

HYUNDAI

OWNER'S MANUAL

Operation
Maintenance
Specifications

All information in this Owner's Manual is current at the time of publication. However, HYUNDAI reserves the right to make changes at any time so that our policy of continual product improvement may be carried out.

This manual applies to all HYUNDAI models and includes descriptions and explanations of optional as well as standard equipment. As a result, you may find material in this manual that does not apply to your specific vehicle.

CAUTION: MODIFICATIONS TO YOUR HYUNDAI

Your HYUNDAI should not be modified in any way. Such modifications may adversely affect the performance, safety or durability of your HYUNDAI and may, in addition, violate conditions of the limited warranties covering the vehicle. Certain modifications may also be in violation of regulations established by the U.S. Department of Transportation and other federal or state agencies.

TWO-WAY RADIO OR CELLULAR TELEPHONE INSTALLATION

Your vehicle is equipped with electronic fuel injection and other electronic components. It is possible for an improperly installed/adjusted two-way radio or cellular telephone to adversely affect electronic systems. For this reason, we recommend that you carefully follow the radio manufacturer's instructions or consult your HYUNDAI dealer for precautionary measures or special instructions if you choose to install one of these devices.

SAFETY AND VEHICLE DAMAGE WARNING

This manual includes information titled as DANGER, WARNING, CAUTION and NOTICE. These titles indicate the following:

DANGER

DANGER indicates a hazardous situation which, if not avoided, will result in death or serious injury.

CAUTION

CAUTION indicates a hazardous situation which, if not avoided, could result in minor or moderate injury.

WARNING

WARNING indicates a hazardous situation which, if not avoided, could result in death or serious injury.

NOTICE

NOTICE indicates a situation which, if not avoided, could result in vehicle damage.

INTRODUCTION

Congratulations, and thank you for choosing HYUNDAI. We are pleased to welcome you to the growing number of discriminating people who drive HYUNDAIS. We are very proud of the advanced engineering and high-quality construction of each HYUNDAI we build.

Your Owner's Manual will introduce you to the features and operation of your new HYUNDAI. To become familiar with your new HYUNDAI, so that you can fully enjoy it, read this Owner's Manual carefully before driving your new vehicle.

This manual contains important safety information and instructions intended to familiarize you with your vehicle's controls and safety features so you can safely operate your vehicle.

This manual also contains information on maintenance designed to enhance safe operation of the vehicle. It is recommended that all service and maintenance on your car be performed by an authorized HYUNDAI dealer. HYUNDAI dealers are prepared to provide high-quality service, maintenance and any other assistance that may be required.

This Owner's Manual should be considered a permanent part of your vehicle, and should be kept in the vehicle so you can refer to it at any time. The manual should stay with the vehicle if you sell it to provide the next owner with important operating, safety and maintenance information.

HYUNDAI MOTOR AMERICA

CAUTION

Severe engine and transmission damage may result from the use of poor quality fuels and lubricants that do not meet HYUNDAI specifications. You must always use high quality fuels and lubricants that meet the specifications listed on Page 8-6 in the Vehicle Specifications section of the Owner's Manual.

Copyright 2015 HYUNDAI Motor America. All rights reserved. No part of this publication may be reproduced, stored in any retrieval system or transmitted in any form or by any means without the prior written permission of HYUNDAI Motor America.

GUIDE TO HYUNDAI GENUINE PARTS

1. What are HYUNDAI Genuine Parts?

HYUNDAI Genuine Parts are the same parts used by HYUNDAI Motor Company to manufacture vehicles. They are designed and tested for the optimum safety, performance, and reliability to our customers.



2. Why should you use genuine parts?

HYUNDAI Genuine Parts are engineered and built to meet rigid manufacturing requirements. Damage caused by using imitation, counterfeit or used salvage parts is not covered under the HYUNDAI New Vehicle Limited Warranty or any other HYUNDAI warranty.

In addition, any damage to or failure of HYUNDAI Genuine Parts caused by the installation or failure of an imitation, counterfeit or used salvage part is not covered by any HYUNDAI Warranty.



3. How can you tell if you are purchasing HYUNDAI Genuine Parts?

Look for the HYUNDAI Genuine Parts Logo on the package (see below).

HYUNDAI Genuine Parts exported to the U.S. are packaged with labels written only in English.

HYUNDAI Genuine Parts are only sold through authorized HYUNDAI Dealerships.

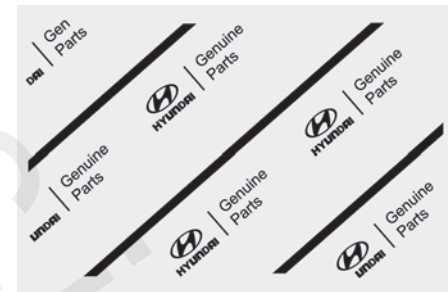

HOW TO USE THIS MANUAL

We want to help you get the greatest possible driving pleasure from your vehicle. Your Owner's Manual can assist you in many ways. To gain an overview of the contents of your Owner's Manual, use the Table of Contents in the front of the manual. The first page of each Chapter includes a detailed Table of Contents of the Topics in that Chapter.

To quickly locate information about your vehicle, use the Index in the back of the manual. It is an alphabetical list of what is in this manual and the page number where it can be found.

For your convenience, we have incorporated tabs on the right-hand page edges. These tabs are coded with the Chapter titles to assist you with navigating through the manual.

SAFETY MESSAGES

Your safety, and the safety of others, is very important. This Owner's Manual provides you with many safety precautions and operating procedures. This information alerts you to potential hazards that may hurt you or others, as well as damage to your vehicle.

Safety messages found on vehicle labels and in this manual describe these hazards and what to do to avoid or reduce the risks.

Warnings and instructions contained in this manual are for your safety. Failure to follow safety warnings and instructions can lead to serious injury or death.

Throughout this manual DANGER, WARNING, CAUTION, NOTICE and the SAFETY ALERT SYMBOL will be used.



This is the safety alert symbol. It is used to alert you to potential physical injury hazards. Obey all safety messages that follow this symbol to avoid possible injury or death. The safety alert symbol precedes the signal words DANGER, WARNING and CAUTION.

DANGER

DANGER indicates a hazardous situation which, if not avoided, will result in death or serious injury.

WARNING

WARNING indicates a hazardous situation which, if not avoided, could result in death or serious injury.

**CAUTION**

CAUTION indicates a hazardous situation which, if not avoided, could result in minor or moderate injury.

NOTICE

NOTICE indicates a situation which, if not avoided, could result in vehicle damage.

FUEL REQUIREMENTS

Your new vehicle is designed to obtain maximum performance with UNLEADED FUEL, as well as minimize exhaust emissions and spark plug fouling.

Your new vehicle is designed to use only unleaded fuel having an octane number ((R+M)/2) of 87 (Research Octane Number 91) or higher. (Do not use methanol blended fuels)

NOTICE

To prevent damage to the engine and engine components, never add any fuel system cleaning agents to the fuel tank other than what has been specified.

Consult an authorized HYUNDAI dealer for additional information.

**WARNING**

- **Do not "top off" after the nozzle automatically shuts off when refueling.**
- **Always check that the fuel cap is installed securely to prevent fuel spillage in the event of an accident.**

Gasoline containing alcohol or methanol

Gasohol, a mixture of gasoline and ethanol (also known as grain alcohol) are being marketed along with or instead of leaded or unleaded gasoline.

Do not use gasohol containing more than 10% ethanol, and do not use gasoline or gasohol containing any methanol. Either of these fuels may cause drivability problems and damage to the fuel system, engine control system and emission control system.

Discontinue using gasohol of any kind if drivability problems occur.

"E85" fuel is an alternative fuel comprised of 85 percent ethanol and 15 percent gasoline, and is manufactured exclusively for use in Flexible Fuel Vehicles. "E85" is not compatible with your vehicle. Use of "E85" may result in poor engine performance and damage to your vehicle's engine and fuel system. HYUNDAI recommends that customers do not use fuel with an ethanol content exceeding 10 percent.

NOTICE

To prevent damage to your vehicle's engine and fuel system:

- **Never use gasohol which contains methanol.**
- **Never use gasohol containing more than 10% ethanol.**
- **Never use leaded fuel or leaded gasohol.**
- **Never use "E85" fuel.**

Your New Vehicle Limited Warranty does not cover damage to the fuel system or any performance problems caused by the use of "E85" fuel.

Other fuels

Using fuels such as;

- Silicone (Si) contained fuel,
- Ferrocene (Fe) contained fuel, and
- Other metallic additives contained fuels,

may cause damage to the engine by plugging, misfiring, poor acceleration, engine stalling, catalyst melting, abnormal corrosion, life cycle reduction.

- The Malfunction Indicator Lamp (MIL) may illuminate.

NOTICE

Damage to the fuel system or performance problem caused by the use of these fuels may not be covered by your New Vehicle Limited Warranty.

Gasoline containing MMT

Some gasoline contains harmful manganese-based fuel additives such as MMT (Methylcyclopentadienyl Manganese Tricarbonyl).

HYUNDAI does not recommend the use of gasoline containing MMT.

This type of fuel can reduce vehicle performance and affect your emission control system.

The malfunction indicator lamp on the cluster may come on.

Fuel Additives

HYUNDAI recommends that you use good quality gasolines treated with detergent additives such as TOP TIER Detergent Gasoline, which help prevent deposit formation in the engine. These gasolines will help the engine run cleaner and enhance performance of the Emission Control System. For more information on TOP TIER Detergent Gasoline, please go to the website (www.toptiergas.com).

VEHICLE BREAK-IN PROCESS

For customers who do not use TOP Tier Detergent Gasoline regularly, and have problems starting or the engine does not run smoothly, additives that you can buy separately may be added to the gasoline. If TOP TIER Detergent Gasoline is not available, one bottle of additive added to the fuel tank at every 7,500 miles or 12 months is recommended.

Additives are available from your authorized HYUNDAI dealer along with information on how to use them. Do not mix other additives.

Operation in foreign countries

If you are going to drive your vehicle in another country, be sure to:

- Observe all regulations regarding registration and insurance.
- Determine that acceptable fuel is available.

No special break-in period is needed. By following a few simple precautions for the first 600 miles (1,000 km) you may add to the performance, economy and life of your vehicle.

- Do not race the engine.
- While driving, keep your engine speed (rpm, or revolutions per minute) between 2,000 rpm and 4,000 rpm.
- Do not maintain a single speed for long periods of time, either fast or slow. Varying engine speed is needed to properly break-in the engine.
- Avoid hard stops, except in emergencies, to allow the brakes to seat properly.

WARNING

CALIFORNIA PROPOSITION 65 WARNING

Items contained in motor vehicles or emitted from them are known to the State of California to cause cancer and birth defects or reproductive harm. These include:

- Gasoline and its vapors
- Engine exhaust
- Used engine oil
- Interior passenger compartment components and materials
- Component parts which are subject to heat and wear

In addition, battery posts, terminals and related accessories contain lead, lead compounds and other chemicals known to the State of California to cause cancer and reproductive harm.

VEHICLE DATA COLLECTION AND EVENT DATA RECORDERS

This vehicle is equipped with an event data recorder (EDR). The main purpose of an EDR is to record, in certain crash or near crash-like situations, such as an air bag deployment or hitting a road obstacle, data that will assist in understanding how a vehicle's systems performed. The EDR is designed to record data related to vehicle dynamics and safety systems for a short period of time, typically 30 seconds or less. The EDR in this vehicle is designed to record such data as:

- How various systems in your vehicle were operating;
- Whether or not the driver and passenger safety belts were buckled/ fastened;
- How far (if at all) the driver was depressing the accelerator and/or brake pedal; and,
- How fast the vehicle was traveling.

These data can help provide a better understanding of the circumstances in which crashes and injuries occur. **NOTE:** EDR data are recorded by your vehicle only if a non-trivial crash situation occurs; no data are recorded by the EDR under normal driving conditions and no personal data (e.g., name, gender, age, and crash location) are recorded. However, other parties, such as law enforcement, could combine the EDR data with the type of personally identifying data routinely acquired during a crash investigation.

To read data recorded by an EDR, special equipment is required, and access to the vehicle or the EDR is needed. In addition to the vehicle manufacturer, other parties, such as law enforcement, that have the special equipment, can read the information if they have access to the vehicle or the EDR.

TABLE OF CONTENTS

Your vehicle at a glance	1
Safety system of your vehicle	2
Convenient features of your vehicle	3
Multimedia System	4
Driving your vehicle	5
What to do in an emergency	6
Maintenance	7
Specifications, Consumer information and Reporting safety defects	8
Index	I

1 Your vehicle at a glance

Exterior overview (I)	1-2
Exterior overview (II)	1-3
Interior overview	1-4
Instrument panel overview	1-5
Engine compartment	1-6

2 Safety system of your vehicle

Important Safety Precautions	2-2
Always Wear Your Seat Belt	2-2
Restrain All Children	2-2
Air Bag Hazards	2-2
Driver Distraction	2-2
Control Your Speed	2-3
Keep Your Vehicle in Safe Condition	2-3
Seats	2-4
Safety Precautions	2-5
Front Seats	2-6
Rear Seats	2-12
Head Restraints	2-16
Seat Warmers and Air Ventilation Seats	2-20

Seat Belts	2-24
Seat Belt Safety Precautions	2-24
Seat Belt Warning Light	2-25
Seat Belt Restraint System	2-26
Additional Seat Belt Safety Precautions	2-32
Care of Seat Belts	2-35
Child Restraint System (CRS)	2-36
Children Always in the Rear	2-36
Selecting a Child Restraint System (CRS)	2-37
Installing a Child Restraint System (CRS)	2-39
Air Bag -	
Advanced Supplemental Restraint System	2-47
Where Are the Air Bags?	2-49
How Does the Air Bag System Operate?	2-52
What to Expect After an Air Bag Inflates	2-57
Occupant Classification System (OCS)	2-58
Why Didn't My Air Bag Go Off in a Collision?	2-63
SRS Care	2-68
Additional Safety Precautions	2-69
Air Bag Warning Labels	2-70

3 Convenient features of your vehicle

Accessing your vehicle	3-3
Smart Key.....	3-3
Immobilizer System.....	3-7
Door locks.....	3-9
Operating Door Locks from Outside the Vehicle.....	3-9
Operating Door Locks from Inside the Vehicle.....	3-10
Auto Door Lock/Unlock Features.....	3-12
Child-Protector Rear Door locks.....	3-12
Theft-alarm system.....	3-13
Driver position memory system.....	3-14
Storing Positions into Memory.....	3-14
Easy Access Function.....	3-15
Steering wheel.....	3-16
Electric Power Steering (EPS).....	3-16
Tilt Steering / Telescope Steering.....	3-17
Heated Steering Wheel.....	3-17
Horn.....	3-18
Mirrors.....	3-19
Inside Rearview Mirror.....	3-19
Outside Rearview Mirror.....	3-34
Reverse Parking Aid Function.....	3-37
Windows	3-38
Power Windows.....	3-39
Panoramic sunroof	3-42
Sunshade.....	3-42
Sliding the Sunroof.....	3-43
Tilting the Sunroof.....	3-43
Closing the Sunroof.....	3-44
To Reset the Sunroof.....	3-45
Exterior features	3-46
Hood.....	3-46
Trunk.....	3-47
Smart Trunk.....	3-50
Fuel Filler Door.....	3-53
Instrument cluster.....	3-57
Instrument cluster control.....	3-58
Gauges.....	3-59
Engine coolant temperature gauge.....	3-61
Warning and indicator lights.....	3-63
Warning messages.....	3-76
LCD Display.....	3-88
Trip computer.....	3-98
Light.....	3-107
Exterior Lights.....	3-107
Smart High Beam.....	3-109
Welcome System.....	3-115
Interior Lights.....	3-116

Wipers and washers	3-120
Windshield Wipers	3-120
Windshield Washers	3-121
Driver Assist System	3-122
Rear view camera	3-122
Rear parking assist system	3-123
Defroster	3-126
Rear Window Defroster	3-126
Automatic climate control system	3-127
Automatic heating and air conditioning	3-128
Manual heating and air conditioning	3-129
System operation	3-137
System maintenance	3-139
Windshield defrosting and defogging	3-141
Automatic Climate Control System	3-142
Defogging logic	3-143
Climate control additional features	3-144
Automatic Ventilation	3-144
To cancel or reset the Automatic Ventilation	3-144
Sunroof Inside Air Recirculation	3-144

Storage compartment	3-145
Center Console Storage	3-145
Glove Box	3-145
Sunglass Holder	3-146
Multi box	3-146
Interior features	3-147
Cup Holder	3-147
Sunvisor	3-148
Power Outlet	3-148
Clock	3-150
Clothes Hanger	3-151
Floor Mat Anchor(s)	3-152
Side Curtain	3-153
Luggage Net Holder	3-153

4 Multimedia system

Multimedia System	4-2
AUX, USB and iPod® Port	4-2
Antenna	4-2
Steering Wheel Audio Control.....	4-3
Audio / Video / Navigation System (AVN).....	4-4
<i>Bluetooth</i> ® Wireless Technology Hands-Free.....	4-4
How Vehicle Audio Works	4-5
Features of Your Vehicle.....	4-7
System Controllers and Functions	
- 3.8 Inch Mono TFT	4-18
Audio Head Unit	4-18
Setup	4-20
Radio : FM, AM.....	4-23
XM™ RADIO	4-24
Basic Method of Use : Audio CD / MP3 CD / USB / iPod® / My Music	4-26
<i>Bluetooth</i> ® Wireless Technology Audio	4-32
Making a Call Using the Steering Wheel Remote Controller.....	4-33
<i>Bluetooth</i> ® Wireless Technology	4-34
Voice Recognition	4-46
Ending Voice Recognition	4-47

System Controllers and Functions

- 5 Inch Color TFT LCD	4-53
Audio Head Unit	4-53
Steering-Wheel Mounted Controls	4-55
Radio Mode.....	4-57
XM™ Radio Mode	4-59
Media Mode.....	4-61
Audio CD Mode.....	4-62
MP3 CD Mode	4-64
USB Mode	4-67
iPod® Mode	4-70
AUX Mode	4-72
MY Music Mode	4-73
<i>Bluetooth</i> ® Wireless Technology Audio Mode	4-76
Voice Recognition	4-92
Setup	4-98
Rear View Camera	4-103
Blue Link®	4-103

5 Driving your vehicle

Before driving	5-4
Before entering the vehicle	5-4
Before starting.....	5-4

Engine Start/Stop button	5-5
Illuminated Engine Start/Stop button	5-6
Engine Stop/Start button positions	5-7
Starting the hybrid system	5-9
Automatic transaxle	5-12
Automatic transaxle operation	5-12
Parking	5-17
Good driving practices	5-17
Braking system	5-19
Power brakes	5-19
Disc brakes wear indicator	5-20
Foot parking brake	5-20
Electronic Parking Brake (EPB)	5-22
AUTO HOLD	5-28
Anti-lock Brake System (ABS)	5-32
Electronic Stability Control (ESC)	5-34
Vehicle Stability Management	5-38
Hill-Start Assist Control (HAC)	5-39
Good braking practices	5-40
Drive mode integrated control system	5-41
Cruise control	5-43
Cruise Control operation	5-43
Smart Cruise Control system	5-48
To adjust the sensitivity of Smart Cruise Control ..	5-49
To convert to Cruise Control Mode	5-49
Smart Cruise Control speed	5-50
Smart Cruise Control vehicle-to-vehicle distance ..	5-54
Radar to detect distance to the vehicle ahead	5-57
Limitations of the system	5-58
Forward collision warning system (FCWS)	5-63
FCWS operation	5-63
Limitations of the system	5-65
Lane departure warning system (LDWS)	5-66
LDWS Operation	5-67
Warning Light and Message	5-68
Blind spot detection system (BSD)	5-70
BSD (Blind Spot Detection) /	
LCA (Lane Change Assist)	5-71
RCTA (Rear Cross Traffic Alert)	5-74
Special driving conditions	5-78
Hazardous driving conditions	5-78
Rocking the vehicle	5-78
Smooth cornering	5-79
Driving at night	5-79
Driving in the rain	5-80
Driving in flooded areas	5-80
Highway driving	5-81

Winter driving	5-82
Snow or icy conditions	5-82
Winter Precautions	5-84
Vehicle load limit	5-87
Tire loading information label	5-88
Trailer towing	5-92

6 What to do in an emergency

In case of an emergency while driving	6-2
Hazard warning flasher	6-2
If the vehicle stalls while driving	6-2
If the vehicle stalls at a crossroad or crossing	6-2
If the vehicle will not start	6-3
If you have a flat tire while driving	6-3
If the engine turns over normally but doesn't start	6-3
Jump starting	6-4
If the engine overheats	6-7

Tire Pressure Monitoring System (TPMS)	6-9
Check tire pressure	6-9
Tire pressure monitoring system	6-10
Low tire pressure telltale	6-11
Low tire pressure position and tire pressure telltale	6-11
TPMS (Tire Pressure Monitoring System) malfunction indicator	6-12
Changing a tire with TPMS	6-13
If you have a flat tire	6-15
With Tire Mobility Kit (TMK)	6-15
Towing	6-22
Towing service	6-22
Removable towing hook	6-23
Emergency Towing	6-24
If an accident occurs	6-26

7 Maintenance

Engine compartment	7-3
Maintenance services	7-4
Owner's responsibility	7-4
Owner maintenance precautions	7-4

Owner maintenance	7-5	Wiper blades	7-39
Owner maintenance schedule.....	7-6	Blade inspection.....	7-39
Scheduled maintenance services	7-8	Blade replacement.....	7-39
Explanation of scheduled maintenance items	7-24	Battery	7-41
Engine oil	7-27	For best battery service.....	7-42
Checking the engine oil level.....	7-27	Battery recharging.....	7-42
Checking the engine oil and filter.....	7-28	Reset features.....	7-43
Engine coolant/inverter coolant	7-29	Tires and wheels	7-44
Checking the engine/inverter coolant level.....	7-29	Tire care.....	7-44
Changing engine coolant.....	7-32	Recommended cold tire inflation pressures.....	7-45
Hybrid starter & generator (HSG) belt	7-32	Check tire inflation pressure.....	7-46
Checking the hybrid starter & generator (HSG) belt.....	7-32	Tire rotation.....	7-47
Brake fluid	7-33	Wheel alignment and tire balance.....	7-48
Checking the brake fluid level.....	7-33	Tire replacement.....	7-48
Washer fluid	7-34	Wheel replacement.....	7-49
Checking the washer fluid level.....	7-34	Tire traction.....	7-49
Parking brake	7-34	Tire maintenance.....	7-50
Checking the parking brake.....	7-34	Tire sidewall labeling.....	7-50
Air cleaner	7-35	Tire terminology and definitions.....	7-54
Filter replacement.....	7-35	All season tires.....	7-57
Climate control air filter	7-37	Summer tires.....	7-57
Filter inspection.....	7-37	Snow tires.....	7-57
		Radial-ply tires.....	7-58
		Low aspect ratio tires.....	7-58

Fuses	7-60
Instrument panel fuse replacement	7-61
Engine compartment panel fuse replacement.....	7-62
Fuse/relay panel description	7-64
Light bulbs	7-72
Headlamp, position lamp, turn signal lamp and side marker light bulb replacement.....	7-73
Side repeater lamp replacement	7-78
Rear combination light bulb replacement.....	7-79
Back-up lamp	7-83
High mounted stop lamp	7-84
License plate light bulb replacement	7-84
Interior light bulb replacement	7-84
Appearance care	7-86
Exterior care	7-86
Interior care.....	7-91
Emission control system	7-93
Crankcase emission control system.....	7-93
Evaporative emission control system including onboard refueling vapor recovery (ORVR)	7-93
Exhaust emission control system	7-94
California perchlorate notice	7-97

8 Specifications, Consumer information and Reporting safety defects

Dimensions	8-2
Engine	8-2
Bulb Wattage	8-3
Tires and Wheels	8-4
Volume and Weight	8-5
Air Conditioning System	8-5
Recommended Lubricants and Capacities	8-6
Recommended SAE Viscosity Number	8-7
Vehicle Identification Number (VIN)	8-8
Vehicle Certification Label	8-8
Tire Specification and Pressure Label	8-9
Engine Number	8-9
Refrigerant Label	8-9
Consumer Information	8-10
Reporting Safety Defects	8-11

Your vehicle at a glance

Exterior overview (I)	1-2
Exterior overview (II)	1-3
Interior overview	1-4
Instrument panel overview	1-5
Engine compartment	1-6

EXTERIOR OVERVIEW (I)

■ Front view

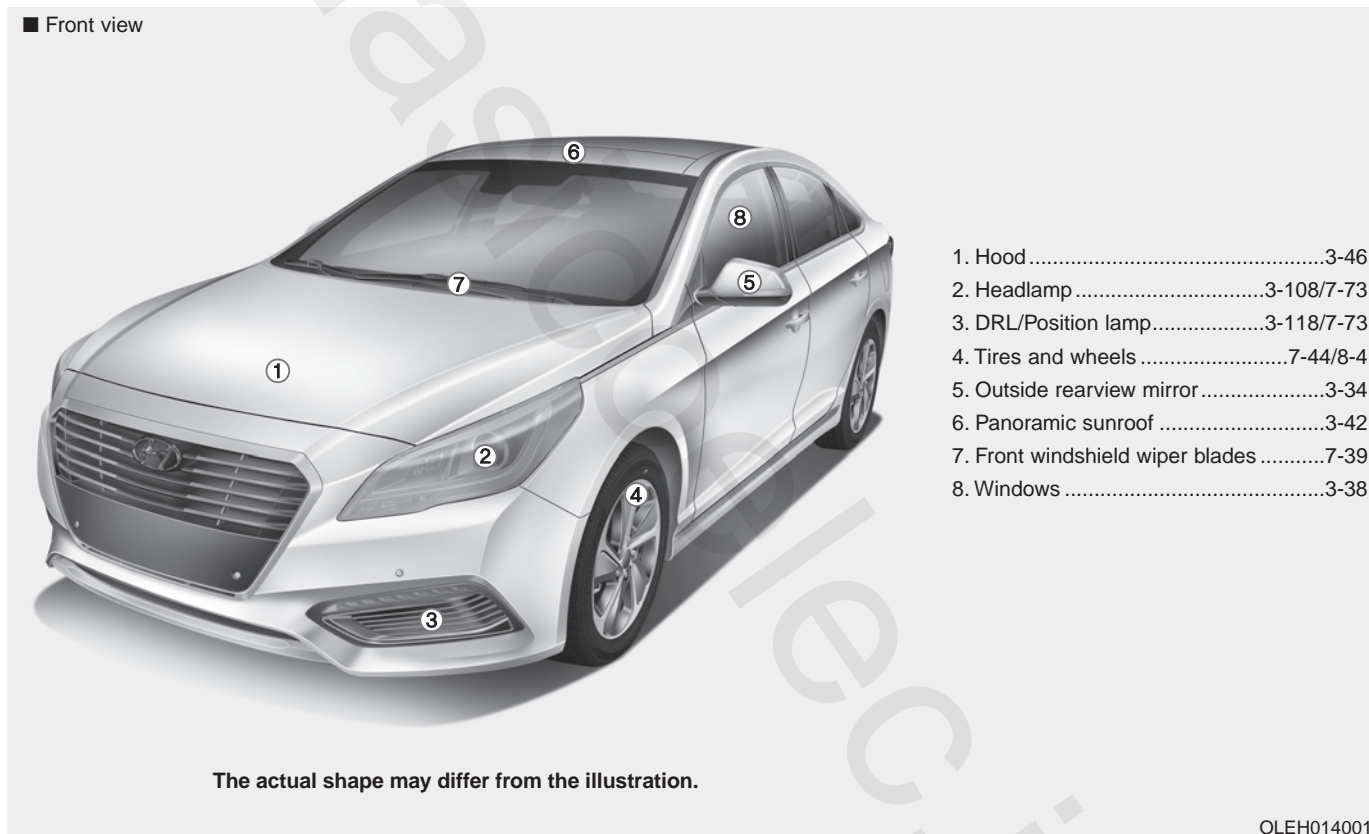

OLEH014001L

EXTERIOR OVERVIEW (II)

■ Rear view

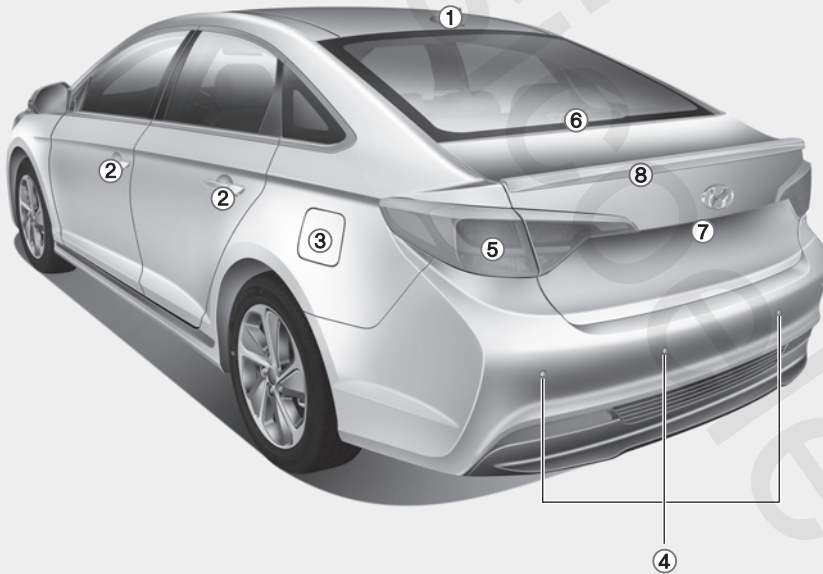

- 1. Antenna4-2
- 2. Doors3-9
- 3. Fuel filler lid3-53
- 4. Rear parking assist system3-123
- 5. Rear combination lamp7-79
- 6. High mounted stop lamp7-84
- 7. Rearview camera3-122
- 8. Trunk3-47

The actual shape may differ from the illustration.

OLFH014002L

INTERIOR OVERVIEW

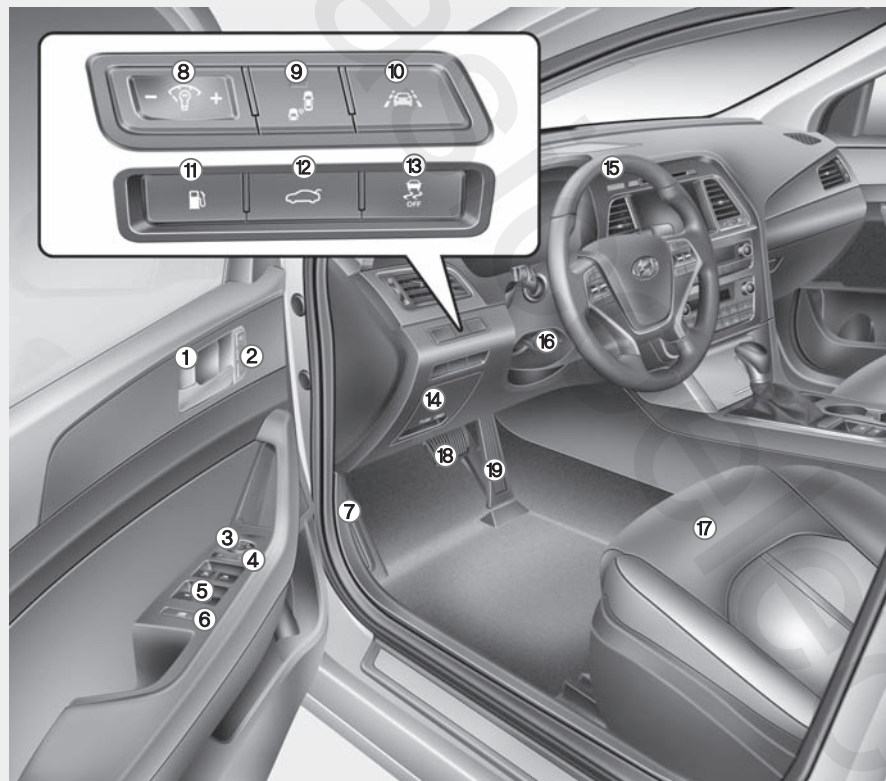

1. Door lock/unlock button3-9
 2. Driver position memory system3-14
 3. Outside rearview mirror control switch3-34
 4. Central door lock switch3-10
 5. Power window switches3-38
 6. Power window lock button3-41
 7. Hood release lever3-46
 8. Instrument panel illumination control switch3-57
 9. Blind spot detection system button*5-70
 10. Lane departure warning system button*5-66
 11. Fuel filler door opener button3-53
 12. Trunk release button3-47
 13. ESC OFF button5-34
 14. Fuse box7-62
 15. Steering wheel3-16
 16. Steering wheel tilt/telescope lever3-17
 17. Seat2-4
 18. Brake pedal
 19. Accelerator pedal
- * : if equipped

The actual shape may differ from the illustration.

OLF014003N

INSTRUMENT PANEL OVERVIEW



1. Light control/Turn signals3-107
 2. Steering wheel audio controls*/
Bluetooth® wireless technology
hands-free controls*4-3
 3. Instrument cluster3-57
 4. Horn3-18
 5. Driver's front air bag.....2-47
 6. Wiper/Washer.....3-120
 7. Cruise controls*5-43
 8. Engine Start/Stop button5-5
 9. Automatic transaxle5-12
 10. Drive mode integrated control
system5-41
 11. Rear parking assist system3-123
 12. EPB (Electronic Parking Brake)* ..5-22
 13. AUTO HOLD5-28
 14. Audio system/Navigation system4-4
 15. Digital Clock3-150
 16. Climate control system3-128/3-129
 17. Power outlet3-148
 18. AUX, USB and iPod® port4-2
 19. Passenger's front air bag2-49
 20. Glove box3-145
- * : if equipped

The actual shape may differ from the illustration.

OLFH015004N

ENGINE COMPARTMENT

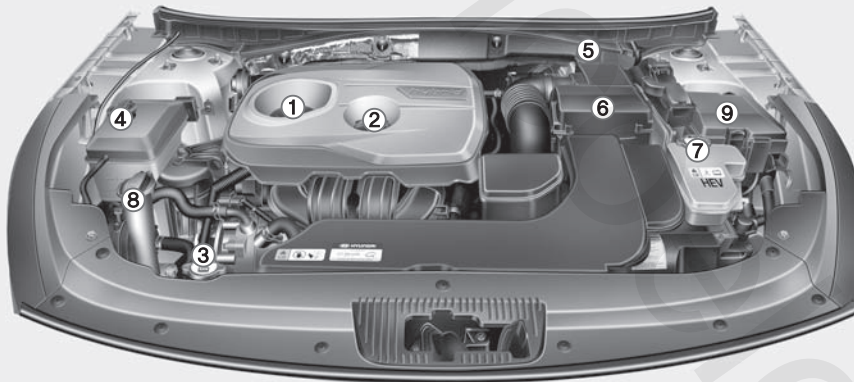

- 1. Engine oil filler cap7-28
- 2. Engine oil dipstick7-27
- 3. Radiator cap7-29
- 4. Engine coolant reservoir7-30
- 5. Brake fluid reservoir7-33
- 6. Air cleaner7-35
- 7. Inverter coolant reservoir7-31
- 8. Windshield washer fluid reservoir7-34
- 9. Fuse box7-60

The actual engine room in the vehicle may differ from the illustration.

OLFH014005K

Safety system of your vehicle

This chapter provides you with important information about how to protect yourself and your passengers. It explains how to properly use your seats and seat belts, and how your air bags work. Additionally, this chapter explains how to properly restrain infants and children in your vehicle.

Important Safety Precautions	2-2	Child Restraint System (CRS)	2-36
Always Wear Your Seat Belt.....	2-2	Children Always in the Rear.....	2-36
Restrain All Children.....	2-2	Selecting a Child Restraint System (CRS).....	2-37
Air Bag Hazards.....	2-2	Installing a Child Restraint System (CRS).....	2-39
Driver Distraction.....	2-2	Air Bag -	
Control Your Speed.....	2-3	Advanced Supplemental Restraint System	2-47
Keep Your Vehicle in Safe Condition.....	2-3	Where Are the Air Bags?.....	2-49
Seats	2-4	How Does the Air Bag System Operate?.....	2-52
Safety Precautions.....	2-5	What to Expect After an Air Bag Inflates.....	2-57
Front Seats.....	2-6	Occupant Classification System (OCS).....	2-58
Rear Seats.....	2-12	Why Didn't My Air Bag Go Off in a Collision?.....	2-63
Head Restraints.....	2-16	SRS Care.....	2-68
Seat Warmers and Air Ventilation Seats.....	2-20	Additional Safety Precautions.....	2-69
Seat Belts	2-24	Air Bag Warning Labels.....	2-70
Seat Belt Safety Precautions.....	2-24		
Seat Belt Warning Light.....	2-25		
Seat Belt Restraint System.....	2-26		
Additional Seat Belt Safety Precautions.....	2-32		
Care of Seat Belts.....	2-35		

IMPORTANT SAFETY PRECAUTIONS

You will find many safety precautions and recommendations throughout this section, and throughout this manual. The safety precautions in this section are among the most important.

Always Wear Your Seat Belt

A seat belt is your best protection in all types of accidents. Air bags are designed to supplement seat belts, not replace them. So even though your vehicle is equipped with air bags, ALWAYS make sure you and your passengers wear your seat belts, and wear them properly.

Restrain All Children

All children under age 13 should ride in your vehicle properly restrained in a rear seat, not the front seat. Infants and small children should be restrained in an appropriate child restraint. Larger children should use a booster seat with the lap/shoulder belt until they can use the seat belt properly without a booster seat.

Air Bag Hazards

While air bags can save lives, they can also cause serious or fatal injuries to occupants who sit too close to them, or who are not properly restrained. Infants, young children, and shorter adults are at the greatest risk of being injured by an inflating air bag. Follow all instructions and warnings in this manual.

Driver Distraction

Driver distraction presents a serious and potentially deadly danger, especially for inexperienced drivers. Safety should be the first concern when behind the wheel and drivers need to be aware of the wide array of potential distractions, such as drowsiness, reaching for objects, eating, personal grooming, other passengers, and using cellular phones.

Drivers can become distracted when they take their eyes and attention off the road or their hands off the wheel to focus on activities other than driving. To reduce your risk of distraction or getting into an accident:

- ALWAYS set up your mobile devices (i.e., MP3 players, phones, navigation units, etc.) when your vehicle is parked or safely stopped.
- ONLY use your mobile device when allowed by laws and when conditions permit safe use. NEVER text or email while driving. Most states have laws prohibiting drivers from texting. Some states and cities also prohibit drivers from using handheld phones.
- NEVER let the use of a mobile device distract you from driving. You have a responsibility to your passengers and others on the road to always drive safely, with your hands on the wheel as well as your eyes and attention on the road.

Control Your Speed

Excessive speed is a major factor in crash injuries and deaths. Generally, the higher the speed, the greater the risk, but serious injuries can also occur at lower speeds. Never drive faster than is safe for current conditions, regardless of the maximum speed posted.

Keep Your Vehicle in Safe Condition

Having a tire blowout or a mechanical failure can be extremely hazardous. To reduce the possibility of such problems, check your tire pressures and condition frequently, and perform all regularly scheduled maintenance.

SEATS

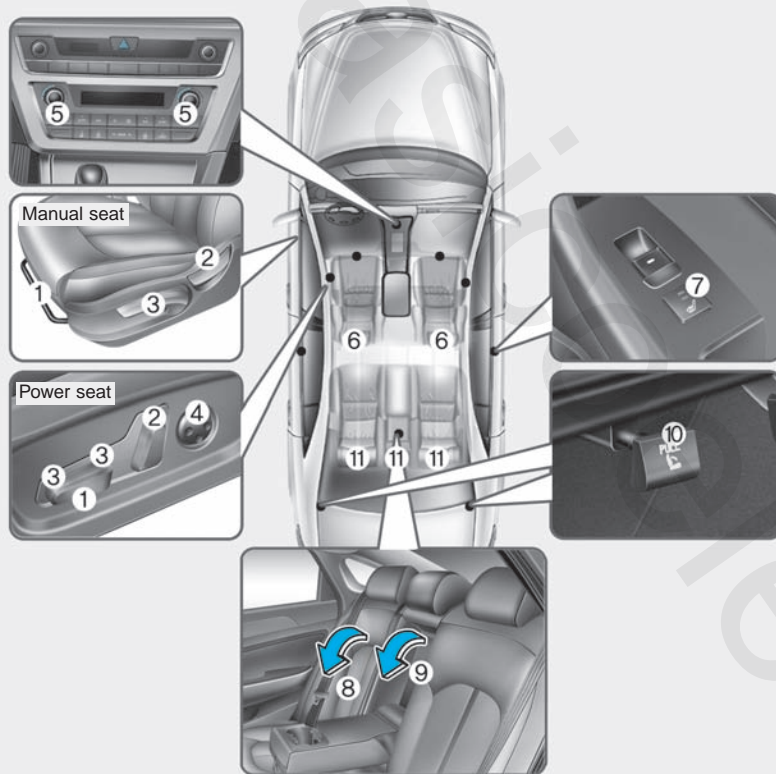

Front seats

1. Seat sliding forward or rearward adjustment
2. Seatback angle adjustment
3. Seat cushion height adjustment
4. Lumbar support adjustment*
5. Seat warmer/Air ventilation seat*
6. Head restraint

Rear seats

7. Seat warmer*
8. Armrest
9. Carrying long/narrow cargo*
10. Seat folding lever*
11. Head restraint

* : if equipped

Safety Precautions

Adjusting the seats so that you are sitting in a safe, comfortable position plays an important role in driver and passenger safety together with the seat belts and air bags in an accident.

WARNING

Do not use a cushion that reduces friction between the seat and the passenger. The passenger's hips may slide under the lap portion of the seat belt during an accident or a sudden stop. Serious or fatal internal injuries could result because the seat belt cannot operate properly.

Air bags

You can take steps to reduce the risk of being injured by an inflating air bag. Sitting too close to an air bag greatly increases the risk of injury in the event the air bag inflates.

The National Highway Traffic Safety Administration (NHTSA) recommends that drivers allow at least 10 inches (25 cm) between the center of the steering wheel and their chest.

WARNING

To reduce the risk of serious injury or death from an inflating air bag, take the following precautions:

- **Adjust the driver's seat as far to the rear as possible while maintaining the ability to maintain full control of the vehicle.**
- **Adjust the front passenger seat as far to the rear as possible.**
- **Hold the steering wheel by the rim with hands at the 9 o'clock and 3 o'clock positions to minimize the risk of injuries to your hands and arms.**
- **NEVER place anything or anyone between the steering wheel and the air bag.**
- **Do not allow the front passenger to place feet or legs on the dashboard to minimize the risk of leg injuries.**

Seat belts

Always fasten your seat belt before starting any trip.

At all times, passengers should sit upright and be properly restrained. Infants and small children must be restrained in appropriate child restraint systems. Children who have outgrown a booster seat and adults must be restrained using the seat belts.

 **WARNING**

Take the following precautions when adjusting your seat belt:

- NEVER use one seat belt for more than one occupant.
- Always position the seatback upright with the lap portion of the seat belt snug and low across the hips.
- NEVER allow children or small infants to ride in a passenger's lap.
- Do not route the seat belt across your neck, across sharp edges, or reroute the shoulder strap away from your body.
- Do not allow the seat belt to become caught or jammed.

Front Seats

 **WARNING**

Take the following precautions when adjusting your seat:

- NEVER attempt to adjust the seat while the vehicle is moving. The seat could respond with unexpected movement and may cause loss of vehicle control resulting in an accident.
- Do not place anything under the front seats. Loose objects in the driver's foot area could interfere with the operation of the foot pedals, causing an accident.
- Do not allow anything to interfere with the normal position and proper locking of the seatback.
- Do not place a cigarette lighter on the floor or seat. When you operate the seat, gas may exit out of the lighter causing a fire.

(Continued)

(Continued)

- Use extreme caution when picking small objects trapped under the seats or between the seat and the center console. Your hands might be cut or injured by the edges of the seat mechanism.

 **CAUTION**

To prevent injury:

- Do not adjust your seat while wearing your seat belt. Moving the seat cushion forward may cause strong pressure on your abdomen.
- Do not allow your hands or fingers to get caught in the seat mechanisms while the seat is moving.

Manual adjustment

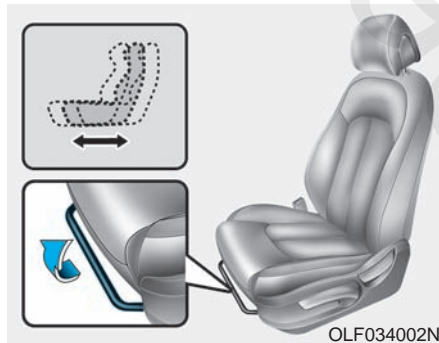

Forward and rearward adjustment

To move the seat forward or rearward:

1. Pull up the seat slide adjustment lever and hold it.
2. Slide the seat to the position you desire.
3. Release the lever and make sure the seat is locked in place. Move forward and rearward without using the lever. If the seat moves, it is not locked properly.

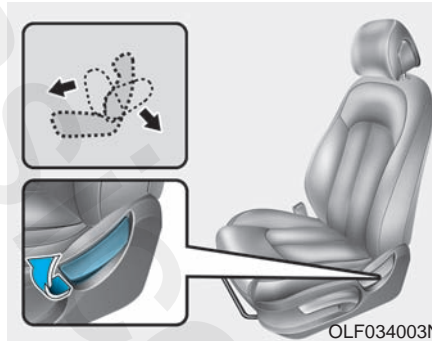

Seatback angle

To recline the seatback:

1. Lean forward slightly and lift up the seatback lever.
2. Carefully lean back on the seat and adjust the seatback to the position you desire.
3. Release the lever and make sure the seatback is locked in place. (The lever **MUST** return to its original position for the seatback to lock.)

Reclining seatback

Sitting in a reclined position when the vehicle is in motion can be dangerous. Even when buckled up, the protection of your restraint system (seat belts and air bags) is greatly reduced by reclining your seatback.

⚠ WARNING

NEVER ride with a reclined seatback when the vehicle is moving.

Riding with a reclined seatback increases your chance of serious or fatal injuries in the event of a collision or sudden stop.

Drivers and passengers should ALWAYS sit well back in their seats, properly belted, and with the seatbacks upright.

Seat belts must be snug against your hips and chest to work properly. When the seatback is reclined, the shoulder belt cannot do its job because it will not be snug against your chest. Instead, it will be in front of you. During an accident, you could be thrown into the seat belt, causing neck or other injuries.

The more the seatback is reclined, the greater chance the passenger's hips will slide under the lap belt or the passenger's neck will strike the shoulder belt.

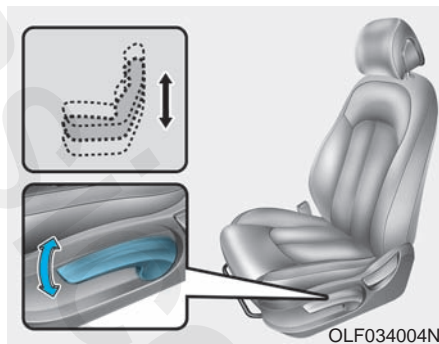

Seat cushion height

To change the height of the seat cushion:

- Push down on the lever several times, to lower the seat cushion.
- Pull up on the lever several times, to raise the seat cushion.

Power adjustment

The front seat can be adjusted by using the control switches located on the outside of the seat cushion. Before driving, adjust the seat to the proper position so that you can easily control the steering wheel, foot pedals and controls on the instrument panel.

⚠ WARNING

NEVER allow children in the vehicle unattended. The power seats are operable when the engine is turned off.

NOTICE

To prevent damage to the seats:

- Always stop adjusting the seats when the seat has been adjusted as far forward or rearward as possible.
- Do not adjust the seats longer than necessary when the engine is turned off. This may result in unnecessary battery drain.
- Do not operate two or more seats at the same time. This may result in an electrical malfunction.

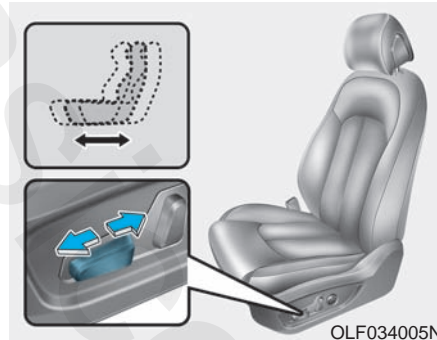
**Forward and rearward adjustment**

To move the seat forward or rearward:

1. Push the control switch forward or rearward.
2. Release the switch once the seat reaches the desired position.

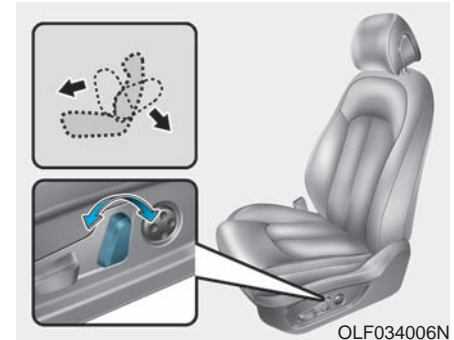
**Seatback angle**

To recline the seatback:

1. Push the control switch forward or rearward.
2. Release the switch once the seatback reaches the desired position.

Reclining seatback

Sitting in a reclined position when the vehicle is in motion can be dangerous. Even when buckled up, the protections of your restraint system (seat belts and air bags) is greatly reduced by reclining your seatback.

WARNING

NEVER ride with a reclined seatback when the vehicle is moving. Riding with a reclined seatback increases your chance of serious or fatal injuries in the event of a collision or sudden stop.

Driver and passengers should **ALWAYS** sit well back in their seats, properly belted, and with the seatbacks upright.

Seat belts must be snug against your hips and chest to work properly. When the seatback is reclined, the shoulder belt cannot do its job because it will not be snug against your chest. Instead, it will be in front of you. During an accident, you could be thrown into the seat belt, causing neck or other injuries.

The more the seatback is reclined, the greater chance the passenger's hips will slide under the lap belt or the passenger's neck will strike the shoulder belt.

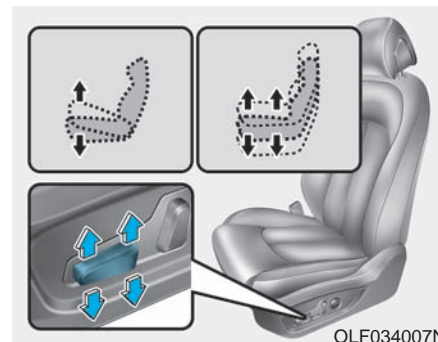

Seat cushion height

To change the height of the seat cushion:

1. Pull the front portion of the control switch up to raise or push down to lower the front part of the seat cushion. Pull the rear portion of the control switch up to raise or push down to lower the seat cushion.
2. Release the switch once the seat reaches the desired position.

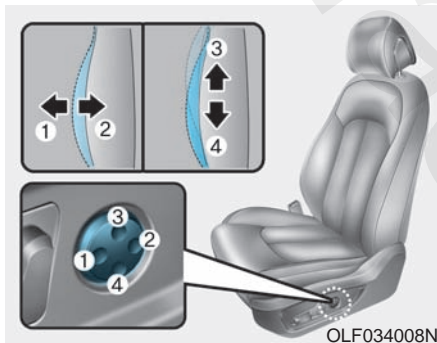

Lumbar support (for driver's seat, if equipped)

The lumbar support can be adjusted by pressing the lumbar support switch.

- Press the front portion of the switch (1) to increase support or the rear portion of the switch (2) to decrease support.
- Move the support position up and down by pressing the switch (3) or (4).

According to the equipped feature, the lumbar support does not operate up or down when the lumbar support is in the rearmost position.

In this case, to use the system, slightly increase support by pushing the front portion of the switch (1).

Seatback pocket

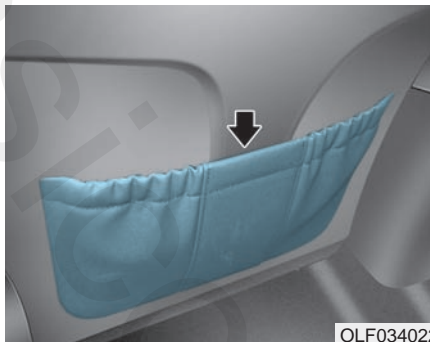

The seatback pocket is provided on the back of the front seatbacks.

⚠ WARNING

To prevent the Occupant Classification System from malfunctioning:

Do not hang onto the front passenger's seatback.

⚠ CAUTION

Do not put heavy or sharp objects in the seatback pockets. In an accident they could come loose from the pocket and injure occupants.

Rear Seats

Folding the rear seat (if equipped)

The rear seatbacks can be folded to facilitate carrying long items or to increase the luggage capacity of the vehicle.

⚠ WARNING

- **Never allow passengers to sit on top of the folded down seatback while the vehicle is moving. This is not a proper seating position and no seat belts are available for use. This could result in serious injury or death in case of an accident or sudden stop.**
- **Objects carried on the folded down seatback should not extend higher than the top of the front seatbacks. This could allow cargo to slide forward and cause injury or damage during sudden stops.**

(Continued)

(Continued)

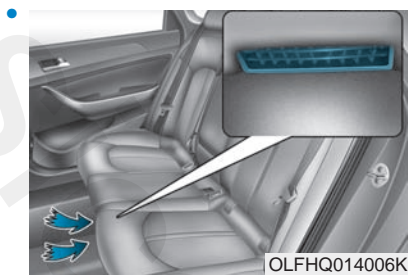

Do not put objects in the center lower part of rear seats. This could block the battery cooling duct causing battery degradation.

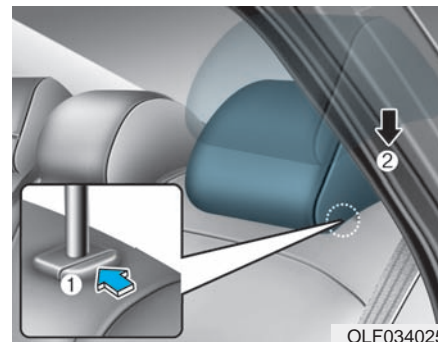

To fold down the rear seatback:

1. Set the front seatback to the upright position and if necessary, slide the front seat forward.
2. Lower the rear head restraints to the lowest position.

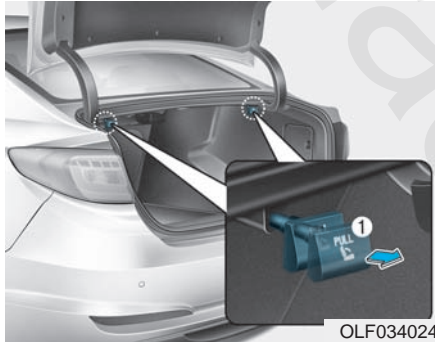

OLF034024

3. Pull on the seatback folding lever (1) located in the trunk.



OLF034027

4. Fold the seatback toward the front of the vehicle.
5. To use the rear seat, lift and pull the seatback rearward. Pull the seatback firmly until it clicks into place. Make sure the seatback is locked in place.

When you return the seatback to its upright position, always be sure it has locked into position by pushing on the top of the seatback.

⚠ WARNING

When returning the rear seatback from a folded to an upright position, hold the seatback and return it slowly. Ensure that the seatback is completely locked into its upright position by pushing on the top of the seatback. In an accident or sudden stop, the unlocked seatback could allow cargo to move forward with great force and enter the passenger compartment, which could result in serious injury or death.

⚠ WARNING

Do not place objects in the rear seats, since they cannot be properly secured and may hit vehicle occupants in a collision causing serious injury or death.

⚠ WARNING

Make sure the engine is off, the shift lever is in P (Park), and the parking brake is securely applied whenever loading or unloading cargo. Failure to take these steps may allow the vehicle to move if the shift lever is inadvertently moved to another position.

Armrest



The armrest is located in the center of the rear seat. Pull the armrest down from the seatback to use it.



Cup holder

To use the center cup holder, pull down the armrest.

Carrying long/narrow cargo (if equipped)

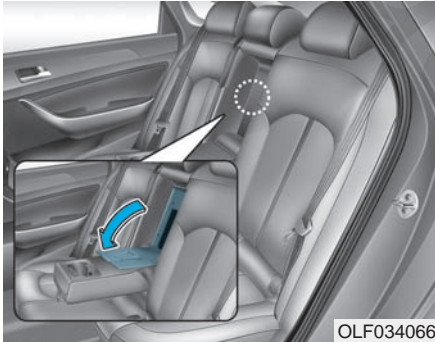

Additional cargo space is provided to accommodate long/narrow cargo (skis, poles, etc.) not able to fit properly in the trunk when closed.

1. Pull the armrest down.
2. Pull the cover down while pushing the release lever down.

CAUTION

- Be careful when loading cargo through the rear passenger seats to prevent damage to the vehicle interior.
- When cargo is loaded through the rear passenger seats, ensure the cargo is properly secured to prevent it from moving while driving.

WARNING

Cargo should always be secured to prevent it from being thrown about the vehicle in a collision and causing injury to the vehicle occupants. Do not place objects in the rear seats, since they cannot be properly secured and may hit the front seat occupants in a collision.

WARNING

Cargo loading

Make sure the engine is off, the automatic transmission is in P (Park) and the parking brake is securely applied whenever loading or unloading cargo.

Failure to take these steps may allow the vehicle to move if the shift lever is inadvertently moved to another position.

Head Restraints

The vehicle's front and rear seats have adjustable head restraints. The head restraints provide comfort for passengers, but more importantly they are designed to help protect passengers from whiplash and other neck and spinal injuries during an accident, especially in a rear impact collision.

WARNING

To reduce the risk of serious injury or death in an accident, take the following precautions when adjusting your head restraints:

- Always properly adjust the head restraints for all passengers **BEFORE** starting the vehicle.
- **NEVER** let anyone ride in a seat with the head restraints removed.

(Continued)

(Continued)

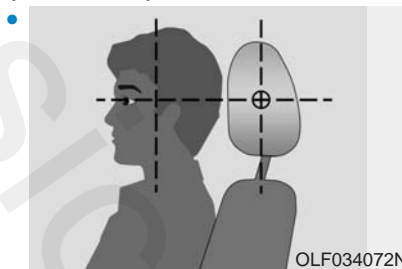

Adjust the head restraints so the middle of the head restraint is at the same height as the height of the top of the eyes.

- **NEVER** adjust the head restraint position of the driver's seat when the vehicle is in motion.
- Adjust the head restraint as close to the passenger's head as possible. Do not use a seat cushion that holds the body away from the seatback.
- Make sure the head restraint locks into position after adjusting it.

NOTICE

To prevent damage, **NEVER** hit or pull on the head restraints.

Front seat head restraints

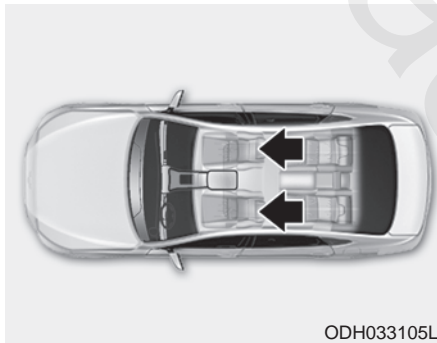

ODH033105L

The vehicle's front and passenger's seats are equipped with adjustable head restraints for the passengers safety and comfort.

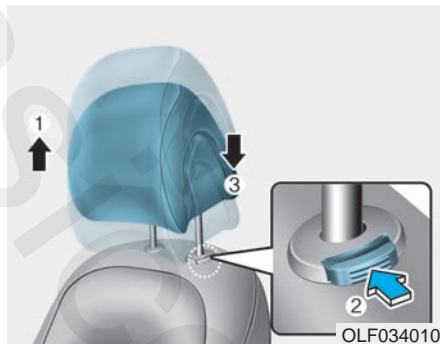

OLF034010

Adjusting the height up and down

To raise the head restraint:

1. Pull it up to the desired position (1).

To lower the head restraint:

1. Push and hold the release button (2) on the head restraint support.
2. Lower the head restraint to the desired position (3).

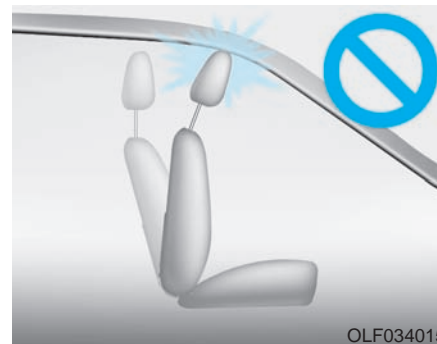

OLF034015

NOTICE

If you recline the seatback towards the front with the head restraint and seat cushion raised, the head restraint may come in contact with the sunvisor or other parts of the vehicle.

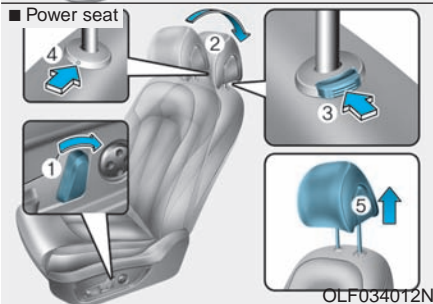
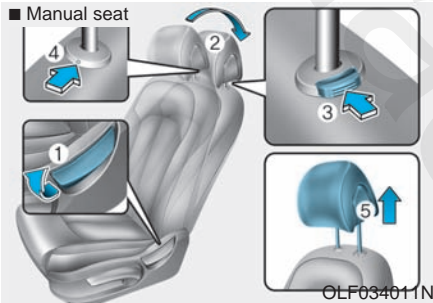

3. Press the head restraint release button (3) and the access hole (4) with a tool (e.g. pin) while pulling the head restraint up (5).

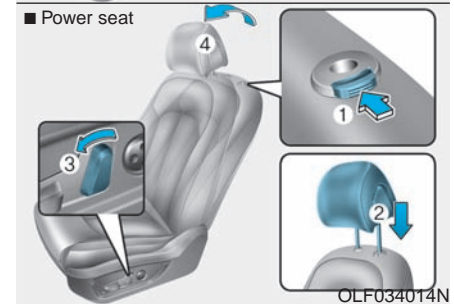
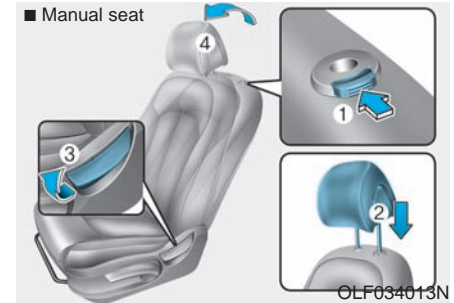

Removal/Reinstallation

To remove the head restraint:

1. Recline the seatback (2) rearward using the seatback angle lever/switch (1).
2. Raise the head restraint as far as it can go.

To reinstall the head restraint:

1. Put the head restraint poles (2) into the holes while pressing the release button (1).
2. Adjust the head restraint to the appropriate height.
3. Recline the seatback (4) forward using the seatback angle lever/switch (3).

Rear seat head restraints

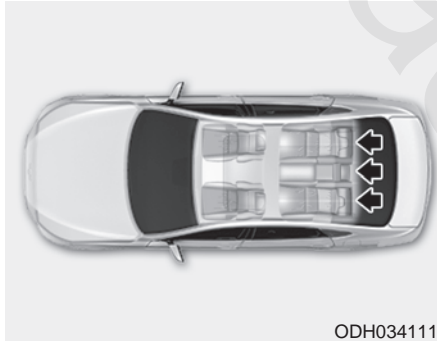

ODH034111

The rear seats are equipped with head restraints in all the seating positions for the passenger's safety and comfort.

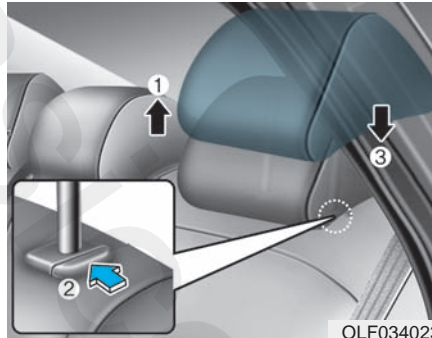

OLF034023

Adjusting the height up and down

To raise the head restraint:

1. Pull it up to the desired position (1).

To lower the head restraint:

1. Push and hold the release button (2) on the head restraint support.
2. Lower the head restraint to the desired position (3).

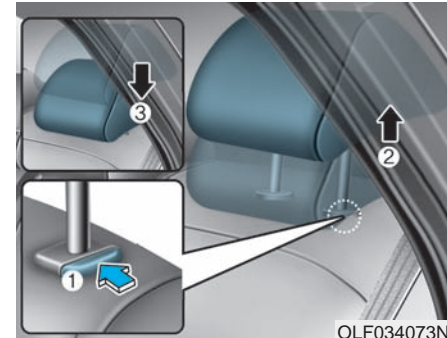

OLF034073N

Removal/Reinstallation

To remove the head restraint:

1. Raise the head restraint as far as it can go.
2. Press the head restraint release button (1) while pulling the head restraint up (2).

To reinstall the head restraint:

1. Put the head restraint poles into the holes (3) while pressing the release button (1).
2. Adjust the head restraint to the appropriate height.

Seat Warmers and Air Ventilation Seats

Front seat warmers (if equipped)

Seat warmers are provided to warm the seats during cold weather.

WARNING

The seat warmers can cause a serious burn, even at low temperatures and especially if used for long periods of time.

Passengers must be able to feel if the seat is becoming too warm so they can turn it off, if needed.

People who cannot detect temperature change or pain to the skin should use extreme caution, especially the following types of passengers:

- Infants, children, elderly or disabled persons, or hospital outpatients.
- People with sensitive skin or who burn easily.

(Continued)

(Continued)

- Fatigued individuals.
- Intoxicated individuals.
- People taking medication that can cause drowsiness or sleepiness.

WARNING

NEVER place anything on the seat that insulates against heat when the seat warmer is in operation, such as a blanket or seat cushion. This may cause the seat warmer to overheat, causing a burn or damage to the seat.

NOTICE

To prevent damage to the seat warmers and seats:

- Never use a solvent such as paint thinner, benzene, alcohol or gasoline to clean the seats.
- Do not place heavy or sharp objects on seats equipped with seat warmers.
- Do not change the seat cover. It may damage the seat warmer.

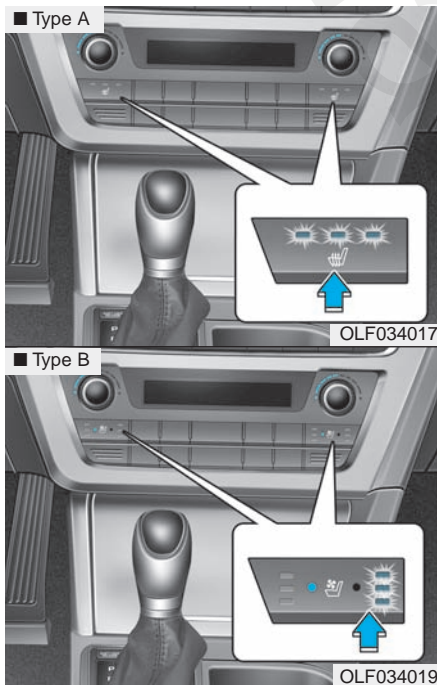

While the engine is running, push either of the switches to warm the driver's seat or front passenger's seat.

During mild weather or under conditions where the operation of the seat warmer is not needed, keep the switches in the OFF position.

- Each time you push the switch, the temperature setting of the seat is changed as follows :



- When pressing the switch for more than 1.5 seconds with the seat warmer operating, the seat warmer will turn OFF.
- The seat warmer defaults to the OFF position whenever the Engine Start/Stop button is in the ON position.

i Information

With the seat warmer switch in the **ON** position, the heating system in the seat turns off or on automatically depending on the seat temperature.

Air ventilation seats (if equipped)

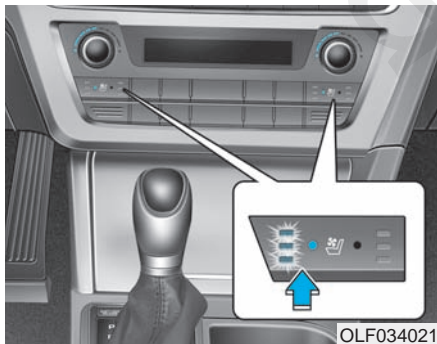

The air ventilation seats are provided to cool the front seats by blowing air through small vent holes on the surface of the seat cushions and seat-backs.

When the operation of the air ventilation seats are not needed, keep the switches in the OFF position.

While the engine is running, push the switch to cool the driver's seat or the front passenger's seat.

- Each time you push the switch, the airflow changes as follows:

OFF → HIGH () → MIDDLE () → LOW ()



- The air ventilation seats default to the OFF position whenever the ignition switch is turned to the ON position.

NOTICE

To prevent damage to the air ventilation seat system and seats:

- Use the air ventilation seats **ONLY** when the air conditioning is on. Using the air ventilation seats for prolonged periods of time with the air conditioning off could cause the air ventilation seats to malfunction.

(Continued)

(Continued)

- Never use a solvent such as paint thinner, benzene, alcohol or gasoline to clean the seats.
- Avoid spilling liquids on the surface of the front seats and seat-backs; this may cause the air vent holes to become blocked and not work properly.
- Do not place materials such as plastic bags or newspapers under the seats. They may block the air intake causing the air vents to not work properly.
- Do not change the seat covers. It may damage the air ventilation seats.
- If the air vents do not operate, restart the vehicle. If there is no change, have your vehicle inspected by an authorized HYUNDAI dealer.

Rear seat warmers (if equipped)

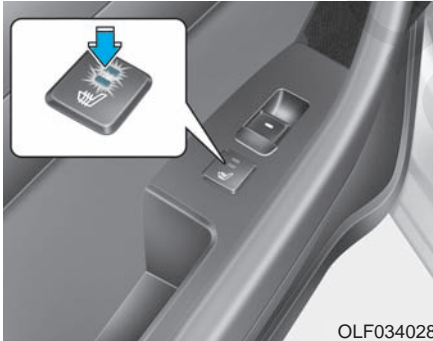

While the engine is running, push either of the switches to warm the rear seat.

During mild weather or under conditions where the operation of the seat warmer is not needed, keep the switches in the OFF position.

Each time you push the switch, the temperature setting of the seat is changed as follows :



The seat warmer defaults to the OFF position whenever the Engine Start/Stop button is in the ON position.

i Information

With the seat warmer switch in the ON position, the heating system in the seat turns off or on automatically depending on the seat temperature.

SEAT BELTS

This section describes how to use the seat belts properly. It also describes some of the things not to do when using seat belts.

Seat Belt Safety Precautions

Always fasten your seat belt and make sure all passengers have fastened their seat belts before starting any trip. Air bags are designed to supplement the seat belt as an additional safety device, but they are not a substitute. Most states require all occupants of a vehicle to wear seat belts.

WARNING

Seat belts must be used by **ALL** passengers whenever the vehicle is moving. Take the following precautions when adjusting and wearing seat belts:

- **ALWAYS** properly restrain children under age 13 in the rear seats.

(Continued)

(Continued)

- **NEVER** allow children to ride in the front passenger seat. If a child age 13 or older must be seated in the front seat, move the seat as far back as possible and properly restrain them in the seat.
- **NEVER** allow an infant or child to be carried on an occupant's lap.
- **NEVER** ride with the seatback reclined when the vehicle is moving.
- Do not allow children to share a seat or seat belt.
- Do not wear the shoulder belt under your arm or behind your back.
- Always wear both the shoulder portion and lap portion of the lap/shoulder belt.
- Do not use the seat belt if it is twisted. A twisted seat belt will not protect you properly in an accident.

(Continued)

(Continued)

- Do not use a seat belt if the webbing or hardware is damaged.
- Do not latch the seat belt into the buckles of other seats.
- **NEVER** unfasten the seat belt while driving. This may cause loss of vehicle control resulting in an accident.
- Make sure there is nothing in the buckle interfering with the seat belt latch mechanism. This may prevent the seat belt from fastening securely.
- No modifications or additions should be made by the user which will either prevent the seat belt adjusting devices from operating to remove slack, or prevent the seat belt assembly from being adjusted to remove slack.

⚠ WARNING

Damaged seat belts and seat belt assemblies will not operate properly. Always replace:

- Frayed, contaminated, or damaged webbing
- Damaged hardware
- The entire seat belt assembly after it has been worn in an accident, even if damage to webbing or assembly is not apparent

Seat Belt Warning Light

*Seat belt warning light
(for driver's seat)*



The driver's seat belt warning light and chime will come on according to the following table when the ignition switch is in the ON position.

Conditions		Warning Pattern	
Seat Belt	Vehicle Speed	Light (Blink)	Chime
Unbuckled		6 seconds	
Buckled		6 seconds	None
Buckled → Unbuckled	Below 3 mph (5 km/h)	6 seconds	None
	3 mph~ 6 mph	6 seconds	
	Above 6 mph (10 km/h)	6 sec. ON / 24 sec. OFF (11 times)	
Unbuckled	Above 6 mph (10 km/h) ↓	6 seconds *1 ↓	
	Below 3 mph (5 km/h)	Stop *2	

*1 : The Warning Pattern repeats 11 times with an interval of 24 seconds. If the driver's seat belt is buckled, the light will stop within 6 seconds and chime will stop immediately.

*2 : The light will stop within 6 seconds and chime will stop immediately.

**Seat belt warning light
(for front passenger's seat)**

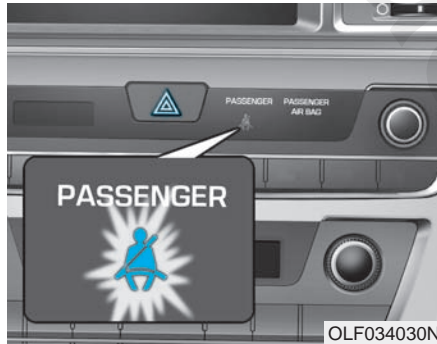

OLF034030N

The front passenger's seat belt warning light will activate to the following table when the ignition switch is in "ON" position.

Conditions		Warning Pattern
Seat Belt	Vehicle Speed	Light-Blink
Unbuckled		6 seconds
Unbuckled	Above 6mph (10 km/h)	Continuously
Buckled		6 seconds
Buckled → Unbuckled	Above 6mph (10 km/h)	Continuously *1
	Below 6mph (10 km/h)	None

*1 : The seat belt warning light will go off if the vehicle speed decreases below 3 mph (5 km/h). If the vehicle speed increases above 3 mph (5 km/h), the warning light will blink again.

Seat Belt Restraint System

Seat Belt-Driver's 3-point system with emergency locking retractor

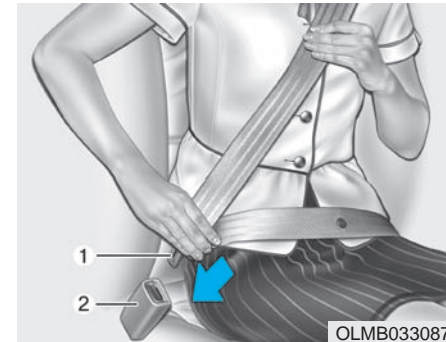

OLMB033087

To fasten your seat belt:

Pull the seat belt out of the retractor and insert the metal tab (1) into the buckle (2). There will be an audible "click" when the tab locks into the buckle.

The seat belt automatically adjusts to the proper length after the lap belt portion is adjusted manually so that it fits snugly around your hips. If you lean forward in a slow, easy motion, the belt will extend and move with you.

If there is a sudden stop or impact, the belt will lock into position. It will also lock if you try to lean forward too quickly.

NOTICE

If you are not able to smoothly pull enough of the seat belt out from the retractor, firmly pull the seat belt out and release it. After release, you will be able to pull the belt out smoothly.

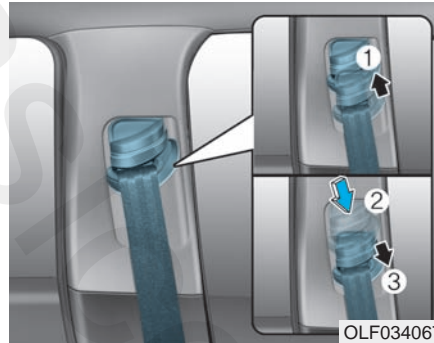

Height adjustment

You can adjust the height of the shoulder belt anchor to one of the four different positions for maximum comfort and safety.

The shoulder portion should be adjusted so it lies across your chest and midway over your shoulder nearest the door, not over your neck.

To adjust the height of the seat belt anchor, lower or raise the height adjuster into an appropriate position.

To raise the height adjuster, pull it up (1). To lower it, push it down (3) while pressing the height adjuster button (2). Release the button to lock the anchor into position. Try sliding the height adjuster to make sure that it has locked into position.

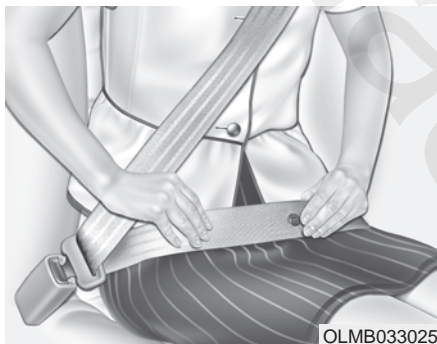

⚠ WARNING

Improperly positioned seat belts may increase the risk of serious injury in an accident. Take the following precautions when adjusting the seat belt:

- Position the lap portion of the seat belt as low as possible across your hips, not on your waist, so that it fits snugly.

(Continued)

(Continued)

- Position one arm under the shoulder belt and the other over the belt, as shown in the illustration.
- Always position the shoulder belt anchor into the locked position at the appropriate height.
- Never position the shoulder belt across your neck or face.

Rear Seat Belt – Passenger’s 3-point system with convertible locking retractor

This type of seat belt combines the features of both an emergency locking retractor seat belt and an automatic locking retractor seat belt. Convertible retractor type seat belts are installed in the rear seat positions to help accommodate the installation of child restraint systems. Although a convertible retractor is also installed in the front passenger seat position, NEVER place any infant/child restraint system in the front seat of the vehicle.

To fasten your seat belt:

Pull the seat belt out of the retractor and insert the metal tab into the buckle. There will be an audible "click" when the tab locks into the buckle. When not securing a child restraint, the seat belt operates in the same way as the driver's seat belt (Emergency Locking Retractor Type). It automatically adjusts to the proper length only after the lap belt portion of the seat belt is adjusted manually so that it fits snugly across your hips.

When the seat belt is fully extended from the retractor to allow the installation of a child restraint system, the seat belt operation changes to allow the belt to retract, but not to extend (Automatic Locking Retractor Type). Refer to the “Using a Child Restraint System” section in this chapter.

NOTICE

Although the seat belt retractor provides the same level of protection for seated passengers in either emergency or automatic locking modes, the emergency locking mode allows seated passengers to move freely in their seat while keeping some tension on the belt. During a collision or sudden stop, the retractor automatically locks the belt to help restrain your body.

To deactivate the automatic locking mode, allow the unbuckled seat belt to fully retract.

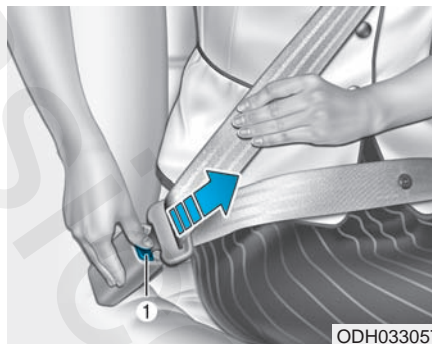
**To release your seat belt:**

Press the release button (1) in the locking buckle.

When it is released, the belt should automatically draw back into the retractor. If this does not happen, check the belt to be sure it is not twisted, then try again.

**Pre-tensioner seat belt
(Driver and front passenger)****Retractor Pre-tensioner**

Your vehicle is equipped with driver's and front passenger's Pre-tensioner Seat Belts. The purpose of the pre-tensioner is to make sure the seat belts fit tightly against the occupant's body in certain frontal collisions. The pre-tensioner seat belts may be activated in crashes where the frontal collision is severe enough.

If the system senses excessive tension on the driver's or passenger's seat belt when the pre-tensioner activates, the load limiter inside the pre-tensioner will release some of the pressure on the affected seat belt.

When the vehicle stops suddenly, or if the occupant tries to lean forward too quickly, the seat belt retractor will lock into position. In certain frontal collisions, the pre-tensioner will activate and pull the seat belt into tighter contact against the occupant's body.



Seat Belt Anchor Pre-tensioner

The purpose of the Seat Belt Anchor Pre-tensioner is to help the lap belt fit tightly against the occupant's lower body in certain frontal collisions. The Seat Belt Anchor Pre-tensioner may be activated in crashes where the frontal collision is severe enough.

⚠ WARNING

- Always wear your seat belt and sit properly in your seat.
- Do not use the seat belt if it is loose or twisted. A loose or twisted seat belt will not protect you properly in an accident.
- Do not place anything near the buckle. This may adversely affect the buckle and cause it to function improperly.
- Always replace your pre-tensioners after activation or an accident.
- **NEVER** inspect, service, repair or replace the pre-tensioners yourself. This must be done by an authorized HYUNDAI dealer.
- Do not hit the seat belt assemblies.

⚠ WARNING

Do not touch the pre-tensioner seat belt assemblies for several minutes after they have been activated. When the pre-tensioner seat belt mechanism deploys during a collision, the pre-tensioners become hot and can burn you.

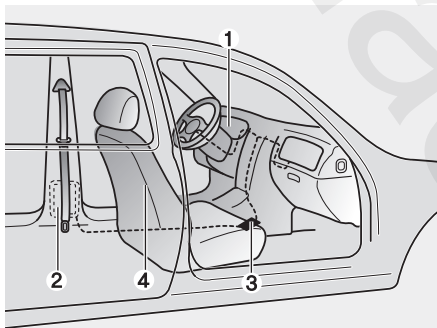

1LDE3100/Q

The Pre-Tensioner Seat Belt System consists mainly of the following components. Their locations are shown in the illustration above:

1. SRS air bag warning light
2. Retractor pre-tensioner
3. SRS control module
4. Anchor Pre-tensioner

NOTICE

The sensor that activates the SRS air bag is connected with the pre-tensioner seat belts. The SRS air bag warning light on the instrument panel will illuminate for approximately 6 seconds after the ignition switch is in the ON position, and then it should turn off.

If the pre-tensioner is not working properly, the warning light will illuminate even if the SRS air bag is not malfunctioning. If the warning light does not illuminate, stays illuminated or illuminates when the vehicle is being driven, have an authorized HYUNDAI dealer inspect the pre-tensioner seat belts and SRS air bags as soon as possible.

NOTICE

- Both the driver's and front passenger's pre-tensioner seat belts may be activated in certain frontal or side collisions or rollovers.
- The pre-tensioners will not be activated if the seat belts are not worn at the time of the collision.
- When the pre-tensioner seat belts are activated, a loud noise may be heard and fine dust, which may appear to be smoke, may be visible in the passenger compartment. These are normal operating conditions and are not hazardous.
- Although it is non-toxic, the fine dust may cause skin irritation and should not be breathed for prolonged periods. Wash all exposed skin areas thoroughly after an accident in which the pre-tensioner seat belts were activated.

Rear center seat belt

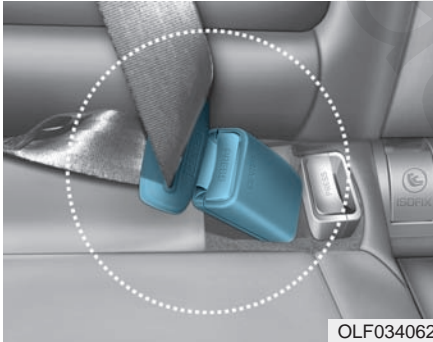

OLF034062

When using the rear center seat belt, the buckle with the "CENTER" mark must be used.

Additional Seat Belt Safety Precautions

Seat belt use during pregnancy

The seat belt should always be used during pregnancy. The best way to protect your unborn child is to protect yourself by always wearing the seat belt.

Pregnant women should always wear a lap-shoulder seat belt. Place the shoulder belt across your chest, routed between your breasts and away from your neck. Place the shoulder belt across the chest, routed away from the neck. Place the lap belt below the belt line so that it fits snugly and as low as possible across the hips, not across the abdomen.

⚠ WARNING

To reduce the risk of serious injury or death to an unborn child during an accident, pregnant women should NEVER place the lap portion of the seat belt above or over the area of the abdomen where the unborn child is located.

Seat belt use and children

Infant and small children

All 50 states have child restraint laws which require children to travel in approved child restraint devices, including booster seats. The age at which seat belts can be used instead of child restraints differs among states, so you should be aware of the specific requirements in your state, and where you are travelling. Infant and child restraints must be properly placed and installed in a rear seat. For more information refer to the "Child Restraint Systems" section in this chapter.

 **WARNING**

ALWAYS properly restrain infants and small children in a child restraint appropriate for the child's height and weight.

To reduce the risk of serious injury or death to a child and other passengers, NEVER hold a child in your lap or arms when the vehicle is moving. The violent forces created during an accident will tear the child from your arms and throw the child against the interior of the vehicle.

Small children are best protected from injury in an accident when properly restrained in the rear seat by a child restraint system that meets the requirements of the Federal Motor Vehicle Safety Standards. Before buying any child restraint system, make sure that it has a label certifying that it meets Federal Motor Vehicle Safety Standard 213. The restraint must be appropriate for your child's height and weight. Check the label on the child restraint for this information. Refer to the "Child Restraint Systems" section in this chapter.

Larger children

Children under age 13 and who are too large for a booster seat must always occupy the rear seat and use the available lap/shoulder belts. A seat belt should lie across the upper thighs and be snug across the shoulder and chest to restrain the child safely. Check belt fit periodically. Children are afforded the most safety in the event of an accident when they are restrained by a proper restraint system and/or seat belts in the rear seat. Always have the LATCH system inspected by your authorized HYUNDAI dealer after an accident. An accident can damage the LATCH system and may not properly secure the child restraint.

If a larger child over age 13 must be seated in the front seat, the child must be securely restrained by the available lap/shoulder belt and the seat should be placed in the rear-most position.

If the shoulder belt portion slightly touches the child's neck or face, try placing the child closer to the center of the vehicle. If the shoulder belt still touches their face or neck they need to be returned to an appropriate booster seat in the rear seat.

WARNING

- **Always make sure children are wearing their seat belts and that they are properly adjusted before driving.**
- **NEVER allow the shoulder belt to contact the child's neck or face.**
- **Do not allow more than one child to use a single seat belt.**

Transporting an injured person

A seat belt should be used when an injured person is being transported. Consult a physician for specific recommendations.

One person per belt

Two people (including children) should never attempt to use a single seat belt. This could increase the severity of injuries in case of an accident.

Do not lie down

Sitting in a reclined position when the vehicle is in motion can be dangerous. Even when buckled up, the protections of your restraint system (seat belts and air bags) is greatly reduced by reclining your seatback.

To reduce the chance of injuries in the event of an accident and to achieve the maximum effectiveness of the restraint system, all passengers should be sitting up and the front and rear seats should be in an upright position when the car is moving.

A seat belt cannot provide proper protection if the person is lying down in the rear seat or if the front or rear seats are in a reclined position.

WARNING

- **NEVER ride with a reclined seatback when the vehicle is moving.**
- **Riding with a reclined seatback increases your chance of serious or fatal injuries in the event of a collision or sudden stop.**
- **Drivers and passengers should always sit well back in their seats, properly belted, and with the seatbacks upright.**

Care of Seat Belts

Seat belt systems should never be disassembled or modified. In addition, care should be taken to assure that seat belts and belt hardware are not damaged by seat hinges, doors or other abuse.

Periodic inspection

All seat belts should be inspected periodically for wear or damage of any kind. Any damaged parts should be replaced as soon as possible by an authorized HYUNDAI dealer.

Keep belts clean and dry

Seat belts should be kept clean and dry. If belts become dirty, they can be cleaned by using a mild soap solution and warm water. Bleach, dye, strong detergents or abrasives should not be used because they may damage and weaken the fabric.

When to replace seat belts

The entire seat belt assembly or assemblies should be replaced if the vehicle has been involved in an accident. This should be done even if no damage is visible. Additional questions concerning seat belt operation should be directed to an authorized HYUNDAI dealer.

CHILD RESTRAINT SYSTEM (CRS)

Children Always in the Rear

WARNING

Always properly restrain children in the rear seats of the vehicle.

Children of all ages are safer when restrained in the rear seat. A child riding in the front passenger seat can be forcefully struck by an inflating air bag resulting in SERIOUS INJURY or DEATH.

Children under age 13 must always ride in the rear seats and must always be properly restrained to minimize the risk of injury in an accident, sudden stop or sudden maneuver. According to accident statistics, children are safer when properly restrained in the rear seats than in the front seat. **Even with air bags, children can be seriously injured or killed.** Children too large for a child restraint must use the seat belts provided.

All 50 states have child restraint laws which require children to travel in approved child restraint devices. The laws governing the age or height/weight restrictions at which seat belts can be used instead of child restraints differs among states, so you should be aware of the specific requirements in your state, and where you are travelling.

Child restraint systems must be properly placed and installed in the rear seat. You must use a commercially available child restraint system that meets the requirements of the Federal Motor Vehicle Safety Standards (FMVSS).

Child restraint systems are generally designed to be secured in a vehicle seat by lap belt portion of a lap/shoulder belt, or by a LATCH system in the rear seats of the vehicle.

Child restraint system (CRS)

Infants and younger children must be restrained in an appropriate rear-facing or forward-facing CRS that has first been properly secured to the rear seat of the vehicle. Read and comply with the instructions for installation and use provided by the manufacturer of the child restraint.

WARNING

An improperly secured child restraint can increase the risk of **SERIOUS INJURY** or **DEATH** in an accident. Always take the following precautions when using a child restraint system:

- **NEVER** install a child or infant restraint in the front passenger's seat.
- Always properly secure the child restraint to a rear seat of the vehicle.

(Continued)

(Continued)

- **Always follow the child restraint system manufacturer's instructions for installation and use.**
- **Always properly restrain your child in the child restraint.**
- **If the vehicle head restraint prevents proper installation of a child seat (as described in the child restraint system manual), the head restraint of the respective seating position shall be readjusted or entirely removed.**
- **Do not use an infant carrier or a child safety seat that "hooks" over a seatback, it may not provide adequate protection in an accident.**
- **After an accident, have a HYUNDAI dealer check the child restraint system, seat belts, tether anchors and lower anchors.**

Selecting a Child Restraint System (CRS)

When selecting a CRS for your child, always:

- Make sure the CRS has a label certifying that it meets applicable Federal Motor Vehicle Safety Standards (FMVSS 213).
- Select a child restraint based on your child's height and weight. The required label or the instructions for use typically provide this information.
- Select a child restraint that fits the vehicle seating position where it will be used.
- Read and comply with the warnings and instructions for installation and use provided with the child restraint system.

Child restraint system types

There are three main types of child restraint systems: rear-facing seats, forward-facing seats, and booster seats. They are classified according to the child's age, height and weight.

Rear-facing child seats

⚠ WARNING

NEVER install a child or infant restraint in the front passenger's seat.

Placing a rear-facing child restraint in the front seat can result in SERIOUS INJURY or DEATH if the child restraint is struck by an inflating air bag.

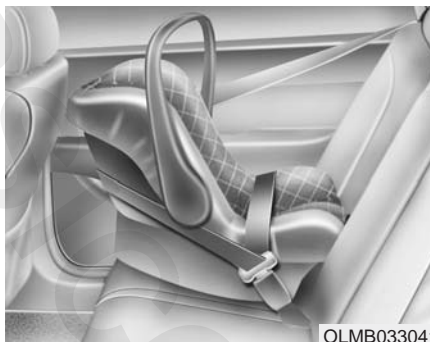

A rear-facing child seat provides restraint with the seating surface against the back of the child. The harness system holds the child in place, and in an accident, acts to keep the child positioned in the seat and reduce the stress to the neck and spinal cord.

All children under age one must always ride in a rear-facing infant child restraint.

Convertible and 3-in-1 child seats typically have higher height and weight limits for the rear-facing position, allowing you to keep your child rear-facing for a longer period of time.

Continue to use a rear-facing child seat for as long as your child will fit within the height and weight limits allowed by the child seat manufacturer. It's the best way to keep them safe. Once your child has outgrown the rear-facing child restraint, your child is ready for a forward-facing child restraint with a harness.



Forward-facing child restraints

A forward-facing child seat provides restraint for the child's body with a harness. Keep children in a forward-facing child seat with a harness until they reach the top height or weight limit allowed by your child restraint's manufacturer.

Once your child outgrows the forward-facing child restraint, your child is ready for a booster seat.

Booster seats

A booster seat is a restraint designed to improve the fit of the vehicle's seat belt system. A booster seat positions the seat belt so that it fits properly over the lap of your child.

Keep your child in a booster seat until they are big enough to sit in the seat without a booster and still have the seat belt fit properly. For a seat belt to fit properly, the lap belt must lie snugly across the upper thighs, not the stomach. The shoulder belt should lie snug across the shoulder and chest and not across the neck or face. Children under age 13 must always ride in the rear seats and must always be properly restrained to minimize the risk of injury.

Installing a Child Restraint System (CRS)

WARNING

Before installing your child restraint system always:

- Read and follow the instructions provided by the manufacturer of the child restraint.
- Read and follow the instructions regarding child restraint systems in this manual.

Failure to follow all warnings and instructions could increase the risk of the SERIOUS INJURY or DEATH if an accident occurs.

WARNING

If the vehicle headrest prevents proper installation of a child seat (as described in the child seat system manual, the headrest of the respective seating position shall be readjusted or entirely removed.

After selecting a proper child seat for your child, check to make sure it fits properly in your vehicle. Follow the instructions provided by the manufacturer when installing the child seat. Note these general steps when installing the seat to your vehicle:

- **Properly secure the child restraint to the vehicle.** All child restraints must be secured to the vehicle with the lap part of a lap/shoulder belt or with the LATCH system.
- **Make sure the child restraint is firmly secured.** After installing a child restraint to the vehicle, push and pull the seat forward and from side-to-side to verify that it is securely attached to the seat. A child restraint secured with a seat belt should be installed as firmly as possible. However, some side-to-side movement can be expected.
- **Secure the child in the child restraint.** Make sure the child is properly strapped in the child restraint according to the manufacturer instructions.

CAUTION

A child restraint in a closed vehicle can become very hot. To prevent burns, check the seating surface and buckles before placing your child in the child restraint.

Lower Anchors and Tether for Children (LATCH) System

The LATCH system holds a child restraint during driving and in an accident. This system is designed to make installation of the child restraint easier and reduce the possibility of improperly installing your child restraint. The LATCH system uses anchors in the vehicle and attachments on the child restraint. The LATCH system eliminates the need to use seat belts to secure the child restraint to the rear seats.

Lower anchors are metal bars built into the vehicle. There are two lower anchors for each LATCH seating position that will accommodate a child restraint with lower attachments.

To use the LATCH system in your vehicle, you must have a child restraint with LATCH attachments.

The child seat manufacturer will provide you with instructions on how to use the child seat with its attachments for the LATCH lower anchors.

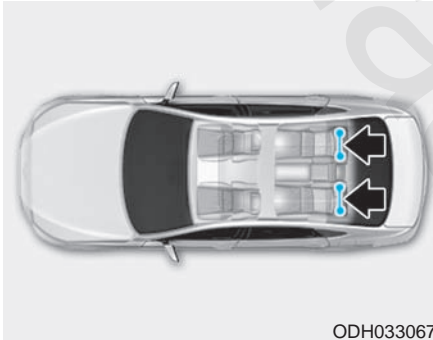

ODH033067

LATCH anchors have been provided in the left and right outboard rear seating positions. Their locations are shown in the illustration. There are no LATCH anchors provided for the center rear seating position.

⚠ WARNING

Do not attempt to install a child restraint system using LATCH anchors in the rear center seating position. There are no LATCH anchors provided for this seat. Using the outboard seat anchors can damage the anchors which may break or fail in a collision resulting in serious injury or death.

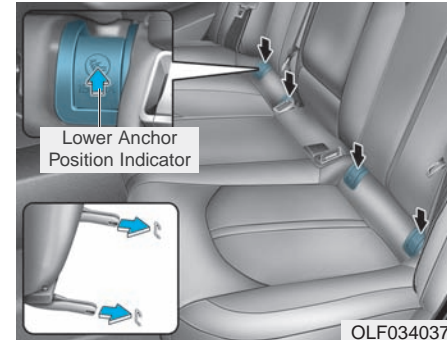

OLF034037

The lower anchor position indicator symbols are located on the left and right rear seat backs to identify the position of the lower anchors in your vehicle (see arrows in illustration).

The LATCH anchors are located between the seatback and the seat cushion of the rear seat left and right outboard seating positions.

To use the lower anchor, push the upper portion of the lower anchor cover.

Securing a child restraint with the LATCH anchors system

To install a LATCH-compatible child restraint in either of the rear outboard seating positions:

1. Move the seat belt buckle away from the lower anchors.
2. Move any other objects away from the anchors that could prevent a secure connection between the child restraint and the lower anchors.
3. Place the child restraint on the vehicle seat, then attach the seat to the lower anchors according to the instructions provided by the child restraint manufacturer.
4. Follow the child restraint instructions for properly adjusting and tightening the lower attachments on the child restraint to the lower anchors.

⚠ WARNING

Take the following precautions when using the LATCH system:

- **Read and follow all installation instructions provided with your child restraint system.**
- **To prevent the child from reaching and taking hold of unretracted seat belts, buckle all unused rear seat belts and retract the seat belt webbing behind the child. Children can be strangled if a shoulder belt becomes wrapped around their neck and the seat belt tightens.**
- **NEVER attach more than one child restraint to a single anchor. This could cause the anchor or attachment to come loose or break.**
- **Always have the LATCH system inspected by your authorized HYUNDAI dealer after an accident. An accident can damage the LATCH system and may not properly secure the child restraint.**

NOTICE

The recommended weight for the LATCH system is under 65 lb (30 kg).

How to calculate the child restraint weight :

Child restraint weight =

65 lb (30 kg) - Child weight

Securing a child restraint seat with “Tether Anchor” system

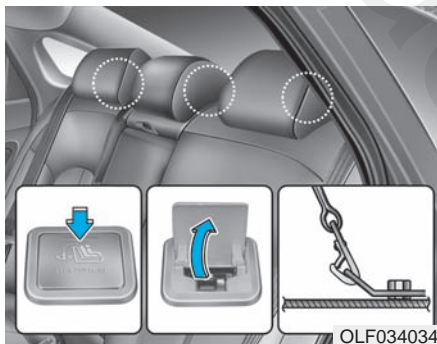

First secure the child restraint with the LATCH lower anchors or the seat belt. If the child restraint manufacturer recommends that the top tether strap be attached, attach and tighten the top tether strap to the top tether strap anchor.

Child restraint hook holders are located on the package tray.

⚠ WARNING

Take the following precautions when installing the tether strap:

- Read and follow all installation instructions provided with your child restraint system.
- **NEVER** attach more than one child restraint to a single tether anchor. This could cause the anchor or attachment to come loose or break.
- **Do not attach the tether strap to anything other than the correct tether anchor. It may not work properly if attached to something else.**
- **Do not use the tether anchors for adult seat belts or harnesses, or for attaching other items or equipment to the vehicle.**



To install the tether anchor:

1. Route the child restraint tether strap over the child restraint seatback. Route the tether strap under the head restraint and between the head restraint posts, or route the tether strap over the top of the vehicle seatback. Make sure the strap is not twisted.
2. Connect the tether strap hook to the tether anchor, then tighten the tether strap according to the child seat manufacturer's instructions to firmly secure the child restraint to the seat.
3. Check that the child restraint is securely attached to the seat by pushing and pulling the seat forward and from side-to-side.

Securing a child restraint with a lap belt or lap/shoulder belt

When not using the LATCH system, all child restraints must be secured to a vehicle rear seat with the lap part of a lap/shoulder belt.

⚠ WARNING

ALWAYS place a rear-facing child restraint in the rear seat of the vehicle.

Placing a rear-facing child restraint in the front seat can result in serious injury or death if the child restraint is struck by an inflating air bag.

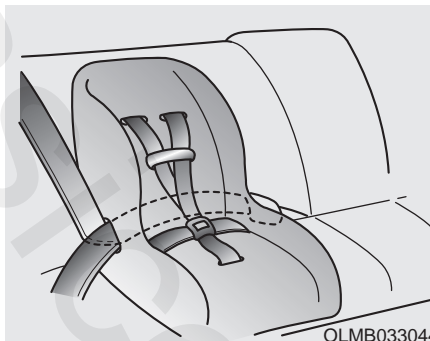

Automatic locking mode

Since all passenger seat belts move freely under normal conditions and only lock under extreme or emergency conditions (emergency locking mode), you must manually pull the seat belt all the way out to shift the retractor to the "Automatic Locking" mode to secure a child restraint.

The "Automatic Locking" mode will help prevent the normal movement of the child in the vehicle from causing the seat belt to loosen and compromise the child restraint system. To secure a child restraint system, use the following procedure.

To install a child restraint system on the rear seats, do the following:

1. Place the child restraint system on a rear seat and route the lap/shoulder belt around or through the child restraint, following the restraint manufacturer's instructions.

Be sure the seat belt webbing is not twisted.

NOTICE

When using the rear center seat belt, you should also refer to the "3-point Rear Center Seat Belt" section in this chapter.

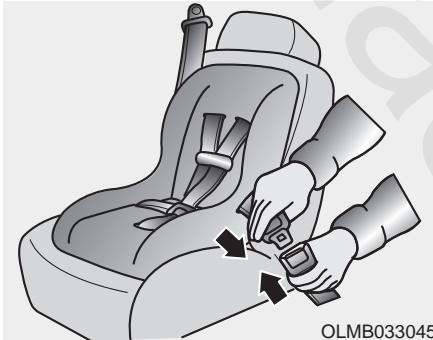

2. Fasten the lap/shoulder belt latch into the buckle. Listen for the distinct "click" sound.

i Information

Position the release button so that it is easy to access in case of an emergency.



3. Pull the shoulder portion of the seat belt all the way out. When the shoulder portion of the seat belt is fully extended, it will shift the retractor to the "Automatic Locking" (child restraint) mode.

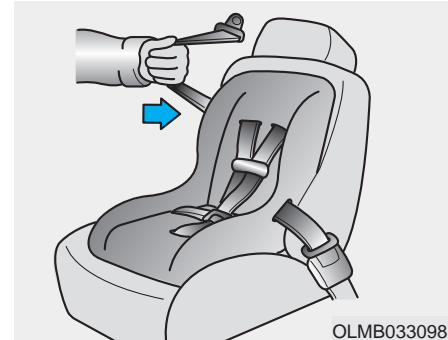

4. Slowly allow the shoulder portion of the seat belt to retract and listen for an audible "clicking" or "ratcheting" sound. This indicates that the retractor is in the "Automatic Locking" mode. If no distinct sound is heard, repeat steps 3 and 4.

5. Remove as much slack from the belt as possible by pushing down on the child restraint system while feeding the shoulder belt back into the retractor.
6. Push and pull on the child restraint system to confirm that the seat belt is holding it firmly in place. If it is not, release the seat belt and repeat steps 2 through 6.
7. Double check that the retractor is in the "Automatic Locking" mode by attempting to pull more of the seat belt out of the retractor. If you cannot, the retractor is in the "Automatic Locking" mode.

If your CRS manufacturer instructs or recommends you to use a tether anchor with the lap/shoulder belt, refer to the previous pages for more information.

NOTICE

When the seat belt is allowed to retract to its fully stowed position, the retractor will automatically switch from the "Automatic Locking" mode to the emergency lock mode for normal adult usage.

⚠ WARNING

If the retractor is not in the "Automatic Locking" mode, the child restraint can move when your vehicle turns or stops suddenly. A child can be seriously injured or killed if the child restraint is not properly anchored in the car, including manually pulling the seat belt all the way out to shift the retractor to the "Automatic Locking" mode.

To remove the child restraint, press the release button on the buckle and then pull the lap/shoulder belt out of the restraint and allow the seat belt to retract fully.

AIR BAG – ADVANCED SUPPLEMENTAL RESTRAINT SYSTEM

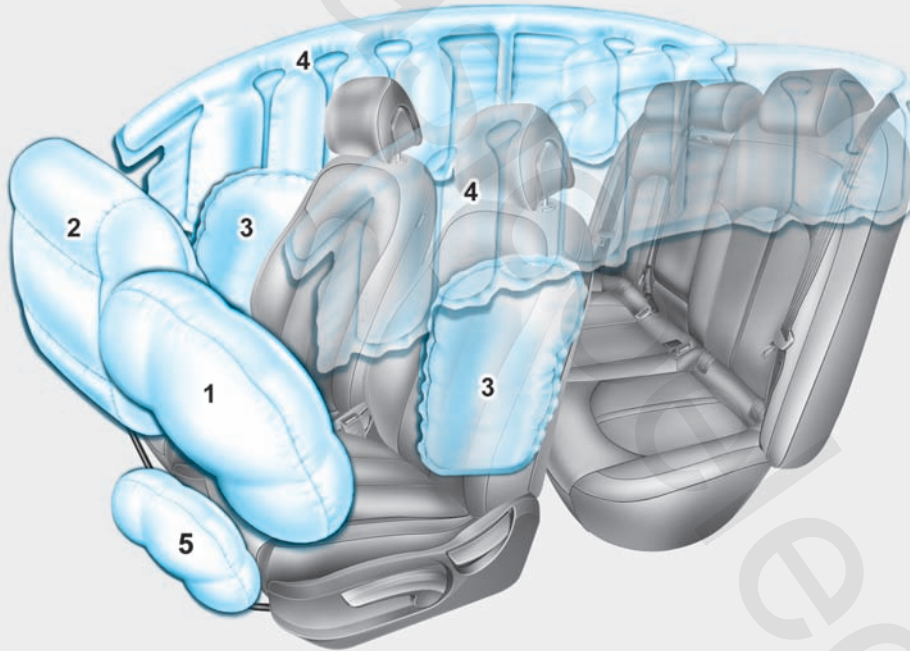

1. Driver's front air bag
2. Passenger's front air bag
3. Side air bag
4. Curtain air bag
5. Driver's knee air bag

The actual air bags in the vehicle may differ from the illustration.

OLF034038

This vehicle is equipped with an Advanced Supplemental Air Bag System for the driver's seat and front passenger's seats.

The front air bags are designed to supplement the three-point seat belts. For these air bags to provide protection, the seat belts must be worn at all times when driving.

You can be severely injured or killed in an accident if you are not wearing a seat belt. Air bags are designed to supplement seat belts, but do not replace them. Also, air bags are not designed to deploy in every collision. In some accidents, the seat belts are the only restraint protecting you.

WARNING

AIR BAG SAFETY PRECAUTIONS

ALWAYS use seat belts and child restraints - every trip, every time, everyone! Even with air bags, you can be seriously injured or killed in a collision if you are improperly belted or not wearing your seat belt when the air bag inflates.

NEVER place a child in any child restraint or booster seat in the front passenger seat. An inflating air bag could forcefully strike the infant or child causing serious or fatal injuries.

ABC - Always Buckle Children under age 13 in the back seat. It is the safest place for children of any age to ride. If a child age 13 or older must be seated in the front seat, he or she must be properly belted and the seat should be moved as far back as possible.

All occupants should sit upright with the seatback in an upright position, centered on the seat cushion with their seat belt on, legs comfortably extended and their feet on the floor until the vehicle is parked and the engine is turned off. If an occupant is out of position during an accident, the rapidly deploying air bag may forcefully contact the occupant causing serious or fatal injuries.

You and your passengers should never sit or lean unnecessarily close to the air bags or lean against the door or center console.

Move your seat as far back as possible from front air bags, while still maintaining control of the vehicle. The U.S. National Highway Traffic Safety Administration (NHTSA) recommends that drivers allow at least 10 inches (25 cm) between the center of the steering wheel and the chest.

Where Are the Air Bags?

Driver's and passenger's front air bags

Your vehicle is equipped with a Advanced Supplemental Restraint System (SRS) and lap/shoulder belts at both the driver and passenger seating positions.

The SRS consists of air bags which are located in the center of the steering wheel, in the driver's side lower crash pad below the steering wheel column and the passenger's side front panel pad above the glove box.

The air bags are labeled with the letters "AIR BAG" embossed on the pad covers.

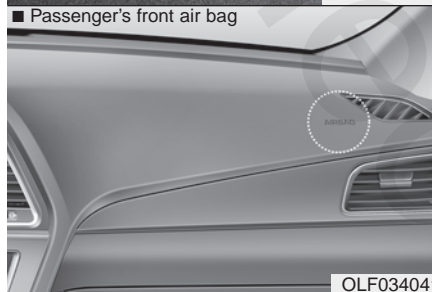

The purpose of the SRS is to provide the vehicle's driver and front passengers with additional protection than that offered by the seat belt system alone. The SRS uses sensors to gather information about the driver's and front passenger's seat belt usage and impact severity.

The seat belt buckle sensors determine if the driver and front passenger's seat belts are fastened. These sensors provide the ability to control the SRS deployment based on whether or not the seat belts are fastened, and how severe the impact is.

The advanced SRS offers the ability to control the air bag inflation within two levels. A first stage level is provided for moderate-severity impacts. A second stage level is provided for more severe impacts.

According to the impact severity, and seat belt usage, the SRS Control Module (SRSCM) controls the air bag inflation. Failure to properly wear seat belts can increase the risk or severity of injury in an accident.

⚠ WARNING

To reduce the risk of serious injury or death from an inflating front air bags, take the following precautions:

- Seat belts must be worn at all times to help keep occupants positioned properly.
- Move your seat as far back as possible from front air bags, while still maintaining control of the vehicle.
- Never lean against the door or center console.
- Do not allow the front passenger to place their feet or legs on the dashboard.
- No objects should be placed over or near the air bag modules on the steering wheel, instrument panel, and the front passenger's panel above the glove box. Such objects could cause harm if the vehicle is in a crash severe enough to cause the air bags to deploy.

Side air bags

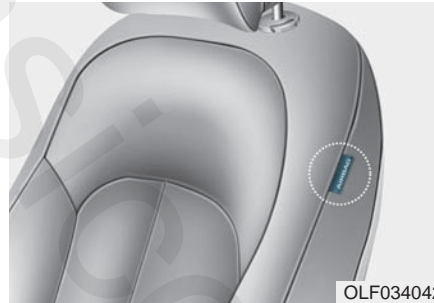

OLF034042

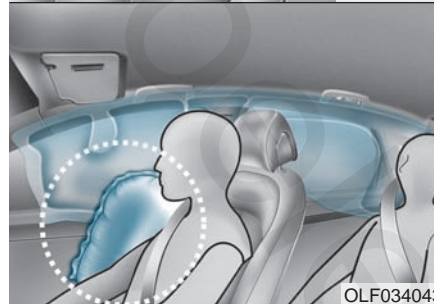

OLF034043

Your vehicle is equipped with a side air bag in each front seat. The purpose of the air bag is to provide the vehicle's driver and the front passenger with additional protection than that offered by the seat belt alone.

The side air bags are designed to deploy during certain side impact collisions, depending on the crash severity, angle, speed and point of impact.

The side and curtain air bags on both sides of the vehicle may deploy if a rollover or possible rollover is detected.

The side air bags are not designed to deploy in all side impact or rollover situations.

WARNING

To reduce the risk of serious injury or death from an inflating side air bag, take the following precautions:

- Seat belts must be worn at all times to help keep occupants positioned properly.
- Do not allow passengers to lean their heads or bodies onto doors, put their arms on the doors, stretch their arms out of the window, or place objects between the doors and seats.
- Hold the steering wheel at the 9 o'clock and 3 o'clock positions, to minimize the risk of injuries to your hands and arms.
- Do not use any accessory seat covers. This could reduce or prevent the effectiveness of the system.
- Do not place any objects over the air bag or between the air bag and yourself.

(Continued)

(Continued)

- Do not place any objects between the door and the seat. They may become dangerous projectiles if the side air bag inflates.
- Do not install any accessories on the side or near the side air bags.
- Do not cause impact to the doors when the ignition switch is in the ON position or this may cause the side air bags to inflate.
- If the seat or seat cover is damaged, have the vehicle checked and repaired by an authorized HYUNDAI dealer.

Curtain air bags

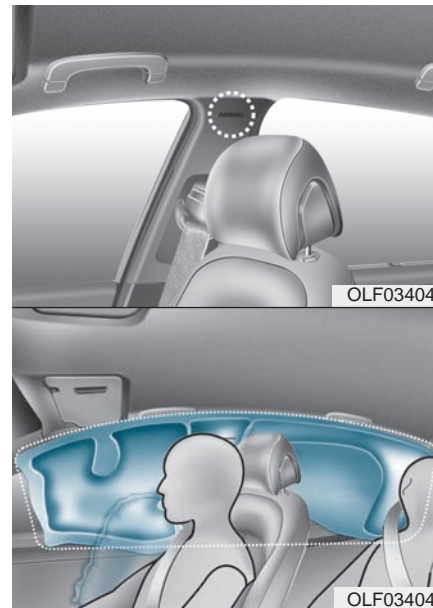

Curtain air bags are located along both sides of the roof rails above the front and rear doors.

They are designed to help protect the heads of the front seat occupants and the rear outboard seat occupants in certain side impact collisions.

The curtain air bags are designed to deploy during certain side impact collisions, depending on the crash severity, angle, speed and impact.

The side and curtain air bags on both sides of the vehicle may deploy if a rollover or possible rollover is detected.

The curtain air bags are not designed to deploy in all side impact or rollover situations.

⚠ WARNING

To reduce the risk of serious injury or death from inflating curtain air bags, take the following precautions:

- **All seat occupants must wear seat belts at all times to help keep occupants positioned properly.**
- **Properly secure child restraints as far away from the door as possible.**
- **Do not allow passengers to lean their heads or bodies onto doors, put their arms on the doors, stretch their arms out of the window, or place objects between the doors and seats.**
- **Do not open or repair the side curtain air bags.**

How Does the Air Bag System Operate?

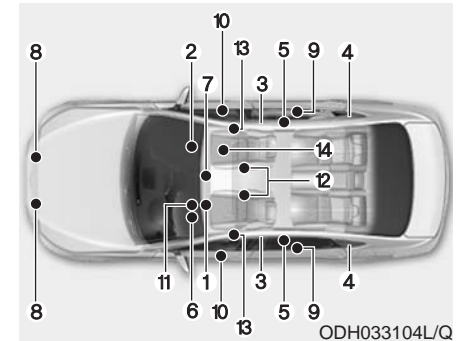

The SRS consists of the following components:

1. Driver's front air bag module
2. Passenger's front air bag module
3. Side air bag modules
4. Curtain air bag modules
5. Retractor pre-tensioner assemblies
6. Air bag warning light
7. SRS control module (SRSCM)/ Rollover sensor
8. Front impact sensors
9. Side impact sensors

10. Side pressure sensors
11. Driver's knee air bag module
12. Driver's and front passenger's seat belt buckle sensors
13. Anchor pre-tensioner
14. Occupant classification system

The SRSCM continually monitors all SRS components while the Engine Start/Stop button is in the ON position to determine if a crash impact is severe enough to require air bag deployment or pre-tensioner seat belt deployment.



SRS warning light

The SRS (Supplement Restraint System) air bag warning light on the instrument panel displays the air bag symbol depicted in the illustration. The system checks the air bag electrical system for malfunctions. The light indicates that there is a potential malfunction with your air bag system, which could include your side and curtain air bags used for rollover protection.

WARNING

If your SRS malfunctions, the air bag may not inflate properly during an accident increasing the risk of serious injury or death.

If any of the following conditions occur, your SRS is malfunctioning:

- **The light does not turn on for approximately six seconds when the ignition switch is in the ON position.**
- **The light stays on after illuminating for approximately six seconds.**
- **The light comes on while the vehicle is in motion.**
- **The light blinks when the engine is running.**

Have an authorized HYUNDAI dealer inspect the SRS as soon as possible if any of these conditions occur.

During a frontal collision, sensors will detect the vehicle's deceleration. If the rate of deceleration is high enough, the control unit will inflate the front air bags.

The front air bags help protect the driver and front passenger by responding to frontal impacts in which seat belts alone cannot provide adequate restraint. When needed, the side air bags help provide protection in the event of a side impact or rollover.

- Air bags are activated (able to inflate if necessary) only when the ignition switch is in the ON position.
- Air bags inflate in the event of certain frontal or side collisions to help protect the occupants from serious physical injury.
- There is no single speed at which the air bags will inflate. Generally, air bags are designed to inflate based upon the severity of a collision and its direction. These two factors determine whether the sensors produce an electronic deployment/inflation signal.

- Air bag deployment depends on a number of factors including vehicle speed, angles of impact and the density and stiffness of the vehicles or objects which your vehicle impacts during a collision. The determining factors are not limited to those mentioned above.

- The front air bags will completely inflate and deflate in an instant. It is virtually impossible for you to see the air bags inflate during an accident. It is much more likely that you will simply see the deflated air bags hanging out of their storage compartments after the collision.

- In addition to inflating in certain side collisions, vehicles equipped with a rollover sensor, side and curtain air bags will inflate if the sensing system detects a rollover.

When a rollover is detected, side and curtain air bags will remain inflated longer to help provide protection from ejection, especially when used in conjunction with the seat belts.

- To help provide protection, the air bags must inflate rapidly. The speed of air bag inflation is a consequence of extremely short time in which to inflate the air bag between the occupant and the vehicle structures before the occupant impacts those structures. This speed of inflation reduces the risk of serious or life-threatening injuries and is thus a necessary part of air bag design.

However, the rapid air bag inflation can also cause injuries which can include facial abrasions, bruises and broken bones because the inflation speed also causes the air bags to expand with a great deal of force.

- There are even circumstances under which contact with the air bag can cause fatal injuries, especially if the occupant is positioned excessively close to the air bag.

You can take steps to reduce the risk of being injured by an inflating air bag. The greatest risk is sitting too close to the air bag. An air bag needs about 10 inches (25 cm) of space to inflate. NHTSA recommends that drivers allow at least 10 inches (25 cm) between the center of the steering wheel and the chest.

⚠ WARNING

To reduce the risk of serious injury or death from an inflating air bag, take the following precautions:

- **NEVER** place a child restraint in the front passenger seat.

Always properly restrain children under age 13 in the rear seats of the vehicle.

- **Adjust the front passenger's and driver's seats as far to the rear as possible while allowing you to maintain full control of the vehicle.**
- **Hold the steering wheel with hands at the 9 o'clock and 3 o'clock positions.**
- **Never place anything or anyone between the air bag and the seat occupant.**
- **Do not allow the front passenger to place their feet or legs on the dashboard.**



When the SRSCM detects a sufficiently severe impact to the front of the vehicle, it will automatically deploy the front air bags.

■ Driver's front air bag (2)



Upon deployment, tear seams molded directly into the pad covers will separate under pressure from the expansion of the air bags. Further opening of the covers allows full inflation of the air bags.

A fully inflated air bag, in combination with a properly worn seat belt, slows the driver or the front passenger forward motion, reducing the risk of head and chest injury.

■ Driver's front air bag (3)

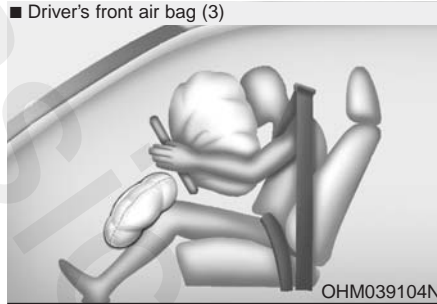

■ Passenger's front air bag



After complete inflation, the air bag immediately starts deflating, enabling the driver to maintain forward visibility and the ability to steer or operate other controls.

WARNING

To prevent objects from becoming dangerous projectiles when the passenger's air bag inflates:

- Do not install or place any objects (drink holder, CD holder, stickers, etc.) on the front passenger's panel above the glove box where the passenger's air bag is located.
- Do not install a container of liquid air freshener near the instrument cluster or on the instrument panel surface.

What to Expect After an Air Bag Inflates

After a frontal or side air bag inflates, it will deflate very quickly. Air bag inflation will not prevent the driver from seeing out of the windshield or being able to steer. Curtain air bags may remain partially inflated for some time after they deploy.

WARNING

After an air bag inflates, take the following precautions:

- Open your windows and doors as soon as possible after impact to reduce prolonged exposure to the smoke and powder released by the inflating air bag.
- Do not touch the air bag storage area's internal components immediately after an air bag has inflated. The parts that come into contact with an inflating air bag may be very hot.

(Continued)

(Continued)

- Always wash exposed skin areas thoroughly with lukewarm water and mild soap.
- Always have an authorized HYUNDAI dealer replace the air bag immediately after deployment. Air bags are designed to be used only once.

Noise and smoke from inflating air bag

When the air bags inflate, they make a loud noise and may produce smoke and powder in the air inside of the vehicle. This is normal and is a result of the ignition of the air bag inflator. After the air bag inflates, you may feel substantial discomfort in breathing because of the contact of your chest with both the seat belt and the air bag, as well as from breathing the smoke and powder. The powder may aggravate asthma for some people. If you experience breathing problems after an air bag deployment, seek medical attention immediately.

Though the smoke and powder are nontoxic, they may cause irritation to the skin, eyes, nose, throat, etc. If this is the case, wash and rinse with cold water immediately and seek medical attention if the symptoms persist.

Occupant Classification System (OCS)

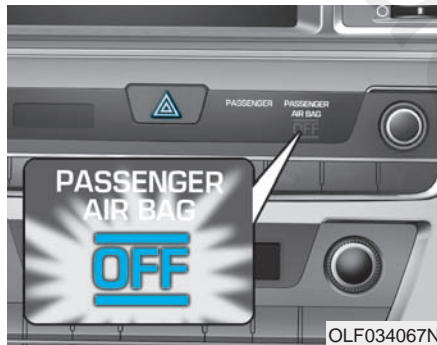

Your vehicle is equipped with an Occupant Classification System (OCS) in the front passenger's seat.

Main components of the Occupant Classification System

- A detection device located within the front passenger seat cushion.
- Electronic system to determine whether the passenger air bag systems should be activated or deactivated.
- An indicator light located on the instrument panel which illuminates the words "PASSENGER AIR BAG OFF" indicating the front passenger air bag system is deactivated.
- The instrument panel air bag indicator light is interconnected with the OCS.

The OCS is designed to detect the presence of a properly-seated front passenger and determine if the passenger's front air bag should be enabled (may inflate) or not.

The purpose is to help reduce the risk of injury or death from an inflating air bag to certain front passenger seat occupants, such as children, by requiring the air bag to be automatically turned OFF.

Front passenger seat adult occupants who are properly seated and wearing the seat belt properly, should not cause the passenger air bag to be automatically turned OFF. For small adults it may be turned OFF, however, if the occupant does not sit in the seat properly (for example, by not sitting upright, by sitting on the edge of the seat, or by otherwise being out of position), this could cause the sensor to turn the air bag OFF.

You will find the "PASSENGER AIR BAG OFF" indicator on the center facia panel. This system detects the conditions 1-4 in the following table and activates or deactivates the front passenger air bag based on these conditions.

Always be sure that you and all vehicle occupants are seated properly and wearing the seat belt properly for the most effective protection by the air bag and the seat belt.

The OCS may not function properly if the passenger takes actions which can affect the classification system. These include:

- Failing to sit in an upright position.
- Leaning against the door or center console.
- Sitting towards the sides of the front of the seat.
- Putting their legs on the dashboard or resting them on other locations which reduce the passenger weight on the front seat.
- Wearing the seat belt improperly.
- Reclining the seatback.
- Wearing a thick cloth like ski wear or hip protection wear.
- Putting an additional thick cushion on the seat.
- Putting electrical devices (e.g. notebook, satellite radio) on the seat with inverter charging.

Condition and operation in the front passenger Occupant Classification System

Condition detected by the occupant classification system	Indicator/Warning light		Devices
	"PASSENGER AIR BAG OFF" indicator light	SRS warning light	Front passenger air bag
1. Adult *1	Off	Off	Activated
2. Infant *2 or child restraint system with 12 months old *3 *4	On	Off	Deactivated
3. Unoccupied	On	Off	Deactivated
4. Malfunction in the system	Off	On	Activated

*1 The system judges a person of adult size as an adult. When a smaller adult sits in the front passenger seat, the system may recognize him/her as a child depending on his/her physique and posture.

*2 Do not allow children to ride in the front passenger seat. When a larger child who has outgrown a child restraint system sits in the front passenger seat, the system may recognize him/her as an adult depending upon his/her physique or sitting position.

*3 Never install a child restraint system on the front passenger seat.

*4 The PASSENGER AIR BAG "OFF" indicator may turn on or off when a child above 12 months to 12 years old (with or without child restraint system) sits in the front passenger seat. This is a normal condition.

⚠ WARNING

Riding in an improper position or placing weight on the front passenger's seat when it is unoccupied by a passenger adversely affects the OCS. To reduce the risk of serious injury or death:



- NEVER put a heavy load in the front seat or seatback pocket, or hang any items on the front passenger seat.



- NEVER ride with the seatback reclined when the vehicle is moving.



- NEVER place your feet on the front passenger seatback.



- NEVER place your feet or legs on the dashboard.



- NEVER sit with your hips shifted towards the front of the seat.



- NEVER lean on the door or center console or sit on one side of the front passenger seat.

(continued)

(continued)

- Do not put an electronic device (ex. Laptop computer, after market, navigation, satellite audio, video game machine, MP3, AC inverter, etc.) in the front passenger seatback pocket or on the front passenger seat.
- Do not place a sitting mat on the front passenger seat.
- Do not place any items under the front passenger seat.
- Do not place sharp objects on the front passenger seat. These may damage the occupant detection system, if they puncture the seat cushion.
- Avoid spilling liquids on the front seat; this may cause the OCS not to work properly. Keep the front seat dry at all times.

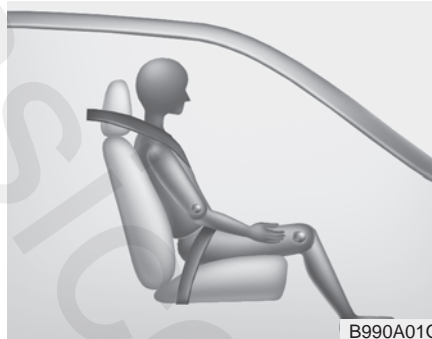

Proper seated position for OCS

If the "PASSENGER AIR BAG OFF" indicator is on when an adult is seated in the front passenger seat, place the ignition switch in the LOCK/OFF position and ask the passenger to sit properly (sitting upright with the seat back in an upright position, centered on the seat cushion with their seat belt on, legs comfortably extended and their feet on the floor). Restart the engine and have the person remain in that position. This will allow the system to detect the person and to enable the passenger air bag. If the "PASSENGER AIR BAG OFF" indicator is still on, ask the passenger to move to the rear seat.

WARNING

Never allow an adult passenger to ride in the front passenger seat when the "PASSENGER AIR BAG OFF" indicator is illuminated. During a collision, the air bag will not inflate if the indicator is illuminated. Have your passenger reposition himself in the seat. If the "PASSENGER AIR BAG OFF" indicator remains illuminated after the passenger repositions himself properly and the vehicle is restarted, have the passenger move to the rear seat because the air bag will not inflate.

NOTICE

The "PASSENGER AIR BAG OFF" indicator illuminates for approximately 4 seconds after the ignition switch is in the ON position or after the engine is started. If the front passenger seat is occupied, the OCS will then classify the front passenger after several more seconds.

Do Not Install a Child Restraint in the Front Passenger's Seat



Even though your vehicle is equipped with the OCS, never install a child restraint in the front passenger's seat. An inflating air bag can forcefully strike a child or child restraint resulting in serious or fatal injury.

⚠ WARNING

- **NEVER** place a rear-facing or front-facing child restraint in the front passenger's seat of the vehicle.
- An inflating frontal air bag could forcefully strike a child resulting in serious injury or death.
- Always properly restrain children in an appropriate child restraint in the rear seat of the vehicle.

Why Didn't My Air Bag Go Off in a Collision?

Air bags are not designed to inflate in every collision. There are certain types of accidents in which the air bag would not be expected to provide additional protection. These include rear impacts, second or third collisions in multiple impact accidents, as well as low speed impacts. Damage to the vehicle indicates a collision energy absorption, and is not an indicator of whether or not an air bag should have inflated.

Air bag collision sensors

WARNING

To reduce the risk of an air bag deploying unexpectedly and causing serious injury or death:

- **Do not hit or allow any objects to impact the locations where air bags or sensors are installed.**
- **Do not perform maintenance on or around the air bag sensors. If the location or angle of the sensors is altered, the air bags may deploy when they should not or may not deploy when they should.**
- **Do not install bumper guards or replace the bumper with a non-genuine HYUNDAI parts. This may adversely affect the collision and air bag deployment performance.**

(Continued)

(Continued)

- **Place the ignition switch in the LOCK/OFF or ACC position when the vehicle is being towed to prevent inadvertent air bag deployment.**
- **Have all air bag repairs conducted by an authorized HYUNDAI dealer.**

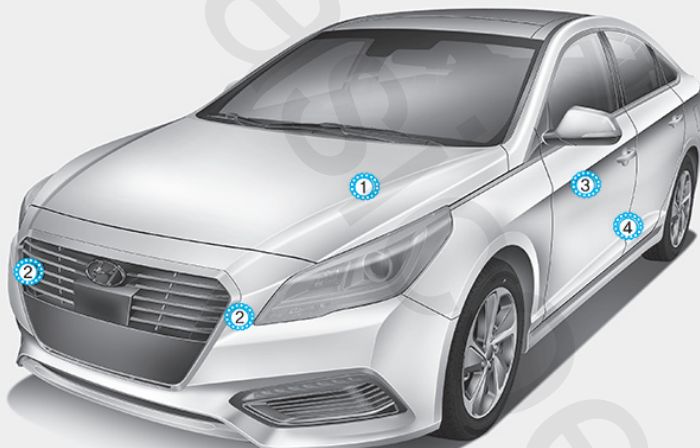

1. SRS control module
2. Front impact sensor
3. Side pressure sensor
4. Side impact sensor

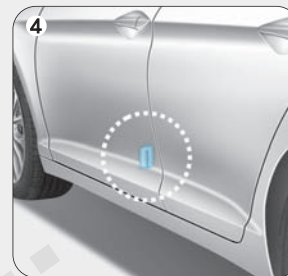
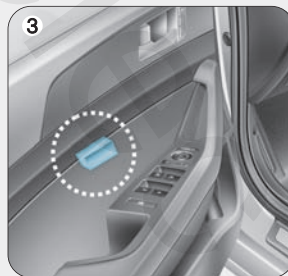
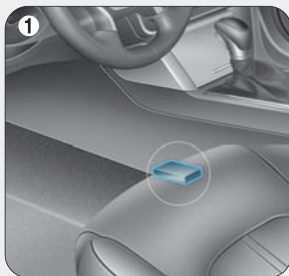

OLF034046N-1/OLF034047/OLF034048N/OLF034049/OLF034068

Air bag inflation conditions

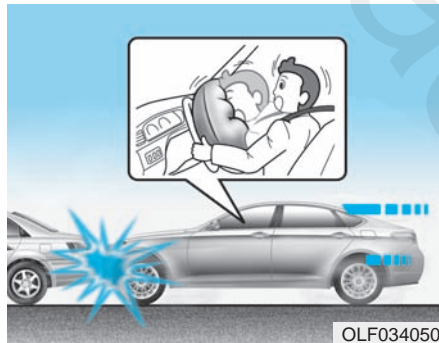

Front air bags

Front air bags and the driver's knee air bag are designed to inflate in a frontal collision depending on the severity, speed, or angles of impact of the front collision.

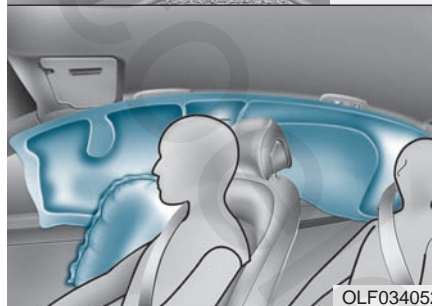
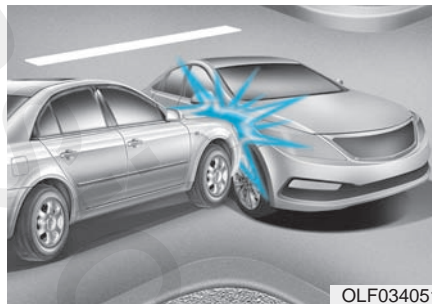

Side and curtain air bags

Side and curtain air bags are designed to inflate when an impact is detected by side collision sensors depending on the severity, speed, or angles of impact resulting from a side impact collision.

Although the driver's and front passenger's air bags are designed to inflate in frontal collisions, they also may inflate in other types of collisions if the front impact sensors detect a sufficient impact. Side and curtain air bags are designed to inflate in side impact collisions or rollover situations, but they may inflate in other collisions if the side impact sensors detect a sufficient impact. Also, the side and curtain air bags are designed to inflate when a rollover is detected by a rollover sensor.

If the vehicle chassis is impacted by bumps or objects on unimproved roads, the air bags may deploy. Drive carefully on unimproved roads or on surfaces not designed for vehicle traffic to prevent unintended air bag deployment.

Air bag non-inflation conditions

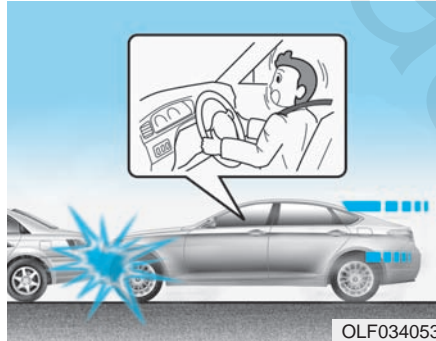

In certain low-speed collisions the air bags may not deploy. The air bags are designed not to deploy in such cases because they may not provide benefits beyond the protection of the seat belts.

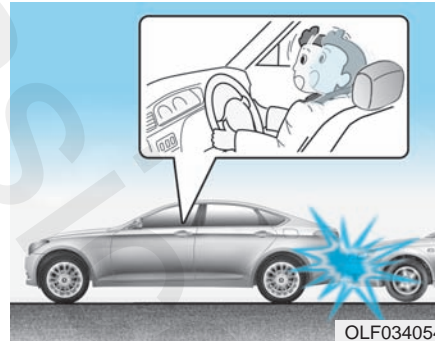

Front air bags are not designed to inflate in rear collisions, because occupants are moved backward by the force of the impact. In this case, inflated air bags would not provide any additional benefit.

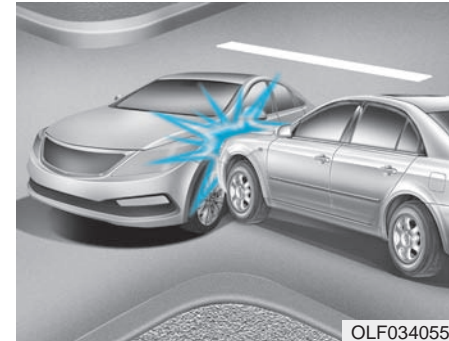

Front air bags may not inflate in side impact collisions, because occupants move in the direction of the collision, and thus in side impacts, front air bag deployment would not provide additional occupant protection.

However, side and curtain air bags may inflate depending on the severity, vehicle speed and angles of impact.



In an angled collision, the force of impact may direct the occupants in a direction where the air bags would not be able to provide any additional benefit, and thus the sensors may not deploy any air bags.

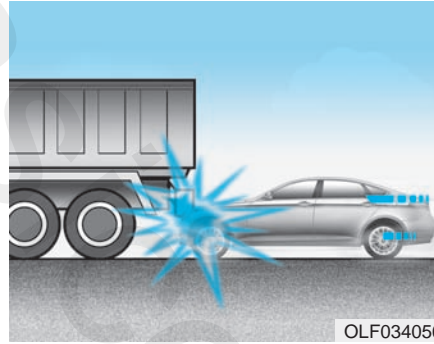

Just before impact, drivers often brake heavily. Such heavy braking lowers the front portion of the vehicle causing it to “ride” under a vehicle with a higher ground clearance. Air bags may not inflate in this “under-ride” situation because deceleration forces that are detected by sensors may be significantly reduced by such “override” collisions.

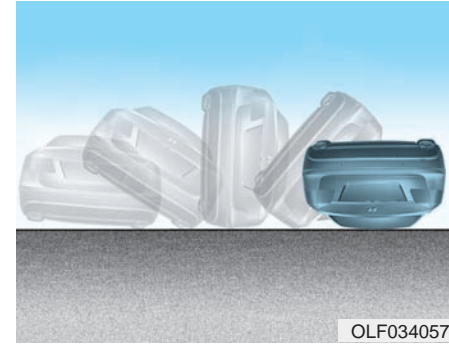

Front air bags may not inflate in rollover accidents because air bag deployment could not provide protection to the occupants.

However, side and curtain air bags may inflate when the vehicle is rolled over by a side impact collision.

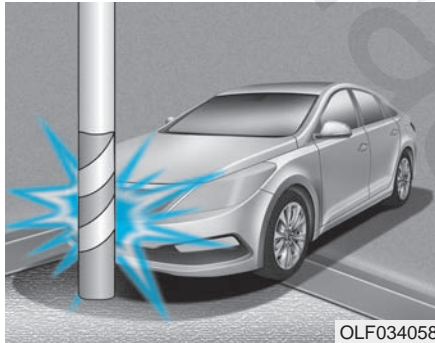

OLF034058

Air bags may not inflate if the vehicle collides with objects such as utility poles or trees, where the point of impact is concentrated and the collision energy is absorbed by the vehicle structure.

SRS Care

The SRS is virtually maintenance-free and there are no parts you can safely service by yourself. If the SRS air bag warning light does not illuminate when the Engine Start/Stop button is in the ON position, or continuously remains on, have your vehicle immediately inspected by an authorized HYUNDAI dealer.

Any work on the SRS system, such as removing, installing, repairing, or any work on the steering wheel, the front passenger's panel, front seats and roof rails must be performed by an authorized HYUNDAI dealer. Improper handling of the SRS system may result in serious personal injury.

WARNING

To reduce the risk of serious injury or death, take the following precautions:

- Do not attempt to modify or disconnect the SRS components or wiring, including the addition of any kind of badges to the pad covers or modifications to the body structure.
- Do not place objects over or near the air bag modules on the steering wheel, instrument panel, or the front passenger's panel above the glove box.
- Clean the air bag pad covers with a soft cloth moistened with plain water. Solvents or cleaners could adversely affect the air bag covers and proper deployment of the system.
- Always have inflated air bags replaced by an authorized HYUNDAI dealer.

(Continued)

(Continued)

- If components of the air bag system must be discarded, or if the vehicle must be scrapped, certain safety precautions must be observed. Consult an authorized HYUNDAI dealer for the necessary information. Failure to follow these precautions could increase the risk of personal injury.

Additional Safety Precautions

Passengers should not move out of or change seats while the vehicle is moving. A passenger who is not wearing a seat belt during a crash or emergency stop can be thrown against the inside of the vehicle, against other occupants, or be ejected from the vehicle.

Do not use any accessories on seat belts. Devices claiming to improve occupant comfort or reposition the seat belt can reduce the protection provided by the seat belt and increase the chance of serious injury in a crash

Do not modify the front seats.

Modification of the front seats could interfere with the operation of the supplemental restraint system sensing components or side air bags.

Do not place items under the front seats. Placing items under the front seats could interfere with the operation of the supplemental restraint system sensing components and wiring harnesses.

Do not cause impact to the doors. Impact to the doors when the Engine Start/Stop button is in the ON position may cause the air bags to inflate.

Modifications to accommodate disabilities. If you require modification to your vehicle to accommodate a disability, contact the HYUNDAI Customer Connect Center at 1-877-378-8727.

Adding equipment to or modifying your air bag equipped vehicle

If you modify your vehicle by changing your vehicle's frame, bumper system, front end or side sheet metal or ride height, this may affect the operation of your vehicle's air bag system.

Air Bag Warning Labels

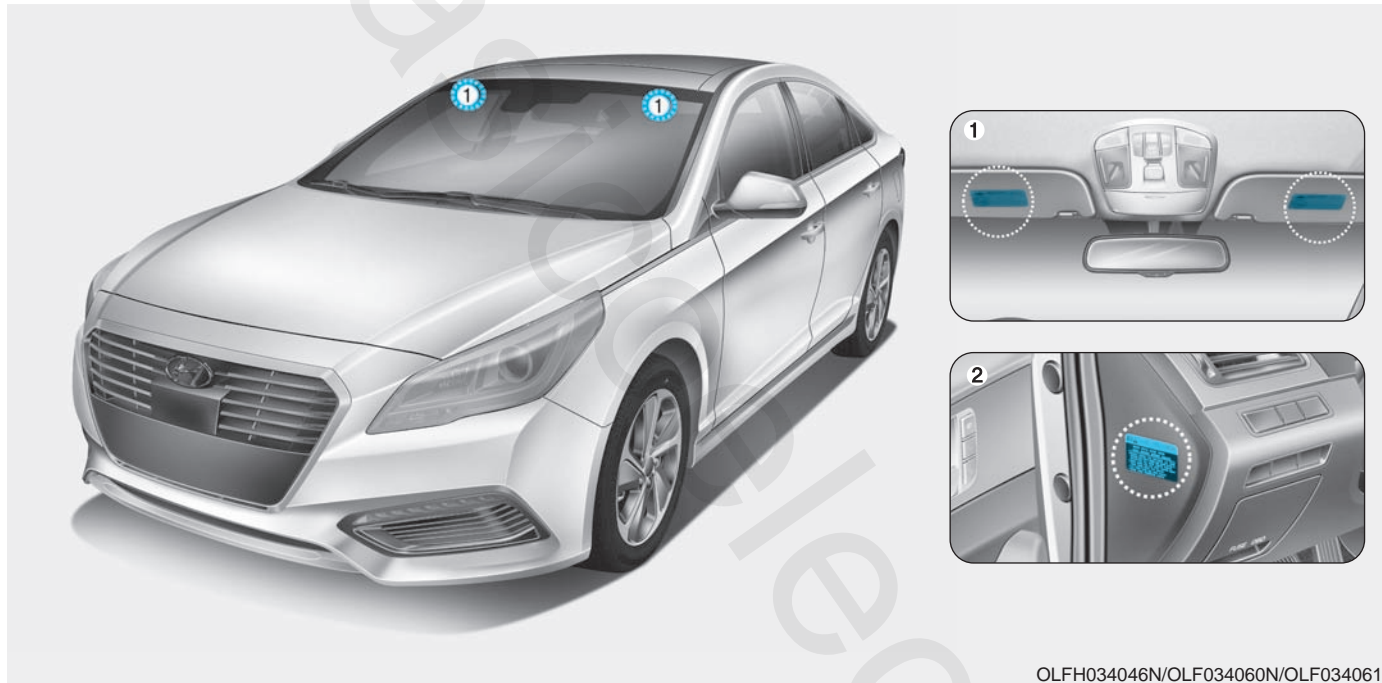

OLF034046N/OLF034060N/OLF034061

Air bag warning labels, required by the U.S. National Highway Traffic Safety Administration (NHTSA), are attached to alert the driver and passengers of potential risks of the air bag system. Be sure to read all of the information about the air bags that are installed on your vehicle in this Owners Manual.

Convenient features of your vehicle

Accessing your vehicle	3-3	Panoramic sunroof	3-42
Smart Key.....	3-3	Sunshade.....	3-42
Immobilizer System.....	3-7	Sliding the Sunroof.....	3-43
Door locks	3-9	Tilting the Sunroof	3-43
Operating Door Locks from Outside the Vehicle.....	3-9	Closing the Sunroof.....	3-44
Operating Door Locks from Inside the Vehicle.....	3-10	To Reset the Sunroof.....	3-45
Auto Door Lock/Unlock Features.....	3-12	Exterior features	3-46
Child-Protector Rear Door locks	3-12	Hood	3-46
Theft-alarm system	3-13	Trunk	3-47
Driver position memory system	3-14	Smart Trunk.....	3-50
Storing Positions into Memory	3-14	Fuel Filler Door.....	3-53
Easy Access Function	3-15	Instrument cluster	3-57
Steering wheel	3-16	Instrument cluster control	3-58
Electric Power Steering (EPS)	3-16	Gauges	3-59
Tilt Steering / Telescope Steering.....	3-17	Engine coolant temperature gauge.....	3-61
Heated Steering Wheel.....	3-17	Warning and indicator lights.....	3-63
Horn.....	3-18	Warning messages	3-76
Mirrors	3-19	LCD Display.....	3-88
Inside Rearview Mirror	3-19	Trip computer.....	3-98
Outside Rearview Mirror	3-34	Light	3-107
Reverse Parking Aid Function.....	3-37	Exterior Lights.....	3-107
Windows	3-38	Smart High Beam	3-109
Power Windows	3-39	Welcome System	3-115
		Interior Lights	3-116

Wipers and washers	3-120	Interior features	3-147
Windshield Wipers	3-120	Cup Holder	3-147
Windshield Washers	3-121	Sunvisor.....	3-148
Driver Assist System	3-122	Power Outlet	3-148
Rear view camera.....	3-122	Clock.....	3-150
Rear parking assist system	3-123	Clothes Hanger	3-151
Defroster	3-126	Floor Mat Anchor(s).....	3-152
Rear Window Defroster	3-126	Side Curtain	3-153
Automatic climate control system	3-127	Luggage Net Holder	3-153
Automatic heating and air conditioning.....	3-128		
Manual heating and air conditioning.....	3-129		
System operation.....	3-137		
System maintenance.....	3-139		
Windshield defrosting and defogging	3-141		
Automatic Climate Control System	3-142		
Defogging logic.....	3-143		
Climate control additional features	3-144		
Automatic Ventilation.....	3-144		
To cancel or reset the Automatic Ventilation.....	3-144		
Sunroof Inside Air Recirculation.....	3-144		
Storage compartment	3-145		
Center Console Storage	3-145		
Glove Box.....	3-145		
Sunglass Holder.....	3-146		
Multi box	3-146		

ACCESSING YOUR VEHICLE

Smart Key



Your HYUNDAI uses a Smart Key, which you can use to lock or unlock a door (and trunk) and even start the engine.

1. Door Lock
2. Door Unlock
3. Trunk Unlock
4. Panic

Locking

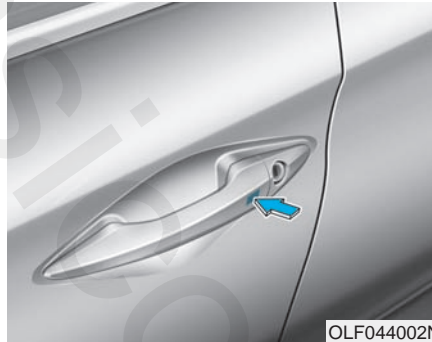

To lock :

1. Close all doors, engine hood and trunk.
2. Either press the door handle button or press the Door Lock button (1) on the smart key.
3. The hazard warning lights will blink and the chime will sound once.
4. Make sure the doors are locked by checking the position of the door lock button inside the vehicle.

Information

The door handle button will only operate when the smart key is within 28~40 inches (0.7~1 m) from the outside door handle.

Even though you press the outside door handle button, the doors will not lock and the chime will sound for three seconds if any of the following occur:

- The Smart Key is in the vehicle.
- The Engine Start/Stop button is in ACC or ON position.
- Any door except the trunk is open.

WARNING

Do not leave the Smart Key in your vehicle with unsupervised children. Unattended children could press the Engine Start/Stop button and may operate power windows or other controls, or even make the vehicle move, which could result in serious injury or death.

Unlocking

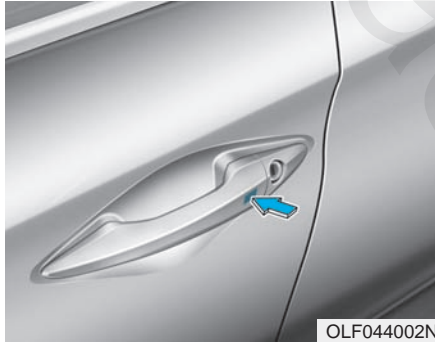

To unlock:

1. Carry the Smart Key.
2. Either press the driver's outside door handle button or press the Door Unlock button (2) on the smart key.
3. The driver's door will unlock. The hazard warning lights will blink two times.

If you press the driver's outside door handle button or Door Unlock button on the smart key again within four seconds, then all the doors will unlock.

i Information

- The door handle button will only operate when the smart key is within 28~40 inches (0.7~1 m) from the outside door handle and other people can also open the doors.
- If you press the front passenger's outside door handle, while carrying the Smart Key, all doors will unlock.
- After unlocking the doors, the doors will lock automatically after 30 seconds unless a door is opened.

Trunk opening

To open:

1. Carry the smart key.
2. Either press the trunk handle button or press and hold the Trunk Unlock button (3) on the smart key for more than one second.
3. The hazard warning lights will blink two times.

Once the trunk is opened and then closed, the trunk will lock automatically.

i Information

The trunk handle button will only operate when the smart key is within 28 inches (0.7 m) from the trunk handle.

Panic button

Press the Panic button (4) and hold for more than one second. The horn sounds and hazard warning lights blink for about 30 seconds. To cancel the panic mode, press any button on the Smart Key.

Start-up

You can start the engine without inserting the key.

For more information, refer to the “Engine Start/Stop Button” section in chapter 5.

NOTICE

To prevent damaging the smart key:

- **Keep the smart key away from water or any liquid. If the smart key is inoperative due to exposure to water or other liquids, it will not be covered by your manufacturer’s vehicle warranty.**
- **Avoid dropping or throwing the smart key.**
- **Protect the smart key from extreme temperatures.**

Mechanical key

If the Smart Key does not operate normally, you can lock or unlock the door by using the mechanical key.



OLF044007

Press and hold the release button (1) and remove the mechanical key (2). Insert the mechanical key into the key hole on the door.

To reinstall the mechanical key, put the key into the hole and push it until a click sound is heard.

Loss of a smart key

A maximum of two Smart Keys can be registered to a single vehicle. If you happen to lose your smart key, you should immediately take the vehicle and remaining keys to your authorized HYUNDAI dealer or tow the vehicle, if necessary.

Smart key precautions

The smart key will not work if any of the following occur:

- The smart key is close to a radio transmitter such as a radio station or an airport which can interfere with normal operation of the transmitter.
- The smart key is near a mobile two way radio system or a cellular phone.
- Another vehicle's smart key is being operated close to your vehicle.

When the smart key does not work correctly, open and close the door with the mechanical key. If you have a problem with the smart key, contact an authorized HYUNDAI dealer.

If the smart key is in close proximity to your mobile phone, the signal could be blocked by your mobile phones normal operational signals. This is especially important when the phone is active such as making and receiving calls, text messaging, and/or sending/receiving emails. Avoid placing the smart key and your mobile phone in the same pants or jacket pocket and always try to maintain an adequate distance between the two devices.

CAUTION

Keep the smart key away from electromagnetic materials that blocks electromagnetic waves to the key surface.

Information

This device complies with Part 15 of the FCC rules.

Operation is subject to the following three conditions:

- 1. This device may not cause harmful interference, and**
- 2. This device must accept any interference received, including interference that may cause undesired operation.**
- 3. Changes or modifications not expressly approved by the party responsible for compliance could void the user's authority to operate the device.**

Battery replacement

If the Smart Key is not working properly, try replacing the battery with a new one.



Battery Type: CR2032

To replace the battery:

1. Pry open the rear cover of the smart key.
2. Remove the old battery and insert the new battery.
3. Reinstall the rear cover of the smart key.

If you suspect your smart key might have sustained some damage, or you feel your smart key is not working correctly, contact an authorized HYUNDAI dealer.

i Information



An inappropriately disposed battery can be harmful to the environment and human health. Dispose the battery according to your local law(s) and regulation(s).

Immobilizer System

The immobilizer system protects your vehicle from theft. If an improperly coded key (or other device) is used, the engine's fuel system is disabled.

When the engine Start/Stop button is in the ON position, the immobilizer system indicator should come on briefly, then go off. If the indicator starts to blink, the system does not recognize the coding of the key.

Place engine Start/Stop button to the OFF position, then place the engine Start/Stop button to the ON position again.

The system may not recognize your key's coding if another immobilizer key or other metal object (i.e., key chain) is near the key. The engine may not start because the metal may interrupt the transponder signal from transmitting normally.

If the system repeatedly does not recognize the coding of the key, it is recommended that you contact your HYUNDAI dealer.

Do not attempt to alter this system or add other devices to it. Electrical problems could result that may make your vehicle inoperable.

WARNING

In order to prevent theft of your vehicle, do not leave spare keys anywhere in your vehicle. Your immobilizer password is a customer unique password and should be kept confidential.

NOTICE

The transponder in your key is an important part of the immobilizer system. It is designed to give years of trouble-free service, however you should avoid exposure to moisture, static electricity and rough handling. Immobilizer system malfunction could occur.

Information

This device complies with Part 15 of the FCC rules.

Operation is subject to the following three conditions:

- 1. This device may not cause harmful interference, and**
- 2. This device must accept any interference received, including interference that may cause undesired operation.**
- 3. Changes or modifications not expressly approved by the party responsible for compliance could void the user's authority to operate the device.**

DOOR LOCKS

Operating Door Locks from Outside the Vehicle

Mechanical key



If you lock the driver's door with a mechanical key, all vehicle doors will lock. If you unlock the driver's door with a mechanical key, the driver's door will unlock.

Once the doors are unlocked, they may be opened by pulling the door handle.

When closing the door, push the door by hand. Make sure that doors are closed securely.

Smart key

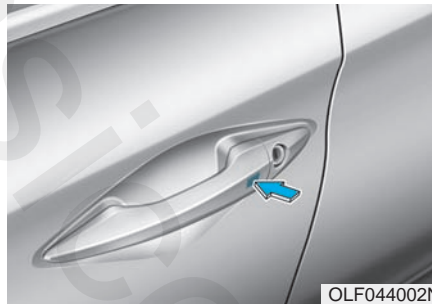

To lock the doors, press the button on the outside door handle while carrying the Smart Key with you or press the Door Lock button on the Smart Key.

Press the button on the driver's outside door handle while carrying the Smart Key with you or press the Door Unlock button on the Smart Key, the driver's door will unlock. If you press the button on the front passenger's outside door, all doors will unlock.

Once the doors are unlocked, they may be opened by pulling the door handle.

When closing the door, push the door by hand. Make sure that doors are closed securely.

i Information

- In cold and wet climates, door lock and door mechanisms may not work properly due to freezing conditions.
- If the door is locked/unlocked multiple times in rapid succession with either the vehicle key or door lock switch, the system may stop operating temporarily in order to protect the circuit and prevent damage to system components.

Operating Door Locks from Inside the Vehicle

With the door lock button

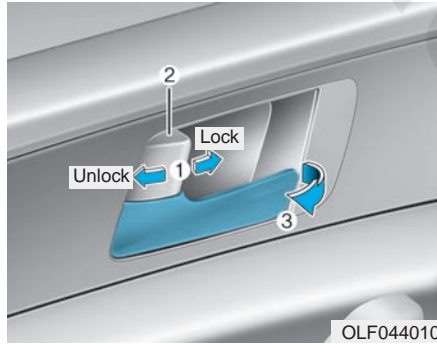

- To unlock a door, push the door lock button (1) to the “Unlock” position. The red mark (2) on the door lock button will be visible.
- To lock a door, push the door lock button (1) to the “Lock” position. If the door is locked properly, the red mark (2) on the door lock button will not be visible.
- To open a door, pull the door handle (3) outward.

- If the inner door handle of the driver’s (or front passenger’s) door is pulled when the door lock button is in the lock position, the button is unlocked and door opens.
- Doors cannot be locked if the smart key is in the vehicle and any door is open.

i Information

If a power door lock ever fails to function while you are in the vehicle try one or more of the following techniques to exit:

- **Operate the door unlock feature repeatedly (both electronic and manual) while simultaneously pulling on the door handle.**
- **Operate the other door locks and handles, front and rear.**
- **Lower a front window and use the mechanical key to unlock the door from outside.**

With the central door lock switch

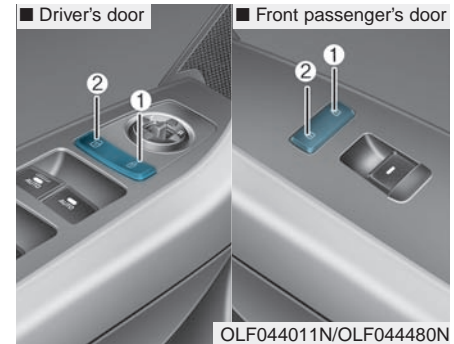

When pressing the (⏏) switch (1), all vehicle doors will lock.

When pressing the (⏏) switch (2), all vehicle doors will unlock.

If the smart key is in the vehicle and any door is opened, the doors will not lock even though the lock button (1) of the central door lock switch is pressed.

⚠ WARNING

The doors should always be fully closed and locked while the vehicle is in motion. If the doors are unlocked, the risk of being thrown from the vehicle in a crash is increased.

⚠ WARNING

Do not leave children or animals unattended in your vehicle. An enclosed vehicle can become extremely hot, causing death or serious injury to unattended children or animals who cannot escape the vehicle. Children might operate features of the vehicle that could injure them, or they could encounter other harm, possibly from someone gaining entry to the vehicle.

⚠ WARNING

Always secure your vehicle.
Leaving your vehicle unlocked increases the potential risk to you or others from someone hiding in your vehicle.
To secure your vehicle, while depressing the brake, move the shift lever to the P (Park) position, engage the parking brake, and place engine Start/Stop button to the OFF position, close all windows, lock all doors, and always take the key with you.

⚠ CAUTION

Opening a door when something is approaching may cause damage or injury. Be careful when opening doors and watch for vehicles, motorcycles, bicycles or pedestrians approaching the vehicle in the path of the door.

Auto Door Lock/Unlock Features

Impact sensing door unlock system

All doors will be automatically unlocked when an impact causes the air bags to deploy.

Shift lever auto door lock

All doors will be automatically locked when shifting the shift lever out of P (Park) with the engine running.

You can activate or deactivate the Auto Door Lock/Unlock features from the User Settings Mode on the LCD display.

For more information, refer to the "LCD Display" section in this chapter.

Child-Protector Rear Door locks

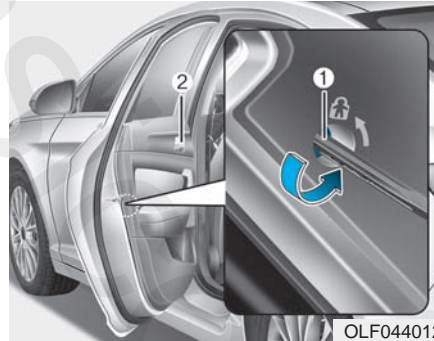

The child safety lock is provided to help prevent children seated in the rear from accidentally opening the rear doors. The rear door safety locks should be used whenever children are in the vehicle.

The child safety lock is located on the edge of each rear door. When the child safety lock is in the lock (1) position, the rear door will not open if the inner door handle (2) is pulled.

To lock the child safety lock, insert a screwdriver into the hole and turn it to the lock position.

To allow a rear door to be opened from inside the vehicle, unlock the child safety lock.

⚠ WARNING

If children accidentally open the rear doors while the vehicle is in motion, they could fall out of the vehicle. The rear door safety locks should always be used whenever children are in the vehicle.

THEFT-ALARM SYSTEM

This system helps to protect your vehicle and valuables. The horn will sound and the hazard warning lights will blink continuously if any of the following occurs:

- A door is opened without using the smart key.
- The trunk is opened without using the smart key.
- The hood is opened.

The alarm continues for 30 seconds, then the system resets. To turn off the alarm, unlock the doors with smart key.

The Theft Alarm System automatically sets 30 seconds after you lock the doors and the trunk. For the system to activate, you must lock the doors and the trunk from outside the vehicle with the smart key or by pressing the button on the outside of the door handles with the smart key in your possession.

The hazard warning lights will blink and the chime will sound once to indicate the system is armed.

Once the security system is set, opening any door, the trunk, or the hood without using the smart key will cause the alarm to activate.

The Theft Alarm System will not set if the hood, the trunk, or any door is not fully closed. If the system will not set, check the hood, the trunk, or the doors are fully closed.

Do not attempt to alter this system or add other devices to it.

Information

- **Do not lock the doors until all passengers have left the vehicle. If the remaining passenger leaves the vehicle when the system is armed, the alarm will be activated.**
- **If the vehicle is not disarmed with the smart key, open the doors by using the mechanical key and start hybrid system by directly pressing the switch with the smart key.**
- **When the system is disarmed but a door or trunk is not opened within 30 seconds, the system will be rearmed.**

DRIVER POSITION MEMORY SYSTEM (IF EQUIPPED)

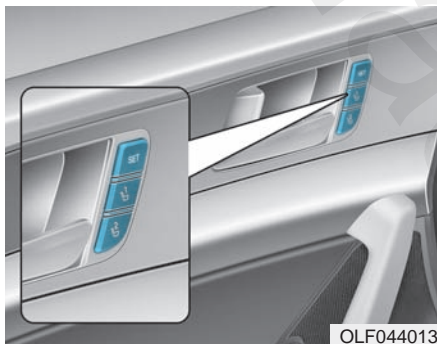

The Driver Position Memory System is provided to store and recall the following memory settings with a simple button operation.

- Driver's seat position
- Outside rearview mirror position
- Instrument panel illumination intensity

If the battery is disconnected, the position memory will be lost and the driving positions must be stored in the system again.

If the Driver Position Memory System does not operate normally, have the system checked by an authorized HYUNDAI dealer.

! WARNING

Never attempt to operate the driver position memory system while the vehicle is moving.

This could result in loss of control, and an accident causing death, serious injury, or property damage.

Storing Positions into Memory

1. Check that the shift lever is in P (Park) while the engine Start/Stop button is in the ON position.
2. Adjust the driver's seat position, outside rearview mirror position and instrument panel illumination intensity to positions comfortable for the driver.
3. Press the SET button. The system will beep once and notify you "Press button to save settings" on the LCD display.
4. Press one of the memory buttons (1 or 2) within 5 seconds. The system will beep twice when the memory has been successfully stored.
- 5.



"Driver 1 (or 2) settings saved" will appear on the LCD display.

Recalling positions from memory

1. Check that the shift lever is in P (Park) while the engine Start/Stop button is in the ON position.
2. Press the desired memory button (1 or 2). The system will beep once, and then the driver's seat position, outside rearview mirror position and instrument panel illumination intensity will automatically adjust to the stored positions.
- 3.



"Driver 1(or 2) settings is applied" will appear on the LCD display.

NOTICE

- While recalling the "1" memory position, pressing the SET or 1 button temporarily stops the adjustment of the recalled memory position. Pressing the 2 button recalls the "2" memory position.
- While recalling the "2" memory position, pressing the SET or 2 button temporarily stops the adjustment of the recalled memory position. Pressing the 1 button recalls the "1" memory position.
- While recalling the stored positions, pressing one of the control buttons for the driver's seat, outside rearview mirror or instrument panel illumination will cause the movement of that component to stop and move in the direction that the control button is pressed.

Easy Access Function

When exiting the vehicle the driver's seat will move rearward when the engine is turned off and the shift lever in P (Park).

When entering the vehicle the driver's seat will move forward when engine Start/Stop button is in the ACC position.

You can activate or deactivate the Easy Access Function from the User Settings Mode on the LCD display.

For more information, refer to the "LCD Display" section in this chapter.

STEERING WHEEL

Electric Power Steering (EPS)

The system assists you with steering the vehicle. If the engine is turned off or if the power steering system becomes inoperative, you may still steer the vehicle, but it will require increased steering effort.

Should you notice any change in the effort required to steer during normal vehicle operation, have the system checked by an authorized HYUNDAI dealer.

CAUTION

If the Electric Power Steering System does not operate normally, the warning light (⊗!) will illuminate on the instrument cluster. You may steer the vehicle, but it will require increased steering efforts. Take your vehicle to an authorized HYUNDAI dealer and have the system checked as soon as possible.

Information

The following symptoms may occur during normal vehicle operation:

- The steering effort may be high immediately after placing the engine Start/Stop button in the ON position.

This happens as the system performs the EPS system diagnostics. When the diagnostics is completed, the steering wheel will return to its normal condition.

- A click noise may be heard from the EPS relay after the engine Start/Stop button is in the ON/OFF position.
- Motor noise may be heard when the vehicle is at a stop or at a low driving speed.
- When you operate the steering wheel in low temperature, abnormal noise may occur. If temperature rises, the noise will disappear. This is a normal condition.

Tilt Steering / Telescope Steering

Adjust the steering wheel so it points toward your chest, not toward your face. Make sure you can see the instrument panel warning lights and gauges. After adjusting, push the steering wheel both up and down to be certain it is locked in position. Always adjust the position of the steering wheel before driving.

WARNING

NEVER adjust the steering wheel while driving. This may cause loss of vehicle control resulting in an accident.



OLF044015

To change the steering wheel angle and height:

1. Pull down the lock-release lever (1).
2. Adjust the steering wheel to the desired angle (2) and height (3).
3. Pull up the lock-release lever to lock the steering wheel in place.

Information

After adjustment, sometimes the lock release lever may not lock the steering wheel. It is not a malfunction. This occurs when two gears are not engaged correctly. In this case, adjust the steering wheel again and then lock the steering wheel.

Heated Steering Wheel (if equipped)



OLF044017

When the engine Start/Stop button is in the ON/OFF position or when the engine is running, press the heated steering wheel button to warm the steering wheel. The indicator on the button will illuminate.

To turn the heated steering wheel off, press the button again. The indicator on the button will turn off.

The heated steering wheel will automatically turn off after approximately 30 minutes.

NOTICE

Do not install any cover or accessory on the steering wheel. The cover or accessory could cause damage to the heated steering wheel system.

Horn



OLF044018

To sound the horn, press the area indicated by the horn symbol on your steering wheel (see illustration). The horn will operate only when this area is pressed.

NOTICE

Do not strike the horn severely to operate it, or hit it with your fist. Do not press on the horn with a sharp-pointed object.

MIRRORS

Inside Rearview Mirror

Before you start driving, adjust the rearview mirror to the center on the view through the rear window.

⚠ WARNING

Make sure your line of sight is not obstructed. Do not place objects in the rear seat, cargo area, or behind the rear headrests which could interfere with your vision through the rear window.

⚠ WARNING

To prevent serious injury during an accident or deployment of the air bag, do not modify the rearview mirror and do not install a wide mirror.

⚠ WARNING

NEVER adjust the mirror while driving. This may cause loss of vehicle control resulting in an accident.

NOTICE

When cleaning the mirror, use a paper towel or similar material dampened with glass cleaner. Do not spray glass cleaner directly on the mirror as that may cause the liquid cleaner to enter the mirror housing.

Day/night rearview mirror (if equipped)

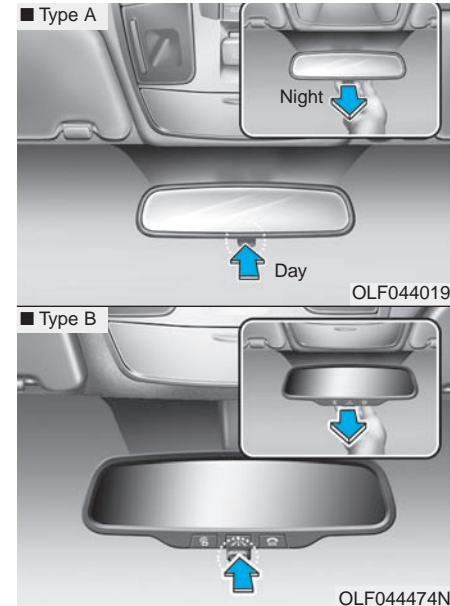

Make this adjustment before you start driving and while the day/night lever is in the day position.

Pull the day/night lever toward you to reduce glare from the headlamps of the vehicles behind you during night driving.

Remember that you lose some rearview clarity in the night position.

Blue Link® center (if equipped)



OLF044021

For details, refer to the Blue Link® Owner's Guide, Navigation Manual or Audio Manual.

Electric chromic mirror (ECM) with HomeLink® system, compass and Blue Link® (for U.S.A)

Your vehicle may be equipped with a Gentex Automatic-Dimming Mirror with a Z-Nav™ Electronic Compass Display and an Integrated HomeLink® Wireless Control System. During nighttime driving, this feature will automatically detect and reduce rearview mirror glare while the compass indicates the direction the vehicle is pointed. The HomeLink® Universal Transceiver allows you to activate your garage door(s), electric gate, home lighting, etc.

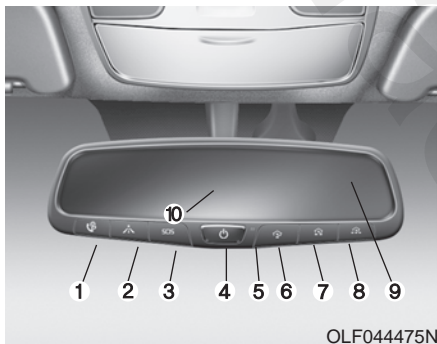

OLF044475N

- (1) Telematics button
- (2) Telematics button
- (3) Telematics button
- (4) Compass control button & Dimming ON/OFF button
- (5) Status indicator LED
- (6) Channel 1 button
- (7) Channel 2 button
- (8) Channel 3 button
- (9) Compass display
- (10) Rear light sensor

Automatic-Dimming Night Vision Safety™ (NVS®) Mirror (if equipped)

The NVS® Mirror automatically reduces glare by monitoring light levels in the front and the rear of the vehicle. Any object that obstructs either light sensor will degrade the automatic dimming control feature.

For more information regarding NVS® mirrors and other applications, please refer to the Gentex website:
www.gentex.com

Your mirror will automatically dim upon detecting glare from the vehicles traveling behind you. The auto-dimming function can be controlled by pressing the Dimming ON/OFF button:

1. Pressing and holding the ☰ button for 3 seconds turns the auto-dimming function OFF which is indicated by the green Status Indicator LED turning off.
2. Pressing and holding the ☰ button for 3 seconds again turns the auto-dimming function ON which is indicated by the green Status Indicator LED turning on.

The mirror defaults to the ON position each time the vehicle is started.



Z-Nav™ Compass Display

The NVS™ Mirror in your vehicle is also equipped with a Z-Nav™ Compass that shows the vehicle Compass heading in the Display Window using the 8 basic cardinal headings (N, NE, E, SE, etc.).

Convenient features of your vehicle

Compass function

The Compass can be turned ON and OFF and will remember the last state when hybrid system is cycled. To turn the display feature ON/OFF:



1. Press and release the  button within 1 second to turn the display feature OFF.
2. Press and release the  button again within 1 second to turn the display back ON.

Additional options can be set with press and hold sequences of the  button and are detailed below.

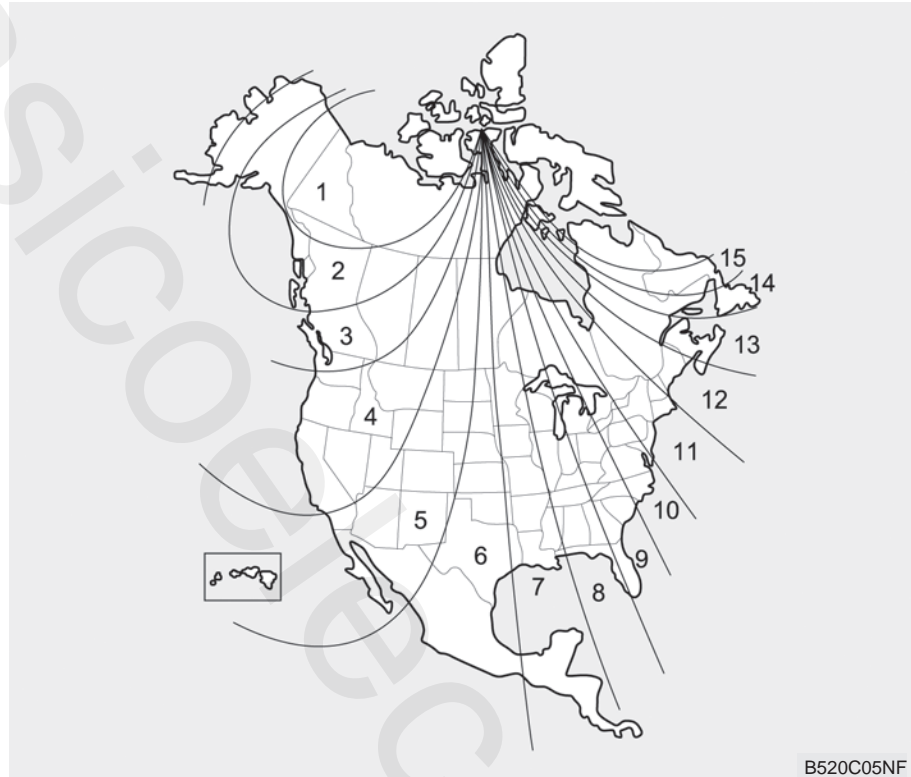
There is a difference between magnetic north and true north. To compensate for this difference you will need to adjust the Zone setting based on where you live.



To adjust the Zone setting:

1. Determine the desired Zone Number based upon your current location on the Zone Map.
2. Press and hold the  button for 6 seconds, the current Zone Number will appear on the display.
3. Pressing and holding the  button again will cause the numbers to increment (Note: they will repeat ...13, 14, 15, 1, 2, ...). Releasing the button when the desired Zone Number appears on the display will set the new Zone.
4. Within about 5 seconds the compass will start displaying a compass heading again.

There are some conditions that can cause changes to the vehicle magnets, such as installing a ski rack or a CB antenna. Body repair work on the vehicle can also cause changes to the vehicle's magnetic field. In these situations, the compass will need to be re-calibrated to quickly correct these changes.

If you need to recalibrate the compass:

1. Press and hold the  button for more than 9 seconds. When the compass memory is cleared a "C" will appear in the display.
2. Drive the vehicle in 2 complete circles at less than 5 mph (8 km/h).

Integrated HomeLink® Wireless Control System

The HomeLink® Wireless Control System can replace up to three hand-held radio-frequency (RF) transmitters with a single built-in device. This innovative feature will learn the radio frequency codes of most current transmitters to operate devices such as gate operators, garage door openers, entry door locks, security systems, even home lighting. Both standard and rolling code-equipped transmitters can be programmed by following the outlined procedures.

Additional HomeLink® information can be found at: www.homelink.com or by calling 1-800-355-3515.

Retain the original transmitter of the RF device you are programming for use in other vehicles as well as for future HomeLink® programming. It is also suggested that upon the sale of the vehicle, the programmed HomeLink® buttons be erased for security purposes.

WARNING

Before programming HomeLink® to a garage door opener or gate operator, make sure people and objects are out of the way of the device to prevent potential harm or damage. Do not use the HomeLink® with any garage door opener that lacks the safety stop and reverse features required by U.S. federal safety standards (this includes any garage door opener model manufactured before April 1, 1982). A garage door that cannot detect an object - signaling the door to stop and reverse - does not meet current U.S. federal safety standards. Using a garage door opener without these features increases the risk of serious injury or death.

Programming HomeLink®



Please note the following:

- When programming a garage door opener, it is advised to park the vehicle outside of the garage.
- It is recommended that a new battery be placed in the hand-held transmitter of the device being programmed to HomeLink® for quicker training and accurate transmission of the radio-frequency signal.
- Some vehicles may require the engine Start/Stop button to be placed in the ACC position for programming and/or operation of HomeLink®.
- In the event that there are still programming difficulties or questions after following the programming steps listed below, contact HomeLink® at: www.homelink.com or by calling 1-800-355-3515.

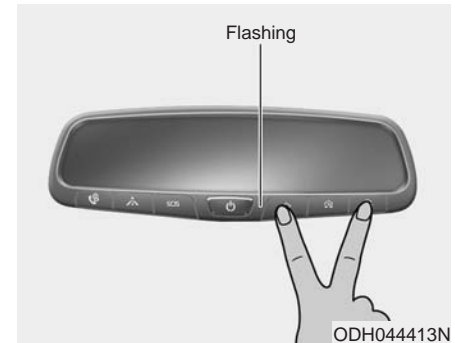
Programming



To train most devices, follow these instructions:

1. For first-time programming, press and hold the two outside buttons (, ) until the indicator light begins to flash (after 10 seconds). Release both buttons. Do not hold the buttons for longer than 20 seconds.

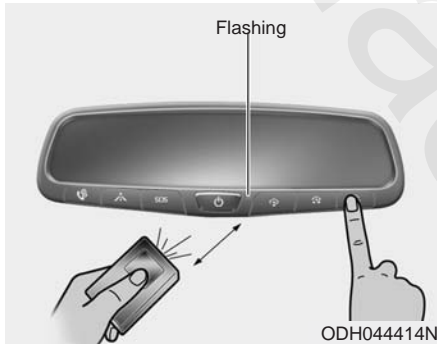

i Information

Some devices may require you to replace this Programming step 3 with procedures noted in the "Gate Operator/Canadian Programming" chapter. If the HomeLink® indicator light does not change to a rapidly blinking light after performing these steps, contact HomeLink® at www.homelink.com.

2. Position the end of your hand-held transmitter 1-3 inches (2-8 cm) away from the HomeLink® button you wish to program while keeping the indicator light in view.
3. Simultaneously press and hold both the HomeLink® and hand-held transmitter buttons until the HomeLink® indicator light changes from a slow to a rapid blinking light. Now you may release both the HomeLink® and hand-held transmitter buttons.

4. Firmly press, hold for 5 seconds and release the programmed HomeLink® button up to two separate times to activate the door. If the door does not activate, press and hold the just-trained HomeLink® button and observe the indicator light.
 - If the indicator light stays on constantly, programming is complete and your device should activate when the HomeLink® button is pressed and released.
 - If the indicator light blinks rapidly for 2 seconds and then turns to a constant light, continue with "Programming" steps 5-7 to complete the programming of a rolling code equipped device (most commonly a garage door opener).
5. At the garage door opener receiver (motor-head unit) in the garage, locate the "learn" or "smart" button. This can usually be found where the hanging antenna wire is attached to the motor-head unit.

6. Firmly press and release the "learn" or "smart" button. (The name and color of the button vary by manufacturer). There are 30 seconds to initiate step 7.
7. Return to the vehicle and firmly press, hold for 2 seconds and release the programmed HomeLink® button. Repeat the "press/hold/release" sequence a second time, and, depending on the brand of the garage door opener (or other rolling code equipped device), repeat this sequence a third time to complete the programming process.

HomeLink® should now activate your rolling code equipped device.

Gate operator & Canadian programming

During programming, your handheld transmitter may automatically stop transmitting. Continue to press the Integrated HomeLink® Wireless Control System button (note steps 2 through 3 in the Programming portion of this document) while you press and re-press ("cycle") your handheld transmitter every two seconds until the frequency signal has been learned. The indicator light will flash slowly and then rapidly after several seconds upon successful training.

Operating HomeLink®

To operate, simply press and release the programmed HomeLink® button. Activation will now occur for the trained device (i.e. garage door opener, gate operator, security system, entry door lock, home/office lighting, etc.). For convenience, the hand-held transmitter of the device may also be used at any time.

Reprogramming a single HomeLink® button

To program a device to HomeLink® using a HomeLink® button previously trained, follow these steps:

1. Press and hold the desired HomeLink® button. DO NOT release the button.
2. The indicator light will begin to flash after 20 seconds. Without releasing the HomeLink® button, proceed with "Programming" step 2.

For questions or comments, contact HomeLink® at www.homelink.com or 1-800-355-3515.

Erasing HomeLink® buttons

Individual buttons cannot be erased. However, to erase all three programmed buttons:

1. Press and hold the two outer HomeLink® buttons until the indicator light begins to flash after 10 seconds.
2. Release both buttons. Do not hold for longer than 20 seconds.

The Integrated HomeLink® Wireless Control System is now in the training (learn) mode and can be programmed at any time following the appropriate steps in the Programming chapters above.

NVS® is a registered trademark and Z-Nav™ is a trademark of the Gentex Corporation, Zeeland, Michigan. HomeLink® is a registered trademark owned by Johnson Controls, Incorporated, Milwaukee, Wisconsin.

FCC ID: NZLTMHL4

IC: 4112A-TLMHL4

i Information

This device complies with Part 15 of the FCC Rules.

Operation is subject to the following three conditions:

- 1. This device may not cause harmful interference, and**
- 2. This device must accept any interference received, including interference that may cause undesired operation.**
- 3. The transceiver has been tested and complies with FCC and Industry Canada rules. Changes or modifications not expressly approved by the party responsible for compliance could void the user's authority to operate the device.**

Electric chromic mirror (ECM) with compass and HomeLink® system (for Canada)

Your vehicle may be equipped with a Gentex Automatic-Dimming Mirror with a Z-Nav™ Electronic Compass Display and an Integrated HomeLink® Wireless Control System.

During nighttime driving, this feature will automatically detect and reduce rearview mirror glare while the compass indicates the direction the vehicle is pointed. The HomeLink® Universal Transceiver allows you to activate your garage door(s), electric gate, home lighting, etc.

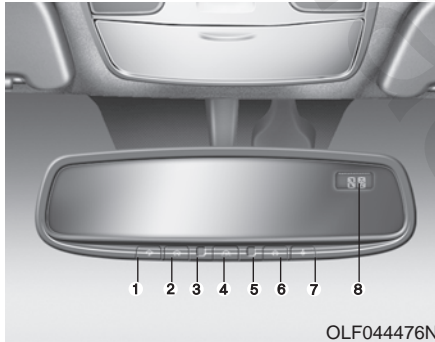

- (1) Channel 1 button
- (2) Channel 2 button
- (3) Status indicator LED
- (4) Channel 3 button
- (5) Rear light sensor
- (6) Dimming ON/OFF button
- (7) Compass control button
- (8) Compass display

Automatic-Dimming Night Vision Safety™ (NVS®) Mirror (if equipped)

The NVS® Mirror automatically reduces glare by monitoring light levels in the front and the rear of the vehicle. Any object that obstructs either light sensor will degrade the automatic dimming control feature.

For more information regarding NVS® mirrors and other applications, please refer to the Gentex website:
www.gentex.com

The auto-dimming function can be controlled by pressing the ON/OFF button:

1. Pressing the button turns the auto-dimming function OFF which is indicated by the green Status Indicator LED turning off.
2. Pressing the button again turns the auto-dimming function ON which is indicated by the green Status Indicator LED turning on.

The mirror defaults to the ON position each time the vehicle is started.

Z-Nav™ Compass Display

The NVS™ Mirror in your vehicle is also equipped with a Z-Nav™ Compass that shows the vehicle Compass heading in the Display Window using the 8 basic cardinal headings (N, NE, E, SE, etc.).

Compass function

The Compass can be turned ON and OFF and will remember the last state when hybrid system is cycled. To turn the display feature ON/OFF:



1. Press and release the \odot button to turn the display feature OFF.
2. Press and release the \odot button again to turn the display back ON.

Additional options can be set with press and hold sequences of the button and are detailed below.

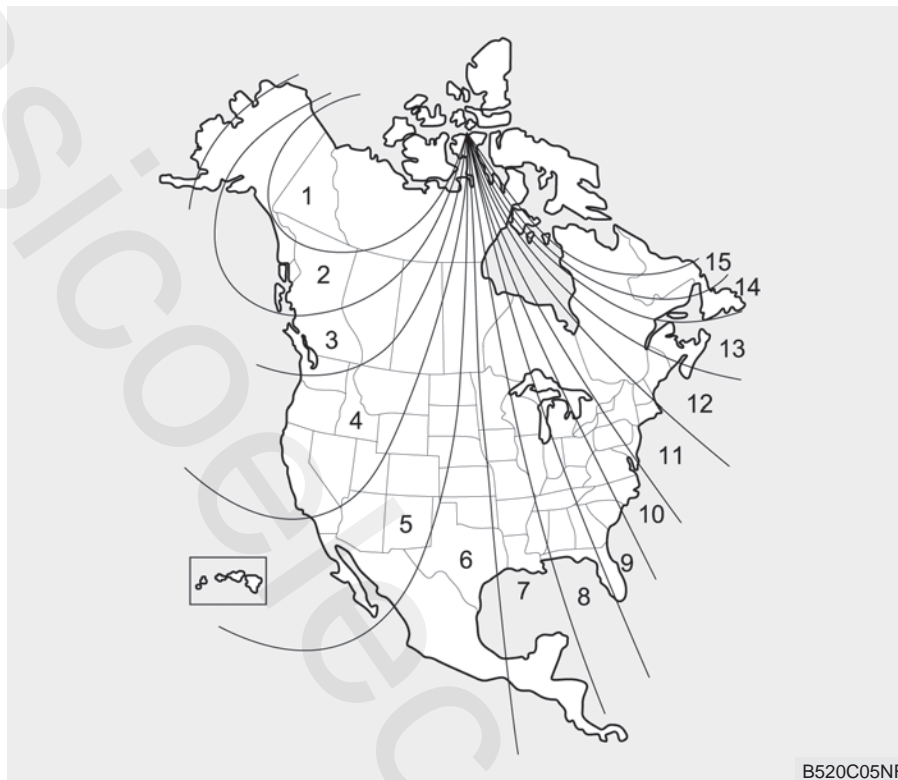
There is a difference between magnetic north and true north. To compensate for this difference you will need to adjust the Zone setting based on where you live.



To adjust the Zone setting:

1. Determine the desired Zone Number based upon your current location on the Zone Map.
2. Press and hold the  button for more than 3 but less than 6 seconds, the current Zone Number will appear on the display.
3. Pressing and holding the  button again will cause the numbers to increment (Note: they will repeat ...13, 14, 15, 1, 2, ...). Releasing the button when the desired Zone Number appears on the display will set the new Zone.
4. Within about 5 seconds the compass will start displaying a compass heading again.

There are some conditions that can cause changes to the vehicle magnets, such as installing a ski rack or a CB antenna. Body repair work on the vehicle can also cause changes to the vehicle's magnetic field. In these situations, the compass will need to be re-calibrated to quickly correct these changes.

If you need to recalibrate the compass:

1. Press and hold the  button for more than 6 seconds. When the compass memory is cleared a "C" will appear in the display.
2. Drive the vehicle in 2 complete circles at less than 5 mph (8 km/h).

Integrated HomeLink® Wireless Control System

The HomeLink® Wireless Control System can replace up to three hand-held radio-frequency (RF) transmitters with a single built-in device. This innovative feature will learn the radio frequency codes of most current transmitters to operate devices such as gate operators, garage door openers, entry door locks, security systems, even home lighting. Both standard and rolling code-equipped transmitters can be programmed by following the outlined procedures.

Additional HomeLink® information can be found at: www.homelink.com or by calling 1-800-355-3515.

Retain the original transmitter of the RF device you are programming for use in other vehicles as well as for future HomeLink® programming. It is also suggested that upon the sale of the vehicle, the programmed HomeLink® buttons be erased for security purposes.

WARNING

Before programming HomeLink® to a garage door opener or gate operator, make sure people and objects are out of the way of the device to prevent potential harm or damage. Do not use the HomeLink® with any garage door opener that lacks the safety stop and reverse features required by U.S. federal safety standards (this includes any garage door opener model manufactured before April 1, 1982). A garage door that cannot detect an object - signaling the door to stop and reverse - does not meet current U.S. federal safety standards. Using a garage door opener without these features increases the risk of serious injury or death.

Programming HomeLink®

Please note the following:

- When programming a garage door opener, it is advised to park the vehicle outside of the garage.
- It is recommended that a new battery be placed in the hand-held transmitter of the device being programmed to HomeLink® for quicker training and accurate transmission of the radio-frequency signal.
- Some vehicles may require the engine Start/Stop button to be placed in the ACC position for programming and/or operation of HomeLink®.
- In the event that there are still programming difficulties or questions after following the programming steps listed below, contact HomeLink® at: www.homelink.com or by calling 1-800-355-3515.

Rolling code programming

Rolling code devices which are "code-protected" and manufactured after 1996 may be determined by the following:

- Reference the device owner's manual for verification.
- The handheld transmitter appears to program the HomeLink® Universal Transceiver but does not activate the device.
- Press and hold the trained HomeLink button. The device has the rolling code feature if the indicator light flashes rapidly and then turns solid after 2 seconds.

To train rolling code devices, follow these instructions:

1. At the garage door opener receiver (motor-head unit) in the garage, locate the "learn" or "smart" button. This can usually be found where the hanging antenna wire is attached to the motor-head unit. Exact location and color of the button may vary by garage door opener brand. If there is difficulty locating the training button, reference the device owner's manual or please visit our Web site at www.homelink.com.
2. Firmly press and release the "learn" or "smart" button (which activates the "training light"). You will have 30 seconds to initiate step 3.
3. Return to the vehicle and firmly press, hold for two seconds and then release the desired HomeLink® button. Repeat the "press/hold/release" sequence a second time to complete the programming. (Some devices may require you to repeat this sequence a third time to complete the programming.)
4. Press and hold the just-trained HomeLink® button and observe the red Status Indicator LED. If the indicator light stays on constantly, programming is complete and your device should activate.
5. To program the remaining two HomeLink® buttons, follow either steps 1 through 4 above for other Rolling Code devices or steps 2 through 5 in Standard Programming for standard devices.

Standard programming

To train most devices, follow these instructions:

1. For first-time programming, press and hold the two outside buttons, HomeLink® Channel 1 and Channel 3 Buttons, until the indicator light begins to flash (after 20 seconds). Release both buttons. Do not hold the buttons for longer than 30 seconds.
2. Position the end of your hand-held transmitter 1-3 inches (2-8 cm) away from the HomeLink® buttons while keeping the indicator light in view.
3. Simultaneously press and hold both the HomeLink® and hand-held transmitter button. DO NOT release the buttons until step 4 has been completed.
4. While continuing to hold the buttons the red Indicator Status LED will flash slowly and then rapidly after HomeLink® successfully trains to the frequency signal from the hand-held transmitter. Release both buttons.

5. Press and hold the just-trained HomeLink® button and observe the red Status Indicator LED. If the indicator light stays on constantly, programming is complete and your device should activate when the HomeLink® button is pressed and released.
6. To program the remaining two HomeLink® buttons, follow steps 2 through 5.

Gate operator & Canadian programming

During programming, your handheld transmitter may automatically stop transmitting. Continue to press the Integrated HomeLink® Wireless Control System button (note steps 2 through 4 in the Standard Programming portion of this document) while you press and re-press ("cycle") your handheld transmitter every two seconds until the frequency signal has been learned. The indicator light will flash slowly and then rapidly after several seconds upon successful training.

Operating HomeLink®

To operate, simply press and release the programmed HomeLink® button. Activation will now occur for the trained device (i.e. garage door opener, gate operator, security system, entry door lock, home/office lighting, etc.). For convenience, the hand-held transmitter of the device may also be used at any time.

Reprogramming a single HomeLink® button

To program a new device to a previously trained HomeLink® button, follow these steps:

1. Press and hold the desired HomeLink® button. Do NOT release until step 4 has been completed.
2. When the indicator light begins to flash slowly (after 20 seconds), position the handheld transmitter 1 to 3 inches away from the HomeLink® surface.
3. Press and hold the handheld transmitter button. The HomeLink® indicator light will flash, first slowly and then rapidly.
4. When the indicator light begins to flash rapidly, release both buttons.
5. Press and hold the just-trained HomeLink® button and observe the red Status Indicator LED. If the indicator light stays on constantly, programming is complete and your new device should activate.

Erasing HomeLink® buttons

Individual buttons cannot be erased. However, to erase all three programmed buttons:

1. Press and hold the two outer HomeLink® buttons until the indicator light begins to flash-after 20 seconds.
2. Release both buttons. Do not hold for longer than 30 seconds.

The Integrated HomeLink® Wireless Control System is now in the training (learn) mode and can be programmed at any time following the appropriate steps in the Programming chapters above.

NVS® is a registered trademark and Z-Nav™ is a trademark of the Gentex Corporation, Zeeland, Michigan. HomeLink® is a registered trademark owned by Johnson Controls, Incorporated, Milwaukee, Wisconsin.

FCC ID: NZLZTVHL3

IC: 4112A-ZTVHL3

i Information

This device complies with Part 15 of the FCC Rules.

Operation is subject to the following three conditions:

1. **This device may not cause harmful interference, and**
2. **This device must accept any interference received, including interference that may cause undesired operation.**
3. **The transceiver has been tested and complies with FCC and Industry Canada rules. Changes or modifications not expressly approved by the party responsible for compliance could void the user's authority to operate the device.**

Outside Rearview Mirror

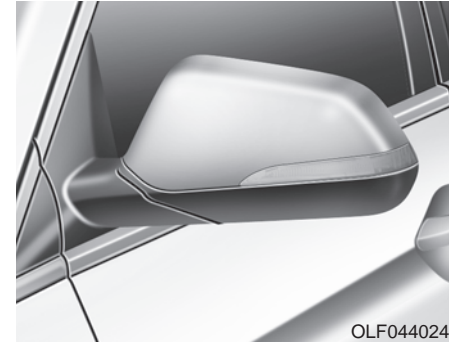

Be sure to adjust mirror angles before driving.

Your vehicle is equipped with both left-hand and right-hand outside rearview mirrors. The mirrors can be adjusted remotely with the remote switch. The mirror heads can be folded to prevent damage during an automatic car wash or when passing through a narrow street.

The right outside rearview mirror is convex. Objects seen in the mirror are closer than they appear.

Use your interior rearview mirror or direct observation to determine the actual distance of following vehicles when changing lanes.

⚠ WARNING

Do not adjust or fold the outside rearview mirrors while driving. This may cause loss of vehicle control resulting in an accident.

⚠ CAUTION

- Do not scrape ice off the mirror face; this may damage the surface of the glass.
- If the mirror is jammed with ice, do not adjust the mirror by force. Use an approved spray de-icer (not radiator antifreeze) spray, or a sponge or soft cloth with warm water, or move the vehicle to a warm place and allow the ice to melt.

Blind zone mirror

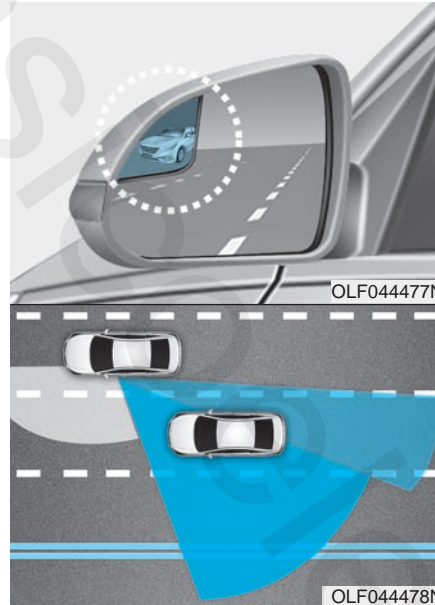

The Blind Zone Mirror (BZM) is a supplemental mirror that helps the driver's blind zone by showing the rear side area of the vehicle. The blind zone mirror is equipped on the left-hand outside rearview mirror.

⚠ WARNING

- Always check the road condition while driving for unexpected situations even though the vehicle is equipped with a blind zone mirror.
- The blind zone mirror is a device made for convenience. Do not solely rely on the mirror but always pay attention to traffic around you.

NOTICE

Do not clean the mirror with harsh abrasives, fuel or other petroleum based cleaning products.

Outside rearview mirror control



Adjusting the rearview mirrors:

1. Move the lever (1) towards the L(Left) or R(Right) to select the rearview mirror you would like to adjust.
2. Use the mirror adjustment control switch to position the selected mirror up, down, left or right.
3. After adjustment, place the lever (1) in the center to prevent inadvertent adjustment.

NOTICE

- The mirrors stop moving when they reach the maximum adjusting angles, but the motor continues to operate while the switch is pressed. Do not press the switch longer than necessary, the motor may be damaged.
- Do not attempt to adjust the outside rearview mirror by hand or the motor may be damaged.

Folding the outside rearview mirror

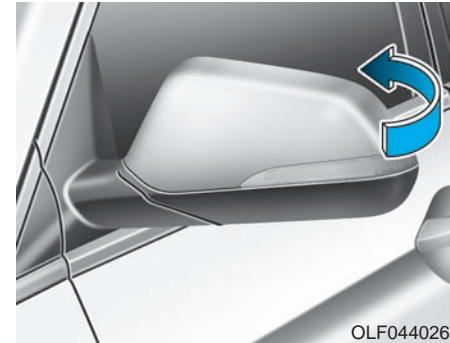

To fold the outside rearview mirror, grasp the housing of the mirror and then fold it toward the rear of the vehicle.

Reverse Parking Aid Function



When you move the shift lever to the R (Reverse) position, the outside rearview mirror(s) will rotate downwards to aid with driving in reverse. The position of the outside rearview mirror switch (1) determines whether or not the mirrors will move:

Left/Right : When either the L (Left) or R (Right) switch is selected, both outside rearview mirrors will move.

Neutral : When neither switch is selected, the outside rearview mirrors will not move.

The outside rearview mirrors will automatically revert to their original positions if any of the following occur:

- Engine Start/Stop button is placed to the ACC or OFF position.
- The shift lever is moved to any position except R (Reverse).
- The remote control outside rearview mirror switch is not selected.

WINDOWS

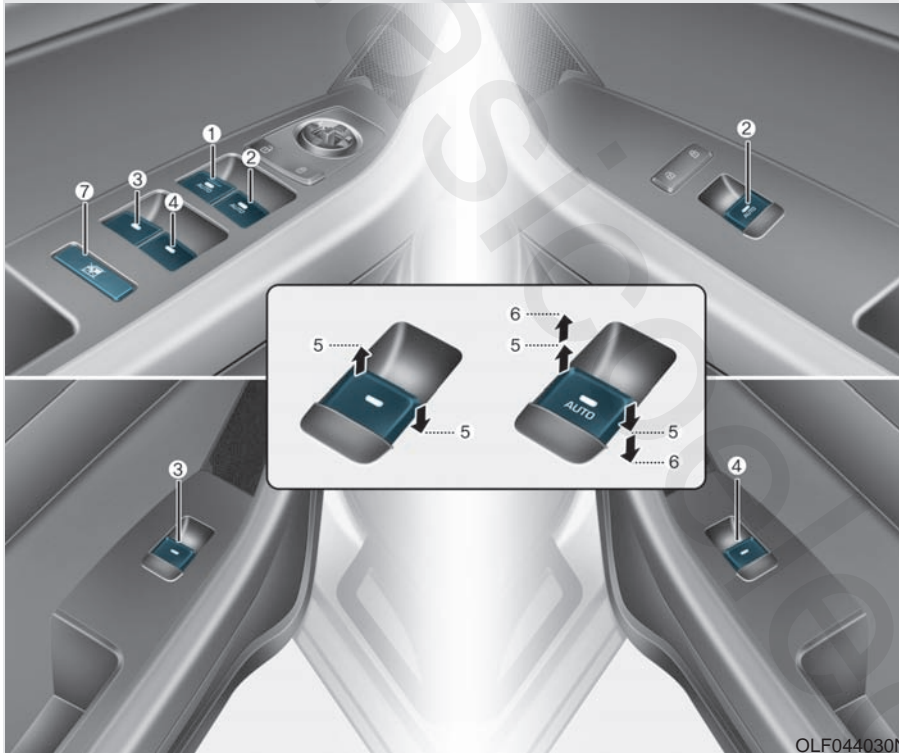

- (1) Driver's door power window switch
- (2) Front passenger's door power window switch
- (3) Rear door (left) power window switch
- (4) Rear door (right) power window switch
- (5) Window opening and closing
- (6) Automatic power window*
- (7) Power window lock switch

Power Windows

Engine Start/Stop button must be in the ON position to be able to raise or lower the windows. Each door has a Power Window switch to control that door's window. The driver has a Power Window Lock switch which can block the operation of passenger windows. The power windows will operate for approximately 30 seconds after engine Start/Stop button is in the ACC or OFF position. However, if the front doors are opened, the Power Windows cannot be operated even within the 30 second period.

WARNING

To avoid serious injury or death, do not extend your head, arms or body outside the windows while driving.

Information

- In cold and wet climates, power windows may not work properly due to freezing conditions.
- While driving with the rear windows down or with the sunroof (if equipped) opened (or partially opened), your vehicle may demonstrate a wind buffeting or pulsation noise. This noise is normal and can be reduced or eliminated by taking the following actions. If the noise occurs with one or both of the rear windows down, partially lower both front windows approximately one inch. If you experience the noise with the sunroof open, slightly close the sunroof.

Window opening and closing

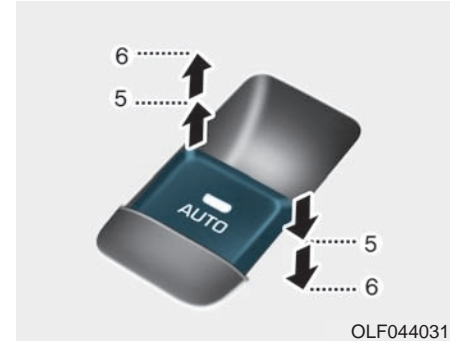

To open:

Press the window switch down to the first detent position (5). Release the switch when you want the window to stop.

To close:

Pull the window switch up to the first detent position (5). Release the window switch when you want the window to stop.

Auto up/down window (if equipped)

Pressing or pulling up the power window switch momentarily to the second detent position (6) completely lowers or lifts the window even when the switch is released. To stop the window at the desired position while the window is in operation, pull up or press down and release the switch.

To reset the power windows

If the power windows do not operate normally, the automatic power window system must be reset as follows:

1. Place engine Start/Stop button in the ON position.
2. Close the window and continue pulling up on the power window switch for at least one second.

If the power windows do not operate properly after resetting, have the system checked by an authorized HYUNDAI dealer.

Automatic reverse (if equipped)

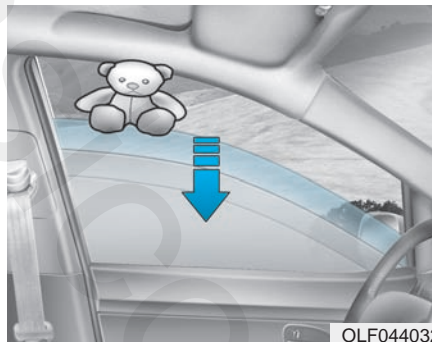

If a window senses any obstacle while it is closing automatically, it will stop and lower approximately 12 inches (30 cm) to allow the object to be cleared.

If the window detects the resistance while the power window switch is pulled up continuously, the window will stop upward movement then lower approximately 1 inch (2.5 cm).

If the power window switch is pulled up continuously again within 5 seconds after the window is lowered by the automatic window reversal feature, the automatic window reversal will not operate.

***i* Information**

The automatic reverse feature is only active when the “Auto Up” feature is used by fully pulling up the switch to the second detent.

***!* WARNING**

Make sure body parts or other objects are safely out of the way before closing the windows to avoid injuries or vehicle damage.

Objects less than 0.16 inch (4 mm) in diameter caught between the window glass and the upper window channel may not be detected by the automatic reverse window and the window will not stop and reverse direction.

Power window lock switch



The driver can disable the power window switches on the rear passengers' doors by pressing the power window lock switch.

When the power window lock switch is pressed:

- The driver's master control can operate all the power windows.
- The front passenger's control can operate the front passenger's power window.
- The rear passenger's control cannot operate the rear passengers' power window.

WARNING

Do not allow children to play with the power windows. Keep the driver's door power window lock switch in the LOCK position. Serious injury or death can result from unintentional window operation by a child.

NOTICE

- To prevent possible damage to the power window system, do not open or close two windows or more at the same time. This will also ensure the longevity of the fuse.
- Never try to operate the main switch on the driver's door and the individual door window switch in opposite directions at the same time. If this is done, the window will stop and cannot be opened or closed.

PANORAMIC SUNROOF (IF EQUIPPED)



OLF044034

Engine Start/Stop button must be in the ON position before you can open or close the sunroof.

i Information

In cold and wet climates, the sunroof may not work properly due to freezing conditions.

! WARNING

Never adjust the sunroof or sunshade while driving. This could result in loss of vehicle control resulting in an accident.

! WARNING

- Make sure heads, other body parts or objects are out of the way before using the sunroof.
- Do not leave the engine running and the key in your vehicle with unsupervised children. Unattended children could operate the sunroof, which could result in serious injury.

NOTICE

To prevent damage to the sunroof and the motor, do not continue to press the sunroof control lever after the sunroof is in the fully open, closed or tilt position(s).

Sunshade



OLF044035

- To open the sunshade, press the sunshade control switch (1).
- To close the sunshade, press the sunshade control switch (2). If you press the switch when the sunroof glass is opened, the sunroof glass will close then the sunshade will close.

To stop the sliding at any point, press the sunshade control switch momentarily.

Sliding the Sunroof

When the sunshade is closed



OLF044036

If you pull the sunroof control lever backward, the sunroof glass will slide all the way open then the sunroof glass will slide all the way open. To stop the sunroof movement at any point, pull or push the sunroof control lever momentarily.

When the sunshade is opened

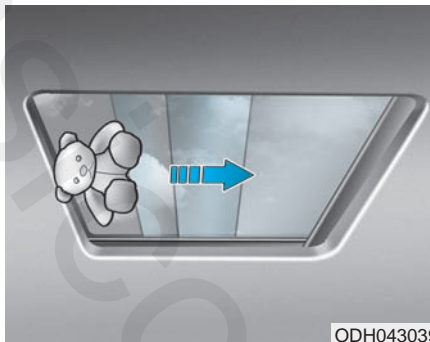

ODH043039

If you pull the sunroof control lever backward, the sunroof glass will slide all the way open. To stop the sunroof movement at any point, pull or push the sunroof control lever momentarily.

i Information

Only the front glass of the panoramic sunroof opens and closes.

Tilting the Sunroof

When the sunshade is closed

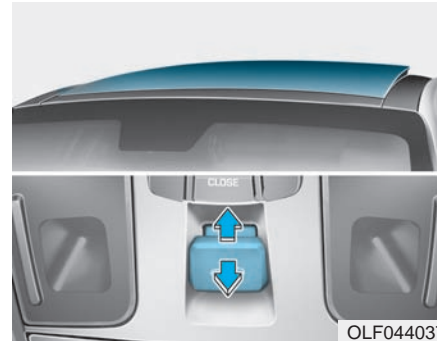

OLF044037

If you push the sunroof control lever upward, the sunshade will slide open then the sunroof glass will tilt.

To stop the sunroof movement at any point, pull or push the sunroof control lever momentarily.

When the sunshade is opened

If you push the sunroof control lever upward, the sunroof glass will tilt.

To stop the sunroof movement at any point, pull or push the sunroof control lever momentarily.

Closing the Sunroof

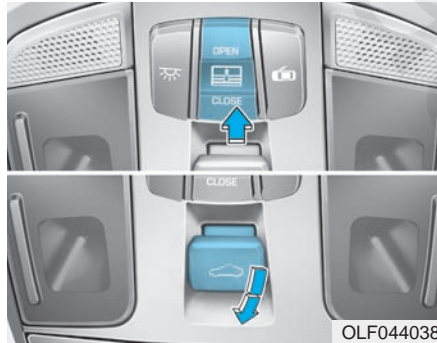

Press the sunshade CLOSE button. The sunroof glass will close then the sunshade will close. To stop the sunroof movement at any point, press the sunshade control switch momentarily.

Automatic reverse

If the sunroof senses any obstacle while it is closing automatically, it will reverse direction then stop to allow the object to be cleared.

⚠ WARNING

- **Make sure heads, other body parts or other objects are safely out of the way before closing the sunroof to avoid injuries or vehicle damage.**

Objects that are small caught between the sunroof glass and the front glass channel may not be detected by the automatic reverse glass and the glass will not stop and reverse direction.

- **To avoid serious injury or death, do not extend your head, arms or body outside the sunroof while driving.**
- **A panoramic sunroof is made of glass, therefore it may break in an accident. If you do not have your seat belt on, you may contact the broken glass and get injured or killed.**

NOTICE

- Periodically remove any dirt that may accumulate on the sunroof guide rail or between the sunroof and roof panel.
- Do not try to open the sunroof when the temperature is below freezing or when the sunroof is covered with snow or ice, the motor could be damaged.

i Information

After the vehicle is washed or in a rainstorm, be sure to wipe off any water that is on the sunroof before operating it.

To Reset the Sunroof

OLF044040

Sunroof needs to be reset if (in the followings)

- Battery is discharged or disconnected or the related fuse has been replaced or disconnected
- The one-touch sliding function of the sunroof does not normally operate

1. Turn the engine on and close the sunroof glass and sunshade completely.
2. Release the control lever.

3. Push the sunroof control lever forward in the direction of close (about 10 seconds) until the sunroof slightly moves. Then, release the lever.
4. Push the sunroof control lever forward in the direction of close until the sunroof operates as follows:

Sunshade Open → Glass Tilt Open
→ Glass Slide Open → Glass Slide Close
→ Sunshade Close

Then, release the control lever.

When this is complete, the sunroof system is reset.

For more information, contact an authorized HYUNDAI dealer.

i Information

If you do not reset the sunroof, it may not work properly.

EXTERIOR FEATURES

Hood

Opening the hood

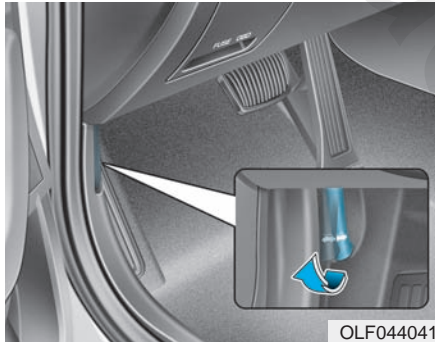

1. Park the vehicle and set the parking brake.
2. Pull the release lever to unlatch the hood. The hood should pop open slightly.

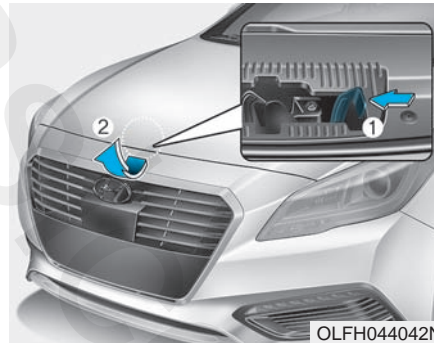

3. Raise the hood slightly, push the secondary latch up (1) inside of the hood center and lift the hood (2). After it has been raised about halfway, it will raise completely by itself.

Closing the hood

1. Before closing the hood, check the following:
 - All filler caps in engine compartment must be correctly installed.
 - Gloves, rags or any other combustible material must be removed from the engine compartment.
2. Lower the hood halfway and push down to securely lock in place. Then double check to be sure the hood is secure.

⚠ WARNING

- Before closing the hood, ensure all obstructions are removed from around hood opening.
- Always double check to be sure that the hood is firmly latched before driving away. If it is not latched, the hood could open while the vehicle is being driven, causing a total loss of visibility, which might result in an accident.
- Do not move the vehicle with the hood in the raised position, as vision is obstructed, which might result in an accident, and the hood could fall or be damaged.

Trunk

Opening the trunk

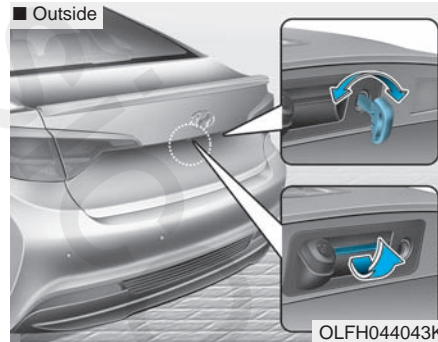

1. Make sure the shift lever is in P (Park).
2. Then do one of the following :
 - Press the Smart Key Trunk Unlock button for more than one second.
 - Press the button on the trunk itself with the Smart Key in your possession.
 - Use the mechanical key.

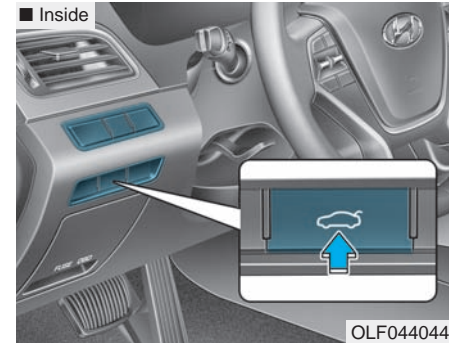

- Use the trunk release button.
3. Lift the trunk lid up.

Closing the trunk

Lower the trunk lid and press down until it locks.

WARNING

Always keep the trunk lid completely closed while the vehicle is in motion. If it is left open or ajar, poisonous exhaust gases containing carbon monoxide (CO) may enter the vehicle and serious illness or death may result.

WARNING

Make sure there are no people or objects around the trunk before opening or closing the Power Trunk. Wait until the trunk is open fully and stopped before loading or unloading cargo from the vehicle.

NOTICE

To prevent damage to the trunk lift cylinders and the attached hardware, always close the trunk before driving.

Information

In cold and wet climates, trunk lock and trunk mechanisms may not work properly due to freezing conditions.

Emergency trunk safety release



Your vehicle is equipped with an Emergency Trunk Safety Release lever located inside the trunk. When someone is inadvertently locked in the trunk, the trunk can be opened by moving the lever in the direction of the arrow and pushing the trunk open.

WARNING

- You and your passengers must be aware of the location of the Emergency Trunk Safety Release lever in this vehicle and how to open the trunk in case you are accidentally locked in the trunk.
- NEVER allow anyone to occupy the trunk of the vehicle at any time. If the trunk is partially or totally latched and the person is unable to get out, serious injury or death could occur due to lack of ventilation, exhaust fumes and rapid heat build-up, or because of exposure to cold weather conditions. The trunk is also a highly dangerous location in the event of a crash because it is not a protected occupant space but is a part of the vehicle's crush zone.

(Continued)



(Continued)

- Your vehicle should be kept locked and the Smart Key should be kept out of the reach of children. Parents should teach their children about the dangers of playing in trunks.
- Use the release lever for emergencies only.

Trunk lid control switch



The trunk lid control switch is used to prevent unauthorized access to the trunk.

- When the trunk lid control switch is in the UNLOCK position () , the trunk can be unlocked with the trunk release button and the smart key.
- When the trunk lid control switch is in the LOCK position () , the trunk can be unlocked with the mechanical key of the smart key.

Smart Trunk (if equipped)

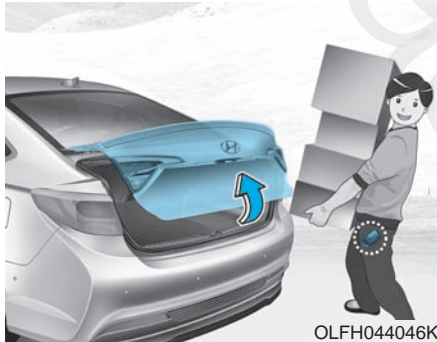

On a vehicle equipped with a smart key, the trunk can be opened using the Smart Trunk system.

How to use the Smart Trunk

The trunk can be opened with no-touch activation satisfying all the conditions below.

- After 15 seconds when all doors are closed and locked
- Positioned in the detecting area for more than 3 seconds.

i Information

- **The Smart Trunk does not operate when:**
 - **The smart key is detected within 15 seconds after the doors are closed and locked, and is continuously detected.**
 - **The smart key is detected within 15 seconds after the doors are closed and locked, and within 60 inches (1.5 m) from the front door handles. (for vehicles equipped with Welcome Light)**
 - **A door is not locked or closed.**
 - **The smart key is in the vehicle.**

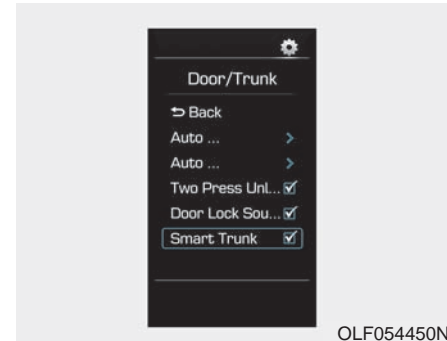

1. Setting

To activate the Smart Trunk, go to User Settings Mode and select Smart Trunk on the LCD display.

For more information, refer to the "LCD Display" section in this chapter.

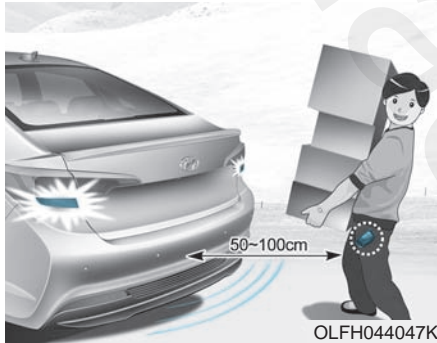

2. Detect and Alert

If you are positioned in the detecting area (20~40 inches (50 ~100 cm) behind the vehicle) carrying a smart key, the hazard warning lights will blink and chime will sound for about 3 seconds to alert you the smart key has been detected and the trunk will open.

i Information

Do not approach the detecting area if you do not want the trunk to open. If you have unintentionally entered the detecting area and the hazard warning lights and chime starts to operate, leave the detecting area with the smart key. The trunk will stay closed.



3. Automatic opening

The hazard warning lights will blink and chime will sound 2 times and then the trunk will open.

⚠ WARNING

- Make sure you close the trunk before driving your vehicle.
- Make sure there are no people or objects around the trunk before opening or closing the trunk.
- Make sure objects in the trunk do not come out when opening the trunk on a slope. It may cause serious injury.
- Make sure to deactivate the Smart Trunk when washing your vehicle. Otherwise, the trunk may open inadvertently.
- The key should be kept out of reach of children. Children may inadvertently open the Smart Trunk while playing around the rear area of the vehicle.

How to deactivate the Smart Trunk function using the smart key



1. Door lock 3. Trunk open
2. Door unlock 4. Panic

If you press any button of the smart key during the Detect and Alert stage, the Smart Trunk function will be deactivated.

Make sure to be aware of how to deactivate the Smart Trunk function for emergency situations.

i Information

- If you press the door unlock button (2), the Smart Trunk function will be deactivated temporarily. But, if you do not open any door for 30 seconds, the smart trunk function will be activated again.
- If you press the trunk open button (3) for more than 1 second, the trunk opens.
- If you press the door lock button (1) or trunk open button (3) when the Smart Trunk function is not in the Detect and Alert stage, the smart trunk function will not be deactivated.
- In case you have deactivated the Smart Trunk function by pressing the smart key button and opened a door, the smart trunk function can be activated again by closing and locking all doors.

Detecting area



- The Smart Trunk operates with a welcome alert if the smart key is detected within 20~40 inches (50~100 cm) from the trunk.
- The alert stops at once if the smart key is positioned outside the detecting area during the Detect and Alert stage.

i Information

- The Smart Trunk function will not work if any of the following occurs:
 - The smart key is close to a radio transmitter such as a radio station or an airport which can interfere with normal operation of the transmitter.
 - The smart key is near a mobile two way radio system or a cellular phone.
 - Another vehicle's smart key is being operated close to your vehicle.
- The detecting range may decrease or increase when :
 - One side of the tire is raised to replace a tire or to inspect the vehicle.
 - The vehicle is parked on a slope or unpaved road, etc.

Fuel Filler Door

Opening the fuel filler door

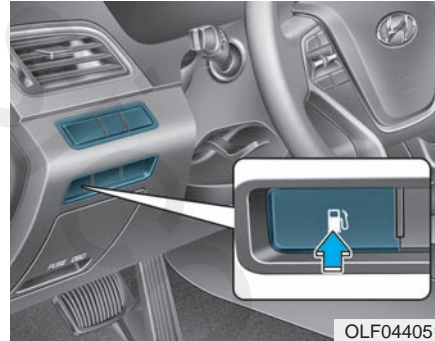

The fuel filler door must be opened from inside the vehicle by pushing the fuel filler door opener button.

1. Turn the engine off.
2. Push the fuel filler door opener button.

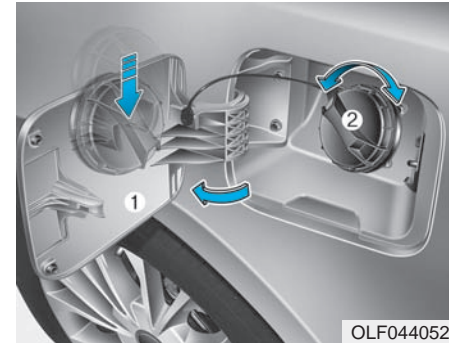

3. Pull the fuel filler door (1) out to fully open.
4. To remove the fuel tank cap (2), turn it counterclockwise. You may hear a hissing noise as the pressure inside the tank equalizes.
5. Place the cap on the fuel filler door.

i Information

If the fuel filler door does not open because ice has formed around it, tap lightly or push on the door to break the ice and release the door. Do not pry on the door. If necessary, spray around the door with an approved de-icer fluid (do not use radiator anti-freeze) or move the vehicle to a warm place and allow the ice to melt.

Closing the fuel filler door

1. To install the fuel tank cap, turn it clockwise until it “clicks” one time.
2. Close the fuel filler door until it is latched securely.

⚠ WARNING

Gasoline is highly flammable and explosive. Failure to follow these guidelines may result in SERIOUS INJURY or DEATH:

- Read and follow all warnings posted at the gas station.
- Before refueling, note the location of the Emergency Gasoline Shut-Off, if available, at the gas station.
- Before touching the fuel nozzle, you should eliminate the potential build-up of static electricity by touching a metal part of the vehicle, a safe distance away from the fuel filler neck, nozzle, or other gas source, with your bare hand.
- Do not use cellular phones while refueling. Electric current and/or electronic interference from cellular phones can potentially ignite fuel vapors and cause a fire.

(Continued)

(Continued)

- Do not get back into a vehicle once you have begun refueling. You can generate a build-up of static electricity by touching, rubbing or sliding against any item or fabric capable of producing static electricity. Static electricity discharge can ignite fuel vapors causing a fire. If you must re-enter the vehicle, you should once again eliminate potentially dangerous static electricity discharge by touching a metal part of the vehicle, away from the fuel filler neck, nozzle or other gasoline source, with your bare hand.
- When using an approved portable fuel container, be sure to place the container on the ground prior to refueling. Static electricity discharge from the container can ignite fuel vapors causing a fire.

(Continued)

(Continued)

- Once refueling has begun, contact between your bare hand and the vehicle should be maintained until the filling is complete.
- Use only approved portable plastic fuel containers designed to carry and store gasoline.
 - When refueling, always move the shift lever to the P (Park) position, set the parking brake, and place engine Start/Stop button to the OFF position. Sparks produced by electrical components related to the engine can ignite fuel vapors causing a fire.
 - Do not use matches or a lighter and do not smoke or leave a lit cigarette in your vehicle while at a gas station, especially during refueling.
 - Do not over-fill or top-off your vehicle tank, which can cause gasoline spillage.

(Continued)

(Continued)

- If a fire breaks out during refueling, leave the vicinity of the vehicle, and immediately contact the manager of the gas station and then contact the local fire department. Follow any safety instructions they provide.
- If pressurized fuel sprays out, it can cover your clothes or skin and thus subject you to the risk of fire and burns. Always remove the fuel cap carefully and slowly. If the cap is venting fuel or if you hear a hissing sound, wait until the condition stops before completely removing the cap.
- Always check that the fuel cap is installed securely to prevent fuel spillage in the event of an accident.

i Information

Make sure to refuel your vehicle according to the "Fuel Requirements" suggested in the Introduction chapter.

NOTICE

- Do not spill fuel on the exterior surfaces of the vehicle. Any type of fuel spilled on painted surfaces may damage the paint.
- If the fuel filler cap requires replacement, use only a genuine HYUNDAI cap or the equivalent specified for your vehicle. An incorrect fuel filler cap can result in a serious malfunction of the fuel system or emission control system.

Emergency fuel filler door release



If the fuel filler door does not open using the remote fuel filler door release button, you can open it manually. Pull the handle of the release located on the left side of the luggage compartment outward slightly.

INSTRUMENT CLUSTER

■ Type A

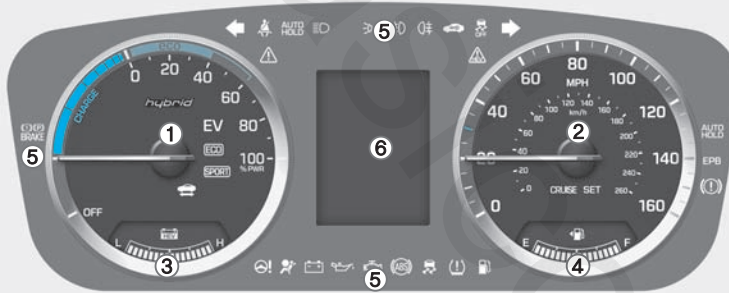

1. Hybrid system gauge
2. Speedometer
3. Battery SOC (State of Charge) gauge
4. Fuel gauge
5. Warning and indicator lights
6. LCD display (including Trip computer)

■ Type B



The actual cluster in the vehicle may differ from the illustration.

OLF044200N/OLF044201N

Instrument cluster control

Adjusting Instrument Panel Illumination

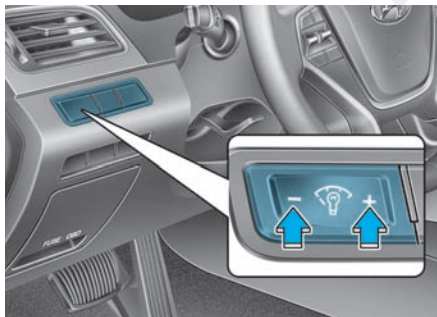

OLF044102

The brightness of the instrument cluster illumination can be adjusted by pressing the illumination control buttons (“+” or “-”), when the Engine Start/Stop button is ON, or when the parking lights are turned ON.

When pressing the illumination control button, the interior switch illumination intensity is also adjusted. The selected brightness of illumination can be saved in the Driver position memory system(if equipped).

For more information, refer to “Driver position Memory System” in this chapter.

⚠ WARNING

Never adjust the instrument cluster while driving. This could result in loss of control and lead to an accident that may cause death, serious injury, or property damage.

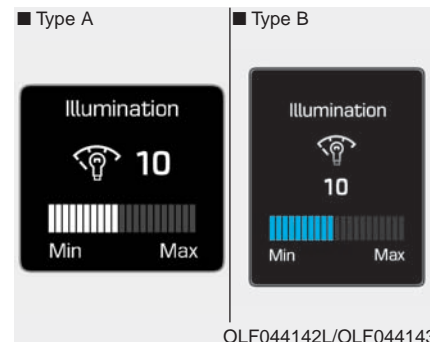

OLF044142L/OLF044143L

- The brightness of the instrument panel illumination is displayed.
- If the brightness reaches to the maximum or minimum level, an alarm will sound.

Gauges

Speedometer



The speedometer indicates the driving speed, calibrated in miles per hour (mph) and/or kilometers per hour (km/h).

Hybrid System Gauge



The hybrid system gauge indicates whether the current driving condition is fuel efficient or not.

- **CHARGE** : Shows that the energy made by the vehicle is being converted to electrical energy. (Regenerated energy)
- **ECO** : Shows that the vehicle is being driven in an Eco-friendly manner.
- **POWER** : Shows that the vehicle is exceeding the Eco-friendly range.

Information

Accordance to the hybrid system gauge area the “EV” indicator comes on or off.

- “EV” indicator ON : Vehicle is driven using the electric motor or the gasoline engine is stopped.
- “EV” indicator OFF : Vehicle is driven using the gasoline engine.

Hybrid Battery SOC (State of Charge) Gauge

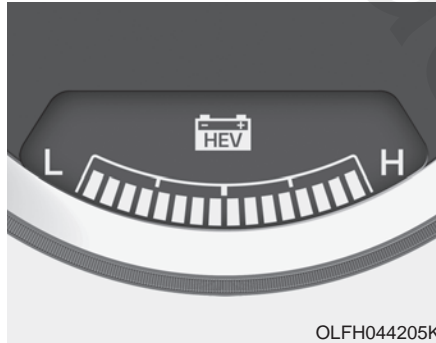

This gauge indicates the remaining hybrid battery power. If the SOC is near the "L (Low)" level, the vehicle automatically operates the engine to charge the battery. However, if the Service Indicator (⚠️) and Malfunction Indicator Lamp (MIL) (🔧) turn on when the SOC gauge is near the "L (Low)" level, have the vehicle checked by an authorized HYUNDAI dealer.

NOTICE

Never try to start the vehicle if the fuel tank is empty. In this condition, the engine cannot charge the high voltage battery of the hybrid system. If you try to start the vehicle when the fuel is empty, the high voltage battery will become discharged and be damaged.

Fuel Gauge

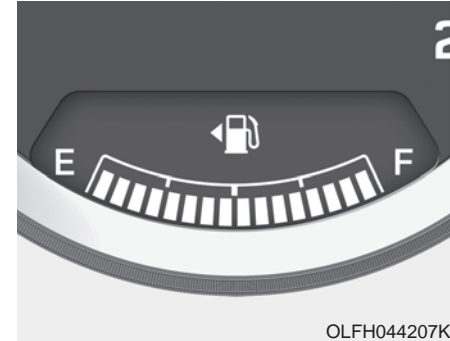

This gauge indicates the approximate amount of fuel remaining in the fuel tank.

i Information

- The fuel tank capacity is specified in chapter 8.
- The fuel gauge is supplemented by a low fuel warning light, which will illuminate when the fuel tank is nearly empty.
- On inclines or curves, the fuel gauge pointer may fluctuate or the low fuel warning light may come on earlier than usual due to the movement of fuel in the tank.

⚠ WARNING

Running out of fuel can expose vehicle occupants to danger. You must stop and obtain additional fuel as soon as possible after the warning light comes on or when the gauge indicator comes close to the "E (Empty)" level.

NOTICE

Avoid driving with an extremely low fuel level. Running out of fuel could cause the engine to misfire, damaging the catalytic converter.

Engine coolant temperature gauge

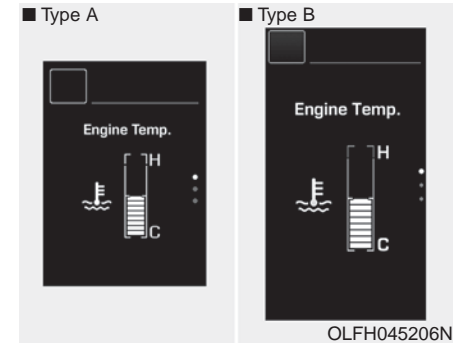

This gauge indicates the temperature of the engine coolant when the engine is running.

NOTICE

When the gauge indicator gets out of the normal range, toward the “H” position, it indicates overheating of the engine. It may damage the engine.

Do not continue driving with the overheated engine. For further information, refer to “If the Engine Overheats” in the chapter 6.



CAUTION

Never remove the radiator cap when the engine is hot. The engine coolant is under pressure and may cause severe burn. Wait until the engine cools down before adding coolant to the reservoir.

Outside Temperature Gauge



This gauge indicates the current outside air temperatures either in Celsius (°C) or Fahrenheit.

- Temperature range : -40°F ~ 140°F
(-40°C ~ 60°C)

The outside temperature on the display may not immediately change like a general thermometer not to distract the driver.

The temperature unit (from °F to °C or ~ °F to °C) can be changed by:

- User Settings Mode in the Cluster : You can change the temperature unit in the “Other Features - Temperature unit” .
- Automatic climate control system : While pressing the OFF button, press the AUTO button for 3 seconds or more.

The temperature unit of the instrument cluster and climate control system will change at once.

Odometer

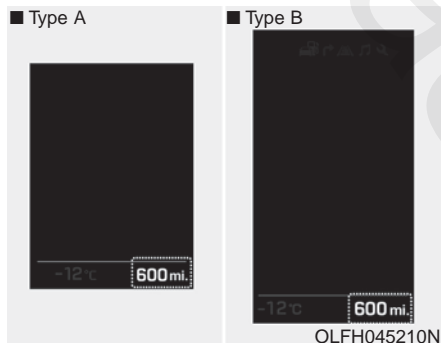

The odometer indicates the accumulated distance that the vehicle has driven and determines the periodic maintenance schedule that should be performed.

Warning and indicator lights

Ready Indicator



This indicator illuminates :

- When the vehicle is ready to be driven.
- ON : Normal driving is possible.
 - OFF : Normal driving is not possible, or a problem has occurred.
 - Blinking : Emergency driving.

When the ready indicator goes OFF or blinks, there is a problem with the system. In this case, have your vehicle inspected by an authorized HYUNDAI dealer.

Service Warning Light



This warning light illuminates :

- When the Engine Start/Stop button is in the ON position.
 - It illuminates for approximately 3 seconds and then goes off.
- When there is a problem with the hybrid vehicle control system or hardware.

When the warning light illuminates while driving, or does not go OFF after starting the vehicle have your vehicle inspected by an authorized HYUNDAI dealer.

EV Mode Indicator



This indicator illuminates when the vehicle is driven by the electric motor.

Air bag Warning Light



This warning light illuminates:

- When the Engine Start/Stop button is in the ON position.
 - It illuminates for approximately 6 seconds and then goes off.
- When there is a malfunction with the SRS.

In this case, have the vehicle inspected by an authorized HYUNDAI dealer.

Seat Belt Warning Light



This warning light informs the driver that the seat belt is not fastened.

For more information, refer to the “Seat Belts” in chapter 2.

Parking Brake & Brake Fluid Warning Light



This warning light illuminates:

- When the Engine Start/Stop button is in the ON position
 - It illuminates for approximately 3 seconds and then goes off.
 - It remains on if the parking brake is applied.
- When the parking brake is applied.
- When the brake fluid level in the reservoir is low.
 - If the warning light illuminates with the parking brake released, it indicates the brake fluid level in reservoir is low.
- When the regenerative brake does not operate.
- When only one of the dual system is working, the stopping distance will be increased

If the brake fluid level in the reservoir is low:

1. Drive carefully to the nearest safe location and stop your vehicle.
2. Stop the vehicle, immediately check the brake fluid level and add fluid, if necessary (**For more information, refer to "Brake Fluid" in the chapter 7**). Then check all brake components for fluid leaks. When any leak in the brake system is still detected, when the warning light remains ON, or when the brakes do not properly operate, do not drive the vehicle.

In this case, have the vehicle towed to an authorized HYUNDAI dealer and inspected.

Dual-diagonal braking system

Your vehicle is equipped with dual-diagonal braking systems. This means you still have braking on two wheels even if one of the dual systems fails.

With only one of the dual systems working, longer pedal travel and greater pedal pressure is required.

If the brakes fail , while driving, shift to a lower gear for additional engine braking and stop the vehicle as soon as it is safe to do so.

WARNING

Driving the vehicle with a warning light ON is dangerous. If the Parking Brake & Brake Fluid Warning Light illuminates with the parking brake released, it indicates that the brake fluid level is low.

In this case, have the vehicle inspected by an authorized HYUNDAI dealer.

Regenerative Brake Warning Light



This warning light illuminates :

When the regenerative brake does not operate and the brake does not perform well. This causes the Brake Warning light (red) and Regenerative Brake Warning Light (yellow) to illuminate simultaneously.

In this case, drive safely and have your vehicle inspected by an authorized HYUNDAI dealer.

WARNING

The operation of the brake pedal may be more difficult than normal and the braking distance can increase.

Anti-lock Brake System (ABS) Warning Light



This warning light illuminates in one of the following situations:

- When the Engine Start/Stop button is in the ON position.
 - It illuminates for approximately 3 seconds and then goes off.
- There is a malfunction with the ABS (The normal braking system is still operational without the assistance of the anti-lock brake system).

In this case, have the vehicle inspected by an authorized HYUNDAI dealer.

Electronic Brake force Distribution (EBD) System Warning Light



These two warning lights illuminate at the same time while driving in the following situation:

- The ABS and the regular brake system may not properly operate.

In this case, have the vehicle inspected by an authorized HYUNDAI dealer.

WARNING

When both the ABS and Parking Brake & Brake Fluid Warning Lights are on, the brake system will not work normally and you may experience an unexpected and dangerous situation during sudden braking.

In this case, avoid high speed driving and abrupt braking.

Have the vehicle inspected by an authorized HYUNDAI dealer as soon as possible.

Information

When the ABS warning light illuminates, or when both the ABS and the Parking Brake & Brake Fluid warning lights illuminate, the speedometer, the odometer, or the tripmeter may not properly operate. Also, the EPS Warning Light may illuminate, and the efforts to operate the steering wheel may need to be increased or decreased.

In this case, have the vehicle inspected by an authorized HYUNDAI dealer as soon as possible.

Electronic Parking Brake (EPB) Warning Light (if equipped)

EPB

This warning light illuminates:

- When the Engine Start/Stop button is in the ON position.
 - It illuminates for approximately 3 seconds and then goes off.
- When there is a malfunction with the EPB.

In this case, have the vehicle inspected by an authorized HYUNDAI dealer.

Information

The Electric Parking Brake (EPB) warning light may illuminate, when the Electronic Stability Control (ESC) indicator illuminates due to the ESC malfunction (This does not indicate the EPB malfunction).

Malfunction Indicator Lamp (MIL)



This warning light illuminates in one of the following situations:

- You turn ON the Engine Start/Stop button.
 - It remains on until the engine is started.
- There is a malfunction with the emission control system.

In this case, have the vehicle inspected by an authorized HYUNDAI dealer.

NOTICE

Driving with the Malfunction Indicator Lamp (MIL) on may cause damage to the emission control systems which could affect drivability and/or fuel economy.

NOTICE

When the Malfunction Indicator Lamp (MIL) illuminates, the catalytic converter is possibly damaged, resulting in loss of engine power.

In this case, have the vehicle inspected by an authorized HYUNDAI dealer as soon as possible.

Charging System Warning Light

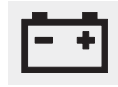

When this warning light illuminates while running the engine, the battery is not being charged. Immediately turn OFF all electrical accessories. Try not to use electrically operated controls, such as the power windows. Keep running the engine. Have the vehicle inspected by an authorized HYUNDAI dealer as soon as possible.

Engine Oil Pressure Warning Light



In this case, have your vehicle inspected by an authorized HYUNDAI dealer.

This warning light illuminates:

- When the Engine Start/Stop button is in the ON position.
 - It remains on until the engine is started.
- When the engine oil pressure is low.

When the engine oil pressure is low, follow the below procedures:

1. Carefully drive to the nearest safe location and stop your vehicle.
2. Turn OFF the engine and check the engine oil level (**For more information, refer to the “Engine Oil” in the chapter 7**). If the level is low, add engine oil.

When the warning light remains ON after adding engine oil and restarting the engine, or when engine oil refilling is unavailable, turn OFF the engine. These indicate a mechanical problem, which needs to be repaired before driving.

NOTICE

When the Engine Oil Pressure Warning Light illuminates, turn OFF the engine, and check the engine oil level, in an attempt to prevent severe engine damage. These should be done as soon as it is safe to do so. When the oil level is low, add the engine oil to the proper level and start the engine again. When the light stays ON, while running the engine, immediately turn OFF the engine.

In this case, have your vehicle inspected by an authorized HYUNDAI dealer.

Low Fuel Level Warning Light



This warning light illuminates:

When the fuel tank is nearly empty.

When the fuel tank is nearly empty:

Add fuel as soon as possible.

NOTICE

- Driving with the Low Fuel Level warning light on or with the fuel level below "E (Empty)" may cause the engine to misfire and damage the catalytic converter.
- Driving the vehicle in EV mode after fuel runs out may damage the hybrid battery

Master Warning Light



This warning light illuminates in one of the following situations:

- When there is a problem with the Collision Warning System (FCWS).
- When there is a problem with the Smart Cruise Control (SCC).
- When there is a problem with the Blind Spot Detection (BSD).
- When washer fluid level is low.
- When there is a problem with the Tire Pressure Monitoring System (TPMS).

To identify the cause of the warning, look at the LCD display.

Icy road warning light (if equipped)

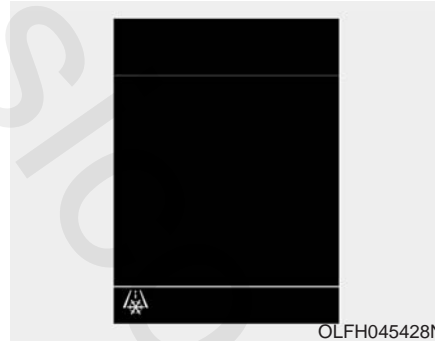

This warning light is to warn the driver the road may be icy.

When the temperature on the outside temperature gauge is approximately below 40°F (4°C), the Icy Road Warning Light and Outside Temperature Gauge blinks 10 times, and then illuminates. Also, the warning chime sounds 3 times.

Information

If the icy road warning light appears while driving, you should drive more attentively and safely refraining from over-speeding, rapid acceleration, sudden braking or sharp turning, etc.

Electronic Stability Control (ESC) Indicator



This indicator illuminates:

- When the Engine Start/Stop button is in the ON position.
 - It illuminates for approximately 3 seconds and then goes off.
- When there is a malfunction with the ESC system.
In this case, have the vehicle inspected by an authorized HYUNDAI dealer.

This indicator blinks:

While the ESC is operating.

For more information, refer to “Electronic Stability Control (ESC)” in chapter 5.

Electronic Stability Control (ESC) OFF Indicator



This indicator illuminates:

- When the Engine Start/Stop button is in the ON position.
 - It illuminates for approximately 3 seconds and then goes off.
- When you deactivate the ESC system by pressing the ESC OFF button.

For more information, refer to “Electronic Stability Control (ESC)” in chapter 5.

Electric Power Steering (EPS) Warning Light



This warning light illuminates:

- When the Engine Start/Stop button is in the ON position.
 - It illuminates for approximately 3 seconds and then goes off.
- When there is a malfunction with the EPS.
In this case, have the vehicle inspected by an authorized HYUNDAI dealer.

Immobilizer Indicator



This indicator illuminates up to 30 seconds:

- When the vehicle detects the smart key in the vehicle properly while the Engine Start/Stop button is in the ACC or ON position.
 - You can start the vehicle.
 - The indicator light goes off after starting the vehicle.

This indicator blinks for a few seconds:

- When the smart key is not in the vehicle.
 - You cannot start the vehicle.

This indicator illuminates for 2 seconds and goes off:

- When the Smart Key is not detected inside the vehicle, when the Engine Start/Stop button is in the ON position.

In this case, have the vehicle inspected by an authorized HYUNDAI dealer.

This indicator blinks:

- When the Smart Key battery is weak.
 - In this case, you cannot start the engine. However, by pressing the Engine Start/Stop button with the smart key, you may start the engine. **(For more information, refer to “Starting the Engine” in the chapter 5).**
- When there is a malfunction with the immobilizer system.

In this case, have the vehicle inspected by an authorized HYUNDAI dealer.

Automatic Transaxle Shift Indicator



This indicator displays where the automatic transaxle shift lever is located.

- Park : P
- Reverse : R
- Neutral : N
- Drive : D
- Sports Mode : 1, 2, 3, 4, 5, 6

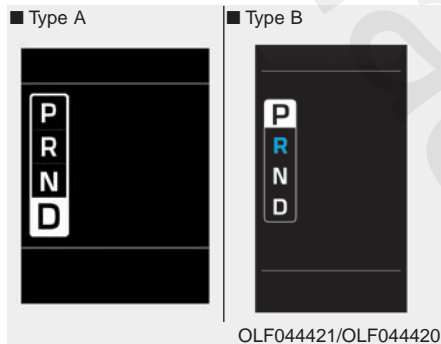

Shift Indicator Pop-up (if equipped)

The current shift lever location is displayed for 2 seconds when shifting into other shift lever locations.

Turn Signal Indicator

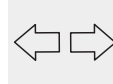

This indicator blinks:

- When you turn the turn signal light on.

If any of the following occurs, there may be a malfunction with the turn signal system. In this case, have the vehicle inspected by an authorized HYUNDAI dealer.

- The indicator does not blink but illuminates.
- The indicator blinks more rapidly.
- The indicator does not illuminate at all.

High Beam Indicator



This indicator illuminates:

- When the headlights are on and in the high beam position
- When the turn signal lever is in the Flash-to-Pass position.

Light ON Indicator



This indicator illuminates:

- When the tail lights and headlights are on.

Cruise Indicator Light

CRUISE

This indicator illuminates:

- When the cruise control system is ON.

For more information, refer to “Cruise Control System” in chapter 5.

Cruise SET Indicator

SET

This indicator illuminates:

- When the cruise control speed is set.

For more information, refer to “Cruise Control System” in chapter 5.

AUTO HOLD Indicator

**AUTO
HOLD**

This indicator illuminates:

- [White] When you activate the auto hold system by pressing the AUTO HOLD button.
- [Green] When you completely stop the vehicle by depressing the brake pedal with the auto hold system activated.
- [Yellow] When there is a malfunction with the auto hold system.
In this case, have the vehicle inspected by an authorized HYUNDAI dealer.

For more information, refer to “Auto Hold” in chapter 5.

SPORT Mode Indicator

SPORT

This indicator illuminates:

- When you select "SPORT" mode for your driving.

For more information, refer to “Drive Mode Integrated Control System” in chapter 5.

ECO Mode Indicator

ECO

This indicator illuminates:

- When you select “ECO” mode for your driving.

For more information, refer to “Drive Mode Integrated Control System” in chapter 5.

WARNING

Do not monitor the ECO indicator while driving. This may distract you, and may cause an accident, resulting in severe personal injury.

Forward Collision Warning System (FCWS) Warning Light (if equipped)



This warning light illuminates:

- When the FCWS is turned off on the User Settings mode.
- When there is a problem with the Forward Collision Warning System (FCWS).

When the warning light remains on, even though the FCWS is turned on, have the system checked by an authorized HYUNDAI dealer.

For more information, refer to “Forward Collision Warning System (FCWS)” in chapter 5.

Lane Departure Warning System (LDWS) Indicator (if equipped)



This indicator illuminates:

- [Green] When you activate the lane departure warning system by pressing the LDWS button.
- [White] When system operating conditions are not satisfied or when the sensor does not detect the lane line.
- [Yellow] When there is a malfunction with the lane departure warning system.

In this case, have your vehicle inspected by an authorized HYUNDAI dealer.

For more information, refer to “Lane Departure Warning System (LDWS)” in chapter 5.

Warning messages

Shift to "P" position

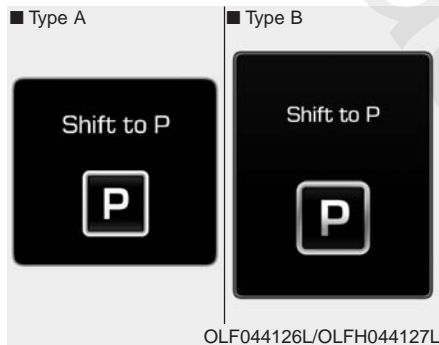

This warning message illuminates, when you attempt to turn OFF the vehicle without setting the shift lever in P (Park).

At this time, the Engine Start/Stop button turns to the ACC position (When you re-press the Engine Start/Stop button again, it will turn to the ON position).

Low Key Battery

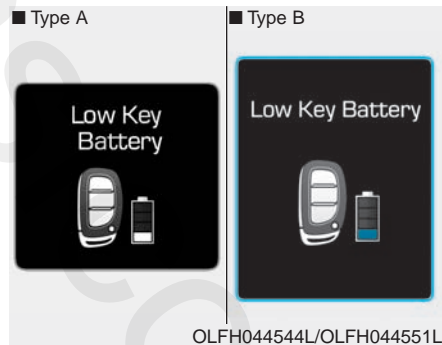

This warning message illuminates, when the Smart Key battery is discharged while turning the Engine Start/Stop button to the OFF position.

Press POWER button while turning wheel

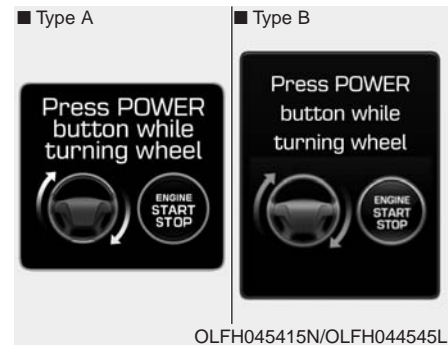

This warning message illuminates, when the steering wheel is fully turned to the left or right while pressing the Engine Start/Stop button.

Steering wheel unlocked

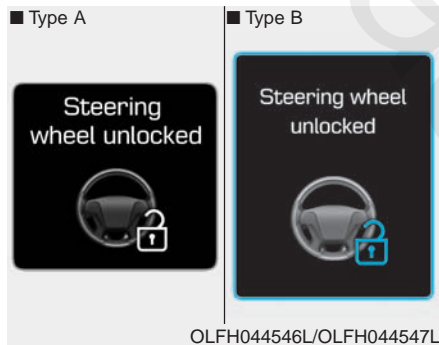

This warning message illuminates when the steering wheel does not lock while the Engine Start/Stop button changes to the OFF position.

Check steering wheel lock system

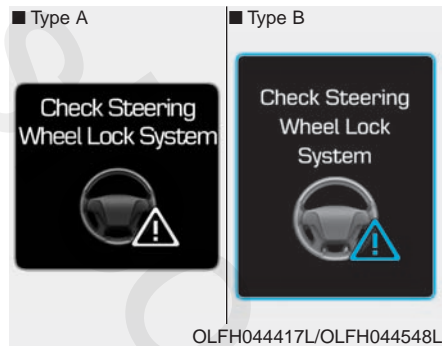

This warning message illuminates when the steering wheel does not lock normally while the Engine Start/Stop button changes to the OFF position.

Press brake pedal to start engine

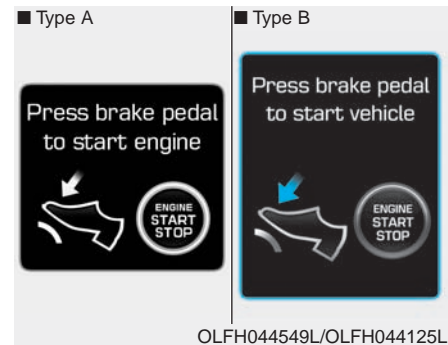

This warning message illuminates, when the Engine Start/Stop button changes to the ACC position twice by repeatedly pressing the button without depressing the brake pedal. You can start the vehicle by depressing the brake pedal

Key not in vehicle

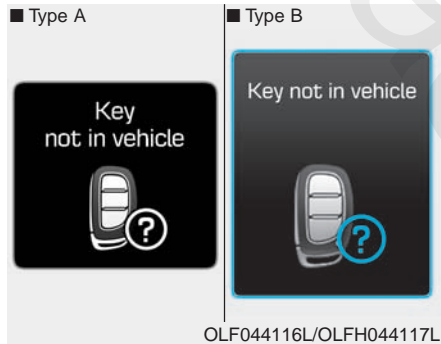

This warning message illuminates, when the Smart Key is out of the vehicle while pressing the Engine Start/Stop button.

You should always carry the Smart Key in your possession.

Key not detected

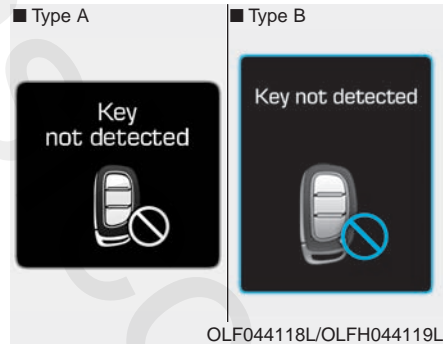

This warning message illuminates, when the Smart Key is not detected while pressing the Engine Start/Stop button.

Press start button again



This warning message illuminates, when you cannot operate the Engine Start/Stop button due to a malfunction with the Engine Start/Stop button.

You can start the vehicle by repressing the Engine Start/Stop button again.

When the warning message illuminates each time you press the Engine Start/Stop button, have your vehicle inspected by an authorized HYUNDAI dealer.

Press "START" button with key

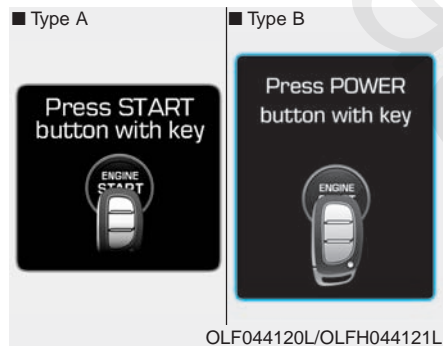

This warning message illuminates, when you press the Engine Start/Stop button while the warning message, "Key not detected," is displayed.

At this time, the immobilizer indicator light blinks.

Check "BRAKE SWITCH" fuse

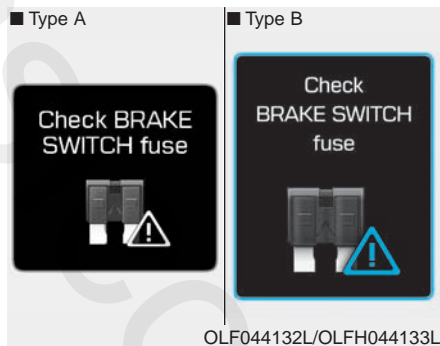

This warning message illuminates if the brake switch fuse is disconnected. You need to replace the fuse with a new one. If not possible, you can start the engine by pressing the Engine Start/Stop button for 10 seconds in the ACC position.

Shift to "P" to start engine

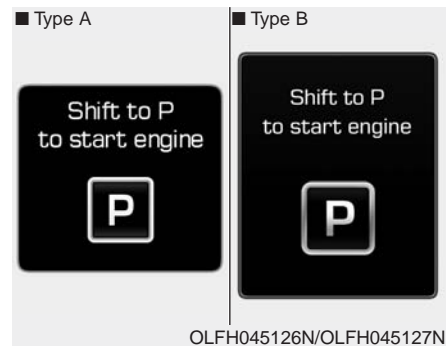

This warning message illuminates, when you try to start the vehicle with the shift lever not in P (Park).

Door, Hood, Trunk Open

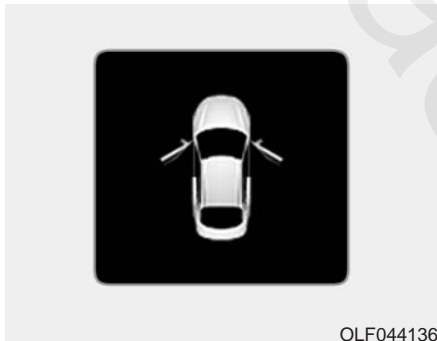

This warning illuminates, when any door, hood, or trunk is open.

Sunroof Open (if equipped)

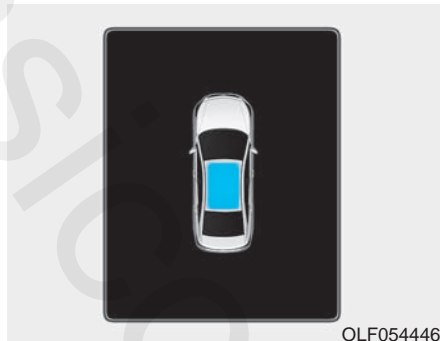

This warning illuminates, when the sunroof is opened, after turning OFF the vehicle.

Turn on "FUSE SWITCH"

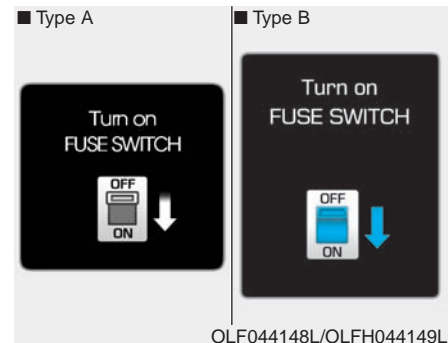

This warning message illuminates if the fuse switch in the instrument panel fuse, under the steering wheel is OFF.

You should turn ON the fuse switch.

For more information, refer to "Fuses" in chapter 7.

Align steering wheel (if equipped)



This warning message illuminates, when the steering wheel is turned by 90 degrees or wider, either to left or to right, while running the engine. You should align the steering wheel and narrow the steering wheel angle to be less than 30 degrees.

Steering wheel aligning is completed (if equipped)

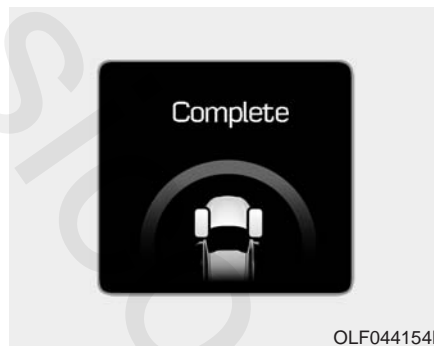

If the steering wheel aligning is completed after "Align steering wheel" warning message is displayed, this message is displayed for 2 seconds.

Low Washer Fluid



This warning message illuminates in the service reminder mode, when the washer fluid in the reservoir is nearly empty. You should refill the washer fluid.

Low Fuel

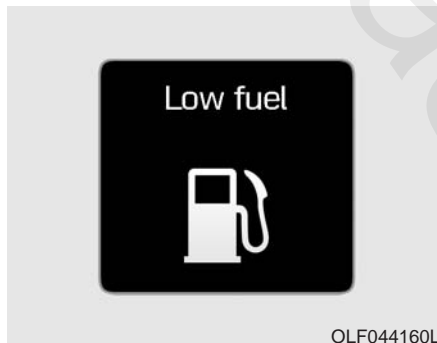

This warning message illuminates, when the fuel tank is nearly empty. You should refill the fuel tank.

Engine has overheated

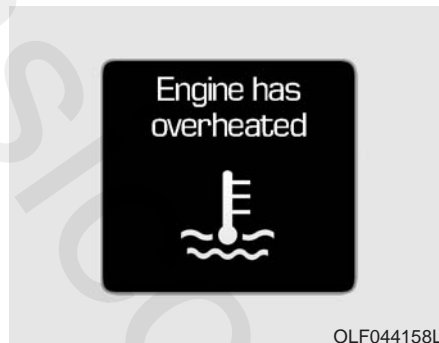

This warning message illuminates when the engine coolant temperature is above 120°C (248°F). This means that the engine is overheated and may be damaged.

If your vehicle is overheated, refer to “Overheating” in chapter 6.

Check headlight (if equipped)

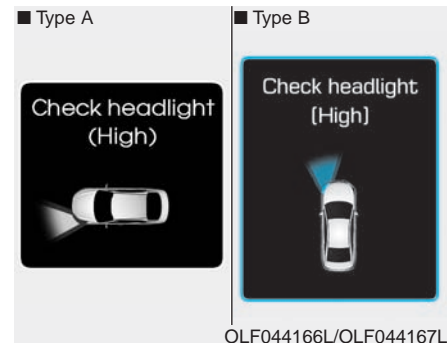

This warning message illuminates when there is a malfunction (burned-out bulb except LED lamp or circuit malfunction) with the headlamp. In this case, have your vehicle inspected by an authorized HYUNDAI dealer.

i Information

Make sure to replace the burned out bulb with a new one of the same wattage rating.

If not, this warning message will not be displayed.

Check Active Air Flap System

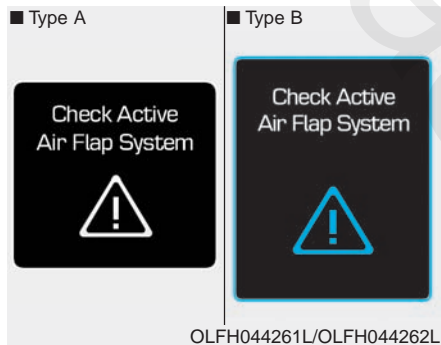

This warning message illuminates in the following situations:

- There is a malfunction with the actuator flap
- There is a malfunction with the actuator air flap controller
- The air flap does not open

When all of the above conditions are fixed, the warning will disappear.

Check Hybrid system

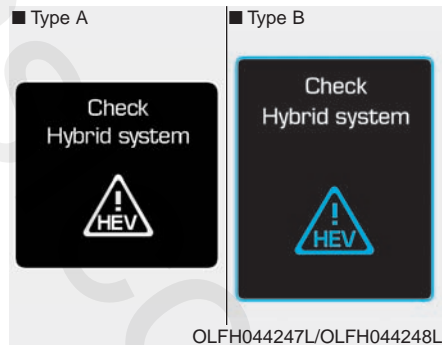

This warning message illuminates when there is a problem with the hybrid control system.

Refrain from driving when the warning message is displayed.

In this case, have your vehicle inspected by an authorized HYUNDAI dealer.

Check Hybrid system. Turn off engine.

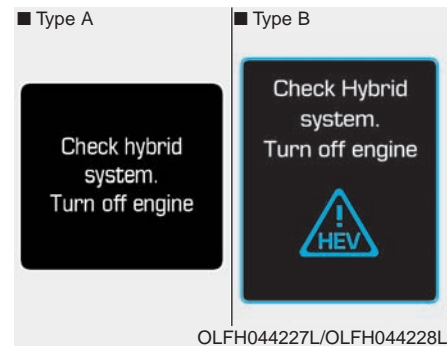

This warning message illuminates when there is a problem with the hybrid system. The "⚠️" indicator will blink and a warning chime will sound until the problem is solved.

In this case, have your vehicle inspected by an authorized HYUNDAI dealer.

Check Hybrid system. Do not start engine.

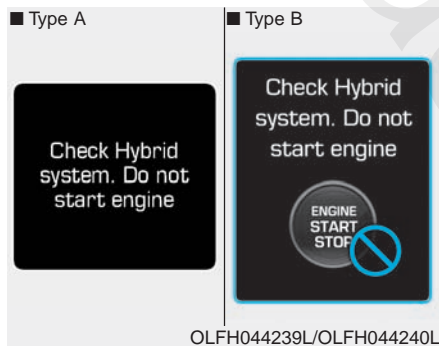

This warning message illuminates when the hybrid battery power (SOC) level is low. A warning chime will sound until the problem is solved. In this case, have your vehicle inspected by an authorized HYUNDAI dealer.

Stop vehicle and check power supply

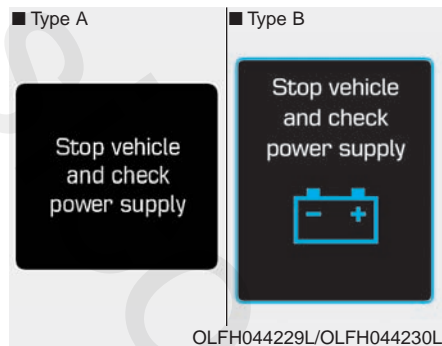

This warning message illuminates when a failure occurs in the power supply system. In this case, park the vehicle in a safe location and tow your vehicle to the nearest authorized HYUNDAI dealer and have the vehicle inspected.

Stop vehicle to charge battery

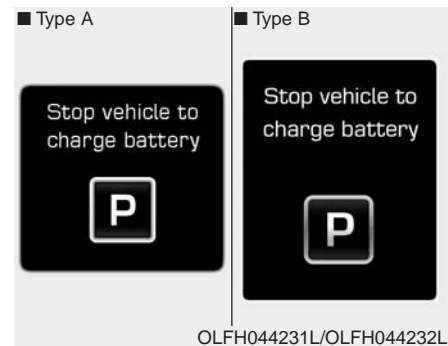

This warning message illuminates when the hybrid battery power (SOC) level is low.

In this case, park the vehicle in a safe location and wait until the hybrid battery is charged.

You can increase the hybrid battery charging rate by holding the accelerator pedal to the floor with transmission in P.

Refuel to prevent Hybrid battery damage

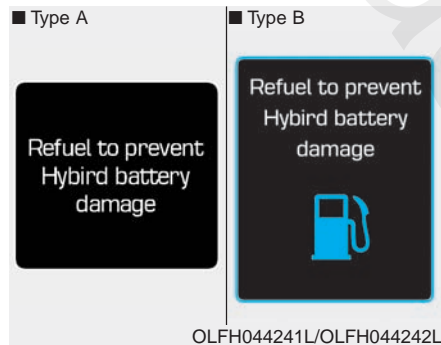

This warning message illuminates when the fuel tank is nearly empty. You should refill the fuel tank to prevent hybrid battery damage.

Refill inverter coolant

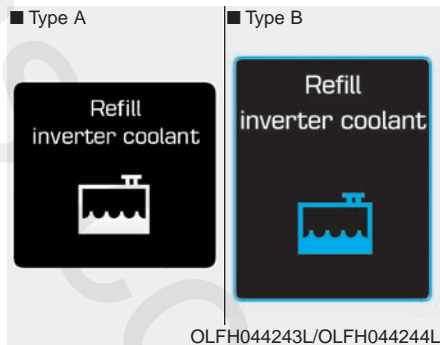

This warning message illuminates when the inverter coolant is nearly empty. You should refill the inverter coolant.

Stop vehicle and check brakes

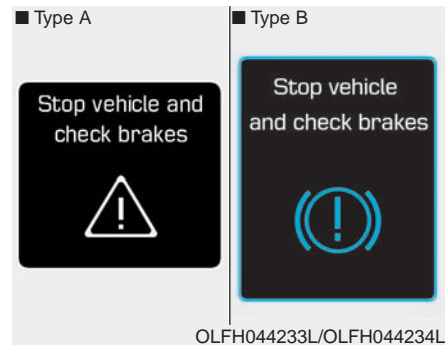

This warning message illuminates when a failure occurs in the brake system. In this case, park the vehicle in a safe location and tow your vehicle to the nearest authorized HYUNDAI dealer and have the vehicle inspected.

Check brakes

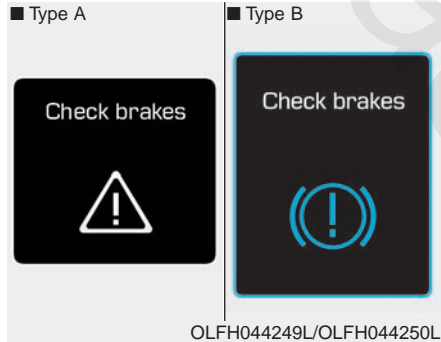

This warning message illuminates when the brake performance is low or the regenerative brake does not work properly due to a failure in the brake system.

In this case, it may take longer for the brake pedal to operate and the braking distance may become longer.

Check Virtual Engine Sound System

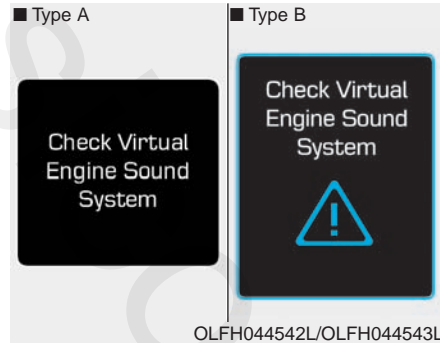

This message illuminates when there is a problem with the Virtual Engine Sound System (VESS).

In this case, have your vehicle inspected by an authorized HYUNDAI dealer.

Coasting guide (if equipped)

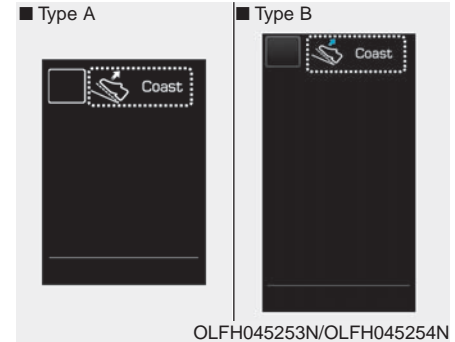

It informs the driver when to take the foot off from the accelerator by anticipating a decelerating event* based on the analysis of driving routes and road conditions of the navigation. It induces the driver to coast the vehicle on a road only with the electrical-motor power. This prevents unnecessary fuel consumption and increases fuel efficiency.

* Examples of decelerating events:
U-turn, turnings to the right/left, traffic circles, highway junctions, tollgates.

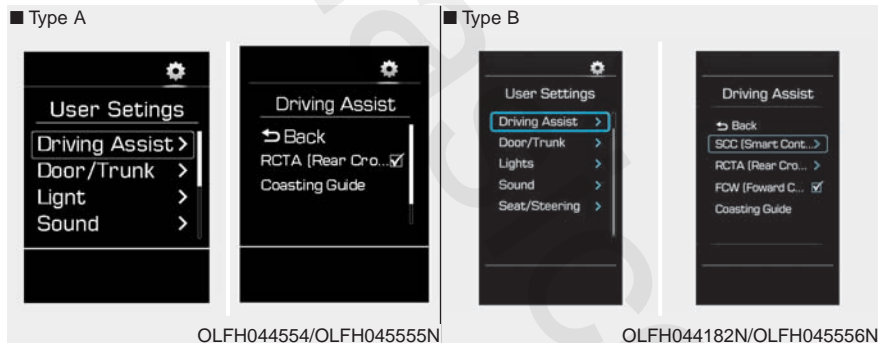

i Information

Coasting guide is only a supplemental system to assist with fuel-efficient driving. Thus, the operating conditions may be different in accordance with traffic/road conditions (i.e. driving in a traffic jam, driving on a slope, driving on a curve). Thus, take the actual driving conditions into consideration, such as distances from the vehicles ahead/behind, while referring to the coasting guide system as guidance.

- User settings

Press the Engine Start/Stop button and put the shift lever in P(Park). In the User Settings Mode, select Driving Assistance, and then Coasting Guide to turn on the system. Cancel the selection of coasting guide to turn off the system. For the explanation of the system, press and hold OK button.

- Operation conditions

To activate the system, take the following procedures. Enter your destination information on the navigation and select the driving route. Select the ECO mode in the Integrated Driving Control System. Then, satisfy the following.

- The driving speed should be between 37 mph (60 km/h) and 99 mph (160 km/h).

- * The operating condition (driving speed) varies in a situation, as there may be a difference in displaying the driving speeds between the instrument cluster and the navigation, and as there may be a difference between the actual driving speed and the driving speed display due to tire inflating ranges.

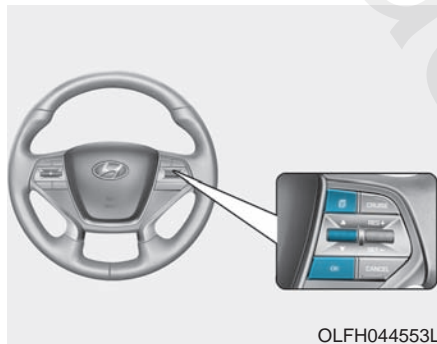

LCD Display

LCD display control











OLFH044553L

The LCD display modes can be changed by pressing the control buttons on the steering wheel.

- (1)  button : Changing LCD modes or returning to previous position
- (2)  ,  button : Changing items
- (3) OK button : Selecting or resetting

LCD modes

Modes	Symbol	Explanation
Trip Computer		This mode displays driving information like the tripmeter, fuel economy, etc. For more information, refer to "Trip Computer" in this chapter.
Turn By Turn (TBT) (if equipped)		This mode displays the state of the navigation.
SCC/LDWS (If equipped)		This mode displays the state of the Smart Cruise Control (SCC) and Lane Departure Warning System (LDWS). For more information, refer to "Smart Cruise Control (SCC)" and Lane Departure Warning System (LDWS) in chapter 5.
A/V (If equipped)		This mode displays the state of the A/V system.
Information	 or  or 	This mode displays the service interval (mileage or days) and warning messages related to the Blind Spot Detection system, etc.
User Settings		In this mode, you can change settings of the doors, lamps, etc.

Cannot edit settings while driving



This warning message illuminates when you try to select an item from the User Settings mode while driving. For your safety, change the User Settings mode after parking the vehicle, applying the parking brake and moving the shift lever to the P (Park) position.

Quick guide (if equipped)

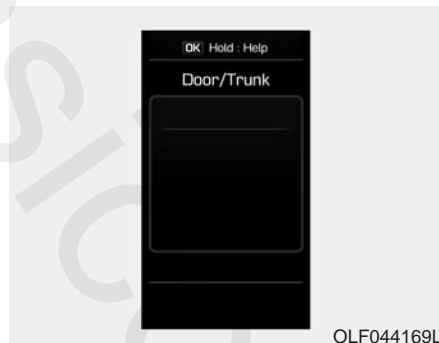

This mode provides quick guides for the systems in the User Settings mode.

Select an item, press and hold the OK button.

For more information about each system, refer to this Owner's Manual.

Trip computer mode

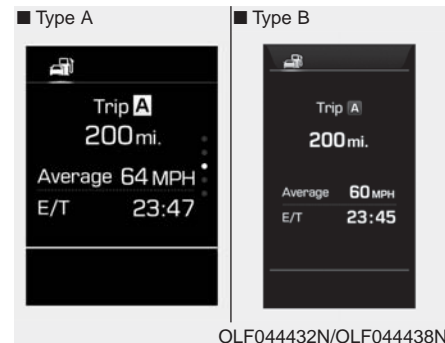

This mode displays driving information like the tripmeter, fuel economy, etc.

For more information, refer to "Trip Computer" in this chapter.

Turn By Turn (TBT) mode (if equipped)

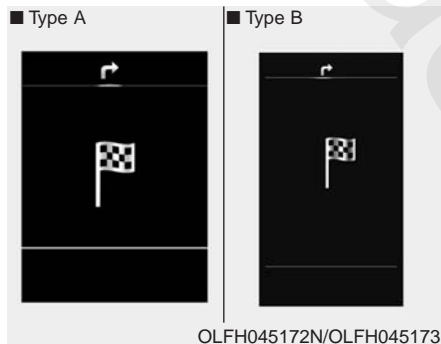

This mode displays the state of the navigation.

SCC/LDWS Mode (if equipped)



This mode displays the state of the Smart Cruise Control (SCC) and Lane Departure Warning System (LDWS).

A/V mode (if equipped)

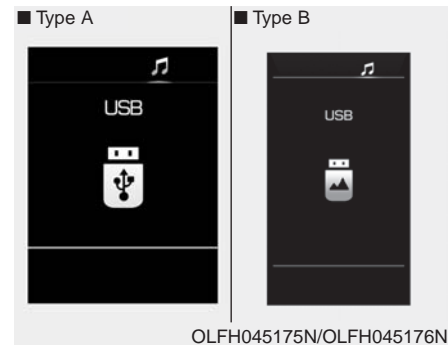

This mode displays the state of the A/V system.

For more information, refer to "Smart Cruise Control (SCC)" and "Lane Departure Warning System (LDWS)" in chapter 5.

Information mode

This mode displays the service interval (mileage and days).

For the setting of the service interval, refer to "User Settings Mode" of the LCD display.

Warning Message

If one of followings occurs, warning messages will be displayed in the information mode for about 10 seconds.

- Malfunction of the Forward Collision Warning System (FCWS)
- Malfunction of the Smart Cruise Control (SCC)
- Malfunction of the Lane Departure Warning System (LDWS)
- Malfunction of the Blind Spot Detection (BSD)
- Low washer fluid

Service Interval



Service in

It calculates and displays the maintenance schedule (mileage or days), as set in the system.

When the set mileages or days passed, "Service in" message is displayed for several seconds each time the Engine Start/Stop button is turned ON.

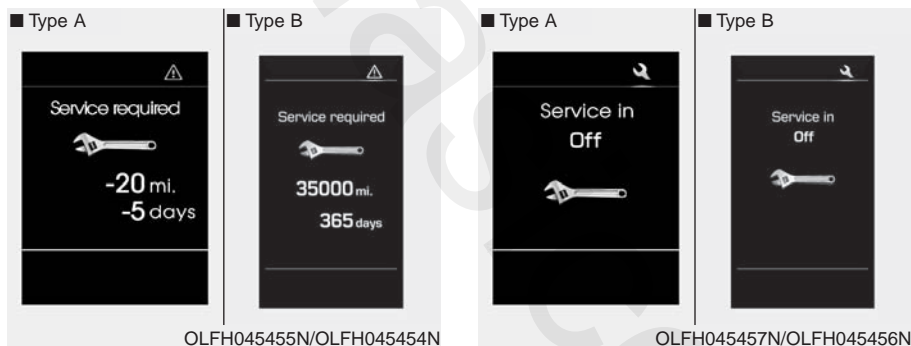

Service required

When you fail to have your vehicle serviced according to the already inputted service interval, "Service required" message is displayed for several seconds each time you turn ON the Engine Start/Stop button.

To reset the service interval in mileages or days that you initially set:

- Press the OK button for more than 1 second.

Service in OFF

When the service interval is not set, "Service in Off" message is displayed on the LCD display.

Information

If any of the following conditions occurs, the mileage and days may be incorrect.

- The battery cable is disconnected.
- The fuse switch is turned off.
- The battery is discharged.

User settings mode

In this mode, you can change setting of the instrument cluster, doors, lamps, and so on.

Driving Assist (if equipped)

Items	Explanation
RCTA (Rear Cross Traffic Alert)	To activate or deactivate the RCTA system. For more information, refer to "Rear Cross Traffic Alert (RCTA)" in chapter 5.
SCC (Smart Cruise Control)	To adjust the sensitivity (Slow/Normal/Fast) of the Smart Cruise Control system. For more information, refer to "Smart Cruise Control (SCC)" in chapter.
FCWS (Forward Collision Warning System)	To activate or deactivate the Forward Collision Warning System. For more information, refer to "Forward Collision Warning System (FCWS)" in chapter.

Door / Trunk

Items	Explanation
Automatically Lock	<ul style="list-style-type: none"> • Off : The auto door lock function is deactivated. • Enable on Speed: All doors will be automatically locked when the vehicle speed exceeds 15 km/h (9.3mph). • Enable on Shift: All doors will be automatically locked when the automatic transaxle shift lever is shifted from P (Park) to the R (Reverse), N (Neutral), or D (Drive).
Automatically Unlock	<ul style="list-style-type: none"> • Off : The auto door unlock function is deactivated. • Vehicle Off: All doors will be automatically unlocked when the Engine Start/Stop button is placed to the OFF position. • Driver Door Unlock: All doors will be automatically unlocked when the driver's door is unlocked. • On Shift to P: All doors will be automatically unlocked when the automatic transaxle shift lever is shifted to P (Park).
Two Press Unlock	<ul style="list-style-type: none"> • OFF : The two press unlock function will be deactivated. Therefore, all doors will unlock if the door is unlocked. • ON : The driver's door will unlock if the door is unlocked. When the door is unlocked again within 4 seconds, all doors will unlock.
Door Lock Sound	To activate or deactivate the lock sound when locking doors.
Smart Trunk	To activate or deactivate the Smart Trunk system. For more information, refer to "Smart Trunk" in this chapter.

Light

Items	Explanation
One Touch Turn Signal	<ul style="list-style-type: none"> • Off: The one touch turn signal function is deactivated. • 3, 5, 7 Flashes : The lane change signals will blink 3, 5, or 7 times when the turn signal lever is slightly operated. <p>For more information, refer to “Light” in this chapter.</p>
Head Lamp Delay	<ul style="list-style-type: none"> • On: The head lamp delay function is activated. • Off: The headlamp delay function is deactivated. <p>For more information, refer to “Light” in this chapter.</p>
Welcome Light	<ul style="list-style-type: none"> • On: The welcome light function is activated. • Off: The welcome light function is deactivated. <p>For more information, refer to “Welcome System” in this chapter.</p>

Sound

Items	Explanation
Park Assist System vol.	<ul style="list-style-type: none"> • Adjust the Park Assist System Volume (Level 1 to 3).
BSD (Blind Spot Detection) Sound	<ul style="list-style-type: none"> • Off : The BSD sound function is deactivated. • On : The BSD sound function is activated.
Welcome Sound	<ul style="list-style-type: none"> • Off : The welcome sound function is deactivated. • On : The welcome sound function is activated.

Seat / Steering

Items	Explanation
Seat Easy Access	<ul style="list-style-type: none">• None: The seat easy access function is deactivated.• Normal/Extended:<ul style="list-style-type: none">- When you turn off the engine, the driver's seat will automatically move rearward short (Normal) or long (Extended) for you to enter or exit the vehicle more comfortably.- If you change the Engine Start/Stop button from OFF position to the ACC, ON, or START position, the driver's seat will return to the original position. <p>For more information, refer to “Driver Position Memory System” in this chapter.</p>

Service interval

Items	Explanation
Service Interval	<ul style="list-style-type: none">• Off : The service interval function is deactivated.• On :You can set the service interval (mileage and months).

Other features

Items	Explanation
Fuel Economy Auto Reset	<ul style="list-style-type: none"> • Off : The average fuel economy will not automatically reset whenever refueling. • On (Auto Reset) : The average fuel economy will automatically reset when refueling. <p>For more information, refer to “Trip Computer” in this chapter.</p>
Shift gear Pop-up	<p>To activate or deactivate the shift gear pop-up function.</p> <p>For more information, refer to “Warning and indicator lights” in this chapter.</p>
Fuel Economy Unit	Choose the fuel economy unit. (US gallon, UK gallon)
Temperature Unit	Choose the temperature unit. (°C,°F)
Tire Pressure Unit	Choose the tire pressure unit. (psi, kPa, Bar)
Language	Choose the language.

Trip computer

The trip computer is a driving information system controlled by a micro-computer. This displays driving-related information.

i Information

Some driving information, stored in the trip computer (i.e. average vehicle speed) is reset when the battery is disconnected

One time driving information mode

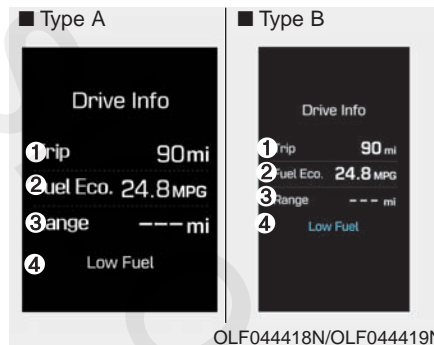

The driving information mode displays tripmeter (1), average fuel economy (2), and estimated distance to empty (3).

The information is displayed for a few seconds when the vehicle is turned OFF. The information is calculated after each trip.

When the estimated distance to empty is less than 1 mile (1 km), the driving information mode displays "---" and "Low fuel" (4) message will appear.

i Information

If "Sunroof Open" warning message is displayed in the cluster, this mode may not be displayed.

Trip modes

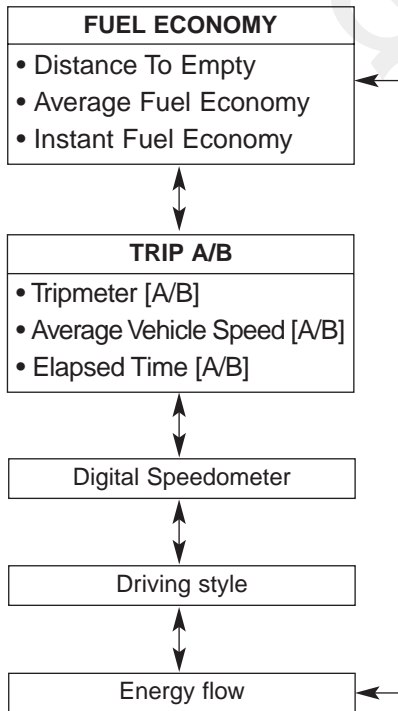

To change the trip mode, rotate "▲, ▼" switch on the steering wheel.

Trip A/B

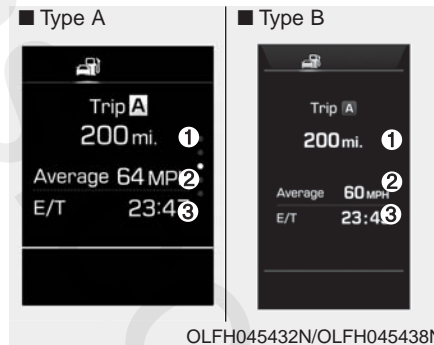

Tripmeter (1)

- The tripmeter is the total driving distance since the last tripmeter reset.
 - Distance range: 0.0 ~ 9999.9 mi. or km
- To reset the tripmeter, press the [OK] button on the steering wheel for more than 1 second when the tripmeter is displayed.

Average Vehicle Speed (2)

- The average vehicle speed is calculated by the total driving distance and driving time since the last average vehicle speed reset.
 - Speed range: 0 ~ 999 MPH or km/h
- To reset the average vehicle speed, press the [OK] button on the steering wheel for more than 1 second when the average vehicle speed is displayed.

i Information

- **The average vehicle speed is not displayed, when the vehicle drives shorter than 0.19 miles (300 meters) or less than 10 seconds after turning ON the Engine Start/Stop button.**
- **Even though the vehicle is not in motion, the average vehicle speed keeps being recorded while running the engine.**

Elapsed Time (3)

- The elapsed time is the total driving time since the last elapsed time reset.
 - Time range (hh:mm): 00:00 ~ 99:59
- To reset the elapsed time, press the [OK] button on the steering wheel for more than 1 second when the elapsed time is displayed.

i Information

Even though the vehicle is not in motion, the elapsed time keeps being recorded, while the engine is running.

Fuel economy

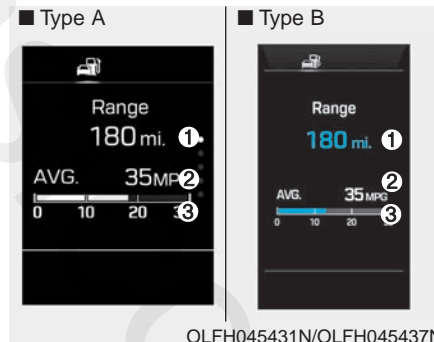

Distance To Empty (1)

- The distance to empty is the estimated distance the vehicle can drive with the remaining fuel.
 - Distance range: 1 ~ 9999 mi. or 1 ~ 9999 km
- When the estimated distance to empty is less than 1 mile (1 km), the trip computer displays "---" .

i Information

- When the vehicle is not on level ground, or when the battery power is interrupted, the distance to empty may not be correctly calculated.
- The distance to empty may differ from the actual distance, as it is estimated with the calculable driving distance.
- The trip computer may not recognize additional fuel adding, when less than 1.6 gallons (6 liters) of fuel is added.
- The fuel economy and distance to empty may significantly vary in accordance with driving conditions, driving habits, and vehicle conditions.

Average Fuel Economy (2)

- The average fuel economy is calculated by the total driving distance and fuel consumption since the last average fuel economy reset.
 - Fuel economy range: 0.0 ~ 99.9 MPG or L/100km or km/L
- The average fuel economy can be reset both manually and automatically.

Manual reset

To manually reset the average fuel economy, press the OK button on the steering wheel for more than 1 second, when the average fuel economy is displayed.

For more information about the OK button, refer to "LCD Display Control" in this chapter.

Automatic reset

To automatically reset the average fuel economy after refueling, select the "Auto Reset" mode in User Settings menu on the LCD display (**Refer to "LCD Display" in this chapter.**)

In "Auto Reset" mode, the average fuel economy will be reset to zero (---), when driving speed exceeds 1 km/h, after adding 1.6 gallons (6 liters) of fuel or more.

i Information

The average fuel economy may be inaccurate when the vehicle drives shorter than 0.19 miles (300 meters) after turning ON the Engine Start/Stop button.

Instant Fuel Economy (3)

- This mode displays the instant fuel economy during the last few seconds when vehicle speed exceeds 6.2 MPH (10 km/h).
 - Fuel economy range: 0 ~ 50 MPG or 0 ~ 30 L/100km

Digital Speedometer

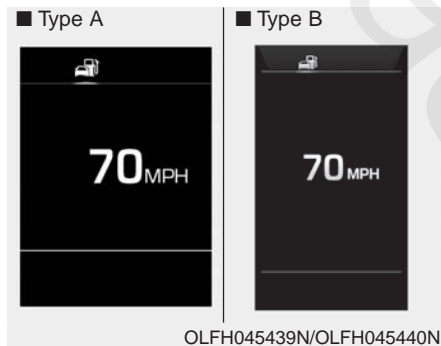

This message shows the speed of the vehicle (km/h, MPH).

Driving style

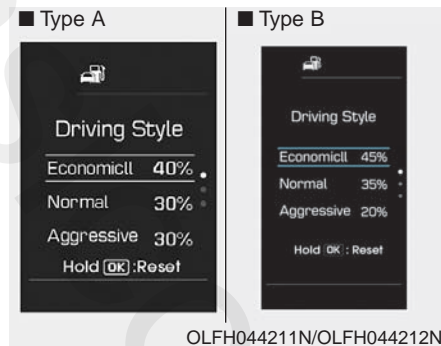

The driving style is displayed when you select "ECO" mode by pressing the DRIVE MODE button.

When the SPORT or NORMAL mode is selected for your driving, each driving category will be displayed with "--".

Energy flow (for Hybrid Electric Vehicle)

The hybrid system informs the drivers its energy flow in various operating modes. While driving, the current energy flow is specified in 11 modes.

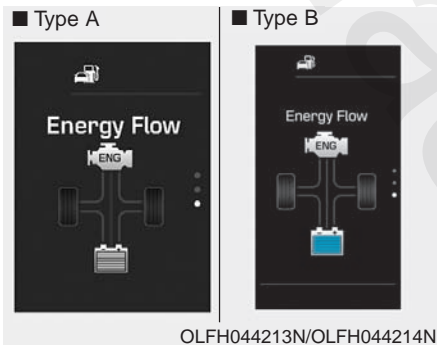

Vehicle Stop

The vehicle is stopped.
(No energy flow)

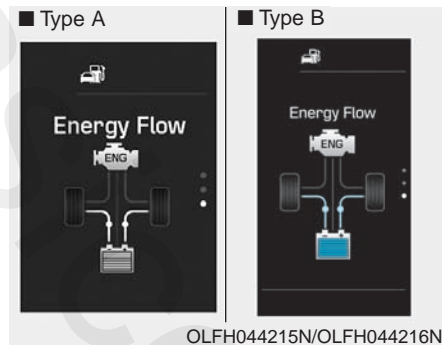

EV Propulsion

Only the motor power is used to drive the vehicle.
(Battery → Wheel)

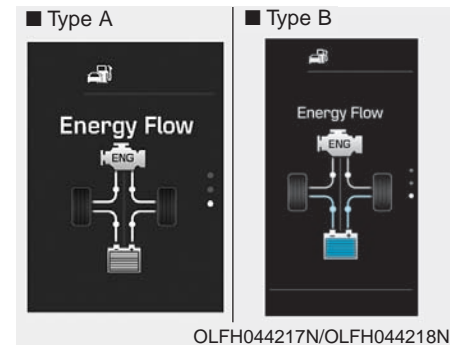

Power Assist

Both the motor and the engine power are used to drive the vehicle.
(Battery & Energy → Wheel)

Convenient features of your vehicle

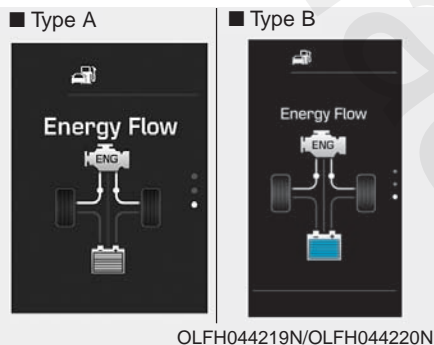

Engine Only Propulsion

Only the engine power is used to drive the vehicle.
(Engine → Wheel)

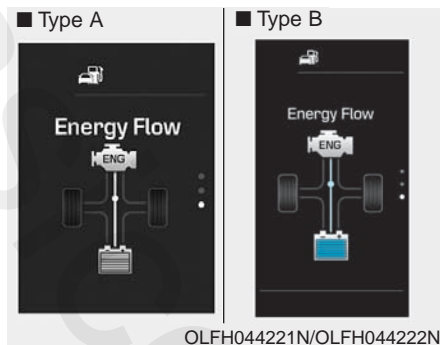

Engine Generation

When the vehicle is stopped, the high-voltage battery is charged up by the engine.
(Engine → Battery)

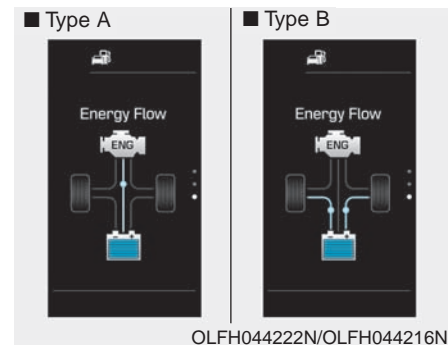

Regeneration

The high-voltage battery is charged up by the regenerative brake system.
(Wheel → Battery)

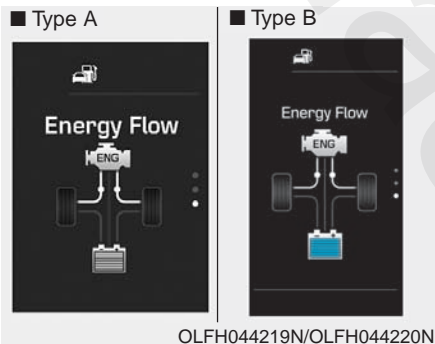

Engine Brake

The engine braking is used to decelerate the vehicle.

(Wheel → Engine)

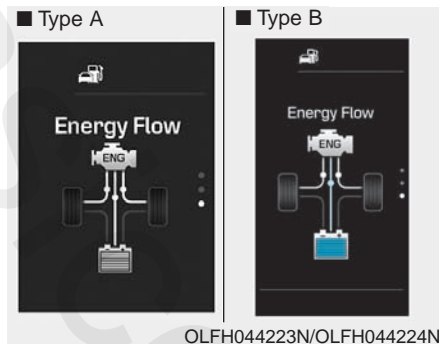

Power Reserve

The engine is simultaneously used to drive the vehicle and to charge up the high-voltage battery.

(Engine → Wheel & Battery)

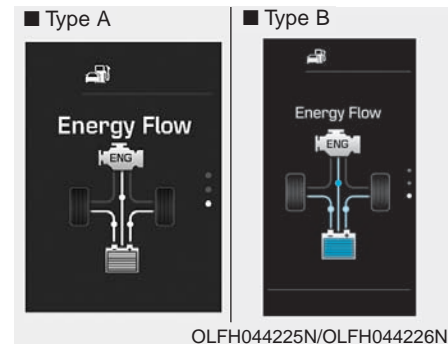

Engine Generation/Motor Drive

The engine charges up the high-voltage battery. The motor power is used to drive the vehicle.

(Engine → Battery → Wheel)

Convenient features of your vehicle

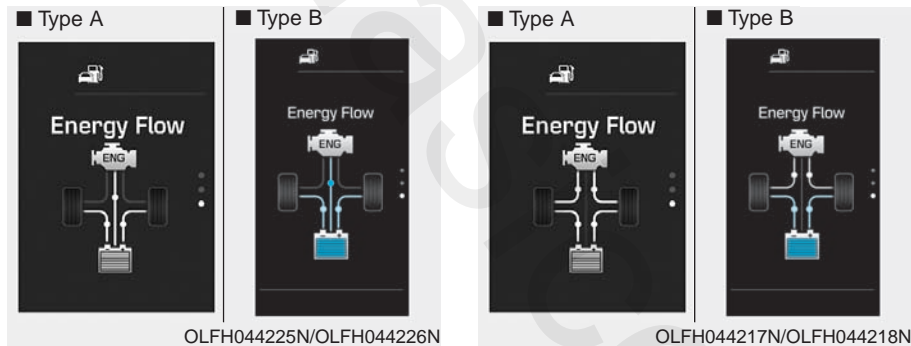

Engine Generation/Regeneration

The engine and regenerative brake system charges up the high-voltage battery.

(Engine & Wheel → Battery)

Engine Brake/Regeneration

The engine braking is simultaneously used to decelerate the vehicle and to charge up the high-voltage battery.

(Wheel → Engine & Battery)

LIGHT

Exterior Lights

Lighting control

To operate the lights, turn the knob at the end of the control lever to one of the following positions:

■ Type A

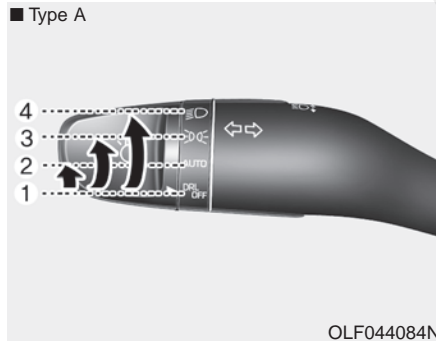

- (1) DRL OFF position
- (2) AUTO light position
- (3) Parking lamp position
- (4) Headlamp position

■ Type B

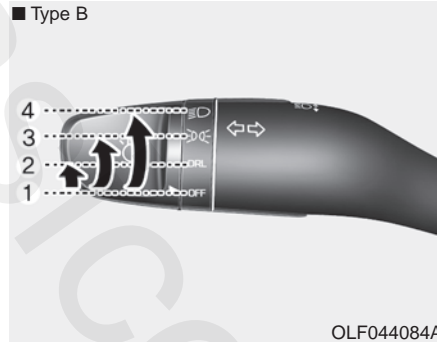

- (1) OFF position
- (2) DRL position
- (3) Parking lamp position
- (4) Headlamp position

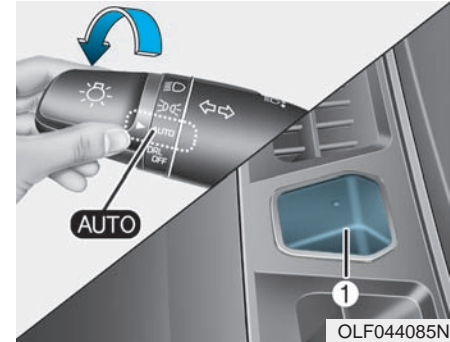

AUTO light position (if equipped)

The parking lamp and headlamp will be turned ON or OFF automatically depending on the amount of light outside the vehicle.

Even with the AUTO light feature in operation, it is recommended to manually turn ON the lamps when driving at night or in a fog, or when you enter dark areas, such as tunnels and parking facilities.

NOTICE

- Do not cover or spill anything on the sensor (1) located in front of the instrument panel.
- Do not clean the sensor using a window cleaner, the cleanser may leave a light film which could interfere with sensor operation.
- If your vehicle has window tint or other types of metallic coating on the front windshield, the AUTO light system may not work properly.



OLF044086N

Parking lamp position (☞☞)

The parking lamp, license plate lamp and instrument panel lamp are turned ON.



OLF044087N

Headlamp position (☞)

The headlamp, parking lamp, license plate lamp and instrument panel lamp are turned ON.

i Information

Engine Start/Stop button is in the ON position to turn on the headlamp.

High beam operation

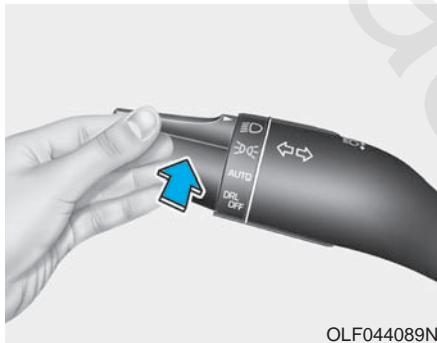

To turn on the high beam headlamp, push the lever away from you. The lever will return to its original position. The high beam indicator will light when the headlamp high beams are switched on.

To turn off the high beam headlamp, pull the lever towards you. The low beams will turn on.

WARNING

Do not use high beam when there are other vehicles approaching you. Using high beam could obstruct the other driver's vision.



To flash the high beam headlamp, pull the lever towards you, then release the lever. The high beams will remain ON as long as you hold the lever towards you.

Smart High Beam (if equipped)

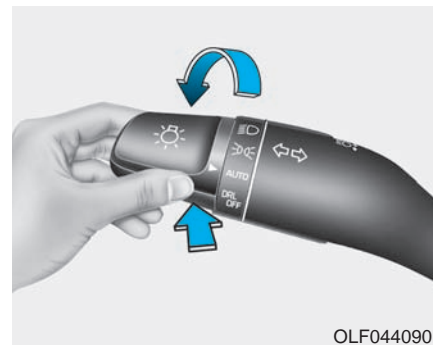

The Smart High Beam is a system that automatically adjusts the headlamp range (switches between high beam and low beam) according to the brightness of other vehicles and road conditions.

Operating condition

1. Place the light switch in the AUTO position.
2. Turn on the high beam by pushing the lever away from you.

The smart high beam () indicator will illuminate.

3. The Smart High Beam will turn on when vehicle speed is above 28 mph (45km/h).

- If the lever is pushed away when the Smart High Beam is operating, the Smart High Beam will turn off and the high beam will be on continuously. The smart high beam () indicator will turn off.
 - If the lever is pulled towards you when the Smart High Beam is operating, the Smart High Beam will turn off.
4. If the light switch is placed to the headlamp position, the Smart High Beam will turn off and the low beam will be on continuously.

The high beam switches to low beam in the below conditions.

- When the Smart High Beam is off.
- When the light switch is not in the AUTO position.
- When the headlamp is detected from the on-coming vehicle.
- When the tail lamp is detected from the front vehicle.
- When the surrounding is bright enough high beams are not needed.
- When streetlights or other lights are detected.
- When vehicle speed is below 18 mph (35km/h).

Warning light and message

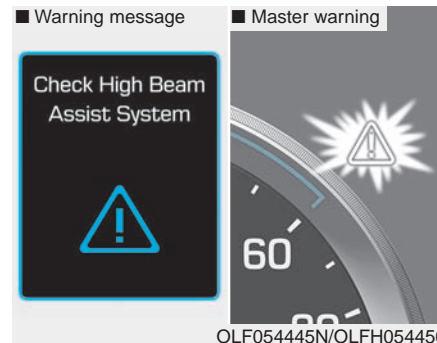

When the Smart High Beam Assist System is not working properly, the warning message will come on for a few second. After the message disappears, the master warning light will illuminate. Take your vehicle to an authorized HYUNDAI dealer and have the system checked.

 **CAUTION**

The system may not operate normally in the below conditions.

- When the light from the on-coming or front vehicle is not detected because of lamp damage, hidden from sight, etc.
- When the lamp of the on-coming or front vehicle is covered with dust, snow or water.
- When the light from the on-coming or front vehicle is not detected because of exhaust fume, smoke, fog, snow, etc.
- When the front window is covered with foreign matters such as ice, dust, fog, or is damaged.

(Continued)

(Continued)

- When there is a similar shape lamp with the front vehicle's lamps.
- When it is hard to see because of fog, heavy rain or snow.
- When the headlamp is not repaired or replaced at an authorized dealer.
- When headlamp aiming is not properly adjusted.
- When driving on a narrow curved road or rough road.
- When driving downhill or uphill.
- When only part of the vehicle in front is visible on a cross-road or curved road.
- When there is a traffic light, reflecting sign, flashing sign or mirror.

(Continued)

(Continued)

- When the road conditions are bad such as being wet or covered with snow.
- When the front vehicle's headlamps are off but the fog lamps on.
- When a vehicle suddenly appears from a curve.
- When the vehicle is tilted from a flat tire or being towed.
- When the LDWS (Lane Departure Warning System) warning light illuminates. (if equipped)

⚠ WARNING

- Do not place any accessories, stickers or tint the windshield.
- Have the windshield glass replaced from an authorized dealer.
- Do not remove or impact related parts of the Smart High Beam system.
- Be careful that water doesn't get into the Smart High Beam unit.
- Do not place objects on the dashboard that reflects light such as mirrors, white paper, etc. The system may malfunction if sunlight is reflected.
- At times, the Smart High Beam system may not work properly, always check the road conditions for your safety. When the system does not operate normally, manually change between the high beam and low beam.

Turn signals and lane change signals

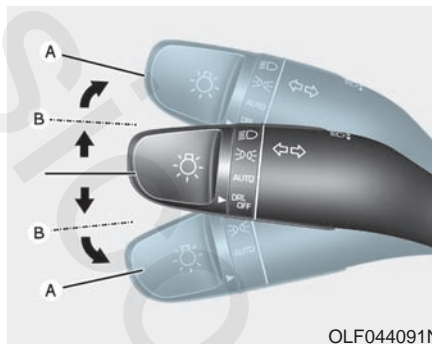

To signal a turn, push down on the lever for a left turn or up for a right turn in position (A). To signal a lane change, move the turn signal lever slightly and hold it in position (B). The lever will return to the OFF position when released or when the turn is completed.

If an indicator stays on and does not flash or if it flashes abnormally, one of the turn signal bulbs may be burned out and will require replacement.

Onetouch turn signal function

To activate an One Touch Turn Signal function, move the turn signal lever slightly and then release it. The lane change signals will blink 3, 5 or 7 times.

You can activate or deactivate the One Touch Turn Signal function or choose the number of blinking (3, 5, or 7) from the User Settings Mode (Light) on the LCD display.

For more information, refer to the "LCD Display" section in this chapter.

Battery saver function

The purpose of this feature is to prevent the battery from being discharged. The system automatically turns off the parking lamp when the driver turns the engine off and opens the driver-side door.

With this feature, the parking lamps will turn off automatically if the driver parks on the side of road at night.

If necessary, to keep the lamps on when the engine is turned off, perform the following:

- 1) Open the driver-side door.
- 2) Turn the parking lamps OFF and ON again using the light switch on the steering column.

Headlamp delay function (if equipped)

If engine Start/Stop button is in the ACC or OFF position with the headlamps ON, the headlamps (and/or parking lamps) remain on for about 5 minutes. However, if the driver's door is opened and closed, the headlamps are turned off after 15 seconds. However, with the engine off if the driver's door is opened and closed, the headlamps (and/or parking lamps) are turned off after 15 seconds.

The headlamps (and/or parking lamps) can be turned off by pressing the lock button on the smart key twice or turning the light switch to the OFF or AUTO position. However, if you turn the light switch to the AUTO position when it is dark outside, the headlamps will not be turned off.

You can activate or deactivate the Headlamp Delay function from the User Settings Mode (Light) on the LCD display.

For more information, refer to the "LCD Display" section in this chapter.

NOTICE

If the driver gets out of the vehicle through other doors (except driver's door), the battery saver function does not operate and the headlamp delay function does not turn off automatically. Therefore, it causes the battery to be discharged. In this case, make sure to turn off the lamp before getting out of the vehicle.

Daytime running light (DRL)

The Daytime Running Lights (DRL) can help for others to see the front of your vehicle during the day, especially after dawn and before sunset.

for U.S.A

The DRL will turn off when:

- Type A
 1. The light switch is not in the AUTO position.
 2. The parking brake is applied.
 3. The engine is turned off.
- Type B
 1. The light switch is not in DRL position.
 2. The parking brake is applied.
 3. The engine is turned off.

for Canada

The DRL will turn off when:

1. The light switch is in the headlamp position, including the operation that the headlamp is turned on automatically in the AUTO light position.
2. The parking brake is applied.
3. The engine is turned off.

Welcome System (if equipped)

Welcome light

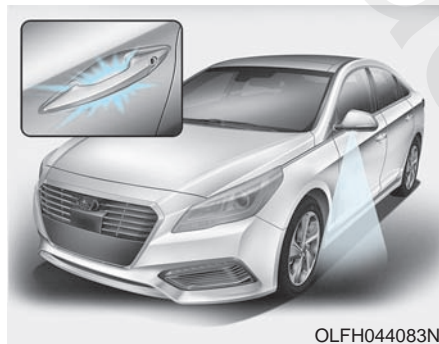

OLFH044083N

Door handle lamp (if equipped)

When all the doors (and trunk) are closed and locked, the door handle lamp will come on for about 15 seconds if any of the below is performed.

- When the door unlock button is pressed on the smart key.
- When the button of the outside door handle is pressed.
- When the vehicle is approached with the smart key in possession.

Headlamp and Parking lamp

When the headlamp (lamp switch in the headlamp or AUTO position) is on and all doors (and trunk) are locked and closed, the parking lamp and headlamp will come on for 15 seconds if/or any of the below is performed.

- When the door unlock button is pressed on smart key.

At this time, if you press the door lock or unlock button on the smart key the parking lamp and headlamp will turn off immediately.

You can activate or deactivate the Welcome Light from the User Settings Mode (Light) on the LCD display.

For more information, refer to the "LCD Display" section in this chapter.

Interior lamp

When the interior lamp switch is in the DOOR position and all doors (and trunk) are closed and locked, the room lamp will come on for 30 seconds if any of the below is performed.

- When the door unlock button is pressed on the smart key.
- When the button of the outside door handle is pressed.

At this time, if you press the door lock or unlock button on the smart key the room lamp will turn off immediately.

Interior Lights

WARNING

Do not use the interior lights when driving in the dark. The interior lights may obscure your view and cause an accident.

NOTICE

Do not use the interior lights for extended periods when the engine is turned off or the battery will discharge.

Interior lamp AUTO cut

The interior lamps will automatically go off approximately 20 minutes after the engine is turned off and the doors closed. If a door is opened, the lamp will go off 40 minutes after the engine is turned off. If the doors are locked by the smart key and the vehicle enters the armed stage of the theft alarm system, the lamps will go off five seconds later.

Front lamps

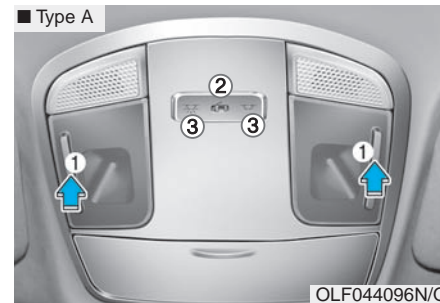

- (1) Front Map Lamp
- (2) Front Door Lamp
- (3) Front Room Lamp

Front Map Lamp:

Press either of these lens (1) to turn the map lamp on or off. This light produces a spot beam for convenient use as a map lamp at night or as a personal lamp for the driver and the front passenger.

Front Door Lamp :

The front or rear room lamps come on when the front or rear doors are opened if the engine is running or not. When doors are unlocked by the smart key, the front and rear lamps come on for approximately 15 seconds as long as any door is not opened. The front and rear room lamps go out gradually after approximately 15 seconds if the door is closed. However, if engine Start/Stop button is in the ON position, or all doors are locked, the front and rear lamps will turn off immediately.

If a door is opened with the ignition switch in the ACC position or the LOCK/OFF position, the front and rear lamps stay on for about 20 minutes. However, if a door is opened with engine Start/Stop button is in the ON position the lamps stays on continuously.

Front Room Lamp:

• Type A

 : Press this switch to turn the front and rear room lamps on.

 : Press this switch to turn the front and rear room lamps off.

• Type B

 : Press this switch to turn the front and rear room lamps on and off.

Rear lamps

■ Type A

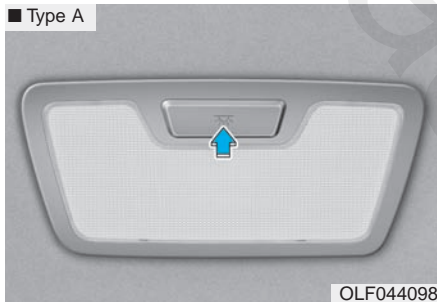

■ Type B



Rear Room Lamp :

Press this switch to turn the room lamp on and off.

Trunk room lamp

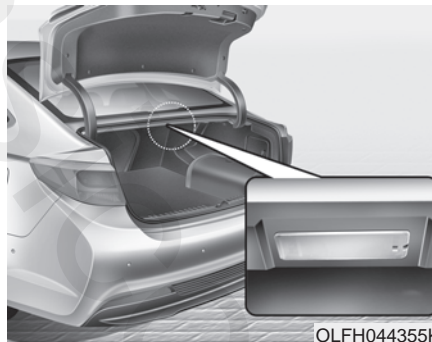

The trunk room lamp comes on when the trunk is opened.

NOTICE

The trunk lamp comes on as long as the trunk lid is open. To prevent unnecessary charging system drain, close the trunk lid securely after using the trunk.

Door courtesy lamp

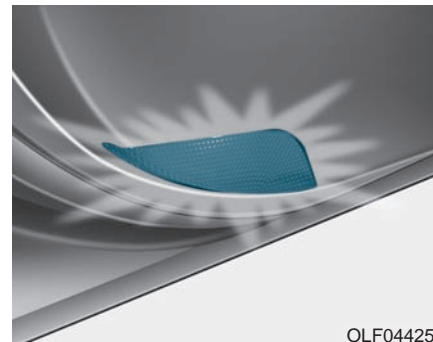

The door courtesy lamp comes ON when the door is opened to assist entering or exiting the vehicle. It also serves as a warning to passing vehicles that the vehicle door is open.

When engine Start/Stop button is in the ACC or OFF position, the door courtesy lamp turns off after 20 minutes.

Glove box lamp

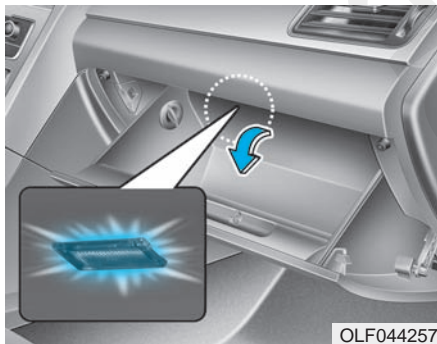

The glove box lamp comes on when the glove box is opened.

If the glove box is not closed, the lamp will turn off after 20 minutes.

NOTICE

To prevent unnecessary charging system drain, close the glove box securely after using the glove box.

Vanity mirror lamp

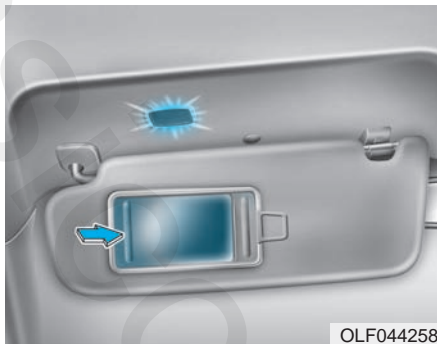

Opening the lid of the vanity mirror will automatically turn on the mirror light.

NOTICE

To prevent unnecessary charging system drain, close the vanity mirror cover after using the mirror.

WIPERS AND WASHERS

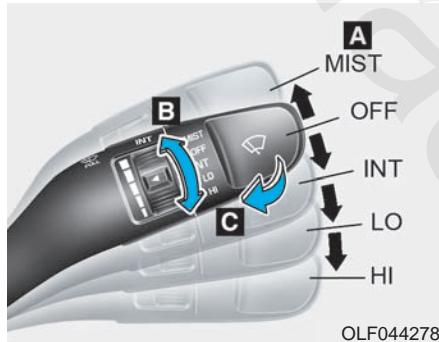

A : Wiper speed control

- MIST – Single wipe
- OFF – Off
- INT – Intermittent wipe
- LO – Low wiper speed
- HI – High wiper speed

B : Intermittent control wipe time adjustment

C : Wash with brief wipes

Windshield Wipers

Operates as follows when engine Start/Stop button is in the ON position.

MIST : For a single wiping cycle, push the lever upward and release. The wipers will operate continuously if the lever is held in this position.

OFF : Wiper is not in operation.

INT : Wiper operates intermittently at the same wiping intervals. To vary the speed setting, move the speed control lever.

LO : The wiper runs at a lower speed.

HI : The wiper runs at a higher speed.

i Information

If there is heavy accumulation of snow or ice on the windshield, defrost the windshield for about 10 minutes, or until the snow and/or ice is removed before using the windshield wipers to ensure proper operation.

If you do not remove the snow and/or ice before using the wiper and washer, it may damage the wiper and washer system.

Windshield Washers

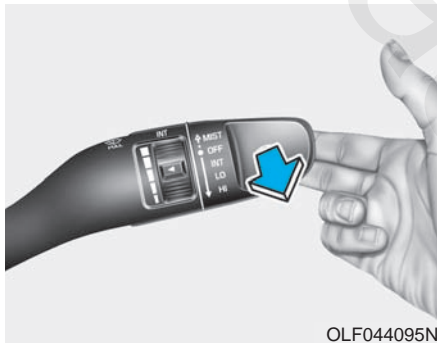

OLF044095N

In the OFF position, pull the lever gently toward you to spray washer fluid on the windshield and to run the wipers 1-3 cycles. The spray and wiper operation will continue until you release the lever. If the washer does not work, you may need to add washer fluid to the washer fluid reservoir.

If equipped with the Headlamp Washer, washer fluid will be sprayed on the headlamp at the same time you operate the windshield washer when:

1. Engine Start/Stop button is in the ON position.
2. The light switch is in the headlamp position.

WARNING

When the outside temperature is below freezing, **ALWAYS** warm the windshield using the defroster to prevent the washer fluid from freezing on the windshield and obscuring your vision which could result in an accident and serious injury or death.

NOTICE

- To prevent possible damage to the washer pump, do not operate the washer when the fluid reservoir is empty.
- To prevent possible damage to the wipers or windshield, do not operate the wipers when the windshield is dry.
- To prevent damage to the wiper arms and other components, do not attempt to move the wipers manually.
- To prevent possible damage to the wipers and washer system, use anti-freezing washer fluids in the winter season or cold weather.

DRIVER ASSIST SYSTEM

Rear view camera

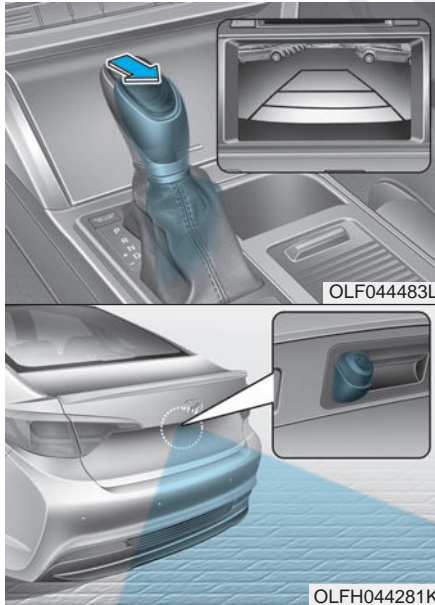

The Rear View Camera will activate when the engine is running and the shift lever is in the R (Reverse) position.

This is a supplemental system that shows behind the vehicle through the navigation display while backing-up.

⚠ WARNING

The Rear View Camera is not a safety device. It only serves to assist the driver in identifying objects directly behind the middle of the vehicle. The camera does NOT cover the complete area behind the vehicle.

⚠ WARNING

- Never rely solely on the Rear View Camera when backing-up.
- ALWAYS look around your vehicle to make sure there are no objects or obstacles before moving the vehicle in any direction to prevent a collision.
- Always pay close attention when the vehicle is driven close to objects, particularly pedestrians, and especially children.

NOTICE

Always keep the camera lens clean. The camera may not work normally if the lens is covered with foreign matter.

Rear parking assist system (if equipped)

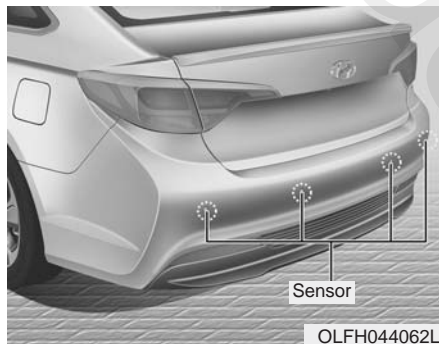

The Rear Parking Assist System assists the driver during reverse movement of the vehicle by chiming if any object is sensed within the distance of 50 inches (120 cm) behind the vehicle. This system is a supplemental system that senses objects within the range and location of the sensors, it cannot detect objects in other areas where sensors are not installed.

⚠ WARNING



- **ALWAYS** look around your vehicle to make sure there are not any objects or obstacles before moving the vehicle in any direction to prevent a collision.
- **Always** pay close attention when the vehicle is driven close to objects, particularly pedestrians, and especially children.
- **Be aware that some objects may not be visible on the screen or be detected by the sensors, due to the objects distance, size or material, all of which can limit the effectiveness of the sensor.**

Operation of the Rear Parking Assist System

Operating condition

- This system will activate when backing up with the ignition switch in the ON position. However, if vehicle speed exceeds 3 mph (5km/h), the system may not detect objects.
- If vehicle speed exceeds 6 mph (10 km/h), the system will not warn you even though objects are detected.
- When more than two objects are sensed at the same time, the closest one will be recognized first.

Types of warning sound and indicator

Types of warning sound	Indicator
When an object is 47 in. to 24 in. (120 cm to 60 cm) from the rear bumper : Buzzer beeps intermittently.	
When an object is 24 in. to 12 in. (60 cm to 30 cm) from the rear bumper : Buzzer beeps more frequently.	
When an object is within 12 in. (30 cm) of the rear bumper : Buzzer beeps continuously.	

NOTICE

- The indicator may differ from the illustration as objects or sensors status. If the indicator blinks, have your vehicle checked by an authorized HYUNDAI dealer.
- If the audible warning does not sound or if the buzzer sounds intermittently when shifting into R (Reverse) position, this may indicate a malfunction with the Parking Assist System. If this occurs, have your vehicle checked by an authorized HYUNDAI dealer as soon as possible.

To turn off the Rear Parking Assist System

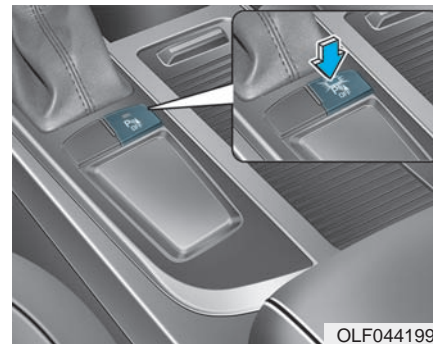

Push the button to turn off the Rear Parking Assist System. The indicator light on the button will turn on.

Non-operational conditions of Parking Assist System

The Rear Parking Assist System may not operate normally when:

- Moisture is frozen to the sensor.
- Sensor is covered with foreign matter, such as snow or water, or the sensor cover is blocked.

There is a possibility of the Rear Parking Assist System malfunction when:

- Driving on uneven road surfaces such as unpaved roads, gravel, bumps, or gradient.
- Objects generating excessive noise such as vehicle horns, loud motorcycle engines, or truck air brakes can interfere with the sensor.
- Heavy rain or water spray is present.
- Wireless transmitters or mobile phones are present near the sensor.
- The sensor is covered with snow.
- Any non-factory equipment or accessories have been installed, or if the vehicle bumper height or sensor installation has been modified.

Detecting range may decrease when:

- Outside air temperature is extremely hot or cold.
- Undetectable objects smaller than 40 inches (1 m) and narrower than 6 inches (14 cm) in diameter.

The following objects may not be recognized by the sensor:

- Sharp or slim objects such as ropes, chains or small poles.
- Objects, which tend to absorb sensor frequency such as clothes, spongy material or snow.

NOTICE

Sensor may not recognize objects less than 12 inches (30 cm) from the sensor, or it may sense an incorrect distance.

NOTICE

Do not push, scratch or strike the sensor with any hard objects that could damage the surface of the sensor. Sensor damage could occur.

⚠ WARNING

Your new vehicle warranty does not cover any accidents or damage to the vehicle or injuries to its occupants related to a Rear Parking Assist System. Always drive safely and cautiously.

DEFROSTER

NOTICE

To prevent damage to the conductors bonded to the inside surface of the rear window, never use sharp instruments or window cleaners containing abrasives to clean the window.

If you want to defrost and defog the front windshield, refer to the "Windshield Defrosting and Defogging" section in this chapter.

Rear Window Defroster

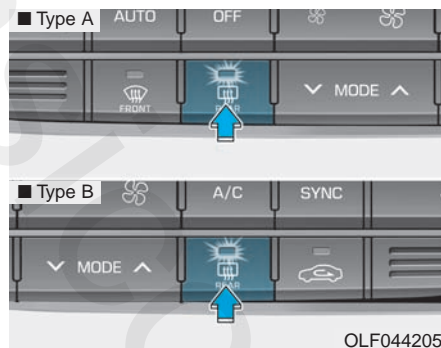

The defroster heats the window to remove frost, fog and thin ice from the interior and exterior of the rear window, while engine is running.

- To activate the rear window defroster, press the rear window defroster button located in the center facia switch panel. The indicator on the rear window defroster button illuminates when the defroster is ON.
- To turn off the defroster, press the rear window defroster button again.

Information

- If there is heavy accumulation of snow on the rear window, brush it off before operating the rear defroster.
- The rear window defroster automatically turns off after approximately 20 minutes or when engine Start/Stop button is in the OFF position.

Outside rearview mirror defroster

If your vehicle is equipped with the outside rearview mirror defrosters, they will operate at the same time you turn on the rear window defroster.

AUTOMATIC CLIMATE CONTROL SYSTEM



1. Driver's temperature control knob
2. Passenger's temperature control knob
3. AUTO (automatic control) button
4. OFF button
5. Fan speed control button
6. Air conditioning button
7. SYNC button
8. Front windshield defrost button
9. Rear window defrost button
10. DRIVER ONLY button
11. Mode selection button
12. ECON (Economy air conditioning) button
13. Air intake control button
14. Climate control information screen

Automatic heating and air conditioning



1. Press the AUTO button.

The modes, fan speeds, air intake and air-conditioning will be controlled automatically according to the temperature setting.

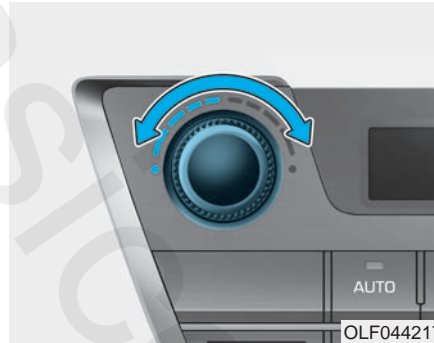

2. Turn the temperature control knob to set the desired temperature.

i Information

- To turn the automatic operation off, select any button of the following:

- Mode selection button
- Front windshield defrost button (Press the button one more time to deselect the front windshield defroster function. The 'AUTO' sign will illuminate on the information display once again.)
- Fan speed control button

The selected function will be controlled manually while other functions operate automatically without 'AUTO' sign.

- For your convenience, use the AUTO button and set the temperature to 73°F (23°C).

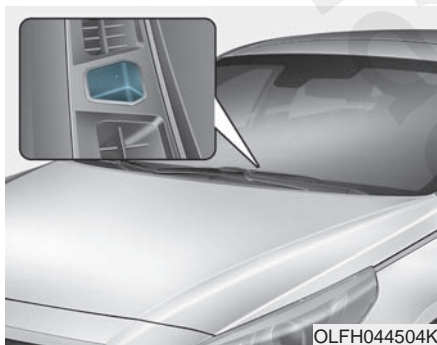

i Information

Never place anything near the sensor to ensure better control of the heating and cooling system.

Manual heating and air conditioning

The heating and cooling system can be controlled manually by pushing buttons other than the AUTO button. In this case, the system works sequentially according to the order of buttons selected. When pressing any button except the AUTO button while using automatic operation, the functions not selected will be controlled automatically.

1. Start hybrid system.
2. Set the mode to the desired position.
For improving the effectiveness of heating and cooling;
 - Heating:
 - Cooling:
3. Set the temperature control to the desired position.

4. Set the air intake control to the outside (fresh) air position.
5. Set the fan speed control to the desired speed.
6. If air conditioning is desired, turn the air conditioning system on.
Press the AUTO button in order to convert to full automatic control of the system.

Convenient features of your vehicle

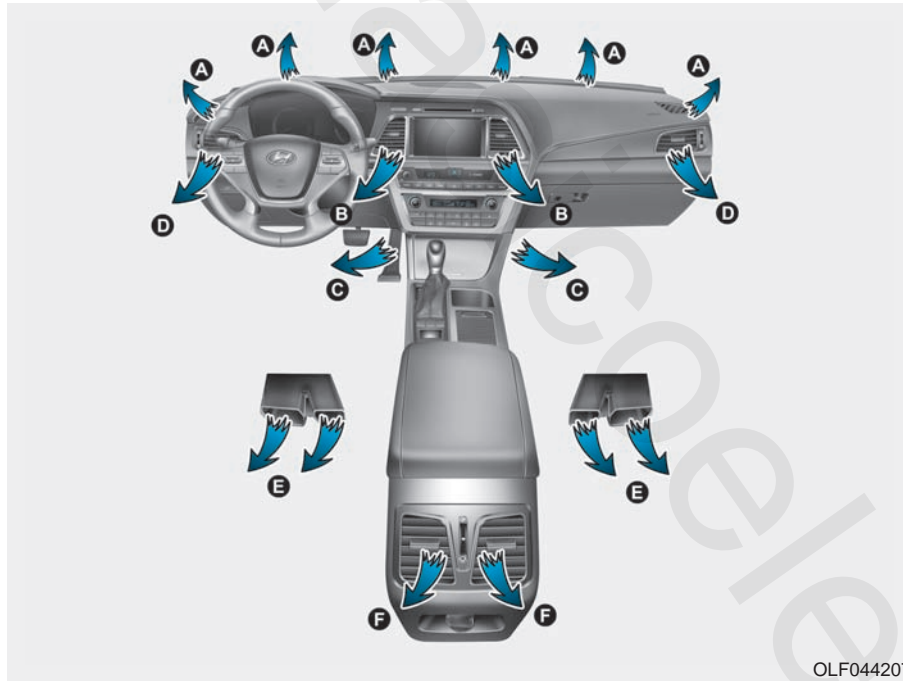

Mode selection

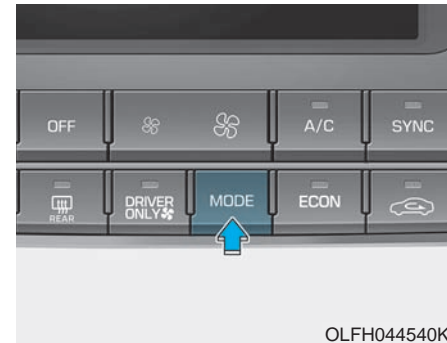

The mode selection button controls the direction of the air flow through the ventilation system.

The air flow outlet port is converted as follows:





Face-Level (B, D, F)

Air flow is directed toward the upper body and face. Additionally, each outlet can be controlled to direct the air discharged from the outlet.



Bi-Level (B, C, D, E, F)

Air flow is directed towards the face and the floor.



Floor & Defrost (A, C, D, E)

Most of the air flow is directed to the floor and the windshield with a small amount directed to the side window defrosters.



Floor-Level (A, C, D, E)

Most of the air flow is directed to the floor, with a small amount of the air being directed to the windshield and side window defrosters.

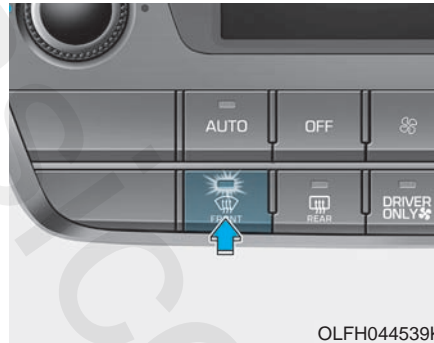

OLFH044539K

Defrost-Level (A)

Most of the air flow is directed to the windshield with a small amount of air directed to the side window defrosters.

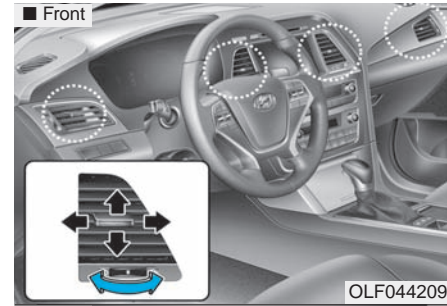

OLF044209

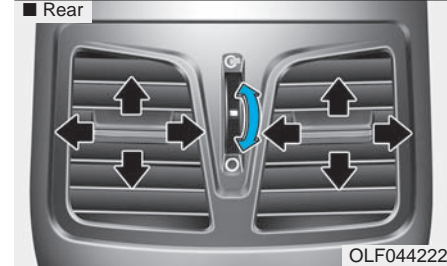

OLF044222

Instrument panel vents

The outlet vents can be opened or closed separately using the thumb-wheel. To close the vent, rotate it left (Rear : down) to the maximum position. To open the vent, rotate it right (Rear : up) to the desired position.

Also, you can adjust the direction of air delivery from these vents using the vent control lever as shown.

Temperature control

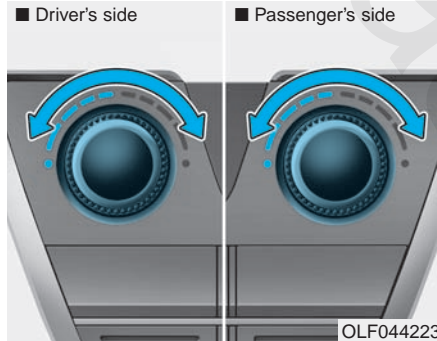

Turn the temperature control knob to set the desired temperature.



Adjusting the driver and passenger side temperature equally

- Press the “SYNC” button to adjust the driver and passenger side temperature equally.

The passenger side temperature will be set to the same temperature as the driver side temperature.

- Turn the driver side temperature control knob. The driver and passenger side temperature will be adjusted equally.

Adjusting the driver and passenger side temperature individually

- Press the “SYNC” button again to adjust the driver and passenger side temperature individually. The illumination of button turns off.
- Operate the driver side temperature control knob to adjust the driver side temperature.
- Operate the passenger side temperature control knob to adjust the passenger side temperature.

Temperature conversion

If the battery has been discharged or disconnected, the temperature mode display will reset to Centigrade.

You can switch the temperature mode between Centigrade to Fahrenheit as follows;

- Automatic climate control system

While pressing the OFF button, press the AUTO button for 3 seconds or more. The display will change from Centigrade to Fahrenheit, or from Fahrenheit to Centigrade.

- “User setting mode” in the cluster :
You can change the temperature unit in the “Other features - Temperature unit”

Air intake control

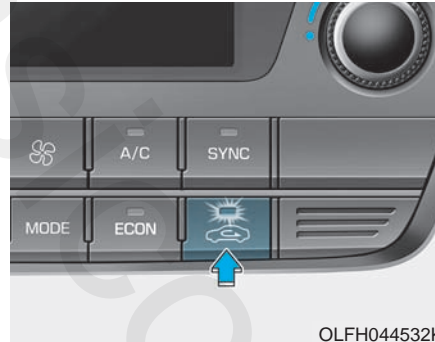

This is used to select the outside (fresh) air position or recirculated air position.

To change the air intake control position, push the control button.

Recirculated air position



With the recirculated air position selected, air from the passenger compartment will be drawn through the heating system and heated or cooled according to the function selected.

Outside (fresh) air position



With the outside (fresh) air position selected, air enters the vehicle from outside and is heated or cooled according to the function selected.

i Information

Prolonged operation of the heater in the recirculated air position (without air conditioning selected) may cause fogging of the windshield and side windows and the air within the passenger compartment may become stale.

In addition, prolonged use of the air conditioning with the recirculated air position selected will result in excessively dry air in the passenger compartment.

! WARNING

- Continued climate control system operation in the recirculated air position may allow humidity to increase inside the vehicle which may fog the glass and obscure visibility.
- Do not sleep in a vehicle with the air conditioning or heating system on. It may cause serious harm or death due to a drop in the oxygen level and/or body temperature.
- Continued climate control system operation in the recirculated air position can cause drowsiness or sleepiness, and loss of vehicle control. Set the air intake control to the outside (fresh) air position as much as possible while driving.

Fan speed control



The fan speed can be set to the desired speed by pushing the fan speed control button.

The higher the fan speed is, the more air is delivered.

Pressing the OFF button turns off the fan.

NOTICE

Operating the fan speed when the Engine Start/Stop button is in the ON position could cause the battery to discharge. Operate the fan speed when hybrid system is running.

Driver Only

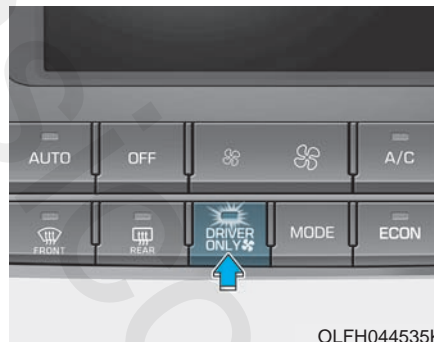

If you press the DRIVER ONLY button (❁) and the indicator light illuminates, cold air mostly blows in the direction of the driver's seat. However, some of the cold air may still come out of other vents to keep indoor air pleasant.

If you use the button with no passenger in the front passenger seat, energy consumption will be reduced.

DRIVER ONLY button will be turned off under the following conditions:

- 1) Defrost on
- 2) SYNC on
- 3) Adjusted front passenger seat temperature
- 4) DRIVER ONLY button pushed again

Air conditioning

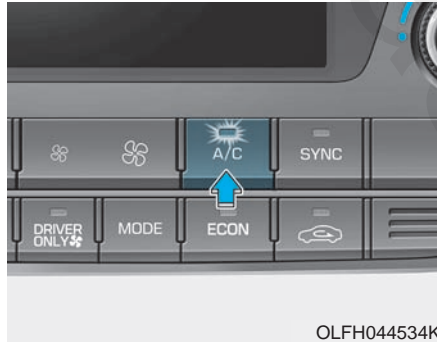

Push the A/C button to turn the air conditioning system on (indicator light will illuminate).

Push the button again to turn the air conditioning system off.

OFF mode



Push the OFF button of the front to turn off the air climate control system. However, you can still operate the mode and air intake buttons as long as the Engine Start/Stop button is in the ON position.

Economy air conditioning button (ECON)

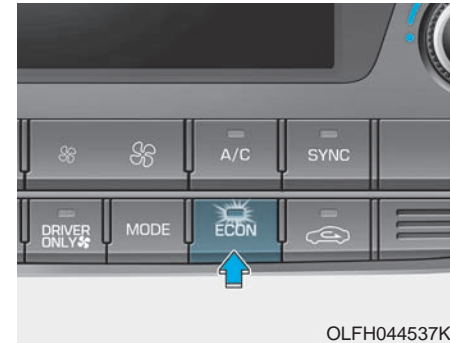

If you push the ECON button while the air conditioning system is working, the air conditioning system will work less and may improve fuel efficiency.



If you want maximum air conditioning turn the ECON system off by pushing the ECON button.

System operation

Ventilation

1. Set the mode to the  position.
2. Set the air intake control to the outside (fresh) air position.
3. Set the temperature control to the desired position.
4. Set the fan speed control to the desired speed.

Heating

1. Set the mode to the  position.
2. Set the air intake control to the outside (fresh) air position.
3. Set the temperature control to the desired position.
4. Set the fan speed control to the desired speed.
5. If dehumidified heating is desired, turn the air conditioning system on.
- If the windshield fogs up, set the mode to the  or  position.

Operation Tips

- To keep dust or unpleasant fumes from entering the vehicle through the ventilation system, temporarily set the air intake control to the recirculated air position. Be sure to return the control to the fresh air position when the irritation has passed to keep fresh air in the vehicle. This will help keep the driver alert and comfortable.
- Air for the heating/cooling system is drawn in through the grilles just ahead of the windshield. Care should be taken that these are not blocked by leaves, snow, ice or other obstructions.
- To prevent interior fog on the windshield, set the air intake control to the fresh air position and fan speed to the desired position, turn on the air conditioning system, and adjust the temperature control to desired temperature.

Air conditioning

HYUNDAI Air Conditioning Systems are filled with R-134a refrigerant.

1. Start hybrid system. Push the air conditioning button.
2. Set the mode to the  position.
3. Set the air intake control to the outside air or recirculated air position.
4. Adjust the fan speed control and temperature control to maintain maximum comfort.

NOTICE

- **The refrigerant system should only be serviced by trained and certified technicians to insure proper and safe operation.**
- **The refrigerant system should be serviced in a well-ventilated place.**
- **The air conditioning evaporator (cooling coil) shall never be repaired or replaced with one removed from a used or salvaged vehicle and new replacement MAC evaporators shall be certified (and labeled) as meeting SAE Standard J2842.**

i Information

- **When using the air conditioning system, monitor the temperature gauge closely while driving up hills or in heavy traffic when outside temperatures are high. Air conditioning system operation may cause engine overheating. Continue to use the blower fan but turn the air conditioning system off if the temperature gauge indicates engine overheating.**
 - **When opening the windows in humid weather air conditioning may create water droplets inside the vehicle. Since excessive water droplets may cause damage to electrical equipment, air conditioning should only be used with the windows closed.**
- #### **Air conditioning system operation tips**
- If the vehicle has been parked in direct sunlight during hot weather, open the windows for a short time to let the hot air inside the vehicle escape.
 - Use air conditioning to reduce humidity and moisture inside the vehicle on rainy or humid days.
 - During air conditioning system operation, you may occasionally notice a slight change in engine speed as the air conditioning compressor cycles. This is a normal system operation characteristic.
 - Use the air conditioning system every month only for a few minutes to ensure maximum system performance.
 - When using the air conditioning system, you may notice clear water dripping (or even puddling) on the ground under the passenger side of the vehicle. This is a normal system operation characteristic.
 - Operating the air conditioning system in the recirculated air position provides maximum cooling, however, continual operation in this mode may cause the air inside the vehicle to become stale.
 - During cooling operation, you may occasionally notice a misty air flow because of rapid cooling and humid air intake. This is a normal system operation characteristic.

System maintenance

Climate control air filter

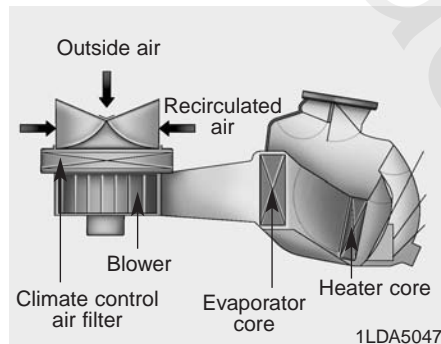

The climate control air filter installed behind the glove box filters the dust or other pollutants that come into the vehicle from the outside through the heating and air conditioning system. If dust or other pollutants accumulate in the filter over a period of time, the air flow from the air vents may decrease, resulting in moisture accumulation on the inside of the windshield even when the outside (fresh) air position is selected. If this happens, we recommend that the climate control air filter be replaced by an authorized HYUNDAI dealer.

i Information

- Replace the filter according to the Maintenance Schedule.

If the car is being driven in severe conditions such as dusty, rough roads, more frequent climate control air filter inspections and changes are required.

- When the air flow rate suddenly decreases, we recommend that the system be checked by an authorized HYUNDAI dealer.

Checking the amount of air conditioner refrigerant and compressor lubricant

When the amount of refrigerant is low, the performance of the air conditioning is reduced. Overfilling also has a bad influence on the air conditioning system.

Therefore, if abnormal operation is found, we recommend that the system be inspected by an authorized HYUNDAI dealer.

⚠ WARNING



Because the refrigerant is at very high pressure, the air conditioning system should only be serviced by trained and certified technicians. It is important that the correct type and amount of oil and refrigerant is used.

Otherwise, it may cause damage to the vehicle and personal injury.

Air Conditioning refrigerant label

■ Example

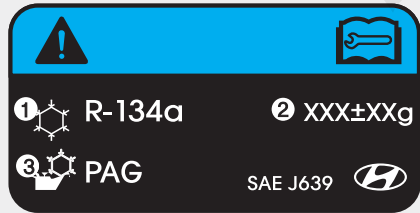

ODH043365

The actual Air Conditioning refrigerant label in the vehicle may differ from the illustration.

Each symbols and specification on air conditioning refrigerant label means as below :



1. Classification of refrigerant
2. Amount of refrigerant
3. Classification of Compressor lubricant

Refer to chapter 8 for more detail location of the air conditioning refrigerant label.

WINDSHIELD DEFROSTING AND DEFOGGING

WARNING

Windshield heating

Do not use the  or  position during cooling operation in extremely humid weather. The difference between the temperature of the outside air and that of the windshield could cause the outer surface of the windshield to fog up, causing loss of visibility could cause an accident resulting in serious injury or death. In this case, set the mode selection knob or button to the  position and fan speed control knob or button to a lower speed.

- For maximum defrosting, set the temperature control to the extreme right/hot position and the fan speed control to the highest speed.
- If warm air to the floor is desired while defrosting or defogging, set the mode to the floor-defrost position.
- Before driving, clear all snow and ice from the windshield, rear window, outside rear view mirrors, and all side windows.
- Clear all snow and ice from the hood and air inlet in the cowl grill to improve heater and defroster efficiency and to reduce the probability of fogging up the inside of the windshield.
- To reduce tendency of the glass fogging and also to improve visibility, keep the interior surface of the windshield clean by wiping it with a clean cloth and glass cleaner.

NOTICE

If the engine temperature is still cold after starting, then a brief engine warm up period may be required for the vented air flow to become warm or hot.

Automatic Climate Control System

To defog inside windshield

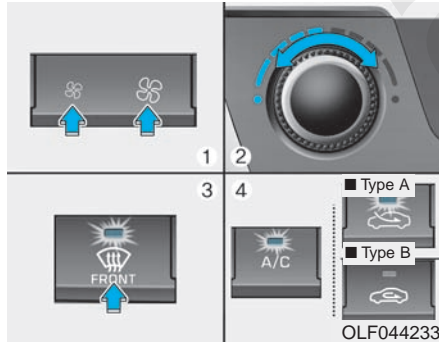

1. Select desired fan speed.
2. Select desired temperature.
3. Press the defroster button ().
4. The outside (fresh) air position will be selected automatically.

If the outside (fresh) air position is not selected automatically, adjust the corresponding button manually.

If the position is selected, lower fan speed is adjusted to a higher fan speed.

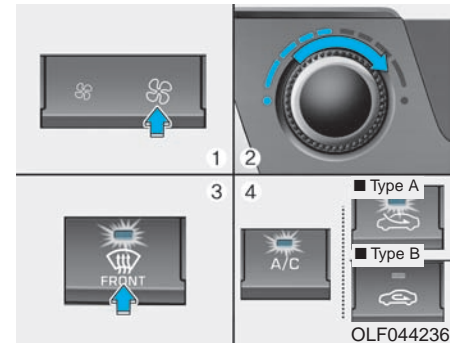

To defrost outside windshield



1. Set the fan speed to the highest (extreme right) position.
2. Set the temperature to the extreme hot (HI) position.
3. Press the defroster button ().
4. The outside (fresh) air position will be selected automatically.

If the position is selected, lower fan speed is adjusted to a higher fan speed.

Defogging logic (if equipped)

To reduce the probability of fogging up the inside of the windshield, the air intake or air conditioning are controlled automatically according to certain conditions such as  or  position. To cancel or return the defogging logic, do the following.

Automatic climate control system

1. Turn the ignition switch to the ON position.
2. Press the defroster button (.
3. While pressing the air conditioning button (A/C), press the air intake control button at least 5 times within 3 seconds.

The climate control information screen will blink 3 times with 0.5 seconds of interval. It indicates that the defogging logic is canceled or returned to the programmed status.

If the battery has been discharged or disconnected, it resets to the defog logic status.

CLIMATE CONTROL ADDITIONAL FEATURES (IF EQUIPPED)

Automatic Ventilation (if equipped)

When the engine is running and temperature is below 59°F (15°C) with the recirculated air position selected more than five minutes, the air intake position will automatically change to the outside (fresh) air position.

To cancel or reset the Automatic Ventilation

When the air conditioning system is on, select Face Level  mode and while pressing the A/C button, press the recirculated air position button five times within three seconds.

Sunroof Inside Air Recirculation (if equipped)

When the heater or air conditioning system is on with the sunroof opened, the outside (fresh) air position will be automatically selected. At this time, if you press the recirculated air position button, the recirculated air position will be selected but will change back to the outside (fresh) air position after 3 minutes.

When the sunroof is closed, the air intake position will return to the original position that was selected.

STORAGE COMPARTMENT

⚠ WARNING

Never store cigarette lighters, propane cylinders, or other flammable/explosive materials in the vehicle. These items may catch fire and/or explode if the vehicle is exposed to hot temperatures for extended periods.

⚠ WARNING

ALWAYS keep the storage compartment covers closed securely while driving. Items inside your vehicle are moving as fast as the vehicle. If you have to stop or turn quickly, or if there is a crash, the items may fly out of the compartment and may cause an injury if they strike the driver or a passenger.

NOTICE

To avoid possible theft, do not leave valuables in the storage compartments.

Center Console Storage

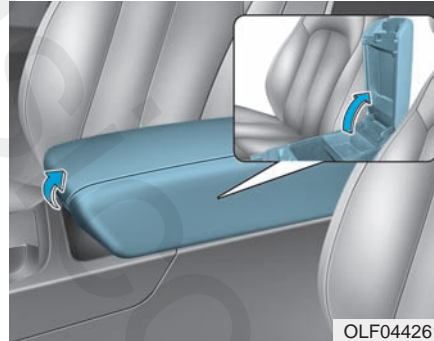

To open :
Pull lever (1).

Glove Box

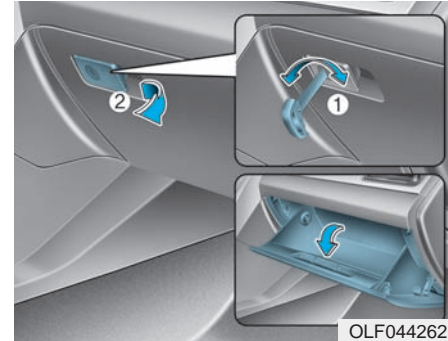

The glove box can be locked and unlocked with the mechanical key (1).

To open:
Pull the lever (2).

⚠ WARNING

ALWAYS close the glove box door after use.

An open glove box door can cause serious injury to the passenger in an accident, even if the passenger is wearing a seat belt.

Sunglass Holder

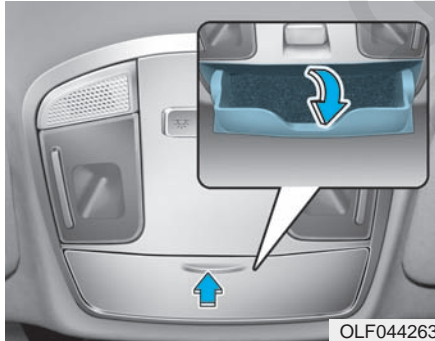

To open:

Press the cover and the holder will slowly open. Place your sunglasses in the compartment door with the lenses facing out.

To close:

Push back into position.

Make sure the sunglass holder is closed while driving.

⚠ WARNING

- Do not keep objects except sunglasses inside the sunglass holder. Such objects can be thrown from the holder in the event of a sudden stop or an accident, possibly injuring the passengers in the vehicle.
- Do not open the sunglass holder while the vehicle is moving. The rear view mirror of the vehicle can be blocked by an open sunglass holder.
- Do not put the glasses forcibly into a sunglass holder. It may cause personal injury if you try to open it forcibly when the glasses are jammed in holder.

Multi box

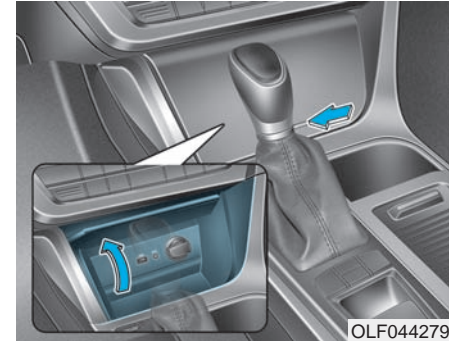

To open the cover, press the cover and it will slowly open. To close the cover, press the cover and it will slowly close.

For the safety of the passengers, when the cover is closed, the cover locks if the vehicle shakes by sudden acceleration and braking.

To unlock the cover, press the cover twice.

INTERIOR FEATURES

Cup Holder

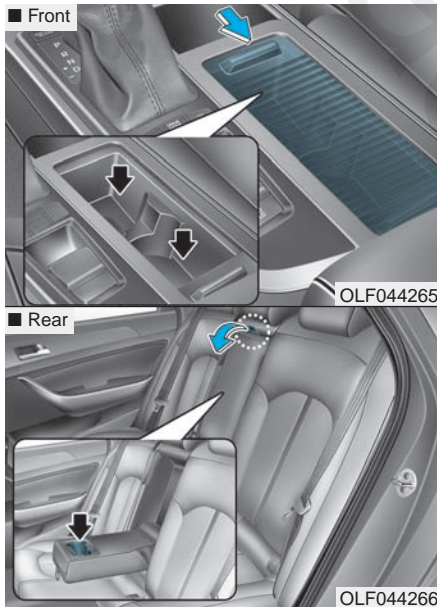

Cups or small beverages cups may be placed in the cup holders.

Rear

Pull the armrest down to use the cup holders.

⚠ WARNING

- Avoid abrupt starting and braking when the cup holder is in use to prevent spilling your drink. If hot liquid spills, you could be burned. Such a burn to the driver could cause loss of vehicle control resulting in an accident.
- Do not place uncovered or unsecured cups, bottles, cans, etc., in the cup holder containing hot liquid while the vehicle is in motion. Injuries may result in the event of sudden stop or collision.
- Only use soft cups in the cup holders. Hard objects can injure you in an accident.

⚠ WARNING

Keep cans or bottles out of direct sun light and do not put them in a hot vehicle. It may explode.

NOTICE

- Keep your drinks sealed while driving to prevent spilling your drink. If liquid spills, it may get into the vehicle's electrical/electronic system and damage electrical/electronic parts.
- When cleaning spilled liquids, do not dry the cup holder at high temperature. This may damage the cup holder.

Sunvisor

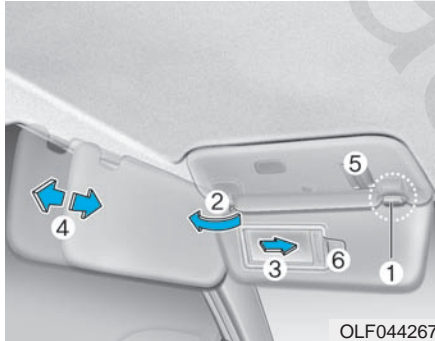

To use a sunvisor, pull it downward.
To use a sunvisor for a side window, pull it downward, unsnap it from the bracket (1) and swing it to the side (2).
To use the vanity mirror, pull down the sunvisor and slide the mirror cover (3).
Adjust the sunvisor forward or backward (4) as needed. Use the ticket holder (5 and 6) to hold tickets.

NOTICE

Close the vanity mirror cover securely and return the sunvisor to its original position after use.

! WARNING

For your safety, do not block your view when using the sunvisor.

NOTICE

- Do not put several tickets in the ticket holder at one time. This could cause damage to the ticket holder.
- Avoid putting a plastic card such as a credit card in the ticket holder located in the outside of the sunvisor. This could cause damage to the plastic card.

Power Outlet

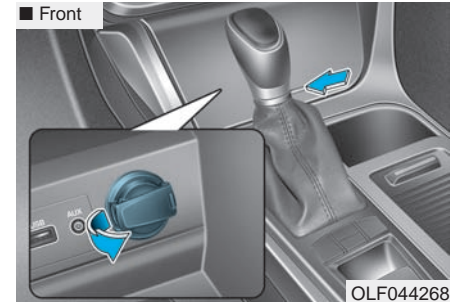

■ Rear (if equipped)

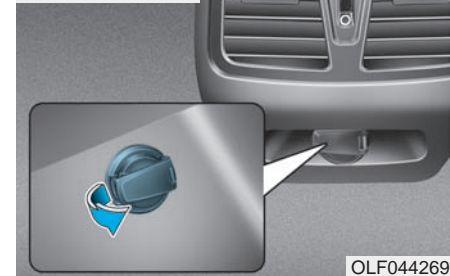

The power outlet is designed to provide power for mobile telephones or other devices designed to operate with vehicle electrical systems. The devices should draw less than 180 W(Watt) with the engine running.

⚠ WARNING

Avoid electrical shocks. Do not place your fingers or foreign objects (pin, etc.) into a power outlet or touch the power outlet with a wet hand.

NOTICE

To prevent damage to the Power Outlets :

- Use the power outlet only when the engine is running and remove the accessory plug after use. Using the accessory plug for prolonged periods of time with the engine off could cause the battery to discharge.
- Only use 12V electric accessories which are less than 180 W(Watt) in electric capacity.
- Adjust the air-conditioner or heater to the lowest operating level when using the power outlet.
- Close the cover when not in use.
- Some electronic devices can cause electronic interference when plugged into a vehicle's power outlet. These devices may cause excessive audio static and malfunctions in other electronic systems or devices used in your vehicle.

(Continued)

(Continued)

- Push the plug in as far as it will go. If good contact is not made, the plug may overheat and the fuse may open.
- Plug in battery equipped electrical/electronic devices with reverse current protection. The current from the battery may flow into the vehicle's electrical/electronic system and cause system malfunction.

Clock

WARNING

Do not adjust the clock while driving, you may lose your steering control and cause an accident that results in severe personal injury or death.

With Audio system

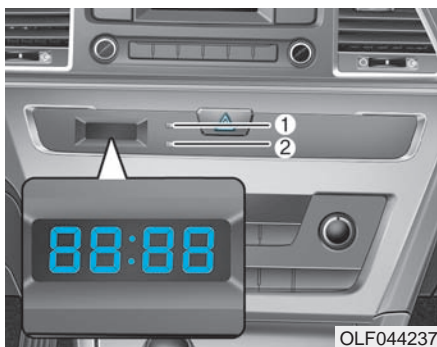

Whenever the battery terminals or related fuses are disconnected, you must reset the time.

To set the time:

Engine Start/Stop button must be in the ACC or ON position.

- **H (Hour, 1)**

Each time you press the "H" button, the clock will change backward by one hour. Pressing and holding the "H" button will change the clock backward continuously.

Release the button at the desired time.

- **M (Minute, 2)**

Each time you press the "M" button, the clock will change backward by one minute. Pressing and holding the "M" button will change the clock backward continuously.

Release the button at the desired time.

- **Display conversion**

To change the 12 hour format to the 24 hour format, press the "H" and "M" button simultaneously for more than 4 seconds.

For example, if the "H" and "M" button is pressed when the time is 10:15 p.m., the display will change to 22:15

With Navigation system

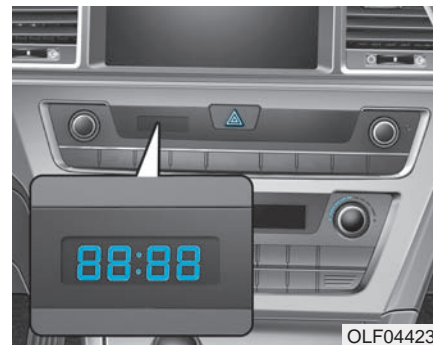

You can set the clock by using the Navigation system.

GPS Time check

The clock is automatically updated through the navigation system.

GPS Time non-check

The clock can be manually adjusted.

1. Select the "System Settings" on the "INFO/Setup" screen.
2. Select the "Clock Settings".
3. Select the "Time Settings" by rotating the controller on the center console panel.
4. Select the "Time Format" to the 12 hour or 24 hour format.

For more information, please refer to the manual that was separately supplied with your vehicle.

Clothes Hanger

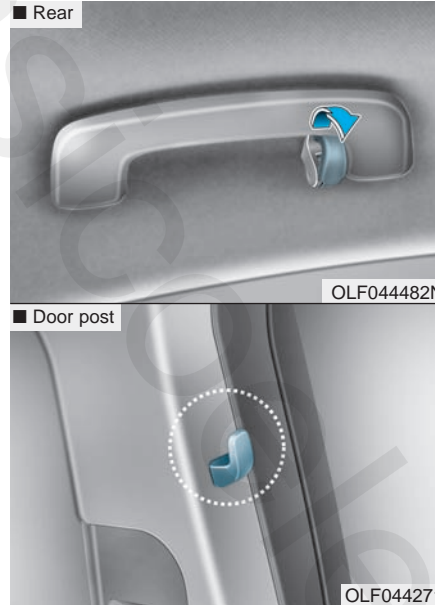

To hang items, pull the hanger down. These hangers are not designed to hold large or heavy items.

⚠ WARNING

Do not hang other objects except clothes. In an accident it may cause vehicle damage or personal injury.

Floor Mat Anchor(s)

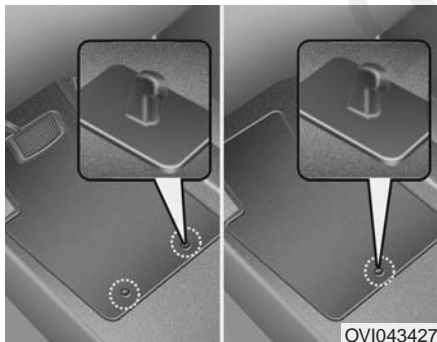

ALWAYS use the Floor Mat Anchors to attach the front floor mats to the vehicle. The anchors on the front floor carpet keep the floor mats from sliding forward.

⚠ WARNING

The following must be observed when installing ANY floor mat to the vehicle.

- Ensure that the floor mats are securely attached to the vehicle's floor mat anchor(s) before driving the vehicle.
- Do not use ANY floor mat that cannot be firmly attached to the vehicle's floor mat anchors.
- Do not stack floor mats on top of one another (e.g. all-weather rubber mat on top of a carpeted floor mat). Only a single floor mat should be installed in each position.

(Continued)

(Continued)

IMPORTANT - Your vehicle was manufactured with driver's side floor mat anchors that are designed to securely hold the floor mat in place. To avoid any interference with pedal operation, HYUNDAI recommends that the HYUNDAI floor mat designed for use in your vehicle be installed.

Side Curtain (if equipped)

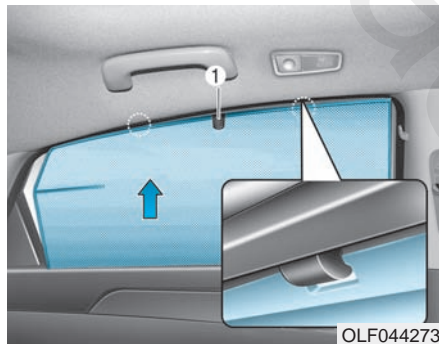

To use the side curtain:

1. Pull up the curtain by the hook (1).
2. Hang the curtain on both sides of the hook.

NOTICE

- Always hang both sides of the curtain on the hook. This could cause damage to the side curtain if only one side of the curtain is hooked.
- Do not let any foreign material get in between the vehicle and side curtain. The side curtain may not be lifted up.

Luggage Net Holder (if equipped)

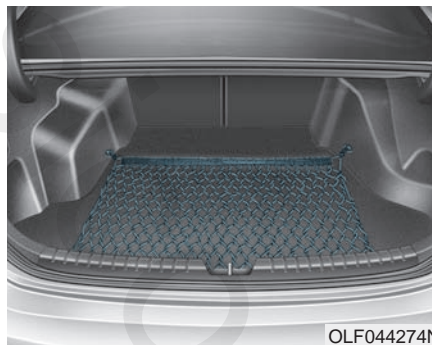

To keep items from shifting in the trunk, you can use the 4 holders located in the trunk to attach the luggage net.

Make sure the luggage net is securely attached to the holders in the trunk.

⚠ WARNING

Avoid eye injury. DO NOT overstretch the luggage net. ALWAYS keep your face and body out of the luggage net's recoil path. DO NOT use the luggage net when the strap has visible signs of wear or damage.

Multimedia System

Multimedia System.....	4-2
AUX, USB and iPod® Port	4-2
Antenna	4-2
Steering Wheel Audio Control.....	4-3
Audio / Video / Navigation System (AVN).....	4-4
<i>Bluetooth</i> ® Wireless Technology Hands-Free.....	4-4
How Vehicle Audio Works	4-5
Features of Your Vehicle.....	4-7
System Controllers and Functions	
- 3.8 Inch Mono TFT	4-18, 4-111
Audio Head Unit.....	4-18, 4-111
Setup.....	4-20, 4-113
Radio : FM, AM, SiriusXM	4-23, 4-116
SiriusXM, XM™ RADIO.....	4-26, 4-117
Basic Method of Use : Audio CD / MP3 CD / USB / iPod® / My Music	4-28, 4-119
<i>Bluetooth</i> ® Wireless Technology Audio.....	4-34, 4-125
<i>Bluetooth</i> ® Wireless Technology.....	4-36, 4-127
Voice Recognition.....	4-47, 4-138
Ending Voice Recognition.....	4-48, 4-139

System Controllers and Functions

- 5 Inch Color TFT LCD	4-55, 4-145
Audio Head Unit.....	4-55, 4-145
Steering-Wheel Mounted Controls.....	4-57, 4-147
Radio Mode	4-59, 4-149
SiriusXM, XM™ Radio Mode	4-63, 4-151
Media Mode	4-65, 4-153
Audio CD Mode	4-66, 4-154
MP3 CD Mode.....	4-68, 4-156
USB Mode.....	4-71, 4-159
iPod® Mode	4-74, 4-162
AUX Mode	4-76, 4-164
MY Music Mode.....	4-77, 4-165
<i>Bluetooth</i> ® Wireless Technology	
Audio Mode	4-80, 4-168
Voice Recognition.....	4-95, 4-183
Setup.....	4-101, 4-190
Rear View Camera.....	4-106, 4-194
Blue Link®.....	4-106, 4-194
Declaration of conformity	4-198

MULTIMEDIA SYSTEM

NOTICE

- If you install an aftermarket HID head lamp, your vehicle's audio and electronic device may malfunction.
- Prevent chemicals such as perfume, cosmetic oil, sun cream, hand cleaner, and air freshener from contacting the interior parts because they may cause damage or discoloration.

AUX, USB and iPod® Port

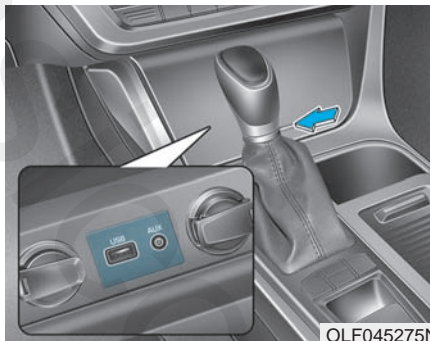

You can use an AUX port to connect audio devices and an USB port to plug in an USB and also in an iPod® port.

i Information

When using a portable audio device connected to the power outlet, noise may occur during playback. If this happens, use the power source of the portable audio device.

※ iPod® is a trademark of Apple Inc.

Antenna

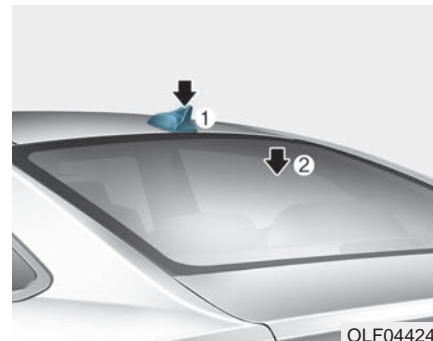

Shark fin antenna (1)

The shark fin antenna will receive the transmit data.

Glass antenna (2)

Your vehicle uses a glass antenna to receive both AM and FM signals.

NOTICE

- Do not clean the inside of the rear window glass with a cleaner or scraper to remove foreign deposits as this may cause damage to the antenna elements.
- Avoid adding metallic coatings such as Ni, Cd, and so on. These can degrade the receiving AM and FM broadcast signals.

Steering Wheel Audio Control**NOTICE**

Do not operate audio remote control buttons simultaneously.

VOLUME (VOL +/-) (1)

- Move the VOLUME lever up to increase volume.
- Move the VOLUME lever down to decrease volume.

SEEK/PRESET (^ / v) (2)

If the SEEK/PRESET lever is moved up or down and held for 0.8 second or more, it will function in the following modes;

RADIO mode

It will function as the AUTO SEEK select button. It will SEEK until you release the button.

MEDIA mode

It will function as the FF/REW button.

If the SEEK/PRESET lever is moved up or down, it will function in the following modes;

RADIO mode

It will function as the PRESET STATION UP/DOWN button.

MEDIA mode

It will function as the TRACK UP/DOWN button.

MODE (3)

Press the MODE button to select Radio, XM, Disc, or AUX.

i Information

Detailed information for audio control buttons are described in the following pages in this chapter.

Audio / Video / Navigation System (AVN)

Detailed information for the AVN system is described in a separately supplied manual.

Bluetooth® Wireless Technology Hands-Free



OLF044242N



OLF044276

Detailed information for the Bluetooth® Wireless Technology hands-free is described in the following pages in this chapter or in the manual supplied separately.

You can use the phone wirelessly by using the Bluetooth® Wireless Technology.

- (1) Call / Answer button
- (2) Call end button
- (3) Microphone

How vehicle audio works

FM reception

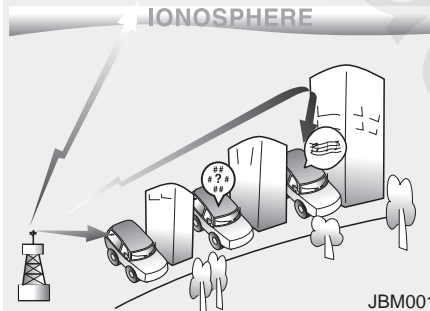

AM and FM radio signals are broadcast from transmitter towers located around your city. They are intercepted by the radio antenna on your vehicle. This signal is then processed by the radio and sent to your vehicle speakers.

When a strong radio signal has reached your vehicle, the precise engineering of your audio system ensures the best possible quality reproduction. However, in some cases the signal coming to your vehicle may not be strong and clear.

This can be due to factors, such as the distance from the radio station, closeness of other strong radio stations or the presence of buildings, bridges or other large obstructions in the area.

AM reception

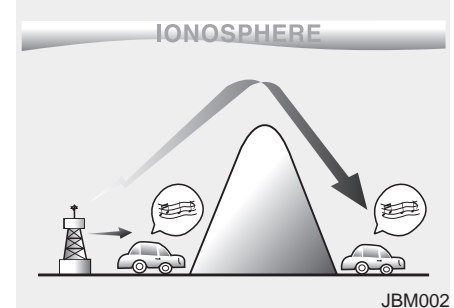

AM broadcasts can be received at greater distances than FM broadcasts. This is because AM radio waves are transmitted at low frequencies. These long distance, low frequency radio waves can follow the curvature of the earth rather than travelling straight. In addition, they curve around obstructions resulting in better signal coverage.

FM radio station

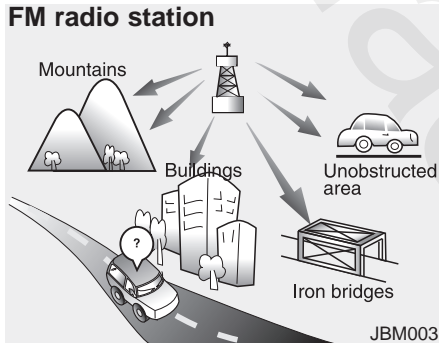

FM broadcasts are transmitted at high frequencies and do not bend to follow the earth's surface. Because of this, FM broadcasts generally begin to fade within short distances from the station. Also, FM signals are easily affected by buildings, mountains, and obstructions. This can lead to undesirable or unpleasant listening conditions which might lead you to believe a problem exists with your radio. The following conditions are normal and do not indicate radio trouble:

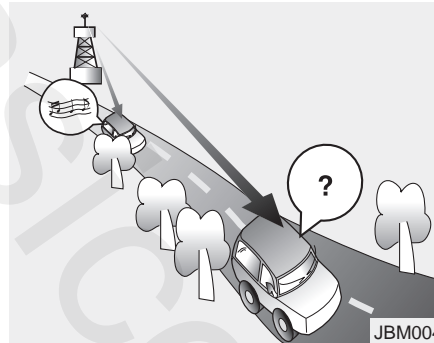

- **Fading** - As your vehicle moves away from the radio station, the signal will weaken and sound will begin to fade. When this occurs, we suggest that you select another stronger station.
- **Flutter/Static** - Weak FM signals or large obstructions between the transmitter and your radio can disturb the signal causing static or fluttering noises to occur. Reducing the treble level may lessen this effect until the disturbance clears.

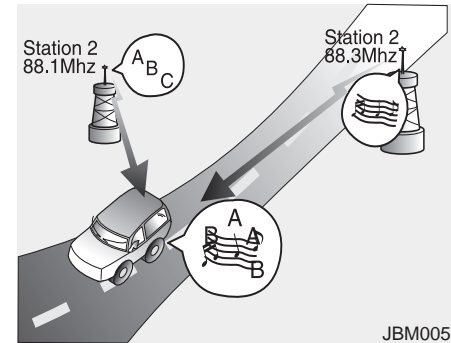

- **Station Swapping** - As an FM signal weakens, another more powerful signal near the same frequency may begin to play. This is because your radio is designed to lock onto the clearest signal. If this occurs, select another station with a stronger signal.
- **Multi-Path Cancellation** - Radio signals being received from several directions can cause distortion or fluttering. This can be caused by a direct and reflected signal from the same station, or by signals from two stations with close frequencies. If this occurs, select another station until the condition has passed.

Features of your vehicle

Satellite radio reception

You may experience difficulties in receiving XM™ satellite radio signals in the following situations.

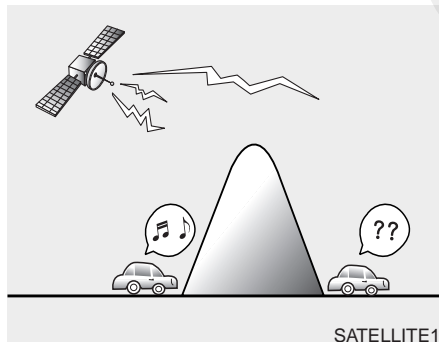

- If you are driving in a tunnel or a covered parking area.
- If you are driving beneath the top level of a multi-level freeway.
- If you are driving under a bridge.
- If you are driving next to a tall vehicle (such as a truck or a bus) that blocks the signal.
- If you are driving in a valley where the surrounding hills or peaks block the signal from the satellite.

- If you are driving on a mountain road where the signal is blocked by mountains.
- If you are driving in an area with tall trees that block the signal (30 ft./10m or more), for example on an road that goes through a dense forest.

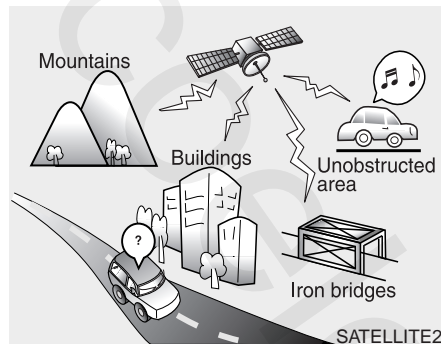

- The signal can become weak in some areas that are not covered by the XM™ repeater network.

Information

There may also be additional unforeseen circumstances leading to reception problems with the XM™ satellite radio signal.

Advisory Messages, such as 'CH Unavailable' may occur when starting XM™ Radio.

Caring for disc

- If the temperature inside the car is too high, open the car windows to ventilate before using the system.
- It is illegal to copy and use MP3/WMA files without permission. Use CDs that are created only by lawful means.
- Do not apply volatile agents, such as benzene and thinner, normal cleaners and magnetic sprays made for analogue disc onto CDs.
- To prevent the disc surface from getting damaged, hold CDs by the edges or the center hole only.
- Clean the disc surface with a piece of soft cloth before playback (wipe it from the center to the outside edge).
- Do not damage the disc surface or attach pieces of sticky tape or paper.
- Make certain only CDs are inserted into the CD player (Do not insert more than one CD at a time).
- Keep CDs in their cases after use to protect them from scratches or dirt.

- Depending on the type of CD-R/CD-RW CDs, certain CDs may not operate normally according to the manufacturing companies. In such circumstances, continued use may cause malfunctions to your audio system.

Information - Playing an Incompatible Copy Protected Audio CD

Some copy protected CDs, which do not comply with international audio CD standards (Red Book), may not play on your car audio. Please note that inability to properly play a copy protected CD may indicate that the CD is defective, not the CD player.

Using a cellular phone or a two-way radio

When a cellular phone is used inside the vehicle, noise may be produced from the audio system. This does not mean that something is wrong with the audio equipment. In such a case, try to operate mobile devices as far from the audio equipment as possible.



CAUTION

When using a communication system such as a cellular phone or a radio set inside the vehicle, a separate external antenna must be fitted. When a cellular phone or a radio set is used with an internal antenna alone, it may interfere with the vehicle's electrical system and adversely affect safe operation of the vehicle.



WARNING

Do not use a cellular phone while driving. Stop at a safe location to use a cellular phone.

NOTE:

Order of playing files (folders) :

1. Song playing order : ① to ⑭ sequentially.

2. Folder playing order :

* If no song file is contained in the folder, that folder is not displayed.

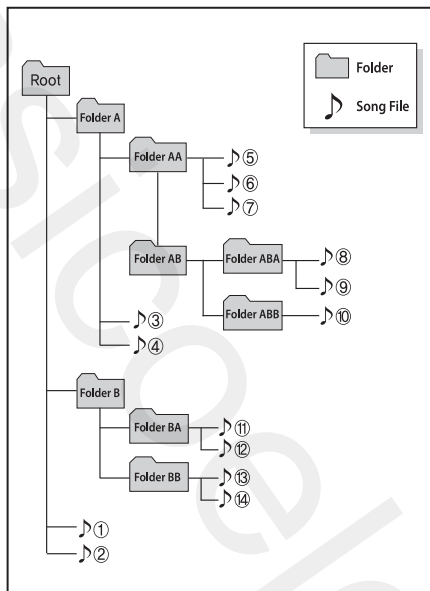
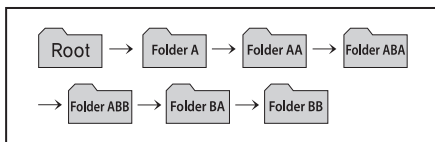

⚠ WARNING

- Do not stare at the screen while driving. Staring at the screen for prolonged periods of time could lead to traffic accidents.
- Do not disassemble, assemble, or modify the audio system. Such acts could result in accidents, fire, or electric shock.
- Using the phone while driving may lead to a lack of attention of traffic conditions and increase the likelihood of accidents. Use the phone feature after parking the vehicle.
- Heed caution not to spill water or introduce foreign objects into the device. Such acts could lead to smoke, fire, or product malfunction.

(Continued)

 **CAUTION**

- Operating the device while driving could lead to accidents due to a lack of attention to external surroundings. First park the vehicle before operating the device.
- Adjust the volume to levels that allow the driver to hear sounds from outside of the vehicle. Driving in a state where external sounds cannot be heard may lead to accidents.
- Pay attention to the volume setting when turning the device on. A sudden output of extreme volume upon turning the device on could lead to hearing impairment. (Adjust the volume to a suitable level before turning off the device.)

(Continued)

NOTICE

- Do not place beverages close to the audio system. Spilling beverages may lead to system malfunction.
- In case of product malfunction, please contact your place of purchase or After Service center.
- Placing the audio system within an electromagnetic environment may result in noise interference.
- Prevent caustic solutions such as perfume and cosmetic oil from contacting the dashboard because they may cause damage or discoloration.

 **Information - Using the discs**

- This device has been manufactured to be compatible with software bearing the following logo marks.
- Do not clean discs with chemical solutions, such as record sprays, antistatic sprays, antistatic liquids, benzene, or thinners.
- After using a disc, put the disc back in its original case to prevent disc scratches.
- Hold discs by their edges or within the center hole to prevent damages to disc surfaces.
- Do not introduce foreign substances into the disc insert/eject slot. Introducing foreign substances could damage the device interior.
- Do not insert two discs simultaneously.
- When using CD-R/CD-RW discs, differences in disc reading and playing times may occur depending on the disc manufacturer, production method and the recording method as used by the user.

(Continued)

(Continued)

- Clean fingerprints and dust off the disc surface (coated side) with a soft cloth.
- The use of CD-R/CD-RW discs attached with labels may result in disc slot jams or difficulties in disc removal. Such discs may also result in noise while playing.
- Some CD-R/CD-RW discs may not properly operate depending on the disc manufacturer, production method and the record method as used by the user. If problems persist, trying using a different CD as continued use may result in malfunctions.
- The performance of this product may differ depending on the CD-RW Drive Software.
- Copy-protected CDs such as S-type CDs may not function in the device. DATA discs cannot be played. (However, such discs may still operate but will do so abnormally.)

(Continued)

(Continued)

- Do not use abnormally shaped discs (8cm, heart-shaped, octagon-shaped) as such discs could lead to malfunctions.
- If the disc is straddled on the disc slot without removal for 10 seconds, the disc will automatically be re-inserted into the disc player.
- Only genuine audio CDs are supported. Other discs may result in recognition failure (e.g. copy CD-R, CDs with labels)

Information - Using the USB device

- Connect the USB device after turning on the engine. The USB device may become damaged if it is already connected when the ignition is turned on. The USB device may not operate properly if the car ignition is turned on or off with the USB device connected.
- Heed caution to static electricity when connecting/disconnecting USB devices.
- Encoded MP3 Players will not be recognized when connected as an external device.
- When connecting an external USB device, the device may not properly recognize the USB is in some states.
- Only products formatted with byte/sectors under 64Kbyte will be recognized.
- This device recognizes USB devices formatted in FAT 12/16/32 file formats. This device does not recognize files in NTFS file format.

(Continued)

(Continued)

- Some USB devices may not be supported due to compatibility issues.
- Avoid contact between the USB connector with bodily parts or foreign objects.
- Repeated connecting/disconnecting of USB devices within short periods of time may result in product malfunction.
- A strange noise may occur when disconnecting the USB.
- Make sure to connect/disconnect external USB devices with the audio power turned off.
- The amount of time required to recognize the USB device may differ depending on the type, size or file formats stored in the USB. Such differences in time are not indications of malfunctions.
- The device only supports USB devices used to play music files.
- USB images and videos are not supported.

(Continued)

(Continued)

- Do not use the USB I/F to charge batteries or USB accessories that generate heat. Such acts may lead to worsened performance or damage to the device.
- The device may not recognize the USB device if separately purchased USB hubs and extension cables are being used. Connect the USB directly with the multimedia terminal of the vehicle.
- When using mass storage USB devices with separate logical drives, only files saved to the root drive can be played.
- Files may not properly operate if application programs are installed to the USBs.
- The device may not operate normally if MP3 Players, cellular phones, digital cameras, or other electronic devices (USB devices not recognized as portable disk drives) are connected with the device.

(Continued)

- Charging through the USB may not work for some mobile devices.
- The device may not support normal operation when using a USB memory type besides (Metal Cover Type) USB Memory.
- The device may not support normal operation when using formats such as HDD Type, CF, or SD Memory.
- The device will not support files locked by DRM (Digital Rights Management.)
- USB memory sticks used by connecting an Adaptor (SD Type or CF Type) may not be properly recognized.
- The device may not operate properly when using USB HDDs or USBs subject to connection failures caused by vehicle vibrations. (e.g. i-stick type)

(Continued)

(Continued)

- Avoid use of USB memory products that can also be used as key chains or mobile phone accessories. Use of such products may cause damage to the USB jack.
- Connecting an MP3 device or phone through various channels, such as AUX/BT or Audio/ USB mode may result in pop noises or abnormal operation.



i Information - Using the iPod® device

- iPod® is a registered trademark of Apple Inc.
- In order to use the iPod® while operating the keys, you must use a dedicated iPod® cable. (the cable that is supplied when purchasing iPod®/iPhone® products)
- If the iPod® is connected to the vehicle while it is playing, a high pitch sound could occur for approximately 1-2 seconds immediately after connecting. If possible, connect the iPod to the vehicle with the iPod® stopped/ paused.
- During ACC ON state, connecting the iPod® through the iPod® cable will charge the iPod® through the car audio system.
- When connecting with the iPod® cable, make sure to fully insert the jack to prevent communication interference.

(Continued)

(Continued)

- When the EQ features of an external device, such as the iPod®, and the audio system are both active, EQ effects could overlap and cause sound deterioration and distortion. Whenever possible, turn off the EQ feature within the external device upon use by connecting with the audio system.
- Noise may occur when an iPod® or AUX device is connected. When such devices are not being used, disconnect the device for storage.
- When the iPod® or AUX device power is connected to the power jack, playing the external device may result in noise. In such cases, disconnect the power connection before use.
- Skipping or improper operation may occur depending on the characteristics of your iPod®/Phone® device.

(Continued)

(Continued)

- If your iPhone® is connected to both the *Bluetooth*® Wireless Technology and USB, the sound may not be properly played. In your iPhone®, select the Dock connector or *Bluetooth*® Wireless Technology to change the sound output (source).
- iPod mode cannot be operated when the iPod® cannot be recognized due to versions that do not support communication protocols.
- For fifth generation iPod® Nano devices, the iPod® may not be recognized when the battery level is low. Please charge the iPod® for use.
- Search/play orders shown within the iPod® device may differ with the orders shown within the audio system.
- If the iPod® malfunctions due to an iPod® device defect, reset the iPod® and try again. (To learn more, refer to your iPod® manual)

(Continued)

(Continued)

- Some iPod®s may not sync with the System depending on its version. If the Media is removed before the Media is recognized, then the system may not properly restore the previously operated mode. (iPad® charging is not supported.)

Information - Using the AUX device

- If an external device connector is connected with the AUX terminal, then AUX mode will automatically operate. Once the connector is disconnected, the previous mode will be restored.
- AUX mode can be used only when an external audio player (camcorder, car VCR, etc.) has been connected.
- The AUX volume can be controlled separately from other audio modes.
- Connecting a connector jack to the AUX terminal without an external device will convert the system to AUX mode, but only output noise. When an external device is not being used, also remove the connector jack.
- When the external device power is connected to the power jack, playing the external device may output noise. In such cases, disconnect the power connection before use.
- Fully insert the AUX cable to the AUX jack upon use.

i Information - Before using the *Bluetooth*® handsfree

What is Bluetooth® ?

- *Bluetooth*® refers to a short-distance wireless networking technology which uses a 2.4GHz ~ 2.48GHz frequency to connect various devices within a certain distance.
- Supported within PCs, external devices, *Bluetooth*® phones, PDAs, various electronic devices, and automotive environments, *Bluetooth*® allows data to be transmitted at high speeds without having to use a connector cable.
- *Bluetooth*® Handsfree refers to a device which allows the user to conveniently make phone calls with *Bluetooth*® mobile phones through the audio system.
- *Bluetooth*® Handsfree may not be supported in some mobile phones. To learn more about mobile device compatibility, visit www.hyundaiusa.com.

i Information - Precautions for safe driving

- *Bluetooth*® Handsfree is a feature that enables drivers to practice safe driving. Connecting the head unit with a *Bluetooth*® phone allows the user to conveniently make and receive calls and use contacts. Before using *Bluetooth*®, carefully read the contents of this user's manual.
- Excessive use or operations while driving may lead to negligent driving practices and result in accidents. Refrain from excessive operations while driving.
- Viewing the screen for prolonged periods of time is dangerous and may lead to accidents. When driving, view the screen only for short periods of time.

i Information - When connecting a *Bluetooth*® phone

- Before connecting the head unit with the mobile phone, check to see that the mobile phone supports *Bluetooth*® features.
- Even if the phone supports *Bluetooth*®, the phone will not be found during device searches if the phone has been set to hidden state or the *Bluetooth*® power is turned off. Disable the hidden state or turn on the *Bluetooth*® power prior to searching/connecting with the Head unit.
- Bluetooth phone is automatically connected when the ignition on.
- If you do not want automatic connection with your *Bluetooth*® device, turn off the *Bluetooth*® feature within your mobile phone.
- The Handsfree call volume and quality may differ depending on the mobile phone.

(Continued)

(Continued)

- Park the vehicle when connecting the head unit with the mobile phone.
- **Bluetooth®** connection may become intermittently disconnected in some mobile phones. Follow these steps to try again.
 1. Within the mobile phone, turn the **Bluetooth®** function off/on and try again.
 2. Turn the mobile phone power Off/On and try again.
 3. Completely remove the mobile phone battery, reboot, and then again.
 4. Reboot the Audio System and try again.
 5. Delete all paired devices, pair and try again.
- Handsfree call quality and volume may differ depending on the model of your mobile phone.

i Information - Using the voice recognition

- When using the voice recognition feature, only commands listed within the user's manual are supported.
- Be aware that during the operation of the voice recognition system, pressing any key other than the  key terminate voice recognition mode.
- For superior voice recognition performance, position the microphone used for voice recognition above the head of the driver's seat and maintain a proper position when saying commands.
- Within the following situations, voice recognition may not function properly due to external sound.
 - When the windows and sunroof are open
 - When the wind of the cooling / heating device is strong
 - When entering and passing through tunnels

(Continued)

(Continued)

- When driving on rugged and uneven roads
- During severe rain (heavy rains, windstorms)
- Phone related voice commands can be used only when a **Bluetooth®** Wireless Technology device is connected.
- When making calls by stating a name, the corresponding contact must be downloaded and stored within the audio system.
- After downloading the **Bluetooth®** Wireless Technology phone book, it takes some times to convert the phone book data into voice information. During this time, voice recognition may not properly operate.
- Pronounce the voice commands naturally and clearly as if in a normal conversation.

The Bluetooth and Voice Recognition Manual is provided in two versions due to software version differences. Before reading the manual, check the following.

Press the  key in FM Radio screen.

1. If you can find "FM <89.1>" on the screen,
▶ (Go to 4-18 page)

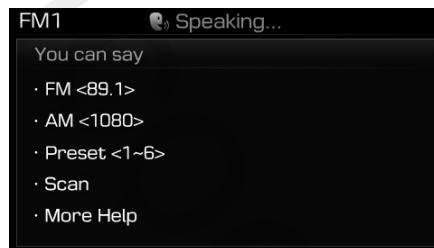
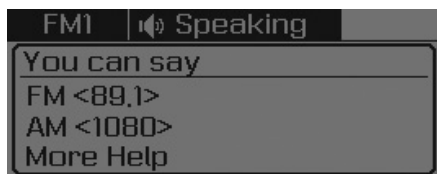

2. If you can find "FM <87.5~107.9>" on the screen,
▶ (Go to 4-111 page)

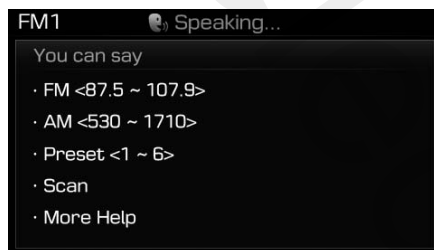
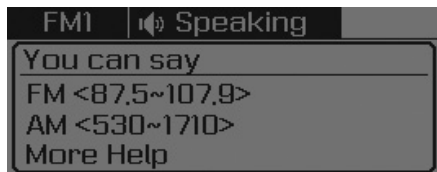

SYSTEM CONTROLLERS AND FUNCTIONS

Audio Head Unit



Name	Description
① ▲	Ejects the disc.
② RADIO	<ul style="list-style-type: none"> Each time the key is pressed, the mode is changed in order of FM1 → FM2 → AM → XM1 → XM2 → XM3 * In Setup>Display, the radio pop up screen will be displayed when [Mode Pop up] is turned On. <p>When the pop up screen is displayed, use the TUNE knob or keys 1 ~ 6 to select the desired mode.</p>

Name	Description
③ MEDIA	<ul style="list-style-type: none"> Each time the key is pressed, the mode is changed in order of CD, USB, iPod, AUX, My Music, BT Audio modes. * In Setup>Display, the media pop up screen will be displayed when [Mode Pop up] is turned On. <p>When the pop up screen is displayed, use the TUNE knob or keys 1 ~ 5 to select the desired mode.</p>
④ PHONE	<ul style="list-style-type: none"> Operates Phone Screen
⑤ SEEK TRACK	<ul style="list-style-type: none"> Radio Mode : Automatically searches for broadcast frequencies. CD, USB, iPod, My Music modes : <ul style="list-style-type: none"> Shortly press the key : Moves to next or previous song(file) Press and hold the key : Rewinds or fast-forwards the current song(file)
⑥ POWER/VOL knob	<ul style="list-style-type: none"> TUNE knob : Turns power On/Off by pressing the knob Volume Knob : Sets volume by turning the knob left/right
⑦ 1 ~ 6 (Preset)	<ul style="list-style-type: none"> Radio Mode : Saves frequencies (channels) or receives saved frequencies (channels) CD, USB, iPod, My Music mode <ul style="list-style-type: none"> 1 : Repeat 2 : Random



Name	Description
⑧ DISP	<ul style="list-style-type: none"> Each time the button is shortly pressed, it sets the screen Off → Screen On → Screen Off * Audio operation is maintained and only the screen will be turned Off. In the screen Off state, press any key to turn the screen On again.

Name	Description
⑨ SCAN	<ul style="list-style-type: none"> Radio Mode <ul style="list-style-type: none"> Shortly press the key : Previews each broadcast for 5 seconds each Press and hold the key : Previews the broadcasts saved in Preset 1 ~ 6 for 5 seconds each. * Press the SCAN key again to continue listening to the current frequency. SiriusXM RADIO Mode <ul style="list-style-type: none"> Press and hold the key : Previews all receivable broadcasts for 10 seconds each CD, USB, iPod mode <ul style="list-style-type: none"> Shortly press the key : Previews each song (file) for 10 seconds each * Press the SCAN key again to continue listening to the current song (file).
⑩ SETUP	<ul style="list-style-type: none"> Shortly press the key : Moves to the Display, Sound, Phone, System setting modes
⑪ MENU	<ul style="list-style-type: none"> Displays menus for the current mode.
⑫ ▼ CAT FOLDER ▲	<ul style="list-style-type: none"> Radio Mode SiriusXM RADIO : Category Search MP3 CD, USB mode : Folder Search * May differ depending on the selected audio
⑬ ● TUNE knob	<ul style="list-style-type: none"> Radio mode : Changes frequency by turning the knob left/right SiriusXM RADIO mode : Changes channel by turning the knob left/right CD, USB, iPod mode: Searches songs (files) by turning the knob left/right * When the desired song is displayed, press the knob to play the song.

SETUP

Display Settings

Press the **SETUP** key ▶ Select [Display] through **TUNE** knob or **1** key



Mode Pop up

[Mode Pop up] ▶ Changes On / Off selection mode

- During On state, press the **RADIO** or **MEDIA** key to display the mode change pop up screen.

Media Display

When playing an MP3 file, select the desired display info from 'Folder/File' or 'Album/Artist/Song'.



Sound Settings

Press the **SETUP** key ▶ Select [Sound] through **TUNE** knob or **2** key

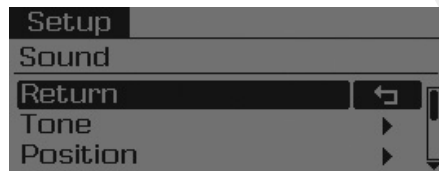

Tone

This menu allows you to set the Bass, Middle, Treble.

Select [Tone] ▶ Select menu through **TUNE** knob ▶ Turn **TUNE** knob left/right to set

- Bass, Middle, Treble : Selects the sound tone.
- Default : Restores default settings.
- * Return : While adjusting values, pressing the **TUNE** knob will restore the parent menu.

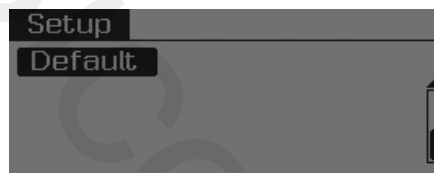

Position

This menu allows you to set the 'Bass, Middle, Treble' and the Sound Fader and Balance.

Select [Position] ▶ Select menu through **TUNE** knob ▶ Turn **TUNE** knob left/right to set.

- Fader, Balance : Selects the sound fader and balance.
- Default : Restores default settings.
- * Return : While adjusting values, pressing the **TUNE** knob will restore the parent menu.

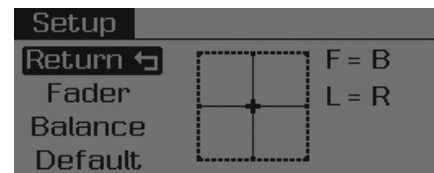

Speed Dependent Volume Control

This feature is used to automatically control the volume level according to the speed of the vehicle.

Select [SDVC] ▶ Turn SDVC On/Off by pressing the **Tune** knob.

Voice Recognition Volume

Adjusts voice recognition volume.

Select [Voice Recognition Vol.] ▶ Set volume of **TUNE** knob

System Settings

Press the **SETUP** key ▶ Select [System] through tune knob or **4** key

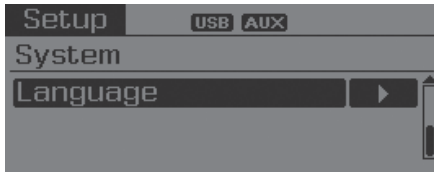
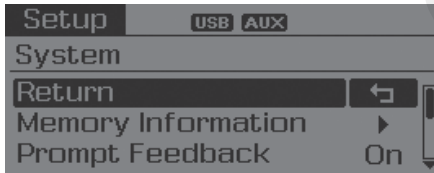

Memory Information

Displays currently used memory and total system memory.

Select [Memory Information] ▶ OK

The currently used memory is displayed on the left side while the total system memory is displayed on the right side.

Prompt Feedback

This feature is used to change voice command feedback between Normal and Expert modes.

Select [Prompt Feedback] ▶ Set through **TUNE** knob

- Normal(On) : This mode is for beginner users and provides detailed instructions during voice command operation.
- Expert(Off) : This mode is for expert users and omits some information during voice command operation. (When using Expert mode, guidance instructions can be heard through the [Help] or [Menu] commands.

Language

This menu is used to set the display and voice recognition language.

Select [Language] ▶ Set through **TUNE** knob



*The system will reboot after the language is changed.

*Language support by region
- English, Français, Español

RADIO : FM, AM, SiriusXM

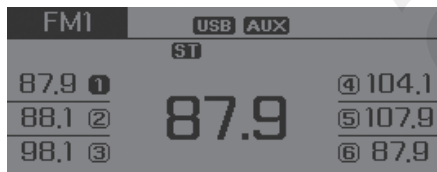

SEEK

Press the key

- Shortly pressing the key : Changes the frequency.
- Pressing and holding the key : Automatically searches for the next frequency.

Preset SEEK

Press the ~ key

- Shortly pressing the key : Plays the frequency saved in the corresponding key.
- Pressing and holding the key : Pressing and holding the desired key from ~ will save the currently playing broadcast to the selected key and sound a BEEP.

SCAN

Press the key

- Shortly pressing the key : The broadcast frequency increases and previews each broadcast for 5 seconds each. After scanning all frequencies, returns and plays the current broadcast frequency.
- Pressing and holding the key : Previews the broadcasts saved in Preset ~ for 5 seconds each.

Selecting through manual search

Turn the TUNE knob left/right to adjust the frequency.

Menu

Press the key ▶ Select [Auto Store] through the TUNE knob or key



A.Store

Saves broadcasts with superior reception to ~ keys. If no frequencies are received, then the most recently received frequency will be broadcast.

SiriusXM® SATELLITE RADIO INFORMATION

Satellite Radio channels:

Enjoy SiriusXM Satellite Radio with a 3-month trial subscription to the Sirius Select package. You'll get over 140 channels, including commercial-free music, plus all your favorite sports, exclusive talk, entertainment, and a selection of premium programming. For more information and a complete list of SiriusXM channels, visit siriusxm.com in the United States, siriusxm.ca in Canada, or call SiriusXM at 1-888-539-7474.

Satellite Radio reception factors:

To receive the satellite signal, your vehicle has been equipped with a satellite radio antenna located on the roof of your vehicle. The vehicle roof provides the best location for an unobstructed, open view of the sky, a requirement of a satellite radio system. Like AM/FM, there are several factors that can affect satellite radio reception performance:

- Antenna obstructions: For optimal reception performance, keep the antenna clear of snow and ice build-up and keep luggage and other material as far away from the antenna as possible.
- Terrain: Hills, mountains, tall buildings, bridges, tunnels, freeway overpasses, parking garages, dense tree foliage and thunderstorms can interfere with your reception.

SiriusXM Satellite Radio service:

SiriusXM is a subscription-based satellite radio service that broadcasts music, sports, news and entertainment programming to radio receivers, which are available for installation in motor vehicles or factory installed, as well as for the home, portable and wireless devices, and through an Internet connection on personal computer.

Vehicles that are equipped with a factory installed SiriusXM Satellite Radio system include:

- Hardware and an introductory trial subscription term, which begins on the date of sale or lease of the vehicle.
- For a small upgrade fee, access to SiriusXM music channels, and other select channels over the Internet using any computer connected to the Internet (U.S. customers only).

For information on extended subscription terms, contact SiriusXM at 1-888-539-7474.

NOTE:

SiriusXM services require a subscription sold separately, or as a package, by Sirius XM Radio Inc. If you decide to continue service after your trial, the subscription plan you choose will automatically renew thereafter and you will be charged according to your chosen payment method at then-current rates. Fees and taxes apply. To cancel you must call SiriusXM at 1-866-635-2349. See SiriusXM Customer Agreement for complete terms at www.siriusxm.com. SiriusXM U.S. satellite and data services are available only in the 48 contiguous USA, DC and PR (with coverage limitations). SiriusXM satellite service is also available in Canada; see www.siriusxm.ca. All fees and programming subject to change. Sirius, XM and all related marks and logos are trademarks of Sirius XM Radio Inc.

SiriusXM RADIO

Using SiriusXM Satellite Radio

Your Hyundai vehicle is equipped with a 3-month trial subscription to SiriusXM so you have access to over 140 channels of music, information, and entertainment programming.



Activation

In order to extend or reactivate your Sirius Select subscription, you will need to contact SiriusXM Customer Care at 1-800-643-2112. Have your 12-digit RID (Radio Identification Number) / ESN (Electronic Serial Number) ready. To retrieve the RID / ESN, turn on the radio, press the **RADIO** key, and tune to channel zero.

Please note that the vehicle will need to be turned on, in Sirius mode, and have an unobstructed view of the sky in order for the radio to receive the activation signal.

SEEK

Press the **SEEK TRACK** key

- Shortly pressing the key : select previous or next channel.
 - Pressing and holding the key : continuously move to previous or next channel.
- *If the "Category" icon is displayed, channels are changed within the current category.

SCAN

Press the **SCAN** key

- Shortly pressing the key : Previews each broadcast for 10 seconds each
- * Press the **SCAN** key again to continue listening to the current frequency
- * If the "Category" icon is displayed, channels are changed within the current category.

Category



Press the  key ▶ Set through the 



- The display will indicate the category menus, highlight the category that the current channel belongs to.
- In the Category List Mode, press the  key to navigate category list.
- Press the tune knob to select the lowest channel in the highlighted category.
- ※ If channel is selected by selecting category, then the “CATEGORY” icon is displayed at the top of the screen.

Preset

Press the  ~  key

- Shortly pressing the key (under 0.8 seconds): Plays the frequency saved in the corresponding key.
- Pressing and holding the key (over 0.8 seconds): Pressing and holding the desired key from  ~  will save the current broadcast to the selected key and sound a BEEP.

Information - Troubleshooting





1. Antenna Error

If this message is displayed, the antenna or antenna cable is broken or unplugged. Please consult with your Hyundai dealership.

2. No Signal

If this message is displayed, it means that the antenna is covered and that the SiriusXM Satellite Radio signal is not available. Ensure the antenna is uncovered and has a clear view of the sky.

Menu

Select category menu through the  ▶ Press the  key
▶ Select  through the  or  key

Info (Information)



Displays the Artist/Song info of the current song.

BASIC METHOD OF USE : Audio CD / MP3 CD / USB / iPod® / My Music



Name	Description
① Repeat	While song (file) is playing ▶ 1 RPT key Audio CD, MP3 CD, USB, iPod®, My Music mode: <ul style="list-style-type: none"> • Repeats the current song MP3 CD, USB mode: <ul style="list-style-type: none"> • Repeats songs within the current folder. (Pressing the key twice). *Press the 1 RPT key again to turn off repeat.
② Random	While song (file) is playing ▶ 2 RDM key Audio CD, iPod®, My Music mode: <ul style="list-style-type: none"> • Plays all songs randomly MP3 CD, USB mode: <ul style="list-style-type: none"> • Folder Random : Plays all files within the current folder in random order. • All Random : Plays all files in random order(Pressing the key twice). * Press the 2 RDM key again to turn off repeat.
③ Changing Song/File	While song (file) is playing ▶ SEEK TRACK key <ul style="list-style-type: none"> • Shortly pressing the key : plays the current song from the beginning / plays the next song. • Pressing and holding the key : Rewinds the song / fast forwards the song. * If the SEEK TRACK key is pressed again within 1 second, the previous song is played.



Name	Description
④ Scan	While song (file) is playing ► SCAN key Scans all songs for 10 seconds starting from the next song. * Press the SCAN key again to turn off. * The SCAN function is not supported in iPod® mode.
⑤ Folder Search : MP3 CD, USB Mode	While file is playing ► CAT FOLDER key • Searches the previous / next folder * If a folder is selected by pressing the TUNE knob, the first file within the selected folder will be played.

MENU : Audio CD

In Audio CD mode, press **MENU** key.



Repeat

Set [**1**RPT] through the **TUNE** knob or **1 RPT** key to repeat the current song.

* Press RPT again to turn off.

Random

Set [**2**RDM] through the **TUNE** knob or **2 RDM** key to randomly play songs within the current CD.

* Press RDM again to turn off.

Information

Set [**3**Info] through the **TUNE** knob or **3** key to display information of the current song.

* Press the **MENU** key to turn off info display.

MENU : MP3 CD / USB

In MP3 CD / USB mode, press **MENU** key.



Repeat

Set [**1**RPT] through the **TUNE** knob or **1 RPT** key to repeat the current song.

* Press RPT again to turn off.

Folder Random

Set [**2**F.RDM] through the **TUNE** knob or **2 RDM** key to randomly play songs within the current folder.

* Press F.RDM again to turn off.

Folder Repeat

Set [**3**F.RPT] through the **TUNE** knob or **3** key to repeat songs within the current folder.

* Press F.RPT again to turn off.

All Random

Set [**4**A.RDM] through the **TUNE** knob or **4** key to randomly play all songs within the CD/USB.

* Press A.RDM again to turn off.

Information

Set [**5**Info] through the **TUNE** knob or **5** key to display information of the current song.

* Press the **MENU** key to turn off info display.

Copy

Set [**6**Copy] through the **TUNE** knob or **6** key.

* This is used to copy the current song into My Music. You can play the copied Music in My Music mode.

* If another key is pressed while copying is in progress, a pop up asking you whether to cancel copying is displayed.

* If another media is connected or inserted (USB, CD, iPod®, AUX) while copying is in progress, copying is canceled.

* Music will not be played while copying is in progress.

MENU : iPod®

In iPod mode, press **MENU** key.



Repeat

Set [**1**RPT] through the **TUNE** knob or **1 RPT** key to repeat the current song.

* Press RPT again to turn repeat off.

Random

Set [**2**RDM] through the **TUNE** knob or **2 RDM** key.

Plays all songs within the currently playing category in random order.

* Press RDM again to turn off.

Information

Set [3]Info through the TUNE knob or 3 key.

Displays information of the current song.

* Press the MENU key to turn off info display.

Search

Set [4]Search through the TUNE knob or 4 key.

Displays iPod® category list.

* Searching iPod® category is MENU key pressed, move to parent category.

MENU : My Music Mode

In My Music mode, press MENU key.



Repeat

Set [1]RPT through the TUNE knob or 1 RPT key.

Repeats the currently playing song.

* Press RPT again to turn repeat off.

Random

Set [2]RDM through the TUNE knob or 2 RDM key.

Plays all songs within the currently playing folder in random order.

* Press RDM again to turn random off.

Information

Set [3]Info through the TUNE knob or 3 key.

Displays information of the current song.

* Press the MENU key to turn off info display.

Delete

Set [4]Delete through the TUNE knob or 4 key.

- Deletes currently playing file

In the play screen, pressing delete will delete the currently playing song.

- Deletes file from list

① Select the file you wish to delete by using the TUNE knob.



② Press the MENU key and select the delete menu to delete the selected file.

Delete All

Set **[5]Del.All** through the **TUNE** knob or **5** key.

Deletes all songs of My Music.

Delete Selection

Press the **MENU** key ▶ Set **[6]Del.Sel** through the **TUNE** knob or **6** key. Songs within My Music are selected and deleted.



① Select the songs you wish to delete from the list.



② After selecting, press the **MENU** key and select the delete menu.

AUX

AUX is used to play external MEDIA currently connected with the AUX terminal.

AUX mode will automatically start when an external device is connected to the AUX terminal.

If an external device is connected, you can also press the **MEDIA** key to change to AUX mode.



* AUX mode cannot be started unless there is an external device connected to the AUX terminal.

Bluetooth® Wireless Technology AUDIO

What is Bluetooth® Wireless Technology?

Bluetooth® Wireless Technology allows devices to be connected in a short distance, including hands-free devices, stereo headsets, wireless remote controllers, etc. For more information, visit the Bluetooth® Wireless Technology website at www.Bluetooth.com

Before using Bluetooth® Wireless Technology audio features

- Bluetooth® Wireless Technology audio may not be supported depending on the compatibility of your Bluetooth® Wireless Technology mobile phone.
- In order to use Bluetooth® Wireless Technology audio, you must first pair and connect the Bluetooth® Wireless Technology mobile phone.

- Bluetooth® Wireless Technology audio can be used only when the [Audio Streaming] of Phone is turned .

Starting Bluetooth® Wireless Technology Audio

- Press the **MEDIA** key to change the mode in order of CD → USB → AUX → My Music → BT Audio.
- If BT Audio is selected, Bluetooth® Wireless Technology audio will start playing.
- * Audio may not automatically start playing in some mobile phones.

Using the Bluetooth® Wireless Technology audio features



- Play / Stop

Press the  TUNE knob to play and pause the current song.



- * The title / artist info may not be supported in some mobile phone. When it is not supported, no title/no artist will be displayed.

- Previous / Next song





Press  or  to play previous or next song.

- * The previous song / next song / play / pause functions may not be supported in some mobile phones.

Making a call using the Steering wheel remote controller



The actual feature in the vehicle may differ from the illustration.

Name	Description
① MODE	<ul style="list-style-type: none"> Each time this key is pressed, the mode is changed in order of FM1 → FM2 → AM → XM1 → XM2 → XM3 → CD → USB or iPod → AUX → My Music → BT Audio If the media is not connected or a disc is not inserted, corresponding modes will be disabled.
② VOL+ VOL-	Raises or lowers speaker volume.
③  key	Places and transfers calls.
④  key	<p>Ends calls or cancels functions.</p> <ul style="list-style-type: none"> Check call history and making call <ul style="list-style-type: none"> Shortly press (under 0.8 seconds) the  key on the steering remote controller. The call history list will be displayed on the screen. Press the  key again to connect a call to the selected number. Redialing the most recently called number <ul style="list-style-type: none"> Press and hold (over 0.8 seconds) the  key on the steering remote controller. The most recently called number is redialed.

Bluetooth® Wireless Technology

Pairing a Bluetooth® Wireless Technology Device

What is Bluetooth® Wireless Technology Pairing?

Pairing refers to the process of synchronizing your Bluetooth® Wireless Technology phone or device with the car audio system for connection. Pairing is necessary to connect and use the Bluetooth® Wireless Technology feature.

! WARNING

Driving while distracted can result in a loss of vehicle control that may lead to an accident, severe personal injury, and death. The driver's primary responsibility is in the safe and legal operation of a vehicle, and use of any handheld devices, other equipment, or vehicle systems which take the driver's eyes, attention and focus away from the safe operation of a vehicle or which are not permissible by law should never be used during operation of the vehicle.

Phone (if equipped) Before using the Bluetooth® Wireless Technology phone features

- In order to use Bluetooth® Wireless Technology phone, you must first pair and connect the Bluetooth® Wireless Technology mobile phone.
- If the mobile phone is not paired or connected, it is not possible to enter Phone mode. Once a phone is paired or connected, the guidance screen will be displayed.
- If Priority is set upon vehicle ignition(IGN/ACC ON), the Bluetooth® Wireless Technology phone will be automatically connected. Even if you are outside, the first Bluetooth® Wireless Technology phone will be automatically connected once you are in the vicinity of the vehicle. If you do not want automatic Bluetooth® Wireless Technology phone connection, set the Bluetooth® Wireless Technology power to OFF.

Pairing **PHONE** key / key on the Steering Remote Controller

When No Devices have been Paired

1. Press the **PHONE** key or the  key on the steering remote controller. The following screen is displayed.

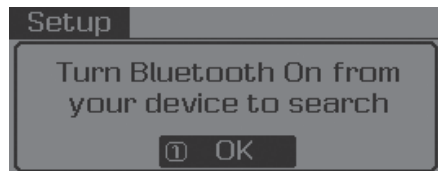

2. Select [OK] button to enter the Pair Phone screen.

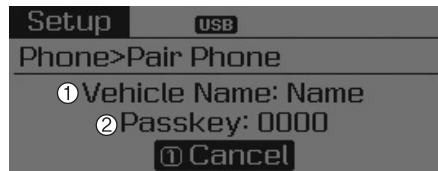

- 1) Vehicle Name : Name of device as shown when searching from your *Bluetooth*® Wireless Technology device
- 2) Passkey : Passkey used to pair the device
3. From your *Bluetooth*® Wireless Technology device (i.e. Mobile Phone), search and select your car audio system.
4. After a few moments, a screen is displayed 6 digits passkey. Hear, check the passkey on your *Bluetooth*® Wireless Technology device and confirm.



5. Once pairing is complete, the following screen is displayed.

During the pairing process, make sure that all connection requests on the phone are accepted for phonebook download and to allow acceptance of all future connection requests. Visit <http://www.hyundaiusa.com/Bluetooth> for additional information on pairing your Bluetooth-enabled mobile phone, and to view a phone compatibility list.

NOTICE



If *Bluetooth*® Wireless Technology devices are paired but none are currently connected, pressing the **PHONE** key or the  key on the steering wheel displays the following screen. Select [Pair] button to pair a new device or select [Connect] to connect a previously paired device.

Pairing through [PHONE] Setup

Press the **SETUP** key ▶ Select [Phone] ▶ Select [Pair Phone] ▶ Select **TUNE** knob



1. The following steps are the same as those described in the section "When No Devices have been Paired" on the previous page.

i Information

- **Bluetooth®** Wireless Technology features supported within the vehicle are as follows. Some features may not be supported depending on your **Bluetooth®** Wireless Technology device.

- **Outgoing/Incoming Handsfree calls**

(Continued)

(Continued)

- Operations during a call (Switch to Private, Switch to call waiting, MIC on/off)
- Downloading Call History
- Downloading Mobile Contacts
- **Bluetooth®** Wireless Technology device auto connection
- Bluetooth Audio Streaming
- Up to five **Bluetooth®** Wireless Technology devices can be paired to the Car Handsfree system.
- Only one **Bluetooth®** Wireless Technology device can be connected at a time.
- Other devices cannot be paired while a **Bluetooth®** Wireless Technology device is connected.
- Only **Bluetooth®** Wireless Technology Handsfree and Bluetooth audio related features are supported.
- Bluetooth related operations are possible only within devices that support Handsfree or audio features, such as a **Bluetooth®** Wireless Technology mobile phone or a Bluetooth audio device.

(Continued)

(Continued)

- If a connected **Bluetooth®** Wireless Technology device becomes disconnected due to being out of communication range, turning the device OFF, or a **Bluetooth®** Wireless Technology communication error, corresponding **Bluetooth®** Wireless Technology devices are automatically searched and reconnected.
- If the system becomes unstable due to communication errors between the car Handsfree and the **Bluetooth®** Wireless Technology device, reset the device by turning off and back on again. Upon resetting **Bluetooth®** Wireless Technology device, the system will be restored.
- After pairing is complete, a contacts download request is sent once to the mobile phone. Some mobile phones may require confirmation upon receiving a download request, ensure your mobile phone accepts the connection. Refer to your phone's user's manual for additional information regarding phone pairing and connections.

Connecting a Device

Press the **SETUP** key ▶ Select [Phone] ▶ Select [Phone List]



- 1) Connected Phone : Device that is currently connected
- 2) Paired Phone : Device that is paired but not connected

From the paired phone list, select the device you want to connect and select [Connect].

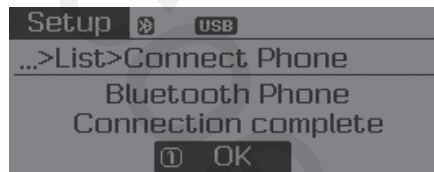

Changing Priority

What is Priority?

It is possible to pair up to five *Bluetooth*® Wireless Technology devices with the car audio system. The "Change Priority" feature is used to set the connection priority of paired phones.

Press the **SETUP** key ▶ Select [Phone] ▶ Select [Phone List]

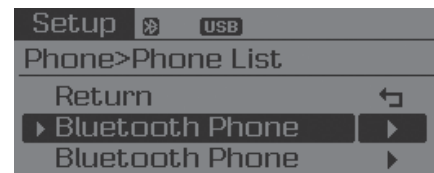

From the paired phone list, select the phone you want to switch to the highest priority, then select [Change Priority] button from the Menu. The selected device will be changed to the highest priority.



NOTICE

Priority icon will be displayed when the selected phone is set as a priority phone.

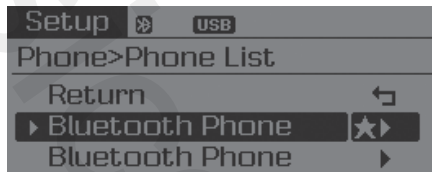

Disconnecting a Device

Press the **SETUP** key ▶ Select [Phone] ▶ Select [Phone List]

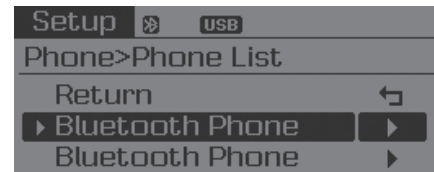

From the paired phone list, select the currently connected device and select [Disconnect] button.

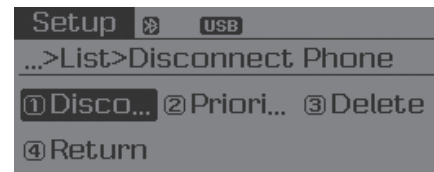

Deleting a Device

Press the **SETUP** key ▶ Select [Phone] ▶ Select [Phone List]

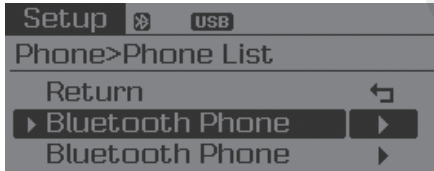

From the paired phone list, select the device you want to delete and select [Delete] button.



i Information

- When deleting the currently connected device, the device will automatically be disconnected to proceed with the deleting process.
- If a paired *Bluetooth*® Wireless Technology device is deleted, the device's call history and contacts data will also be deleted.
- To re-use a deleted device, you must pair the device again.

Pairing a New Device

Press the **SETUP** key ▶ Select [Phone] ▶ Select [Pair Phone]

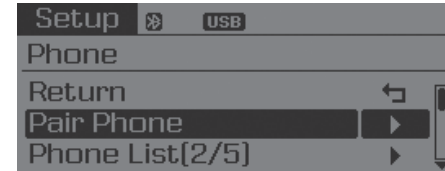

Bluetooth® Wireless Technology devices can be paired with the audio system.

For more information, refer to the "Pairing through Phone Setup" section within *Bluetooth*® Wireless Technology.

Viewing Paired Phone List

Press the **SETUP** key ▶ Select [Phone] ▶ Select [Phone List]

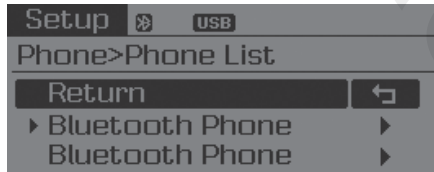

This feature is used to view mobile phones that have been paired with the audio system. Upon selecting a paired phone, the setup menu is displayed.

For more information, refer to the "Setting *Bluetooth*® Wireless Technology Connection" section within *Bluetooth*® Wireless Technology.

- 1) Connect/Disconnect Phone : Connect/ disconnects currently selected phone
- 2) Change Priority : Sets currently selected phone to highest connection priority
- 3) Delete : Deletes the currently selected phone
- 4) Return : Moves to the previous screen

i Information - Before downloading contacts

- Only contacts within connected phones can be downloaded. Also check to see that your mobile phone supports the download feature.
- To learn more about whether your mobile phone supports contacts downloads, refer to your mobile phone user's manual.
- The contacts for only the connected phone can be downloaded.

Downloading Contacts

Press the **SETUP** key ▶ Select [Phone] ▶ Select [Contacts Download]



As the contacts are downloaded from the mobile phone, a download progress bar is displayed.

i Information

- Upon downloading phone contacts, the previous corresponding data is deleted.
- This feature may not be supported in some mobile phones.
- Voice Recognition may not operate while contacts are being downloaded.

Outgoing Volume

Press the **SETUP** key ▶ Select [Phone] ▶ Select [Outgoing Volume]
Use **TUNE** knob to adjust the outgoing volume level.

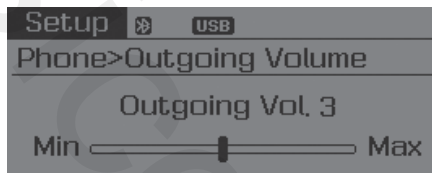

i Information

While on a call, the volume can be changed by using the **SEEK TRACK** key.

Turning Bluetooth System Off

Press the **SETUP** key ▶ Select [Phone] ▶ Select [Bluetooth System Off]

Once *Bluetooth*® Wireless Technology is turned off, *Bluetooth*® Wireless Technology related features will not be supported within the audio system.

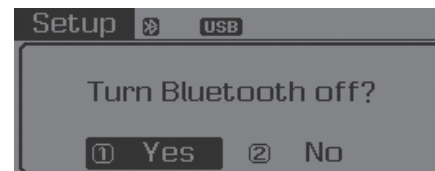
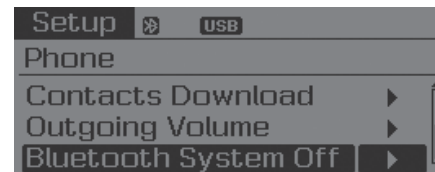

i Information

To turn *Bluetooth*® Wireless Technology back on, go to **SETUP** ▶ [Phone] and select “Yes”.

Phone Menu Screen

Phone Menus

With a *Bluetooth*® Wireless Technology device connected, press the **PHONE** key to display the Phone menu screen.



- 1) Favorite : Up to 20 frequently used contacts saved for easy access
- 2) Call History : Device the call history list screen
- 3) Contacts : Displays the Contacts list screen
- 4) Setup : Displays Phone related settings.

i Information

- If you select the [Call History] button but there is no call history data, a prompt is displayed which asks to download call history data.
- If you select the [Contacts] button but there is no contacts data stored, a prompt is displayed which asks to download contacts data.
- This feature may not be supported in some mobile phones. For more information on download support, refer to your mobile phone user's manual.

Answering Calls

Answering a Call

Answering a call with a *Bluetooth*® Wireless Technology device connected will display the following screen.

To accept the call, press **[CALL]** key on the steering wheel while the call is incoming.



- 1) Caller : Displays the other party's name when the incoming caller is saved within your contacts
- 2) Incoming Number : Displays the incoming number

i Information

- When an incoming call pop-up is displayed, most Audio and SETUP mode features are disabled. Only the call volume will operate.
- The telephone number may not be properly displayed in some mobile phones.

Favorites

Press the **PHONE** key ▶ Select [Favorites]



- 1) Saved favorite contact : Connects call upon selection
- 2) To add favorite : Downloaded contacts be saved as favorite.

i Information

- To save Favorite, contacts should be downloaded.
- Contact saved in Favorites will not be automatically updated if the contact has been updated in the phone. To update Favorites, delete the Favorite and create a new Favorite.

Call History

Press the **PHONE** key ▶ Select [Call History]



A list of incoming, outgoing and missed calls is displayed.

- Call history may not be saved in the call history list in some mobile phones.
- Calls received with hidden caller ID will not be saved in the call history list.
- Calling through the call history is not possible when there is no call history stored or a *Bluetooth*® Wireless Technology phone is not connected.
- Up to 50 received, dialed and missed calls are stored in Call History.
- Time of received/dialed calls and call time information are not saved.

Contacts

Press the **PHONE** key ▶ Select [Contacts]



The list of saved phone book entries is displayed.

NOTE:

Find a contact in an alphabetical order, press the **MENU** key.



i Information

- Up to 1,000 contacts saved in your *Bluetooth*® Wireless Technology phone can be downloaded into the car contacts. Contacts that have been downloaded to the car cannot be edited or deleted on the phone.
- Mobile phone contacts are managed separately for each paired *Bluetooth*® Wireless Technology device (max 5 devices x 1,000 contacts each). Previously downloaded data is maintained even if the *Bluetooth*® Wireless Technology device has been disconnected.

(However, the contacts and call history saved to the phone will be deleted if a paired phone is deleted.)

- It is possible to download contacts during Bluetooth streaming audio.
- When downloading contacts, the icon will be displayed within the status bar.

(Continued)

- It is not possible to begin downloading a contact list when the contact download feature has been turned off within the *Bluetooth*® Wireless Technology device. In addition, some devices may require device authorization upon attempting to download contacts. If downloading does not normally occur, check the *Bluetooth*® Wireless Technology device settings or the screen state.
- The contacts download feature may not be supported in some mobile phones. For more information of supported *Bluetooth*® devices and function support, refer to your phone's user manual.

(Continued)

VOICE RECOGNITION

Using Voice Recognition

Starting Voice Recognition

Shortly press the  key on the steering wheel. Say a command.

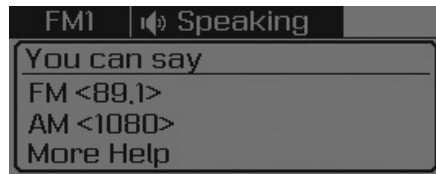

If prompt feedback is in [ON], then the system will say “Please say a command after the beep (BEEP)”

- If prompt feedback is in [OFF] mode, then the system will only say “(BEEP)”
- To change Prompt Feedback [On]/[Off], go to **SETUP** ▶ [System] ▶ [Prompt Feedback]

Information

For proper recognition, say the command after the voice instruction and beep tone.

Contact List Best Practices

- 1) Do not store single-name entries (e.g., “Bob”, “Mom”, “Kim”, etc.). Instead, always use full names (including first and last names) for all contacts (e.g., use “Jacob Stevenson” instead of “Dad”).
- 2) Do not use abbreviations (i.e., use “Lieutenant” instead of “Lt.” or “Sergeant” instead of “Sgt.”).
- 3) Do not use acronyms (i.e., use “County Finance Department” instead of “CFD”).
- 4) Do not use special characters (e.g., “@”, “hyphen -”, “asterisk *”, “ampersand &”).
- 5) If a name is not recognized from the contact list, change it to a more descriptive name (e.g., use “Grandpa Joseph” instead of “Pa Joe”).

Skipping Prompt Messages

While prompt message is being stated ▶ Shortly press the  key on the steering remote controller

The prompt message is immediately ended and the beep tone will sound. After the “beep”, say the voice command.

Re-starting Voice Recognition

While system waits for a command ▶ Shortly press the  key on the steering remote controller

The command wait state is immediately ended and the beep tone will sound. After the “beep”, say the voice command.

ENDING VOICE RECOGNITION

While Voice Recognition is operating

- ▶ Press and hold the  key on the steering remote controller

Information

- While using voice command, pressing any steering wheel control or a different key will end voice command.
- When the system is waiting for a voice command, say “cancel” or “end” to end voice command.
- When the system is waiting for a voice command, press and hold the  key on the steering wheel to end voice command.

Voice Recognition and Phone Contact Tips:

The Hyundai Voice Recognition System may have difficulty understanding some accents or uncommon names.

When using Voice Recognition to place a call, speak in a moderate tone, with clear pronunciation To maximize the use of Voice Recognition, consider these guidelines when storing contacts:

- Do not store single-name entries (e.g., “Bob”, “Mom”, etc.). Instead, always use full names (including first and last names) for these contacts
- Do not use special characters (e.g., '@', '-', '*', '&', etc.)
- Do not use abbreviations (i.e., use “Lieutenant” instead of “Lt.”) or acronyms (i.e., use “County Finance Department” instead of “C. F. D.”; Be sure to say the name exactly as it is entered in the contacts list

Illustration on using voice commands

- Starting voice command.

Shortly pressing the  key (under 0.8 seconds):

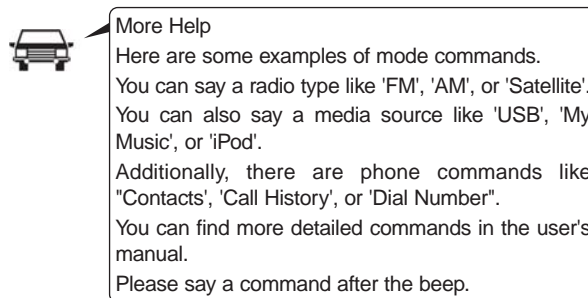
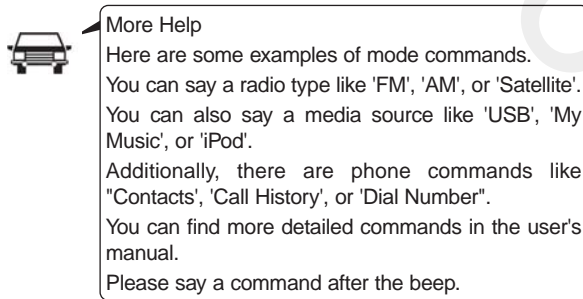
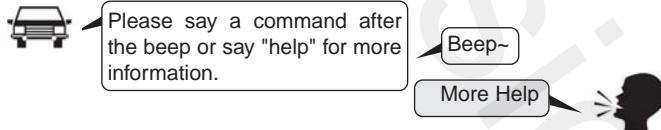

- Skipping Voice Recognition

Shortly pressing the  key (under 0.8 seconds):



Shortly pressing the  key (under 0.8 seconds):



- Ending voice command.

Shortly pressing the  key (under 0.8 seconds):

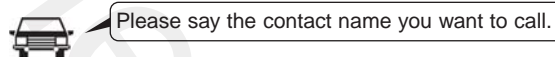
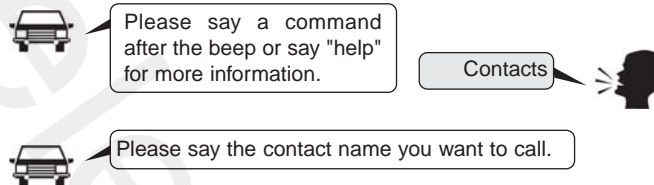

Voice Command List

- Common Commands: These commands can be used in most operations. (However a few commands may not be available during certain operations)

Command	Function
More Help	Provides guidance on commands that can be used anywhere in the system.
Help	Provides guidance on commands that can be used within the current mode.
Call<Name>	Calls <Name> saved in Contacts Ex) Call "John Smith"
Call <Name> on Mobile	Calls <Name> to the number that is saved as "Mobile" in Contacts Ex) Call "John Smith" on Mobile
Call <Name> in Office	Calls <Name> to the number that is saved as "Office" in Contacts Ex) Call "John Smith" in Office
Call <Name> at Home	Calls <Name> to the number that is saved as "Home" in Contacts Ex) Call "John Smith" at Home
Call <Name> on Other	Calls <Name> to the number that is saved as "Other" in Contacts Ex) Call "John Smith" on Other
Phone	Provides guidance on Phone related commands. After saying this command, say "Favorites", "Call History", "Contacts" or "Dial Number" execute corresponding functions.
Favorites	Displays the Favorite screen.
Call History	Displays the Call History screen.

Command	Function
Contacts (Call by Name)	Displays the Contacts screen. After saying this command, say the name of a contact saved in the Contacts to automatically connect the call.
Dial Number	Displays the Dial number screen. After saying this command, you can say the number that you want to call.
Redial	Connects the last dialed call number.
Tutorial	Provides guidance on how to use voice recognition and Bluetooth® connections.
Radio	<ul style="list-style-type: none"> • When listening to the radio, displays the next radio screen. (FM1→FM2→AM→XM1→XM2→XM3→FM1) • When listening to a different mode, displays the most recently played radio screen. • When currently listening to the FM radio, maintains the current state. • When listening to a different mode, displays the most recently played FM screen.
FM1(FM One)	Displays the FM1 screen.
FM2(FM Two)	Displays the FM2 screen.
AM	Displays the AM screen.

Command	Function
FM Preset 1~6	Plays the most recently played broadcast saved in FM Preset 1~6.
AM Preset 1~6	Plays the broadcast saved in AM Preset 1~6.
FM 87.5~107.9	Plays the FM broadcast of the corresponding frequency.
AM 530~1701	Plays the AM broadcast of the corresponding frequency.
XM (Satellite)	<ul style="list-style-type: none"> • When currently listening to the SiriusXM®, maintains the current state. • When listening to a different mode, displays the most recently played SiriusXM® screen.
XM (Satellite) 1~3	Displays the selected SiriusXM® screen.
XM Channel 0~223	Plays the selected SiriusXM® channel.
Media	Moves to the most recently played media screen.
CD	Plays the music saved in the CD.
USB	Plays USB music.
iPod®	Plays iPod music.
My Music	Plays the music saved in My Music.
AUX (Auxiliary)	Plays the connected external device.
Bluetooth® Audio	Plays the music saved in connected Bluetooth® device.
Mute	Mutes the sound

Command	Function
Cancel (Exit)	Ends voice command.

- FM/AM radio commands: Commands available during FM, AM radio operation

Command	Function
Preset 1~6	Plays the broadcast station saved in Preset 1~6.
Scan	Scans receivable frequencies from the current broadcast and plays for 10 seconds each.
Preset Scan	Moves to the next preset from the current present and plays for 10 seconds each.
Information	Displays the information of the current broadcast. (This feature can be used when receiving RBDS broadcasts.)

- Satellite radio commands: Commands that can be used while listening to Satellite Radio.

Command	Function
Channel 0~255	Play the selected Satellite Radio channel.
Scan	Scans receivable channels from the current broadcast and plays for 10 seconds each.
Preset 1~6	Plays the broadcast saved in Preset 1~6.
Information	Displays the information of the current broadcast.

- Audio CD commands: Commands available during Audio CD operation

Command	Function
Random	Randomly plays the tracks within the CD.
Random Off	Cancels random play to play tracks in sequential order.
Repeat	Repeats the current track.
Repeat Off	Cancels repeat play to play tracks in sequential order.
Track 1~30	Plays the desired track number.

- MP3 CD / USB commands: Commands available during USB and MP3 CD operation

Command	Function
Random	Randomly plays the files within the current folder.
Random Off	Cancels random play to play files in sequential order.
Repeat	Repeats the current file.
Repeat Off	Cancels repeat play to play files in sequential order.
Information	Displays the information screen of the current file.
Next Folder	Play the first file in the next folder
Previous Folder	Play the first file in the previous folder

- iPod® Commands: Commands available during iPod® operation

Command	Function
Random	Randomly plays the songs within the current category.
Random Off	Cancels random play to play songs in sequential order.
Repeat	Repeats the current song.
Repeat Off	Cancels repeat play to play songs in sequential order.

- My Music Commands: Commands available during My Music operation

Command	Function
Random	Randomly plays all saved files.
Random Off	Cancels random play to play files in sequential order.
Repeat	Repeats the current file.
Repeat Off	Cancels repeat play to play files in sequential order.
Delete	Deletes the current file. You will bypass an additional confirmation process.

- Bluetooth® Wireless Technology Audio Commands: Commands available during Bluetooth® Wireless Technology audio streaming from mobile phone operation Command Operation

Command	Function
Play	Plays the currently paused song.
Pause	Pauses the current song.

i Information

iPod® is a registered trademark of Apple Inc. iPod® mobile digital device sold separately. The Bluetooth® word mark and logos are registered trademarks owned by Bluetooth® SIG, Inc. and any use of such marks by Hyundai is under license. SiriusXM services require a subscription sold separately, or as a package, by Sirius XM Radio Inc. If you decide to continue service after your trial, the subscription plan you choose will automatically renew thereafter and you will be charged according to your chosen payment method at the current rates. Fees and taxes apply. To cancel you must call SiriusXM at 1-866-635-2349. See SiriusXM Customer Agreement for complete terms at www.siriusxm.com. SiriusXM U.S. satellite and data services are available only in the 48 contiguous USA, DC and PR (with coverage limitations). SiriusXM satellite service is also available in Canada; see www.siriusxm.ca. All fees and programming subject to change.

(Continued)

(Continued)

Sirius, XM and all related marks and logos are trademarks of Sirius XM Radio Inc. Android™ is a trademark of Google, Inc. BlackBerry is a registered trademark of Research In Motion Limited (RIM). All other marks, channel names and logos are the property of their respective owners. All rights reserved.

SYSTEM CONTROLLERS AND FUNCTIONS

Audio Head Unit



Name	Description
①	Ejects the disc.
② RADIO	<ul style="list-style-type: none"> Convert to Radio mode. Each time the key is pressed, the mode is changed in order of FM1, FM2, AM, XM1, XM2, XM3.
③ MEDIA	<ul style="list-style-type: none"> Convert to Media Mode Each time the key is pressed, the mode is changed in order of CD, USB(iPod®), AUX, My Music, BT Audio.

Name	Description
④ PHONE	<p>(for <i>Bluetooth</i>® Wireless Technology equipped model)</p> <ul style="list-style-type: none"> Converts to Phone mode * When a phone is not connected, the connection screen is displayed.
⑤	<ul style="list-style-type: none"> Power : Press to turn power on/off. Volume : Turn left/right to control volume.
⑥	<ul style="list-style-type: none"> When pressed shortly <ul style="list-style-type: none"> Radio mode : plays previous/next frequency. Media (CD/USB/iPod®/My Music) modes : changes the track, Song(file) When pressed and held <ul style="list-style-type: none"> Radio mode : continuously changes the frequency. Upon release, plays the current frequency. Media(CD/USB/iPod®/My Music) modes : rewinds or fast forwards the track or file During a Handsfree call, controls the call volume.
⑦	<ul style="list-style-type: none"> SiriusXM RADIO : Category Search MP3 CD/USB mode : Search Folder







No **dimension** will be shown if the **dimension** feature is not supported.

Name	Description
⑧ DISP	<ul style="list-style-type: none"> • Turns the monitor display on/off.
⑨ MUTE	<ul style="list-style-type: none"> • When the button is pressed, stops sound and "Audio Mute" is displayed on LCD.
⑩ SCAN	<ul style="list-style-type: none"> • Radio Mode : previews all receivable broad casts for 5 seconds each • SiriusXM RADIO Mode : previews all receivable broadcasts for 10 seconds each. broadcasts for 10 seconds each • Media (CD/USB/My Music) modes : previews each song (file) for 10 seconds each.
⑪ SETUP	<ul style="list-style-type: none"> • Converts to Setup mode.
⑫ TUNE knob	<ul style="list-style-type: none"> • Radio mode : turn to change broadcast frequencies. • SiriusXM RADIO Mode : turn to change broadcast channels • Media (CD/USB/iPod®/My Music) modes : turn to search tracks/ channels/files.



Steering-Wheel Mounted Controls



The actual feature in the vehicle may differ from the illustration.

Name	Description
① 	<ul style="list-style-type: none"> • When pressed shortly <ul style="list-style-type: none"> - Starts voice recognition - When selecting during a voice prompt, stops the prompt and converts to voice command waiting state • When pressed and held (over 0.8 seconds) <ul style="list-style-type: none"> - Ends voice recognition
② MODE	<ul style="list-style-type: none"> • Each time this key is pressed, the mode is changed in order of FM1 → FM2 → AM → XM1 → XM2 → XM3 → CD → USB or iPod → AUX → My Music → BT Audio • If the media is not connected or a disc is not inserted, corresponding modes will be disabled.
③  , 	Used to control volume.
④  , 	<ul style="list-style-type: none"> • When pressed shortly (under 0.8 seconds) <ul style="list-style-type: none"> - Radio mode : searches broadcast frequencies and channels saved to presets. - Media(CD / USB / iPod® / My Music / BT Audio) modes : changes the track, file or chapter. • When pressed and held (over 0.8 seconds) <ul style="list-style-type: none"> - Radio mode, automatically searches broadcast frequencies and channels - Media(CD / USB / iPod® / My Music) modes, rewinds or fast forwards the track or song(file) - BT Audio mode may not be supported in some mobile phones.



Name	Description
⑤ 	<ul style="list-style-type: none"> • When pressed shortly <ul style="list-style-type: none"> - When pressed in the phone screen, displays call history screen - When pressed in the dial screen, makes a call - When pressed in the incoming call screen, answers the call - When pressed during call waiting, switches to waiting call (Call Waiting) • When pressed and held (over 0.8 seconds) <ul style="list-style-type: none"> - When pressed in the <i>Bluetooth</i>[®] Wireless Technology Handsfree wait mode, redials the last call - When pressed during a <i>Bluetooth</i>[®] Wireless Technology Handsfree call, switches call back to mobile phone (Private) - When pressed while calling on the mobile phone, switches call back to <i>Bluetooth</i>[®] Wireless Technology Handsfree (Operates only when <i>Bluetooth</i>[®] Wireless Technology Handsfree is connected)
⑥ 	Ends phone call

RADIO MODE

Basic Mode Screen



1. Mode Display
Displays currently operating mode.

2. Frequency
Displays the current frequency.

3. Preset
Displays current preset number P1 ~ P6.

4. Preset Display
Displays preset buttons.

5. A.store
Automatically saves frequencies with superior reception to Preset buttons.

Switching to Radio Mode

Pressing the **RADIO** key will change the operating mode in order of FM1 → FM2 → AM → XM1 → XM2 → XM3

If [Mode Pop up] is turned on within **SETUP** ▶ [Display], then pressing the **RADIO** key will display the Radio Pop-up Mode screen.

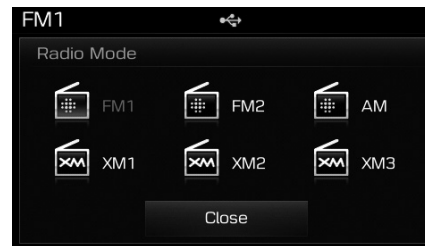

Turn the **TUNE** knob to move the focus. Press the knob to select.

Searching Radio Frequencies

Using Seek

Press the  key to play the previous/next frequency.

Using TUNE

Turn the  TUNE knob to select the desired frequency.

- FM : Increases/decreased by 200kHz
- AM : Increased/decreased by 9 (Only GUAM), 10kHz

Using Radio Mode

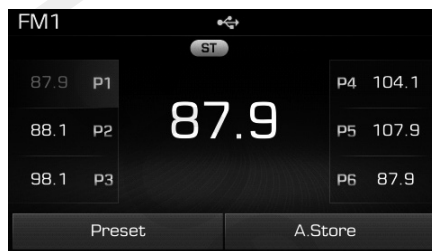

Selecting Presets/Saving Presets

Press the  button to display the broadcast information for the frequency saved to each button.



Press the  ~  buttons to play the desired preset.

Information

While listening to a frequency you want to save as a preset, press and hold one of the  ~  preset buttons (over 0.8 seconds) to save the current frequency to the selected preset.

Auto Store

Press the  button to automatically save receivable frequencies to Preset buttons.

Information

While Auto Store is operating, pressing the  button again will cancel Auto Store and restore the previous frequency.

Scan

Press the  key to preview frequencies with superior reception for 5 seconds each.

Press and hold the  key (over 0.8 seconds) to preview presets for 5 seconds each.

Once scan is complete, the previous frequency will be restored.

While Scan is operating, pressing the  key will cancel the scan operation.

SiriusXM® Satellite Radio information

Satellite Radio channels:

Enjoy SiriusXM Satellite Radio with a 3-month trial subscription to the Sirius Select package. You'll get over 140 channels, including commercial-free music, plus all your favorite sports, exclusive talk, entertainment, and a selection of premium programming. For more information and a complete list of SiriusXM channels, visit siriusxm.com in the United States, siriusxm.ca in Canada, or call SiriusXM at 1-888-539-7474.

Satellite Radio reception factors:

To receive the satellite signal, your vehicle has been equipped with a satellite radio antenna located on the roof of your vehicle. The vehicle roof provides the best location for an unobstructed, open view of the sky, a requirement of a satellite radio system. Like AM/FM, there are several factors that can affect satellite radio reception performance:

- **Antenna obstructions:** For optimal reception performance, keep the antenna clear of snow and ice build-up and keep luggage and other material as far away from the antenna as possible.
- **Terrain:** Hills, mountains, tall buildings, bridges, tunnels, freeway overpasses, parking garages, dense tree foliage and thunderstorms can interfere with your reception.

SiriusXM Satellite Radio service:

SiriusXM is a subscription-based satellite radio service that broadcasts music, sports, news and entertainment programming to radio receivers, which are available for installation in motor vehicles or factory installed, as well as for the home, portable and wireless devices, and through an Internet connection on personal computer.

Vehicles that are equipped with a factory installed SiriusXM Satellite Radio system include:

- Hardware and an introductory trial subscription term, which begins on the date of sale or lease of the vehicle.
- For a small upgrade fee, access to SiriusXM music channels, and other select channels over the Internet using any computer connected to the Internet (U.S. customers only).

For information on extended subscription terms, contact SiriusXM at 1-888-539-7474.

NOTE:

SiriusXM services require a subscription sold separately, or as a package, by Sirius XM Radio Inc. If you decide to continue service after your trial, the subscription plan you choose will automatically renew thereafter and you will be charged according to your chosen payment method at then-current rates. Fees and taxes apply. To cancel you must call SiriusXM at 1-866-635-2349. See SiriusXM Customer Agreement for complete terms at www.siriusxm.com. SiriusXM U.S. satellite and data services are available only in the 48 contiguous USA, DC and PR (with coverage limitations). SiriusXM satellite service is also available in Canada; see www.siriusxm.ca. All fees and programming subject to change. Sirius, XM and all related marks and logos are trademarks of Sirius XM Radio Inc.

SiriusXM RADIO MODE

Basic Mode Screen

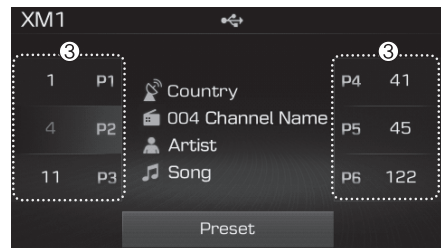
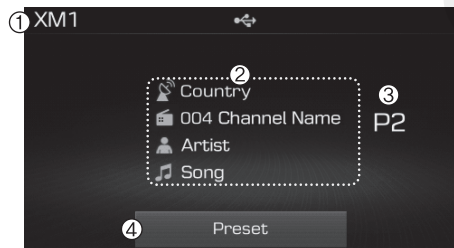

1. Mode Display

Displays currently operating mode.

2. Channel Information

Displays the category, channel number, channel name, artist and title information.

3. Preset

Displays currently playing preset number **P1** ~ **P6**.

4. Preset Display

Displays saved presets.

Using SiriusXM Satellite Radio

Your Hyundai vehicle is equipped with a 3-month trial subscription to SiriusXM so you have access to over 140 channels of music, information, and entertainment programming.

Activation

In order to extend or reactivate your Sirius Select subscription, you will need to contact SiriusXM Customer Care at 1-800-643-2112. Have your 12-digit RID (Radio Identification Number) / ESN (Electronic Serial Number) ready. To retrieve the RID / ESN, turn on the radio, press the **RADIO** key, and tune to channel zero.

Please note that the vehicle will need to be turned on, in Sirius mode, and have an unobstructed view of the sky in order for the radio to receive the activation signal.

Using SEEK

Press the **SEEK TRACK** key to play the previous/next channel.

*If the "Category" icon is displayed, channels are changed within the current category.

SCAN

Press the **SCAN** key to scan all channels with superior reception for 5 seconds each.

Once scan is complete, the previously played channel will be restored.

During Scan, pressing the **SCAN** key again will cancel the scan operation and restore the previously played channel.

If the “Category” icon is displayed, channels are changed within the current category.

Searching Categories

Select the category by using the **CAT FOLDER** key and press the **TUNE** knob to select.

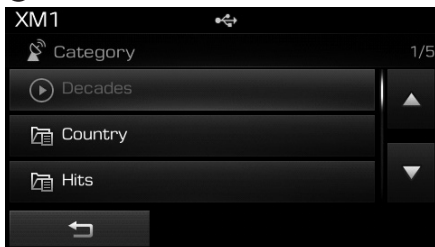

Channels for the selected category are played.

i Information - Troubleshooting

1. Antenna Error

If this message is displayed, the antenna or antenna cable is broken or unplugged. Please consult with your Hyundai dealership.

2. No Signal

If this message is displayed, it means that the antenna is covered and that the SiriusXM Satellite Radio signal is not available. Ensure the antenna is uncovered and has a clear view of the sky.

Selecting Presets/Saving Presets

Press the **Preset** button to display the broadcast information for the channel saved to each button.

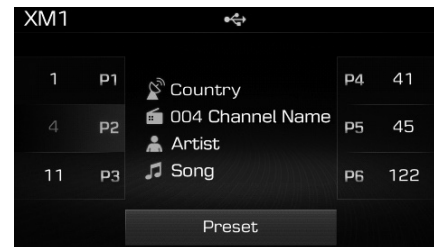

Press the **P1** ~ **P6** buttons to play the desired preset.

i Information

While listening to a channel you want to save as a preset, press and hold one of the **P1 ~ **P6** preset buttons to save the current channel to the selected preset.**

MEDIA MODE

Pressing the **MEDIA** key will change the operating mode in order of CD → USB(iPod®) → AUX → My Music → BT Audio.

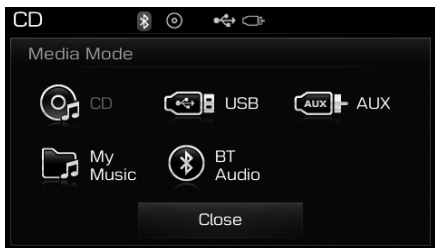

If [Mode Pop up] is turned on within **SETUP** ▶ [Display], then pressing the **MEDIA** key will display the Media Pop-up Mode screen.

Turn the **TUNE** knob to move the focus. Press the knob to select.

i Information

The media mode pop up screen can be displayed only when there are two or more media modes turned on.

Title Icon

When a *Bluetooth*® Wireless Technology, iPod®, USB, or AUX device is connected or a CD is inserted, the corresponding mode icon will be displayed.



Icon	Title
	<i>Bluetooth</i> ® Wireless Technology
	CD
	iPod®
	USB
	AUX



AUDIO CD MODE

Using Audio CD Mode

Playing/Pausing CD Tracks

Once an audio CD is inserted, the mode will automatically start and begin playing.



While playing, press the  button to pause and press  button to play.



Information

- Only genuine audio CDs are supported. Other discs may result in recognition failure (e.g. copy CD-R, CDs with labels)
- The artist and title information are displayed on the screen if track information is included within the audio CD.

Changing Tracks

Press the  key to move to the previous or next track.

Information

- Pressing the  key after the track has been playing for 2 seconds will start the current track from the beginning.
- Pressing the  key before the track has been playing for 1 seconds will start the previous track.

Selecting from the List

Turn the **TUNE** knob left/right to search for the desired track.

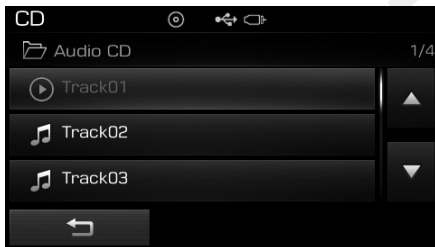

Once you find the desired track, press the **TUNE** knob to start playing.

Rewinding / Fast-forwarding Tracks

While playing, press and hold the **SEEK TRACK** key to rewind or fast-forward the current track.

Scan

Press the **SCAN** key to play the first 10 seconds of each file.

Audio CD Mode Menu

Within this mode, you will have access to the Info, Random(Shuffle), Repeat and List features.

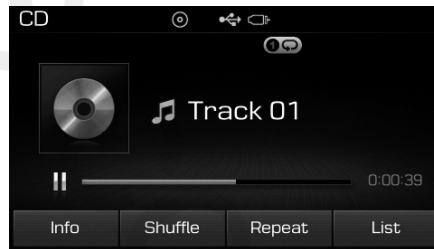

Info

Press the **Info** button to display details about the current disc.

Random(Shuffle)

Press the **Shuffle** button to play tracks in random(Shuffle) order.

Press the **Shuffle** button again to turn the Random(Shuffle) feature off.

- Random(Shuffle): Plays all tracks in random(Shuffle) order.

Repeat

Press the **Repeat** button to repeat the current track. Press the button again to turn the repeat feature off.

- Repeat : Repeats the current track.

List

Press the **List** button to display the track list screen.

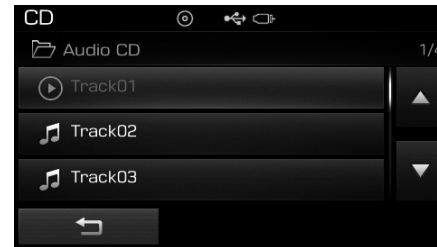

Turn the **TUNE** knob left/right to search for tracks. Once the desired track is displayed, press the knob to select and play.



MP3 CD MODE

Using MP3 CD Mode

Playing/Pausing MP3 Files

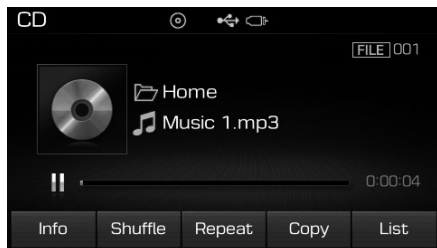
Once an MP3 disc is inserted the mode will automatically start and being playing.



While playing, press the  button to pause and press  button to play.



Information

If there are numerous files and folders within the disc, reading time could take more than 10 seconds and the list may not be displayed or song searches may not operate. Once loading is complete, try again.

Changing Files

Press the  key to move to the previous or next file.

NOTICE

- Pressing the  key after the file has been playing for 2 seconds will start the current file from the beginning.
- Pressing the  key before the file has been playing for 1 seconds will start the previous file.

Selecting from the List

Turn the  knob left/right to search for the desired file.

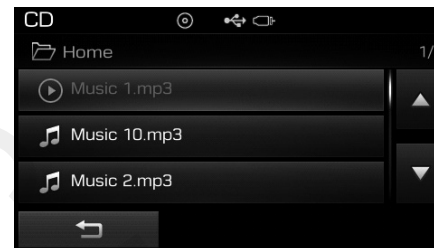

Once you find the desired file, press the  knob to start playing.

Rewinding / Fast-forwarding Files

While playing, press and hold the **SEEK TRACK** key (over 0.8 seconds) to rewind or fast-forward the current file.

Scan

Press the **SCAN** key to play the first 10 seconds of each file.

Searching Folders

Press the **CAT FOLDER** key to select and search folders.

Once the desired folder is displayed, press the **TUNE** knob to select.

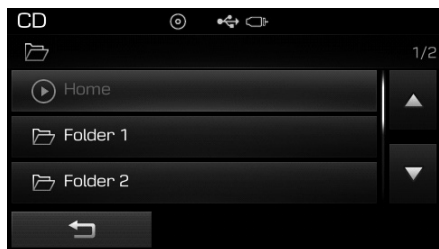

The first file within the selected folder will begin playing.

MP3 CD Mode Menu

Within this mode, you will have access to the Info, Random(Shuffle), Repeat, Copy and List features.

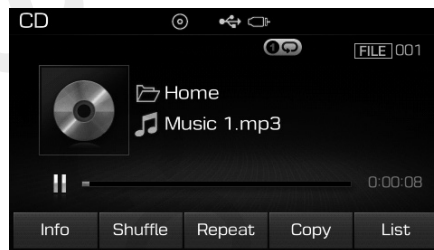

Info

Press the **Info** button to display details about the current file.

Information

- When the 'Folder File' option is set as the default display within Display setup, the album/artist/file information are displayed as detailed file information.
- When the 'Album Artist Song' option is set as the default display, the folder name/file name are displayed as detailed file information.
- The title, artist and album info are displayed only when such information are recorded within the MP3 file ID3 tag.

Random(Shuffle)

Press the **Shuffle** button to play files in random(Shuffle) order.

Each time the button is pressed, the feature changes in order of Random (Shuffle) Folder → Random (Shuffle) All → Off.

- Random(Shuffle) Folder : Plays all files within the current folder in Random (Shuffle) order.
- Random(Shuffle) All : Plays all files in Random(Shuffle) order.

Repeat

Press the **Repeat** button to repeat the current file or folder.

Each time the button is pressed, the feature changes in order of Repeat →Repeat Folder→Off.

- Repeat: Repeats the current file.
- Repeat Folder: Repeats all files within the current Folder.

Copying Files

Press the **Copy** button to copy the current file into My Music.

i Information

Selecting another feature during copying will display a pop-up asking whether you wish to cancel copying. To cancel, select 'Yes'.

List

Press the **List** button to display the file list screen.

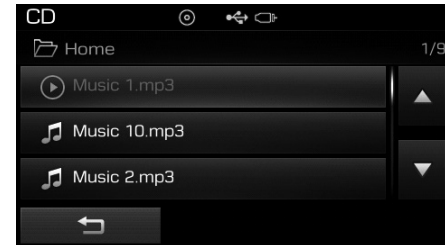

Turn the **TUNE** knob left/right to search for files. Once the desired file is displayed, press the knob to select and play.

USB MODE

Using USB Mode

Playing/Pausing USB Files

Once a USB is connected, the mode will automatically start and begin playing a USB file.

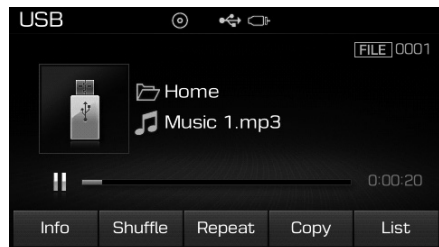

While playing, press the **||** button to pause and press **▶** button to play.

i Information

- Loading may require additional time if there are many files and folders within the USB and result in faulty list display or file searching. Normal operations will resume once loading is complete.
- The device may not support normal operation when using a USB memory type besides (Metal Cover Type) USB Memory.

Changing Files

Press the **SEEK TRACK** keys to move to the previous or next file.

i Information

- Pressing the **SEEK TRACK** key after the file has been playing for 2 seconds will start the current file from the beginning.
- Pressing the **SEEK TRACK** key before the file has been playing for 1 seconds will start the previous file.

Selecting from the List

Turn the **TUNE** knob left/right to search for the desired file.

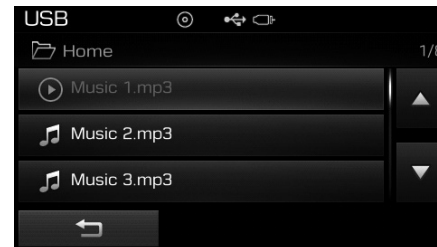

Once you find the desired file, press the **TUNE** knob to start playing.

Rewinding / Fast-forwarding Files

While playing, press and hold the **SEEK TRACK** key (over 0.8 seconds) to rewind or fast-forward the current file.

Scan

Press the **SCAN** key to play the first 10 seconds of each file.

Searching Folders

Press the  key to select and search folders.

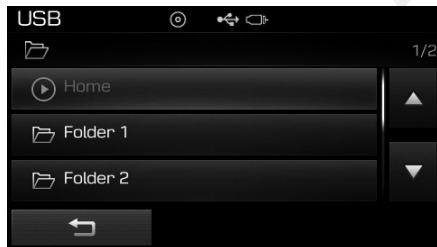

Once the desired folder is displayed, press the  TUNE knob to select.

The first file within the selected folder will begin playing.

USB Mode Menu

Within this mode, you will have access to the Info, Random(Shuffle), Repeat, Copy and List features.

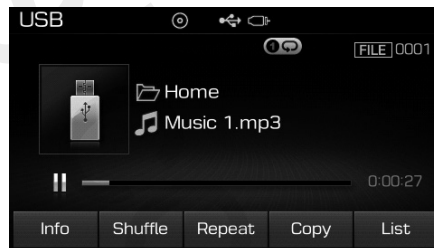

Info

Press the  button to display details about the current file.

Information

- When the 'Folder File' option is set as the default display within Display setup, the album/artist/file information are displayed as detailed file information.
- When the 'Album Artist Song' option is set as the default display, the folder name/file name are displayed as detailed file information.
- The title, artist and album info are displayed only when such information are recorded within the MP3 file ID3 tag.

Random (Shuffle)

Press the **Shuffle** button to play files in random(Shuffle) order.

Each time the button is pressed, the feature changes in order of Random(Shuffle) Folder→Random (Shuffle) All→Off.

- Random(Shuffle) Folder : Plays the files in the current folder in random(Shuffle) order.
- Random(Shuffle) All : Plays all files in random(Shuffle) order.

Repeat

Press the **Repeat** button to repeat the current file or folder.

Each time the button is pressed, the feature changes in order of Repeat→Repeat Folder → Off.

- Repeat : Repeats the current file.
- Repeat Folder : Repeats all files within the current folder.

Copying Files

Press the **Copy** button to copy the current file into My Music.

i Information

Selecting another feature during copying will display a pop-up asking whether you wish to cancel copying. To cancel, select 'Yes'.

List

Press the **List** button to display the file list screen.

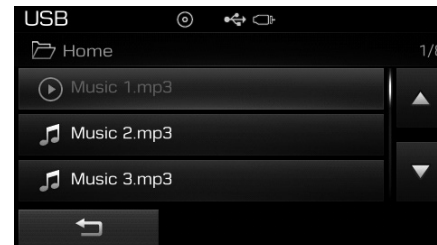

Turn the **TUNE** knob left/right to search for files. Once the desired file is displayed, press the knob to select and play.



iPod® MODE

Using iPod® Mode

Playing/Pausing iPod® Songs

Once an iPod® is connected, the mode will automatically start and begin playing an iPod® song.



While playing, press the  button to pause and press  button to play.



Information

iPod®s with unsupported communication protocols may not properly operate in the audio system.

Changing Songs

Press the  key to move to the previous or next song.

NOTICE

- Pressing the  key after the song has been playing for 2 seconds will start the current song from the beginning.
- Pressing the  key before the song has been playing for 1 seconds will start the previous song.
- Slight time differences may exist depending your iPod® product.

Rewinding / Fast-forwarding Songs

While playing, press and hold the  key (over 0.8 seconds) to rewind or fast-forward the current song.

Searching Categories

Turn the  TUNE knob left/right to search for the desired category.

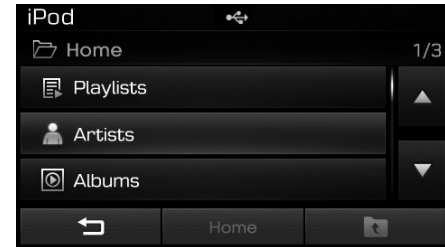

Once you find the desired category, press the  TUNE knob to select and play.



Information

There are eight categories that can be searched, including Playlists, Artists, Albums, Genres, Songs, Composers, Audiobooks and Podcasts.

Category Menu

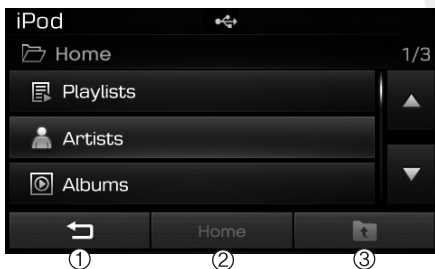
Within the iPod® Category menu, you will have access to the , Home, and  features.



1.  : Displays the play screen
2. Home : Moves to the iPod® root category screen
3.  : Moves to the previous category

Information

- If the search mode is accessed while playing a song, the most recently searched category is displayed.
- Search steps upon initial connection may differ depending on the type of iPod® device.

iPod® Mode Menu

Within this mode, you will have access to the Random(Shuffle), Repeat and List features.

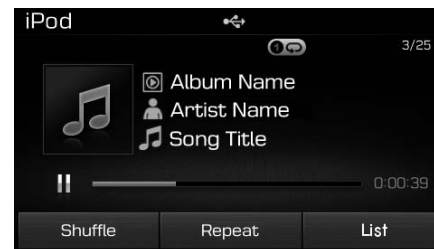

Random (Shuffle)

Press the  button to play songs in random(Shuffle) order.

- Random(Shuffle) All : Plays all songs in Random(Shuffle) order.

Repeat

Press the **Repeat** button to repeat the current song. Press the button again to turn the repeat feature off.

- Repeat : Repeats the current song

List

Press the **List** button to display the Category Menu.

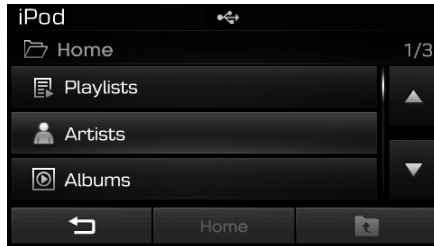

Turn the **TUNE** knob left/right to search for the desired category.

Once you find the desired category, press the **TUNE** knob to select and play.

AUX MODE

Using AUX Mode

Press the **MEDIA** key ▶ Select [AUX]

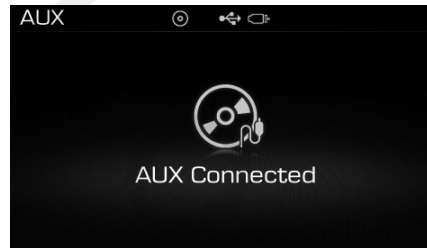

An external device can be connected to play music.

Connecting an External Device

External audio players (Camcorders, car VCR, etc.) can be played through a dedicated cable.

MY MUSIC MODE

Using My Music Mode

Playing/Pausing My Music Files

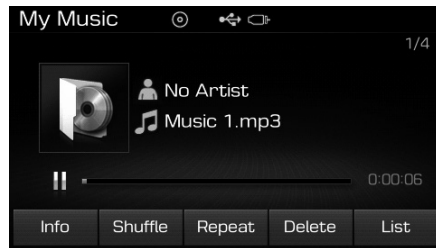

While playing, press the **||** button to pause and press **▶** button to play.

i Information

If there are no files saved within My Music, the **My Music** button will be disabled.

Changing Files

Press the **SEEK TRACK** key to move to the previous or next file.

i Information

- Pressing the **SEEK TRACK** key after the file has been playing for 2 seconds will start the current file from the beginning.
- Pressing the **SEEK TRACK** key before the file has been playing for 1 seconds will start the previous file.

Selecting from the List

Turn the **TUNE** knob left/right to search for the desired file.

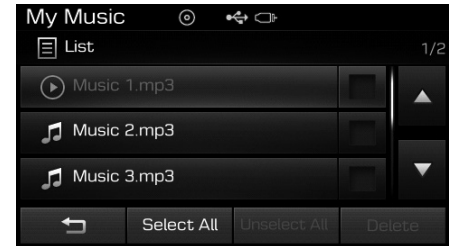

Once you find the desired file, press the **TUNE** knob to start playing.

Rewinding / Fast-forwarding Files

While playing, press and hold the **SEEK TRACK** key to rewind or fast-forward the current file.

Scan

Press the **SCAN** key to play the first 10 seconds of each file.

My Music Mode Menu

Within this mode, you will have access to the Info, Random(Shuffle), Repeat, Delete and List features.

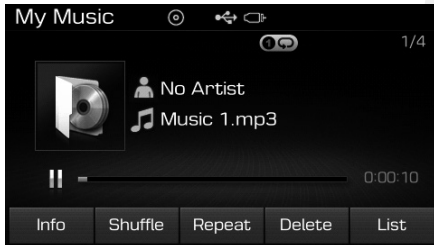

Info

Press the **Info** button to display details about the current file.

i Information

The title, artist and album info are displayed only when such information is recorded within the MP3 file ID3 tag.

Random

Press the **Shuffle** button to play files in random order. Press the button again to turn the Random feature off.

Repeat

Press the **Repeat** button to repeat the current song. Press the button again to turn the repeat feature off.

Deleting Files

Press the **Delete** button to delete the current file.

List

Press the **List** button to display the file list screen.

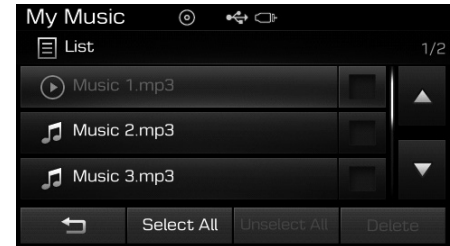

Turn the **TUNE** knob left/right to search for files. Once the desired file is displayed, press the knob to select and play.

List Menu

From the List screen, it is possible to delete files you previously saved into My Music.

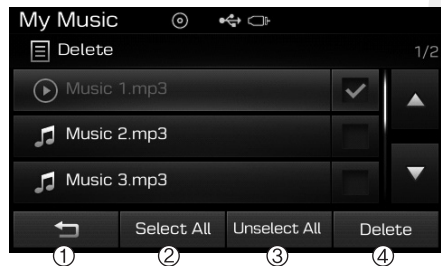

Press the **Select All** button or individually select the files you want to delete. Once files are selected, the **Unselect All** button and **Delete** buttons will be enabled.

- 1) **←** : Moves to the previous screen
- 2) **Select All**: Selects all files
- 3) **Unselect All**: Deselects all selected files
- 4) **Delete**: Deletes selected files

After selecting the files you want to delete, press the **Delete** button to delete the selected files.

i Information

- If there is memory available, up to 6,000 files can be saved.
- Identical files cannot be copied more than 1,000 times.
- To check memory information, go to **SETUP** ▶ [System] ▶ [Memory Information]

i Information - Using the *Bluetooth®* wireless technology audio mode

- *Bluetooth®* Wireless Technology Audio Mode can be used only when a *Bluetooth®* Wireless Technology phone has been connected.
- *Bluetooth®* Wireless Technology Audio Mode will not be available when connecting mobile phones that do not support this feature.
- While *Bluetooth®* Wireless Technology Audio is playing, if the *Bluetooth®* Wireless Technology phone is connected, then the music will also stop.
- Moving the Track up/down while playing *Bluetooth®* Wireless Technology audio mode may result in pop noises in some mobile phones.
- *Bluetooth®* Wireless Technology streaming audio may not be supported in some mobile phones.

(Continued)

(Continued)

- When returning to *Bluetooth®* Wireless Technology Audio mode after ending a call, the mode may not automatically restart in some mobile phones.
- Receiving an incoming call or making an outgoing call while playing *Bluetooth®* Wireless Technology Audio may result in audio interference.



Bluetooth® Wireless Technology AUDIO MODE (if equipped)

Using *Bluetooth®* Wireless Technology Audio Mode

Playing/Pausing *Bluetooth®* Wireless Technology Audio

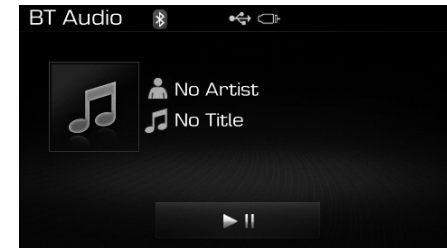
Once a *Bluetooth®* Wireless Technology device is connected, the mode will automatically start.



While playing, press the  button to pause and press  button to play.

i Information

The play/pause feature may operate differently depending on the mobile phone.

Changing Files

Press the  key to move to the previous or next file.

Setting Connection

If a *Bluetooth*[®] Wireless Technology device has not been connected, press the **SETUP** key ▶[Phone] button to display the *Bluetooth*[®] Wireless Technology connection screen.

It is possible to use the pair phone, connect/disconnect and delete features from your *Bluetooth*[®] Wireless Technology phone.

i Information

- If music is not yet playing from your mobile device after converting to *Bluetooth*[®] Wireless Technology Audio mode, pressing the play button once may start playing the mode. Check to see that music is playing from the *Bluetooth*[®] Wireless Technology device after converting to *Bluetooth*[®] Wireless Technology Audio Mode.

i Information - Pairing through [PHONE] Setup

- The *Bluetooth*[®] and Voice Recognition Manual is provided in two versions due to software version differences.
- Before reading the manual, check the following.
- Press the **SETUP** key ▶Select [Phone]▶Select [Pair Phone]

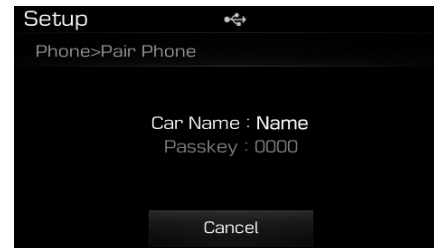

- From your *Bluetooth*[®] Wireless Technology device (i.e. Mobile Phone), search and select your car audio system.

Pairing a *Bluetooth*[®] Wireless Technology Device

What is *Bluetooth*[®] Wireless Technology Pairing?

Pairing refers to the process of synchronizing your *Bluetooth*[®] Wireless Technology phone or device with the car audio system for connection. Pairing is necessary to connect and use the *Bluetooth*[®] Wireless Technology feature.

Pairing **PHONE** key / key on the Steering Remote Controller

When No Devices have been Paired

1. Press the **PHONE** key or the  key on the steering remote controller. The following screen is displayed.
2. Press the **OK** button to enter the Pair Phone screen.

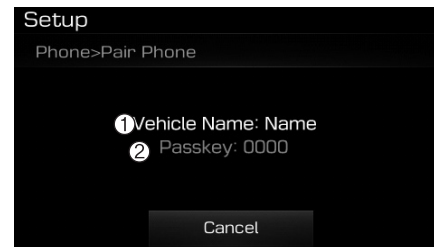
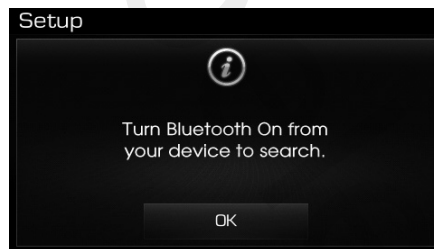

- 1) Vehicle Name : Name of device as shown when searching from your *Bluetooth*[®] Wireless Technology device
- 2) Passkey : Passkey used to pair the device
3. From your *Bluetooth*[®] Wireless Technology device (i.e. Mobile Phone), search and select your car audio system.
4. After a few moments, a screen is displayed 6 digits passkey. Hear, check the passkey on your *Bluetooth*[®] Wireless Technology device and confirm.

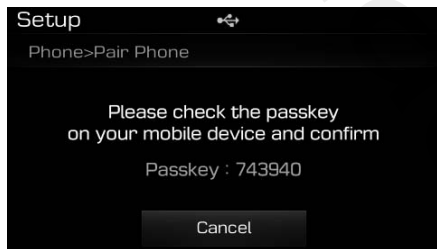

5. Once pairing is complete, the following screen is displayed.

NOTICE



If **Bluetooth®** Wireless Technology devices are paired but none are currently connected, pressing the **PHONE** key or the  key on the steering wheel displays the following screen. Press the [Pair] button to pair a new device or press the [Connect] to connect a previously paired device.

Pairing through [PHONE] Setup

Press the **SETUP** key ▶ Select [Phone] ▶ Select [Pair Phone]

(For USA)

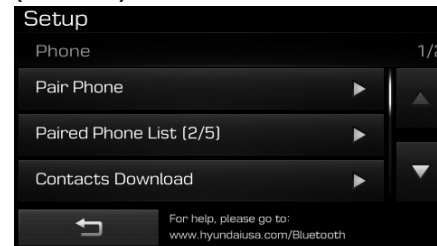

(Except USA)

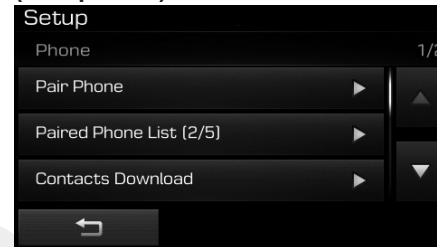

(* the screen can be different by region.)

The following steps are the same as those described in the section "When No Devices have been Paired" on the previous page.

i Information

- **Bluetooth®** Wireless Technology features supported within the vehicle are as follows. Some features may not be supported depending on your **Bluetooth®** Wireless Technology device.
 - Outgoing/Incoming Handsfree calls
 - Operations during a call (Switch to Private, Switch to call waiting, MIC on/off)
 - Downloading Call History
 - Downloading Mobile Contacts
 - **Bluetooth®** Wireless Technology device auto connection
 - Bluetooth Audio Streaming
- Up to five **Bluetooth®** Wireless Technology devices can be paired to the Car Handsfree system.
- Only one **Bluetooth®** Wireless Technology device can be connected at a time.
- Other devices cannot be paired while a **Bluetooth®** Wireless Technology device is connected.

(Continued)

(Continued)

- Only **Bluetooth®** Wireless Technology Handsfree and Bluetooth audio related features are supported.
- Bluetooth related operations are possible only within devices that support Handsfree or audio features, such as a **Bluetooth®** Wireless Technology mobile phone or a Bluetooth audio device.
- If a connected **Bluetooth®** Wireless Technology device becomes disconnected due to being out of communication range, turning the device OFF, or a **Bluetooth®** Wireless Technology communication error, corresponding **Bluetooth®** Wireless Technology devices are automatically searched and reconnected.
- If the system becomes unstable due to communication errors between the car Handsfree and the **Bluetooth®** Wireless Technology device, reset the device by turning off and back on again. Upon resetting **Bluetooth®** Wireless Technology device, the system will be restored.

(Continued)

(Continued)

- After pairing is complete, a contacts download request is sent once to the mobile phone. Some mobile phones may require confirmation upon receiving a download request, ensure your mobile phone accepts the connection. Refer to your phones user's manual for additional information regarding phone pairing and connections.

Connecting a Device

Press the **SETUP** key ▶ Select [Phone] ▶ Select [Paired Phone List]

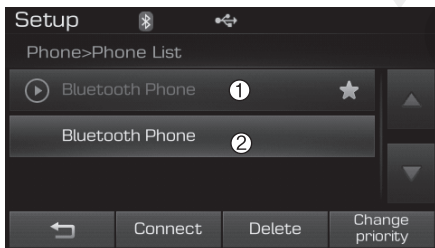

- 1) Connected Phone : Device that is currently connected
- 2) Paired Phone : Device that is paired but not connected

From the paired phone list, select the device you want to connect and press the **Connect** button.

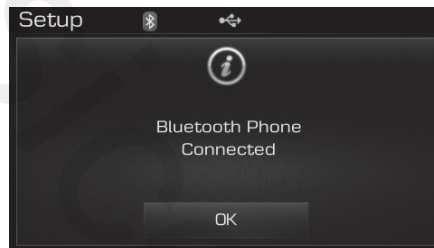

Changing Priority

What is Priority?

It is possible to pair up to five *Bluetooth*® Wireless Technology devices with the car audio system. The "Change Priority" feature is used to set the connection priority of paired phones.

Press the **SETUP** key ▶ Select [Phone] ▶ Select [Paired Phone List]

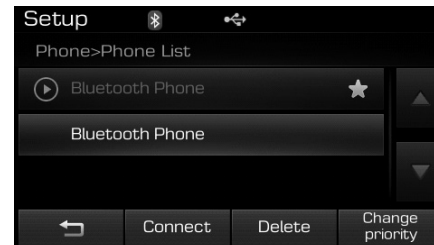

From the paired phone list, select the phone you want to switch to the highest priority, then press the **Change priority** button from the Menu. The selected device will be changed to the highest priority.

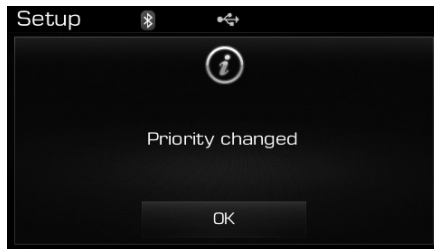

NOTICE

Priority icon will be displayed when the selected phone is set as a priority phone.



Disconnecting a Device

Press the **SETUP** key ▶ Select [Phone] ▶ Select [Paired Phone List]

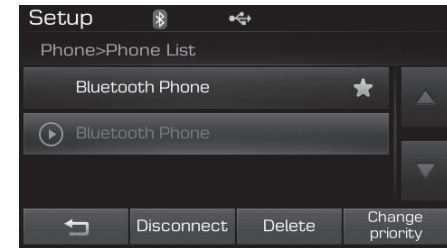

From the paired phone list, select the currently connected device and press the **Disconnect** button.

Deleting a Device

Press the **SETUP** key ▶ Select [Phone] ▶ Select [Paired Phone List]

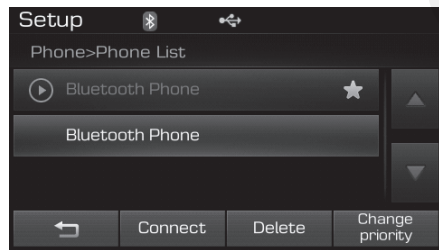

From the paired phone list, select the device you want to delete and press the **Delete** button.

i Information

- When deleting the currently connected device, the device will automatically be disconnected to proceed with the deleting process.
- If a paired *Bluetooth*® Wireless Technology device is deleted, the device's call history and contacts data will also be deleted.
- To re-use a deleted device, you must pair the device again.

Phone Menu Screen

Phone Menus

With a *Bluetooth*® Wireless Technology device connected, press the **PHONE** key to display the Phone menu screen.

(For USA)

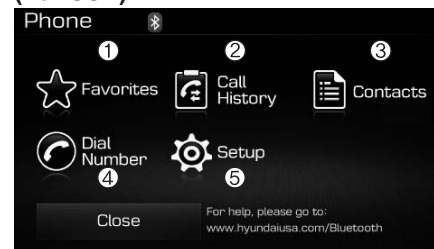

(Except USA)

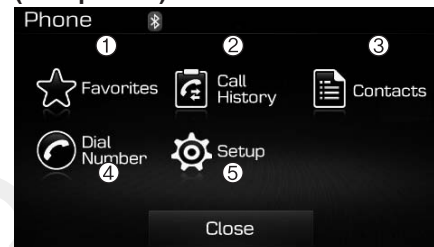

(※ the screen can be different by region.)

- 1) Favorite : Up to 20 frequently used contacts saved for easy access
- 2) Call History : Device the call history list screen
- 3) Contacts : Displays the Contacts list screen
- 4) Dial Number : Displays the dial screen where numbers can be dialed to make calls
- 5) Setup : Displays Phone related settings

i Information

- If you press the [Call History] button but there is no call history data, a prompt is displayed which asks to download call history data.
- If you press the [Contacts] button but there is no contacts data stored, a prompt is displayed which asks to download contacts data.
- This feature may not be supported in some mobile phones. For more information on download support, refer to your mobile phone user's manual.

Favorites

Press the **PHONE** key ▶ Select [Favorites]

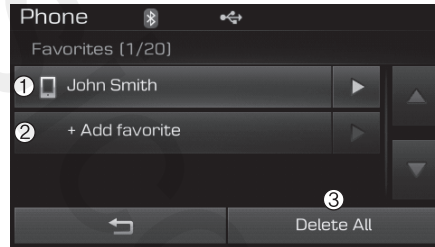

- 1) Saved favorite contact : Connects call upon selection
- 2) To add favorite : Downloaded contacts be saved as favorite.
- 3) Delete All : Delete all stored favorite contacts

i Information

- To save Favorite, contacts should be downloaded.
- Contact saved in Favorites will not be automatically updated if the contact has been updated in the phone. To update Favorites, delete the Favorite and create a new Favorite.

Call History

Press the **PHONE** key ▶ Select [Call History]

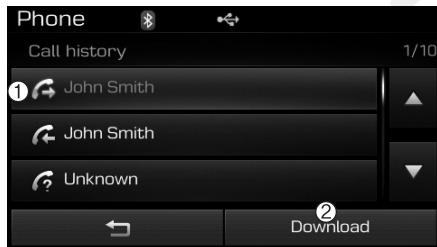

A list of incoming, outgoing and missed calls is displayed.

Press the **Download** button to download the call history.

1) Call History :

- Displays recent calls (call history)
- Connects call upon selection

2) Download : Download Recent Call History

- Call history may not be saved in the call history list in some mobile phones.

- Calls received with hidden caller ID will not be saved in the call history list.
- Calling through the call history is not possible when there is no call history stored or a *Bluetooth*® Wireless Technology phone is not connected.
- Up to 50 received, dialed and missed calls are stored in Call History.
- Time of received/dialed calls and call time information are not saved.

Contacts

Press the **PHONE** key ▶ Select [Contacts]

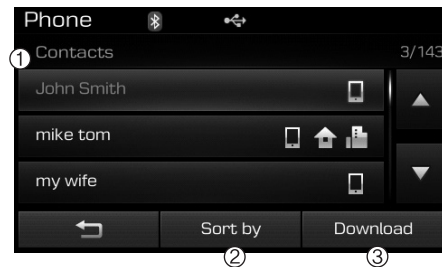
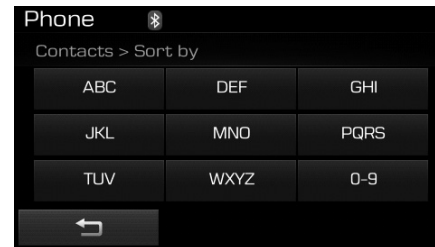

The list of saved phone book entries is displayed. Press the **Download** button to download the call history.

1) Contacts List :

- Displays downloaded contacts entries
- Connects call upon selection

2) Sort by : Find a contact in an alphabetical order.

3) Download : Download contacts entries

i Information

- Up to 1,000 contacts saved in your *Bluetooth*® Wireless Technology phone can be downloaded into the car contacts. Contacts that have been downloaded to the car cannot be edited or deleted on the phone.
- Mobile phone contacts are managed separately for each paired *Bluetooth*® Wireless Technology device (max 5 devices x 1,000 contacts each). Previously downloaded data is maintained even if the *Bluetooth*® Wireless Technology device has been disconnected.

(However, the contacts and call history saved to the phone will be deleted if a paired phone is deleted.)

(Continued)

(Continued)

- It is possible to download contacts during Bluetooth streaming audio.
- When downloading contacts, the icon will be displayed within the status bar.
- It is not possible to begin downloading a contact list when the contact download feature has been turned off within the *Bluetooth*® Wireless Technology device. In addition, some devices may require device authorization upon attempting to download contacts. If downloading does not normally occur, check the *Bluetooth*® Wireless Technology device settings or the screen state.
- The contacts download feature may not be supported in some mobile phones. For more information of supported *Bluetooth*® devices and function support, refer to your phone's user manual.

Calling by Dialing a Number

Press the **PHONE** key ▶ Select [Dial Number]

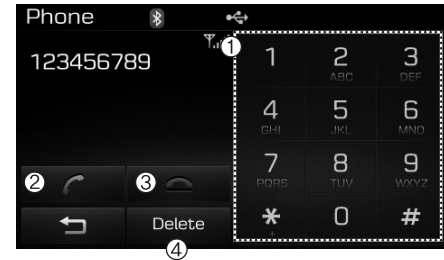

- 1) Dial Pad : Used to enter phone number
- 2) Call : If a number has been entered, calls the number. If no number has been entered, switches to call history screen
- 3) End : Deletes the entered phone number
- 4) Delete : Deletes entered numbers one digit at a time

Answering Calls

Answering a Call

Answering a call with a *Bluetooth®* Wireless Technology device connected will display the following screen.

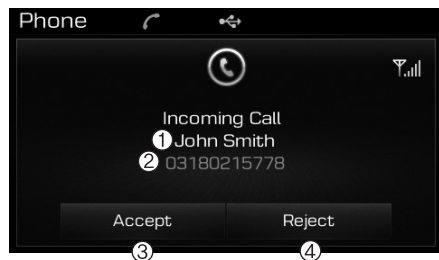

- 1) Caller : Displays the other party's name when the incoming caller is saved within your contacts
- 2) Incoming Number : Displays the incoming number
- 3) Accept : Accepts the incoming call
- 4) Reject : Rejects the incoming call

i Information

- When an incoming call pop-up is displayed, most Audio and SETUP mode features are disabled. Only the call volume will operate.
- The telephone number may not be properly displayed in some mobile phones.

During a Handsfree Call

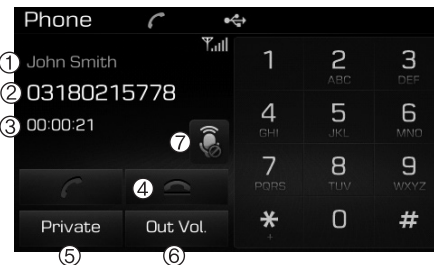

- 1) Caller : Displays the other party's name if the incoming caller is saved within your contacts
- 2) Incoming Number : Displays the incoming number
- 3) Call time : Displays the call time
- 4) End : Ends call
- 5) Private : Converts to Private mode
- 6) Out Vol. : Sets call volume as heard by the other party
- 7) Mute : Turns Mic Mute On/Off

i Information

If the mic is muted, the other party will not be able to hear your voice.

Bluetooth® Wireless Technology Setting

Pairing a New Device

Press the **SETUP** key ▶ Select [Phone] ▶ Select [Pair Phone]

(For USA)

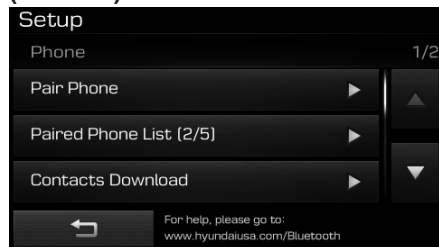

(Except USA)

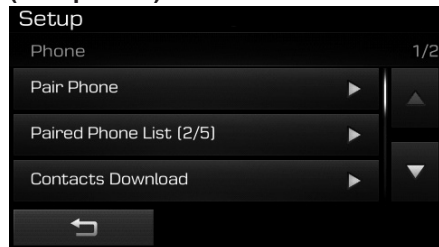

(※ the screen can be different by region.)

Bluetooth® Wireless Technology devices can be paired with the audio system.

For more information, refer to the “Pairing through Phone Setup” section within *Bluetooth®* Wireless Technology.

Viewing Paired Phone List

Press the **SETUP** key ▶ Select [Phone] ▶ Select [Paired Phone List]

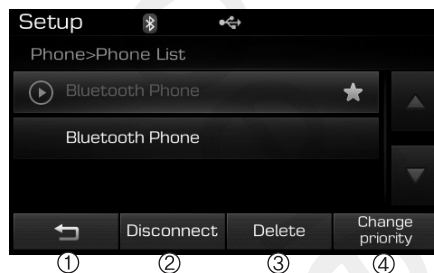

This feature is used to view mobile phones that have been paired with the audio system. Upon selecting a paired phone, the setup menu is displayed.

For more information, refer to the “Setting *Bluetooth®* Wireless Technology Connection” section within *Bluetooth®* Wireless Technology.

- 1) : Moves to the previous screen
- 2) Connect/Disconnect Phone : Connect/ disconnects currently selected phone
- 3) Delete : Deletes the currently selected phone
- 4) Change Priority : Sets currently selected phone to highest connection priority

i Information - Before downloading contacts

- Only contacts within connected phones can be downloaded. Also check to see that your mobile phone supports the download feature.
- To learn more about whether your mobile phone supports contacts downloads, refer to your mobile phone user's manual.
- The contacts for only the connected phone can be downloaded.

Downloading Contacts

Press the **SETUP** key ▶ Select [Phone] ▶ Select [Contacts Download]

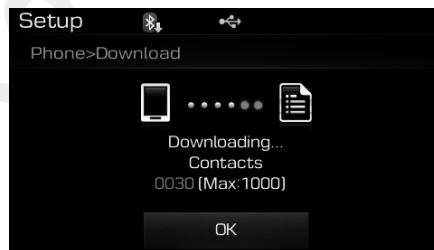

As the contacts are downloaded from the mobile phone, a download progress bar is displayed.

i Information

- Upon downloading phone contacts, the previous corresponding data is deleted.
- This feature may not be supported in some mobile phones.
- Voice Recognition may not operate while contacts are being downloaded.

Outgoing Volume

Press the **SETUP** key ▶ Select [Phone] ▶ Select [Outgoing Volume]

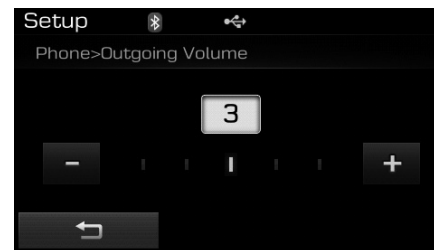

Use the **-**, **+** buttons to adjust the outgoing volume level.

NOTICE

While on a call, the volume can be changed by using the **SEEK TRACK** key.

Turning Bluetooth System Off

Press the **SETUP** key ▶ Select [Phone] ▶ Select [Bluetooth System Off]

Once *Bluetooth*® Wireless Technology is turned off, *Bluetooth*® Wireless Technology related features will not be supported within the audio system.

(For USA)

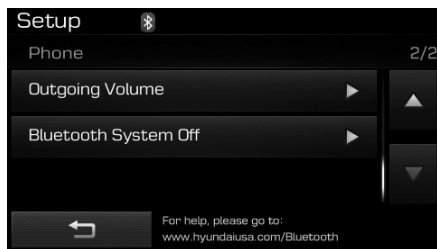

(Except USA)

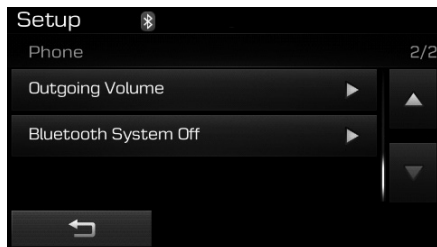

NOTICE

To turn *Bluetooth*® Wireless Technology back on, go to **SETUP** ▶ [Phone] and press “Yes

VOICE RECOGNITION

Using Voice Recognition

Starting Voice Recognition

Shortly press the  key on the steering wheel remote controller. Say a command.

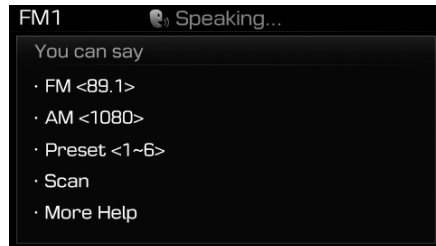

If prompt feedback is in [ON], then the system will say “Please say a command after the beep (BEEP)”

- If prompt feedback is in [OFF] mode, then the system will only say “(BEEP)”
- To change Prompt Feedback [On]/[Off], go to **SETUP** ▶ [System] ▶ [Prompt Feedback]

NOTICE

For proper recognition, say the command after the voice instruction and beep tone.

Contact List Best Practices

- 1) Do not store single-name entries (e.g., “Bob”, “Mom”, “Kim”, etc.). Instead, always use full names (including first and last names) for all contacts (e.g., use “Jacob Stevenson” instead of “Dad”).
- 2) Do not use abbreviations (i.e., use “Lieutenant” instead of “Lt.” or “Sergeant” instead of “Sgt.”).
- 3) Do not use acronyms (i.e., use “County Finance Department” instead of “CFD”).
- 4) Do not use special characters (e.g., “@”, “hyphen -”, “asterisk *”, “ampersand &”).
- 5) If a name is not recognized from the contact list, change it to a more descriptive name (e.g., use “Grandpa Joseph” instead of “Pa Joe”).

Skipping Prompt Messages

While prompt message is being stated ▶ Shortly press the  key on the steering remote controller

The prompt message is immediately ended and the beep tone will sound. After the “beep”, say the voice command.

Re-starting Voice Recognition

While system waits for a command ▶ Shortly press the  key on the steering remote controller

The command wait state is immediately ended and the beep tone will sound. After the “beep”, say the voice command.

* Illustration on using voice commands

• **Starting voice command.**

Shortly pressing the  key (under 0.8 seconds):



Please say a command after the beep or say "help" for more information.

Ding~

More Help



More Help
Here are some examples of mode commands.
You can say a radio type like 'FM', 'AM', or 'Satellite'.
You can also say a media source like 'USB', 'My Music', or 'iPod'.
Additionally, there are phone commands like "Contacts", 'Call History', or 'Dial Number'.
You can find more detailed commands in the user's manual.
Please say a command after the beep.

• **Skipping Voice Recognition**

Shortly pressing the  key (under 0.8 seconds):



Please say a...

Shortly pressing the  key (under 0.8 seconds):



(BEEP)

More Help



More Help

Here are some examples of mode commands.
You can say a radio type like 'FM', 'AM', or 'Satellite'.
You can also say a media source like 'USB', 'My Music', or 'iPod'.
Additionally, there are phone commands like "Contacts", 'Call History', or 'Dial Number'.
You can find more detailed commands in the user's manual.
Please say a command after the beep.

• **Ending voice command.**

Shortly pressing the  key (under 0.8 seconds):



Please say a command after the beep or say "help" for more information.

Ding~

Contacts



Please say the contact name you want to call.

Cancel



Voice Command List

- Common Commands: These commands can be used in most operations. (However a few commands may not be available during certain operations)

Command	Function
More Help	Provides guidance on commands that can be used anywhere in the system.
Help	Provides guidance on commands that can be used within the current mode.
Call<Name>	Calls <Name> saved in Contacts Ex) Call "John Smith"
Call <Name> on Mobile	Calls <Name> to the number that is saved as "Mobile" in Contacts Ex) Call "John Smith" on Mobile
Call <Name> in Office	Calls <Name> to the number that is saved as "Office" in Contacts Ex) Call "John Smith" in Office
Call <Name> at Home	Calls <Name> to the number that is saved as "Home" in Contacts Ex) Call "John Smith" at Home
Call <Name> on Other	Calls <Name> to the number that is saved as "Other" in Contacts Ex) Call "John Smith" on Other
Phone	Provides guidance on Phone related commands. After saying this command, say "Favorites", "Dial Number", "Call History" or "Contacts" execute corresponding functions.
Favorites	Displays the Favorite screen.
Call History	Displays the Call History screen.

Command	Function
Contacts (Call by Name)	Displays the Contacts screen. After saying this command, say the name of a contact saved in the Contacts to automatically connect the call.
Dial Number	Displays the Dial number screen. After saying this command, you can say the number that you want to call.
Redial	Connects the last dialed call number.
Tutorial	Provides guidance on how to use voice recognition and Bluetooth® connections.
Radio	<ul style="list-style-type: none"> • When listening to the radio, displays the next radio screen. (FM1→FM2→AM→XM1→XM2→XM3→FM1) • When listening to a different mode, displays the most recently played radio screen. • When currently listening to the FM radio, maintains the current state. • When listening to a different mode, displays the most recently played FM screen.
FM1(FM One)	Displays the FM1 screen.
FM2(FM Two)	Displays the FM2 screen.
AM	Displays the AM screen.

Command	Function
FM Preset 1~6	Plays the most recently played broadcast saved in FM Preset 1~6.
AM Preset 1~6	Plays the broadcast saved in AM Preset 1~6.
FM 87.5~107.9	Plays the FM broadcast of the corresponding frequency.
AM 530~1701	Plays the AM broadcast of the corresponding frequency.
XM (Satellite)	<ul style="list-style-type: none"> • When currently listening to the SiriusXM® maintains the current state. • When listening to a different mode, displays the most recently played SiriusXM® screen.
XM (Satellite) 1~3	Displays the selected SiriusXM® screen.
XM Channel 0~223	Plays the selected SiriusXM® channel.
Media	Moves to the most recently played media screen.
CD	Plays the music saved in the CD.
USB	Plays USB music.
iPod®	Plays iPod music.
My Music	Plays the music saved in My Music.

Command	Function
AUX (Auxiliary)	Plays the connected external device.
Bluetooth® Audio	Plays the music saved in connected Bluetooth® device.
Mute	Mutes the sound
Cancel (Exit)	Ends voice command.

- FM/AM radio commands: available during FM, AM radio operation

Command	Function
Preset 1~6	Plays the broadcast saved in Preset 1~6.
Scan	Scans receivable frequencies from the current broadcast and plays for 10 seconds each.
Preset Scan	Moves to the next preset from the current present and plays for 10 seconds each.
Information	Displays the information of the current broadcast.(This feature can be used when receiving RBDS broadcasts.)

- Satellite radio commands: Commands that can be used while listening to Satellite Radio.

Command	Function
Channel 0~255	Play the selected Satellite Radio channel.
Scan	Scans receivable channels from the current broadcast and plays for 10 seconds each.
Preset 1~6	Plays the broadcast saved in Preset 1~6.
Information	Displays the information of the current broadcast.

- Audio CD commands: Commands available during Audio CD operation

Command	Function
Play	Plays the currently paused track.
Pause	Pauses the current track.
Shuffle	Randomly plays the tracks within the CD.
Shuffle Off	Cancels random play to play tracks in sequential order.
Repeat	Repeats the current track.
Repeat Off	Cancels repeat play to play tracks in sequential order.
Track 1~30	Plays the desired track number.

- MP3 CD / USB commands: Commands available during USB and MP3 CD operation

Command	Function
Play	Plays the currently paused file.
Pause	Pauses the current file.
Shuffle	Randomly plays the files within the current folder.
Shuffle Off	Cancels random play to play files in sequential order.
Repeat	Repeats the current file.
Repeat Off	Cancels repeat play to play files in sequential order.
Next Folder	Play the first file in the next folder
Previous Folder	Play the first file in the previous folder

- iPod® Commands: Commands available during iPod® operation

Command	Function
Play	Plays the currently paused song.
Pause	Pauses the current song.
Shuffle	Randomly plays the songs within the current category.
Shuffle Off	Cancels random play to play songs in sequential order.
Repeat	Repeats the current song.
Repeat Off	Cancels repeat play to play songs in sequential order.

- My Music Commands: Commands available during My Music operation

Command	Function
Play	Plays the currently paused file.
Pause	Pauses the current file.
Shuffle	Randomly plays all saved files.
Shuffle Off	Cancels random play to play files in sequential order.
Repeat	Repeats the current file.
Repeat Off	Cancels repeat play to play files in sequential order.
Delete	Deletes the current file. You will bypass an additional confirmation process.

SETUP

Starting Mode

Press the **SETUP** key to display the Setup screen.

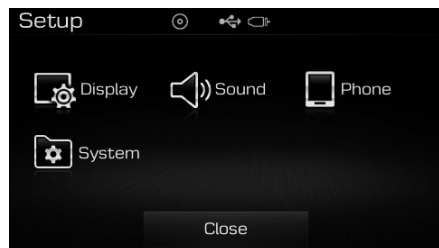

You can select and control options related to [Display], [Sound], [Phone] and [System].

Display Settings

Adjusting the Brightness

Press the **SETUP** key ▶ Select [Display] ▶ Select [Brightness]

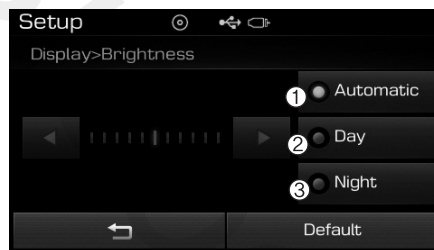

Use the ◀, ▶ buttons to adjust the screen brightness or set the Brightness on Automatic, Day, or Night mode.

Press the **Default** button to reset.

- 1) Automatic : Adjusts the brightness automatically
- 2) Day : Always maintains the brightness on high
- 3) Night: Always maintains the brightness on low

Mode Pop up

Press the **SETUP** key ▶ Select [Display] ▶ Select [Mode Pop up]

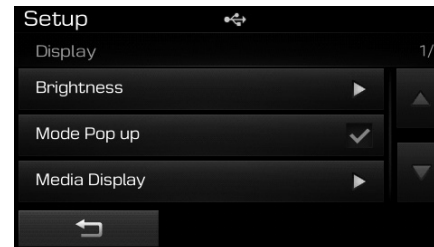

This feature is used to display the Pop-up Mode screen when entering radio and media modes.

When this feature is turned on, pressing the **RADIO** or **MEDIA** key will display the Pop-up Mode screen.

i Information

The media Pop-up Mode screen can be displayed only when two or more media modes have been connected.

MP3 Information Display

Press the **SETUP** key ▶ Select [Display] ▶ Select [Media Display]

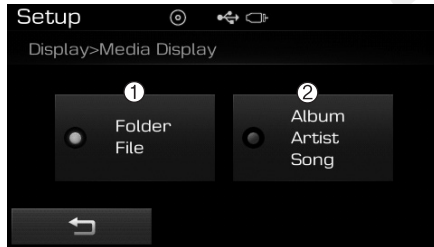

This feature is used to change the information displayed within USB and MP3 CD modes.

- 1) Folder/File : Displays file name and folder name
- 2) Album/Artist/Song : Displays album name/artist name/song

Sound Settings

Sound Settings

Press the **SETUP** key ▶ Select [Sound] ▶ Select [Sound Setting]



Use the **◀**, **▶**, **▲**, **▼** buttons to adjust the Fader/Balance settings.

Use the **◀**, **▶** buttons to adjust the Bass/Middle/Treble settings.

Press the **Default** button to reset.

Variable EQ

This is a premium sound system feature in which the acoustical mode can be selected according to musical preferences.

Select [Variable EQ] ▶ Set menu through **TUNE** knob

- Innocente(Normal) : Natural sound, sound optimized for driver.
- Forza(Dynamic) : Powerful sound emphasizing bass, stereo sound.
- Concerto(Concert) : Sound similar to a concert or live hall

* May differ depending on the selected audio.

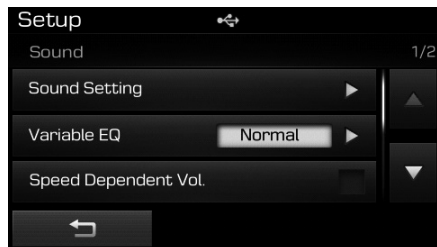

SDVC (Speed Dependent Volume Control)

Press the **SETUP** key ▶ Select [Sound] ▶ Select [Speed Dependent Vol.]

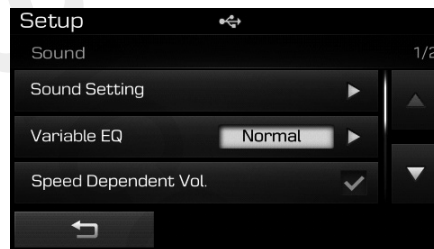

The volume level is controlled automatically according to the vehicle speed. SDVC can be set by selecting from On / Off.

Voice Recognition Volume

Press the **SETUP** key ▶ Select [Sound] ▶ Select [Voice Recognition Vol.]

Turn the **TUNE** knob to adjust the Voice Recognition volume.

Touch Screen Beep

Press the **SETUP** key ▶ Select [Sound]
▶ Select [Touch Screen Beep]

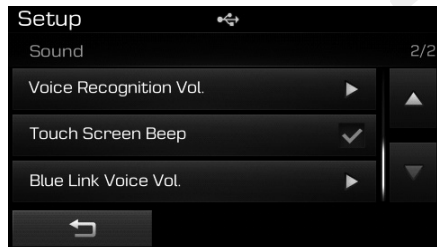

This feature is used to turn the touch screen beep on/off.

Blue Link Voice Volume

Press the **SETUP** key ▶ Select [Sound]
▶ Select [Blue Link Voice Vol.]

Turn the **TUNE** knob to adjust the Blue Link Voice Volume.

* Blue Link® may differ depending on the selected audio.

System Setting

Memory Information

Press the **SETUP** key ▶ Select [System] ▶ Select [Memory Information]

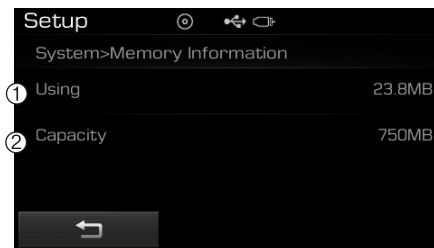

This feature displays information related to system memory.

- 1) Using : Displays capacity currently in use
- 2) Capacity : Displays total capacity

Prompt Feedback

Press the **SETUP** key ▶ Select [System] ▶ Select [Prompt Feedback]

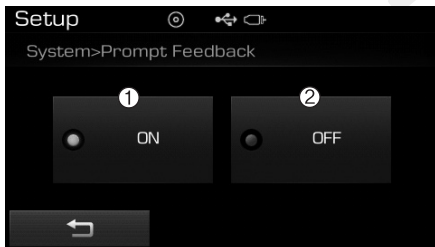

This feature is used to select the desired prompt feedback option from ON and OFF.

- 1) ON : When using voice recognition, provides detailed guidance prompts
- 2) OFF : When using voice recognition, omits some guidance prompts

Language

Press the **SETUP** key ▶ Select [System] ▶ Select [Language]

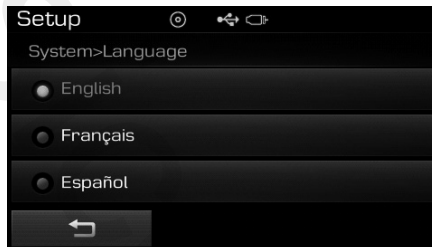

*This feature is used to change the system and voice recognition language.

*if the language is changed, the system will restart and apply the selected language.

REAR VIEW CAMERA (if equipped)

- The system has been equipped with a rear view camera for user safety by allowing a wider rear range of vision.
- The rear view camera will automatically operate when the ignition key is turned ON and the shift lever is set to R (Reverse).
- The rear view camera will automatically stop operating when set to a different lever.

 **CAUTION**

The rear view camera has been equipped with an optical lens to provide a wider range of vision and may appear different from the actual distance. For safety, directly check the rear and left/right sides.

BLUE LINK® (IF EQUIPPED)

Hyundai aims to offer differentiated customer values through a 'Connected Car Life,' which is to provide consumers with fast and reliable IT technology. As consumers' lifestyles become more and more mobile in thanks to remarkable advances in smart phones, tablet PCs and overall wireless telecommunication, new lifestyle patterns demand seamless connection between one's office, home, outdoors and automobiles.

Automobile companies are now faced with the task of shifting their paradigm from vehicle-centered services to customer value-centered services, with the ultimate goal of securing global leadership in the field of vehicle IT and telematics.



Hyundai Motor plans to achieve this by realizing a terminal platform flexible to changes in IT technology, cooperating with global IT companies, creating an eco-system and providing the latest contents & services based on an open environment.

Using the Room Mirror Key

Selecting the room mirror key will allow you to make service required inquiries, POI info searches, and emergency rescues by connecting to the Blue Link® Center.

Such features can be used only after subscribing to the Blue Link® service.



① (Blue Link® Center)

Makes requests for Blue Link® service related inquiries and consultations.

A call is connected to the Blue Link® service center employee.

Re-pressing the key will end the call.

This feature does not operate when you are on a Bluetooth® phone call.

② (Blue Link® for POI)

- Blue Link® for Voice command Starts Blue Link® voice command.

Voice receiving voice guidance, shortly press the button to convert to voice command mode. Press and hold the button to end voice command.

• TBT VR Commands

1. Navigate to

“Navigate to” voice command is used to request the download of route data for a new destination, saved destinations, daily routes and previous destinations.

2. Save Destination

“Save Destination” VR command is used to assign a voice tag to the last downloaded destination and store it in a destination directory.

Information

The Turn by Turn (TBT) feature supports the store of ten (10) destinations in the TBT destinations directory.

3. Route Preview

“Route Preview” VR command allows the user to preview the route instructions (upcoming maneuver instructions) at any time during the route guidance.

4. Destinations List

“Destinations List” VR command allows the user to preview and delete the stored destinations with their associated voice tags in the Turn by Turn destinations directory.

5. Voice Guidance

“Voice Guidance” VR command allows the user to mute/unmute the Turn by Turn(TBT) direction announcements.

6. Suspend Route

“Suspend Route” VR command allows the user to suspend and pause Turn by Turn(TBT) route guidance while in the guidance mode.

7. Resume Route

“Resume Route” VR command allows the user to resume Turn by Turn(TBT) route guidance.



③ (Blue Link® for SOS)

In the case of an emergency, requests for help to the Blue Link® center.

Call is connected to the Blue Link® emergency rescue center. Re-pressing the key will end the call.

If already on a Bluetooth® phone call, the call will end to connect you to the Blue Link® Emergency Rescue Center.

Information

- **You cannot talk simultaneously on the Bluetooth® phone and Blue Link® phone.**
- **While on a Bluetooth® call, pressing the  key or  key will display a message indicating that you are currently on a call.**
- **A message will be displayed if you receive a Bluetooth® Bluetooth® Wireless Technology call while already on a Blue Link® call. At this time, press the  key on the steering wheel remote controller to accept the call. The phone bell will not ring.**

Turn by Turn

The Turn by Turn feature can be used through Blue Link®.

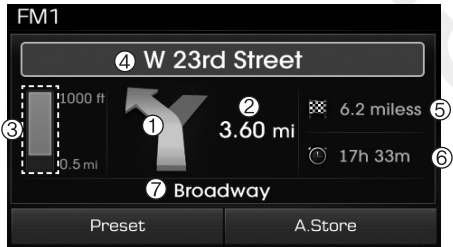

- 1.Direction Indicator Image
- 2.Remaining distance until next point
- 3.The Count bar is divided into a total of 9 levels.

9 Level	0.5mi	8 Level	0.4mi
7 Level	0.3mi	6 Level	0.2mi
5 Level	0.1mi	4 Level	400ft
3 Level	300ft	2 Level	200ft
1 Level	100ft		

- 4.Next Street name
- 5.Distance to destination
- 6.Expected Time Arrival
7. Current Street name

* For information on specific Blue Link® operations, please refer to a separate manual.

i Information

iPod® is a registered trademark of Apple Inc. iPod® mobile digital device sold separately. The Bluetooth® word mark and logos are registered trademarks owned by Bluetooth® SIG, Inc. and any use of such marks by Hyundai is under license. SiriusXM services require a subscription sold separately, or as a package, by Sirius XM Radio Inc. If you decide to continue service after your trial, the subscription plan you choose will automatically renew thereafter and you will be charged according to your chosen payment method at the current rates. Fees and taxes apply. To cancel you must call SiriusXM at 1-866-635-2349. See SiriusXM Customer Agreement for complete terms at www.siriusxm.com. SiriusXM U.S. satellite and data services are available only in the 48 contiguous USA, DC and PR (with coverage limitations). SiriusXM satellite service is also available in Canada; see www.siriusxm.ca. All fees and programming subject to change.

(Continued)

(Continued)

Sirius, XM and all related marks and logos are trademarks of Sirius XM Radio Inc. Android™ is a trademark of Google, Inc. BlackBerry is a registered trademark of Research In Motion Limited (RIM). All other marks, channel names and logos are the property of their respective owners. All rights reserved.

SYSTEM CONTROLLERS AND FUNCTIONS

Audio Head Unit



Name	Description
① ▲	Ejects the disc.
② RADIO	<ul style="list-style-type: none"> Each time the key is pressed, the mode is changed in order of FM1 → FM2 → AM → XM1 → XM2 → XM3 * In Setup>Display, the radio pop up screen will be displayed when [Mode Pop up] is turned On. <p>When the pop up screen is displayed, use the TUNE knob or keys 1 ~ 6 to select the desired mode.</p>

Name	Description
③ MEDIA	<ul style="list-style-type: none"> Each time the key is pressed, the mode is changed in order of CD, USB, iPod, AUX, My Music, BT Audio modes. * In Setup>Display, the media pop up screen will be displayed when [Mode Pop up] is turned On. <p>When the pop up screen is displayed, use the TUNE knob or keys 1 ~ 5 to select the desired mode.</p>
④ PHONE	<ul style="list-style-type: none"> Operates Phone Screen
⑤ SEEK TRACK	<ul style="list-style-type: none"> Radio Mode : Automatically searches for broadcast frequencies. CD, USB, iPod, My Music modes : <ul style="list-style-type: none"> Shortly press the key : Moves to next or previous song(file) Press and hold the key : Rewinds or fast-forwards the current song(file)
⑥ PWR/VOL knob	<ul style="list-style-type: none"> TUNE knob : Turns power On/Off by pressing the knob VOLUME knob : Sets volume by turning the knob left/right
⑦ 1 ~ 6 (Preset)	<ul style="list-style-type: none"> Radio Mode : Saves frequencies (channels) or receives saved frequencies (channels) CD, USB, iPod, My Music mode <ul style="list-style-type: none"> 1 : Repeat 2 : Random



Name	Description
⑧ DISP	<ul style="list-style-type: none"> Each time the button is shortly pressed, it sets the screen Off → Screen On → Screen Off * Audio operation is maintained and only the screen will be turned Off. In the screen Off state, press any key to turn the screen On again.

Name	Description
⑨ SCAN	<ul style="list-style-type: none"> Radio Mode <ul style="list-style-type: none"> Shortly press the key : Previews each broadcast for 5 seconds each Press and hold the key : Previews the broadcasts saved in Preset 1 ~ 6 for 5 seconds each. * Press the SCAN key again to continue listening to the current frequency. XM™ Radio Mode <ul style="list-style-type: none"> Press and hold the key : Previews all receivable broadcasts for 10 seconds each CD, USB, iPod mode <ul style="list-style-type: none"> Shortly press the key : Previews each song (file) for 10 seconds each * Press the SCAN key again to continue listening to the current song (file).
⑩ SETUP	<ul style="list-style-type: none"> Shortly press the key : Moves to the Display, Sound, Phone, System setting modes
⑪ MENU	<ul style="list-style-type: none"> Displays menus for the current mode.
⑫ ▼ CAT FOLDER ▲	<ul style="list-style-type: none"> Radio Mode <ul style="list-style-type: none"> XM™ RADIO : Category Search MP3, CD, USB mode : Folder Search * May differ depending on the selected audio
⑬ ● TUNE knob	<ul style="list-style-type: none"> Radio mode : Changes frequency by turning the knob left/right XM™ Radio mode : Changes channel by turning the knob left/right CD, USB, iPod mode: Searches songs (files) by turning the knob left/right * When the desired song is displayed, press the knob to play the song.

SETUP

Display Settings

Press the **SETUP** key ▶ Select [Display] through **TUNE** knob or **1** key



Mode Pop up

[Mode Pop up] ▶ Changes **On**/**Off** selection mode

- During On state, press the **RADIO** or **MEDIA** key to display the mode change pop up screen.

Media Display

When playing an MP3 file, select the desired display info from 'Folder/File' or 'Album/Artist/Song'.



Sound Settings

Press the **SETUP** key ▶ Select [Sound] through **TUNE** knob or **2** key

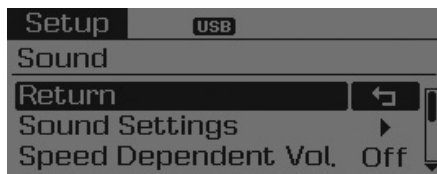

Sound Settings

This menu allows you to set the 'Bass, Middle, Treble' and the Sound Fader and Balance.

Select [Sound Settings] ▶ Select menu through **TUNE** knob ▶ Turn **TUNE** knob left/right to set

- Bass, Middle, Treble : Selects the sound tone.
 - Fader, Balance : Moves the sound fader and balance.
 - Default : Restores default settings.
- * Return : While adjusting values, pressing the **TUNE** knob will restore the parent menu.

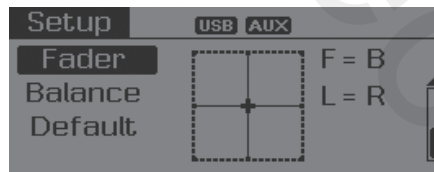

Speed Dependent Volume Control

This feature is used to automatically control the volume level according to the speed of the vehicle.

Select [SDVC] ▶ Turn SDVC On/Off by pressing the **Tune** knob.

Voice Recognition Volume

Adjusts voice recognition volume.

Select [Voice Recognition Vol.] ▶ Set volume of **TUNE** knob

System Settings

Press the **SETUP** key ▶ Select [System] through tune knob or **4** key

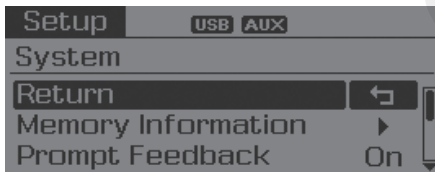

Memory Information

Displays currently used memory and total system memory.

Select [Memory Information] ▶ OK

The currently used memory is displayed on the left side while the total system memory is displayed on the right side.

Prompt Feedback

This feature is used to change voice command feedback between Normal and Expert modes.

Select [Prompt Feedback] ▶ Set through **TUNE** knob

- Normal(On) : This mode is for beginner users and provides detailed instructions during voice command operation.
- Expert(Off) : This mode is for expert users and omits some information during voice command operation. (When using Expert mode, guidance instructions can be heard through the [Help] or [Menu] commands.

Language

This menu is used to set the display and voice recognition language.

Select [Language] ▶ Set through **TUNE** knob



*The system will reboot after the language is changed.

*Language support by region
- English, Français, Español

RADIO : FM, AM

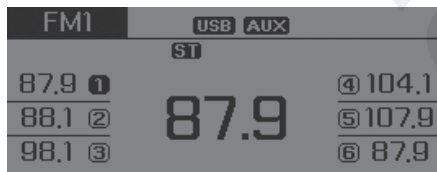

SEEK

Press the **SEEK TRACK** key

- Shortly pressing the key : Changes the frequency.
- Pressing and holding the key : Automatically searches for the next frequency.

Preset SEEK

Press the **1** ~ **6** key

- Shortly pressing the key : Plays the frequency saved in the corresponding key.
- Pressing and holding the key : Pressing and holding the desired key from **1** ~ **6** will save the currently playing broadcast to the selected key and sound a BEEP.

SCAN

Press the **SCAN** key

- Shortly pressing the key : The broadcast frequency increases and previews each broadcast for 5 seconds each. After scanning all frequencies, returns and plays the current broadcast frequency.
- Pressing and holding the key : Previews the broadcasts saved in Preset **1** ~ **6** for 5 seconds each.

Selecting through manual search

Turn the **TUNE** knob left/right to adjust the frequency.

- FM : Changes by 200KHz
- AM : Changes by 9 (Only GUAM), 10KHz

Menu

Press the **MENU** key ▶ Select [1 Auto Store] through the **TUNE** knob or **1** key



1 A.Store

Press the **MENU** key ▶ Set [A.Store] through **TUNE** knob or **1** key

Saves broadcasts with superior reception to **1** ~ **6** keys. If no frequencies are received, then the most recently received frequency will be broadcast.

XM™ RADIO



Your vehicle is equipped with a 3 month complimentary period of XM™ Satellite Radio. XM™ provides access to over 130 channels of music, information, and entertainment programming.

SEEK

Press the  key

- Shortly pressing the key : select previous or next channel.
- Pressing and holding the key : continuously move to previous or next channel.

✳ If the “Category” icon is displayed, channels are changed within the current category.

SCAN

Press the  key

- Shortly pressing the key : Previews each broadcast for 10 seconds each
- ✳ Press the  key again to continue listening to the current frequency
- ✳ If the “Category” icon is displayed, channels are changed within the current category.

Category

Press the  key ▶ Set through the 



- The display will indicate the category menus, highlight the category that the current channel belongs to.
- In the Category List Mode, press the  key to navigate category list.
- Press the tune knob to select the lowest channel in the highlighted category.
- ✳ If channel is selected by selecting category, then the “CATEGORY” icon is displayed at the top of the screen.

Preset

Press the **1** ~ **6** key

- Shortly pressing the key (under 0.8 seconds): Plays the frequency saved in the corresponding key.
- Pressing and holding the key (over 0.8 seconds): Pressing and holding the desired key from **1** ~ **6** will save the current broadcast to the selected key and sound a BEEP.

Menu

Select category menu through the
● TUNE knob ▶ Press the **MENU** key
▶ Select [**I**Info] through the ● TUNE knob or **1** key

Info (Information)



Displays the Artist/Song info of the current song.

BASIC METHOD OF USE : Audio CD / MP3 CD / USB / iPod® / My Music



Name	Description
① Repeat	<p>While song (file) is playing ▶ 1 RPT key</p> <p>Audio CD, MP3 CD, USB, iPod®, My Music mode:</p> <ul style="list-style-type: none"> • Repeats the current song <p>MP3 CD, USB mode:</p> <ul style="list-style-type: none"> • Repeats songs within the current folder. (Pressing the key twice). <p>* Press the 1 RPT key again to turn off repeat.</p>
② Random	<p>While song (file) is playing ▶ 2 RDM key</p> <p>Audio CD, iPod®, My Music mode:</p> <ul style="list-style-type: none"> • Plays all songs randomly <p>MP3 CD, USB mode:</p> <ul style="list-style-type: none"> • Folder Random : Plays all files within the current folder in random order. • All Random : Plays all files in random order (Pressing the key twice). <p>* Press the 2 RDM key again to turn off repeat.</p>
③ Changing Song/File	<p>While song (file) is playing ▶ SEEK TRACK key</p> <ul style="list-style-type: none"> • Shortly pressing the key : plays the current song from the beginning / plays the next song. • Pressing and holding the key : Rewinds the song / fast forwards the song. <p>* If the SEEK TRACK key is pressed again within 1 second, the previous song is played.</p>



Name	Description
④ Scan	While song (file) is playing ► SCAN key Scans all songs for 10 seconds starting from the next song. * Press the SCAN key again to turn off. * The SCAN function is not supported in iPod® mode.
⑤ Folder Search : MP3 CD, USB Mode	While file is playing ► CAT FOLDER key • Searches the previous / next folder * If a folder is selected by pressing the TUNE knob, the first file within the selected folder will be played.

MENU : Audio CD

In CD mode, press **MENU** key.



Repeat

Set [**1**RPT] through the **TUNE** knob or **1 RPT** key to repeat the current song.

* Press RPT again to turn off.

Random

Set [**2**RDM] through the **TUNE** knob or **2 RDM** key to randomly play songs within the current folder.

* Press RDM again to turn off.

Information

Set [**3**Info] through the **TUNE** knob or **3** key to display information of the current song.

* Press the **MENU** key to turn off info display.

MENU : MP3 CD / USB

In MP3 CD / USB mode, press **MENU** key.



Repeat

Set [**1**RPT] through the **TUNE** knob or **1 RPT** key to repeat the current song.

* Press RPT again to turn off.

Folder Random

Set [**2**F.RDM] through the **TUNE** knob or **2 RDM** key to randomly play songs within the current folder.

* Press F.RDM again to turn off.

Folder Repeat

Set [**3**F.RPT] through the **TUNE** knob or **3** key to repeat songs within the current folder.

* Press F.RPT again to turn off.

All Random

Set [**4**A.RDM] through the **TUNE** knob or **4** key to randomly play all songs within the CD.

* Press A.RDM again to turn off.

Information

Set [**5**Info] through the **TUNE** knob or **5** key to display information of the current song.

* Press the **MENU** key to turn off info display.

Copy

Set [**6**Copy] through the **TUNE** knob or **6** key.

* This is used to copy the current song into My Music. You can play the copied Music in My Music mode.

* If another key is pressed while copying is in progress, a pop up asking you whether to cancel copying is displayed.

* If another media is connected or inserted (USB, CD, iPod®, AUX) while copying is in progress, copying is canceled.

* Music will not be played while copying is in progress.

MENU : iPod®

In iPod mode, press **MENU** key.



Repeat

Set [**1**RPT] through the **TUNE** knob or **1 RPT** key to repeat the current song.

* Press RPT again to turn repeat off.

Random

Set [**2**RDM] through the **TUNE** knob or **2 RDM** key.

Plays all songs within the currently playing category in random order.

* Press RDM again to turn off.

Information

Set [3]Info through the TUNE knob or 3 key.

Displays information of the current song.

* Press the MENU key to turn off info display.

Search

Set [4]Search through the TUNE knob or 4 key.

Displays iPod® category list.

* Searching iPod® category is MENU key pressed, move to parent category.

MENU : My Music Mode

In My Music mode, press MENU key.



Repeat

Set [1]RPT through the TUNE knob or 1 RPT key.

Repeats the currently playing song.

* Press RPT again to turn repeat off.

Random

Set [2]RDM through the TUNE knob or 2 RDM key.

Plays all songs within the currently playing folder in random order.

* Press RDM again to turn random off.

Information

Set [3]Info through the TUNE knob or 3 key.

Displays information of the current song.

* Press the MENU key to turn off info display.

Delete

Set [4]Delete through the TUNE knob or 4 key.

- Deletes currently playing file

In the play screen, pressing delete will delete the currently playing song.

- Deletes file from list

① Select the file you wish to delete by using the TUNE knob.



② Press the MENU key and select the delete menu to delete the selected file.

Delete All

Set [5]Del.All through the TUNE knob or [5] key.

Deletes all songs of My Music.

Delete Selection

Press the [MENU] key ▶ Set [6]Del.Sel through the TUNE knob or [6] key. Songs within My Music are selected and deleted.



① Select the songs you wish to delete from the list.



② After selecting, press the [MENU] key and select the delete menu.

AUX

AUX is used to play external MEDIA currently connected with the AUX terminal.

AUX mode will automatically start when an external device is connected to the AUX terminal.

If an external device is connected, you can also press the [MEDIA] key to change to AUX mode.



* AUX mode cannot be started unless there is an external device connected to the AUX terminal.

Bluetooth® Wireless Technology AUDIO

What is Bluetooth® Wireless Technology?

Bluetooth® Wireless Technology allows devices to be connected in a short distance, including hands-free devices, stereo headsets, wireless remote controllers, etc. For more information, visit the Bluetooth® Wireless Technology website at www.Bluetooth.com

Before using Bluetooth® Wireless Technology audio features

- Bluetooth® Wireless Technology audio may not be supported depending on the compatibility of your Bluetooth® Wireless Technology mobile phone.
- In order to use Bluetooth® Wireless Technology audio, you must first pair and connect the Bluetooth® Wireless Technology mobile phone.

- Bluetooth® Wireless Technology audio can be used only when the [Audio Streaming] of Phone is turned (On).

- * Setting Bluetooth® Wireless Technology Audio Streaming : Press the **SETUP** key ▶ Select [Phone] through the tune knob or **3** key ▶ Select [Audio Streaming] through the **TUNE** knob ▶ Set (On)/(Off)

Starting Bluetooth® Wireless Technology Audio

- Press the **MEDIA** key to change the mode in order of CD → USB → AUX → My Music → BT Audio.
- If BT Audio is selected, Bluetooth® Wireless Technology audio will start playing.
- * Audio may not automatically start playing in some mobile phones.

Using the Bluetooth® Wireless Technology audio features

- Play / Stop

Press the **TUNE** knob to play and pause the current song.







- * The play / pause functions may not be supported in some mobile phones.

Making a call using the Steering wheel remote controller



The actual feature in the vehicle may differ from the illustration.

Name	Description
① MODE	<ul style="list-style-type: none"> Each time this key is pressed, the mode is changed in order of FM1 → FM2 → AM → XM1 → XM2 → XM3 → CD → USB or iPod → AUX → My Music → BT Audio If the media is not connected or a disc is not inserted, corresponding modes will be disabled.
② VOL+ VOL-	Raises or lowers speaker volume.
③  key	Places and transfers calls.
④  key	<p>Ends calls or cancels functions.</p> <ul style="list-style-type: none"> Check call history and making call <ol style="list-style-type: none"> Shortly press (under 0.8 seconds) the  key on the steering remote controller. The call history list will be displayed on the screen. Press the  key again to connect a call to the selected number. Redialing the most recently called number <ol style="list-style-type: none"> Press and hold (over 0.8 seconds) the  key on the steering remote controller. The most recently called number is redialed.

Bluetooth® Wireless Technology

Pairing a Bluetooth® Wireless Technology Device

What is Bluetooth® Wireless Technology Pairing?

Pairing refers to the process of synchronizing your Bluetooth® Wireless Technology phone or device with the car audio system for connection. Pairing is necessary to connect and use the Bluetooth® Wireless Technology feature.

⚠ WARNING

Driving while distracted can result in a loss of vehicle control that may lead to an accident, severe personal injury, and death. The driver's primary responsibility is in the safe and legal operation of a vehicle, and use of any handheld devices, other equipment, or vehicle systems which take the driver's eyes, attention and focus away from the safe operation of a vehicle or which are not permissible by law should never be used during operation of the vehicle.

PHONE (if equipped)

Before using the Bluetooth® Wireless Technology phone features

- In order to use Bluetooth® Wireless Technology phone, you must first pair and connect the Bluetooth® Wireless Technology mobile phone.
- If the mobile phone is not paired or connected, it is not possible to enter Phone mode. Once a phone is paired or connected, the guidance screen will be displayed.
- If Priority is set upon vehicle ignition(IGN/ACC ON), the Bluetooth® Wireless Technology phone will be automatically connected. Even if you are outside, the first Bluetooth® Wireless Technology phone will be automatically connected once you are in the vicinity of the vehicle. If you do not want automatic Bluetooth® Wireless Technology phone connection, set the Bluetooth® Wireless Technology power to OFF.

Pairing **PHONE** Key / Key on the Steering Remote Controller

When No Devices have been Paired

1. Press the **PHONE** key or the  key on the steering remote controller. The following screen is displayed.

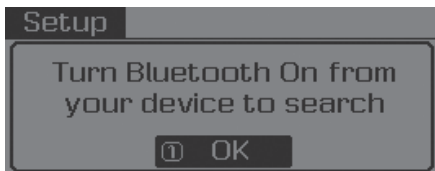

2. Select [OK] button to enter the Pair Phone screen.

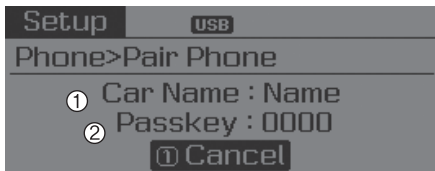

- 1) Car Name : Name of device as shown when searching from your *Bluetooth*[®] Wireless Technology device
- 2) Passkey : Passkey used to pair the device
3. From your *Bluetooth*[®] Wireless Technology device (i.e. Mobile Phone), search and select your car audio system.
4. After a few moments, a screen is displayed 6 digits passkey. Hear, check the passkey on your *Bluetooth*[®] Wireless Technology device and confirm.

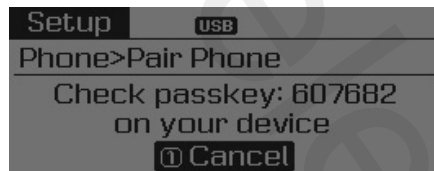

5. Once pairing is complete, the following screen is displayed.

During the pairing process, make sure that all connection requests on the phone are accepted for phonebook download and to allow acceptance of all future connection requests. Visit <http://www.hyundaiusa.com/Bluetooth> for additional information on pairing your Bluetooth-enabled mobile phone, and to view a phone compatibility list.

NOTICE

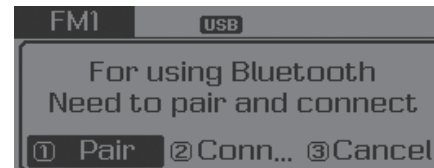

If *Bluetooth*[®] Wireless Technology devices are paired but none are currently connected, pressing the **PHONE** key or the  key on the steering wheel displays the following screen. Select [Pair] button to pair a new device or select [Connect] to connect a previously paired device.

Pairing through [PHONE] Setup

Press the **SETUP** key ▶ Select [Phone] ▶ Select [Pair Phone] ▶ Select **TUNE** knob



1. The following steps are the same as those described in the section "When No Devices have been Paired" on the previous page.

i Information

- **Bluetooth®** Wireless Technology features supported within the vehicle are as follows. Some features may not be supported depending on your **Bluetooth®** Wireless Technology device.
 - Outgoing/Incoming Handsfree calls

(Continued)

(Continued)

- Operations during a call (Switch to Private, Switch to call waiting, MIC on/off)
- Downloading Call History
- Downloading Mobile Contacts
- **Bluetooth®** Wireless Technology device auto connection
- Bluetooth Audio Streaming
- Up to five **Bluetooth®** Wireless Technology devices can be paired to the Car Handsfree system.
- Only one **Bluetooth®** Wireless Technology device can be connected at a time.
- Other devices cannot be paired while a **Bluetooth®** Wireless Technology device is connected.
- Only **Bluetooth®** Wireless Technology Handsfree and Bluetooth audio related features are supported.
- Bluetooth related operations are possible only within devices that support Handsfree or audio features, such as a **Bluetooth®** Wireless Technology mobile phone or a Bluetooth audio device.

(Continued)

(Continued)

- If a connected **Bluetooth®** Wireless Technology device becomes disconnected due to being out of communication range, turning the device OFF, or a **Bluetooth®** Wireless Technology communication error, corresponding **Bluetooth®** Wireless Technology devices are automatically searched and reconnected.
- If the system becomes unstable due to communication errors between the car Handsfree and the **Bluetooth®** Wireless Technology device, reset the device by turning off and back on again. Upon resetting **Bluetooth®** Wireless Technology device, the system will be restored.
- After pairing is complete, a contacts download request is sent once to the mobile phone. Some mobile phones may require confirmation upon receiving a download request, ensure your mobile phone accepts the connection. Refer to your phones user's manual for additional information regarding phone pairing and connections.

Connecting a Device

Press the **SETUP** key ▶ Select [Phone] ▶ Select [Phone List]



- 1) Connected Phone : Device that is currently connected
- 2) Paired Phone : Device that is paired but not connected

From the paired phone list, select the device you want to connect and select [Connect].

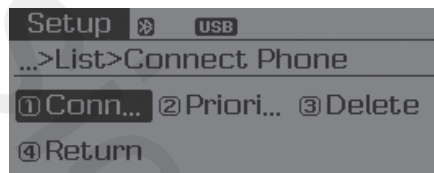

Changing Priority

What is Priority?

It is possible to pair up to five *Bluetooth*® Wireless Technology devices with the car audio system. The "Change Priority" feature is used to set the connection priority of paired phones.

Press the **SETUP** key ▶ Select [Phone] ▶ Select [Phone List]



From the paired phone list, select the phone you want to switch to the highest priority, then select [Change Priority] button from the Menu. The selected device will be changed to the highest priority.

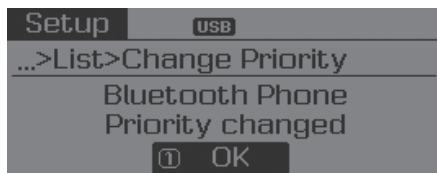

NOTICE

Priority icon will be displayed when the selected phone is set as a priority phone.



Disconnecting a Device

Press the **SETUP** key ▶ Select [Phone] ▶ Select [Phone List]



From the paired phone list, select the currently connected device and select [Disconnect] button.

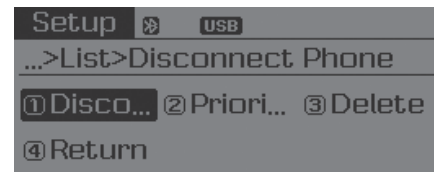

Deleting a Device

Press the **SETUP** key ▶ Select [Phone] ▶ Select [Phone List]

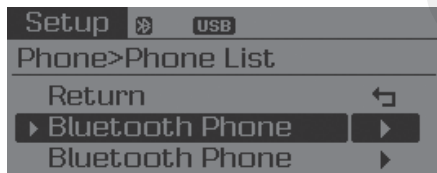

From the paired phone list, select the device you want to delete and select [Delete] button.

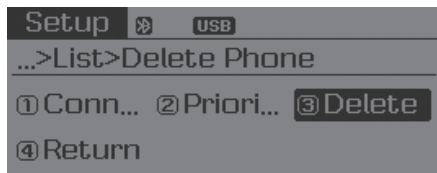

i Information

- When deleting the currently connected device, the device will automatically be disconnected to proceed with the deleting process.
- If a paired *Bluetooth*® Wireless Technology device is deleted, the device's call history and contacts data will also be deleted.
- To re-use a deleted device, you must pair the device again.

Pairing a New Device

Press the **SETUP** key ▶ Select [Phone] ▶ Select [Pair Phone]



Bluetooth® Wireless Technology devices can be paired with the audio system.

For more information, refer to the “Pairing through Phone Setup” section within *Bluetooth*® Wireless Technology.

Viewing Paired Phone List

Press the **SETUP** key ▶ Select [Phone] ▶ Select [Phone List]



This feature is used to view mobile phones that have been paired with the audio system. Upon selecting a paired phone, the setup menu is displayed.

For more information, refer to the “Setting *Bluetooth*® Wireless Technology Connection” section within *Bluetooth*® Wireless Technology.

- 1) Connect/Disconnect Phone : Connect/ disconnects currently selected phone
- 2) Change Priority : Sets currently selected phone to highest connection priority
- 3) Delete : Deletes the currently selected phone
- 4) Return : Moves to the previous screen

i Information - Before downloading contacts

- Only contacts within connected phones can be downloaded. Also check to see that your mobile phone supports the download feature.
- To learn more about whether your mobile phone supports contacts downloads, refer to your mobile phone user’s manual.
- The contacts for only the connected phone can be downloaded.

Downloading Contacts

Press the **SETUP** key ▶ Select [Phone] ▶ Select [Contacts Download]



As the contacts are downloaded from the mobile phone, a download progress bar is displayed.

i Information

- Upon downloading phone contacts, the previous corresponding data is deleted.
- This feature may not be supported in some mobile phones.
- Voice Recognition may not operate while contacts are being downloaded.

Outgoing Volume

Press the **SETUP** key ▶ Select [Phone] ▶ Select [Outgoing Volume]
Use **TUNE** knob to adjust the outgoing volume level.

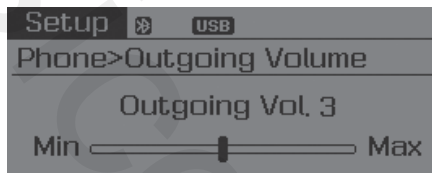

i Information

While on a call, the volume can be changed by using the **SEEK TRACK** key.

Turning Bluetooth System Off

Press the **SETUP** key ▶ Select [Phone] ▶ Select [Bluetooth System Off]

Once *Bluetooth*® Wireless Technology is turned off, *Bluetooth*® Wireless Technology related features will not be supported within the audio system.

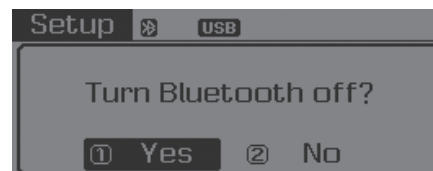
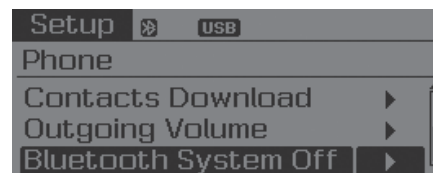

i Information

To turn *Bluetooth*® Wireless Technology back on, go to **SETUP** ▶ [Phone] and select “Yes”.

Phone Menu Screen

Phone Menus

With a *Bluetooth*® Wireless Technology device connected, press the **PHONE** key to display the Phone menu screen.



- 1) Favorite : Up to 20 frequently used contacts saved for easy access
- 2) Call History : Device the call history list screen
- 3) Contacts : Displays the Contacts list screen
- 4) Setup : Displays Phone related settings.

i Information

- If you select the [Call History] button but there is no call history data, a prompt is displayed which asks to download call history data.
- If you select the [Contacts] button but there is no contacts data stored, a prompt is displayed which asks to download contacts data.
- This feature may not be supported in some mobile phones. For more information on download support, refer to your mobile phone user's manual.

Answering Calls

Answering a Call

Answering a call with a *Bluetooth*® Wireless Technology device connected will display the following screen.

To accept the call, press **CALL** key on the steering wheel while the call is incoming.



- 1) Caller : Displays the other party's name when the incoming caller is saved within your contacts
- 2) Incoming Number : Displays the incoming number

i Information

- When an incoming call pop-up is displayed, most Audio and SETUP mode features are disabled. Only the call volume will operate.
- The telephone number may not be properly displayed in some mobile phones.
- When a call is answered with the mobile phone, the call mode will automatically revert to Private mode.

Favorites

Press the **PHONE** key ▶ Select [Favorites]



- 1) Saved favorite contact : Connects call upon selection
- 2) To add favorite : Downloaded contacts be saved as favorite.

i Information

- To save Favorite, contacts should be downloaded.
- Contact saved in Favorites will not be automatically updated if the contact has been updated in the phone. To update Favorites, delete the Favorite and create a new Favorite.

Call History

Press the **PHONE** key ▶ Select [Call History]



A list of incoming, outgoing and missed calls is displayed.

- Call history may not be saved in the call history list in some mobile phones.
- Calls received with hidden caller ID will not be saved in the call history list.
- Calling through the call history is not possible when there is no call history stored or a *Bluetooth*® Wireless Technology phone is not connected.
- Up to 50 received, dialed and missed calls are stored in Call History.
- Time of received/dialed calls and call time information are not saved.

Contacts

Press the **PHONE** key ▶ Select [Contacts]



The list of saved phone book entries is displayed.

NOTE:

Find a contact in an alphabetical order, press the **MENU** key.



i Information

- Up to 1,000 contacts saved in your *Bluetooth*® Wireless Technology phone can be downloaded into the car contacts. Contacts that have been downloaded to the car cannot be edited or deleted on the phone.
- Mobile phone contacts are managed separately for each paired *Bluetooth*® Wireless Technology device (max 5 devices x 1,000 contacts each). Previously downloaded data is maintained even if the *Bluetooth*® Wireless Technology device has been disconnected.

(However, the contacts and call history saved to the phone will be deleted if a paired phone is deleted.)

- It is possible to download contacts during Bluetooth streaming audio.
- When downloading contacts, the icon will be displayed within the status bar.

(Continued)

(Continued)

- It is not possible to begin downloading a contact list when the contact download feature has been turned off within the *Bluetooth*® Wireless Technology device. In addition, some devices may require device authorization upon attempting to download contacts. If downloading does not normally occur, check the *Bluetooth*® Wireless Technology device settings or the screen state.
- The contacts download feature may not be supported in some mobile phones. For more information of supported *Bluetooth*® devices and function support, refer to your phone's user manual.

VOICE RECOGNITION

Using Voice Recognition

Starting Voice Recognition

Shortly press the  key on the steering wheel. Say a command.

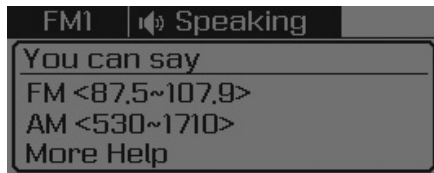

If prompt feedback is in [ON], then the system will say “Please say a command after the beep (BEEP)”

- If prompt feedback is in [OFF] mode, then the system will only say “(BEEP)”
- To change Prompt Feedback [On]/[Off], go to **SETUP** ▶ [System] ▶ [Prompt Feedback]

Information

For proper recognition, say the command after the voice instruction and beep tone.

Contact List Best Practices

- 1) Do not store single-name entries (e.g., “Bob”, “Mom”, “Kim”, etc.). Instead, always use full names (including first and last names) for all contacts (e.g., use “Jacob Stevenson” instead of “Dad”).
- 2) Do not use abbreviations (i.e., use “Lieutenant” instead of “Lt.” or “Sergeant” instead of “Sgt.”).
- 3) Do not use acronyms (i.e., use “County Finance Department” instead of “CFD”).
- 4) Do not use special characters (e.g., “@”, “hyphen -”, “asterisk *”, “ampersand &”).
- 5) If a name is not recognized from the contact list, change it to a more descriptive name (e.g., use “Grandpa Joseph” instead of “Pa Joe”).

Skipping Prompt Messages

While prompt message is being stated ▶ Shortly press the  key on the steering remote controller

The prompt message is immediately ended and the beep tone will sound. After the “beep”, say the voice command.

Re-starting Voice Recognition

While system waits for a command ▶ Shortly press the  key on the steering remote controller

The command wait state is immediately ended and the beep tone will sound. After the “beep”, say the voice command.

ENDING VOICE RECOGNITION

While Voice Recognition is operating

- ▶ Press and hold the  key on the steering remote controller

Information

- While using voice command, pressing any steering wheel control or a different key will end voice command.
- When the system is waiting for a voice command, say “cancel” or “end” to end voice command.
- When the system is waiting for a voice command, press and hold the  key on the steering wheel to end voice command.

Voice Recognition and Phone Contact Tips:

The Hyundai Voice Recognition System may have difficulty understanding some accents or uncommon names.

When using Voice Recognition to place a call, speak in a moderate tone, with clear pronunciation To maximize the use of Voice Recognition, consider these guidelines when storing contacts:

- Do not store single-name entries (e.g., “Bob”, “Mom”, etc.). Instead, always use full names (including first and last names) for these contacts
- Do not use special characters (e.g., '@', '-', '*', '&', etc.)
- Do not use abbreviations (i.e., use “Lieutenant” instead of “Lt.”) or acronyms (i.e., use “County Finance Department” instead of “C. F. D.”; Be sure to say the name exactly as it is entered in the contacts list

Illustration on using voice commands

- Starting voice command.

Shortly pressing the  key (under 0.8 seconds):

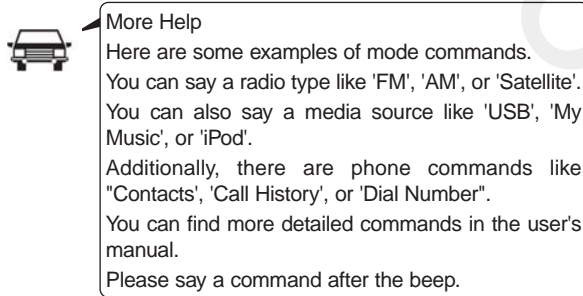
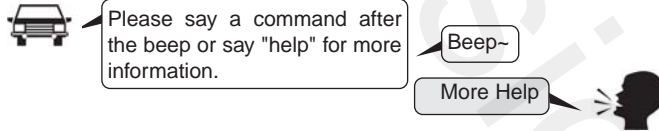

- Skipping Voice Recognition

Shortly pressing the  key (under 0.8 seconds):

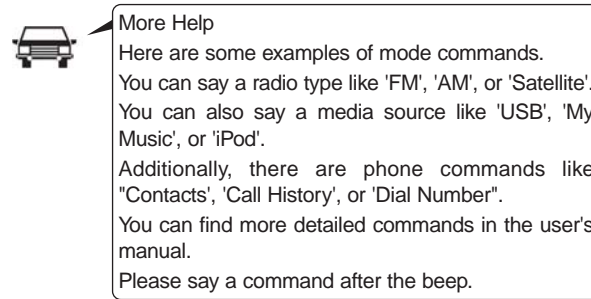
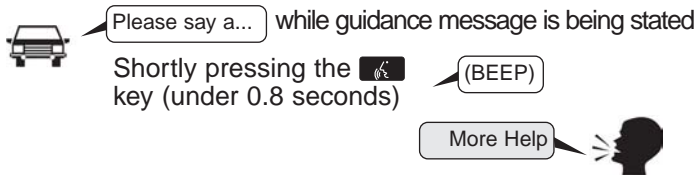

- End voice command.

Shortly pressing the  key (under 0.8 seconds):

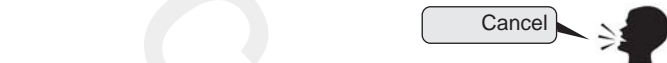
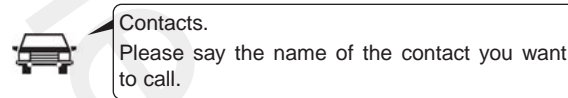
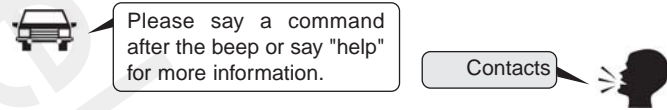

Voice Command List

- Common Commands: These commands can be used in most operations. (However a few commands may not be available during certain operations)

Command	Function
More Help	Provides guidance on commands that can be used anywhere in the system.
Help	Provides guidance on commands that can be used within the current mode.
Call<Name>	Calls <Name> saved in Contacts Ex) Call "John Smith"
Call <Name> on Mobile	Calls <Name> to the number that is saved as "Mobile" in Contacts Ex) Call "John Smith" on Mobile
Call <Name> in Office	Calls <Name> to the number that is saved as "Office" in Contacts Ex) Call "John Smith" in Office
Call <Name> at Home	Calls <Name> to the number that is saved as "Home" in Contacts Ex) Call "John Smith" at Home
Call <Name> on Other	Calls <Name> to the number that is saved as "Other" in Contacts Ex) Call "John Smith" on Other
Phone	Provides guidance on Phone related commands. After saying this command, say "Favorites", "Call History", "Contacts" or "Dial Number" execute corresponding functions.
Favorites	Display the Favorite screen.
Call History	Displays the Call History screen.

Command	Function
Contacts (Call by Name)	Displays the Contacts screen. After saying this command, say the name of a contact saved in the Contacts to automatically connect the call.
Dial Number	Display the Dial number screen. After saying this command, you can say the number that you want to call.
Redial	Connects the most recently called number.
Tutorial	Provide guidance on how to use voice recognition and Bluetooth® connections.
Radio	<ul style="list-style-type: none"> • When listening to the radio, displays the next radio screen. (FM1→FM2→AM→XM1→XM2→XM3→FM1) • When listening to a different mode, displays the most recently played radio screen. • When currently listening to the FM radio, maintains the current state. • When listening to a different mode, displays the most recently played FM screen.
FM1(FM One)	Displays the FM1 screen.
FM2(FM Two)	Displays the FM2 screen.
AM	Displays the AM screen.

Command	Function
FM Preset 1~6	Plays the most recently played broadcast saved in FM Preset 1~6.
AM Preset 1~6	Plays the broadcast saved in AM Preset 1~6.
FM 87.5~107.9	Plays the FM broadcast of the corresponding frequency.
AM 530~1701	Plays the AM broadcast of the corresponding frequency.
SiriusXM™	<ul style="list-style-type: none"> • When currently listening to the SiriusXM™, maintains the current state. • When listening to a different mode, displays the most recently played SiriusXM™ screen.
SiriusXM™ 1~3	Displays the selected XM™ screen.
SiriusXM™ Channel 0~255	Plays the selected XM™ channel.
Media	Moves to the most recently played media screen.
CD	Plays the music saved in the CD.
USB	Plays USB music.
iPod®	Plays iPod music.
My Music	Plays the music saved in My Music.
AUX (Auxiliary)	Plays the connected external device.
Bluetooth® Audio	Plays the music saved in connected Bluetooth® device.
Mute	Mutes the sound

Command	Function
Please repeat	Repeats the most recent comment.
Mute	Mutes the sound.
Cancel (Exit)	Ends voice command.

- FM/AM radio commands: Commands available during FM, AM radio operation

Command	Function
Preset 1~6	Plays the broadcast station saved in Preset 1~6.
Scan	Scans receivable frequencies from the current broadcast and plays for 10 seconds each.
Preset Scan	Moves to the next preset from the current present and plays for 10 seconds each.
Information	Displays the information of the current broadcast.(This feature can be used when receiving RBDS broadcasts.)

- Satellite radio commands: Commands that can be used while listening to Satellite Radio.

Command	Function
Channel 0~255	Play the selected Satellite Radio channel.
Scan	Scans receivable channels from the current broadcast and plays for 10 seconds each.
Preset 1~6	Plays the broadcast saved in Preset 1~6.
Information	Displays the information of the current broadcast.

- Audio CD commands: Commands available during Audio CD operation

Command	Function
Random	Randomly plays the tracks within the CD.
Random Off	Cancel random play to play tracks in sequential order.
Repeat	Repeats the current track.
Repeat Off	Cancel repeat play to play tracks in sequential order.
Track 1~30	Plays the desired track number.

- MP3 CD / USB commands: Commands available during USB and MP3 CD operation

Command	Function
Random	Randomly plays the files within the current folder.
Random Off	Cancel random play to play files in sequential order.
Repeat	Repeats the current file.
Repeat Off	Cancel repeat play to play files in sequential order.
Information	Displays the information screen of the current file.
Next Folder	Play the first file in the next folder
Previous Folder	Play the first file in the previous folder

- iPod® Commands: Commands available during iPod® operation

Command	Function
Random	Randomly plays the songs within the current category.
Random Off	Cancels random play to play songs in sequential order.
Repeat	Repeats the current song.
Repeat Off	Cancels repeat play to play songs in sequential order.

- My Music Commands: Commands available during My Music operation

Command	Function
Random	Randomly plays all saved files.
Random Off	Cancels random play to play files in sequential order.
Repeat	Repeats the current file.
Repeat Off	Cancels repeat play to play files in sequential order.
Delete	Deletes the current file. You will bypass an additional confirmation process.

- Bluetooth® Wireless Technology Audio Commands: Commands available during Bluetooth® Wireless Technology audio streaming from mobile phone operation Command Operation

Command	Function
Play	Plays the currently paused song.
Pause	Pauses the current song.

SYSTEM CONTROLLERS AND FUNCTIONS

Audio Head Unit



Name	Description
①	Ejects the disc.
② RADIO	<ul style="list-style-type: none"> Convert to Radio mode. Each time the key is pressed, the mode is changed in order of FM1, FM2, AM, XM1, XM2, XM3.
③ MEDIA	<ul style="list-style-type: none"> Convert to Media Mode Each time the key is pressed, the mode is changed in order of CD, USB(iPod®), AUX, My Music, BT Audio.

Name	Description
④ PHONE	<p>(for <i>Bluetooth</i>® Wireless Technology equipped model)</p> <ul style="list-style-type: none"> Converts to Phone mode * When a phone is not connected, the connection screen is displayed.
⑤	<ul style="list-style-type: none"> Power : Press to turn power on/off. Volume : Turn left/right to control volume.
⑥	<ul style="list-style-type: none"> When pressed shortly <ul style="list-style-type: none"> Radio mode : plays previous/next frequency. Media (CD/USB/iPod®/My Music) modes : changes the track, Song(file) When pressed and held <ul style="list-style-type: none"> Radio mode : continuously changes the frequency. Upon release, plays the current frequency. Media(CD/USB/iPod®/My Music) modes : rewinds or fast forwards the track or file During a Handsfree call, controls the call volume.
⑦	<ul style="list-style-type: none"> XM™ RADIO : Category Search CD/USB/MP3 mode : Search Folder





No **dimension** will be shown if the **dimension** feature is not supported.

Name	Description
⑧ DISP	• Turns the monitor display on/off.
⑨ MUTE	When the button is pressed, stops sound and "Audio Mute" is displayed on LCD.
⑩ SCAN	<ul style="list-style-type: none"> • Radio Mode : previews all receivable broad casts for 5 seconds each • XM™ Radio Mode: previews all receivable broadcasts for 10 seconds each • Media (CD/USB/My Music) modes : previews each song (file) for 10 seconds each.
⑪ SETUP	Converts to Setup mode.
⑫ TUNE knob	<ul style="list-style-type: none"> • Radio mode : turn to change broadcast frequencies. • XM™ Radio mode : turn to change broadcast channels • Media (CD/USB/iPod®/My Music) modes : turn to search tracks/ channels/files.



Steering-Wheel Mounted Controls



The actual feature in the vehicle may differ from the illustration.

Name	Description
① 	<ul style="list-style-type: none"> When pressed shortly <ul style="list-style-type: none"> - Starts voice recognition - When selecting during a voice prompt, stops the prompt and converts to voice command waiting state When pressed and held (over 0.8 seconds) <ul style="list-style-type: none"> - Ends voice recognition
② MODE	<ul style="list-style-type: none"> Each time this key is pressed, the mode is changed in order of FM1 → FM2 → AM → XM1 → XM2 → XM3 → CD → USB or iPod → AUX → My Music → BT Audio If the media is not connected or a disc is not inserted, corresponding modes will be disabled.
③ VOL+ , VOL-	Used to control volume.
④  , 	<p>Mute the microphone during a call.</p> <ul style="list-style-type: none"> When pressed shortly (under 0.8 seconds) <ul style="list-style-type: none"> - Radio mode : searches broadcast frequencies and channels saved to presets. - Media(CD / USB / iPod® / My Music / BT Audio) modes : changes the track, file or chapter. When pressed and held (over 0.8 seconds) <ul style="list-style-type: none"> - Radio mode, automatically searches broadcast frequencies and channels - Media(CD / USB / iPod® / My Music) modes, rewinds or fast forwards the track or song(file) - BT Audio mode may not be supported in some mobile phones.



Name	Description
⑤ 	<ul style="list-style-type: none"> • When pressed shortly <ul style="list-style-type: none"> - When pressed in the phone screen, displays call history screen - When pressed in the dial screen, makes a call - When pressed in the incoming call screen, answers the call - When pressed during call waiting, switches to waiting call (Call Waiting) • When pressed and held (over 0.8 seconds) <ul style="list-style-type: none"> - When pressed in the <i>Bluetooth</i>[®] Wireless Technology Handsfree wait mode, redials the last call - When pressed during a <i>Bluetooth</i>[®] Wireless Technology Handsfree call, switches call back to mobile phone (Private) - When pressed while calling on the mobile phone, switches call back to <i>Bluetooth</i>[®] Wireless Technology Handsfree (Operates only when <i>Bluetooth</i>[®] Wireless Technology Handsfree is connected)
⑥ 	Ends phone call

RADIO MODE

Basic Mode Screen



1. Mode Display
Displays currently operating mode.

2. Frequency
Displays the current frequency.

3. Preset
Displays current preset number P1 ~ P6.

4. Preset Display
Displays preset buttons.

5. A.store
Automatically saves frequencies with superior reception to Preset buttons.

Switching to Radio Mode

Pressing the **RADIO** key will change the operating mode in order of FM1 → FM2 → AM → XM1 → XM2 → XM3

If [Mode Pop up] is turned on within **SETUP** ▶ [Display], then pressing the **RADIO** key will display the Radio Pop-up Mode screen.

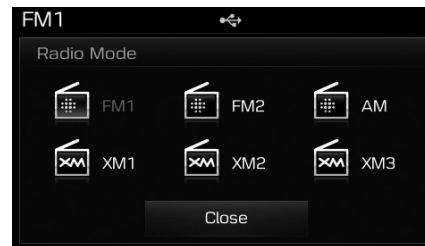

Turn the **TUNE** knob to move the focus. Press the knob to select.

Searching Radio Frequencies Using Radio Mode

Using Seek

Press the  key to play the previous/next frequency.

Using TUNE

Turn the  TUNE knob to select the desired frequency.

- FM : Increases/decreased by 200kHz
- AM : Increased/decreased by 9 (Only GUAM), 10kHz



Selecting Presets/Saving Presets

Press the  button to display the broadcast information for the frequency saved to each button.



Press the  ~  buttons to play the desired preset.

Information

While listening to a frequency you want to save as a preset, press and hold one of the  ~  preset buttons (over 0.8 seconds) to save the current frequency to the selected preset.

Auto Store

Press the  button to automatically save receivable frequencies to Preset buttons.

Information

While Auto Store is operating, pressing the [Cancel] button again will cancel Auto Store and restore the previous frequency.

Scan

Press the  key to preview frequencies with superior reception for 5 seconds each.

Press and hold the  key (over 0.8 seconds) to preview presets for 5 seconds each.

Once scan is complete, the previous frequency will be restored.

While Scan is operating, pressing the  key will cancel the scan operation.

XM™ RADIO MODE

Basic Mode Screen

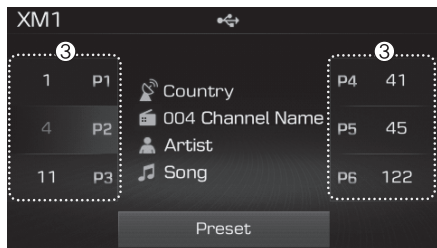

1. Mode Display

Displays currently operating mode.

2. Channel Information

Displays the category, channel number, channel name, artist and title information.

3. Preset

Displays currently playing preset number **P1** ~ **P6**.

4. Preset Display

Displays saved presets.

Using SEEK

Press the **SEEK TRACK** key to play the previous/next channel.

*If the "Category" icon is displayed, channels are changed within the current category.

SCAN

Press the **SCAN** key to scan all channels with superior reception for 5 seconds each.

Once scan is complete, the previously played channel will be restored.

During Scan, pressing the **SCAN** key again will cancel the scan operation and restore the previously played channel.

If the “Category” icon is displayed, channels are changed within the current category.

Searching Categories

Select the category by using the **▼ CAT FOLDER ▲** key and press the **⦿ TUNE** knob to select.

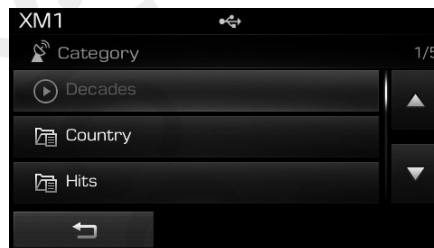

Channels for the selected category are played.

Selecting Presets/Saving Presets

Press the **Preset** button to display the broadcast information for the channel saved to each button.

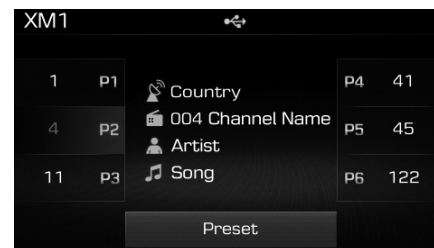

Press the **P1** ~ **P6** buttons to play the desired preset.

i Information

While listening to a channel you want to save as a preset, press and hold one of the **P1** ~ **P6** preset buttons to save the current channel to the selected preset.

MEDIA MODE

Pressing the **MEDIA** key will change the operating mode in order of CD → USB(iPod®) → AUX → My Music → BT Audio.

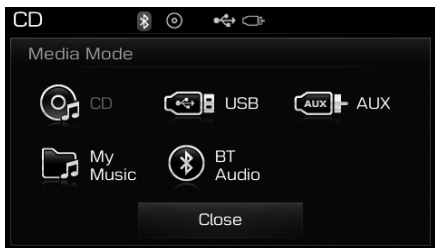

If [Mode Pop up] is turned on within **SETUP** ▶ [Display], then pressing the **MEDIA** key will display the Media Pop-up Mode screen.

Turn the **TUNE** knob to move the focus. Press the knob to select.

i Information

The media mode pop up screen can be displayed only when there are two or more media modes turned on.

Title Icon

When a *Bluetooth®* Wireless Technology, iPod®, USB, or AUX device is connected or a CD is inserted, the corresponding mode icon will be displayed.



Icon	Title
	<i>Bluetooth®</i> Wireless Technology
	CD
	iPod®
	USB
	AUX



AUDIO CD MODE

Using Audio CD Mode

Playing/Pausing CD Tracks

Once an audio CD is inserted, the mode will automatically start and begin playing.



While playing, press the  button to pause and press  button to play.



Information

- Only genuine audio CDs are supported. Other discs may result in recognition failure (e.g. copy CD-R, CDs with labels)
- The artist and title information are displayed on the screen if track information is included within the audio CD.

Changing Tracks

Press the  key to move to the previous or next track.

Information

- Pressing the  key after the track has been playing for 2 seconds will start the current track from the beginning.
- Pressing the  key before the track has been playing for 1 seconds will start the previous track.

Selecting from the List

Turn the **TUNE** knob left/right to search for the desired track.

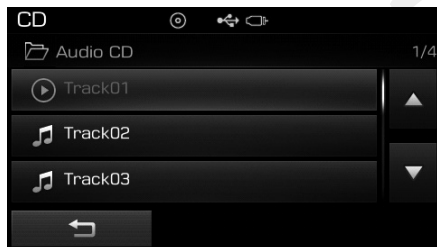

Once you find the desired track, press the **TUNE** knob to start playing.

Rewinding / Fast-forwarding Tracks

While playing, press and hold the **SEEK TRACK** key to rewind or fast-forward the current track.

Scan

Press the **SCAN** key to play the first 10 seconds of each file.

Audio CD Mode Menu

Within this mode, you will have access to the Info, Random(Shuffle), Repeat and List features.

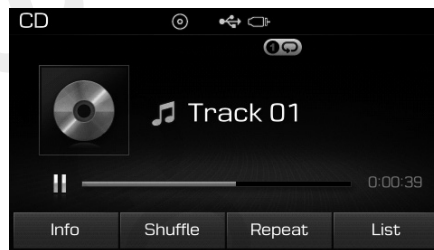

Info

Press the **Info** button to display details about the current disc.

Random(Shuffle)

Press the **Shuffle** button to play tracks in random(Shuffle) order.

Press the **Shuffle** button again to turn the Random(Shuffle) feature off.

- Random(Shuffle): Plays all tracks in random(Shuffle) order.

Repeat

Press the **Repeat** button to repeat the current track. Press the button again to turn the repeat feature off.

- Repeat : Repeats the current track.

List

Press the **List** button to display the track list screen.

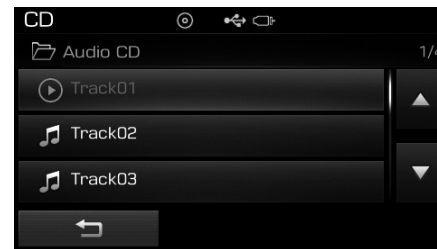

Turn the **TUNE** knob left/right to search for tracks. Once the desired track is displayed, press the knob to select and play.



MP3 CD MODE

Using MP3 CD Mode

Playing/Pausing MP3 Files

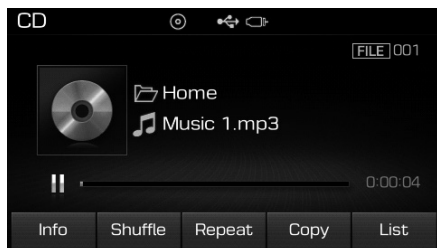
Once an MP3 disc is inserted the mode will automatically start and being playing.



While playing, press the  button to pause and press  button to play.



Information

If there are numerous files and folders within the disc, reading time could take more than 10 seconds and the list may not be displayed or song searches may not operate. Once loading is complete, try again.

Changing Files

Press the  key to move to the previous or next file.

NOTICE

- Pressing the  key after the file has been playing for 2 seconds will start the current file from the beginning.
- Pressing the  key before the file has been playing for 1 seconds will start the previous file.

Selecting from the List

Turn the  knob left/right to search for the desired file.

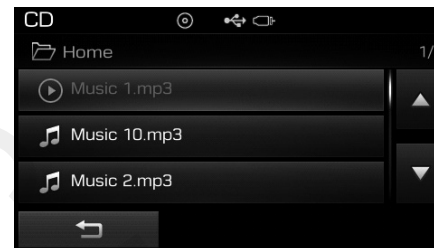

Once you find the desired file, press the  knob to start playing.

Rewinding / Fast-forwarding Files

While playing, press and hold the **SEEK TRACK** key (over 0.8 seconds) to rewind or fast-forward the current file.

Scan

Press the **SCAN** key to play the first 10 seconds of each file.

Searching Folders

Press the **CAT FOLDER** key to select and search folders.

Once the desired folder is displayed, press the **TUNE** knob to select.

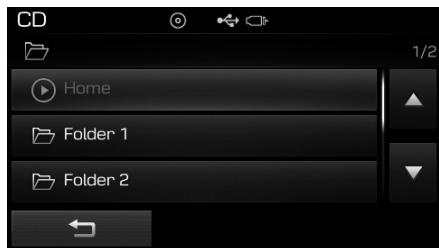

The first file within the selected folder will begin playing.

MP3 CD Mode Menu

Within this mode, you will have access to the Info, Random(Shuffle), Repeat, Copy and List features.

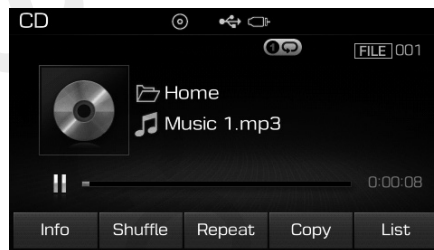

Info

Press the **Info** button to display details about the current file.

Information

- When the 'Folder File' option is set as the default display within Display setup, the album/artist/file information are displayed as detailed file information.
- When the 'Album Artist Song' option is set as the default display, the folder name/file name are displayed as detailed file information.
- The title, artist and album info are displayed only when such information are recorded within the MP3 file ID3 tag.

Random(Shuffle)

Press the **Shuffle** button to play files in random(Shuffle) order.

Each time the button is pressed, the feature changes in order of Random (Shuffle) Folder → Random (Shuffle) All → Off.

- Random(Shuffle) Folder : Plays all files within the current folder in Random (Shuffle) order.
- Random(Shuffle) All : Plays all files in Random(Shuffle) order.

Repeat

Press the **Repeat** button to repeat the current file or folder.

Each time the button is pressed, the feature changes in order of Repeat →Repeat Folder→Off.

- Repeat: Repeats the current file.
- Repeat Folder: Repeats all files within the current Folder.

Copying Files

Press the **Copy** button to copy the current file into My Music.

i Information

Selecting another feature during copying will display a pop-up asking whether you wish to cancel copying. To cancel, select 'Yes'.

List

Press the **List** button to display the file list screen.

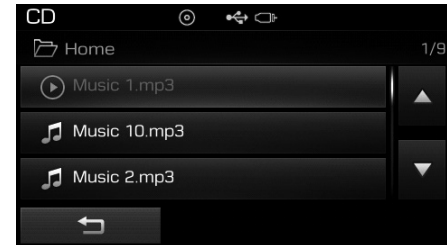

Turn the **TUNE** knob left/right to search for files. Once the desired file is displayed, press the knob to select and play.

USB MODE

Using USB Mode

Playing/Pausing USB Files

Once a USB is connected, the mode will automatically start and begin playing a USB file.

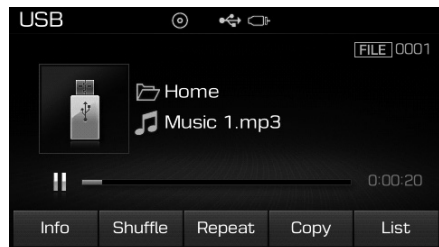

While playing, press the **||** button to pause and press **▶** button to play.

i Information

- Loading may require additional time if there are many files and folders within the USB and result in faulty list display or file searching. Normal operations will resume once loading is complete.
- The device may not support normal operation when using a USB memory type besides (Metal Cover Type) USB Memory.

Changing Files

Press the **SEEK TRACK** keys to move to the previous or next file.

i Information

- Pressing the **SEEK TRACK** key after the file has been playing for 2 seconds will start the current file from the beginning.
- Pressing the **SEEK TRACK** key before the file has been playing for 1 seconds will start the previous file.

Selecting from the List

Turn the **TUNE** knob left/right to search for the desired file.

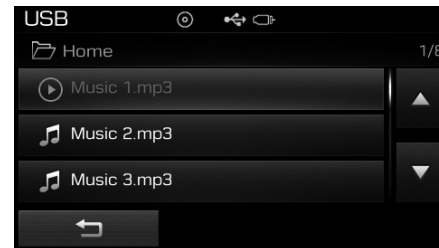

Once you find the desired file, press the **TUNE** knob to start playing.

Rewinding / Fast-forwarding Files

While playing, press and hold the **SEEK TRACK** key (over 0.8 seconds) to rewind or fast-forward the current file.

Scan

Press the **SCAN** key to play the first 10 seconds of each file.

Searching Folders

Press the  key to select and search folders.

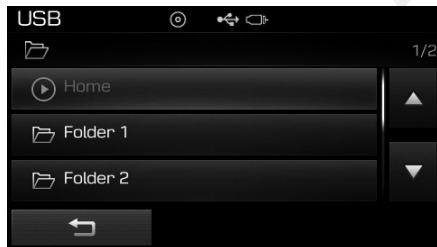

Once the desired folder is displayed, press the  TUNE knob to select.

The first file within the selected folder will begin playing.

USB Mode Menu

Within this mode, you will have access to the Info, Random(Shuffle), Repeat, Copy and List features.

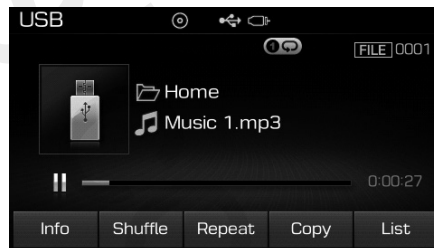

Info

Press the  button to display details about the current file.

Information

- When the 'Folder File' option is set as the default display within Display setup, the album/artist/file information are displayed as detailed file information.
- When the 'Album Artist Song' option is set as the default display, the folder name/file name are displayed as detailed file information.
- The title, artist and album info are displayed only when such information are recorded within the MP3 file ID3 tag.

Random (Shuffle)

Press the **Shuffle** button to play files in random(Shuffle) order.

Each time the button is pressed, the feature changes in order of Random(Shuffle) Folder→Random (Shuffle) All→Off.

- Random(Shuffle) Folder : Plays the files in the current folder in random(Shuffle) order.
- Random(Shuffle) All : Plays all files in random(Shuffle) order.

Repeat

Press the **Repeat** button to repeat the current file or folder.

Each time the button is pressed, the feature changes in order of Repeat→Repeat Folder → Off.

- Repeat : Repeats the current file.
- Repeat Folder : Repeats all files within the current folder.

Copying Files

Press the **Copy** button to copy the current file into My Music.

i Information

Selecting another feature during copying will display a pop-up asking whether you wish to cancel copying. To cancel, select 'Yes'.

List

Press the **List** button to display the file list screen.

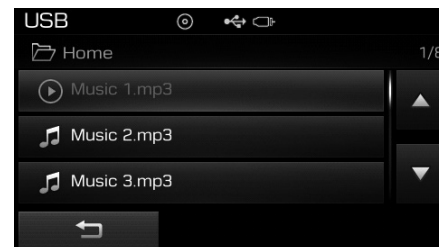

Turn the **TUNE** knob left/right to search for files. Once the desired file is displayed, press the knob to select and play.



iPod® MODE

Using iPod® Mode

Playing/Pausing iPod® Songs

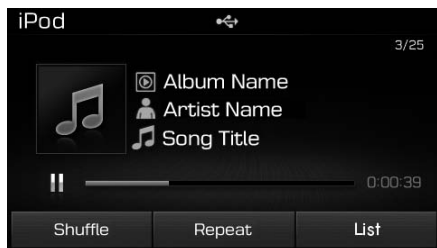
Once an iPod® is connected, the mode will automatically start and begin playing an iPod® song.



While playing, press the  button to pause and press  button to play.



Information

iPod®s with unsupported communication protocols may not properly operate in the audio system.

Changing Songs

Press the  key to move to the previous or next song.

NOTICE

- Pressing the  key after the song has been playing for 2 seconds will start the current song from the beginning.
- Pressing the  key before the song has been playing for 1 seconds will start the previous song.
- Slight time differences may exist depending your iPod® product.

Rewinding / Fast-forwarding Songs

While playing, press and hold the  key (over 0.8 seconds) to rewind or fast-forward the current song.

Searching Categories

Turn the  TUNE knob left/right to search for the desired category.

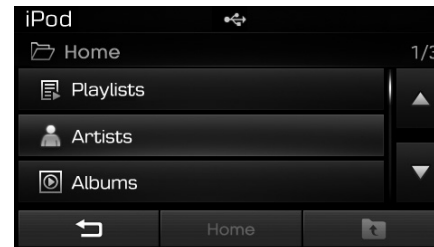

Once you find the desired category, press the  TUNE knob to select and play.



Information

There are eight categories that can be searched, including Playlists, Artists, Albums, Genres, Songs, Composers, Audiobooks and Podcasts.

Category Menu

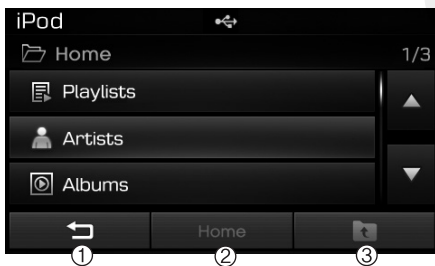
Within the iPod® Category menu, you will have access to the , Home, and  features.



1.  : Displays the play screen
2. Home : Moves to the iPod® root category screen
3.  : Moves to the previous category

Information

- If the search mode is accessed while playing a song, the most recently searched category is displayed.
- Search steps upon initial connection may differ depending on the type of iPod® device.

iPod® Mode Menu

Within this mode, you will have access to the Random(Shuffle), Repeat and List features.

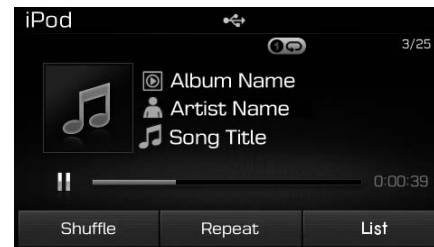

Random(Shuffle)

Press the  button to play songs in random(Shuffle) order.

- Random(Shuffle) All : Plays all songs in Random(Shuffle) order.

Repeat

Press the **Repeat** button to repeat the current song. Press the button again to turn the repeat feature off.

- Repeat : Repeats the current song

List

Press the **List** button to display the Category Menu.

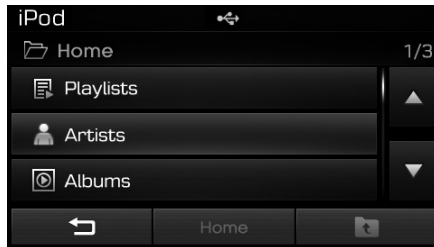

Turn the **TUNE** knob left/right to search for the desired category.

Once you find the desired category, press the **TUNE** knob to select and play.

AUX MODE

Using AUX Mode

Press the **MEDIA** key ▶ Select [AUX]

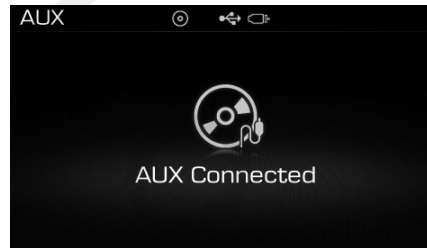

An external device can be connected to play music.

Connecting an External Device

External audio players (Camcorders, car VCR, etc.) can be played through a dedicated cable.

MY MUSIC MODE

Using My Music Mode

Playing/Pausing My Music Files

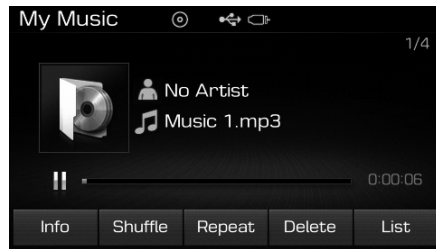

While playing, press the **||** button to pause and press **▶** button to play.

i Information

If there are no files saved within My Music, the **My Music** button will be disabled.

Changing Files

Press the **SEEK TRACK** key to move to the previous or next file.

i Information

- Pressing the **SEEK TRACK** key after the file has been playing for 2 seconds will start the current file from the beginning.
- Pressing the **SEEK TRACK** key before the file has been playing for 1 seconds will start the previous file.

Selecting from the List

Turn the **TUNE** knob left/right to search for the desired file.

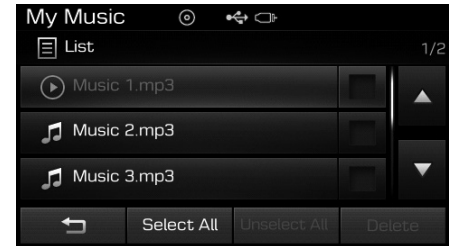

Once you find the desired file, press the **TUNE** knob to start playing.

Rewinding / Fast-forwarding Files

While playing, press and hold the **SEEK TRACK** key to rewind or fast-forward the current file.

Scan

Press the **SCAN** key to play the first 10 seconds of each file.

My Music Mode Menu

Within this mode, you will have access to the Info, Random(Shuffle), Repeat, Delete and List features.

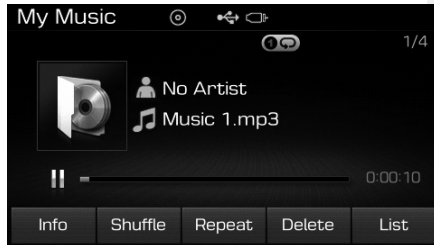

Info

Press the **Info** button to display details about the current file.

i Information

The title, artist and album info are displayed only when such information is recorded within the MP3 file ID3 tag.

Random

Press the **Shuffle** button to play files in random order. Press the button again to turn the Random feature off.

Repeat

Press the **Repeat** button to repeat the current song. Press the button again to turn the repeat feature off.

Deleting Files

Press the **Delete** button to delete the current file.

List

Press the **List** button to display the file list screen.

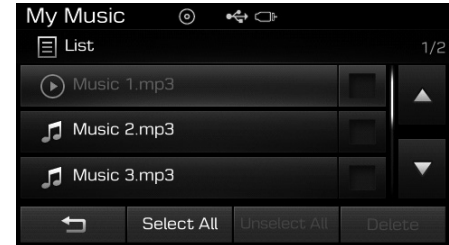

Turn the **TUNE** knob left/right to search for files. Once the desired file is displayed, press the knob to select and play.

List Menu

From the List screen, it is possible to delete files you previously saved into My Music.

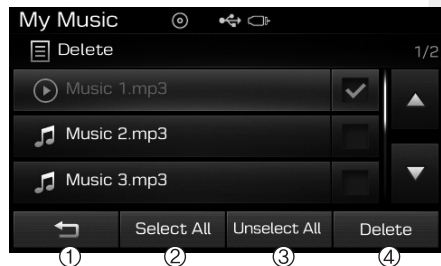

Press the **Select All** button or individually select the files you want to delete. Once files are selected, the **Unselect All** button and **Delete** buttons will be enabled.

- 1) **←** : Moves to the previous screen
- 2) **Select All**: Selects all files
- 3) **Unselect All**: Deselects all selected files
- 4) **Delete**: Deletes selected files

After selecting the files you want to delete, press the **Delete** button to delete the selected files.

i Information

- If there is memory available, up to 6,000 files can be saved.
- Identical files cannot be copied more than 1,000 times.
- To check memory information, go to **SETUP** ▶ [System] ▶ [Memory Information]

i Information - Using the *Bluetooth*[®] wireless technology audio mode

- *Bluetooth*[®] Wireless Technology Audio Mode can be used only when a *Bluetooth*[®] Wireless Technology phone has been connected.
- *Bluetooth*[®] Wireless Technology Audio Mode will not be available when connecting mobile phones that do not support this feature.
- While *Bluetooth*[®] Wireless Technology Audio is playing, if the *Bluetooth*[®] Wireless Technology phone is connected, then the music will also stop.
- Moving the Track up/down while playing *Bluetooth*[®] Wireless Technology audio mode may result in pop noises in some mobile phones.
- *Bluetooth*[®] Wireless Technology streaming audio may not be supported in some mobile phones.

(Continued)

(Continued)

- When returning to *Bluetooth*[®] Wireless Technology Audio mode after ending a call, the mode may not automatically restart in some mobile phones.
- Receiving an incoming call or making an outgoing call while playing *Bluetooth*[®] Wireless Technology Audio may result in audio interference.



Bluetooth[®] Wireless Technology AUDIO MODE (if equipped)

Using *Bluetooth*[®] Wireless Technology Audio Mode

Playing/Pausing Bluetooth[®] Wireless Technology Audio

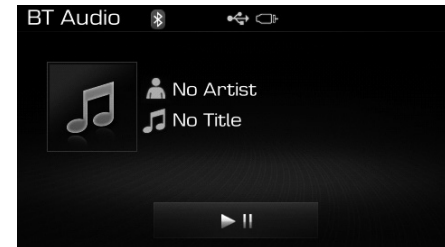
Once a *Bluetooth*[®] Wireless Technology device is connected, the mode will automatically start.



While playing, press the  button to pause and press  button to play.

i Information

The play/pause feature may operate differently depending on the mobile phone.

Changing Files

Press the  key to move to the previous or next file.

Setting Connection

If a *Bluetooth*[®] Wireless Technology device has not been connected, press the **SETUP** key ▶[Phone] button to display the *Bluetooth*[®] Wireless Technology connection screen.

It is possible to use the pair phone, connect/disconnect and delete features from your *Bluetooth*[®] Wireless Technology phone.

i Information

- If the *Bluetooth*[®] Wireless Technology audio is not operating properly, check whether the feature is turned off at **SETUP** ▶[Phone]▶[Streaming Audio]. If the feature is off, turn back on and try again.
- If music is not yet playing from your mobile device after converting to *Bluetooth*[®] Wireless Technology Audio mode, pressing the play button once may start playing the mode. Check to see that music is playing from the *Bluetooth*[®] Wireless Technology device after converting to *Bluetooth*[®] Wireless Technology Audio Mode.

i Information - Pairing through [PHONE] Setup

- The *Bluetooth*[®] and Voice Recognition Manual is provided in two versions due to software version differences.
- Before reading the manual, check the following.
- Press the **SETUP** key ▶Select [Phone]▶Select [Pair Phone]

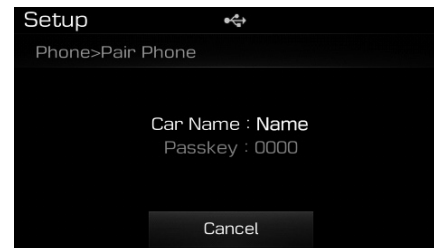

- From your *Bluetooth*[®] Wireless Technology device (i.e. Mobile Phone), search and select your car audio system.

Pairing a *Bluetooth*[®] Wireless Technology Device

What is *Bluetooth*[®] Wireless Technology Pairing?

Pairing refers to the process of synchronizing your *Bluetooth*[®] Wireless Technology phone or device with the car audio system for connection. Pairing is necessary to connect and use the *Bluetooth*[®] Wireless Technology feature.

Pairing **PHONE** Key / Key on the Steering Remote Controller

When No Devices have been Paired

1. Press the **PHONE** key or the  key on the steering remote controller. The following screen is displayed.
2. Press the **OK** button to enter the Pair Phone screen.

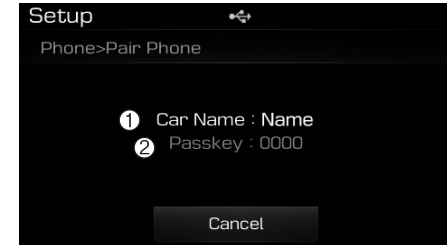
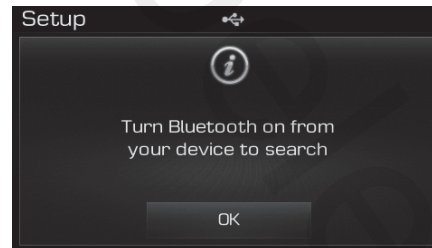

- 1) Car Name : Name of device as shown when searching from your *Bluetooth*[®] Wireless Technology device
- 2) Passkey : Passkey used to pair the device
3. From your *Bluetooth*[®] Wireless Technology device (i.e. Mobile Phone), search and select your car audio system.
4. After a few moments, a screen is displayed 6 digits passkey. Hear, check the passkey on your *Bluetooth*[®] Wireless Technology device and confirm.

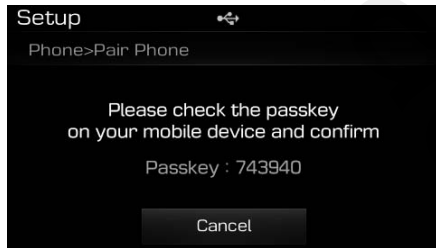

5. Once pairing is complete, the following screen is displayed.

NOTICE



If **Bluetooth®** Wireless Technology devices are paired but none are currently connected, pressing the **[PHONE]** key or the **[↶]** key on the steering wheel displays the following screen. Press the **[Pair]** button to pair a new device or press the **[Connect]** to connect a previously paired device.

Pairing through [PHONE] Setup

Press the **[SETUP]** key ▶ Select **[Phone]** ▶ Select **[Pair Phone]**

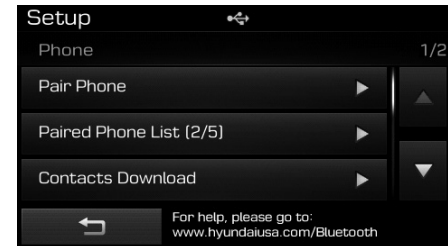

(※ the screen can be different by region.)

The following steps are the same as those described in the section "When No Devices have been Paired" on the previous page.

i Information

- **Bluetooth®** Wireless Technology features supported within the vehicle are as follows. Some features may not be supported depending on your **Bluetooth®** Wireless Technology device.
 - Outgoing/Incoming Handsfree calls
 - Operations during a call (Switch to Private, Switch to call waiting, MIC on/off)
 - Downloading Call History
 - Downloading Mobile Contacts
 - **Bluetooth®** Wireless Technology device auto connection
 - Bluetooth Audio Streaming
- Up to five **Bluetooth®** Wireless Technology devices can be paired to the Car Handsfree system.
- Only one **Bluetooth®** Wireless Technology device can be connected at a time.
- Other devices cannot be paired while a **Bluetooth®** Wireless Technology device is connected.

(Continued)

(Continued)

- Only **Bluetooth®** Wireless Technology Handsfree and Bluetooth audio related features are supported.
- Bluetooth related operations are possible only within devices that support Handsfree or audio features, such as a **Bluetooth®** Wireless Technology mobile phone or a Bluetooth audio device.
- If a connected **Bluetooth®** Wireless Technology device becomes disconnected due to being out of communication range, turning the device OFF, or a **Bluetooth®** Wireless Technology communication error, corresponding **Bluetooth®** Wireless Technology devices are automatically searched and reconnected.
- If the system becomes unstable due to communication errors between the car Handsfree and the **Bluetooth®** Wireless Technology device, reset the device by turning off and back on again. Upon resetting **Bluetooth®** Wireless Technology device, the system will be restored.

(Continued)

(Continued)

- After pairing is complete, a contacts download request is sent once to the mobile phone. Some mobile phones may require confirmation upon receiving a download request, ensure your mobile phone accepts the connection. Refer to your phones user's manual for additional information regarding phone pairing and connections.

Connecting a Device

Press the **SETUP** key ▶ Select [Phone] ▶ Select [Paired Phone List]

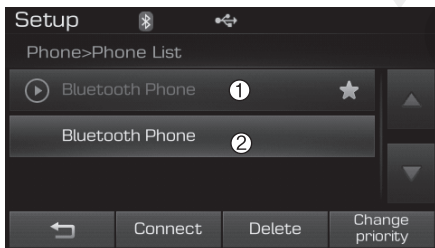

- 1) Connected Phone : Device that is currently connected
- 2) Paired Phone : Device that is paired but not connected

From the paired phone list, select the device you want to connect and press the **Connect** button.

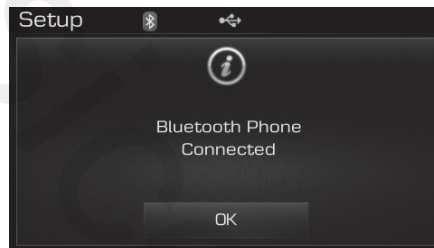

Changing Priority

What is Priority?

It is possible to pair up to five *Bluetooth*® Wireless Technology devices with the car audio system. The "Change Priority" feature is used to set the connection priority of paired phones.

Press the **SETUP** key ▶ Select [Phone] ▶ Select [Paired Phone List]



From the paired phone list, select the phone you want to switch to the highest priority, then press the **Change priority** button from the Menu. The selected device will be changed to the highest priority.

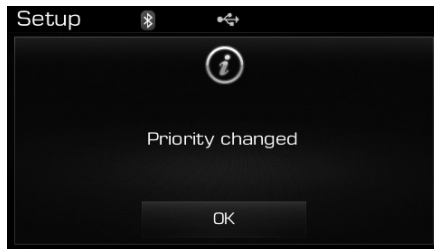

NOTICE

Priority icon will be displayed when the selected phone is set as a priority phone.



Disconnecting a Device

Press the **SETUP** key ▶ Select [Phone] ▶ Select [Paired Phone List]

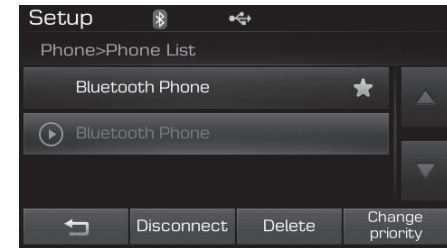

From the paired phone list, select the currently connected device and press the **Disconnect** button.

Deleting a Device

Press the **SETUP** key ▶ Select [Phone] ▶ Select [Paired Phone List]

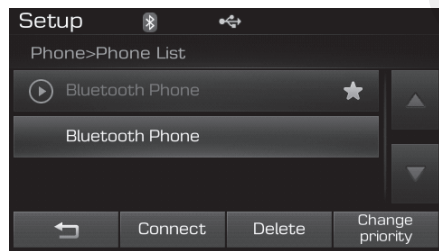

From the paired phone list, select the device you want to delete and press the **Delete** button.

i Information

- When deleting the currently connected device, the device will automatically be disconnected to proceed with the deleting process.
- If a paired *Bluetooth*® Wireless Technology device is deleted, the device's call history and contacts data will also be deleted.
- To re-use a deleted device, you must pair the device again.

Phone Menu Screen

Phone Menus

With a *Bluetooth*® Wireless Technology device connected, press the **PHONE** key to display the Phone menu screen.

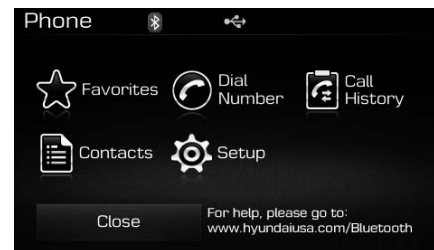

(※ the screen can be different by region.)

- 1) Favorite : Up to 20 frequently used contacts saved for easy access
- 2) Dial Number : Displays the dial screen where numbers can be dialed to make calls
- 3) Call History : Device the call history list screen

- 4) Contacts : Displays the Contacts list screen
- 5) Setup : Displays Phone related settings

i Information

- If you press the [Call History] button but there is no call history data, a prompt is displayed which asks to download call history data.
- If you press the [Contacts] button but there is no contacts data stored, a prompt is displayed which asks to download contacts data.
- This feature may not be supported in some mobile phones. For more information on download support, refer to your mobile phone user's manual.

Favorites

Press the **PHONE** key ▶ Select [Favorites]

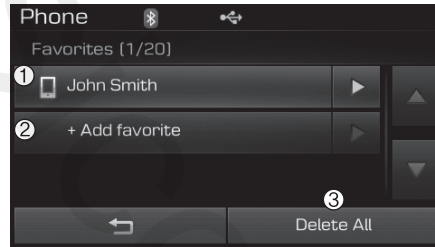

- 1) Saved favorite contact : Connects call upon selection
- 2) To add favorite : Downloaded contacts be saved as favorite.
- 3) Delete All : Delete all stored favorite contacts

i Information

- To save Favorite, contacts should be downloaded.
- Contact saved in Favorites will not be automatically updated if the contact has been updated in the phone. To update Favorites, delete the Favorite and create a new Favorite.

Calling by Dialing a Number

Press the **PHONE** key ▶ Select [Dial Number]

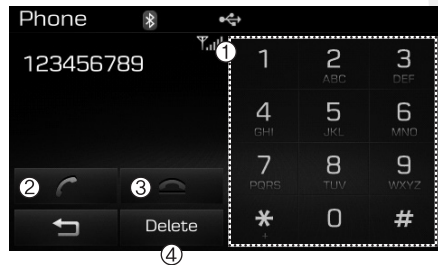

- 1) Dial Pad : Used to enter phone number
- 2) Call : If a number has been entered, calls the number. If no number has been entered, switches to call history screen
- 3) End : Deletes the entered phone number
- 4) Delete : Deletes entered numbers one digit at a time

Answering Calls

Answering a Call

Answering a call with a *Bluetooth®* Wireless Technology device connected will display the following screen.

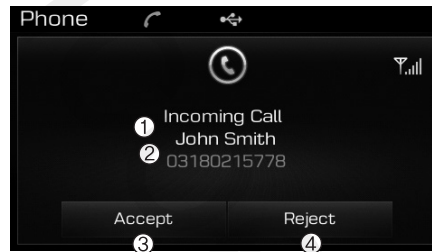

- 1) Caller : Displays the other party's name when the incoming caller is saved within your contacts
- 2) Incoming Number : Displays the incoming number
- 3) Accept : Accept the incoming call
- 4) Reject : Reject the incoming call

i Information

- When an incoming call pop-up is displayed, most Audio and SETUP mode features are disabled. Only the call volume will operate.
- The telephone number may not be properly displayed in some mobile phones.
- When a call is answered with the mobile phone, the call mode will automatically revert to Private mode.

During a Handsfree Call



- 1) Caller : Displays the other party's name if the incoming caller is saved within your contacts
- 2) Incoming Number : Displays the incoming number
- 3) Call time : Displays the call time
- 4) End : Ends call
- 5) Private : Converts to Private mode
- 6) Out Vol. : Sets call volume as heard by the other party
- 7) Mute : Turns Mic Mute On/Off

i Information

If the mic is muted, the other party will not be able to hear your voice.

Call History

Press the **PHONE** key ▶ Select [Call History]

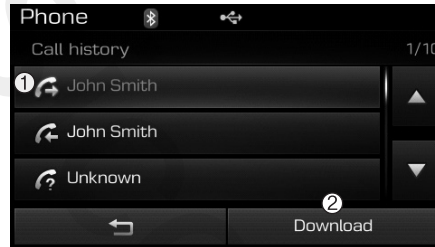

A list of incoming, outgoing and missed calls is displayed.

Press the **Download** button to download the call history.

- 1) Call History :
 - Displays recent calls (call history)
 - Connects call upon selection
- 2) Download : Download Recent Call History

- Call history may not be saved in the call history list in some mobile phones.

- Calls received with hidden caller ID will not be saved in the call history list.
- Calling through the call history is not possible when there is no call history stored or a *Bluetooth*® Wireless Technology phone is not connected.
- Up to 50 received, dialed and missed calls are stored in Call History.
- Time of received/dialed calls and call time information are not saved.

Contacts

Press the **PHONE** key ▶ Select [Contacts]

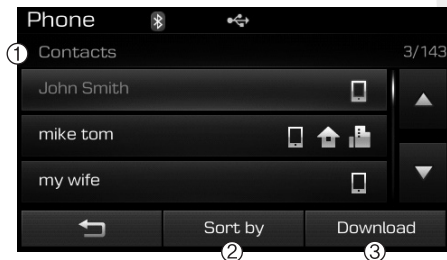

The list of saved phone book entries is displayed. Press the **Download** button to download the call history.

- 1) Contacts List :
 - Displays downloaded contacts entries
 - Connects call upon selection
- 2) Sort by : Find a contact in an alphabetical order.
- 3) Download : Download contacts entries

i Information

- Up to 1,000 contacts saved in your *Bluetooth*® Wireless Technology phone can be downloaded into the car contacts. Contacts that have been downloaded to the car cannot be edited or deleted on the phone.
- Mobile phone contacts are managed separately for each paired *Bluetooth*® Wireless Technology device (max 5 devices x 1,000 contacts each). Previously downloaded data is maintained even if the *Bluetooth*® Wireless Technology device has been disconnected.

(However, the contacts and call history saved to the phone will be deleted if a paired phone is deleted.)

- It is possible to download contacts during Bluetooth streaming audio.
- When downloading contacts, the icon will be displayed within the status bar.

(Continued)

(Continued)

- It is not possible to begin downloading a contact list when the contact download feature has been turned off within the *Bluetooth*® Wireless Technology device. In addition, some devices may require device authorization upon attempting to download contacts. If downloading does not normally occur, check the *Bluetooth*® Wireless Technology device settings or the screen state.
- The contacts download feature may not be supported in some mobile phones. For more information of supported *Bluetooth*® devices and function support, refer to your phone's user manual.

Bluetooth® Wireless Technology Setting

Pairing a New Device

Press the **SETUP** key ▶ Select [Phone] ▶ Select [Pair Phone]

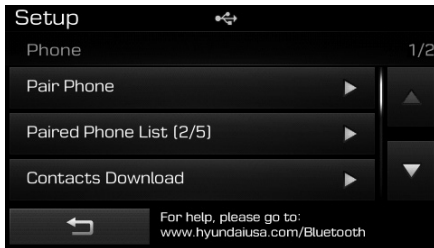

(* the screen can be different by region.)

Bluetooth® Wireless Technology devices can be paired with the audio system.

For more information, refer to the "Pairing through Phone Setup" section within *Bluetooth®* Wireless Technology.

Viewing Paired Phone List

Press the **SETUP** key ▶ Select [Phone] ▶ Select [Paired Phone List]

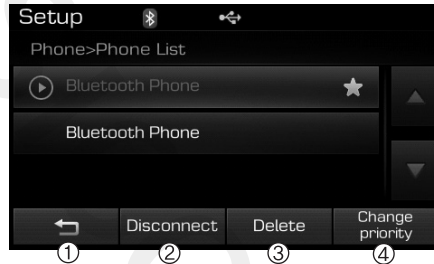

This feature is used to view mobile phones that have been paired with the audio system. Upon selecting a paired phone, the setup menu is displayed.

For more information, refer to the "Setting *Bluetooth®* Wireless Technology Connection" section within *Bluetooth®* Wireless Technology.

- 1) : Moves to the previous screen
- 2) Connect/Disconnect Phone : Connect/ disconnects currently selected phone
- 3) Delete : Deletes the currently selected phone
- 4) Change Priority : Sets currently selected phone to highest connection priority

i Information - Before downloading contacts

- Only contacts within connected phones can be downloaded. Also check to see that your mobile phone supports the download feature.
- To learn more about whether your mobile phone supports contacts downloads, refer to your mobile phone user's manual.
- The contacts for only the connected phone can be downloaded.

Downloading Contacts

Press the **SETUP** key ▶ Select [Phone] ▶ Select [Contacts Download]

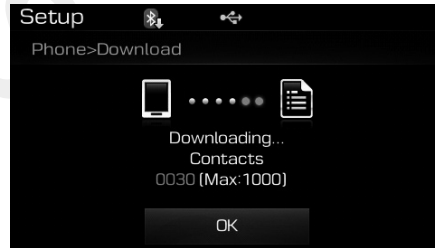

As the contacts are downloaded from the mobile phone, a download progress bar is displayed.

i Information

- Upon downloading phone contacts, the previous corresponding data is deleted.
- This feature may not be supported in some mobile phones.
- Voice Recognition may not operate while contacts are being downloaded.

Outgoing Volume

Press the **SETUP** key ▶ Select [Phone] ▶ Select [Outgoing Volume]



Use the **-**, **+** buttons to adjust the outgoing volume level.

NOTICE

While on a call, the volume can be changed by using the **SEEK TRACK** key.

Turning Bluetooth System Off

Press the **SETUP** key ▶ Select [Phone] ▶ Select [Bluetooth System Off]

Once *Bluetooth*® Wireless Technology is turned off, *Bluetooth*® Wireless Technology related features will not be supported within the audio system.

NOTICE

To turn *Bluetooth*® Wireless Technology back on, go to **SETUP** ▶ [Phone] and press “Yes

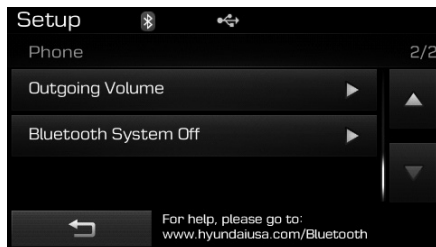

VOICE RECOGNITION

Using Voice Recognition

Starting Voice Recognition

Shortly press the  key on the steering wheel remote controller. Say a command.

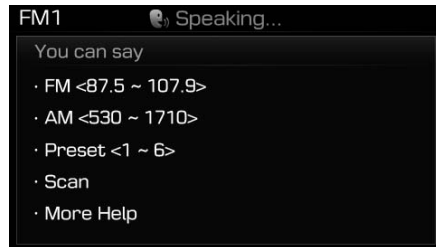

If prompt feedback is in [ON], then the system will say “Please say a command after the beep (BEEP)”

- If prompt feedback is in [OFF] mode, then the system will only say “(BEEP)”
- To change Prompt Feedback [On]/[Off], go to **SETUP** ▶ [System] ▶ [Prompt Feedback]

NOTICE

For proper recognition, say the command after the voice instruction and beep tone.

Contact List Best Practices

- 1) Do not store single-name entries (e.g., “Bob”, “Mom”, “Kim”, etc.). Instead, always use full names (including first and last names) for all contacts (e.g., use “Jacob Stevenson” instead of “Dad”).
- 2) Do not use abbreviations (i.e., use “Lieutenant” instead of “Lt.” or “Sergeant” instead of “Sgt.”).
- 3) Do not use acronyms (i.e., use “County Finance Department” instead of “CFD”).
- 4) Do not use special characters (e.g., “@”, “hyphen -”, “asterisk *”, “ampersand &”).
- 5) If a name is not recognized from the contact list, change it to a more descriptive name (e.g., use “Grandpa Joseph” instead of “Pa Joe”).

Skipping Prompt Messages

While prompt message is being stated ▶ Shortly press the  key on the steering remote controller

The prompt message is immediately ended and the beep tone will sound. After the “beep”, say the voice command.

Re-starting Voice Recognition

While system waits for a command ▶ Shortly press the  key on the steering remote controller

The command wait state is immediately ended and the beep tone will sound. After the “beep”, say the voice command.

* Illustration on using voice commands

• **Starting voice command.**

Shortly pressing the  key (under 0.8 seconds):

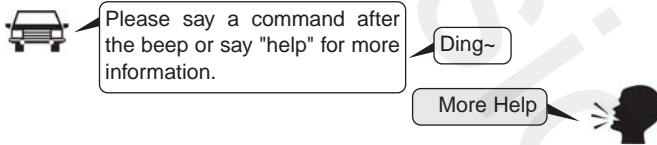



More Help
 Here are some examples of mode commands. You can say a radio type like 'FM', 'AM', or 'Satellite'. You can also say a media source like 'USB', 'My Music', or 'iPod'. Additionally, there are phone commands like 'Contacts', 'Call History', or 'Dial Number'. You can find more detailed commands in the user's manual. Please say a command after the beep.

More Help
 Here are some examples of mode commands. You can say a radio type like 'FM', 'AM', or 'Satellite'. You can also say a media source like 'USB', 'My Music', or 'iPod'. Additionally, there are phone commands like 'Contacts', 'Call History', or 'Dial Number'. You can find more detailed commands in the user's manual. Please say a command after the beep.

• **Skipping Voice Recognition**

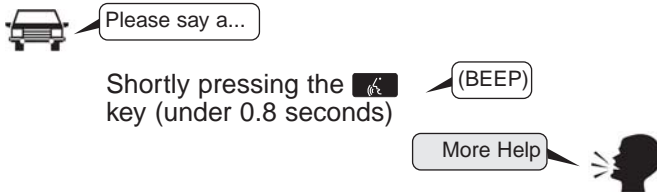
Shortly pressing the  key (under 0.8 seconds):



Shortly pressing the  key (under 0.8 seconds)

• **End voice command.**

Shortly pressing the  key (under 0.8 seconds):

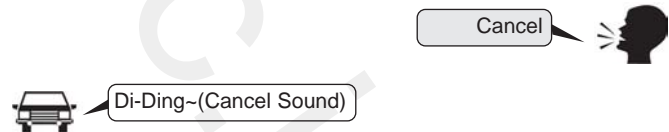
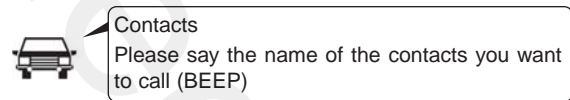
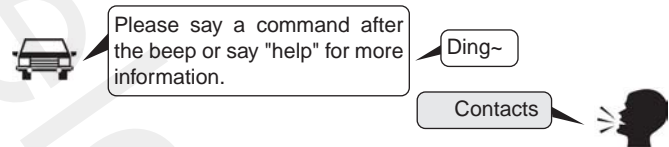

Voice Command List

- Common Commands: These commands can be used in most operations. (However a few commands may not be available during certain operations)

Command	Function
More Help	Provides guidance on commands that can be used anywhere in the system.
Help	Provides guidance on commands that can be used within the current mode.
Call<Name>	Calls <Name> saved in Contacts Ex) Call "John Smith"
Call <Name> on Mobile	Calls <Name> to the number that is saved as "Mobile" in Contacts Ex) Call "John Smith" on Mobile
Call <Name> in Office	Calls <Name> to the number that is saved as "Office" in Contacts Ex) Call "John Smith" in Office
Call <Name> at Home	Calls <Name> to the number that is saved as "Home" in Contacts Ex) Call "John Smith" at Home
Call <Name> on Other	Calls <Name> to the number that is saved as "Other" in Contacts Ex) Call "John Smith" on Other
Phone	Provides guidance on Phone related commands. After saying this command, say "Favorites", "Dial Number", "Call History" or "Contacts" execute corresponding functions.
Favorites	Displays the Favorite screen.
Call History	Displays the Call History screen.

Command	Function
Contacts (Call by Name)	Displays the Contacts screen. After saying this command, say the name of a contact saved in the Contacts to automatically connect the call.
Dial Number	Display the Dial number screen. After saying this command, you can say the number that you want to call.
Redial	Connects the most recently called number.
Tutorial	Provide guidance on how to use voice recognition and Bluetooth® connections.
Radio	<ul style="list-style-type: none"> • When listening to the radio, displays the next radio screen. (FM1→FM2→AM→XM1→XM2→XM3→FM1) • When listening to a different mode, displays the most recently played radio screen. • When currently listening to the FM radio, maintains the current state. • When listening to a different mode, displays the most recently played FM screen.
FM1(FM One)	Displays the FM1 screen.
FM2(FM Two)	Displays the FM2 screen.
AM	Displays the AM screen.

Command	Function
FM Preset 1~6	Plays the most recently played broadcast saved in FM Preset 1~6.
AM Preset 1~6	Plays the broadcast saved in AM Preset 1~6.
FM 87.5~107.9	Plays the FM broadcast of the corresponding frequency.
AM 530~1701	Plays the AM broadcast of the corresponding frequency.
XM™ (Satellite) 0~255	<ul style="list-style-type: none"> • When currently listening to the SiriusXM™, maintains the current state. • When listening to a different mode, displays the most recently played SiriusXM™ screen.
XM™(Satellite) 1~3	Displays the selected SiriusXM™ screen.
XM™ Channel	Plays the selected SiriusXM™ channel.
Media	Moves to the most recently played media screen.
CD	Plays the music saved in the CD.
USB	Plays USB music.
iPod®	Plays iPod music.
My Music	Plays the music saved in My Music.

Command	Function
AUX (Auxiliary)	Plays the connected external device.
Bluetooth® Audio	Plays the music saved in connected Bluetooth® device.
Please repeat	Repeats the most recent comment.
Mute	Mutes the sound
Cancel (Exit)	Ends voice command.

- FM/AM radio commands: available during FM, AM radio operation

Command	Function
Preset 1~6	Plays the broadcast saved in Preset 1~6.
Scan	Scans receivable frequencies from the current broadcast and plays for 10 seconds each.
Preset Scan	Moves to the next preset from the current present and plays for 10 seconds each.
Information	Displays the information of the current broadcast.(This feature can be used when receiving RBDS broadcasts.)

- Satellite radio commands: Commands that can be used while listening to Satellite Radio.

Command	Function
Channel 0~255	Play the selected Satellite Radio channel.
Scan	Scans receivable channels from the current broadcast and plays for 10 seconds each.
Preset 1~6	Plays the broadcast saved in Preset 1~6.
Information	Displays the information of the current broadcast.

- Audio CD commands: Commands available during Audio CD operation

Command	Function
Play	Plays the currently paused track.
Pause	Pauses the current track.
Shuffle	Randomly plays the tracks within the CD.
Shuffle Off	Cancels random play to play tracks in sequential order.
Repeat	Repeats the current track.
Repeat Off	Cancels repeat play to play tracks in sequential order.
Track 1~30	Plays the desired track number.

- MP3 CD / USB commands: Commands available during USB and MP3 CD operation

Command	Function
Play	Plays the currently paused file.
Pause	Pauses the current file.
Shuffle	Randomly plays the files within the current folder.
Shuffle Off	Cancels random play to play files in sequential order.
Repeat	Repeats the current file.
Repeat Off	Cancels repeat play to play files in sequential order.
Next Folder	Play the first file in the next folder
Previous Folder	Play the first file in the previous folder

- iPod® Commands: Commands available during iPod® operation

Command	Function
Play	Plays the currently paused song.
Pause	Pauses the current song.
Shuffle	Randomly plays the songs within the current category.
Shuffle Off	Cancels random play to play songs in sequential order.
Repeat	Repeats the current song.
Repeat Off	Cancels repeat play to play songs in sequential order.

- My Music Commands: Commands available during My Music operation

Command	Function
Play	Plays the currently paused file.
Pause	Pauses the current file.
Shuffle	Randomly plays all saved files.
Shuffle Off	Cancels random play to play files in sequential order.
Repeat	Repeats the current file.
Repeat Off	Cancels repeat play to play files in sequential order.
Delete	Deletes the current file. You will bypass an additional confirmation process.

i Information

SiriusXM™ service requires a subscription, sold separately, after 3-month trial included with vehicle purchase. If you decide to continue your SiriusXM™ service at the end of your trial subscription, the plan you choose will automatically renew and bill at then-current rates until you call us at 1-866-635-2349 to cancel. See our Customer Agreement for complete terms at www.siriusxm.com. Other fees and taxes apply. All fees and programming are subject to change. Sirius satellite service is available only to those at least 18 and older in the 48 contiguous USA, D.C., and PR (with coverage limitations). Our Internet radio service is available throughout our satellite service area and in AK and HI. Certain channels are not available on our Internet radio service or on mobile devices. SiriusXM™ Traffic available in select markets. See siriusxm.com/traffic for more information. © 2013 Sirius XM™ Radio Inc. Sirius, XM™ and all related marks and logos are trademarks of Sirius XM™ Radio Inc.

(Continued)

(Continued)

iPod® is a registered trademark of Apple Inc.

iPod® mobile digital device sold separately. The *Bluetooth*® word mark and logos are registered trademarks owned by Bluetooth SIG, Inc. and any use of such marks by Hyundai is under license. A *Bluetooth*® enabled cell phone is required to use *Bluetooth*® wireless technology. All rights reserved.

SETUP

Starting Mode

Press the **SETUP** key to display the Setup screen.

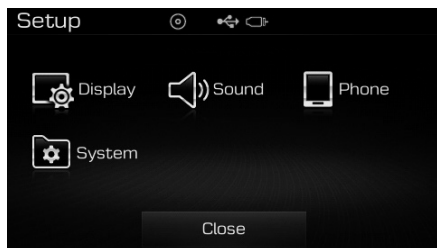

You can select and control options related to [Display], [Sound], [Phone] and [System].

Display Settings

Adjusting the Brightness

Press the **SETUP** key ▶ Select [Display] ▶ Select [Brightness]

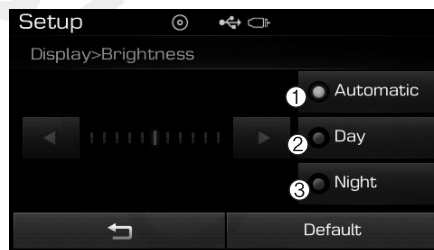

Use the ◀, ▶ buttons to adjust the screen brightness or set the Brightness on Automatic, Day, or Night mode.

Press the **Default** button to reset.

- 1) Automatic : Adjusts the brightness automatically
- 2) Day : Always maintains the brightness on high
- 3) Night: Always maintains the brightness on low

Mode Pop up

Press the **SETUP** key ▶ Select [Display] ▶ Select [Mode Pop up]

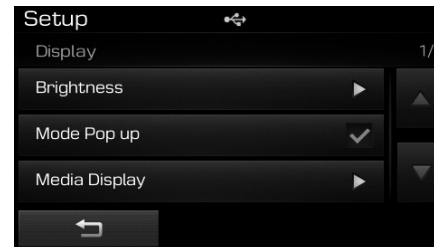

This feature is used to display the Pop-up Mode screen when entering radio and media modes.

When this feature is turned on, pressing the **RADIO** or **MEDIA** key will display the Pop-up Mode screen.

i Information

The media Pop-up Mode screen can be displayed only when two or more media modes have been connected.

MP3 Information Display

Press the **SETUP** key ▶ Select [Display] ▶ Select [Media Display]

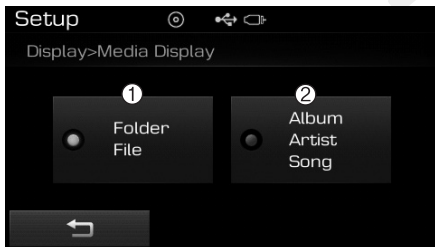

This feature is used to change the information displayed within USB and MP3 CD modes.

- 1) Folder/File : Displays file name and folder name
- 2) Album/Artist/Song : Displays album name/artist name/song

Sound Settings

Sound Settings

Press the **SETUP** key ▶ Select [Sound] ▶ Select [Sound Setting]

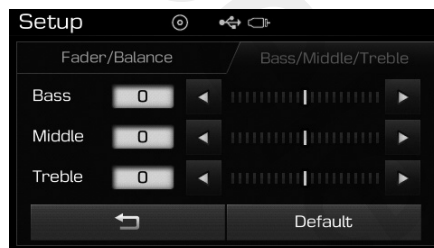
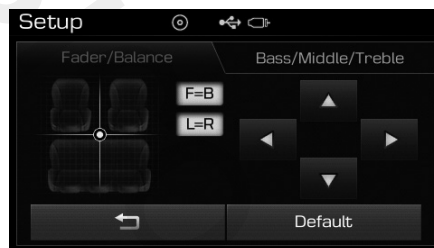

Use the ◀, ▶, ▲, ▼ buttons to adjust the Fader/Balance settings.

Use the ◀, ▶ buttons to adjust the Bass/Middle/Treble settings.

Press the **Default** button to reset.

Variable EQ

This is a premium sound system feature in which the acoustical mode can be selected according to musical preferences.

Select [Variable EQ] ▶ Set menu through  TUNE knob

- Innocente(Normal) : Natural sound, sound optimized for driver.
- Forza(Dynamic) : Powerful sound emphasizing bass, stereo sound.
- Concerto(Concert) : Sound similar to a concert or live hall

* May differ depending on the selected audio.

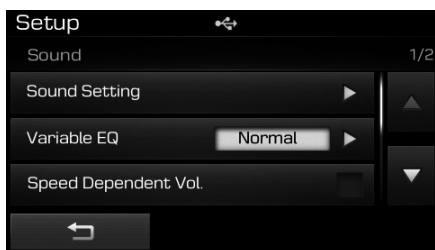

SDVC (Speed Dependent Volume Control)

Press the **SETUP** key ▶ Select [Sound] ▶ Select [Speed Dependent Vol.]

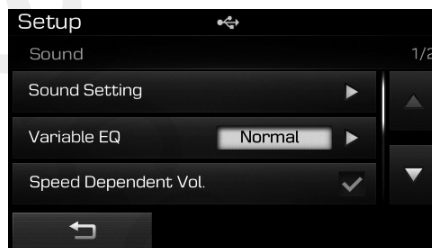

The volume level is controlled automatically according to the vehicle speed. SDVC can be set by selecting from On / Off.

Voice Recognition Volume

Press the **SETUP** key ▶ Select [Sound] ▶ Select [Voice Recognition Vol.]

Turn the  TUNE knob to adjust the Voice Recognition volume.

Touch Screen Beep

Press the **SETUP** key ▶ Select [Sound] ▶ Select [Touch Screen Beep]

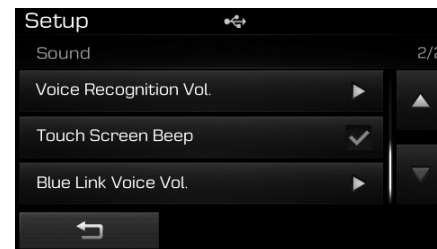

This feature is used to turn the touch screen beep on/off.

Blue Link Voice Volume

Press the **SETUP** key ▶ Select [Sound] ▶ Select [Blue Link Voice Vol.]

Turn the  TUNE knob to adjust the Blue Link Voice Volume.

* Blue Link® may differ depending on the selected audio.

System Setting

Memory Information

Press the **SETUP** key ▶ Select [System] ▶ Select [Memory Information]

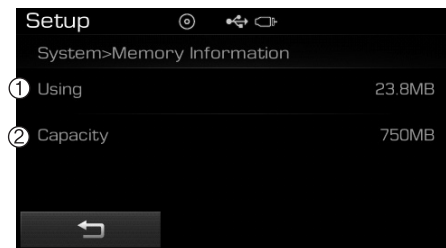

This feature displays information related to system memory.

- 1) Using : Displays capacity currently in use
- 2) Capacity : Displays total capacity

Prompt Feedback

Press the **SETUP** key ▶ Select [System] ▶ Select [Prompt Feedback]

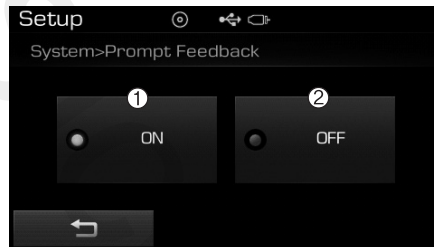

This feature is used to select the desired prompt feedback option from ON and OFF.

- 1) ON : When using voice recognition, provides detailed guidance prompts
- 2) OFF : When using voice recognition, omits some guidance prompts

Language

Press the **SETUP** key ▶ Select [System] ▶ Select [Language]

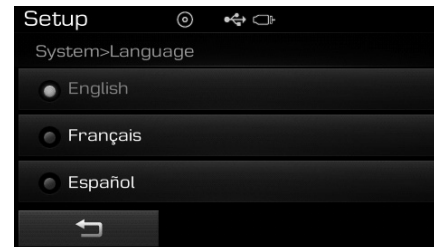

*This feature is used to change the system and voice recognition language.

*if the language is changed, the system will restart and apply the selected language.

REAR VIEW CAMERA (if equipped)

- The system has been equipped with a rear view camera for user safety by allowing a wider rear range of vision.
- The rear view camera will automatically operate when the ignition key is turned ON and the shift lever is set to R (Reverse).
- The rear view camera will automatically stop operating when set to a different lever.



CAUTION

The rear view camera has been equipped with an optical lens to provide a wider range of vision and may appear different from the actual distance. For safety, directly check the rear and left/right sides.

BLUE LINK® (IF EQUIPPED)

Hyundai aims to offer differentiated customer values through a 'Connected Car Life,' which is to provide consumers with fast and reliable IT technology. As consumers' lifestyles become more and more mobile in thanks to remarkable advances in smart phones, tablet PCs and overall wireless telecommunication, new lifestyle patterns demand seamless connection between one's office, home, outdoors and automobiles.

Automobile companies are now faced with the task of shifting their paradigm from vehicle-centered services to customer value-centered services, with the ultimate goal of securing global leadership in the field of vehicle IT and telematics.



Hyundai Motor plans to achieve this by realizing a terminal platform flexible to changes in IT technology, cooperating with global IT companies, creating an eco-system and providing the latest contents & services based on an open environment.

Using the Room Mirror Key

Selecting the room mirror key will allow you to make service required inquiries, POI info searches, and emergency rescues by connecting to the Blue Link® Center.

Such features can be used only after subscribing to the Blue Link® service.

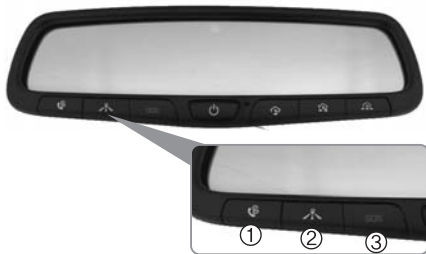

① (Blue Link® Center)

Makes requests for Blue Link® service related inquiries and consultations.

A call is connected to the Blue Link® service center employee.

Re-pressing the key will end the call.

This feature does not operate when you are on a Bluetooth® phone call.

② (Blue Link® for POI)

- Blue Link® for Voice command
Starts Blue Link® voice command.

Voice receiving voice guidance, shortly press the button to convert to voice command mode. Press and hold the button to end voice command.

• TBT VR Commands

1. Navigate to

"Navigate to" voice command is used to request the download of route data for a new destination, saved destinations, daily routes and previous destinations.

2. Save Destination

"Save Destination" VR command is used to assign a voice tag to the last downloaded destination and store it in a destination directory.

Information

The Turn by Turn (TBT) feature supports the store of ten (10) destinations in the TBT destinations directory.

3. Route Preview

"Route Preview" VR command allows the user to preview the route instructions (upcoming maneuver instructions) at any time during the route guidance.

4. Destinations List

"Destinations List" VR command allows the user to preview and delete the stored destinations with their associated voice tags in the Turn by Turn destinations directory.

5. Voice Guidance

"Voice Guidance" VR command allows the user to mute/unmute the Turn by Turn (TBT) direction announcements.

6. Suspend Route

"Suspend Route" VR command allows the user to suspend and pause Turn by Turn(TBT) route guidance while in the guidance mode.

7. Resume Route

"Resume Route" VR command allows the user to resume Turn by Turn(TBT) route guidance.



③ SOS (Blue Link® for SOS)

In the case of an emergency, requests for help to the Blue Link® center.

Call is connected to the Blue Link® emergency rescue center. Re-pressing the key will end the call.

If already on a Bluetooth® phone call, the call will end to connect you to the Blue Link® Emergency Rescue Center.

i Information

- **You cannot talk simultaneously on the Bluetooth® phone and Blue Link® phone.**
- **While on a Bluetooth® call, pressing the  key or  key will display a message indicating that you are currently on a call.**
- **A message will be displayed if you receive a Bluetooth® Wireless Technology call while already on a Blue Link® call. At this time, press the**

Eco Coach



• What is Eco Coach?

Every 2.5 minutes, Eco Coach compares your fuel economy against the government tested average (EPA) or other similar Hyundai models (community), based on your preference. Each month, or after every tank fill up, Eco Coach rates your extended average and gives you a reward star if you best the average.

See your My Hyundai web page for more information.

- What does the bar graph and horizontal line mean?

The horizontal line is adjusted once per month or at each tank full, based on your preference; it represents the EPA combined average or community average fuel economy target.

- What is My Eco MPG?

Your actual fuel economy average over 2.5 minutes.

This value is also shown in bar graph as your “now” rating.

- What are Eco Rewards?

If you beat the average (the EPA or community), you will receive an Eco Reward point.

See your my Hyundai web page for more information.

[Eco Driving] will not operate if the vehicle ignition is not turned on. Please operate with the ignition turned on.

Turn by Turn

The Turn by Turn feature can be used through Blue Link®.

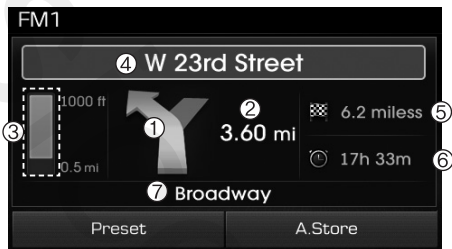

- 1.Direction Indicator Image
- 2.Remaining distance until next point
- 3.The Count bar is divided into a total of 9 levels.

9 Level	0.5mi	8 Level	0.4mi
7 Level	0.3mi	6 Level	0.2mi
5 Level	0.1mi	4 Level	400ft
3 Level	300ft	2 Level	200ft
1 Level	100ft		

- 4.Next Street name
- 5.Distance to destination
- 6.Expected Time Arrival
7. Current Street name

* For information on specific Blue Link® operations, please refer to a separate manual.

DECLARATION OF CONFORMITY

FCC

This equipment has been tested and found to comply with the limits for a Class B digital device, pursuant to part 15 of the FCC Rules. These limits are designed to provide reasonable protection against harmful interference in a residential installation.

This equipment generates, uses and can radiate radio frequency energy and, if not installed and used in accordance with the instructions, may cause harmful interference to radio communications. However, there is no guarantee that interference will not occur in a particular installation. If this equipment does cause harmful interference to radio or television reception, which can be determined by turning the equipment off and on, the user is encouraged to try to correct the interference by one or more of the following measures:

- Reorient or relocate the receiving antenna.
- Increase the separation between the equipment and receiver.
- Connect the equipment into an outlet on a circuit different from that to which the receiver is connected.
- Consult the dealer or an experienced radio/TV technician for help.

Caution: Any changes or modifications to this device not explicitly approved by manufacturer could void your authority to operate this equipment.

This device complies with part 15 of the FCC Rules. Operation is subject to the following two conditions :

(1) This device may not cause harmful interference, and (2) this device must accept any interference received, including interference that may cause undesired operation.

This equipment complies with FCC radiation exposure limits set forth for an uncontrolled environment.

This equipment should be installed and operated with minimum 20cm between the and your body. This transmitter must not be collocated or operating in conjunction with any other antenna or transmitter unless authorized to do so by the FCC.

Driving your vehicle

Before driving	5-4	Drive mode integrated control system	5-41
Before entering the vehicle	5-4	Cruise control	5-43
Before starting.....	5-4	Cruise Control operation	5-43
Engine Start/Stop button	5-5	Smart Cruise Control system	5-48
Illuminated Engine Start/Stop button	5-6	To adjust the sensitivity of Smart Cruise Control ..	5-49
Engine Stop/Start button positions	5-7	To convert to Cruise Control Mode	5-49
Starting the hybrid system	5-9	Smart Cruise Control speed	5-50
Automatic transaxle	5-12	Smart Cruise Control vehicle-to-vehicle distance..	5-54
Automatic transaxle operation	5-12	Radar to detect distance to the vehicle ahead.....	5-57
Parking.....	5-17	Limitations of the system	5-58
Good driving practices.....	5-17	Forward collision warning system (FCWS)	5-63
Braking system	5-19	FCWS operation.....	5-63
Power brakes	5-19	Limitations of the system	5-65
Disc brakes wear indicator	5-20	Lane departure warning system (LDWS)	5-66
Foot parking brake	5-20	LDWS Operation	5-67
Electronic Parking Brake (EPB).....	5-22	Warning Light and Message.....	5-68
AUTO HOLD	5-28	Blind spot detection system (BSD)	5-70
Anti-lock Brake System (ABS)	5-32	BSD (Blind Spot Detection) /	
Electronic Stability Control (ESC).....	5-34	LCA (Lane Change Assist).....	5-71
Vehicle Stability Management.....	5-38	RCTA (Rear Cross Traffic Alert)	5-74
Hill-Start Assist Control (HAC)	5-39		
Good braking practices.....	5-40		

Special driving conditions	5-78
Hazardous driving conditions.....	5-78
Rocking the vehicle.....	5-78
Smooth cornering.....	5-79
Driving at night.....	5-79
Driving in the rain.....	5-80
Driving in flooded areas.....	5-80
Highway driving.....	5-81
Winter driving	5-82
Snow or icy conditions.....	5-82
Winter Precautions.....	5-84
Vehicle load limit	5-87
Tire loading information label.....	5-88
Trailer towing	5-92

WARNING

Carbon monoxide (CO) gas is toxic. Breathing CO can cause unconsciousness and death.

Engine exhaust contains carbon monoxide which cannot be seen or smelled.

Do not inhale engine exhaust.

If at any time you smell engine exhaust inside the vehicle, open the windows immediately. Exposure to CO can cause unconsciousness and death by asphyxiation.

Be sure the exhaust system does not leak.

The exhaust system should be checked whenever the vehicle is raised to change the oil or for any other purpose. If you hear a change in the sound of the exhaust or if you drive over something that strikes the underneath side of the vehicle, have the exhaust system checked as soon as possible by an authorized HYUNDAI dealer.

Do not run the engine in an enclosed area.

Letting the engine idle in your garage, even with the garage door open, is a hazardous practice. Run the engine only long enough to start the engine and to move the vehicle out of the garage.

Avoid idling the engine for prolonged periods with people inside the vehicle.

If it is necessary to idle the engine for a prolonged period with people inside the vehicle, be sure to do so only in an open area with the air intake set at "Fresh" and fan control set to high so fresh air is drawn into the interior.

Keep the air intakes clear.

To assure proper operation of the ventilation system, keep the ventilation air intakes located in front of the windshield clear of snow, ice, leaves, or other obstructions.

If you must drive with the trunk open:

Close all windows.

Open instrument panel air vents.

Set the air intake control at "Fresh", the air flow control at "Floor" or "Face", and the fan control set to high.

 **WARNING**

**CALIFORNIA PROPOSITION 65
WARNING**

Engine exhaust and a wide variety of automobile components including components found in the interior furnishings in a vehicle, contain or emit harmful chemicals known to the State of California to cause cancer and birth defects and reproductive harm. In addition, certain fluids contained in vehicles and certain products of components contain or emit chemicals known to the State of California to cause cancer and birth defects or other reproductive harm.

BEFORE DRIVING

Before entering the vehicle

- Be sure all windows, outside mirror(s), and outside lights are clean and unobstructed.
- Remove frost, snow, or ice.
- Visually check the tires for uneven wear and damage.
- Check under the vehicle for any sign of leaks.
- Be sure there are no obstacles behind you if you intend to back up.

Before starting

- Make sure the hood, the trunk, and the doors are securely closed and locked.
- Adjust the position of the seat and steering wheel.
- Adjust the inside and outside rearview mirrors.
- Verify all the lights work.
- Fasten your seatbelt. Check that all passengers have fastened their seatbelts.

- Check the gauges and indicators in the instrument panel and the messages on the instrument display when the ignition switch is in the ON position.
- Check that any items you are carrying are stored properly or fastened down securely.

 **WARNING**

To reduce the risk of **SERIOUS INJURY** or **DEATH**, take the following precautions:

- **ALWAYS** wear your seat belt. All passengers must be properly belted whenever the vehicle is moving. For more information, refer to “Seat Belts” in chapter 2.
- Always drive defensively. Assume other drivers or pedestrians may be careless and make mistakes.
- Stay focused on the task of driving. Driver distraction can cause accidents.
- Leave plenty of space between you and the vehicle in front of you.

 **WARNING**

NEVER drink or take drugs and drive.

Drinking or taking drugs and driving is dangerous and may result in an accident and **SERIOUS INJURY** or **DEATH**.

Drunk driving is the number one contributor to the highway death toll each year. Even a small amount of alcohol will affect your reflexes, perceptions and judgment. Just one drink can reduce your ability to respond to changing conditions and emergencies and your reaction time gets worse with each additional drink.

Driving while under the influence of drugs is as dangerous or more dangerous than driving under the influence of alcohol.

(Continued)

(Continued)

You are much more likely to have a serious accident if you drink or take drugs and drive. If you are drinking or taking drugs, don't drive. Do not ride with a driver who has been drinking or taking drugs. Choose a designated driver or call a taxi.

ENGINE START/STOP BUTTON

 **WARNING**

To reduce the risk of **SERIOUS INJURY** or **DEATH**, take the following precautions:

- **NEVER** allow children or any person who is unfamiliar with the vehicle to touch the Engine Start/Stop button or related parts. Unexpected and sudden vehicle movement can occur.
- **NEVER** reach through the steering wheel for the Engine Start/Stop button, or any other control, while the vehicle is in motion. The presence of your hand or arm in this area may cause a loss of vehicle control resulting in an accident.

Illuminated Engine Start/Stop button



Whenever the front door is opened, the Engine Start/Stop button will illuminate and will go off 30 seconds after the door is closed.

⚠ WARNING

To turn the hybrid system off in an emergency:



Press and hold the Engine Start/Stop button for more than two seconds OR Rapidly press and release the Engine Start/Stop button three times (within three seconds).



If the vehicle is still moving, you can restart the hybrid system without depressing the brake pedal by pressing the Engine Start/Stop button with the shift lever in the N (Neutral) position.

⚠ WARNING

- **NEVER** press the Engine Start/Stop button while the vehicle is in motion except in an emergency. This will result in the hybrid system turning off and loss of power assist for the steering and brake systems. This may lead to loss of directional control and braking function, which could cause an accident.
- Before leaving the driver's seat, always make sure the shift lever is in the P (Park) position, set the parking brake, press the Engine Start/Stop button to the OFF position, and take the Smart Key with you. Unexpected vehicle movement may occur if these precautions are not followed.

Engine Stop/Start button positions

Button Position	Action	Notice
<p data-bbox="244 298 303 322">OFF</p>  <p>The image shows a circular button with 'OFF', 'ACC', and 'ON' markings around the perimeter. The 'OFF' position is highlighted, and the center of the button displays 'ENGINE START STOP'.</p>	<p data-bbox="414 304 939 386">To turn off the hybrid system, press the Engine Start/Stop button with shift lever in P (Park).</p> <p data-bbox="414 394 939 506">When you press the Engine Start/Stop button without the shift lever in P (Park), the Engine Start/Stop button does not turn to the OFF position, but turns to the ACC position.</p>	
<p data-bbox="244 615 303 639">ACC</p>  <p>The image shows the same circular button, but the 'ACC' position is highlighted in blue. The center of the button displays 'ENGINE START STOP'.</p>	<p data-bbox="414 621 897 703">Press the Engine Start/Stop button when the button is in the OFF position without depressing the brake pedal.</p> <p data-bbox="414 711 811 735">Electrical accessories are usable.</p>	<p data-bbox="956 621 1491 733">If you leave the Engine Start/Stop button in the ACC position for more than one hour, the battery power will turn off automatically to prevent the battery from discharging.</p>

Button Position	Action	Notice
<p style="text-align: center;">ON</p> 	<p>Press the Engine Start/Stop button while it is in the ACC position without depressing the brake pedal.</p> <p>The warning lights can be checked before the hybrid system is started.</p>	<p>Do not leave the Engine Start/Stop button in the ON position when the hybrid system is not running to prevent the battery from discharging.</p>
<p style="text-align: center;">START</p> 	<p>To start the hybrid system, depress the brake pedal and press the Engine Start/Stop button with the shift lever in the P (Park) position.</p>	<p>If you press the Engine Start/Stop button without depressing the brake pedal, the hybrid system does not start and the Engine Start/Stop button changes as follows: OFF → ACC → ON → OFF or ACC</p>

Starting the hybrid system

WARNING

- Always wear appropriate shoes when operating your vehicle. Unsuitable shoes, such as high heels, ski boots, sandals, flip-flops, etc., may interfere with your ability to use the brake and accelerator pedals.
- Do not start the vehicle with the accelerator pedal depressed. The vehicle can move and lead to an accident.

Information

- The hybrid system will start by pressing the Engine Start/Stop button, only when the smart key is in the vehicle.
- Even when the smart key is in the vehicle, and when it is far away from the driver, the hybrid system may not start.
- When the Engine Start/Stop button is in the ACC or ON position, any door is open, the system checks for the smart key. When the smart key is not in the vehicle, the " " indicator will blink and the warning "Key not in vehicle" will come on. When all doors are closed, the chime will also sound for about 5 seconds. Keep the smart key in the vehicle when in the ACC position or if the hybrid system is ON.

1. Always carry the smart key with you.
2. Make sure the parking brake is applied.
3. Make sure the shift lever is in P (Park).
4. Depress the brake pedal.
- 5 Press the Engine Start/Stop button. If the hybrid system starts, the " " indicator will come on.

i Information

- Do not wait for the engine to warm up while the vehicle remains stationary.
Start driving at moderate engine speeds. (Steep accelerating and decelerating should be avoided.)
- Always start the vehicle with your foot on the brake pedal. Do not depress the accelerator while starting the vehicle. Do not race the engine while warming it up.
- If ambient temperature is low, the " " indicator may remain illuminated longer than the normal amount of time.

NOTICE

To prevent damage to the vehicle:

- If the " " indicator turns off while you are in motion, do not attempt to move the shift lever to the P (Park) position.

If traffic and road conditions permit, you may put the shift lever in the N (Neutral) position while the vehicle is still moving and press the Engine Start/Stop button in an attempt to restart the hybrid system.

- Do not push or tow your vehicle to start the hybrid system.

NOTICE

To prevent damage to the vehicle:

Do not press the Engine Start/Stop button for more than 10 seconds except when the stop lamp fuse is blown.

When the stop lamp fuse is blown, you cannot normally start the hybrid system. Replace the fuse with a new one. If you are not able to replace the fuse, you can start the hybrid system by pressing and holding the Engine Start/Stop button for 10 seconds with the Engine Start/Stop button in the ACC position.

For your safety always depress the brake pedal before starting the hybrid system.



OLFH054009L

i Information

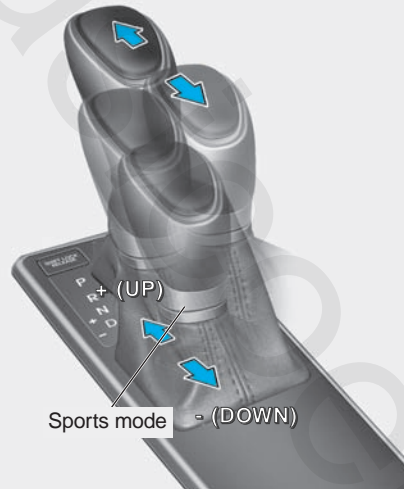
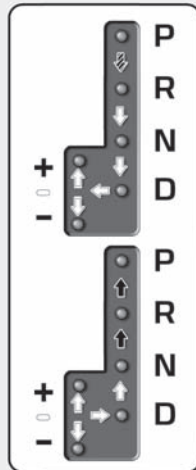

If the smart key battery is weak or the smart key does not work correctly, you can start the hybrid system by pressing the Engine Start/Stop button with the smart key in the direction of the picture above.

AUTOMATIC TRANSAXLE



Automatic transaxle operation

The automatic transaxle has six forward speeds and one reverse speed. The individual speeds are selected automatically in the D (Drive) position.

-  Depress the brake pedal and press the shift button while moving the shift lever.
-  Press the shift button while moving the shift lever.
-  The shift lever can freely operate.

OLF054012

WARNING

To reduce the risk of serious injury or death:

- **ALWAYS** check the surrounding areas near your vehicle for people, especially children, before shifting a vehicle into D (Drive) or R (Reverse).
- Before leaving the driver's seat, always make sure the shift lever is in the P (Park) position, then set the parking brake, and place the Engine Start/Stop button in the OFF position. Unexpected and sudden vehicle movement can occur if these precautions are not followed.
- Do not use the engine brake (shifting from a high gear to lower gear) rapidly on slippery roads. The vehicle may slip causing an accident.
- When using Sport Mode: Do not shift from a high gear to lower gear rapidly on slippery roads. The vehicle may slip causing an accident.

The indicator in the instrument cluster displays the shift lever position when the Engine Start/Stop button is in the ON position.

P (Park)

Always come to a complete stop before shifting into P (Park).

To shift from P (Park), you must depress firmly on the brake pedal and make sure your foot is off the accelerator pedal.

If you have done all of the above and still cannot shift the lever out of P (Park), see "Shift-Lock Release" in this chapter.

The shift lever must be in P (Park) before turning the hybrid system off.

WARNING

- Shifting into P (Park) while the vehicle is in motion may cause you to lose control of the vehicle.
- After the vehicle has stopped, always make sure the shift lever is in P (Park), apply the parking brake, and turn the hybrid system off.
- Do not use the P (Park) position in place of the parking brake.

R (Reverse)

Use this position to drive the vehicle backward.

NOTICE

Always come to a complete stop before shifting into or out of R (Reverse); you may damage the transaxle if you shift into R (Reverse) while the vehicle is in motion.

N (Neutral)

The wheels and transaxle are not engaged. The vehicle will roll freely even on the slightest incline unless the parking brake or service brakes are applied.

D (Drive)

This is the normal driving position. The transaxle will automatically shift through a 6-gear sequence, providing the best fuel economy and power.

For extra power when passing another vehicle or driving uphill, depress the accelerator fully. The transaxle will automatically downshift to the next lower gear (or gears, as appropriate).

The DRIVE MODE switch, located on the shift lever console, allows the driver to switch from NORMAL mode to SPORT or ECO mode.

For more information, refer to "Drive Mode Integrated Control System" later in this chapter.

Sports mode

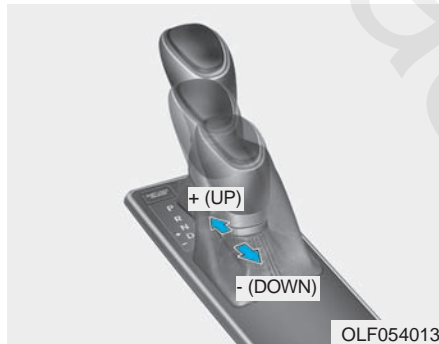

Whether the vehicle is stationary or in motion, sports mode is selected by pushing the shift lever from the D (Drive) position into the manual gate. To return to D (Drive) range operation, push the shift lever back into the main gate.

In Sports Mode, moving the shift lever backwards and forwards will allow you to select the desired range of gears for the current driving conditions.

- + (Up) : Push the lever forward once to shift up one gear.
- (Down) : Pull the lever backwards once to shift down one gear.

i Information

- Only the six forward gears can be selected. To reverse or park the vehicle, move the shift lever to the R (Reverse) or P (Park) position as required.
- Downshifts are made automatically when the vehicle slows down. When the vehicle stops, 1st gear is automatically selected.
- In sports mode, the driver must execute upshifts in accordance with road conditions.

(Continued)

(Continued)

- To maintain the required levels of vehicle performance and safety, the system may not execute certain gearshifts when the shift lever is operated.
- When driving on a slippery road, push the shift lever forward into the + (Up) position. This causes the transaxle to shift into the 2nd gear which is better for smooth driving on a slippery road. Push the shift lever to the - (Down) side to shift back to the 1st gear.
- When accelerating from a stop on a slippery road, push the shift lever forward into the + (Up) position. This causes the transaxle to shift into the 2nd gear which is better for smooth driving on a slippery road. Push the shift lever to the - (Down) side to shift back to the 1st gear.

Shift-lock system

For your safety, the automatic transaxle has a shift-lock system which prevents shifting the transaxle from P (Park) into R (Reverse) unless the brake pedal is depressed. To shift the transaxle from P (Park) into R (Reverse):

1. Depress and hold the brake pedal.
2. Start the hybrid system or place the Engine Start/Stop button in the ON position.
3. Move the shift lever.

Shift-lock release

If the shift lever cannot be moved from the P (Park) position into R (Reverse) position with the brake pedal depressed, continue depressing the brake, and then do the following:

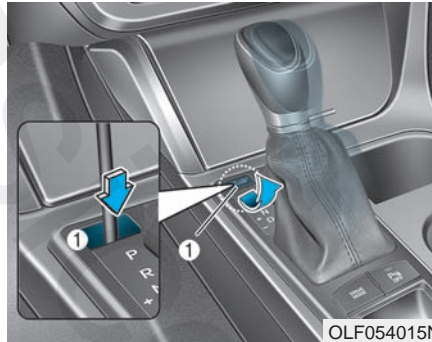

1. Place the Engine Start/Stop button in the OFF position.
2. Apply the parking brake.
3. Carefully remove the cap (1) covering the shift-lock access hole.
4. Insert a tool (e.g. flathead screwdriver) into the access hole and press down on the tool.
5. Move the shift lever while holding down the screwdriver.
6. Remove the tool from the shiftlock override access hole then install the cap.

If you need to use the shift-lock release, have the system inspected by an authorized HYUNDAI dealer immediately.

Parking

Always come to a complete stop and continue to depress the brake pedal. Move the shift lever into the P (Park) position, apply the parking brake, and place the Engine Start/Stop button in the OFF position. Take the Key with you when exiting the vehicle.

WARNING

When you stay in the vehicle with the engine running, be careful not to depress the accelerator pedal for a long period of time. The engine or exhaust system may overheat and start a fire.

The exhaust gas and the exhaust system are very hot. Keep away from the exhaust system components.

Do not stop or park over flammable materials, such as dry grass, paper or leaves. They may ignite and cause a fire.

Good driving practices

- Never move the shift lever from P (Park) or N (Neutral) to any other position with the accelerator pedal depressed.
- Never move the shift lever into P (Park) when the vehicle is in motion.

Be sure the vehicle is completely stopped before you attempt to shift into R (Reverse) or D (Drive).

- Do not move the shift lever to N (Neutral) when driving. Doing so may result in an accident because of a loss of engine braking and the transaxle could be damaged.
- Do not drive with your foot resting on the brake pedal. Even light, but consistent pedal pressure can result in the brakes overheating, brake wear and possibly even brake failure.
- Always apply the parking brake when leaving the vehicle. Do not depend on placing the transaxle in P (Park) to keep the vehicle from moving.

- Exercise extreme caution when driving on a slippery surface. Be especially careful when braking, accelerating or shifting gears. On a slippery surface, an abrupt change in vehicle speed can cause the drive wheels to lose traction and may cause loss of vehicle control resulting in an accident
- Optimum vehicle performance and economy is obtained by smoothly depressing and releasing the accelerator.

 **WARNING**

To reduce the risk of **SERIOUS INJURY** or **DEATH**:

- **ALWAYS** wear your seatbelt. In a collision, an unbelted occupant is significantly more likely to be seriously injured or killed than a properly belted occupant.
- Avoid high speeds when cornering or turning.
- Do not make quick steering wheel movements, such as sharp lane changes or fast, sharp turns.
- The risk of rollover is greatly increased if you lose control of your vehicle at highway speeds.
- Loss of control often occurs if two or more wheels drop off the roadway and the driver over steers to reenter the roadway.

(Continued)

(Continued)

- In the event your vehicle leaves the roadway, do not steer sharply. Instead, slow down before pulling back into the travel lanes.
- **HYUNDAI** recommends you follow all posted speed limits.

 **Information - Kickdown Mechanism**

Use the kickdown mechanism on the accelerator pedal for maximum acceleration. Depress the accelerator pedal beyond the detent and the automatic transaxle will shift to a lower gear depending on the engine speed.

BRAKING SYSTEM

Power brakes

Your vehicle has power-assisted brakes that adjust automatically through normal usage.

If the hybrid system is not on or is turned off while driving, the power assist for the brakes will not work. You can still stop your vehicle by applying greater force to the brake pedal than typical. The stopping distance, however, will be longer than with power brakes.

When the hybrid system is not on, the reserve brake power is partially depleted each time the brake pedal is applied. Do not pump the brake pedal when the power assist has been interrupted.

Pump the brake pedal only when necessary to maintain steering control on slippery surfaces.

WARNING

Take the following precautions:

- **Do not drive with your foot resting on the brake pedal. This will create abnormal high brake temperatures, excessive brake lining and pad wear, and increased stopping distances.**
- **When descending a long or steep hill, shift to a lower gear and avoid continuous application of the brakes. Applying the brakes continuously will cause the brakes to overheat and could result in a temporary loss of braking performance.**

(Continued)

(Continued)

- **Wet brakes may impair the vehicle's ability to safely slow down; the vehicle may also pull to one side when the brakes are applied. Applying the brakes lightly will indicate whether they have been affected in this way. Always test your brakes in this fashion after driving through deep water. To dry the brakes, lightly tap the brake pedal to heat up the brakes while maintaining a safe forward speed until brake performance returns to normal. Avoid driving at high speeds until the brakes function correctly.**

NOTICE

Do not depress the brake pedal continuously without the "" indicator ON. The battery may be discharged.

Disc brakes wear indicator

When your brake pads are worn out and new pads are required, you will hear a high pitched warning sound from your front or rear brakes. You may hear this sound come and go or it may occur whenever you depress the brake pedal.

Please remember some driving conditions or climates may cause a brake squeal when you first apply (or lightly apply) the brakes. This is normal and does not indicate a problem with your brakes.

NOTICE

To avoid costly brake repairs, do not continue to drive with worn brake pads.

i Information

Always replace brake pads as complete front or rear axle sets.

Foot parking brake (if equipped)

Applying the parking brake

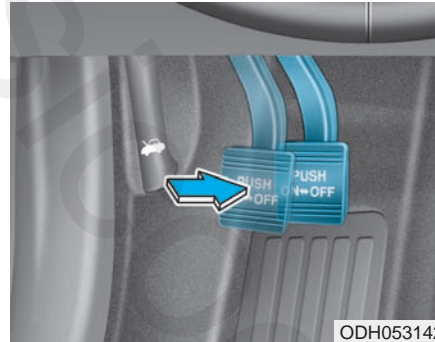

To engage the parking brake, first apply the foot brake and then depress the parking brake pedal down as far as possible.

! WARNING

To reduce the risk of SERIOUS INJURY or DEATH, do not operate the parking brake while the vehicle is moving except in an emergency situation. It could damage the brake system and lead to an accident.

Releasing the parking brake

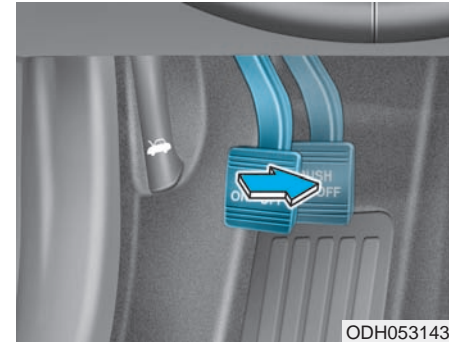

To release:

Firmly depress the brake pedal.

Depress the parking brake pedal down and it will release automatically.

If the parking brake does not release or does not release all the way, have the system checked by an authorized HYUNDAI dealer.

WARNING

- Whenever leaving the vehicle or parking, always come to a complete stop and continue to depress the brake pedal. Move the shift lever into the P (Park) position, then apply the parking brake, and place the Engine Start/Stop button in the OFF position.

Vehicles with the parking brake not fully engaged are at risk for moving inadvertently and causing injury to yourself or others.

- NEVER allow anyone who is unfamiliar with the vehicle to touch the parking brake. If the parking brake is released unintentionally, serious injury may occur.
- Only release the parking brake when you are seated inside the vehicle with your foot firmly on the brake pedal.

NOTICE

- Do not apply the accelerator pedal while the parking brake is engaged. If you depress the accelerator pedal with the parking brake engaged, warning will sound. Damage to the parking brake may occur.
- Driving with the parking brake on can overheat the braking system and cause premature wear or damage to brake parts. Make sure the parking brake is released and the Brake Warning Light is off before driving.



Check the Parking Brake Warning Light by placing the Engine Start/Stop button to the ON position (do not start the hybrid system).

This light will be illuminated when the parking brake is applied with the Engine Start/Stop button in the START or ON position.

Before driving, be sure the parking brake is released and the Brake Warning Light is OFF.

If the Parking Brake Warning Light remains on after the parking brake is released while hybrid system is ON, there may be a malfunction in the brake system. Immediate attention is necessary.

If at all possible, cease driving the vehicle immediately. If that is not possible, use extreme caution while operating the vehicle and only continue to drive the vehicle until you can reach a safe location.

Electronic Parking Brake (EPB) (if equipped)

Applying the parking brake

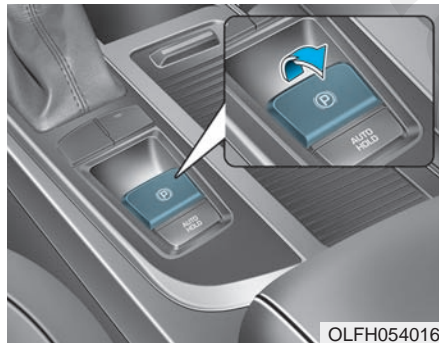

To apply the EPB (Electronic Parking Brake):

1. Depress the brake pedal.
2. Pull upwards on the EPB switch.

Make sure the Parking Brake Warning Light (Ⓟ_{BRAKE}, red color) comes on.

Also, the EPB is applied automatically if the [AUTO HOLD] switch is on when the engine is turned off. However, if you press the EPB switch within one second after the engine is turned off, the EPB will not be applied.

⚠ WARNING

To reduce the risk of SERIOUS INJURY or DEATH, do not operate the EPB while the vehicle is moving except in an emergency situation. It could damage the brake system and lead to an accident.

Releasing the parking brake

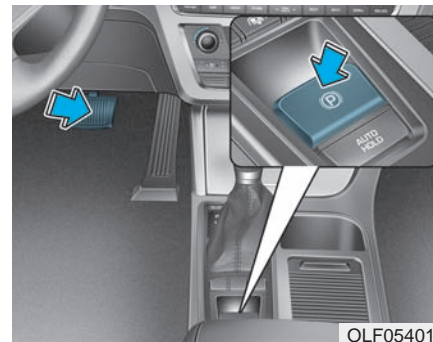

To release the EPB (Electronic Parking Brake)

With the Engine Start/Stop button in the ON position.

1. Depress the brake pedal and hold.
2. Press the EPB switch downwards.

Make sure the Parking Brake Warning Light (Ⓟ_{BRAKE}, red color) goes off.

To release EPB (Electronic Parking Brake) automatically:

- Shift lever in P (Park)

With the engine running depress the brake pedal and shift out of P (Park) to R (Reverse) or D (Drive).
- Shift lever in N (Neutral)

With the engine running depress the brake pedal and shift out of N (Neutral) to R (Reverse) or D (Drive).
- Automatic transaxle vehicle
 1. Start the engine.
 2. Fasten the driver's seat belt.
 3. Close the driver's door, engine hood and tailgate/trunk.
 4. Depress the accelerator pedal while the shift lever is in R (Reverse), D (Drive) or Sports mode.

Make sure the Parking Brake Warning light (ⓘ ⓘ
BRAKE, red color) goes off.

i Information

- **For your safety, you can engage the EPB even though the Engine Stop/Start button is in the OFF position, but you cannot release it.**
- **For your safety, depress the brake pedal and release the parking brake manually with the EPB switch when you drive downhill or when backing up the vehicle.**

NOTICE

- **If the parking brake warning light (ⓘ ⓘ
BRAKE, red color) is still on even though the EPB has been released, have the system checked by an authorized HYUNDAI dealer.**
- **Do not drive your vehicle with the EPB applied. It may cause excessive brake pad and brake rotor wear.**

When the EPB (Electronic Parking Brake) does not release:

Contact an authorized HYUNDAI dealer by loading the vehicle on a flatbed tow truck and have the system checked.

EPB (Electronic Parking Brake) may be automatically applied when:

- The EPB is overheated
- It is requested by other systems
- The hybrid system is turned off with the EPB applied

i Information

If the driver turns the hybrid system off while Auto Hold is operating, EPB will be automatically applied.

However, if you press the EPB switch within one second after the hybrid system is turned off, the EPB will not be applied.

Warning messages

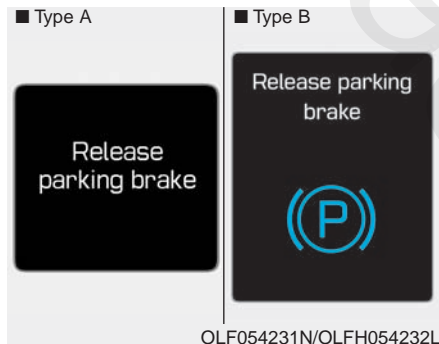

Release parking brake

If the mentioned situation occurs, depress the brake pedal and release EPB by pressing the EPB switch.

- When you try to drive with the EPB applied, a warning will sound and a message will appear.
- When the driver's seat belt is unfastened or the driver's door is open, when the engine hood is open with the shift lever in D (Drive), or when the trunk is open with the shift lever in R (Reverse), a warning message will be displayed with a warning sound.

- When there is a problem with the vehicle, a warning may sound and a message may appear.

WARNING

- Whenever leaving the vehicle or parking, always come to a complete stop and continue to depress the brake pedal.

Move the shift lever into the P (Park) position, press the EPB switch, and press the Engine Start/Stop button to the OFF position. Take the Smart Key with you when exiting the vehicle.

Vehicles not fully engaged in P (Park) with the parking brake set are at risk for moving inadvertently and causing injury to yourself or others.

- NEVER allow anyone who is unfamiliar with the vehicle to touch the EPB switch. If the EPB is released unintentionally, serious injury may occur.
- Only release the EPB when you are seated inside the vehicle with your foot firmly on the brake pedal.

NOTICE

- Do not apply the accelerator pedal while the parking brake is engaged. If you depress the accelerator pedal with the EPB engaged, a warning will sound.
- Driving with the parking brake on can overheat the braking system and cause premature wear or damage to brake parts. Make sure the EPB is released and the parking brake warning light ( red color) is off before driving.

Information

- A clicking sound may be heard while operating or releasing the EPB. These conditions are normal and indicate that the EPB is functioning properly.
- When leaving your keys with a parking attendant or assistant, make sure to inform him/her how to operate the EPB.

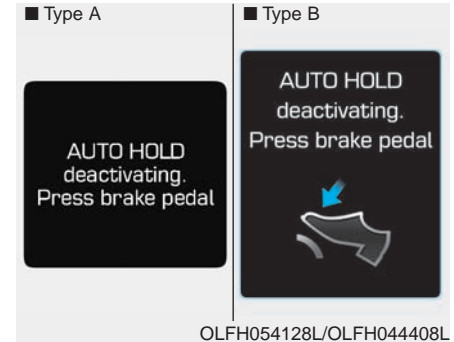

AUTO HOLD deactivating. Press brake pedal

When the conversion from Auto Hold to EPB is not working properly a warning will sound and a message will appear.

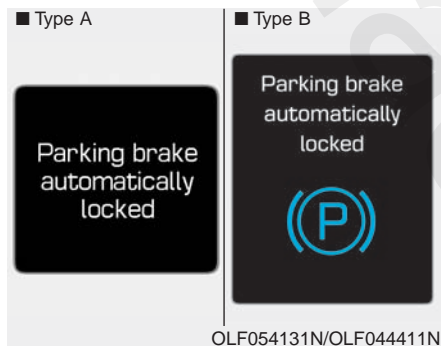

Parking brake automatically locked

If the EPB is applied while Auto Hold is activated, a warning will sound and a message will appear.

EPB malfunction indicator (if equipped)





This warning light illuminates if the Engine Start/Stop button is changed to the ON position and goes off in approximately 3 seconds if the system is operating normally.

If the EPB malfunction indicator remains on, comes on while driving, or does not come on when the Engine Start/Stop button is changed to the ON position, this indicates that the EPB may have malfunctioned.

If this occurs, have the system checked by an authorized HYUNDAI dealer.

The EPB malfunction indicator may illuminate when the ESC indicator comes on to indicate that the ESC is not working properly, but it does not indicate a malfunction of the EPB.

NOTICE

- If the EPB warning light is still on, we recommend that the system be checked by an authorized HYUNDAI dealer.
- If the parking brake warning light (, red color) does not illuminate or blinks even though the EPB switch was pulled up, the EPB may not be applied.
- If the parking brake warning light (, red color) blinks when the EPB warning light is on, press the switch, and then pull it up. Repeat this one more time. If the EPB warning does not go off, have the system checked by an authorized HYUNDAI dealer.

Emergency braking

If there is a problem with the brake pedal while driving, emergency braking is possible by pulling up and holding the EPB switch. Braking is possible only while you are holding the EPB switch.

WARNING

Do not operate the parking brake while the vehicle is moving except in an emergency situation. It could damage the brake system and lead to a severe accident.

Information

During emergency braking the parking brake warning light (, red color) will illuminate to indicate the system is operating.

NOTICE

If there is a noise or burning smell after using the emergency brake, have your vehicle checked by an authorized HYUNDAI dealer as soon as possible.

When the EPB (Electronic Parking Brake) does not release

If the EPB does not release normally, contact an authorized HYUNDAI dealer by loading the vehicle on a flatbed tow truck and have the system checked.

AUTO HOLD (if equipped)

This feature helps keep the brake applied when the shift lever is in D (Drive), R (Reverse), N (Neutral) or Sports Mode with the feature enabled and when the brake pedal has been depressed to stop the vehicle.

To apply :

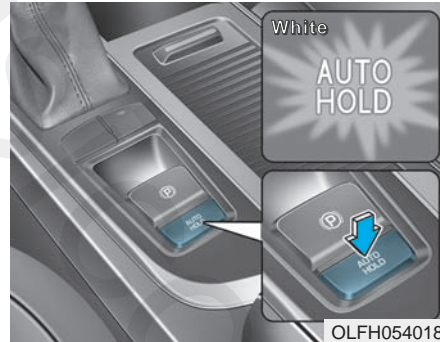

1. With the driver's door, engine hood and trunk closed, fasten the driver's seat belt or depress the brake pedal and then press the [AUTO HOLD] switch. The white "AUTO HOLD" indicator will come on and the system will be in the standby position.

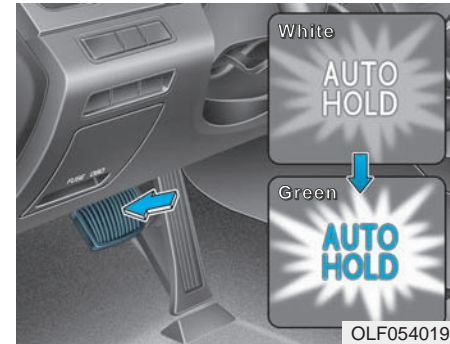

2. When you stop the vehicle completely by depressing the brake pedal, the "AUTO HOLD" indicator changes from white to green.

3. The vehicle will remain stationary even if you release the brake pedal.

4. If EPB is applied, Auto Hold will be released.

To release :

If you press the accelerator pedal with the shift lever in R (Reverse), D (Drive) or Sports Mode, the Auto Hold will be released automatically and the vehicle will start to move. The indicator changes from green to white.

WARNING

When the AUTO HOLD is automatically released by depressing the accelerator pedal, always take a look around your vehicle. Slowly depress the accelerator pedal for a smooth start.

To cancel :

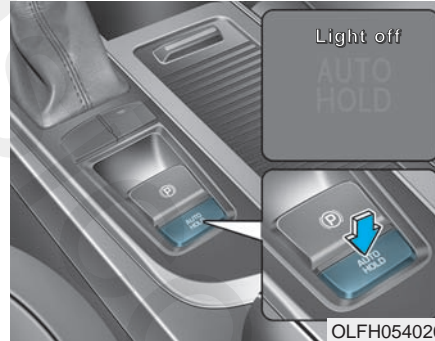

1. Depress the brake pedal.
2. Press the [AUTO HOLD] switch.

The "AUTO HOLD" indicator will turn off.

WARNING

To prevent, unexpected and sudden vehicle movement, ALWAYS press your foot on the brake pedal to cancel the Auto Hold before you:

- Drive downhill.
- Drive the vehicle in R (Reverse).
- Park the vehicle.

i Information

- The Auto Hold does not operate when:
 - The driver's seat belt is unfastened and driver's door is opened
 - The engine hood is opened
 - The trunk is opened
 - The shift lever is in P (Park)
 - The EPB is applied
- For your safety, the Auto Hold automatically switches to EPB when:
 - The driver's seat belt is unfastened and driver's door is opened
 - The engine hood is opened with the shift lever is in D (Drive)
 - The trunk is opened with the shift lever is in R (Reverse)
 - The vehicle stops for more than 10 minutes
 - The vehicle stands on a steep slope
 - The vehicle moves several times

(Continued)

(Continued)

- In these cases, the parking brake warning light ( red color) illuminates, the "AUTO HOLD" indicator color changes from green to white, and a message will be displayed with warning sound to inform you that EPB is automatically applied.
- If the "AUTO HOLD" indicator changes to yellow, the Auto Hold is not working properly. Contact an authorized HYUNDAI dealer.
 - While operating Auto Hold, you may hear mechanical noise. However, it is normal operating noise.

⚠ WARNING

- Press the accelerator pedal slowly when you start the vehicle.
- For your safety, cancel the Auto Hold when you drive downhill, back up the vehicle or park the vehicle.

NOTICE

If there is a malfunction with the driver's door, engine hood or trunk open detection system, the Auto Hold may not work properly. Contact an authorized HYUNDAI dealer.

Warning messages

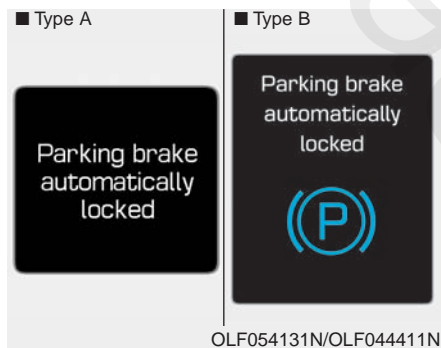

Parking brake automatically locked
When the EPB is applied from Auto Hold, a warning will sound and a message will appear.

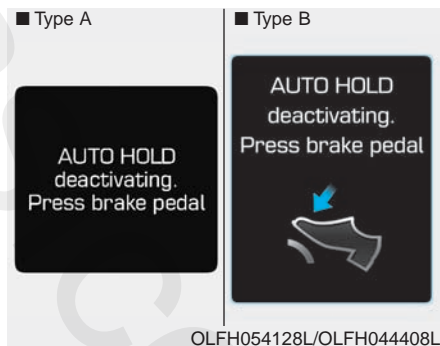

AUTO HOLD deactivating.
Press brake pedal

When the conversion from Auto Hold to EPB is not working properly a warning will sound and a message will appear.

NOTICE

When this message is displayed, the Auto Hold and EPB may not operate. For your safety, depress the brake pedal.

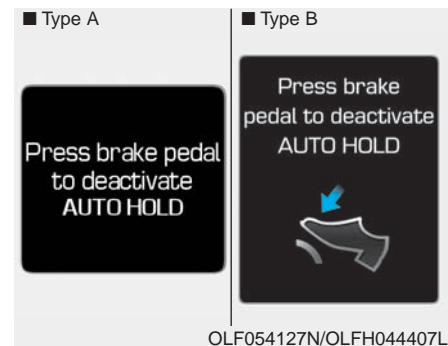

Press brake pedal to deactivate AUTO HOLD

If you did not apply the brake pedal when you release the Auto Hold by pressing the [AUTO HOLD] switch, a warning will sound and a message will appear.

AUTO HOLD
conditions not met. Close door, hood, trunk, and fasten seatbelt

OLF054129N

AUTO HOLD conditions not met. Close door, hood, trunk, and fasten seatbelt

When you press the [AUTO HOLD] switch, if the driver's door, engine hood and trunk are not closed or the driver's seat belt is unfastened, a warning will sound and a message will appear on the LCD display. Press the [AUTO HOLD] button again after closing the driver's door, engine hood and trunk and fastening the seat belt.

Anti-lock Brake System (ABS)

WARNING

An Anti-Lock Braking System (ABS) or an Electronic Stability Control (ESC) system will not prevent accidents due to improper or dangerous driving maneuvers. Even though vehicle control is improved during emergency braking, always maintain a safe distance between you and objects ahead of you. Vehicle speeds should always be reduced during extreme road conditions. The braking distance for cars equipped with ABS or ESC may be longer than for those without these systems in the following road conditions.

- Drive your vehicle at reduced speeds during the following conditions:
- Rough, gravel or snow-covered roads.

(Continued)

(Continued)

- On roads where the road surface is pitted or has different surface height.
- Tire chains are installed on your vehicle.

The safety features of an ABS or ESC equipped vehicle should not be tested by high speed driving or cornering. This could endanger the safety of yourself or others.

ABS is an electronic braking system that helps prevent a braking skid. ABS allows the driver to steer and brake at the same time.

Using ABS

To obtain the maximum benefit from your ABS in an emergency situation, do not attempt to modulate your brake pressure and do not try to pump your brakes. Depress your brake pedal as hard as possible.

When you apply your brakes under conditions which may lock the wheels, you may hear sounds from the brakes, or feel a corresponding sensation in the brake pedal. This is normal and it means your ABS is active.

ABS does not reduce the time or distance it takes to stop the vehicle.

Always maintain a safe distance from the vehicle in front of you.

ABS will not prevent a skid that results from sudden changes in direction, such as trying to take a corner too fast or making a sudden lane change. Always drive at a safe speed for the road and weather conditions.

ABS cannot prevent a loss of stability. Always steer moderately when braking hard. Severe or sharp steering wheel movement can still cause your vehicle to veer into oncoming traffic or off the road.

On loose or uneven road surfaces, operation of the anti-lock brake system may result in a longer stopping distance than for vehicles equipped with a conventional brake system.

The ABS warning light () will stay on for several seconds after the Engine Start/Stop button is in the ON position. During that time, the ABS will go through self-diagnosis and the light will go off if everything is normal. If the light stays on, you may have a problem with your ABS. Contact an authorized HYUNDAI dealer as soon as possible.

WARNING

If the ABS warning light () is on and stays on, you may have a problem with the ABS. Your power brakes will work normally. To reduce the risk of serious injury or death, contact your HYUNDAI dealer as soon as possible.

NOTICE

When you drive on a road having poor traction, such as an icy road, and apply your brakes continuously, the ABS will be active continuously and the ABS warning light (ABS) may illuminate. Pull your car over to a safe place and turn the engine off.

Restart the engine. If the ABS warning light is off, then your ABS system is normal.

Otherwise, you may have a problem with your ABS system. Contact an authorized HYUNDAI dealer as soon as possible.

i Information

When you jump start your vehicle because of a drained battery, the ABS warning light (ABS) may turn on at the same time. This happens because of the low battery voltage. It does not mean your ABS is malfunctioning. Have the battery recharged before driving the vehicle.

Electronic Stability Control (ESC)

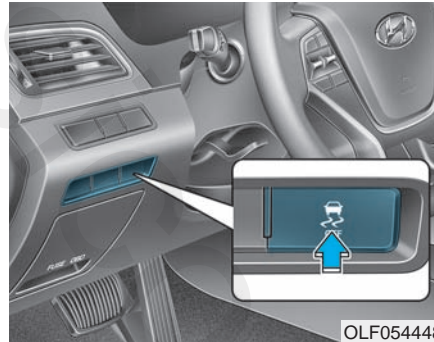

OLF054448

The Electronic Stability Control (ESC) system helps to stabilize the vehicle during cornering maneuvers.

ESC checks where you are steering and where the vehicle is actually going. ESC applies braking pressure to any one of the vehicle's brakes and intervenes in the engine management system to assist the driver with keeping the vehicle on the intended path. It is not a substitute for safe driving practices. Always adjust your speed and driving to the road conditions.

⚠ WARNING

Never drive too fast for the road conditions or too quickly when cornering. The ESC system will not prevent accidents.

Excessive speed in turns, abrupt maneuvers, and hydroplaning on wet surfaces can result in severe accidents.

ESC operation

ESC ON condition

When the Engine Start/Stop button is in the ON position, the ESC and the ESC OFF indicator lights illuminate for approximately three seconds and goes off, then the ESC is turned on.

When operating



When the ESC is in operation, the ESC indicator light blinks:

- When you apply your brakes under conditions which may lock the wheels, you may hear sounds from the brakes, or feel a corresponding sensation in the brake pedal. This is normal and it means your ESC is active.
- When the ESC activates, the engine may not respond to the accelerator as it does under routine conditions.
- If the Cruise Control was in use when the ESC activates, the Cruise Control automatically disengages. The Cruise Control can be reengaged when the road conditions allow. **See “Cruise Control System” later in this chapter.**

- When moving out of the mud or driving on a slippery road, the engine rpm (revolutions per minute) may not increase even if you press the accelerator pedal deeply. This is to maintain the stability and traction of the vehicle and does not indicate a problem.

ESC OFF condition



To cancel ESC operation :

• State 1

■ Type A



■ Type B



OLF054439N/OLF054101N

Press the ESC OFF button shortly (ESC OFF indicator light and message illuminates). At this state, the engine control function does not operate. The traction control function does not operate but only the brake control function operates.

• State 2

■ Type A



■ Type B



OLF054438N/OLF054100N

Press the ESC OFF button for more than 3 seconds. ESC OFF indicator light and message illuminates and ESC OFF warning chime will sound. At this state, the engine control function and brake control function does not operate. The vehicle stability control function does not operate any more.

If the Engine Start/Stop button is placed to the OFF position when ESC is off, ESC remains off. Upon restarting the engine, the ESC will automatically turn on again.

Indicator lights

■ ESC indicator light (blinks)



■ ESC OFF indicator light (comes on)



When the Engine Start/Stop button is pressed to the ON position, the ESC indicator light illuminates, then goes off if the ESC system is operating normally.

The ESC indicator light blinks whenever the ESC is operating.

If ESC indicator light stays on, your vehicle may have a malfunction with the ESC system. When this warning light illuminates, have the vehicle checked by an authorized HYUNDAI dealer as soon as possible.

The ESC OFF indicator light comes on when the ESC is turned off with the button.

WARNING

When the ESC is blinking, this indicates the ESC is active:

Drive slowly and NEVER attempt to accelerate. NEVER turn the ESC off while the ESC indicator light is blinking or you may lose control of the vehicle resulting in an accident.

NOTICE

Driving with tires or wheels in various sizes may fail the normal operation of the ESC system. Before replacing tires, make sure they are in the same size as others. Never drive the vehicle, which is installed with the tires of different diameters.

ESC OFF usage

When Driving

The ESC OFF mode should only be used briefly to help free the vehicle if stuck in snow or mud by temporarily stopping operation of the ESC to maintain wheel torque.

To turn ESC off while driving, press the ESC OFF button while driving on a flat road surface.

NOTICE

To prevent damage to the transaxle:

- **Do not allow wheel(s) of one axle to spin excessively while the ESC, ABS, and parking brake warning (, red color) lights are displayed. The repairs would not be covered by the vehicle warranty. Reduce engine power and do not spin the wheel(s) excessively while these lights are displayed.**
- **When operating the vehicle on a dynamometer, make sure the ESC is turned off (ESC OFF light illuminated).**

Information

Turning the ESC off does not affect ABS or standard brake system operation.

Vehicle Stability Management

Vehicle Stability Management (VSM) helps ensure the vehicle stays stable when accelerating or braking suddenly on wet, slippery and rough roads where traction over the four tires can suddenly become uneven.

WARNING

Take the following precautions when using the Vehicle Stability Management (VSM):

- **ALWAYS check the speed and the distance to the vehicle ahead. The VSM is not a substitute for safe driving practices.**
- **Never drive too fast for the road conditions. The VSM system will not prevent accidents. Excessive speed in bad weather, slippery and uneven roads can result in severe accidents.**

VSM operation

VSM ON condition

The VSM operates when:

- The Electronic Stability Control (ESC) is on.
- Vehicle speed is approximately above 9 mph (15 km/h) on curve roads.
- Vehicle speed is approximately above 12 mph (20 km/h) when the vehicle is braking on rough roads.

When operating

When you apply your brakes under conditions which may activate the ESC, you may hear sounds from the brakes, or feel a corresponding sensation in the brake pedal. This is normal and it means your VSM is active.

Information

The VSM does not operate when:



- **Driving on bank road such as gradient or incline**
- **Driving rearward.**
- **ESC OFF indicator light is on.**
- **EPS (Electric Power Steering) warning light () is on.**

VSM OFF condition

To cancel VSM operation, press the ESC OFF button. ESC OFF indicator light () will illuminate.

To turn on VSM, press the ESC OFF button again. The ESC OFF indicator light will go out.

WARNING

If ESC indicator light () or EPS warning light () stays on, your vehicle may have a malfunction with the VSM system. When the warning light illuminates have the vehicle checked by an authorized HYUNDAI dealer as soon as possible.

NOTICE

Driving with varying tire or wheel sizes may cause the ESC system to malfunction. When replacing tires, make sure they are the same size as your original tires for this vehicle.

Hill-Start Assist Control (HAC)

A vehicle has the tendency to slide backwards on a steep slope, before depressing the accelerator after a stop. The HAC helps prevent the vehicle from sliding backwards by automatically operating the brake systems for about 2 seconds. The brake systems are automatically released, when the accelerator pedal is depressed.

WARNING

The HAC is activated only for about 2 seconds, so always depress the accelerator pedal to begin driving upwards after a stop.

Information

- The HAC does not operate when the shift lever is in P (Park) or N (Neutral).
- The HAC activates even when the ESC (Electronic Stability Control) is off. However, it does not activate, when the ESC does not normally operate.

Good braking practices

WARNING

Whenever leaving the vehicle or parking, always come to a complete stop and continue to depress the brake pedal. Move the shift lever into the P (Park) position, then apply the parking brake, and place the Engine Start/Stop button in the OFF position.

Vehicles with the parking brake not fully engaged are at risk for moving inadvertently and causing injury to yourself or others.

Wet brakes can be dangerous! The brakes may get wet if the vehicle is driven through standing water or if it is washed. Your vehicle will not stop as quickly if the brakes are wet. Wet brakes may cause the vehicle to pull to one side.

To dry the brakes, apply the brakes lightly until the braking action returns to normal, taking care to keep the vehicle under control at all times. If the braking action does not return to normal, stop as soon as it is safe to do so and call an authorized HYUNDAI dealer for assistance.

DO NOT drive with your foot resting on the brake pedal. Even light, but constant pedal pressure can result in the brakes overheating, brake wear, and possibly even brake failure.

If a tire goes flat while you are driving, apply the brakes gently and keep the vehicle pointed straight ahead while you slow down. When you are moving slowly enough for it to be safe to do so, pull off the road and stop in a safe location.

Keep your foot firmly on the brake pedal when the vehicle is stopped to prevent the vehicle from rolling forward.

DRIVE MODE INTEGRATED CONTROL SYSTEM

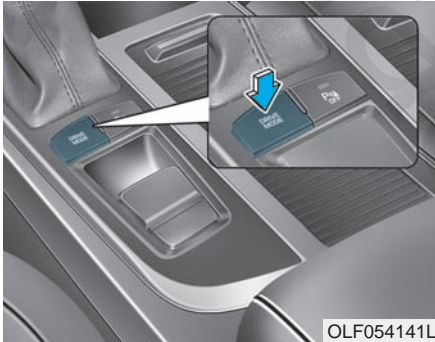

The drive mode may be selected according to the driver's preference or road condition.

The system resets to be in the ECO mode, when the hybrid system is restarted.

i Information

If there is a problem with the instrument cluster, the drive mode will be in ECO mode and may not change to NORMAL mode or SPORT mode.

The mode changes, as below, whenever the DRIVE MODE button is pressed.



When NORMAL mode is selected, it is not displayed on the instrument cluster.

ECO mode (Active ECO)

ECO

The ECO mode is a guidance for fuel efficient driving.

When the ECO mode is selected by pressing the DRIVE MODE button, the ECO indicator (green color) will illuminate.

i Information

Fuel efficiency depends on the driver's driving habit and road condition.

i Information

The ECO mode will provide best efficiency for customer driving habits that are not aggressive in accelerating and in conditions not involving many rolling hills to drive through. Under situation of aggressive driving style or driving conditions involving rolling hills causing frequent gear shifts you should try NORMAL mode instead as it may actually yield your best economy and drivability. Compare between the 2 modes.

When Active ECO is activated:

- The acceleration response may be slightly reduced as the accelerator pedal is depressed moderately.
- The air conditioner performance may be limited.
- The shift pattern of the automatic transaxle may change.
- The engine noise may get louder.

The above situations are normal conditions when the Active ECO system is activated to improve fuel efficiency.

SPORT mode

SPORT

SPORT mode manages the driving dynamics by automatically adjusting the steering wheel and hybrid system.

- When the SPORT mode is selected by pressing the DRIVE MODE button, the SPORT indicator (yellow color) will illuminate.
- Restarting of the hybrid system in the SPORT mode resets the DRIVE mode to the ECO mode. Thus, when necessary, reselect the SPORT mode.

***i* Information**

In the SPORT mode, the fuel efficiency may decrease.

CRUISE CONTROL

Cruise Control operation

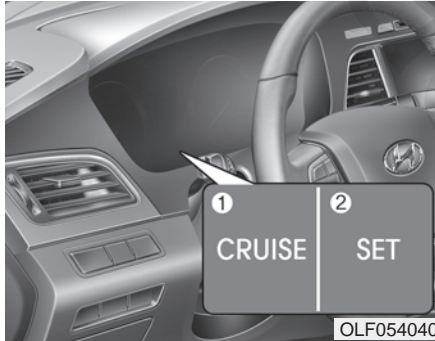

1. CRUISE indicator
2. SET indicator

The Cruise Control system allows you to drive at speeds above 20 mph (30 km/h) without depressing the accelerator pedal.

WARNING

Take the following precautions:

- If the Cruise Control is left on, ("CRUISE" indicator light in the instrument cluster is illuminated) the Cruise Control can be activated unintentionally. Keep the Cruise Control system off ("CRUISE" indicator light OFF) when the Cruise Control is not in use, to avoid inadvertently setting a speed.
- Use the Cruise Control system only when traveling on open highways in good weather.
- Do not use the Cruise Control when it may be unsafe to keep the vehicle at a constant speed:
 - Driving in heavy or varying speed traffic.
 - On slippery (rainy, icy or snow covered) roads.
 - Hilly or winding roads.
 - Very windy areas.

Information

- During normal cruise control operation, when the SET switch is activated or reactivated after applying the brakes, the cruise control will energize after approximately 3 seconds. This delay is normal.
- To activate cruise control, depress the brake pedal at least once after turning the ignition switch to the ON position or starting the engine. This is to check if the brake switch which is important part to cancel cruise control is in normal condition.

To set Cruise Control speed

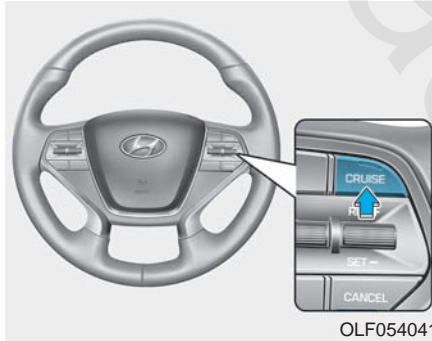

1. Press the CRUISE button on the steering wheel to turn the system on. The "CRUISE" indicator will illuminate.
2. Accelerate to the desired speed, which must be more than 20 mph (30 km/h).

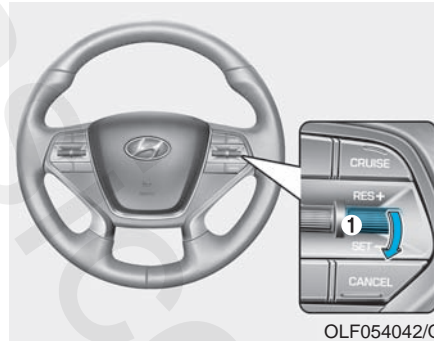

3. Push the lever (1) down (SET-), and release it. The SET indicator light will illuminate.
4. Release the accelerator pedal.

i Information

On a steep slope, the vehicle may slightly slow down or speed up, while driving uphill or downhill.

To increase Cruise Control speed

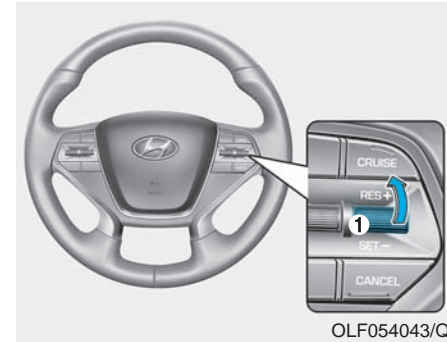

- Push the lever (1) up (RES+) and hold it, while monitoring the SET speed on the instrument cluster. Release the lever when the desired speed is shown and the vehicle will accelerate to that speed.
- Push the lever (1) up (RES+) and release it immediately. The cruising speed will increase 1.0 mph (1.6 km/h) each time the lever is operated in this manner.

- Depress the accelerator pedal. When the vehicle attains the desired speed, push the lever (1) down (SET-).

To decrease Cruise Control speed

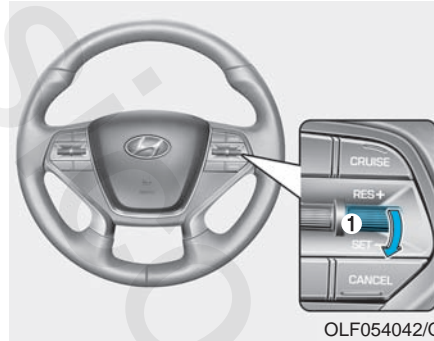

- Push the lever (1) down (SET-) and hold it. Your vehicle will gradually slow down. Release the lever at the speed you want to maintain.
- Push the lever (1) down (SET-) and release it immediately. The cruising speed will decrease 1.0 mph (1.6 km/h) each time the lever is operated in this manner.
- Lightly tap the brake pedal. When the vehicle attains the desired speed, push the lever (1) down (SET-).

To temporarily accelerate with the Cruise Control ON

Depress the accelerator pedal. When you take your foot off the accelerator, the vehicle will return to the previously set speed.

If you push the lever down (SET-) at the increased speed, the Cruise Control will maintain the increased speed.

Cruise Control will be canceled when:

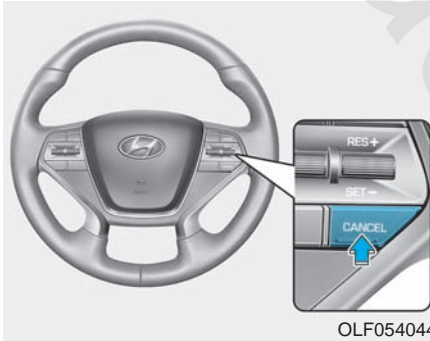

- Decreasing the vehicle speed to less than approximately 20 mph (30 km/h).
 - The ESC (Electronic Stability Control) is operating.
 - Downshifting to the 2nd gear in Sports Mode.
- Depressing the brake pedal.
 - Pressing the CANCEL button located on the steering wheel.
 - Pressing the CRUISE button. Both the CRUISE indicator and the "SET" indicator will turn OFF.
 - Moving the shift lever into N (Neutral).
 - Decreasing the vehicle speed lower than the set speed by 5 mph (10 km/h).

***i* Information**

Each of the above actions will cancel Cruise Control operation (the "SET" indicator in the instrument cluster will go off), but only pressing the CRUISE button will turn the system off. If you wish to resume Cruise Control operation, push the lever up (RES+) located on your steering wheel. You will return to your previously preset speed, unless the system was turned off using the CRUISE button.

To resume preset Cruising speed

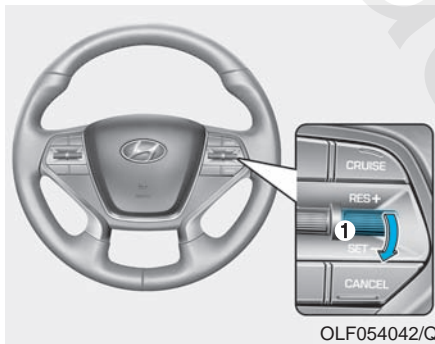

OLF054042/Q

Push the lever (1) up (RES+). If the vehicle speed is over 20 mph (30 km/h), the vehicle will resume the preset speed.

To turn Cruise Control off

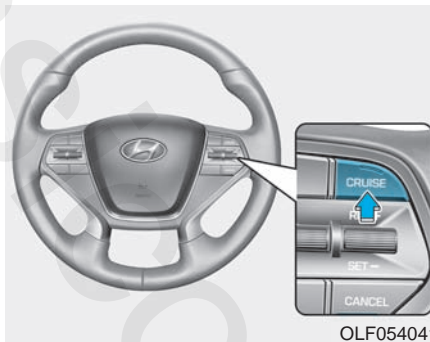

OLF054041

- Press the CRUISE button (the "CRUISE" indicator light will go off).
- Turn the vehicle OFF.

SMART CRUISE CONTROL SYSTEM (IF EQUIPPED)



OLF054430N

- ① Cruise Indicator
- ② Set Speed
- ③ Vehicle-to-Vehicle Distance

The Smart Cruise Control System allows you to program the vehicle to maintain constant speed and distance detecting the vehicle ahead without depressing the accelerator/brake pedal.

⚠ WARNING

For your safety, please read the owner's manual before using the Smart Cruise Control system.

⚠ WARNING

The Smart Cruise Control System is not a substitute for safe driving practices, but a convenience function only. It is the responsibility of the driver to always check the speed and distance to the vehicle ahead.

⚠ WARNING

Take the following precautions:

- If the Smart Cruise Control is left on, ("CRUISE" indicator light in the instrument cluster is illuminated) the Smart Cruise Control can be activated unintentionally. Keep the Smart Cruise Control System off ("CRUISE" indicator light OFF) when the Smart Cruise Control is not in use, to avoid inadvertently setting a speed.
- Use the Smart Cruise Control System when traveling on open highways in good weather.
- Do not use the Smart Cruise Control when it may not be safe to keep the vehicle at a constant speed:
 - Driving in heavy or varying speed traffic.
 - On slippery (rainy, icy or snow covered) roads.
 - Hilly or winding roads.
 - Very windy areas.

To adjust the sensitivity of Smart Cruise Control



The sensitivity of vehicle speed when following the front vehicle to maintain the set distance can be adjusted. Go to the User Settings Mode (Driving Assist) and select SCC (Smart Cruise Control). You may select one of the three stages you prefer.

- Slow:

Vehicle speed following the front vehicle to maintain the set distance is slower than normal speed.

- Normal:

Vehicle speed following the front vehicle to maintain the set distance is normal

- Fast:

Vehicle speed following the front vehicle to maintain the set distance is faster than normal speed.

To convert to Cruise Control Mode

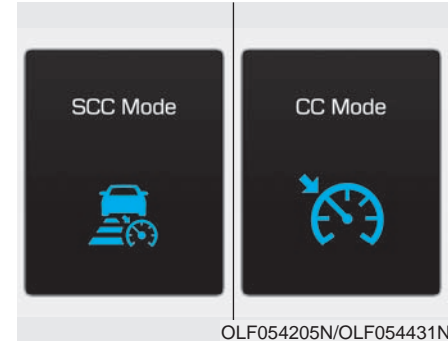

The driver may choose to only use the Cruise Control Mode (speed control function) by doing as follows:

1. Turn the Smart Cruise Control System on (the "CRUISE" indicator will be on but the system will not be activated).
2. Press and hold the Vehicle-to-Vehicle Distance button for more than 2 seconds.
3. Choose between "Smart Cruise Control (SCC) Mode" and "Cruise Control (CC) Mode".

When the system is canceled using the CRUISE button or the CRUISE button is used after the engine is turned on, the SCC Mode will turn on.

WARNING

When using the Cruise Control Mode, you must manually adjust the distance to other vehicles by depressing the accelerator or brake pedal. The system does not automatically adjust the distance to vehicles in front of you.

Smart Cruise Control speed

To set Smart Cruise Control speed

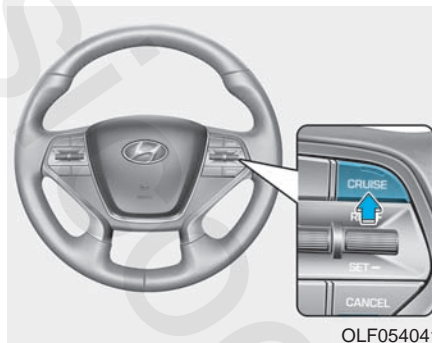

1. Push the CRUISE button on the steering wheel to turn the system on. The "CRUISE" indicator will illuminate.
2. Accelerate to the desired speed.
The Smart Cruise Control speed can be set as follows:
 - 20 mph (30 km/h)~110 mph (180 km/h): when there is no vehicle in front
 - 0 mph (0 km/h)~110 mph (180 km/h): when there is a vehicle in front

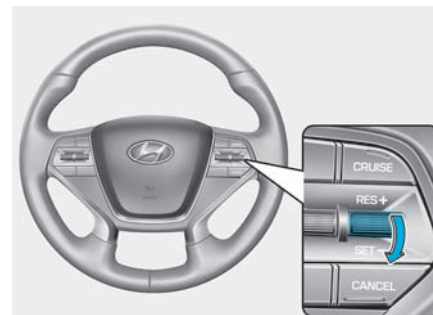

3. Push the lever down (SET-), and release it at the desired speed. The Set Speed and Vehicle-to-Vehicle Distance on the LCD display will illuminate.
4. Release the accelerator pedal. The desired speed will automatically be maintained.

If there is a vehicle in front of you, the speed may decrease to maintain the distance to the vehicle ahead.

On a steep grade, the vehicle may slow down or speed up slightly while going uphill or downhill.

To increase Smart Cruise Control set speed



Follow either of these procedures:

- Push the lever up (RES+), and hold it. Your vehicle set speed will increase by 5 mph (10 km/h). Release the lever at the speed you want.
- Push the lever up (RES+), and release it immediately. The cruising speed will increase by 1.0 mph (1.0 km/h) each time you move the lever up in this manner.
- You can set the speed to 110 mph (180 km/h).

To decrease the Smart Cruise Control set speed

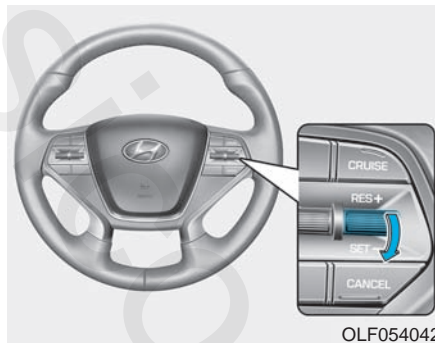

Follow either of these procedures:

- Push the lever down (SET-), and hold it. Your vehicle set speed will decrease by 5 mph (10 km/h). Release the lever at the speed you want.
- Push the lever down (SET-), and release it immediately. The cruising speed will decrease by 1.0 mph (1.0 km/h) each time you move the lever down in this manner.
- You can set the speed to 20 mph (30 km/h).

To temporarily accelerate with the Smart Cruise Control on

If you want to speed up temporarily when the Smart Cruise Control is on, depress the accelerator pedal. Increased speed will not interfere with Smart Cruise Control operation or change the set speed.

To return to the set speed, take your foot off the accelerator.

If you push the lever down (SET-) at increased speed, the cruising speed will be set again.

CAUTION

Be careful when accelerating temporarily, because the speed is not controlled automatically at this time even if there is a vehicle in front of you.

Smart Cruise Control will be temporarily canceled when:



Canceled manually

- Depressing the brake pedal.
- Pressing the CANCEL button located on the steering wheel.
- Depress the brake pedal and press the CANCEL button at the same time, when the vehicle is at a standstill.

The Smart Cruise Control turns off temporarily when the indicator on the LCD display turns off.

The CRUISE indicator is illuminated continuously.

Canceled automatically

- The driver's door is opened.
- The shift lever is shifted to N (Neutral), R (Reverse) or P (Park).
- The EPB (Electronic Parking Brake) is applied.
- The vehicle speed is over 120 mph (190 km/h)
- The ESC (Electronic Stability Control), TCS (Traction Control System) or ABS is operating.
- The ESC is turned off.
- The radar or the cover is dirty or blocked with foreign matter.
- The SCC system has malfunctioned.
- When the vehicle is stopped for more than 5 minutes.
- The driver starts driving by pushing the lever up (RES +) or down (SET -) or depressing the accelerator pedal, approximately 3 seconds after the vehicle is stopped by the Smart Cruise Control System with no other vehicle ahead.

- The driver starts driving by pushing the lever up (RES +) or down (SET -) or depressing the accelerator pedal, after stopping the vehicle with a vehicle stopped far away in front.
- The accelerator pedal is continuously depressed for more than one minute.

Each of these actions will cancel the Smart Cruise Control operation. (The Set Speed and Vehicle-to-Vehicle Distance on the LCD display will go off.)

In a condition the Smart Cruise Control is canceled automatically, the Smart Cruise Control will not resume even though the RES+ or SET- lever is pushed. Also, the EPB will be applied when the vehicle is stopped.

NOTICE

If the Smart Cruise Control is canceled by other than the reasons mentioned, have your vehicle checked by an authorized HYUNDAI dealer.

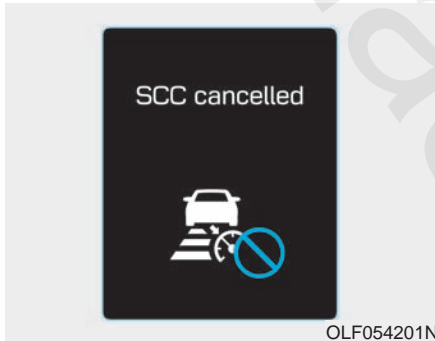

If the system is canceled, the warning chime will sound and a message will appear for a few seconds.

You must adjust the vehicle speed by depressing the accelerator or brake pedal according to the road condition ahead and driving condition.

Always check the road conditions. Do not rely on the warning chime.

To resume Smart Cruise Control set speed

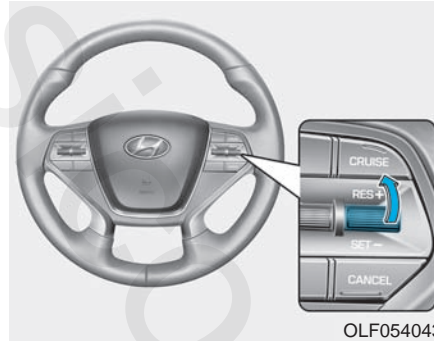

If any method other than the cruise lever was used to cancel cruising speed and the system is still activated, the cruising speed will automatically resume when you push the lever up (RES+) or down (SET-).

If you push the lever up (RES+), the speed will resume to the recently set speed. However, if vehicle speed has dropped below approximately 20 mph (30 km/h), it will resume when there is a vehicle in front of your vehicle.

CAUTION

Always check the road conditions when you push the lever up (RES+) to resume speed.

To turn Cruise Control off

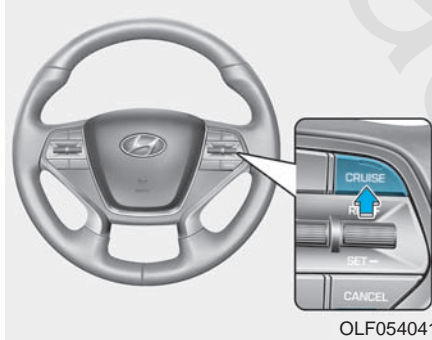

Press the CRUISE button (the "CRUISE" indicator light will go off).

Smart Cruise Control vehicle-to-vehicle distance

To set Vehicle-to-Vehicle Distance



When the Smart Cruise Control System is ON, you can set and maintain the distance from the vehicle ahead of you without pressing the accelerator or brake pedal.

Each time the button is pressed, the vehicle to vehicle distance changes as follows:

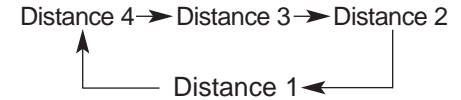

For example, if you drive at 56 mph (90 km/h), the distance maintain as follows:

- Distance 4 - approximately 172 feet (52.5 m)
- Distance 3 - approximately 130 feet (40 m)
- Distance 2 - approximately 106 feet (32.5 m)
- Distance 1 - approximately 82 feet (25 m)

***i* Information**

Distance 4 is always set when the system is used for the first time after starting the engine.

When the lane ahead is clear:



OLF054447N

The vehicle speed will maintain the set speed.

When there is a vehicle ahead of you in your lane:



- Your vehicle speed will slow down or speed up to maintain the selected distance.
- If the vehicle ahead speeds up, your vehicle will travel at a steady cruising speed after accelerating to the set speed.

⚠ WARNING

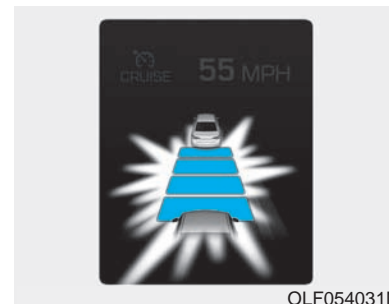

When using the Smart Cruise Control System:

- The warning chime sounds and the Vehicle-to Vehicle Distance indicator blinks if the vehicle is unable to maintain the selected distance from the vehicle ahead.

(Continued)

(Continued)

- If the warning chime sounds, depress the accelerator or brake pedal to actively adjust the vehicle speed, and the distance to the vehicle ahead.
- Even if the warning chime is not activated, always pay attention to the driving conditions to prevent dangerous situations from occurring.



CAUTION

If the vehicle ahead (vehicle speed: less than 20 mph (30km/h)) disappears to the next lane, the warning chime will sound and a message will appear. Adjust your vehicle speed for vehicles or objects that can suddenly appear in front of you by depressing the brake pedal.

Always pay attention to the road condition ahead.

In traffic situation



In traffic, your vehicle will stop if the vehicle ahead of you stops. Also, if the vehicle ahead of you starts moving, your vehicle will start as well. However, if the vehicle stops for more than 3 seconds, you must depress the accelerator pedal or push up the lever (RES+ or SET-) to start driving.

Radar to detect distance to the vehicle ahead



The Smart Cruise Control uses a radar to detect distance to the vehicle ahead.

Radar check message



If the radar or cover is dirty or obscured with foreign matter such as snow, this message will appear. In this case, the system may not function temporarily, but it does not indicate a malfunction of the Smart Cruise Control System. Clean the radar or cover by using a soft cloth.

SCC (Smart Cruise Control) malfunction message



The message will appear when the vehicle to vehicle distance control system is not functioning normally. Take your vehicle to an authorized HYUNDAI dealer and have the system checked.

CAUTION

- Do not install accessories around the radar and do not replace the bumper by yourself. It may interfere with the radar performance.
- Always keep the radar and bumper clean.
- To prevent radar cover damage from occurring, wash the car with a soft cloth.
- Do not paint the radar cover.
- Do not damage the radar or radar area by a strong impact. If the radar moves slightly off position, the Smart Cruise Control System will not operate correctly. If this occurs, have your vehicle checked by an authorized HYUNDAI dealer.
- Use only a genuine HYUNDAI radar cover for your vehicle.

Limitations of the system

The Smart Cruise Control System may have limits to its ability to detect distance to the vehicle ahead due to road and traffic conditions.

On curves

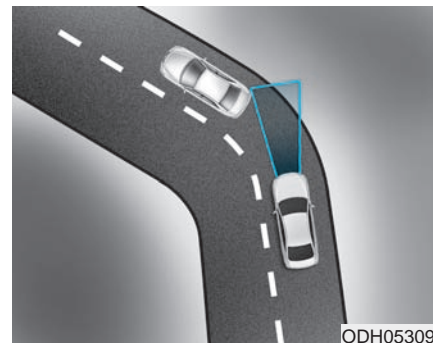

- The Smart Cruise Control System may not detect a moving vehicle in your lane, and then your vehicle could accelerate to the set speed. Also, the vehicle speed will decrease when the vehicle ahead is recognized suddenly.
- Select the appropriate set speed on curves and apply the brakes or accelerator pedal if necessary.



ODH053093

Your vehicle speed can be reduced due to a vehicle in the adjacent lane. Apply the accelerator pedal and select the appropriate set speed. Check to be sure that the road conditions permit safe operation of the Smart Cruise Control.

On inclines

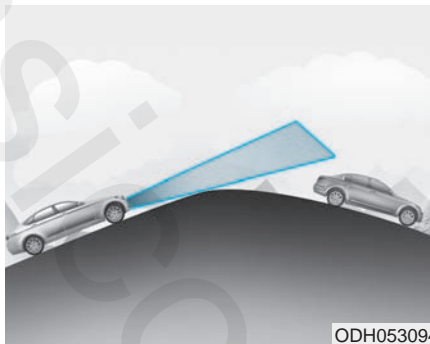

ODH053094

- During uphill or downhill driving, the Smart Cruise Control System may not detect a moving vehicle in your lane, and cause your vehicle to accelerate to the set speed. Also, the vehicle speed will rapidly decrease when the vehicle ahead is recognized suddenly.
- Select the appropriate set speed on inclines and apply the brake or accelerator pedal if necessary.

Lane changing

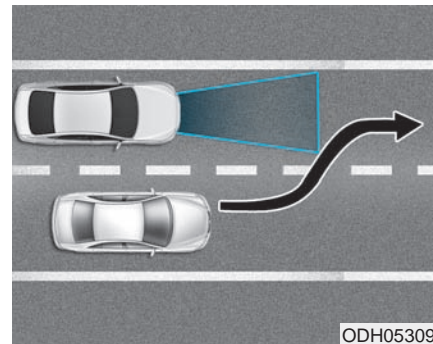

ODH053095

- A vehicle which moves into your lane from an adjacent lane cannot be recognized by the radar until it is in the radar's detection range.
- The radar may not detect immediately when a vehicle cuts in suddenly. Always pay attention to the traffic, road and driving conditions.
- If a slower vehicle moves into your lane, your speed may decrease to maintain the distance to the vehicle ahead.
- If a faster vehicle moves into your lane, your vehicle will accelerate to the set speed.

Vehicle recognition

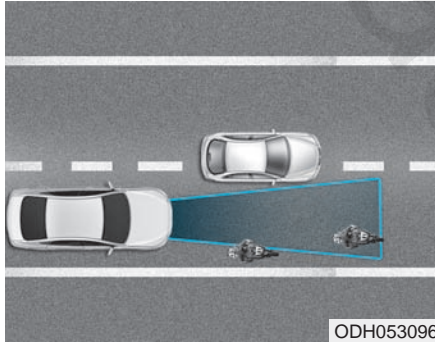

Some vehicles in your lane cannot be recognized by the radar:

- Narrow vehicles such as motorcycles or bicycles
- Vehicles offset to one side
- Slow-moving vehicles or sudden-decelerating vehicles
- Stopped vehicles
- Vehicles with small rear profile such as trailers with no loads

A vehicle ahead cannot be recognized correctly by the radar if any of following occurs:

- When the vehicle is pointing upwards due to overloading in the trunk
- While the steering wheel is operating
- When driving to one side of the lane
- When driving on narrow lanes or on curves

Apply the brake or accelerator pedal if necessary.

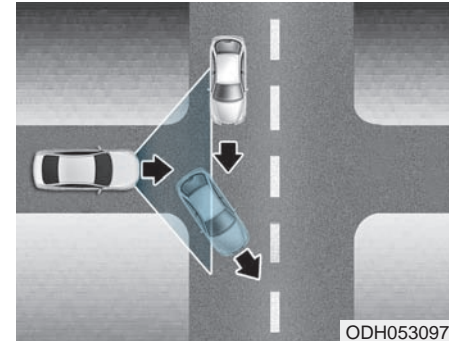

- Your vehicle may accelerate when a vehicle ahead of you disappears.
- When you are warned that the vehicle ahead of you is not detected, drive with caution.

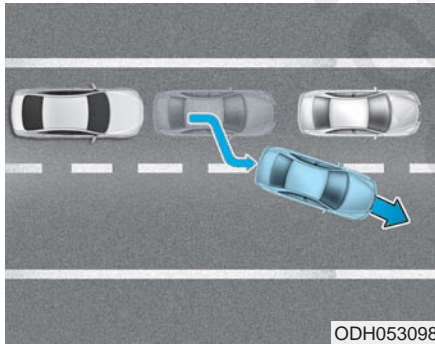

ODH053098

- When vehicles are at a standstill and the vehicle in front of you changes to the next lane, be careful when your vehicle starts to move because it may not recognize the stopped vehicle in front of you.

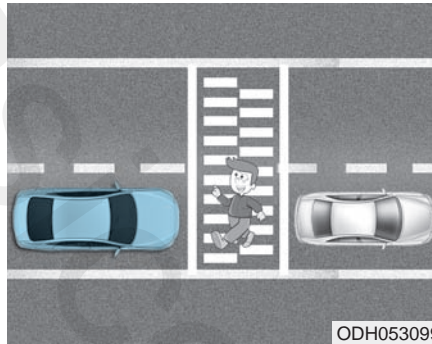

ODH053099

- Always look out for pedestrians when your vehicle is maintaining a distance with the vehicle ahead.

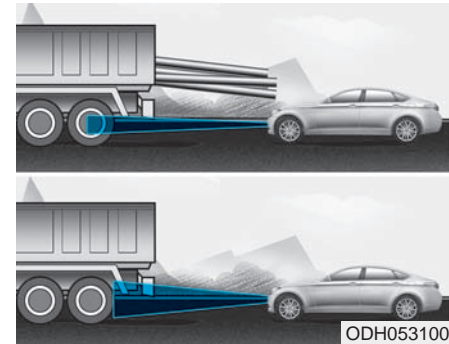

ODH053100

- Always be cautious for vehicles with higher height or vehicles carrying loads that sticks out from the back of the vehicle.

⚠ WARNING

When using the Smart Cruise Control take the following precautions:

- If an emergency stop is necessary, you must apply the brakes. The vehicle cannot be stopped by using the Smart Cruise Control System.
- Keep a safe distance according to road conditions and vehicle speed. If the vehicle to vehicle distance is too close during a high-speed driving, a serious collision may result.
- Always maintain sufficient braking distance and decelerate your vehicle by applying the brakes if necessary.
- The Smart Cruise Control System cannot recognize a stopped vehicle, pedestrians or an oncoming vehicle. Always look ahead cautiously to prevent unexpected and sudden situations from occurring.

(Continued)

(Continued)

- Vehicles moving in front of you with a frequent lane change may cause a delay in the system's reaction or may cause the system to react to a vehicle actually in an adjacent lane. Always drive cautiously to prevent unexpected and sudden situations from occurring.
- Always be aware of the selected speed and vehicle to vehicle distance.
- The Smart Cruise Control System may not recognize complex driving situations so always pay attention to driving conditions and control your vehicle speed.

NOTICE

The Smart Cruise Control System may not operate temporarily due to:

- Electrical interference
- Modifying the suspension
- Differences of tire abrasion or tire pressure
- Installing different type of tires

i Information

This device complies with Part 15 of the FCC rules.

Operation is subject to the following three conditions:

1. This device may not cause harmful interference, and
2. This device must accept any interference received, including interference that may cause undesired operation.
3. Changes or modifications not expressly approved by the party responsible for compliance could void the user's authority to operate the device.

i Information

Radio frequency radiation exposure information:

This equipment complies with FCC radiation exposure limits set forth for an uncontrolled environment.

This equipment should be installed and operated with minimum distance of 20 cm between the radiator (antenna) and your body.

This transmitter must not be co-located or operating in conjunction with any other antenna or transmitter.

FORWARD COLLISION WARNING SYSTEM (FCWS) (IF EQUIPPED)

The Forward Collision Warning System helps avoid accidents by identifying critical situations early and warning the driver.

FCWS operation

To operate:



Go to the User Settings mode (Driving Assist) and select FCW (Forward Collision Warning) on the LCD display. The system will turn on and standby to activate. The system will activate when vehicle speed is above 25 mph (40 km/h) and below 90 mph (145 km/h).



When the FCWS is turned off on the User Settings mode, FCWS warning light will illuminate on the instrument cluster. When the FCWS warning light remains illuminated, even though the FCWS is turned on, have the system checked by an authorized HYUNDAI dealer.

FCWS will default ON when vehicle is restarted even though FCWS was turned off on the User Settings mode.

Warning message



A warning message and chime will be provided when rapidly approaching a slower moving, braking or stopped vehicle ahead.

Immediately reduce your speed to prevent a collision.

i Information

The maximum warning speed for a stopped vehicle is 53 mph (85 km/h).

! WARNING

- The Forward Collision Warning System is a supplemental system to assist you and its effects may differ according to road and driving conditions. Do not solely rely on the system and always pay attention to prevent dangerous situations from occurring.
- FCWS is a warning system and does not apply the brakes automatically in a near crash situation. FCWS may not provide a warning with enough time to help avoid a crash. FCWS does not detect pedestrians, animals, signs, construction or other objects. It is the responsibility of the driver to pay attention to the roadway to prevent collisions.

FCWS malfunction message

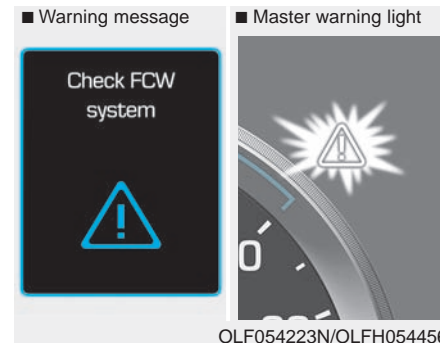

When the FCWS is not working properly, the FCWS warning light (🚗) will illuminate and the warning message will come on for a few seconds. After the message disappears, the master warning light will illuminate.

Limitations of the system

The Forward Collision Warning System may have limits to its ability to detect distance to the vehicle ahead due to road and traffic conditions.

The FCW cannot detect vehicles or detect objects as vehicles when:

- The camera lens is covered with dirt.
- There is heavy rain or heavy snow.
- Driving in a curve.
- Driving uphill or downhill.
- An object ahead is very narrow such as motorcycles or bicycles.
- A vehicle suddenly enters your lane.
- The front vehicle suddenly departs from the lane or it is hidden by other objects.
- A vehicle passes by at a higher rate of speed.
- An unusual shape vehicle is ahead such as a trailer, special access vehicle or a truck with unique shaped cargo.
- The rear lamps of the vehicle ahead is missing, installed on an unusual place or installed unevenly.
- The front vehicle installs a separate lamp or LED lamp at the rear of the vehicle.
- Coming in or out a tunnel, where the illumination intensity is high.
- Driving with the sun in front of you.
- The approaching vehicle has the high beam on.
- The vehicle vibrates heavily due to road conditions.
- The vehicle is tilted from a flat tire or being towed.
- The vehicle ahead is not distinguishable due to similar shape lamps.
- An object ahead is mistaken for a vehicle such as a shadow, sign, etc.

Information

This device complies with Part 15 of the FCC rules.

Operation is subject to the following two conditions:

- 1. This device may not cause harmful interference, and**
- 2. This device must accept any interference received, including interference that may cause undesired operation.**

LANE DEPARTURE WARNING SYSTEM (LDWS) (IF EQUIPPED)

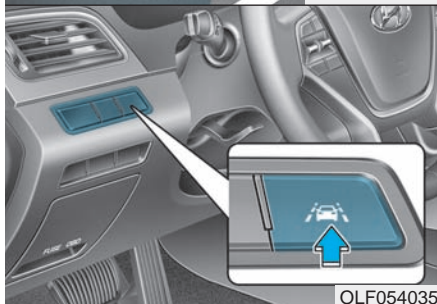
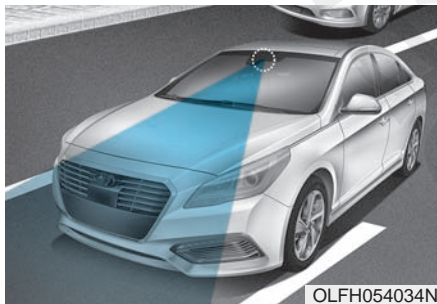

Lane Departure Warning System detects the lane with the camera at the front windshield and warns you when your vehicle departs from the lane.

WARNING

Take the following precautions when using the Lane Departure Warning System (LDWS):

- ALWAYS check the road conditions. The LDWS does not make the vehicle change lanes or stay in the lanes.
- Do not turn the steering wheel suddenly if the LDWS warns that your vehicle is leaving the lane.
- If the camera cannot detect the lane or if the vehicle speed does not exceed 44 mph (70 km/h), the LDWS will not be able to notify you if the vehicle leaves the lane.
- If your vehicle has window tint or other types of coating and accessory on the front windshield, the LDWS may not work properly.

(Continued)

(Continued)

- Do not allow any water or liquid to contact the LDWS camera or the camera may be damaged.
- Do not remove the LDWS parts and do not damage the camera by a strong impact.
- Do not put objects that reflect light on the dash board.
- The operation of the LDWS can be affected by several factors (including environmental conditions). It is the responsibility of the driver to pay attention to the roadway and to maintain the vehicle in its lane at all times.

LDWS Operation

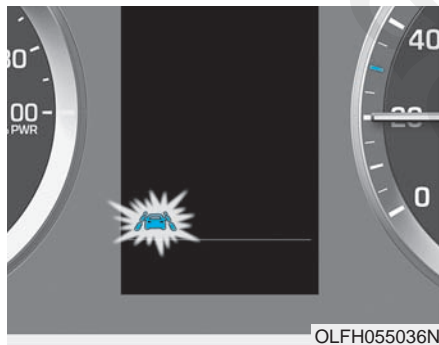

To operate:

Press the LDWS button with the Engine Start/Stop button in the ON position. The indicator (white) illuminates on the cluster.

To cancel:

Press the LDWS button again. The indicator on the cluster will go off.

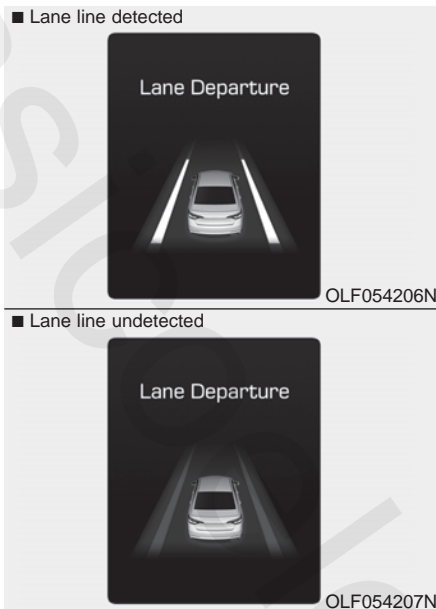

If the vehicle leaves the lane when the LDWS is operating and vehicle speed exceeds 44mph (70km/h), the warning operates as follows:

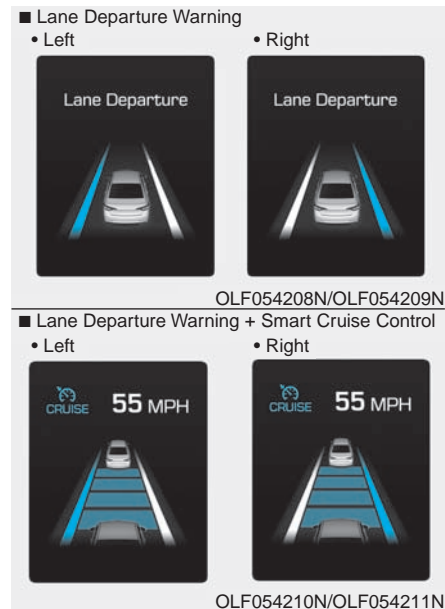

1. Visual warning

If you leave the lane, the lane line you leave on the LCD display blinks yellow.

2. Audible warning

If you leave the lane, the warning sound operates.

Warning Light and Message

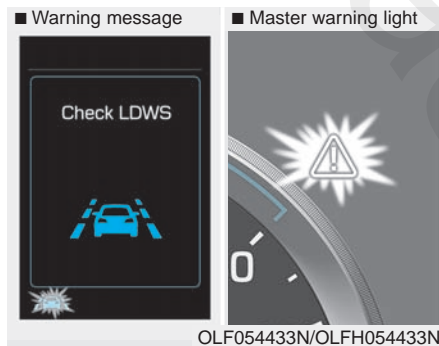

When the LDWS is not working properly, the warning light will illuminate and the warning message will come on for a few seconds. After the message disappears, the master warning light will illuminate.

Take your vehicle to an authorized HYUNDAI dealer and have the system checked.

The LDWS does not operate when:

- The driver turns on the turn signal to change lanes or operates the hazard warning flasher.
- Driving on the lane line.

i Information

Always operate the turn signal before changing lanes.

DRIVER'S ATTENTION

The LDWS may not warn you even if the vehicle leaves the lane, or may warn you even if the vehicle does not leave the lane when:

- The lane is not visible due to snow, rain, stain, a puddle or other factors.
- The brightness outside changes suddenly such as when entering or exiting a tunnel.
- The headlamps are not on at night or in a tunnel, or light level is low.
- It is difficult to distinguish the color of the lane marking from the road or the lane line is damaged or indistinct.
- Driving on a steep grade or a curve.
- Light such as street light, sunlight or oncoming vehicle light reflects from the water on the road.
- The lens or windshield is covered with foreign matter.

(Continued)

(Continued)

- The camera cannot detect the lane because of fog, heavy rain, or heavy snow.
- The surrounding of the inside rear view mirror temperature is high due to direct sun light.
- The lane is very wide or narrow.
- The windshield is fogged by humid air in the vehicle.
- A shadow is on the lane line.
- There is a mark that looks like a lane line.
- There is a boundary structure, such as a concrete barrier.
- The distance from the vehicle ahead is very short or the vehicle ahead drives covering the lane line.
- The vehicle vibrates heavily due to road conditions.
- The number of lanes increases or decreases or the lane lines are crossing.
- Putting something on the dashboard.

(Continued)

(Continued)

- Driving with the sun in front of you.
- Driving in areas under construction.
- There are more than two lane lines.

BLIND SPOT DETECTION SYSTEM (BSD) (IF EQUIPPED)

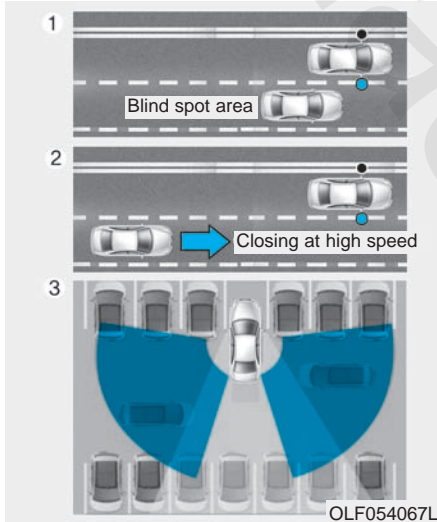

The Blind Spot Detection System (BSD) uses a radar sensor to alert the driver.

It monitors the rear area of the vehicle and provides information to the driver.

(1) BSD (Blind Spot Detection)

The detection range varies in accordance with a driving speed. When your vehicle is faster than the other vehicles, the system will not warn you.

(2) LCA (Lane Change Assist)

When a vehicle approaches you at a high speed, the system will warn you.

(3) RCTA (Rear Cross Traffic Alert)

When your vehicle moves backwards, and when the sensor detects the approaching vehicle in the left and right side, the system will warn you.

⚠ WARNING

- Always check the road condition while driving for unexpected situations even though the Blind Spot Detection System (BSD) is operating.
- The Blind Spot Detection System (BSD) is a supplemental system to assist you. Do not entirely rely on the system. Always pay attention, while driving, for your safety.
- The Blind Spot Detection System (BSD) is not a substitute for proper and safe driving. Always drive safely and use caution when changing lanes or backing the vehicle up. The Blind Spot Detection System (BSD) may not detect every object alongside the vehicle.

BSD (Blind Spot Detection) / LCA (Lane Change Assist)

Operating conditions

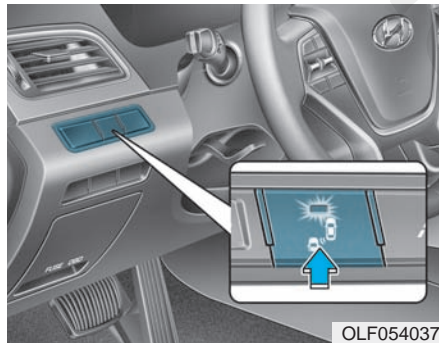

To operate:

Press the BSD switch with the Engine Start/Stop button in the ON position.

The indicator illuminates on the switch. If vehicle speed exceeds 20 mph (30km/h) the system will activate.

To cancel:

Press the BSD switch again. The indicator on the switch will go off.

When the system is not used, turn the system off by turning off the switch.

i Information

- If the Engine Start/Stop button is pressed OFF and then ON again, the BSD system returns to the previous state.
- When the system is turned on, the warning light will illuminate for 3 seconds on the outside rearview mirror.

Warning type

The system will activate when:

1. The system is on.
2. The vehicle speed is above about 20 mph (30 km/h).
3. Vehicles behind are detected.

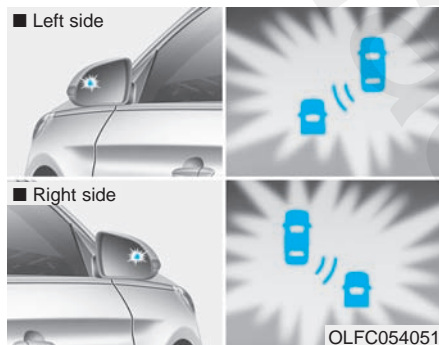

First stage alert

If a vehicle is detected within the boundary of the system, a warning light will illuminate on the outside rearview mirror.

If the detected vehicle is not in warning range, the warning will turn off according to driving conditions.



Second stage alert

The second stage alarm will activate when:

1. The first stage alert is on.
2. The turn signal light is on to change a lane.

When the second stage alert is activated, a warning light will blink on the outside rearview mirror.

If you turn off the turn signal light, the second stage alert will be deactivated.

Detecting sensor



The sensors are located inside the rear bumper.

Always keep the rear bumper clean for the proper operation of the system.

Warning message

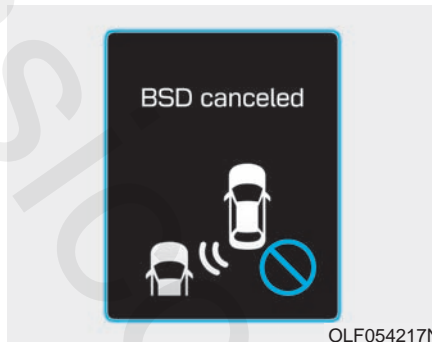

- This warning message may appear when :
 - There are foreign substances on the rear bumper
 - Driving in rural areas with little traffic or open terrains such as wide expanse of desert
 - There is heavy snow or rain

The light on the switch and the system will turn off automatically.

When the message is displayed due to a foreign substance, remove the foreign substance on the rear bumper. After the foreign substance is removed, if you drive for approximately 10 minutes, the system will work normally.

If the system does not operate normally after removing the substance or is not in a situation mentioned above, Take your vehicle to an authorized HYUNDAI dealer and have the system checked.

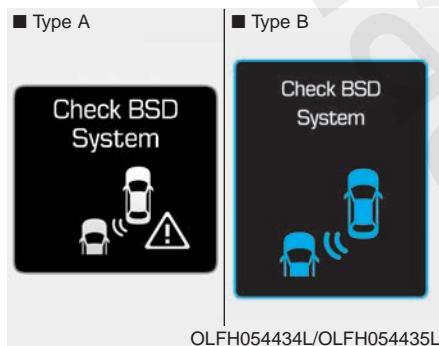

If there is a problem with the BSD system, a warning message will appear and the light on the switch will turn off. The system will turn off automatically. Have your vehicle inspected by an authorized HYUNDAI dealer.

RCTA (Rear Cross Traffic Alert)

When your vehicle starts to move backwards after parking, the sensor detects any approaching vehicles from the left and right sides and warns the driver.

Operating conditions

To operate:

Go to the User Settings Mode (Driving Assist) and select RCTA (Rear Cross Traffic Alert) on the LCD display (**For more information, refer to "LCD Display" in chapter 3.**). The system will turn on and standby to activate. The system will activate when vehicle speed is below 6 mph (10 km/h) with the shift lever in R (Reverse).

i Information

The RCTA (Rear Cross Traffic Alert) detecting range is about 1 feet ~ 65 feet (0.5 m ~ 20 m). A vehicle will be detected if the vehicle speed is 2.5 mph ~ 22.4 mph (4km/h ~ 36km/h) within the detecting range. However, the detecting range may change under different conditions. Always pay attention to the surroundings.

Warning type

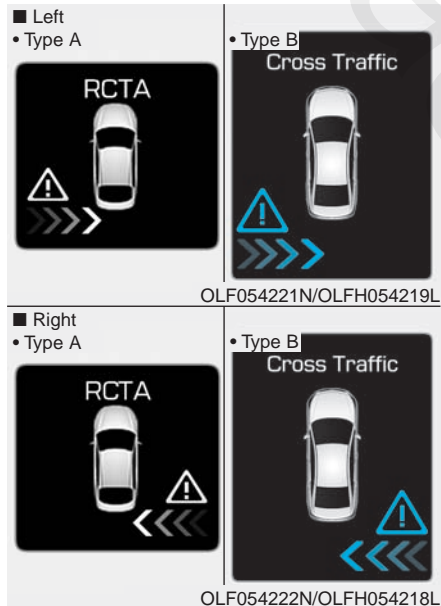

If the vehicle detected by the sensors approaches your vehicle, the warning chime will sound, the warning light on the outside rearview mirror will blink and a message will appear on the LCD display.

Information

- If the detected vehicle is out of the sensing range of your vehicle, move the vehicle away from the detected object slowly; the warning will be cancelled.
- The system may not operate properly due to other factors or circumstances. Always pay attention to your surroundings.
- If your vehicle's left or right side bumper is blinded by barrier or vehicles, the system sensing ability may be reduced.

WARNING

- The warning light on the outside rearview mirror will illuminate whenever a vehicle is detected at the rear side by the system.

To avoid accidents, do not focus only on the warning light and neglect to see the surrounding of the vehicle.

- Drive safely even though the vehicle is equipped with a Blind Spot Detection System (BSD) and Rear Cross Traffic Alert (RCTA). Do not solely rely on the system but check your surrounding before changing lanes or backing the vehicle up.

The system may not alert the driver in some conditions so always check the surroundings while driving.

(Continued)

(Continued)

- The Blind Spot Detection System (BSD) and Rear Cross Traffic Alert (RCTA) are not a substitute for proper and safe driving practices. Always drive safely and use caution when changing lanes or backing the vehicles up. The Blind Spot Detection System (BSD) may not detect every object alongside the vehicle.

NOTICE

- The system may not properly operate, when the bumper is replaced, or when a repair work is done near the sensor.
- The sensing range differs according to the roads width. When the road is narrow, the system may detect other vehicles in the next lane.
- The system may turn off due to strong electromagnetic waves.

Non-operating condition

Outside rearview mirror may not alert the driver when:

- The outside rearview mirror housing is damaged or covered with debris.
- The window is covered with debris.
- The windows are severely tinted.

DRIVER'S ATTENTION

The driver must be cautious in the below situations, because the system may not detect other vehicles or objects in certain circumstances.

- The vehicle drives on a curved road or through a tollgate.
- The sensor is polluted with rain, snow, mud, etc.
- The rear bumper, in which the sensor is located, is covered or blocked with a foreign matter such as a sticker, a bumper guard, a bicycle stand, etc.
- The rear bumper is damaged, or the sensor is out of the original default position.
- The vehicle height gets lower or higher due to heavy loading in a trunk, abnormal tire pressure, etc.
- The vehicle drives in a bad weather such as heavy rain or snow.
- There is a fixed object near the vehicle, such as a guardrail.

(Continued)

(Continued)

- A big vehicle is near such as a bus or truck.
- A motorcycle or bicycle is near.
- A flat trailer is near.
- If the vehicle has started at the same time as the vehicle next to you and has accelerated.
- When the other vehicle passes at a very fast speed.
- While changing lanes.
- While going down or up a steep road where the height of the lane is different.
- When the other vehicle approaches very close.
- When a trailer or carrier is installed.
- When the temperature of the rear bumper is high.
- When the sensors are blocked by the other vehicles, walls or parking-lot pillars.
- When the detected vehicle also moves back, as your vehicle drives back.

(Continued)

(Continued)

- If there are small things like shopping cart and baby carriage.
- If there is low height vehicle like sport vehicle.
- When other vehicles are close to your vehicle
- When the vehicle in the next lane moves two lanes away from you OR when the vehicle two lanes away moves to the next lane from you.
- When driving through a narrow road with many trees or bushes.

Information

This device complies with Part 15 of the FCC rules.

Operation is subject to the following two conditions:

1. This device may not cause harmful interference, and
2. This device must accept any interference received, including interference that may cause undesired operation.

SPECIAL DRIVING CONDITIONS

Hazardous driving conditions

When hazardous driving elements are encountered such as water, snow, ice, mud and sand, take the below suggestions:

- Drive cautiously and keep a longer braking distance.
- Avoid abrupt braking or steering.
- When your vehicle is stuck in snow, mud, or sand, use the second gear. Accelerate slowly to avoid unnecessary wheel spinning.
- Put sand, rock salt, tire chains or other non-slip materials under the wheels to provide additional traction while being stuck in ice, snow, or mud.

WARNING

Downshifting with an automatic transaxle while driving on slippery surfaces can cause an accident. The sudden change in tire speed could cause the tires to skid. Be careful when downshifting on slippery surfaces.

Rocking the vehicle

If it is necessary to rock the vehicle to free it from snow, sand, or mud, first turn the steering wheel right and left to clear the area around your front wheels. Then, shift back and forth between R (Reverse) and a forward gear.

Try to avoid spinning the wheels, and do not race the engine.

To prevent transaxle wear, wait until the wheels stop spinning before shifting gears. Release the accelerator pedal while shifting, and press lightly on the accelerator pedal while the transaxle is in gear. Slowly spinning the wheels in forward and reverse directions causes a rocking motion that may free the vehicle.

WARNING

If the tires spin at high speed the tires can explode, and you or others may be injured. Do not attempt this procedure if people or objects are anywhere near the vehicle.

The vehicle can overheat causing an engine compartment fire or other damage. Spin the wheels as little as possible and avoid spinning the wheels at speeds over 35 mph (56 km/h) as indicated on the speedometer.

i Information

The ESC system must be turned OFF before rocking the vehicle.

NOTICE

If you are still stuck after rocking the vehicle a few times, have the vehicle pulled out by a tow vehicle to avoid engine overheating, possible damage to the transaxle, and tire damage. See "Towing" in chapter 6.

Smooth cornering

Avoid braking or gear changing in corners, especially when roads are wet. Ideally, corners should always be taken under gentle acceleration.

Driving at night

Night driving presents more hazards than driving in the daylight. Here are some important tips to remember:

- Slow down and keep more distance between you and other vehicles, as it may be more difficult to see at night, especially in areas where there may not be any street lights.
- Adjust your mirrors to reduce the glare from other driver's headlamps.
- Keep your headlamps clean and properly aimed. Dirty or improperly aimed headlamps will make it much more difficult to see at night.
- Avoid staring directly at the headlamps of oncoming vehicles. You could be temporarily blinded, and it will take several seconds for your eyes to readjust to the darkness.

Driving in the rain

Rain and wet roads can make driving dangerous. Here are a few things to consider when driving in the rain or on slick pavement:

- Slow down and allow extra following distance. A heavy rainfall makes it harder to see and increases the distance needed to stop your vehicle.
- Turn OFF your Cruise Control.
- Replace your windshield wiper blades when they show signs of streaking or missing areas on the windshield.
- Be sure your tires have enough tread. If your tires do not have enough tread, making a quick stop on wet pavement can cause a skid and possibly lead to an accident. **See "Tire Tread" in chapter 7.**
- Turn on your headlamps to make it easier for others to see you.
- Driving too fast through large puddles can affect your brakes. If you must go through puddles, try to drive through them slowly.

- If you believe your brakes may be wet, apply them lightly while driving until normal braking operation returns.

Hydroplaning

If the road is wet enough and you are going fast enough, your vehicle may have little or no contact with the road surface and actually ride on the water. The best advice is SLOW DOWN when the road is wet.

The risk of hydroplaning increases as the depth of tire tread decreases, refer to "Tire Tread" in chapter 7.

Driving in flooded areas

Avoid driving through flooded areas unless you are sure the water is no higher than the bottom of the wheel hub. Drive through any water slowly. Allow adequate stopping distance because brake performance may be reduced.

After driving through water, dry the brakes by gently applying them several times while the vehicle is moving slowly.

Highway driving

Tires

Adjust the tire inflation, as specified. Under-inflation may overheat or damage the tires.

Do not install worn-out or damaged tires, which may reduce traction or fail the braking operation.

i Information

Never over-inflate your tires above the maximum inflation pressure, as specified on your tires.

Fuel, engine coolant and engine oil

Driving at a high speed consumes more fuel than driving at a slow speed, such as in an urban area. Do not forget to check both the engine coolant and engine oil.

Drive belt

A loose or damaged drive belt may overheat the engine.

WINTER DRIVING

The severe weather conditions of winter quickly wear out tires and cause other problems. To minimize winter driving problems, you should take the following suggestions:

Snow or icy conditions

You need to keep sufficient distance between your vehicle and the vehicle in front of you.

Apply the brakes gently. Speeding, rapid acceleration, sudden brake applications, and sharp turns are potentially very hazardous practices. During deceleration, use engine braking to the fullest extent. Sudden brake applications on snowy or icy roads may cause skids to occur.

To drive your vehicle in deep snow, it may be necessary to use snow tires or to install tire chains on your tires.

Always carry emergency equipment. Some of the items you may want to carry include tire chains, tow straps or chains, a flashlight, emergency flares, sand, a shovel, jumper cables, a window scraper, gloves, ground cloth, coveralls, a blanket, etc.

Snow tires

WARNING

Snow tires should be equivalent in size and type to the vehicle's standard tires. Otherwise, the safety and handling of your vehicle may be adversely affected.

If you mount snow tires on your vehicle, make sure to use radial tires of the same size and load range as the original tires. Mount snow tires on all four wheels to balance your vehicle's handling in all weather conditions. The traction provided by snow tires on dry roads may not be as high as your vehicle's original equipment tires. Check with the tire dealer for maximum speed recommendations.

Information

Do not install studded tires without first checking local, state and municipal regulations for possible restrictions against their use.

Tire chains



Since the sidewalls of radial tires are thinner than other types of tires, they may be damaged by mounting some types of tire chains on them. Therefore, the use of snow tires is recommended instead of tire chains. Do not mount tire chains on vehicles equipped with aluminum wheels; if unavoidable use a wire type chain. If tire chains must be used, use genuine HYUNDAI parts and install the tire chain after reviewing the instructions provided with the tire chains. Damage to your vehicle caused by improper tire chain use is not covered by your vehicle manufacturer's warranty.

WARNING

The use of tire chains may adversely affect vehicle handling:

- Drive less than 20 mph (30 km/h) or the chain manufacturer's recommended speed limit, whichever is lower.
- Drive carefully and avoid bumps, holes, sharp turns, and other road hazards, which may cause the vehicle to bounce.
- Avoid sharp turns or locked wheel braking.

Information

- Install tire chains on the front tires. It should be noted that installing tire chains on the tires will provide a greater driving force, but will not prevent side skids.
- Do not install studded tires without first checking local, state and municipal regulations for possible restrictions against their use.

Chain Installation

When installing tire chains, follow the manufacturer's instructions and mount them as tightly possible. Drive slowly (less than 20 mph (30 km/h)) with chains installed. If you hear the chains contacting the body or chassis, stop and tighten them. If they still make contact, slow down until the noise stops. Remove the tire chains as soon as you begin driving on cleared roads.

When mounting snow chains, park the vehicle on level ground away from traffic. Turn on the vehicle Hazard Warning Flasher and place a triangular emergency warning device behind the vehicle (if available). Always place the vehicle in P (Park), apply the parking brake and turn off the engine before installing snow chains.

NOTICE

When using tire chains:

- **Wrong size chains or improperly installed chains can damage your vehicle's brake lines, suspension, body and wheels.**
- **Use SAE "S" class or wire chains.**
- **If you hear noise caused by chains contacting the body, retighten the chain to prevent contact with the vehicle body.**
- **To prevent body damage, retighten the chains after driving 0.3~0.6 miles (0.5~1.0 km).**
- **Do not use tire chains on vehicles equipped with aluminum wheels. If unavoidable, use a wire type chain.**
- **Use wire chains less than 0.47 in (12 mm) wide to prevent damage to the chain's connection.**

Winter Precautions

Use high quality ethylene glycol coolant

Your vehicle is delivered with high quality ethylene glycol coolant in the cooling system. It is the only type of coolant that should be used because it helps prevent corrosion in the cooling system, lubricates the water pump and prevents freezing. Be sure to replace or replenish your coolant in accordance with the maintenance schedule in section 7. Before winter, have your coolant tested to assure that its freezing point is sufficient for the temperatures anticipated during the winter.

Check battery and cables

The winter temperature increases the battery consumption. **Inspect the battery and cables, as specified in the chapter 7.** The battery charging level can be checked by an authorized HYUNDAI dealer or in a service station.

Change to "winter weight" oil if necessary

In some regions during winter, it is recommended to use the "winter weight" oil with lower viscosity. For further information, refer to the chapter 8. When you are not sure about a type of winter weight oil, consult an authorized HYUNDAI dealer.

Check spark plugs and ignition system

Inspect the spark plugs, as specified in the chapter 7. If necessary, replace them. Also check all ignition wirings and components for any cracks, wear-out, and damage.

To prevent locks from freezing

To prevent the locks from being frozen, spray approved de-icing fluid or glycerin into key holes. When a lock opening is already covered with ice, spray approved de-icing fluid over the ice to remove it. When an internal part of a lock freezes, try to thaw it with a heated key. Carefully use the heated key to avoid an injury.

Use approved window washer anti-freeze solution in system

To prevent the window washer from being frozen, add authorized window washer anti-freeze solution, as specified on the window washer container. Window washer anti-freeze solution is available from an authorized HYUNDAI dealer, and so are the most vehicle accessory outlets. Do not use engine coolant or other types of anti-freeze solution to prevent any damage to the vehicle paint.

Do not let your parking brake freeze

Under some conditions your parking brake can freeze in the engaged position. This is most likely to happen when there is an accumulation of snow or ice around or near the rear brakes or if the brakes are wet.

When there is the risk that your parking brake may freeze, temporarily apply it with the shift lever in P (Park). Also, block the rear wheels in advance, so the vehicle may not roll. Then, release the parking brake.

Do not let ice and snow accumulate underneath

Under some conditions, snow and ice can build up under the fenders and interfere with the steering. When driving in such conditions during the severe winter, you should check underneath the vehicle on a regular basis, so that moving the front wheels and the steering components is unblocked.

Carry emergency equipment

In accordance with weather conditions, you should carry appropriate emergency equipment, while driving.

Some of the items you may want to carry include tire chains, tow straps or chains, flashlight, emergency flares, sand, shovel, jumper cables, window scraper, gloves, ground cloth, coveralls, blanket, etc.

Do not place objects or materials in the engine compartment

Putting objects or materials in the engine compartment may cause an engine failure or combustion, because those may block the engine cooling. Such damage will not be covered by the manufacturer's warranty.

VEHICLE LOAD LIMIT

Two labels on your driver's door sill show how much weight your vehicle was designed to carry: the Tire and Loading Information Label and the Certification Label.

Before loading your vehicle, familiarize yourself with the following terms for determining your vehicle's weight ratings, from the vehicle's specifications and the Certification Label:

Base Curb Weight

This is the weight of the vehicle including a full tank of fuel and all standard equipment. It does not include passengers, cargo, or optional equipment.

Vehicle Curb Weight

This is the weight of your new vehicle when you picked it up from your dealer plus any aftermarket equipment.

Cargo Weight

This figure includes all weight added to the Base Curb Weight, including cargo and optional equipment.

GAW (Gross Axle Weight)

This is the total weight placed on each axle (front and rear) - including vehicle curb weight and all payload.

GAWR (Gross Axle Weight Rating)

This is the maximum allowable weight that can be carried by a single axle (front or rear). These numbers are shown on the Certification Label. The total load on each axle must never exceed its GAWR.

GVW (Gross Vehicle Weight)

This is the Base Curb Weight plus actual Cargo Weight plus passengers.

GVWR (Gross Vehicle Weight Rating)

This is the maximum allowable weight of the fully loaded vehicle (including all options, equipment, passengers and cargo). The GVWR is shown on the Certification Label located on the driver's door sill.

Tire loading information label

■ Type A

TIRE AND LOADING INFORMATION RENSEIGNEMENTS SUR LES PNEUS ET LE CHARGEMENT				
SEATING CAPACITY NOMBRE DE PLACES		TOTAL 5	FRONT 2 AVANT	REAR 3 ARRIÈRE
The combined weight of occupants and cargo should never exceed 410 kg or 904 lbs. Le poids total des occupants et du chargement ne doit jamais dépasser				
TIRE PNEU	SIZE DIMENSIONS	COLD TIRE PRESSURE PRESSION DES PNEUS À FROID	SEE OWNER'S MANUAL FOR ADDITIONAL INFORMATION VOIR LE MANUEL DE L'USAGER POUR PLUS DE RENSEIGNEMENTS	
FRONT AVANT	205/65R16	240kPa, 35psi		
REAR ARRIÈRE	205/65R16	240kPa, 35psi		
SPARE DE SECOURS		NONE AUCUN		

■ Type B

TIRE AND LOADING INFORMATION RENSEIGNEMENTS SUR LES PNEUS ET LE CHARGEMENT				
SEATING CAPACITY NOMBRE DE PLACES		TOTAL 5	FRONT 2 AVANT	REAR 3 ARRIÈRE
The combined weight of occupants and cargo should never exceed 410 kg or 904 lbs. Le poids total des occupants et du chargement ne doit jamais dépasser				
TIRE PNEU	SIZE DIMENSIONS	COLD TIRE PRESSURE PRESSION DES PNEUS À FROID	SEE OWNER'S MANUAL FOR ADDITIONAL INFORMATION VOIR LE MANUEL DE L'USAGER POUR PLUS DE RENSEIGNEMENTS	
FRONT AVANT	215/55R17	240kPa, 35psi		
REAR ARRIÈRE	215/55R17	240kPa, 35psi		
SPARE DE SECOURS		NONE AUCUN		

OLFH054451/OLFH054452

The label located on the driver's door sill gives the original tire size, cold tire pressures recommended for your vehicle, the number of people that can be in your vehicle and vehicle capacity weight.

Vehicle capacity weight

904 lbs. (410 kg)

Vehicle capacity weight is the maximum combined weight of occupants and cargo. If your vehicle is equipped with a trailer, the combined weight includes the tongue load.

Seating capacity

Total : 5 persons

(Front seat : 2 persons,
Rear seat : 3 persons)

Seating capacity is the maximum number of occupants including a driver, your vehicle may carry. However, the seating capacity may be reduced based upon the weight of all of the occupants, and the weight of the cargo being carried or towed. Do not overload the vehicle as there is a limit to the total weight, or load limit including occupants and cargo, the vehicle can carry.

Towing capacity

We do not recommend using this vehicle for trailer towing.

Cargo capacity







The cargo capacity of your vehicle will increase or decrease depending on the weight and the number of occupants and the tongue load, if your vehicle is equipped with a trailer.

Steps for determining correct load limit

1. Locate the statement "The combined weight of occupants and cargo should never exceed XXX kg or XXX lbs." on your vehicle's placard.
2. Determine the combined weight of the driver and passengers that will be riding in your vehicle.
3. Subtract the combined weight of the driver and passengers from XXX kg or XXX lbs.
4. The resulting figure equals the available amount of cargo and luggage load capacity. For example, if the "XXX" amount equals 1400 lbs. and there will be five 150 lb. passengers in your vehicle, the amount of available cargo and luggage load capacity is 650 lbs. (1400 - 750 (5 x 150) = 650 lbs.)
5. Determine the combined weight of luggage and cargo being loaded on the vehicle. That weight may not safely exceed the available cargo and luggage load capacity calculated in Step 4.
6. If your vehicle will be towing a trailer, load from your trailer will be transferred to your vehicle. Consult this manual to determine how this reduces the available cargo and luggage load capacity of your vehicle.

⚠ WARNING

Do not overload the vehicle as there is a limit to the total weight, or load limit, including occupants and cargo, the vehicle can carry. Overloading can shorten the life of the vehicle. If the GVWR or the GAWR is exceeded, parts on the vehicle can break, and it can change the handling of your vehicle. These could cause you to lose control and result in an accident.

<p>Example 1</p>	<div style="display: flex; align-items: center; justify-content: center;"> <div style="background-color: black; color: white; padding: 10px; margin-right: 20px;">Vehicle Capacity</div> ≥ <div style="display: flex; align-items: center; margin-right: 20px;">  </div> + <div style="display: flex; align-items: center;">  </div> </div> <div style="display: flex; justify-content: space-around; margin-top: 10px;"> <div style="text-align: center;"> <p>Maximum Load (1400 lbs.) (635 kg)</p> </div> <div style="text-align: center;"> <p>Passenger Weight (150 lbs. × 2 = 300 lbs.) (68 kg × 2 = 136 kg)</p> </div> <div style="text-align: center;"> <p>Cargo Weight (1100 lbs.) (499 kg)</p> </div> </div>
<p>Example 2</p>	<div style="display: flex; align-items: center; justify-content: center;"> <div style="background-color: black; color: white; padding: 10px; margin-right: 20px;">Vehicle Capacity</div> ≥ <div style="display: flex; align-items: center; margin-right: 20px;">  </div> + <div style="display: flex; align-items: center;">  </div> </div> <div style="display: flex; justify-content: space-around; margin-top: 10px;"> <div style="text-align: center;"> <p>Maximum Load (1400 lbs.) (635 kg)</p> </div> <div style="text-align: center;"> <p>Passenger Weight (150 lbs. × 5 = 750 lbs.) (68 kg × 5 = 340 kg)</p> </div> <div style="text-align: center;"> <p>Cargo Weight (650 lbs.) (295 kg)</p> </div> </div>
<p>Example 3</p>	<div style="display: flex; align-items: center; justify-content: center;"> <div style="background-color: black; color: white; padding: 10px; margin-right: 20px;">Vehicle Capacity</div> ≥ <div style="display: flex; align-items: center; margin-right: 20px;">  </div> + <div style="display: flex; align-items: center;">  </div> </div> <div style="display: flex; justify-content: space-around; margin-top: 10px;"> <div style="text-align: center;"> <p>Maximum Load (1400 lbs.) (635 kg)</p> </div> <div style="text-align: center;"> <p>Passenger Weight (172 lbs. × 5 = 860 lbs.) (78 kg × 5 = 390 kg)</p> </div> <div style="text-align: center;"> <p>Cargo Weight (540 lbs.) (245 kg)</p> </div> </div>

Certification label

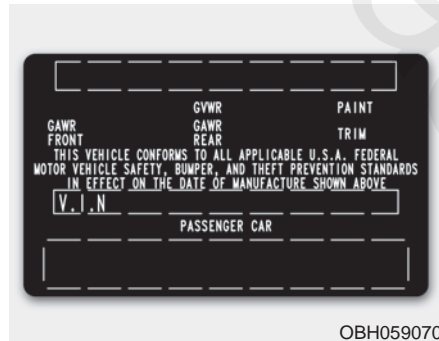

The certification label is located on the driver's door sill at the center pillar and shows the maximum allowable weight of the fully loaded vehicle. This is called the GVWR (Gross Vehicle Weight Rating). The GVWR includes the weight of the vehicle, all occupants, fuel and cargo.

This label also tells you the maximum weight that can be supported by the front and rear axles, called Gross Axle Weight Rating (GAWR).

The total weight of the vehicle, including all occupants, accessories, cargo, and trailer tongue load must not exceed the Gross Vehicle Weight Rating (GVWR) or the Gross Axle Weight Rating (GAWR). To find out the actual loads on your front and rear axles, you need to go to a weigh station and weigh your vehicle. Be sure to spread out your load equally on both sides of the centerline.

WARNING

Overloading

- Never exceed the GVWR for your vehicle, the GAWR for either the front or rear axle and vehicle capacity weight. Exceeding these ratings can affect your vehicle's handling and braking ability, and cause an accident.
- Do not overload your vehicle. Overloading your vehicle can cause heat buildup in your vehicle's tires and possible tire failure, increased stopping distances and poor vehicle handling—all of which may result in a crash.

NOTICE

Overloading your vehicle may cause damage. Repairs would not be covered by your warranty. Do not overload your vehicle.

! WARNING

If you carry items inside your vehicle (e.g., suitcases, tools, packages, or anything else), they are moving as fast as the vehicle. If you have to stop or turn quickly, or if there is a crash, the items will keep going and can cause an injury if they strike the driver or a passenger.

- Put items in the cargo area of your vehicle. Try to spread the weight evenly.
- Do not stack items, like suitcases, inside the vehicle above the tops of the seats.
- Do not leave an unsecured child restraint in your vehicle.
- When you carry something inside the vehicle, secure it.

TRAILER TOWING

We do not recommend using this vehicle for trailer towing.

What to do in an emergency

In case of an emergency while driving	6-2	Towing	6-22
Hazard warning flasher	6-2	Towing service	6-22
If the vehicle stalls while driving.....	6-2	Removable towing hook	6-23
If the vehicle stalls at a crossroad or crossing.....	6-2	Emergency Towing.....	6-24
If the vehicle will not start.....	6-3	If an accident occurs.....	6-26
If you have a flat tire while driving.....	6-3		
If the engine turns over normally but doesn't start.....	6-3		
Jump starting	6-4		
If the engine overheats	6-7		
Tire Pressure Monitoring System (TPMS).....	6-9		
Check tire pressure.....	6-9		
Tire pressure monitoring system	6-10		
Low tire pressure telltale	6-11		
Low tire pressure position and tire pressure telltale	6-11		
TPMS (Tire Pressure Monitoring System) malfunction indicator	6-12		
Changing a tire with TPMS.....	6-13		
If you have a flat tire.....	6-15		
With Tire Mobility Kit (TMK).....	6-15		

HAZARD WARNING FLASHER

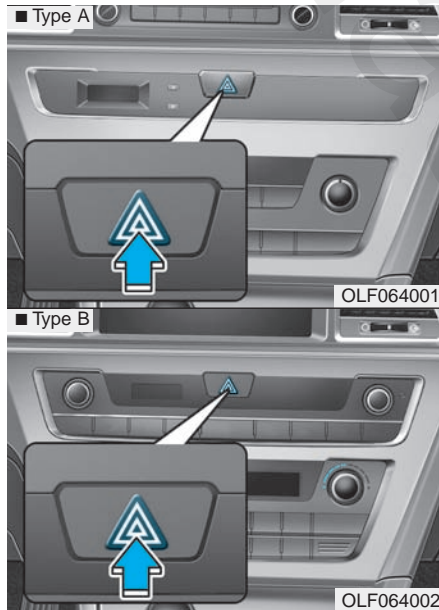

The hazard warning flasher serves as a warning to other drivers to exercise extreme caution when approaching, overtaking, or passing your vehicle.

It should be used whenever emergency repairs are being made or when the vehicle is stopped near the edge of a roadway.

To turn the hazard warning flasher on or off, press the hazard warning flasher button with the ignition switch in any position. The button is located in the center fascia panel. All turn signal lights will flash simultaneously.

- The hazard warning flasher operates whether your vehicle is running or not.
- The turn signals do not work when the hazard flasher is on.

IN CASE OF AN EMERGENCY WHILE DRIVING

If the vehicle stalls while driving

- Reduce your speed gradually, keeping a straight line. Move cautiously off the road to a safe place.
- Turn on your hazard warning flasher.
- Try to start the hybrid system again. If your vehicle will not start, contact an authorized HYUNDAI dealer or seek other qualified assistance.

If the vehicle stalls at a cross-road or crossing

If the vehicle stalls at a crossroad or crossing, if safe to do so, move the shift lever to the N (Neutral) position and then push the vehicle to a safe location.

If you have a flat tire while driving

If a tire goes flat while you are driving:

- Take your foot off the accelerator pedal and let the vehicle slow down while driving straight ahead. Do not apply the brakes immediately or attempt to pull off the road as this may cause loss of vehicle control resulting in an accident. When the vehicle has slowed to such a speed that it is safe to do so, brake carefully and pull off the road. Drive off the road as far as possible and park on firm, level ground. If you are on a divided highway, do not park in the median area between the two traffic lanes.
- When the vehicle is stopped, press the hazard warning flasher button, move the shift lever into P(Park), and apply the parking brake, and place the Engine Start/Stop button in the OFF position.
- Have all passengers get out of the vehicle. Be sure they all get out on the side of the vehicle that is away from traffic.
- When changing a flat tire, follow the instructions provided later in this chapter.

IF THE VEHICLE WILL NOT START

- Be sure the shift lever is in P (Park). The vehicle starts only when the shift lever is in P (Park).
- Check the battery connections to be sure they are clean and tight.
- Turn on the interior light. If the light dims or goes out when you operate the starter, the battery is drained.

Do not push or pull the vehicle to start it. This could cause damage to your vehicle. See instructions for "Jump Starting" provided in this chapter.

CAUTION

Push or pull starting the vehicle may cause the catalytic converter to overload which can lead to damage to the emission control system.

If the engine turns over normally but doesn't start

Check the fuel level and add fuel if necessary.

If the engine still does not start, have your vehicle checked by an authorized HYUNDAI dealer.

JUMP STARTING

Jump starting can be dangerous if done incorrectly. Follow the jump starting procedure in this section to avoid serious injury or damage to your vehicle. If in doubt about how to properly jump start your vehicle, we strongly recommend that you have a service technician or towing service do it for you.

WARNING

To prevent **SERIOUS INJURY** or **DEATH** to you or bystanders, always follow these precautions when working near or handling the battery:



Always read and follow instructions carefully when handling a battery.



Wear eye protection designed to protect the eyes from acid splashes.



Keep all flames, sparks, or smoking materials away from the battery.



Hydrogen is always present in battery cells, is highly combustible, and may explode if ignited.



Keep batteries out of reach of children.

(Continued)

(Continued)



Batteries contain sulfuric acid which is highly corrosive. Do not allow acid to contact your eyes, skin or clothing.

If acid gets into your eyes, flush your eyes with clean water for at least 15 minutes and get immediate medical attention. If acid gets on your skin, thoroughly wash the area. If you feel pain or a burning sensation, get medical attention immediately.

- When lifting a plastic-cased battery, excessive pressure on the case may cause battery acid to leak. Lift with a battery carrier or with your hands on opposite corners.
- Do not attempt to jump start your vehicle if your battery is frozen.

(Continued)

(Continued)

- **NEVER** attempt to recharge the battery when the vehicle's battery cables are connected to the battery.
- The electrical ignition system works with high voltage. **NEVER** touch these components with the engine running or when the ignition switch is in the ON position.

i Information



An inappropriately disposed battery can be harmful to the environment and human health. Dispose the battery according to your local law(s) or regulations.

NOTICE

To prevent damage to your vehicle:

- **Only use a 12-volt power supply (battery or jumper system) to jump start your vehicle.**
- **Do not attempt to jump start your vehicle by push-starting.**

Jump starting procedure

1. Position the vehicles close enough that the jumper cables will reach, but do not allow the vehicles to touch.
2. Avoid fans or any moving parts in the engine compartment at all times, even when the vehicles are turned off.
3. Turn off all electrical devices such as radios, lights, air conditioning, etc. Put the vehicles in P (Park) and set the parking brakes. Turn both vehicles OFF.

i Information

Your vehicle has a battery in the trunk compartment.

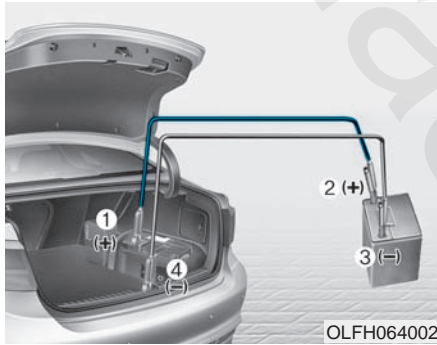

4. Connect the jumper cables in the exact sequence shown in the illustration. First connect one jumper cable to the red, positive (+) jumper terminal of your vehicle (1).
5. Connect the other end of the jumper cable to the red, positive (+) battery/jumper terminal of the assisting vehicle (2).
6. Connect the second jumper cable to the black, negative (-) battery/chassis ground of the assisting vehicle (3).

7. Connect the other end of the second jumper cable to the black, negative (-) chassis ground of your vehicle (4).

Do not allow the jumper cables to contact anything except the correct battery or jumper terminals or the correct ground. Do not lean over the battery when making connections.

8. Start the engine of the assisting vehicle and let it run at approximately 2,000 rpm for a few minutes. Then start your vehicle.

If your vehicle will not start after a few attempts, it probably requires servicing. In this event please seek qualified assistance. If the cause of your battery discharging is not apparent, have your vehicle checked by an authorized HYUNDAI dealer.

Disconnect the jumper cables in the exact reverse order you connected them:



1. Disconnect the jumper cable from the black, negative (-) chassis ground of your vehicle (4).
2. Disconnect the other end of the jumper cable from the black, negative (-) battery/chassis ground of the assisting vehicle (3).
3. Disconnect the second jumper cable from the red, positive (+) battery/jumper terminal of the assisting vehicle (2).
4. Disconnect the other end of the jumper cable from the red, positive (+) jumper terminal of your vehicle (1).

IF THE ENGINE OVERHEATS

If your engine coolant temperature gauge indicates overheating, you experience a loss of power, or hear loud pinging or knocking, the engine may be overheating. If this happens, you should:

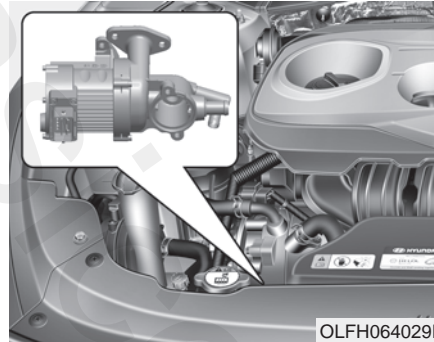
1. Turn ON the hazard warning flasher, pull off the road and stop as soon as it is safe to do so.
2. Place the shift lever in P (Park) and set the parking brake.



3. Make sure that there is no hot steam gushing out of the engine compartment. When it is safe to do so, open the engine compartment, and check the water-pump connector. When the water-pump connector is disconnected, stop the engine, re-connect the water-pump connector, and then re-start the engine.
4. Set the temperature and the air flow to the maximum, and turn ON the air conditioner.
5. When the Service warning light () illuminates on the instrument cluster, immediately stop the engine, and contact an authorized HYUNDAI dealer. When the engine warning light () illuminates, or when the coolant or hot steams gush out of the engine compartment, leave the engine compartment opened, while running the engine. This is to ventilate the engine compartment and to cool down the engine.
6. Check the coolant temperature gauge on the instrument cluster to make sure the coolant temperature is sufficiently cooled down. Check the coolant level. When it is insufficient, check its connection with the radiator, the heater hose, and the water pump for any leakage. When there is no leakage, add the coolant. However, if the problems persists, such as the illumination of the warning lights, leakages, or the cooling-fan malfunction, which may overheat the engine, immediately stop the engine, and have your vehicle checked by an authorized HYUNDAI dealer.

⚠ WARNING



The electric motor for the cooling fan may continue to operate or start up when the engine is not running and can cause serious injury. Keep hands, clothing and tools away from the rotating fan blades of the cooling fan.

⚠ WARNING



Never remove the radiator cap and/or inverter coolant cap or the drain plug while the engine and radiator are hot. Hot coolant and steam may blow out under pressure, causing serious injury.

Turn the engine off and wait until the engine cools down. Use extreme care when removing the radiator cap and/or inverter coolant cap. Wrap a thick towel around it, and turn it counterclockwise slowly to the first stop. Step back while the pressure is released from the cooling system. When you are sure all the pressure has been released, press down on the cap, using a thick towel, and continue turning counterclockwise to remove it.

7. If you cannot find the cause of the overheating, wait until the engine temperature has returned to normal. Then, if coolant has been lost, carefully add coolant to the reservoir to bring the fluid level in the reservoir up to the halfway mark.
8. Proceed with caution, keeping alert for further signs of overheating. If overheating happens again, call an authorized HYUNDAI dealer for assistance.

⚠ CAUTION

Serious loss of coolant indicates a leak in the cooling system and should be checked as soon as possible by an authorized HYUNDAI dealer.

TIRE PRESSURE MONITORING SYSTEM (TPMS)



- (1) Low Tire Pressure Telltale/TPMS Malfunction Indicator
- (2) Low Tire Pressure Position Telltale and Tire Pressure Telltale (Shown on the LCD display)

Check tire pressure

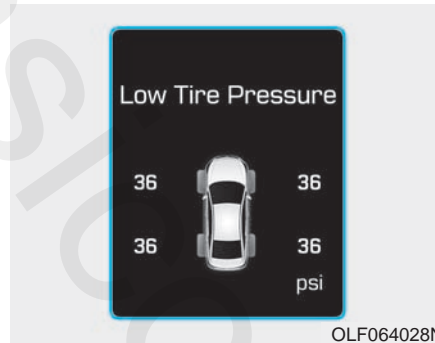

- You can check the tire pressure in the Information Mode on the cluster.

Refer to the "User Settings Mode" section in chapter 3.

- Tire pressure is displayed after a few minutes of driving after initial engine start up.
- If tire pressure is not displayed when the vehicle is stopped, "Drive to display" message will appear. After driving, check the tire pressure.

- The displayed tire pressure values may differ from those measured with a tire pressure gauge.
- You can change the tire pressure unit in the User Settings Mode on the cluster.
 - psi, kpa, bar (**Refer to the "User Settings Mode" section in chapter 3).**)

Tire pressure monitoring system

Each tire, including the spare (if provided), should be checked monthly when cold and inflated to the inflation pressure recommended by the vehicle manufacturer on the vehicle placard or tire inflation pressure label. (If your vehicle has tires of a different size than the size indicated on the vehicle placard or tire inflation pressure label, you should determine the proper tire inflation pressure for those tires.)

As an added safety feature, your vehicle has been equipped with a tire pressure monitoring system (TPMS) that illuminates a low tire pressure telltale when one or more of your tires is significantly under-inflated. Accordingly, when the low tire pressure telltale illuminates, you should stop and check your tires as soon as possible, and inflate them to the proper pressure. Driving on a significantly under-inflated tire causes the tire to overheat and can lead to tire failure.

Under-inflation also reduces fuel efficiency and tire tread life, and may affect the vehicle's handling and stopping ability.

Please note that the TPMS is not a substitute for proper tire maintenance, and it is the driver's responsibility to maintain correct tire pressure, even if under-inflation has not reached the level to trigger illumination of the TPMS low tire pressure telltale.

Your vehicle has also been equipped with a TPMS malfunction indicator to indicate when the system is not operating properly. The TPMS malfunction indicator is combined with the low tire pressure telltale. When the system detects a malfunction, the telltale will flash for approximately one minute and then remain continuously illuminated. This sequence will continue upon subsequent vehicle start-ups as long as the malfunction exists.

When the malfunction indicator is illuminated, the system may not be able to detect or signal low tire pressure as intended. TPMS malfunctions may occur for a variety of reasons, including the installation of replacement or alternate tires or wheels on the vehicle that prevent the TPMS from functioning properly.

Always check the TPMS malfunction telltale after replacing one or more tires or wheels on your vehicle to ensure that the replacement or alternate tires and wheels allow the TPMS to continue to function properly.

NOTICE

If any of the below happens, have the system checked by an authorized HYUNDAI dealer.

1. The Low Tire Pressure Telltale/TPMS Malfunction Indicator does not illuminate for 3 seconds when the ignition switch is placed to the ON position or engine is running.
2. The TPMS Malfunction Indicator remains illuminated after blinking for approximately 1 minute.
3. The Low Tire Pressure Position Telltale remains illuminated.



Low tire pressure telltale

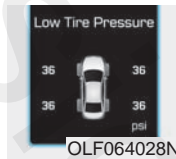

Low tire pressure position and tire pressure telltale

When the tire pressure monitoring system warning indicators are illuminated and warning message displayed on the cluster LCD display, one or more of your tires is significantly under-inflated. The Low Tire Pressure Position Telltale will indicate which tire is significantly under-inflated by illuminating the corresponding position light.

If either telltale illuminates, immediately reduce your speed, avoid hard cornering and anticipate increased stopping distances. You should stop and check your tires as soon as possible. Inflate the tires to the proper pressure as indicated on the vehicle's placard or tire inflation pressure label located on the driver's side center pillar outer panel.

If you cannot reach a service station or if the tire cannot hold the newly added air, replace the low pressure tire with the spare tire.

The Low Tire Pressure Telltale will remain on and the TPMS Malfunction Indicator may blink for one minute and then remain illuminated (when the vehicle is driven approximately 20 minutes at speed above 15.5 mph (25 km/h)) until you have the low pressure tire repaired and replaced on the vehicle.

i Information

The spare tire is not equipped with a tire pressure sensor.

 **CAUTION**

In winter or cold weather, the Low Tire Pressure Telltale may be illuminated if the tire pressure was adjusted to the recommended tire inflation pressure in warm weather. It does not mean your TPMS is malfunctioning because the decreased temperature leads to a proportional lowering of tire pressure.

When you drive your vehicle from a warm area to a cold area or from a cold area to a warm area, or the outside temperature is greatly higher or lower, you should check the tire inflation pressure and adjust the tires to the recommended tire inflation pressure.

 **WARNING**

Low pressure damage

Significantly low tire pressure makes the vehicle unstable and can contribute to loss of vehicle control and increased braking distances.

Continued driving on low pressure tires can cause the tires to overheat and fail.



TPMS (Tire Pressure Monitoring System) malfunction indicator

The TPMS Malfunction Indicator will illuminate after it blinks for approximately one minute when there is a problem with the Tire Pressure Monitoring System.

Have the system checked by an authorized HYUNDAI dealer as soon as possible.

NOTICE

If there is a malfunction with the TPMS, the Low Tire Pressure Position Telltale will not be displayed even though the vehicle has an under-inflated tire.

NOTICE

The TPMS Malfunction Indicator may illuminate after blinking for one minute if the vehicle is near electric power supply cables or radio transmitters such as police stations, government and public offices, broadcasting stations, military installations, airports, transmitting towers, etc.

Additionally, the TPMS Malfunction Indicator may illuminate if snow chains are used or electronic devices such as computers, chargers, remote starters, navigation, etc. This may interfere with normal operation of the TPMS.

Changing a tire with TPMS

If you have a flat tire, the Low Tire Pressure and Position telltales will come on. Have the flat tire repaired by an authorized HYUNDAI dealer as soon as possible or replace the flat tire with the spare tire.

 **CAUTION**

Never use a puncture-repairing agent not approved by HYUNDAI dealer to repair and/or inflate a low pressure tire. Tire sealant not approved by HYUNDAI dealer may damage the tire pressure sensor.

The spare tire (if equipped) does not come with a tire pressure monitoring sensor. When the low pressure tire or the flat tire is replaced with the spare tire, the Low Tire Pressure Telltale will remain on. Also, the TPMS Malfunction Indicator will illuminate after blinking for one minute if the vehicle is driven at speed above 15.5 mph (25 km/h) for approximately 20 minutes.

Once the original tire equipped with a tire pressure monitoring sensor is reinflated to the recommended pressure and reinstalled on the vehicle, the Low Tire Pressure Telltale and TPMS Malfunction Indicator will go off within a few minutes of driving.

If the indicators do not extinguish after a few minutes, please visit an authorized HYUNDAI dealer.

Each wheel is equipped with a tire pressure sensor mounted inside the tire behind the valve stem (except for the spare tire). You must use TPMS specific wheels. It is recommended that you always have your tires serviced by an authorized HYUNDAI dealer.

You may not be able to identify a tire with low pressure by simply looking at it. Always use a good quality tire pressure gauge to measure. Please note that a tire that is hot (from being driven) will have a higher pressure measurement than a tire that is cold.

A cold tire means the vehicle has been sitting for 3 hours and driven for less than 1 mile (1.6 km) in that 3 hour period.

Allow the tire to cool before measuring the inflation pressure. Always be sure the tire is cold before inflating to the recommended pressure.

WARNING

- The TPMS cannot alert you to severe and sudden tire damage caused by external factors such as nails or road debris.
- If you feel any vehicle instability, immediately take your foot off the accelerator, apply the brakes gradually with light force, and slowly move to a safe position off the road.

WARNING

Tampering with, modifying, or disabling the Tire Pressure Monitoring System (TPMS) components may interfere with the system's ability to warn the driver of low tire pressure conditions and/or TPMS malfunctions. Tampering with, modifying, or disabling the Tire Pressure Monitoring System (TPMS) components may void the warranty for that portion of the vehicle.

Information

This device complies with Part 15 of the FCC rules.

Operation is subject to the following three conditions:

1. This device may not cause harmful interference, and
2. This device must accept any interference received, including interference that may cause undesired operation.
3. Changes or modifications not expressly approved by the party responsible for compliance could void the user's authority to operate the equipment.

IF YOU HAVE A FLAT TIRE

With Tire Mobility Kit
(TMK, if equipped)

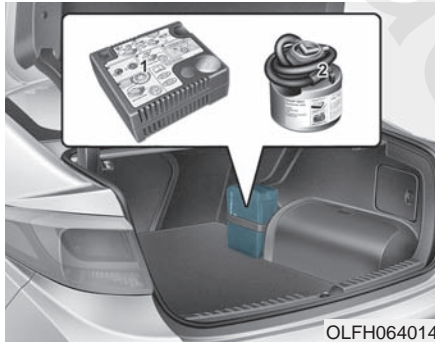

For safe operation, carefully read and follow the instructions in this manual before use.

- (1) Compressor
- (2) Sealant bottle

The Tire Mobility Kit is a temporary fix to the tire and the tire should be inspected by an authorized HYUNDAI dealer as soon as possible.

⚠ CAUTION

One sealant bottle for one tire

When two or more tires are flat, do not use the tire mobility kit because the supported one sealant of Tire Mobility Kit is only used for one flat tire.

⚠ WARNING

Tire wall

Do not use the Tire Mobility Kit to repair punctures in the tire walls. This can result in an accident due to tire failure.

⚠ WARNING

Temporary fix

Have your tire repaired as soon as possible. The tire may lose air pressure at any time after inflating with the Tire Mobility Kit.

Introduction



With the Tire Mobility Kit you stay mobile even after experiencing a tire puncture.

The compressor and sealing compound system effectively and comfortably seals most punctures in a passenger car tire caused by nails or similar objects and reinflates the tire.

After you ensure that the tire is properly sealed you can drive cautiously on the tire (distance up to 120 miles (200 km)) at a max. speed of (50mph (80 km/h)) in order to reach a service station or tire dealer for the tire replacement.

It is possible that some tires, especially with larger punctures or damage to the sidewall, cannot be sealed completely.

Air pressure loss in the tire may adversely affect tire performance.

For this reason, you should avoid abrupt steering or other driving maneuvers, especially if the vehicle is heavily loaded or if a trailer is in use.

The Tire Mobility Kit is not designed or intended as a permanent tire repair method and is to be used for one tire only.

This instruction shows you step by step how to temporarily seal the puncture simply and reliably.

Read the section "Notes on the safe use of the Tire Mobility Kit".

Notes on the safe use of the Tire Mobility Kit

- Park your car at the side of the road so that you can work with the Tire Mobility Kit away from moving traffic.
- To be sure your vehicle will not move, even when you're on fairly level ground, always set your parking brake.
- Only use the Tire Mobility Kit for sealing/inflation passenger car tires. Only punctured areas located within the tread region of the tire can be sealed using the tire mobility kit.
- Do not use on motorcycles, bicycles or any other type of tires.
- When the tire and wheel are damaged, do not use Tire Mobility Kit for your safety.
- Use of the Tire Mobility Kit may not be effective for tire damage larger than approximately 0.24 inch (6 mm).
Please contact the nearest HYUNDAI dealership if the tire cannot be made roadworthy with the Tire Mobility Kit.
- Do not use the Tire Mobility Kit if a tire is severely damaged by driving run flat or with insufficient air pressure.
- Do not remove any foreign objects such as nails or screws that have penetrated the tire.
- Provided the car is outdoors, leave the engine running. Otherwise operating the compressor may eventually drain the car battery.
- Never leave the Tire Mobility Kit unattended while it is being used.
- Do not leave the compressor running for more than 10 minutes at a time or it may overheat.
- Do not use the Tire Mobility Kit if the ambient temperature is below -22°F (-30°C).

Components of the Tire Mobility Kit

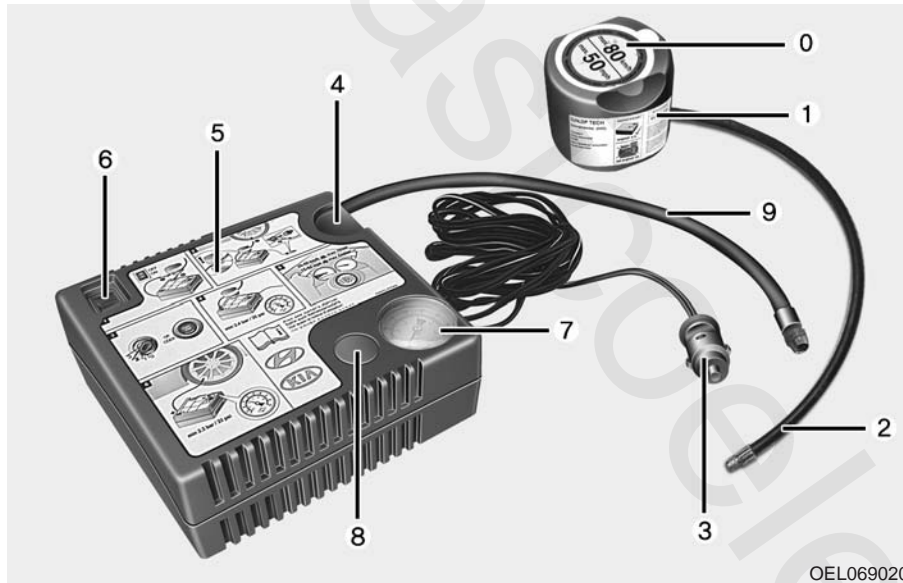

0. Speed restriction label
1. Sealant bottle and label with speed restriction
2. Filling hose from sealant bottle to wheel
3. Connectors and cable for power outlet direct connection
4. Holder for the sealant bottle
5. Compressor
6. ON/OFF switch
7. Pressure gauge for displaying the tire inflation pressure
8. Screw cap for reducing tire inflation pressure

9. Hose to connect compressor and sealant bottle or compressor and wheel

Connectors, cable and connection hose are stored in the compressor housing.

Strictly follow the specified sequence, otherwise the sealant may escape under high pressure.

⚠ WARNING

Do not use the tire sealant after the sealant has expired (i.e. pasted the expiration date on the sealant container). This can increase the risk of tire failure.

⚠ WARNING

- Keep out of reach of children.
- Avoid contact with eyes.
- Do not swallow.

OEL069020

Using the Tire Mobility Kit

1. Detach the speed restriction label (0) from the sealant bottle (1), and place it in a highly visible place inside the vehicle such as on the steering wheel to remind the driver not to drive too fast.

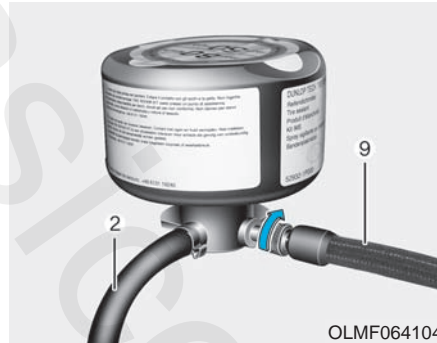

2. Screw the connection hose (9) onto the connector of the sealant bottle.
3. Ensure that the screw cap (8) is closed.



4. Unscrew the valve cap from the valve of the flat tire and screw the filling hose (2) of the sealant bottle onto the valve.

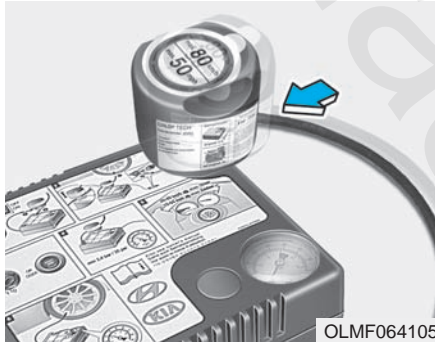

OLMF064105

5. Insert the sealant bottle into the housing (4) of the compressor so that the bottle is upright.
6. Ensure that the compressor is switched off, position 0.



OLF064019N

7. Plug the compressor power cord (3) into the vehicle power outlet.
8. With the ignition switch in the ON position, switch on the compressor and let it run for approximately 5–7 minutes to fill the sealant up to proper pressure. (refer to the Tire and Wheels, chapter 8). The inflation pressure of the tire after filling is unimportant and will be checked/corrected later.
Be careful not to overinflate the tire and stay away from the tire when filling it.

⚠ CAUTION

Do not attempt to drive your vehicle if the tire pressure is below 29 psi (200kpa). This could result in an accident due to sudden tire failure.

9. Switch off the compressor.
10. Detach the hoses from the sealant bottle connector and from the tire valve.

Return the Tire Mobility Kit to its storage location in the vehicle.

⚠ WARNING

Do not leave your vehicle running in a poorly ventilated area for extended periods of time. Carbon monoxide poisoning and suffocation can occur.

Distributing the sealant

11. Immediately drive approximately 4~6miles (7~10km or about 10 minutes) to evenly distribute the sealant in the tire.

Do not exceed a speed of 50 mph (80 km/h). If possible, do not fall below a speed of 12 mph (20 km/h).

While driving, if you experience any unusual vibration, ride disturbance or noise, reduce your speed and drive with caution until you can safely pull off of the side of the road.



CAUTION

Never use a puncture-repairing agent not approved by HYUNDAI dealer to repair and/or inflate a low pressure tire. Tire sealant not approved by HYUNDAI dealer may damage the tire pressure sensor.



Checking the tire inflation pressure

1. After driving approximately 4~6miles (7~10km or about 10 minutes), stop at a safe location.
2. Connect hose (9) of the compressor directly to the tire valve.
3. Plug the compressor power cord into the vehicle power outlet.

4. Adjust the tire inflation pressure to the recommended tire inflation.

With the ignition switched on, proceed as follows.

- To increase the inflation pressure:

Switch on the compressor, position to [I]. To check the current inflation pressure setting, briefly switch off the compressor.

- To reduce the inflation pressure:

Loosen the screw cap (8) on the compressor hose.



Information

The pressure gauge may show higher than actual reading when the compressor is running. To get an accurate tire pressure, the compressor needs to be turned off.

 **CAUTION**

When you use the Tire Mobility Kit including sealant not approved by HYUNDAI, the tire pressure sensors may be damaged by sealant. The sealant on the tire pressure sensor and wheel should be removed when you replace the tire with a new one and inspect the tire pressure sensors at an authorized dealer.

Technical Data

System voltage: DC 12 V

Working voltage: DC 10 - 15 V

Amperage rating: max. 15 A

Suitable for use at temperatures:

-22 ~ +158°F (-30 ~ +70°C)

Max. working pressure:

87 psi (6 bar)

Size

Compressor: 6.6 x 5.9 x 2.7 in.

(168 x 150 x 68 mm)

Sealant bottle: 4.0 x 3.3 ø in.

(104 x 85 ø mm)

Compressor weight:

2.3 lbs (1.05 kg)

Sealant volume:

18.3 cu. in. (300 ml)

TOWING

Towing service

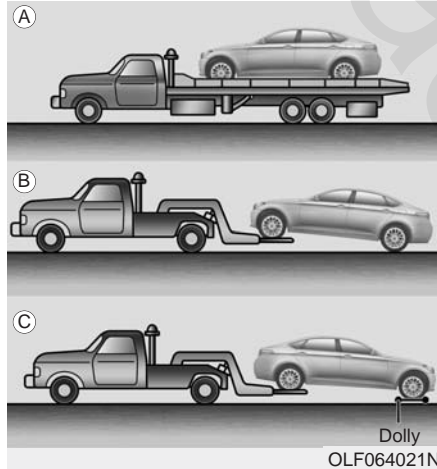

If emergency towing is necessary, we recommend having it done by an authorized HYUNDAI dealer or a commercial tow-truck service.

Proper lifting and towing procedures are necessary to prevent damage to the vehicle. The use of wheel dollies or flatbed is recommended.

It is acceptable to tow the vehicle with the rear wheels on the ground (without dollies) and the front wheels off the ground.

If any of the loaded wheels or suspension components are damaged or the vehicle is being towed with the front wheels on the ground, use a towing dolly under the front wheels.

When being towed by a commercial tow truck and wheel dollies are not used, the front of the vehicle should always be lifted, not the rear.

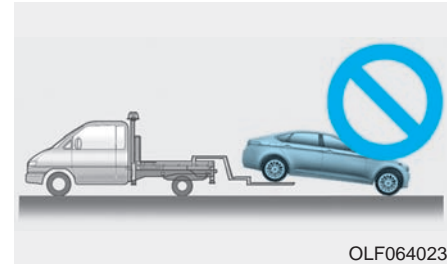

CAUTION

- Do not tow the vehicle with the front wheels on the ground as this may cause damage to the vehicle.
- Do not tow with sling-type equipment. Use wheel lift or flatbed equipment.

When towing your vehicle in an emergency without wheel dollies :

1. Place the Engine Start/Stop button in the ACC position.
2. Place the shift lever in N (Neutral).
3. Release the parking brake.

CAUTION

Failure to place the transaxle shift lever in N (Neutral) may cause internal damage to the transaxle.

Removable towing hook

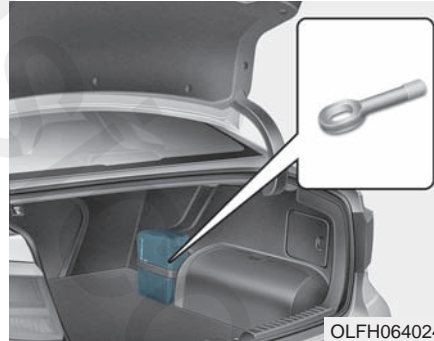

1. Open the trunk, and take the towing hooks out from the tool case.

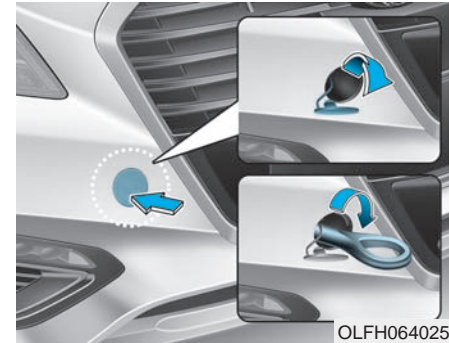

2. Open the cover by pressing the lower part on the front bumper.
3. Install the towing hook by rotating it in a clock-wise direction until it is securely installed.
4. After use, remove the towing hook and close the cover.

Emergency Towing (if equipped)

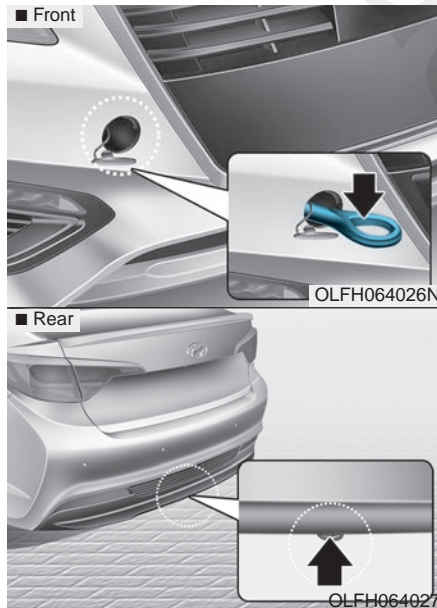

If towing is necessary, we recommend you to have it done by an authorized HYUNDAI dealer or a commercial tow truck service.

If towing service is not available in an emergency, your vehicle may be temporarily towed using a cable or chain secured to the emergency towing hook at the rear of the vehicle.

Use extreme caution when towing the vehicle with a cable or chain. A driver must be in the vehicle to steer it and operate the brakes.

Towing should be done only on a solid ground for a short distance and at a low speed.

Also, the wheels, axles, power train, steering and brakes must all be in good condition.

Always follow these emergency towing precautions:

- Place the Engine Start/Stop button in the ACC position so the steering wheel is not locked.
- Place the shift lever in N (Neutral).
- Release the parking brake.
- Depress the brake pedal with more force than normal since you will have reduced braking performance.
- More steering effort will be required because the power steering system will be disabled.
- Use a vehicle heavier than your own to tow your vehicle.
- The drivers of both vehicles should communicate with each other frequently.
- Before emergency towing, check that the hook is not broken or damaged.
- Fasten the towing cable or chain securely to the hook.
- Do not jerk the hook. Apply steady and even force.

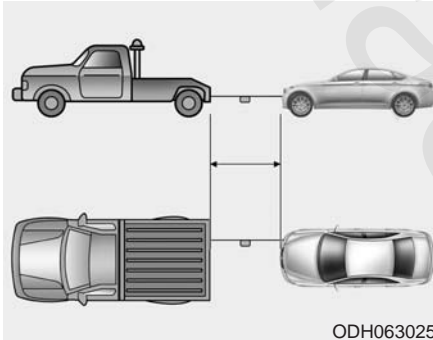

ODH063025

- Use a towing cable or chain less than 16 feet (5 m) long. Attach a white or red cloth (about 12 inches (30 cm) wide) in the middle of the cable or chain for easy visibility.
- Drive carefully so the towing cable or chain remains tight during towing.
- Before towing, check the automatic transaxle for fluid leaks under your vehicle. If the automatic transaxle fluid is leaking, flatbed equipment or a towing dolly must be used.

CAUTION

To avoid damage to your vehicle and vehicle components when towing:

- Always pull straight ahead when using the towing hooks. Do not pull from the side or at a vertical angle.
- Do not use the towing hooks to pull a vehicle out of mud, sand or other conditions from which the vehicle cannot be driven out under its own power.
- Limit the vehicle speed to 10 mph (15 km/h) and drive less than 1 mile (1.5 km) when towing to avoid serious damage to the automatic transaxle.

IF AN ACCIDENT OCCURS

WARNING

- For your safety, do not touch high voltage cables, connectors and package modules. High voltage components are orange in color.
- Exposed cables or wires may be visible inside or outside of the vehicle. Never touch the wires or cables, because an electrical shock, an injury, or a death may occur.
- Any gas or electrolyte leakage from your vehicle is not only poisonous but also flammable. Upon witnessing one of those, open the windows, and remain a safe distance from the vehicle out of the road. Immediately contact an authorized Hyundai dealer and advise them that a hybrid vehicle is involved.
- If you need towing, refer to "Towing" in the previous pages.

(Continued)

(Continued)

- When the vehicle is severely damaged, remain a safe distance of 50 feet (15 meter) or more between your vehicle and other vehicles/flammas.

WARNING

If a fire occurs :

Upon witnessing any sparks, gases, flames, or fuel leakage of your vehicle, immediately call 911 or contact an authorized HYUNDAI dealer. Also, advise them that a hybrid vehicle is involved.

WARNING

When a submersion in water occurs:

When your vehicle is flooded in water, a high-voltage battery may cause shock or may catch on fire. Thus, turn the hybrid system OFF, take the key in your possession and move to a safe place. Never attempt physical contact with your flooded vehicle. Immediately contact an authorized HYUNDAI dealer and advise them that a hybrid vehicle is involved.

Maintenance

Engine compartment	7-3	Air cleaner	7-35
Maintenance services	7-4	Filter replacement.....	7-35
Owner's responsibility.....	7-4	Climate control air filter	7-37
Owner maintenance precautions	7-4	Filter inspection.....	7-37
Owner maintenance.....	7-5	Wiper blades	7-39
Owner maintenance schedule.....	7-6	Blade inspection	7-39
Scheduled maintenance services.....	7-8	Blade replacement	7-39
Explanation of scheduled maintenance		Battery.....	7-41
items.....	7-24	For best battery service.....	7-42
Engine oil	7-27	Battery recharging	7-42
Checking the engine oil level.....	7-27	Reset features	7-43
Checking the engine oil and filter	7-28	Tires and wheels	7-44
Engine coolant/inverter coolant	7-29	Tire care	7-44
Checking the engine/inverter coolant level.....	7-29	Recommended cold tire inflation pressures.....	7-45
Changing engine coolant.....	7-32	Check tire inflation pressure.....	7-46
Hybrid starter & generator (HSG) belt.....	7-32	Tire rotation	7-47
Checking the hybrid starter &		Wheel alignment and tire balance	7-48
generator (HSG) belt.....	7-32	Tire replacement	7-48
Brake fluid	7-33	Wheel replacement.....	7-49
Checking the brake fluid level.....	7-33	Tire traction.....	7-49
Washer fluid	7-34	Tire maintenance	7-50
Checking the washer fluid level.....	7-34	Tire sidewall labeling.....	7-50
Parking brake	7-34	Tire terminology and definitions.....	7-54
Checking the parking brake	7-34	All season tires	7-57
		Summer tires	7-57

Snow tires	7-57
Radial-ply tires	7-58
Low aspect ratio tires	7-58
Fuses.....	7-60
Instrument panel fuse replacement	7-61
Engine compartment panel fuse replacement.....	7-62
Fuse/relay panel description	7-64
Light bulbs.....	7-72
Headlamp, position lamp, turn signal lamp and side marker light bulb replacement.....	7-73
Side repeater lamp replacement	7-78
Rear combination light bulb replacement.....	7-79
Back-up lamp.....	7-83
High mounted stop lamp	7-84
License plate light bulb replacement	7-84
Interior light bulb replacement	7-84
Appearance care	7-86
Exterior care	7-86
Interior care.....	7-91
Emission control system	7-93
Crankcase emission control system	7-93
Evaporative emission control system including onboard refueling vapor recovery (ORVR)	7-93
Exhaust emission control system	7-94
California perchlorate notice	7-97

ENGINE COMPARTMENT

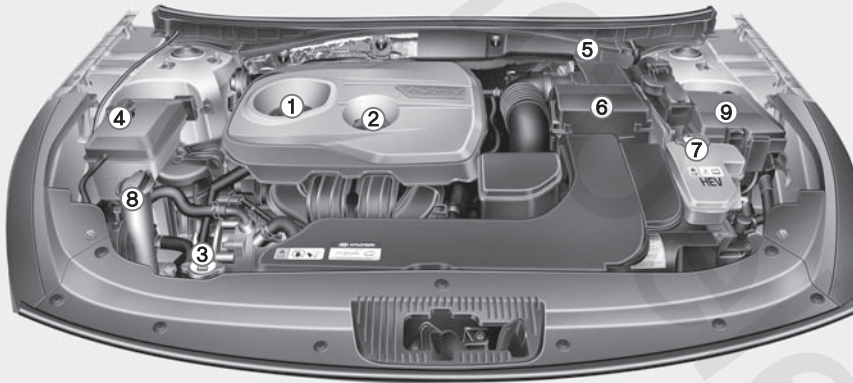

1. Engine oil filler cap
2. Engine oil dipstick
3. Radiator cap
4. Engine coolant reservoir
5. Brake fluid reservoir
6. Air cleaner
7. Inverter coolant reservoir
8. Windshield washer fluid reservoir
9. Fuse box

The actual engine compartment the vehicle may differ from the illustration.

OLFH014005K

MAINTENANCE SERVICES

You should exercise the utmost care to prevent damage to your vehicle and injury to yourself whenever performing any maintenance or inspection procedures.

Have your vehicle maintained and repaired by an authorized HYUNDAI dealer. An authorized HYUNDAI dealer meets HYUNDAI's high service quality standards and receives technical support from HYUNDAI in order to provide you with a high level of service satisfaction.

Owner's responsibility

Maintenance service and record retention are the owner's responsibility.

You should retain documents that show proper maintenance has been performed on your vehicle in accordance with the scheduled maintenance service charts shown on the following pages. You need this information to establish your compliance with the servicing and maintenance requirements of your vehicle warranties.

Detailed warranty information is provided in your Owner's Handbook & Warranty Information booklet.

Repairs and adjustments required as a result of improper maintenance or a lack of required maintenance are not covered.

Owner maintenance precautions

Inadequate, incomplete or insufficient servicing may result in operational problems with your vehicle that could lead to vehicle damage, an accident, or personal injury. This chapter provides instructions only for the maintenance items that are easy to perform. Several procedures can be done only by an authorized HYUNDAI dealer with special tools.

Your vehicle should not be modified in any way. Such modifications may adversely affect the performance, safety or durability of your vehicle and may, in addition, violate conditions of the limited warranties covering the vehicle.

Certain modifications may also be in violation of regulations established by the U.S. Department of Transportation and other federal or state agencies.

NOTICE

Improper owner maintenance during the warranty period may affect warranty coverage. For details, read the separate Owner's Handbook & Warranty Information booklet provided with the vehicle. If you're unsure about any service or maintenance procedure, have it done by an authorized HYUNDAI dealer.

OWNER MAINTENANCE

WARNING

Performing maintenance work on a vehicle can be dangerous. If you lack sufficient knowledge and experience or the proper tools and equipment to do the work, have it done by an authorized HYUNDAI dealer. ALWAYS follow these precautions for performing maintenance work:

- Park your vehicle on level ground, move the shift lever into the P (Park, for automatic transaxle vehicle) position, apply the parking brake, place the Engine Start/Stop button in the OFF position.
- Block the tires (front and back) to prevent the vehicle from moving.

Remove loose clothing or jewelry that can become entangled in moving parts.

(Continued)

(Continued)

- If you must run the engine during maintenance, do so out doors or in an area with plenty of ventilation.
- Keep flames, sparks, or smoking materials away from the battery and fuel-related parts.
- When you open the engine hood, turn the hybrid system off. If not, it may result in death or serious injury because of the high voltage flow.

The following lists are vehicle checks and inspections that should be performed by the owner or an authorized HYUNDAI dealer at the frequencies indicated to help ensure safe, dependable operation of your vehicle.

Any adverse conditions should be brought to the attention of your dealer as soon as possible.

These Owner Maintenance vehicle checks are generally not covered by warranties and you may be charged for labor, parts and lubricants used.

Owner maintenance schedule

When you stop for fuel:

- Check the engine oil level.
- Check coolant level in the engine coolant reservoir.
- Check the windshield washer fluid level.
- Check for low or under-inflated tires.

⚠ WARNING

Be careful when checking your engine coolant level when the engine is hot. This may result in coolant being blown out of the opening and cause serious burns and other injuries.

While operating your vehicle:

- Note any changes in the sound of the exhaust or any smell of exhaust fumes in the vehicle.
- Check for vibrations in the steering wheel. Notice if there is any increased steering effort or looseness in the steering wheel, or change in its straight-ahead position.
- Notice if your vehicle constantly turns slightly or “pulls” to one side when traveling on smooth, level road.
- When stopping, listen and check for unusual sounds, pulling to one side, increased brake pedal travel or “hard-to-push” brake pedal.
- If any slipping or changes in the operation of your transmission occurs, check the transmission fluid level.
- Check the automatic transaxle P (Park) function.
- Check the parking brake.
- Check for fluid leaks under your vehicle (water dripping from the air conditioning system during or after use is normal).

At least monthly:

- Check coolant level in the engine coolant reservoir.
- Check the operation of all exterior lights, including the stoplights, turn signals and hazard warning flashers.
- Check the inflation pressures of all tires including the spare for tires that are worn, show uneven wear, or are damaged.
- Check for loose wheel lug nuts.

***At least twice a year:
(i.e., every Spring and Fall)***

- Check radiator, heater and air conditioning hoses for leaks or damage.
- Check windshield washer spray and wiper operation. Clean wiper blades with clean cloth dampened with washer fluid.
- Check headlamp alignment.
- Check muffler, exhaust pipes, shields and clamps.
- Check the seat belts for wear and function.

At least once a year:

- Clean body and door drain holes.
- Lubricate door hinges and hood hinges.
- Lubricate door and hood locks and latches.
- Lubricate door rubber weather strips.
- Check the air conditioning system.
- Inspect and lubricate automatic transaxle linkage and controls.
- Clean the battery and terminals.
- Check the brake fluid level.

SCHEDULED MAINTENANCE SERVICES

Follow Normal maintenance schedule if the vehicle is usually operated where none of the following conditions apply. If any of the following conditions apply, you must follow the Maintenance Under Severe Usage Conditions.

- Repeated short distance driving.
- Driving in dusty conditions or sandy areas.
- Extensive use of brakes.
- Driving in areas where salt or other corrosive materials are used.
- Driving on rough or muddy roads.
- Driving in mountainous areas.
- Extended periods of idling or low speed operation.
- Driving for a prolonged period in cold temperatures and/or extremely humid climates.
- More than 50% driving in heavy city traffic during hot weather above 90°F (32°C).

For additional information or assistance see your authorized HYUNDAI dealer.

Normal maintenance schedule

The following maintenance services must be performed to ensure good emission control and performance.

Keep receipts for all vehicle emission services to protect your warranty. Where both mileage and time are shown, the frequency of service is determined by whichever occurs first.

7,500 miles (12,000 km) or 6 months

- Inspect air cleaner filter
- Inspect HSG belt *²
(7,500 miles (12,000 km) or 12 months)
- Inspect vacuum hose
- Air intake hose
- Replace engine oil and filter
(7,500 miles (12,000 km) or 12 months)
- Add fuel additive *¹
(7,500 miles (12,000 km) or 12 months)

*¹ : If TOP TIER Detergent Gasoline is not available, one bottle of additive is recommended. Additives are available from your authorized HYUNDAI dealer along with information on how to use them. Do not mix other additives.

*² : Inspect HSG belt for evidence of cuts, crocks, excessive wear or oil saturation and replace if necessary. If drive belt noise occurred, readjust drive belt tension before replace.

* : Inspect : Inspect and if necessary, adjust, correct, clean or replace.

15,000 miles (24,000 km) or 12 months

- Inspect air cleaner filter
- Inspect HSG belt *²
(15,000 miles (24,000 km) or 24 months)
- Inspect vacuum hose
- Inspect air conditioning refrigerant
- Inspect brake hoses and lines
- Inspect drive shafts and boots
- Inspect exhaust pipe and muffler
- Inspect front brake disc/pads, calipers
- Inspect rear brake disc/pads
- Inspect steering gear box, linkage & boots/lower arm ball joint, upper arm ball joint
- Inspect suspension mounting bolts
- Air intake hose
- Replace climate control air filter
(for evaporator and blower unit)
- Replace engine oil and filter
(15,000 miles (24,000 km) or 24 months)

(Continued)

Normal maintenance schedule (CONT.)

(Continued)

- Add fuel additive *1
(15,000 miles (24,000 km) or 24 months)

*1 : If TOP TIER Detergent Gasoline is not available, one bottle of additive is recommended. Additives are available from your authorized HYUNDAI dealer along with information on how to use them. Do not mix other additives.

*2 : Inspect HSG belt for evidence of cuts, cracks, excessive wear or oil saturation and replace if necessary. If drive belt noise occurred, readjust drive belt tension before replace.

※ Inspect : Inspect and if necessary, adjust, correct, clean or replace.

22,500 miles (36,000 km) or 18 months

- Inspect air cleaner filter
- Inspect vacuum hose
- Air intake hose
- Inspect HSG belt *2
(22,500 miles (36,000 km) or 36 months)
- Replace engine oil and filter
(22,500 miles (36,000 km) or 36 months)
- Add fuel additive *1
(22,500 miles (36,000 km) or 36 months)

*1 : If TOP TIER Detergent Gasoline is not available, one bottle of additive is recommended. Additives are available from your authorized HYUNDAI dealer along with information on how to use them. Do not mix other additives.

*2 : Inspect HSG belt for evidence of cuts, cracks, excessive wear or oil saturation and replace if necessary. If drive belt noise occurred, readjust drive belt tension before replace.

※ Inspect : Inspect and if necessary, adjust, correct, clean or replace.

Normal maintenance schedule (CONT.)

30,000 miles (48,000 km) or 24 months

- Inspect vacuum hose
- Inspect air conditioning refrigerant
- Inspect brake hoses and lines
- Inspect drive shafts and boots
- Inspect exhaust pipe and muffler
- Inspect HSG belt ^{*2}
(30,000 miles (48,000 km) or 48 months)
- Inspect front brake disc/pads, calipers
- Inspect rear brake disc/pads
- Inspect steering gear box, linkage & boots/lower arm ball joint, upper arm ball joint
- Inspect suspension mounting bolts
- Inspect brake fluid
- Inspect fuel filter ^{*3}
- Inspect fuel cap, fuel lines, fuel hoses and connections
- Inspect fuel tank air filter (if equipped) ^{*3}
- Inspect parking brake
- Inspect vapor hose and fuel filler cap
- Air intake hose
- Replace climate control air filter
(for evaporator and blower unit)

(Continued)

(Continued)

- Replace air cleaner filter
- Replace engine oil and filter
(30,000 miles (48,000 km) or 48 months)
- Add fuel additive ^{*1}
(30,000 miles (48,000 km) or 48 months)

^{*1} : If TOP TIER Detergent Gasoline is not available, one bottle of additive is recommended. Additives are available from your authorized HYUNDAI dealer along with information on how to use them. Do not mix other additives.

^{*2} : Inspect HSG belt for evidence of cuts, crocks, excessive wear or oil saturation and replace if necessary. If drive belt noise occurred, readjust drive belt tension before replace.

^{*3} : Fuel filter & Fuel tank air filter are considered to be maintenance free but periodic inspection is recommended for this maintenance schedule depends on fuel quality. If there are some important safety matters like fuel flow restriction, surging, loss of power, hard starting problem etc, replace the fuel filter immediately regardless of maintenance schedule and consult an authorized HYUNDAI dealer for details.

^{*} Inspect : Inspect and if necessary, adjust, correct, clean or replace.

Normal maintenance schedule (CONT.)

37,500 miles (60,000 km) or 30 months

- Inspect air cleaner filter
- Inspect HSG belt *²
(37,500 miles (60,000 km) or 60 months)
- Inspect vacuum hose
- Air intake hose
- Replace engine oil and filter
(37,500 miles (60,000 km) or 60 months)
- Add fuel additive *¹
(37,500 miles (60,000 km) or 60 months)

*¹ : If TOP TIER Detergent Gasoline is not available, one bottle of additive is recommended. Additives are available from your authorized HYUNDAI dealer along with information on how to use them. Do not mix other additives.

*² : Inspect HSG belt for evidence of cuts, crocks, excessive wear or oil saturation and replace if necessary. If drive belt noise occurred, readjust drive belt tension before replace.

* : Inspect : Inspect and if necessary, adjust, correct, clean or replace.

45,000 miles (72,000 km) or 36 months

- Inspect air cleaner filter
- Inspect vacuum hose
- Inspect air conditioning refrigerant
- Inspect brake hoses and lines
- Inspect drive shafts and boots
- Inspect exhaust pipe and muffler
- Inspect front brake disc/pads, calipers
- Inspect HSG belt *²
(45,000 miles (72,000 km) or 72 months)
- Inspect rear brake disc/pads
- Inspect steering gear box, linkage & boots/lower arm ball joint, upper arm ball joint
- Inspect suspension mounting bolts
- Air intake hoses
- Replace climate control air filter
(for evaporator and blower unit)
- Replace engine oil and filter
(45,000 miles (72,000 km) or 72 months)
- Add fuel additive *¹
(45,000 miles (72,000 km) or 72 months)

Normal maintenance schedule (CONT.)

52,500 miles (84,000 km) or 42 months

- Inspect air cleaner filter
- Inspect HSG belt *²
(52,500 miles (84,000 km) or 84 months)
- Inspect vacuum hose
- Air intake hose
- Replace engine oil and filter
(52,500 miles (84,000 km) or 84 months)
- Add fuel additive *¹
(52,500 miles (84,000 km) or 84 months)

*¹ : If TOP TIER Detergent Gasoline is not available, one bottle of additive is recommended. Additives are available from your authorized HYUNDAI dealer along with information on how to use them. Do not mix other additives.

*² : Inspect HSG belt for evidence of cuts, crocks, excessive wear or oil saturation and replace if necessary. If drive belt noise occurred, readjust drive belt tension before replace.

* : Inspect : Inspect and if necessary, adjust, correct, clean or replace.

60,000 miles (96,000 km) or 48 months

- Inspect vacuum hose
- Inspect air conditioning refrigerant
- Inspect brake hoses and lines
- Inspect drive shafts and boots
- Inspect exhaust pipe and muffler
- Inspect front brake disc/pads, calipers
- Inspect rear brake disc/pads
- Inspect steering gear box, linkage & boots/lower arm ball joint, upper arm ball joint
- Inspect suspension mounting bolts
- Inspect brake fluid
- Inspect fuel filter *³
- Inspect fuel cap, fuel lines, fuel hoses and connections
- Inspect fuel tank air filter (if equipped) *³
- Inspect parking brake
- Inspect vapor hose and fuel filler cap
- Replace HSG belt *²
(60,000 miles (96,000 km) or 48 months)
- Air intake hose
- Replace climate control air filter
(for evaporator and blower unit)

(Continued)

Normal maintenance schedule (CONT.)

(Continued)

- Replace air cleaner filter
- Replace engine oil and filter
(60,000 miles (96,000 km) or 96 months)
- Add fuel additive *¹
(60,000 miles (96,000 km) or 96 months)

*¹ : If TOP TIER Detergent Gasoline is not available, one bottle of additive is recommended. Additives are available from your authorized HYUNDAI dealer along with information on how to use them. Do not mix other additives.

*² : Inspect HSG belt for evidence of cuts, cracks, excessive wear or oil saturation and replace if necessary. If drive belt noise occurred, readjust drive belt tension before replace.

*³ : Fuel filter & Fuel tank air filter are considered to be maintenance free but periodic inspection is recommended for this maintenance schedule depends on fuel quality. If there are some important safety matters like fuel flow restriction, surging, loss of power, hard starting problem etc, replace the fuel filter immediately regardless of maintenance schedule and consult an authorized HYUNDAI dealer for details.

* : Inspect : Inspect and if necessary, adjust, correct, clean or replace.

67,500 miles (108,000 km) or 54 months

- Inspect air cleaner filter
- Inspect HSG belt *²
(67,500 miles (108,000 km) or 108 months)
- Inspect vacuum hose
- Air intake hose
- Replace engine oil and filter
(67,500 miles (108,000 km) or 108 months)
- Add fuel additive *¹
(67,500 miles (108,000 km) or 108 months)

*¹ : If TOP TIER Detergent Gasoline is not available, one bottle of additive is recommended. Additives are available from your authorized HYUNDAI dealer along with information on how to use them. Do not mix other additives.

*² : Inspect HSG belt for evidence of cuts, cracks, excessive wear or oil saturation and replace if necessary. If drive belt noise occurred, readjust drive belt tension before replace.

* : Inspect : Inspect and if necessary, adjust, correct, clean or replace.

Normal maintenance schedule (CONT.)

75,000 miles (120,000 km) or 60 months

- Inspect air cleaner filter
- Inspect vacuum hose
- Inspect air conditioning refrigerant
- Inspect brake hoses and lines
- Inspect drive shafts and boots
- Inspect exhaust pipe and muffler
- Inspect front brake disc/pads, calipers
 - Inspect rear brake disc/pads
- Inspect steering gear box, linkage & boots/lower arm ball joint, upper arm ball joint
- Inspect suspension mounting bolts
- Inspect HSG belt *²
(75,000 miles (120,000 km) or 120 months)
- Air intake hose
- Replace climate control air filter
(for evaporator and blower unit)
- Replace engine oil and filter
(75,000 miles (120,000 km) or 120 months)
- Add fuel additive *¹
(75,000 miles (120,000 km) or 120 months)

82,500 miles (132,000 km) or 66 months

- Inspect air cleaner filter
- Inspect HSG belt *²
(82,500 miles (132,000 km) or 132 months)
- Inspect vacuum hose
- Air intake hose
- Replace engine oil and filter
(82,500 miles (132,000 km) or 132 months)
- Add fuel additive *¹
(82,500 miles (132,000 km) or 132 months)

*¹ : If TOP TIER Detergent Gasoline is not available, one bottle of additive is recommended. Additives are available from your authorized HYUNDAI dealer along with information on how to use them. Do not mix other additives.

*² : Inspect HSG belt for evidence of cuts, cracks, excessive wear or oil saturation and replace if necessary. If drive belt noise occurred, readjust drive belt tension before replace.

※ Inspect : Inspect and if necessary, adjust, correct, clean or replace.

Normal maintenance schedule (CONT.)

90,000 miles (144,000 km) or 72 months

- Inspect vacuum hose
- Inspect air conditioning refrigerant
- Inspect brake hoses and lines
- Inspect drive shafts and boots
- Inspect exhaust pipe and muffler
- Inspect front brake disc/pads, calipers
- Inspect rear brake disc/pads
 - Inspect steering gear box, linkage & boots/lower arm ball joint, upper arm ball joint
- Inspect suspension mounting bolts
- Inspect brake fluid
- Inspect fuel filter *³
- Inspect fuel cap, fuel lines, fuel hoses and connections
- Inspect fuel tank air filter (if equipped) *³
- Inspect parking brake
- Inspect vapor hose and fuel filler cap
- Inspect HSG belt *²
(90,000 miles (144,000 km) or 144 months)
- Air intake hose
- Replace climate control air filter
(for evaporator and blower unit)
- Replace air cleaner filter

(Continued)

(Continued)

- Replace engine oil and filter
(90,000 miles (144,000 km) or 144 months)
- Add fuel additive *¹
(90,000 miles (144,000 km) or 144 months)

*¹ : If TOP TIER Detergent Gasoline is not available, one bottle of additive is recommended. Additives are available from your authorized HYUNDAI dealer along with information on how to use them. Do not mix other additives.

*² : Inspect HSG belt for evidence of cuts, crocks, excessive wear or oil saturation and replace if necessary. If drive belt noise occurred, readjust drive belt tension before replace.

*³ : Fuel filter & Fuel tank air filter are considered to be maintenance free but periodic inspection is recommended for this maintenance schedule depends on fuel quality. If there are some important safety matters like fuel flow restriction, surging, loss of power, hard starting problem etc, replace the fuel filter immediately regardless of maintenance schedule and consult an authorized HYUNDAI dealer for details.

* : Inspect : Inspect and if necessary, adjust, correct, clean or replace.

Normal maintenance schedule (CONT.)

97,500 miles (156,000 km) or 78 months

- Inspect air cleaner filter
- Inspect HSG belt *²
(97,500 miles (156,000 km) or 156 months)
- Inspect vacuum hose
- Air intake hose
- Replace engine oil and filter
(97,500 miles (156,000 km) or 156 months)
- Add fuel additive *¹
(97,500 miles (156,000 km) or 156 months)

*¹ : If TOP TIER Detergent Gasoline is not available, one bottle of additive is recommended. Additives are available from your authorized HYUNDAI dealer along with information on how to use them. Do not mix other additives.

*² : Inspect HSG belt for evidence of cuts, crocks, excessive wear or oil saturation and replace if necessary. If drive belt noise occurred, readjust drive belt tension before replace.

* : Inspect : Inspect and if necessary, adjust, correct, clean or replace.

105,000 miles (168,000 km) or 84 months

- Inspect air cleaner filter
- Inspect vacuum hose
- Inspect air conditioning refrigerant
- Inspect brake hoses and lines
- Inspect drive shafts and boots
- Inspect exhaust pipe and muffler
- Inspect front brake disc/pads, calipers
- Inspect rear brake disc/pads
- Inspect steering gear box, linkage & boots/lower arm ball joint, upper arm ball joint
- Inspect suspension mounting bolts
- Inspect HSG belt *²
(105,000 miles (168,000 km) or 168 months)
- Air intake hose
- Replace climate control air filter
(for evaporator and blower unit)
- Replace spark plugs (iridium coated)
- Replace engine oil and filter
(105,000 miles (168,000 km) or 168 months)
- Add fuel additive *¹
(105,000 miles (168,000 km) or 168 months)

Normal maintenance schedule (CONT.)

112,500 miles (180,000 km) or 90 months

- Inspect air cleaner filter
- Inspect HSG belt *²
(112,500 miles (180,000 km) or 180 months)
- Inspect vacuum hose
- Air intake hose
- Replace engine oil and filter
(112,500 miles (180,000 km) or 180 months)
- Add fuel additive *¹
(112,500 miles (180,000 km) or 180 months)

*¹ : If TOP TIER Detergent Gasoline is not available, one bottle of additive is recommended. Additives are available from your authorized HYUNDAI dealer along with information on how to use them. Do not mix other additives.

*² : Inspect HSG belt for evidence of cuts, crocks, excessive wear or oil saturation and replace if necessary. If drive belt noise occurred, readjust drive belt tension before replace.

* : Inspect : Inspect and if necessary, adjust, correct, clean or replace.

120,000 miles (192,000 km) or 96 months

- Inspect vacuum hose
- Inspect air conditioning refrigerant
- Inspect brake hoses and lines
- Inspect drive shafts and boots
- Inspect exhaust pipe and muffler
- Inspect front brake disc/pads, calipers
- Inspect rear brake disc/pads
- Inspect steering gear box, linkage & boots/lower arm ball joint, upper arm ball joint
- Inspect suspension mounting bolts
- Inspect brake fluid
- Inspect fuel filter *³
- Inspect fuel cap, fuel lines, fuel hoses and connections
- Inspect fuel tank air filter (if equipped) *³
- Inspect parking brake
- Inspect vapor hose and fuel filler cap
- Air intake hose
- Replace climate control air filter
(for evaporator and blower unit)
- Replace air cleaner filter
- Replace engine oil and filter
(120,000 miles (192,000 km) or 192 months)

(Continued)

Normal maintenance schedule (CONT.)

(Continued)

- Replace engine coolant
(First, 120,000 miles (192,000 km) or 120 months
after every 30,000 miles (48,000 km) or 24 months)
- Replace inverter coolant
(First, 120,000 miles (192,000 km) or 120 months
after every 30,000 miles (48,000 km) or 24 months)
- Add fuel additive *¹
(120,000 miles (192,000 km) or 192 months)

*¹ : If TOP TIER Detergent Gasoline is not available, one bottle of additive is recommended. Additives are available from your authorized HYUNDAI dealer along with information on how to use them. Do not mix other additives.

*² : Inspect HSG belt for evidence of cuts, cracks, excessive wear or oil saturation and replace if necessary. If drive belt noise occurred, readjust drive belt tension before replace.

*³ : Fuel filter & Fuel tank air filter are considered to be maintenance free but periodic inspection is recommended for this maintenance schedule depends on fuel quality. If there are some important safety matters like fuel flow restriction, surging, loss of power, hard starting problem etc, replace the fuel filter immediately regardless of maintenance schedule and consult an authorized HYUNDAI dealer for details.

* : Inspect : Inspect and if necessary, adjust, correct, clean or replace.

127,500 miles (204,000 km) or 102 months

- Inspect air cleaner filter
- Inspect HSG belt *²
(127,500 miles (204,000 km) or 204 months)
- Inspect vacuum hose
- Air intake hose
- Replace engine oil and filter
(127,500 miles (204,000 km) or 204 months)
- Add fuel additive *¹
(127,500 miles (204,000 km) or 204 months)

*¹ : If TOP TIER Detergent Gasoline is not available, one bottle of additive is recommended. Additives are available from your authorized HYUNDAI dealer along with information on how to use them. Do not mix other additives.

*² : Inspect HSG belt for evidence of cuts, cracks, excessive wear or oil saturation and replace if necessary. If drive belt noise occurred, readjust drive belt tension before replace.

* : Inspect : Inspect and if necessary, adjust, correct, clean or replace.

Normal maintenance schedule (CONT.)

135,000 miles (216,000 km) or 108 months

- Inspect air cleaner filter
- Inspect vacuum hose
- Inspect air conditioning refrigerant
- Inspect brake hoses and lines
- Inspect drive shafts and boots
- Inspect exhaust pipe and muffler
- Inspect front brake disc/pads, calipers
- Inspect rear brake disc/pads
- Inspect steering gear box, linkage & boots/lower arm ball joint, upper arm ball joint
- Inspect suspension mounting bolts
- Inspect HSG belt *²
(135,000 miles (216,000 km) or 216 months)
- Air intake hose
- Replace climate control air filter
(for evaporator and blower unit)
- Replace engine oil and filter
(135,000 miles (216,000 km) or 216 months)
- Add fuel additive *¹
(135,000 miles (216,000 km) or 216 months)

142,500 miles (228,000 km) or 114 months

- Inspect air cleaner filter
- Inspect HSG belt *²
(142,500 miles (228,000 km) or 228 months)
- Inspect vacuum hose
- Air intake hose
- Replace engine oil and filter
(142,500 miles (228,000 km) or 228 months)
- Add fuel additive *¹
(142,500 miles (228,000 km) or 228 months)

*¹ : If TOP TIER Detergent Gasoline is not available, one bottle of additive is recommended. Additives are available from your authorized HYUNDAI dealer along with information on how to use them. Do not mix other additives.

*² : Inspect HSG belt for evidence of cuts, cracks, excessive wear or oil saturation and replace if necessary. If drive belt noise occurred, readjust drive belt tension before replace.

※ Inspect : Inspect and if necessary, adjust, correct, clean or replace.

Normal maintenance schedule (CONT.)

150,000 miles (240,000 km) or 120 months

- Inspect vacuum hose
- Inspect air conditioning refrigerant
- Inspect brake hoses and lines
- Inspect drive shafts and boots
- Inspect exhaust pipe and muffler
- Inspect front brake disc/pads, calipers
 - Inspect rear brake disc/pads
- Inspect steering gear box, linkage & boots/lower arm ball joint, upper arm ball joint
- Inspect suspension mounting bolts
- Inspect brake fluid
- Inspect fuel filter *³
- Inspect fuel lines, fuel hoses and connections
- Inspect fuel tank air filter (if equipped) *³
- Inspect parking brake
- Inspect vapor hose and fuel filler cap
- Inspect HSG belt *²
(150,000 miles (240,000 km) or 240 months)
- Air intake hose
- Replace climate control air filter
(for evaporator and blower unit)
- Replace air cleaner filter
- Replace engine oil and filter
(150,000 miles (240,000 km) or 240 months)

(Continued)

(Continued)

- Replace engine coolant
(First, 120,000 miles (192,000 km) or 120 months after every 30,000 miles (48,000 km) or 24 months)
- Replace inverter coolant
(First, 120,000 miles (192,000 km) or 120 months after every 30,000 miles (48,000 km) or 24 months)
- Add fuel additive *¹
(150,000 miles (240,000 km) or 240 months)

*¹ : If TOP TIER Detergent Gasoline is not available, one bottle of additive is recommended. Additives are available from your authorized HYUNDAI dealer along with information on how to use them. Do not mix other additives.

*² : Inspect HSG belt for evidence of cuts, cracks, excessive wear or oil saturation and replace if necessary. If drive belt noise occurred, readjust drive belt tension before replace.

*³ : Fuel filter & Fuel tank air filter are considered to be maintenance free but periodic inspection is recommended for this maintenance schedule depends on fuel quality. If there are some important safety matters like fuel flow restriction, surging, loss of power, hard starting problem etc, replace the fuel filter immediately regardless of maintenance schedule and consult an authorized HYUNDAI dealer for details.

* : Inspect : Inspect and if necessary, adjust, correct, clean or replace.

No check, No service required

- Automatic transaxle fluid

Maintenance

Maintenance under severe usage conditions

The following items must be serviced more frequently on cars normally used under severe driving conditions. Refer to the chart below for the appropriate maintenance intervals.

R : Replace I : Inspect and, after inspection, clean, adjust, repair or replace if necessary

MAINTENANCE ITEM	MAINTENANCE OPERATION	MAINTENANCE INTERVALS	DRIVING CONDITION
Engine oil and filter	R	Every 3,750 miles (6,000 km) or 6 months	A, B, C, D, E, F, G, H, I, K
Air cleaner filter	R	More frequently	C, E
Spark plugs	R	More frequently	B, H
Automatic transaxle fluid	R	Every 60,000 miles (96,000 km)	A, C, E, F, G, I
HSG (Hybrid Starter&Generator) belt	R	Every 30,000 miles (48,000 km) or 24 months	C, D, E, L
	I	Every 3,750 miles (6,000 km) or 6 months	
Front brake disc/pads, calipers	I	More frequently	C, D, G, H

MAINTENANCE ITEM	MAINTENANCE OPERATION	MAINTENANCE INTERVALS	DRIVING CONDITION
Rear brake disc/pads	I	More frequently	C, D, G, F
Parking brake	I	More frequently	C, D, G, H
Steering gear box, linkage & boots/lower arm ball joint, upper arm ball joint	I	More frequently	C, D, E, F, G, H, I
Drive shafts and boots	I	Every 7,500 miles (12,000 km) or 6 months	C, D, E, F, G, H, I, J
Climate control air filter (for evaporator and blower unit)	R	More frequently	C, E

Severe driving conditions

- A - Repeatedly driving short distance of less than 5 miles (8 km) in normal temperature or less than 10 miles (16 km) in freezing temperature
- B - Extensive engine idling or low speed driving for long distances
- C - Driving on rough, dusty, muddy, unpaved, graveled or salt-spread roads
- D - Driving in areas using salt or other corrosive materials or in very cold weather
- E - Driving in sandy areas
- F - Driving in heavy traffic area over 90°F (32°C)
- G - Driving on uphill, downhill, or mountain road
- H - Towing a Trailer, or using a camper, or roof rack
- I - Driving as a patrol car, taxi, other commercial use or vehicle towing
- J - Driving over 106 mph (170 km/h)
- K - Frequently driving in stop-and-go conditions

EXPLANATION OF SCHEDULED MAINTENANCE ITEMS

Engine oil and filter

The engine oil and filter should be changed at the intervals specified in the maintenance schedule. If the car is being driven in severe conditions, more frequent oil and filter changes are required.

HSG (Hybrid starter & generator) belt

The HSG belt should be changed at the intervals specified in the maintenance schedule.

Fuel filter

A clogged filter can limit the speed at which the vehicle may be driven, damage the emission system and cause multiple issues such as hard starting. If an excessive amount of foreign matter accumulates in the fuel tank, the filter may require replacement more frequently. After installing a new filter, run the engine for several minutes, and check for leaks at the connections. Fuel filters should be installed by an authorized HYUNDAI dealer.

Fuel lines, fuel hoses and connections

Check the fuel lines, fuel hoses and connections for leakage and damage. Have an authorized HYUNDAI dealer replace any damaged or leaking parts immediately.

Vapor hose and fuel filler cap

The vapor hose and fuel filler cap should be inspected at those intervals specified in the maintenance schedule. Make sure a new vapor hose or fuel filler cap is correctly replaced.

Air cleaner filter

A genuine HYUNDAI air cleaner filter is recommended when the filter is replaced.

Spark plugs

Make sure to install new spark plugs of the correct heat range.

Cooling system

Check cooling system components, such as radiator, coolant reservoir, hoses and connections for leakage and damage. Replace any damaged parts.

Engine coolant/Inverter coolant

The coolant should be changed at the intervals specified in the maintenance schedule.

Automatic transaxle fluid

Automatic transaxle fluid should not be checked under normal usage conditions. But in severe conditions, the fluid should be changed at an authorized HYUNDAI dealer in accordance to the scheduled maintenance at the beginning of this chapter.

NOTICE

Automatic transaxle fluid color is basically red.

As the vehicle is driven, the automatic transaxle fluid will begin to look darker. This is a normal condition and you should not judge the need to replace the fluid based upon the changed color.

CAUTION

The use of a non-specified fluid could result in transaxle malfunction and failure. Use only the specified automatic transaxle fluid (refer to “Recommended Lubricants and Capacities” in chapter 8).

Brake hoses and lines

Visually check for proper installation, chafing, cracks, deterioration and any leakage. Replace any deteriorated or damaged parts immediately.

Brake fluid

Check brake fluid level in the brake fluid reservoir. The level should be between the MIN and the MAX marks on the side of the reservoir. Use only hydraulic brake fluid conforming to DOT 3 or DOT 4 specification.

Parking brake

Inspect the parking brake system including the parking brake pedal and cables.

Brake discs, pads, calipers and rotors

Check the pads for excessive wear, discs for run out and wear, and calipers for fluid leakage.

Exhaust pipe and muffler

Visually inspect the exhaust pipes, muffler and hangers for cracks, deterioration, or damage. Start the engine and listen carefully for any exhaust gas leakage. Tighten connections or replace parts as necessary.

Suspension mounting bolts

Check the suspension connections for looseness or damage. Retighten to the specified torque.

Steering gear box, linkage & boots/lower arm ball joint

With the vehicle stopped and the hybrid system off, check for excessive free-play in the steering wheel. Check the linkage for bends or damage. Check the dust boots and ball joints for deterioration, cracks, or damage.

Replace any damaged parts.

Drive shafts and boots

Check the drive shafts, boots and clamps for cracks, deterioration, or damage. Replace any damaged parts and, if necessary, repack the grease.

Air conditioning refrigerant

Check the air conditioning lines and connections for leakage and damage.

ENGINE OIL

Checking the engine oil level

1. Follow all of the oil manufacturer's precautions.
2. Be sure the vehicle is on level ground in P (Park) with the parking brake set and the wheels blocked.
3. Turn the engine on and allow the engine to reach normal operating temperature.
4. Turn the hybrid system off and wait about five minutes for the oil to return to the oil pan.
5. Pull the dipstick out, wipe it clean, and re-insert it fully.

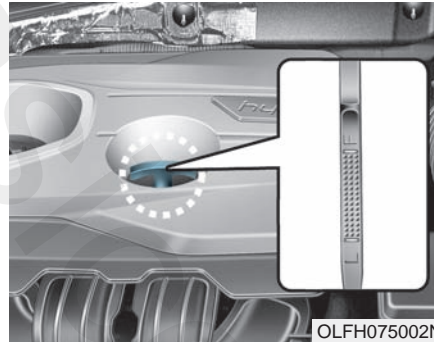

6. Pull the dipstick out again and check the level. The level should be between F and L.
7. If it is near or at L, add enough oil to bring the level to F.

NOTICE

To prevent damage to your engine:

- Do not overfill with engine oil. Add oil in small quantities and recheck level to ensure engine is not overfilled.
- Do not spill engine oil when adding or changing engine oil. Use a funnel to help prevent oil from being spilled on engine components. Wipe off spilled oil immediately

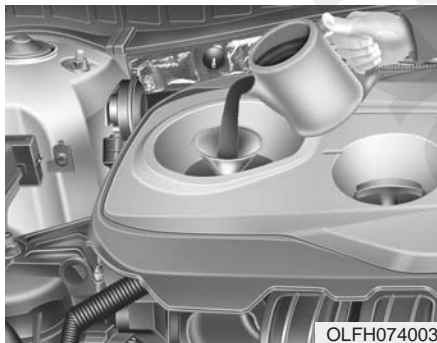

NOTICE

Use only the specified engine oil (refer to “Recommended Lubricants and Capacities” in chapter 8).

Checking the engine oil and filter



Have engine oil and filter changed by an authorized HYUNDAI dealer according to the Maintenance Schedule at the beginning of this chapter.

⚠ WARNING

CALIFORNIA PROPOSITION 65 WARNING

Engine oil contains chemicals known to the State of California to cause cancer, birth defects and reproductive harm. Used engine oil may cause irritation or cancer of the skin if left in contact with the skin for prolonged periods of time. Always protect your skin by washing your hands thoroughly with soap and warm water as soon as possible after handling used oil.

ENGINE COOLANT/INVERTER COOLANT

The high-pressure cooling system has a reservoir filled with year-round antifreeze coolant. The reservoir is filled at the factory.

Check the antifreeze protection and coolant level at least once a year, at the beginning of the winter season and before traveling to a colder climate.

Checking the engine/inverter coolant level

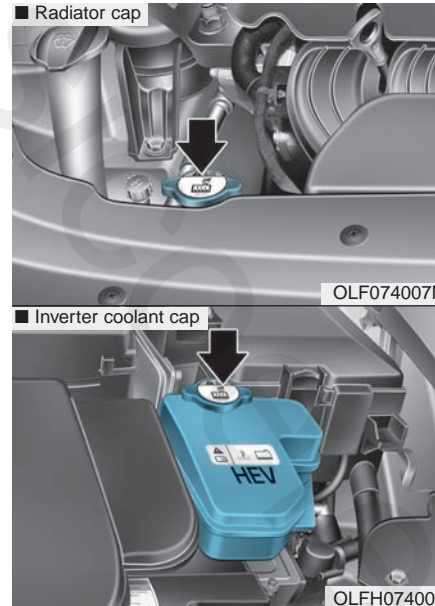

⚠ WARNING

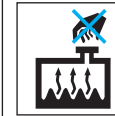

Never remove the radiator cap and/or inverter coolant cap or the drain plug while the engine and radiator are hot. Hot coolant and steam may blow out under pressure, causing serious injury.

Turn the hybrid system off and wait until the engine cools down. Use extreme care when removing the radiator cap and/or inverter coolant cap. Wrap a thick towel around it, and turn it counterclockwise slowly to the first stop. Step back while the pressure is released from the cooling system. When you are sure all the pressure has been released, press down on the cap, using a thick towel, and continue turning counterclockwise to remove it.

i Information

The engine coolant and/or inverter coolant level is influenced by the hybrid system temperature. Before checking or refilling the engine coolant and/or inverter coolant, turn the hybrid vehicle off.

⚠ WARNING



The electric motor for the cooling fan may continue to operate or start up when the engine is not running and can cause serious injury. Keep hands, clothing and tools away from the rotating fan blades of the cooling fan.

The electric motor for the cooling fan is controlled by engine coolant temperature, refrigerant pressure and vehicle speed. As the engine coolant temperature decreases, the electric motor will automatically shut off. This is a normal condition. If your vehicle is equipped with GDI, the electric motor for the cooling fan may begin to operate at any time and continue to operate until you disconnect the negative battery cable.

Engine coolant

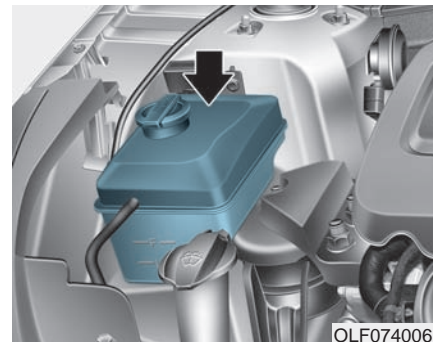

Check the condition and connections of all cooling system hoses and heater hoses. Replace any swollen or deteriorated hoses.

The coolant level should be filled between the F and the L marks on the side of the coolant reservoir when the engine is cool.

If the coolant level is low, add enough distilled (deionized) water to bring the level to the F mark, but do not overfill. If frequent additions are required, See an authorized HYUNDAI dealer for a cooling system inspection.

Inverter coolant

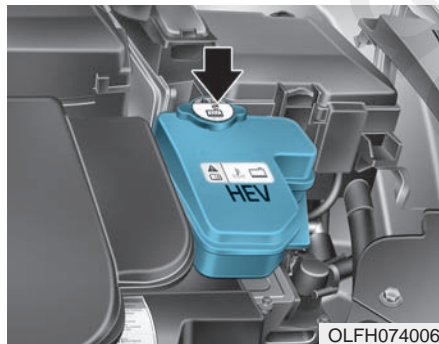

Check the condition and connections of all cooling system hoses and heater hoses. Replace any swollen or deteriorated hoses.

The coolant level should be filled between the MAX and the MIN marks on the side of the coolant reservoir when the engine is cool.

If the coolant level is low, add enough distilled (deionized) water to bring the level to the MAX mark, but do not overfill. If frequent additions are required, we recommend that you see an authorized HYUNDAI dealer for a cooling system inspection.

Recommended coolant

- When adding coolant, use only deionized water, distilled water or soft water for your vehicle and never mix hard water in the coolant filled at the factory.
- An improper coolant mixture can result in severe malfunction or engine/ hybrid system damage.
- The engine in your vehicle has aluminum engine parts and must be protected by an phosphate-based ethylene glycol coolant to prevent corrosion and freezing.
- Do not use alcohol or methanol coolant or mix them with the specified coolant.
- Do not use a solution that contains more than 60% antifreeze or less than 35% antifreeze, which would reduce the effectiveness of the solution.

For mixing percentage, refer to the following table:

Ambient Temperature	Mixture Percentage (volume)	
	Antifreeze	Water
5°F (-15°C)	35	65
-13°F (-25°C)	40	60
-31°F (-35°C)	50	50
-49°F (-45°C)	60	40

i Information

If in doubt about the mix ratio, a 50% water and 50% antifreeze mix is the easiest to mix together as it will be the same quantity of each. It is suitable to use for most temperature ranges of -31°F and higher.

Changing engine coolant

Have coolant changed by an authorized HYUNDAI dealer according to the Maintenance Schedule at the beginning of this chapter.

WARNING

Do not use engine coolant or antifreeze in the washer fluid reservoir.

Engine coolant can severely obscure visibility when sprayed on the windshield and may cause loss of vehicle control resulting in an accident.

Engine coolant may also cause damage to paint and body trim.

NOTICE

To prevent damage to engine parts, put a thick towel around the radiator cap before refilling the coolant to prevent the coolant from overflowing into engine parts, such as the generator.

HYBRID STARTER & GENERATOR (HSG) BELT

Checking the hybrid starter & generator (HSG) belt

Have the hybrid starter & generator (HSG) belt inspected or replaced according to the Maintenance Schedule in this chapter by an authorized HYUNDAI dealer.

CAUTION

When the HSG belt is worn out or damaged, replace the belt.

Otherwise, it may cause engine overheating or battery discharge.

WARNING

- Turn the vehicle off while you inspect the engine or hybrid starter & generator(HSG) belt. Otherwise it may result in serious injury.
- Keep hands, clothing etc. away from the hybrid starter & generator (HSG) belt.

BRAKE FLUID

Checking the brake fluid level

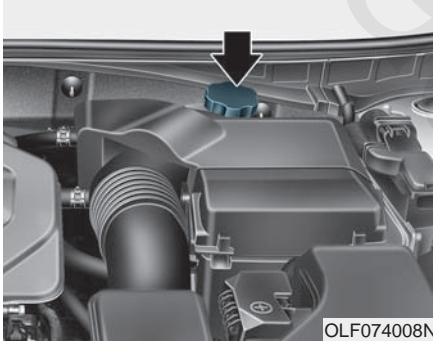

Check the fluid level in the reservoir periodically. The fluid level should be between MAX and MIN marks on the side of the reservoir.

Before removing the reservoir cap and adding brake fluid, clean the area around the reservoir cap thoroughly to prevent brake fluid contamination.

If the level is low, add the specified brake fluid to the MAX level. The level will fall with accumulated mileage. This is a normal condition associated with the wear of the brake linings. If the fluid level is excessively low, have the brake system checked by an authorized HYUNDAI dealer.

! WARNING

If the brake system requires frequent additions of fluid this could indicate a leak in the brake system. Have the vehicle inspected by an authorized HYUNDAI dealer.

! WARNING

Do not allow brake fluid to come in contact with your eyes. If brake fluid comes in contact with your eyes, flush your eyes with clean water for at least 15 minutes and get immediate medical attention.

NOTICE

- Do not allow brake fluid to contact the vehicle's body paint, as paint damage will result.
- Brake fluid, which has been exposed to open air for an extended time should NEVER be used as its quality cannot be guaranteed. It should be disposed of properly.
- Do not use the wrong kind of brake fluid. A few drops of mineral based oil, such as engine oil, in your brake system can damage brake system parts.

i Information

Use only the specified brake fluid (refer to "Recommended Lubricants and Capacities" in chapter 8).

WASHER FLUID

Checking the washer fluid level

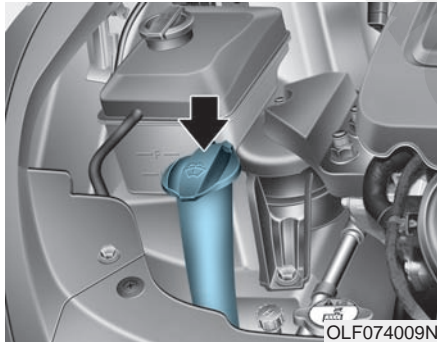

Check the fluid level in the washer fluid reservoir and add fluid if necessary. Plain water may be used if washer fluid is not available. However, use washer solvent with antifreeze characteristics in cold climates to prevent freezing.

⚠ WARNING

To prevent serious injury or death, take the following safety precautions when using washer fluid:

- Do not use engine coolant or antifreeze in the washer fluid reservoir.
- Engine coolant can severely obscure visibility when sprayed on the windshield and may cause loss of vehicle control resulting in an accident or damage to paint and body trim.
- Do not allow sparks or flame to contact the washer fluid or the washer fluid reservoir. Washer fluid may contain alcohol and can be flammable.
- Do not drink washer fluid and avoid contact with skin. Washer fluid is poisonous to humans and animals.
- Keep washer fluid away from children and animals.

PARKING BRAKE

Checking the parking brake

Foot type

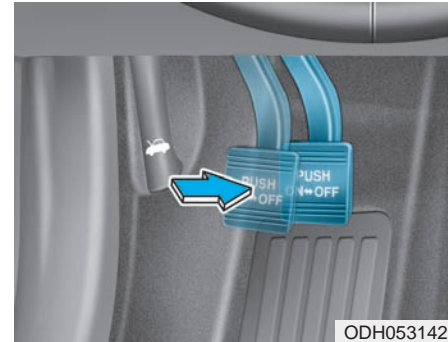

Check whether the stroke is within specification when the parking brake pedal is depressed with 44 lb (20 kg, 196 N) of force. Also, the parking brake alone should securely hold the vehicle on a fairly steep grade. If the stroke is more or less than specified, have the parking brake adjusted by an authorized HYUNDAI dealer.

Stroke : 3 notch

AIR CLEANER

Filter replacement

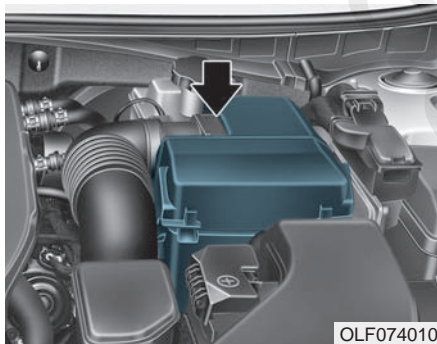

The air cleaner filter can be cleaned for inspection using compressed air. Do not attempt to wash or to rinse it, as water will damage the filter. If soiled, the air cleaner filter must be replaced.

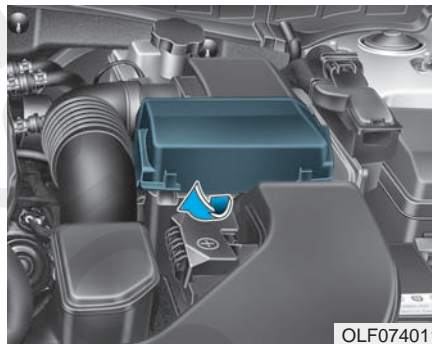

1. Remove the air cleaner filter cover.
2. Wipe the inside of the air cleaner.

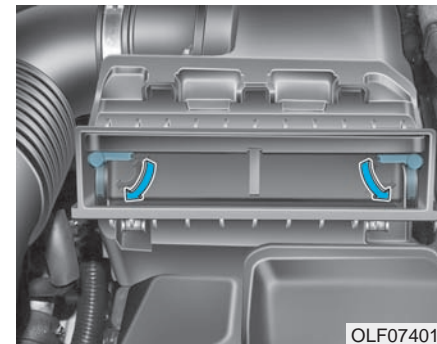

3. Pull down the lever to the UNLOCK position.

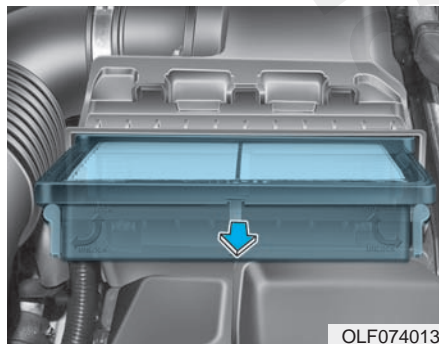

4. Replace the air cleaner filter.

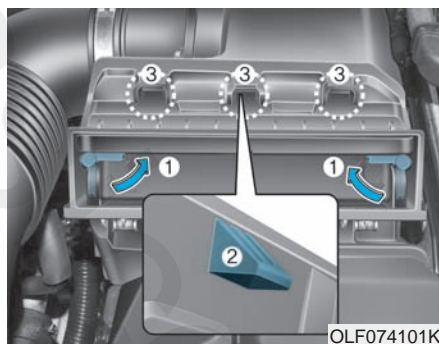

5. Pull up the lever (1) to the LOCK position.

6. Install the cover and make sure the inner hooks/bosses (2) are hung on the hooks (3).

7. Check if the cover is firmly installed.

i Information

If the vehicle is operated in extremely dusty or sandy areas, replace the element more often than the usual recommended intervals (refer to “Maintenance Under Severe Usage Conditions” in this chapter).

NOTICE

- Do not drive with the air cleaner filter removed. This will result in excessive engine wear.
- When removing the air cleaner filter, be careful that dust or dirt does not enter the air intake, or damage may result.
- Use HYUNDAI genuine parts, use of non-genuine parts could damage the air flow sensor.

CLIMATE CONTROL AIR FILTER

Filter inspection

The climate control air filter should be replaced according to the Maintenance Schedule. If the vehicle is operated in severely air-polluted cities or on dusty rough roads for a long period, it should be inspected more frequently and replaced earlier. When you replace the climate control air filter, replace it performing the following procedure, and be careful to avoid damaging other components.

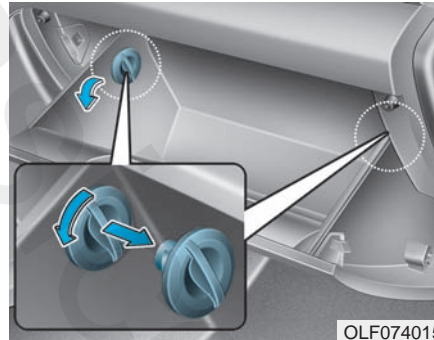

1. With the glove box open, remove the stoppers on both sides to allow the glove box to hang freely on the hinges.

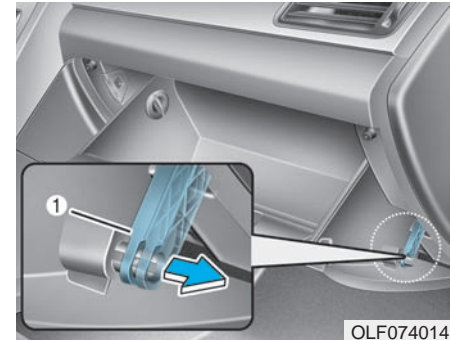

2. Remove the support rod (1).

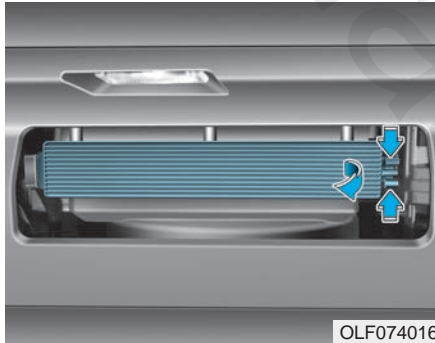

3. Remove the climate control air filter case by pulling out the right side of the cover.

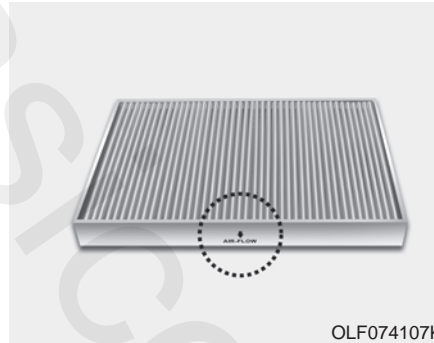

4. Replace the climate control air filter.
5. Reassemble in the reverse order of disassembly.

NOTICE

Install a new climate control air filter in the correct direction with the arrow symbol (↓) facing downwards. Otherwise, the climate control effects may decrease, possibly with a noise.

WIPER BLADES

Blade inspection

Contamination of either the windshield or the wiper blades with foreign matter can reduce the effectiveness of the windshield wipers. Common sources of contamination are insects, tree sap, and hot wax treatments used by some commercial car washes. If the blades are not wiping properly, clean both the window and the blades with a clean cloth dampened with washer fluid.

NOTICE

To prevent damage to the wiper blades, arms or other components, do not:

- Use gasoline, kerosene, paint thinner, or other solvents on or near them.
- Attempt to move the wipers manually.
- Use non-specified wiper blades.

i Information

Commercial hot waxes applied by automatic car washes have been known to make the windshield difficult to clean.

Blade replacement

When the wipers no longer clean adequately, the blades may be worn or cracked, and require replacement.

NOTICE

To prevent damage to the wiper arms or other components, do not attempt to move the wipers manually.

NOTICE

The use of a non-specified wiper blade could result in wiper malfunction and failure.



1. Raise the wiper arm.

NOTICE

Do not allow the wiper arm to fall against the windshield, since it may chip or crack the windshield.

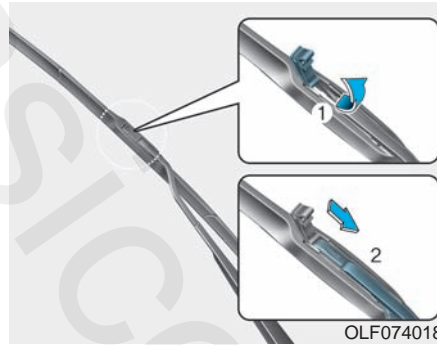

2. Lift the wiper blade clip. Then push down the blade body.

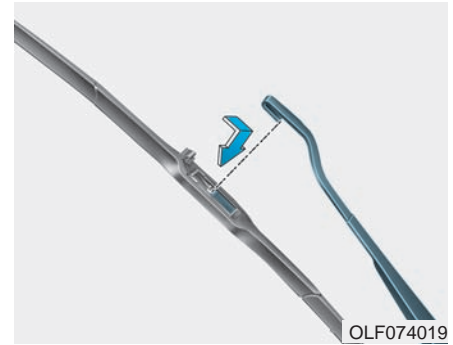

3. Install the new blade assembly in the reverse order of removal.
4. Return the wiper arm on the windshield.

BATTERY

WARNING

To prevent **SERIOUS INJURY** or **DEATH** to you or bystanders, always follow these precautions when working near or handling the battery:



Always read and follow instructions carefully when handling a battery.



Wear eye protection designed to protect the eyes from acid splashes.



Keep all flames, sparks, or smoking materials away from the battery.



Hydrogen is always present in battery cells, is highly combustible, and may explode if ignited.



Keep batteries out of reach of children.

(Continued)

(Continued)



Batteries contain sulfuric acid which is highly corrosive. Do not allow acid to contact your eyes, skin or clothing.

If acid gets into your eyes, flush your eyes with clean water for at least 15 minutes and get immediate medical attention. If acid gets on your skin, thoroughly wash the area. If you feel pain or a burning sensation, get medical attention immediately.

- When lifting a plastic-cased battery, excessive pressure on the case may cause battery acid to leak. Lift with a battery carrier or with your hands on opposite corners.
- Do not attempt to jump start your vehicle if your battery is frozen.

(Continued)

(Continued)

- **NEVER** attempt to recharge the battery when the vehicle's battery cables are connected to the battery.
- The electrical ignition system works with high voltage. **NEVER** touch these components with the engine running or when the Engine Start/Stop button is in the ON position.

⚠ WARNING

**CALIFORNIA PROPOSITION 65
WARNING**

Battery posts, terminals, and related accessories contain lead and lead compounds, chemicals known to the State of California to cause cancer, birth defects and reproductive harm. Batteries also contain other chemicals known to the State of California to cause cancer. Wash hands after handling.

NOTICE

- When you do not use the vehicle for a long time in a low temperature area, disconnect the battery and keep it indoors.
- Always charge the battery fully to prevent battery case damage in low temperature areas.

For best battery service



- Keep the battery securely mounted.
- Keep the battery top clean and dry.
- Keep the terminals and connections clean, tight, and coated with petroleum jelly or terminal grease.
- Rinse any spilled acid from the battery immediately with a solution of water and baking soda.

Battery recharging

⚠ WARNING

Always follow these instructions when recharging your vehicle's battery to avoid the risk of **SERIOUS INJURY** or **DEATH** from explosions or acid burns:

- Before performing maintenance or recharging the battery, turn off all accessories and place the Engine Start/Stop button to the OFF position.
- Keep all flames, sparks, or smoking materials away from the battery.
- Always work outdoors or in an area with plenty of ventilation.
- Wear eye protection when checking the battery during charging.
- The battery must be removed from the vehicle and placed in a well ventilated area.

(Continued)

(Continued)

- **Watch the battery during charging, and stop or reduce the charging rate if the battery cells begin boiling violently.**
- **The negative battery cable must be removed first and installed last when the battery is disconnected. Disconnect the battery charger in the following order:**
 - (1) Turn off the battery charger main switch.
 - (2) Unhook the negative clamp from the negative battery terminal.
 - (3) Unhook the positive clamp from the positive battery terminal.
- **Always use a genuine HYUNDAI approved battery when you replace the battery.**

By jump starting

After a jump start from a good battery, drive the vehicle for 20-30 minutes before it is shutoff. The vehicle may not restart if you shut it off before the battery had a chance to adequately recharge. See “Jump Starting” in chapter 6 for more information on jump starting procedures.

i Information



An inappropriately disposed battery can be harmful to the environment and human health.

Dispose the battery according to your local law(s) or regulation.

Reset features

Some items need to be reset after the battery has been discharged or the battery has been disconnected. See chapter 3 for:

- Power Windows
- Trip Computer
- Climate Control System
- Clock
- Audio System
- Sunroof

TIRES AND WHEELS

WARNING

Tire failure may cause loss of vehicle control resulting in an accident. To reduce risk of **SERIOUS INJURY** or **DEATH**, take the following precautions:

- Inspect your tires monthly for proper inflation as well as wear and damage.
- The recommended cold tire pressure for your vehicle can be found in this manual and on the tire label located on the driver's side center pillar. Always use a tire pressure gauge to measure tire pressure. Tires with too much or too little pressure wear unevenly causing poor handling.
- Check the pressure of the spare every time you check the pressure of the other tires on your vehicle.

(Continued)

(Continued)

- Replace tires that are worn, show uneven wear, or are damaged. Worn tires can cause loss of braking effectiveness, steering) control, or traction.
- **ALWAYS** replace tires with the same size as each tire that was originally supplied with this vehicle. Using tires and wheels other than the recommended sizes could cause unusual handling characteristics, poor vehicle control, or negatively affect your vehicle's Anti-Lock Brake System (ABS) resulting in a serious accident.

Tire care

For proper maintenance, safety, and maximum fuel economy, you must always maintain recommended tire inflation pressures and stay within the load limits and weight distribution recommended for your vehicle.

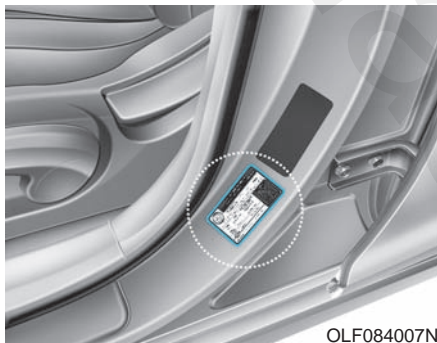

OLF084007N

All specifications (sizes and pressures) can be found on a label attached to the driver's side center pillar.

Recommended cold tire inflation pressures

All tire pressures (including the spare) should be checked when the tires are cold. "Cold tires" means the vehicle has not been driven for at least three hours or driven less than one mile (1.6 km).

Warm tires normally exceed recommended cold tire pressures by 4 to 6 psi (28 to 41 kPa). Do not release air from warm tires to adjust the pressure or the tires will be under-inflated. For recommended inflation pressure, refer to "Tire and Wheels" in chapter 8.

WARNING

Recommended pressures must be maintained for the best ride, vehicle handling, and minimum tire wear.

Over-inflation or under-inflation can reduce tire life, adversely affect vehicle handling, and lead to sudden tire failure that could result in loss of vehicle control resulting in an accident.

Severe under-inflation can lead to severe heat build-up, causing blowouts, tread separation and other tire failures that can result in the loss of vehicle control resulting in an accident. This risk is much higher on hot days and when driving for long periods at high speeds.

 **CAUTION**

- **Under-inflation results in excessive wear, poor handling and reduced fuel economy. Wheel deformation is also possible. Keep your tire pressures at the proper levels. If a tire frequently needs refilling, have it checked by an authorized HYUNDAI dealer.**
- **Over-inflation produces a harsh ride, excessive wear at the center of the tire tread, and a greater possibility of damage from road hazards.**

Check tire inflation pressure

Check your tires, including the spare tire, once a month or more.

How to check

Use a good quality tire pressure gauge to check tire pressure. You can not tell if your tires are properly inflated simply by looking at them. Radial tires may look properly inflated when they are under-inflated.

Remove the valve cap from the tire valve stem. Press the tire gauge firmly onto the valve to get a pressure measurement. If the cold tire inflation pressure matches the recommended pressure on the tire and loading information label, no further adjustment is necessary. If the pressure is low, add air until you reach the recommended pressure. Make sure to put the valve caps back on the valve stems. Without the valve cap, dirt or moisture could get into the valve core and cause air leakage. If a valve cap is missing, install a new one as soon as possible.

If you overfill the tire, release air by pushing on the metal stem in the center of the tire valve. Recheck the tire pressure with the tire gauge. Be sure to put the valve caps back on the valve stems. Without the valve cap, dirt or moisture could get into the valve core and cause air leakage. If a valve cap is missing, install a new one as soon as possible.

Tire rotation

To equalize tread wear, HYUNDAI recommends that the tires be rotated every 7,500 miles (12,000 km) or sooner if irregular wear develops.

During rotation, check the tires for correct balance.

When rotating tires, check for uneven wear and damage. Abnormal wear is usually caused by incorrect tire pressure, improper wheel alignment, out-of-balance wheels, severe braking or severe cornering. Look for bumps or bulges in the tread or side of tire. Replace the tire if you find either of these conditions. Replace the tire if fabric or cord is visible. After rotation, be sure to bring the front and rear tire pressures to specification and check lug nut tightness (proper torque is 65-79 lb.ft [9-11 kg.m]).

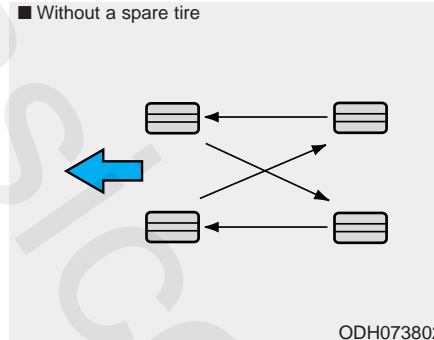

Disc brake pads should be inspected for wear whenever tires are rotated.

Information

The outside and inside of the unsymmetrical tire is distinguishable. When installing an unsymmetrical tire, be sure to install the side marked "outside" face the outside. If the side marked "inside" is installed on the outside, it will have a bad effect on vehicle performance.

⚠ WARNING

- Do not use the compact spare tire for tire rotation.
- Do not mix bias ply and radial ply tires under any circumstances. This may cause unusual handling characteristics that may cause loss of vehicle control resulting in an accident.

Wheel alignment and tire balance

The wheels on your vehicle were aligned and balanced carefully at the factory to give you the longest tire life and best overall performance.

In most cases, you will not need to have your wheels aligned again. However, if you notice unusual tire wear or your vehicle pulling one way or the other, the alignment may need to be reset.

If you notice your vehicle vibrating when driving on a smooth road, your wheels may need to be rebalanced.

NOTICE

Improper wheel weights can damage your vehicle's aluminum wheels. Use only approved wheel weights.

Tire replacement



If the tire is worn evenly, a tread wear indicator will appear as a solid band across the tread. This shows there is less than 1/16 inch (1.6 mm) of tread left on the tire. Replace the tire when this happens.

Do not wait for the band to appear across the entire tread before replacing the tire.

⚠ WARNING

To reduce the risk of DEATH or SERIOUS INJURY:

- Replace tires that are worn, show uneven wear, or are damaged. Worn tires can cause loss of braking effectiveness, steering control, and traction.
- Always replace tires with the same size as each tire that was originally supplied with this vehicle. Using tires and wheels other than the recommended sizes could cause unusual handling characteristics, poor vehicle control, or negatively affect your vehicle's Anti-Lock Brake System (ABS) resulting in a serious accident.

(Continued)

(Continued)

- **Tires degrade over time, even when they are not being used. Regardless of the remaining tread, HYUNDAI recommends that tires be replaced after six (6) years of normal service.**
- **Heat caused by hot climates or frequent high loading conditions can accelerate the aging process. Failure to follow this warning may cause sudden tire failure, which could lead to a loss of vehicle control resulting in an accident.**

Compact spare tire replacement

A compact spare tire has a shorter tread life than a regular size tire. Replace it when you can see the tread wear indicator bars on the tire. The replacement compact spare tire should be the same size and design tire as the one provided with your new vehicle and should be mounted on the same compact spare tire wheel. The compact spare tire is not designed to be mounted on a regular size wheel, and the compact spare tire wheel is not designed for mounting a regular size tire.

⚠ WARNING

The original tire should be repaired or replaced as soon as possible to avoid failure of the spare and loss of vehicle control resulting in an accident. The compact spare tire is for emergency use only. Do not operate your vehicle over 50 mph (80 km/h) when using the compact spare tire.

Wheel replacement

When replacing the metal wheels for any reason, make sure the new wheels are equivalent to the original factory units in diameter, rim width and offset.

Tire traction

Tire traction can be reduced if you drive on worn tires, tires that are improperly inflated or on slippery road surfaces. Tires should be replaced when tread wear indicators appear. To reduce the possibility of losing control, slow down whenever there is rain, snow or ice on the road.

Tire maintenance

In addition to proper inflation, correct wheel alignment helps to decrease tire wear. If you find a tire is worn unevenly, have your dealer check the wheel alignment.

When you have new tires installed, make sure they are balanced. This will increase vehicle ride comfort and tire life. Additionally, a tire should always be rebalanced if it is removed from the wheel.

Tire sidewall labeling

This information identifies and describes the fundamental characteristics of the tire and also provides the tire identification number (TIN) for safety standard certification. The TIN can be used to identify the tire in case of a recall.

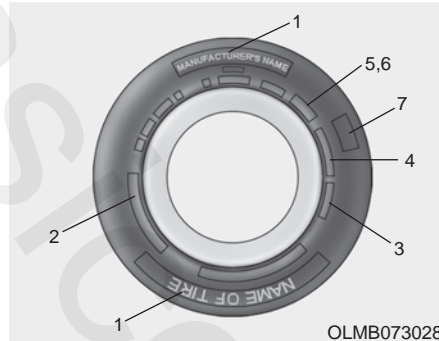

1. Manufacturer or brand name

Manufacturer or brand name is shown.

2. Tire size designation

A tire's sidewall is marked with a tire size designation. You will need this information when selecting replacement tires for your car. The following explains what the letters and numbers in the tire size designation mean.

Example tire size designation:

(These numbers are provided as an example only; your tire size designator could vary depending on your vehicle.)

205/65R16 95H

205 - Tire width in millimeters.

65 - Aspect ratio. The tire's section height as a percentage of its width.

R - Tire construction code (Radial).

16 - Rim diameter in inches.

95 - Load Index, a numerical code associated with the maximum load the tire can carry.

H - Speed Rating Symbol. See the speed rating chart in this section for additional information.

Wheel size designation

Wheels are also marked with important information that you need if you ever have to replace one. The following explains what the letters and numbers in the wheel size designation mean.

Example wheel size designation:

6.5JX16

6.5 - Rim width in inches.

J - Rim contour designation.

16 - Rim diameter in inches.

Tire speed ratings

The chart below lists many of the different speed ratings currently being used for passenger car tires. The speed rating is part of the tire size designation on the sidewall of the tire. This symbol corresponds to that tire's designed maximum safe operating speed.

Speed Rating Symbol	Maximum Speed
S	112 mph (180 km/h)
T	118 mph (190 km/h)
H	130 mph (210 km/h)
V	149 mph (240 km/h)
Z	Above 149 mph (240 km/h)

3. Checking tire life (TIN : Tire Identification Number)

Any tires that are over six years old, based on the manufacturing date, (including the spare tire) should be replaced by new ones. You can find the manufacturing date on the tire sidewall (possibly on the inside of the wheel), displaying the DOT Code. The DOT Code is a series of numbers on a tire consisting of numbers and English letters. The manufacturing date is designated by the last four digits (characters) of the DOT code.

DOT : XXXX XXXX OOOO

The front part of the DOT means a plant code number, tire size and tread pattern and the last four numbers indicate week and year manufactured.

For example:

DOT XXXX XXXX 1615 represents that the tire was produced in the 16th week of 2015.

4. Tire ply composition and material

The number of layers or plies of rubber-coated fabric in the tire. Tire manufacturers also must indicate the materials in the tire, which include steel, nylon, polyester, and others. The letter "R" means radial ply construction; the letter "D" means diagonal or bias ply construction; and the letter "B" means belted-bias ply construction.

5. Maximum permissible inflation pressure

This number is the greatest amount of air pressure that should be put in the tire. Do not exceed the maximum permissible inflation pressure. Refer to the Tire and Loading Information label for recommended inflation pressure.

6. Maximum load rating

This number indicates the maximum load in kilograms and pounds that can be carried by the tire. When replacing the tires on the vehicle, always use a tire that has the same load rating as the factory installed tire.

7. Uniform tire quality grading

Quality grades can be found where applicable on the tire sidewall between tread shoulder and maximum section width.

For example:

TREAD wear 200
TRACTION AA
TEMPERATURE A

Tread wear

The tread wear grade is a comparative rating based on the wear rate of the tire when tested under controlled conditions on a specified government test course. For example, a tire graded 150 would wear one-and-a-half times ($1\frac{1}{2}$) as well on the government course as a tire graded 100.

The relative performance of tires depends upon the actual conditions of their use, however, and may depart significantly from the norm due to variations in driving habits, service practices and differences in road characteristics and climate.

These grades are molded on the sidewalls of passenger vehicle tires. The tires available as standard or optional equipment on your vehicle may vary with respect to grade.

Traction - AA, A, B & C

The traction grades, from highest to lowest, are AA, A, B and C. Those grades represent the tire's ability to stop on wet pavement as measured under controlled conditions on specified government test surfaces of asphalt and concrete. A tire marked C may have poor traction performance.

WARNING

The traction grade assigned to this tire is based on straight-ahead braking traction tests, and does not include acceleration, cornering, hydroplaning, or peak traction characteristics.

Temperature - A, B & C

The temperature grades are A (the highest), B and C representing the tire's resistance to the generation of heat and its ability to dissipate heat when tested under controlled conditions on a specified indoor laboratory test wheel.

Sustained high temperature can cause the material of the tire to degenerate and reduce tire life, and excessive temperature can lead to sudden tire failure. Grade C responds to a level of performance which all passenger car tires must meet under the Federal Motor Vehicle Safety Standard No. 109. Grades B and A represent higher levels of performance on the laboratory test wheel than the minimum required by law.

WARNING

The temperature grade for this tire is established for a tire that is properly inflated and not overloaded. Excessive speed, under-inflation, over-inflation, or excessive loading, either separately or in combination, can cause heat build-up and possible sudden tire failure. This may cause loss of vehicle control resulting in an accident.

Tire terminology and definitions

Air Pressure

The amount of air inside the tire pressing outward on the tire. Air pressure is expressed in pounds per square inch (psi) or kilopascal (kPa).

Accessory Weight

This means the combined weight of optional accessories. Some examples of optional accessories are automatic transaxle, power seats, and air conditioning.

Aspect Ratio

The relationship of a tire's height to its width.

Belt

A rubber coated layer of cords that is located between the plies and the tread. Cords may be made from steel or other reinforcing materials.

Bead

The tire bead contains steel wires wrapped by steel cords that hold the tire onto the rim.

Bias Ply Tire

A pneumatic tire in which the plies are laid at alternate angles less than 90 degrees to the centerline of the tread.

Cold Tire Pressure

The amount of air pressure in a tire, measured in pounds per square inch (psi) or kilopascals (kPa) before a tire has built up heat from driving.

Curb Weight

This means the weight of a motor vehicle with standard and optional equipment including the maximum capacity of fuel, oil and coolant, but without passengers and cargo.

DOT Markings

A code molded into the sidewall of a tire signifying that the tire is in compliance with the U.S. Department of Transportation motor vehicle safety standards. The DOT code includes the Tire Identification Number (TIN), an alphanumeric designator which can also identify the tire manufacturer, production plant, brand and date of production.

GVWR

Gross Vehicle Weight Rating

GAWR FRT

Gross Axle Weight Rating for the Front Axle.

GAWR RR

Gross Axle Weight Rating for the Rear axle.

Intended Outboard Sidewall

The side of an asymmetrical tire, that must always face outward when mounted on a vehicle.

Kilopascal (kPa)

The metric unit for air pressure.

Light truck (LT) tire

A tire designated by its manufacturer as primarily intended for use on light-weight trucks or multipurpose passenger vehicles.

Load ratings

The maximum load that a tire is rated to carry for a given inflation pressure.

Load Index

An assigned number ranging from 1 to 279 that corresponds to the load carrying capacity of a tire.

Maximum Inflation Pressure

The maximum air pressure to which a cold tire may be inflated. The maximum air pressure is molded onto the sidewall.

Maximum Load Rating

The load rating for a tire at the maximum permissible inflation pressure for that tire.

Maximum Loaded Vehicle Weight

The sum of curb weight; accessory weight; vehicle capacity weight; and production options weight.

Normal Occupant Weight

The number of occupants a vehicle is designed to seat multiplied by 150 pounds (68 kg).

Occupant Distribution

Designated seating positions.

Outward Facing Sidewall

An asymmetrical tire has a particular side that faces outward when mounted on a vehicle. The outward facing sidewall bears white lettering or bears manufacturer, brand, and/or model name molding that is higher or deeper than the same moldings on the inner facing sidewall.

Passenger (P-Metric) tire

A tire used on passenger cars and some light duty trucks and multipurpose vehicles.

Ply

A layer of rubber-coated parallel cords

Pneumatic tire

A mechanical device made of rubber, chemicals, fabric and steel or other materials, that, when mounted on an automotive wheel, provides the traction and contains the gas or fluid that sustains the load.

Production options weight

The combined weight of installed regular production options weighing over 5 lb.(2.3 kg) in excess of the standard items which they replace, not previously considered in curb weight or accessory weight, including heavy duty brakes, ride levelers, roof rack, heavy duty battery, and special trim.

Recommended Inflation Pressure

Vehicle manufacturer's recommended tire inflation pressure as shown on the tire placard.

Radial Ply Tire

A pneumatic tire in which the ply cords that extend to the beads are laid at 90 degrees to the centerline of the tread.

Rim

A metal support for a tire and upon which the tire beads are seated.

Sidewall

The portion of a tire between the tread and the bead.

Speed Rating

An alphanumeric code assigned to a tire indicating the maximum speed at which a tire can operate.

Traction

The friction between the tire and the road surface. The amount of grip provided.

Tread

The portion of a tire that comes into contact with the road.

Treadwear Indicators

Narrow bands, sometimes called "wear bars," that show across the tread of a tire when only 1/16 inch of tread remains.

UTQGS

Uniform Tire Quality Grading Standards is a tire information system that provides consumers with ratings for a tire's traction, temperature and treadwear. Ratings are determined by tire manufacturers using government testing procedures. The ratings are molded into the sidewall of the tire.

Vehicle Capacity Weight

The number of designated seating positions multiplied by 150 lbs. (68 kg) plus the rated cargo and luggage load.

Vehicle Maximum Load on the Tire

Load on an individual tire due to curb and accessory weight plus maximum occupant and cargo weight.

Vehicle Normal Load on the Tire

Load on an individual tire that is determined by distributing to each axle its share of the curb weight, accessory weight, and normal occupant weight and dividing by 2.

Vehicle Placard

A label permanently attached to a vehicle showing the original equipment tire size and recommended inflation pressure.

All season tires

HYUNDAI specifies all season tires on some models to provide good performance for use all year round, including snowy and icy road conditions. All season tires are identified by ALL SEASON and/or M+S (Mud and Snow) on the tire sidewall. Snow tires have better snow traction than all season tires and may be more appropriate in some areas.

Summer tires

HYUNDAI specifies summer tires on some models to provide superior performance on dry roads. Summer tire performance is substantially reduced in snow and ice. Summer tires do not have the tire traction rating M+S (Mud and Snow) on the tire side wall. If you plan to operate your vehicle in snowy or icy conditions, HYUNDAI recommends the use of snow tires or all season tires on all four wheels.

Snow tires

If you equip your car with snow tires, they should be the same size and have the same load capacity as the original tires. Snow tires should be installed on all four wheels; otherwise, poor handling may result. Snow tires should carry 4 psi (28 kPa) more air pressure than the pressure recommended for the standard tires on the tire label on the driver's side of the center pillar, or up to the maximum pressure shown on the tire sidewall, whichever is less. Do not drive faster than 75 mph (120 km/h) when your vehicle is equipped with snow tires.

Radial-ply tires

Radial-ply tires provide improved tread life, road hazard resistance and smoother high speed ride. The radial-ply tires used on this vehicle are of belted construction, and are selected to complement the ride and handling characteristics of your vehicle. Radial-ply tires have the same load carrying capacity, as bias-ply or bias belted tires of the same size, and use the same recommended inflation pressure. Mixing of radial-ply tires with bias-ply or bias belted tires is not recommended. Any combinations of radial-ply and bias-ply or bias belted tires when used on the same vehicle will seriously deteriorate vehicle handling. The best rule to follow is: Identical pairs of radial-ply tires should always be used as a set for the front tires and a set for the rear tires.

Longer wearing tires can be more susceptible to irregular tread wear. It is very important to follow the tire rotation interval in this chapter to achieve the tread life potential of these tires. Cuts and punctures in radial-ply tires are repairable only in the tread area, because of sidewall flexing. Consult your tire dealer for radial-ply tire repairs.

WARNING

Do not mix bias ply and radial ply tires under any circumstances. This may cause unusual handling characteristics that may cause loss of vehicle control resulting in an accident.

Low aspect ratio tires

Low aspect ratio tires, the aspect ratio is lower than 50, are provided for sporty looks.

Because low aspect ratio tires are optimized for handling and braking, it may be more uncomfortable to ride in and there is more noise compare with normal tires.

 **CAUTION**

Because the sidewall of the low aspect ratio tire is shorter than the normal, the wheel and tire of the low aspect ratio tire is easier to be damaged. So, follow the instructions below.

- When driving on a rough road or off road, drive cautiously because tires and wheels may be damaged. And after driving, inspect tires and wheels.
- When passing over a pothole, speed bump, manhole, or curb stone, drive slowly so that the tires and wheels are not damaged.
- If the tire is impacted, inspect the tire condition or contact an authorized HYUNDAI dealer.
- To prevent damage to the tire, inspect the tire condition and pressure every 1,800 miles (3,000km).

 **CAUTION**

- It is not easy to recognize tire damage with your own eyes. But if there is the slightest hint of tire damage, have the tire checked or replaced because the tire damage may cause air leakage from the tire.
- If the tire is damaged by driving on a rough road, off road, pothole, manhole, or curb stone, it will not be covered by the warranty.

FUSES

■ Blade type



Normal



Blown

■ Cartridge type



Normal



Blown

■ Multi fuse

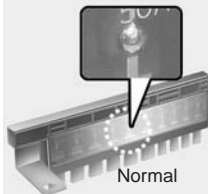

Normal

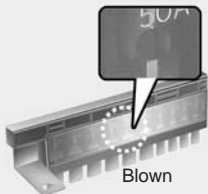

Blown



Normal



Blown

OLF074075

A vehicle's electrical system is protected from electrical overload damage by fuses.

This vehicle has 2 (or 3) fuse panels, one located in the driver's side panel bolster, the other in the engine compartment near the battery.

If any of your vehicle's lights, accessories, or controls do not work, check the appropriate circuit fuse. If a fuse has blown, the element inside the fuse will be melted or broken.

If the electrical system does not work, first check the driver's side fuse panel. Before replacing a blown fuse, turn the engine and all switches off, and then disconnect the negative battery cable. Always replace a blown fuse with one of the same rating.

If the replacement fuse blows, this indicates an electrical problem. Avoid using the system involved and immediately consult an authorized HYUNDAI dealer.

Information

Three kinds of fuses are used: blade type for lower amperage rating, cartridge type, and fusible link for higher amperage ratings.

WARNING

NEVER replace a fuse with anything but another fuse of the same rating.

- A higher capacity fuse could cause damage and possibly cause a fire.
- Do not install a wire or aluminum foil instead of the proper fuse - even as a temporary repair. It may cause extensive wiring damage and possibly a fire.

CAUTION

Do not use a screwdriver or any other metal object to remove fuses because it may cause a short circuit and damage the system.

Instrument panel fuse replacement



1. Turn the hybrid system off.
2. Turn all other switches OFF.
3. Open the fuse panel cover.
4. Refer to the label on the inside of the fuse panel cover to locate the suspected fuse location.

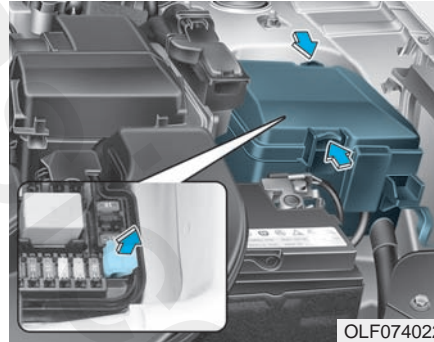

5. Pull the suspected fuse straight out. Use the removal tool provided in the engine compartment fuses panel.
6. Check the removed fuse; replace it if it is blown. Spare fuses are provided in the instrument panel fuse panels (or in the engine compartment fuse panel).
7. Push in a new fuse of the same rating, and make sure it fits tightly in the clips. If it fits loosely, consult an authorized HYUNDAI dealer.

In an emergency, if you do not have a spare fuse, use a fuse of the same rating from a circuit you may not need for operating the vehicle, such as the cigarette lighter fuse.

If the headlamps or other electrical components do not work and the fuses are OK, check the fuse panel in the engine compartment. If a fuse is blown, it must be replaced with the same rating.

Fuse switch



Always, place the fuse switch to the ON position.

If you move the switch to the OFF position, some items such as the audio system and digital clock must be reset and the smart key may not work properly.

Information

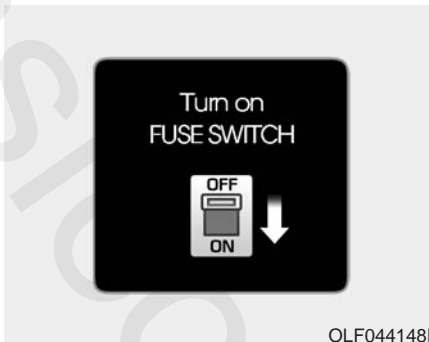

If the fuse switch is OFF, the above message will appear.

NOTICE

- **Always place the fuse switch in the ON position while driving the vehicle.**
- **Do not move the transportation fuse switch repeatedly. The fuse switch may be damaged.**

Engine compartment panel fuse replacement

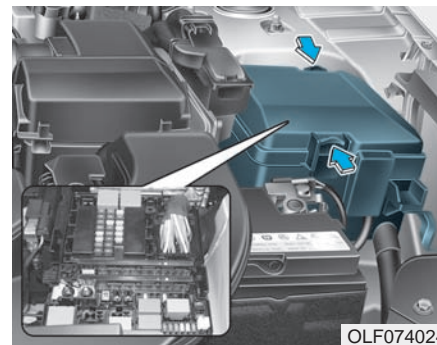

1. Turn the hybrid system off.
2. Turn all other switches OFF.
3. Remove the fuse panel cover by pressing the tap and pulling up.
4. Check the removed fuse; replace it if it is blown. To remove or insert the fuse, use the fuse puller in the engine compartment fuse panel.
5. Push in a new fuse of the same rating, and make sure it fits tightly in the clips. If it fits loosely, consult an authorized HYUNDAI dealer.

Main fuse

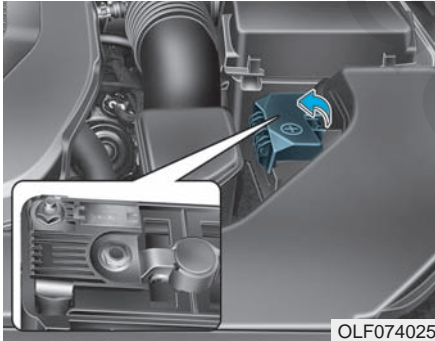

If the main fuse is blown, it must be removed as follows:

1. Turn off the engine.
2. Disconnect the negative battery cable.
3. Remove the fuse panel cover by pressing the tab and pulling it up.
4. Remove the nuts shown in the picture above.
5. Replace the fuse with a new one of the same rating.
6. Reinstall in the reverse order of removal.

i Information

If the main fuse is blown, consult an authorized HYUNDAI dealer.

Multi fuse

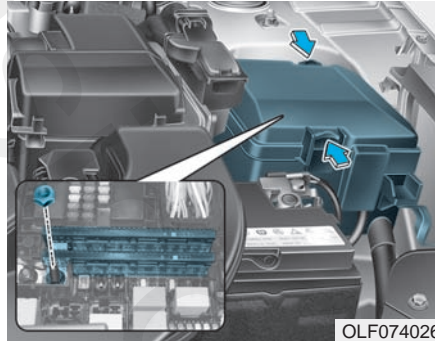

If the multi fuse is blown, it must be removed as follows:

1. Turn off the engine.
2. Disconnect the negative battery cable.
3. Remove the fuse panel cover by pressing the tab and pulling it up.
4. Remove the nuts shown in the picture above.
5. Replace the fuse with a new one of the same rating.
6. Reinstall in the reverse order of removal.

i Information

If the multi fuse is blown, consult an authorized HYUNDAI dealer.

Fuse/relay panel description

Instrument panel fuse panel



OLF074027

Inside the fuse/relay box cover, you can find the fuse/relay label describing fuse/relay name and capacity.

i Information

Not all fuse panel descriptions in this manual may be applicable to your vehicle; the information is accurate at the time of printing. When you inspect the fuse box on your vehicle, refer to the fuse box label.

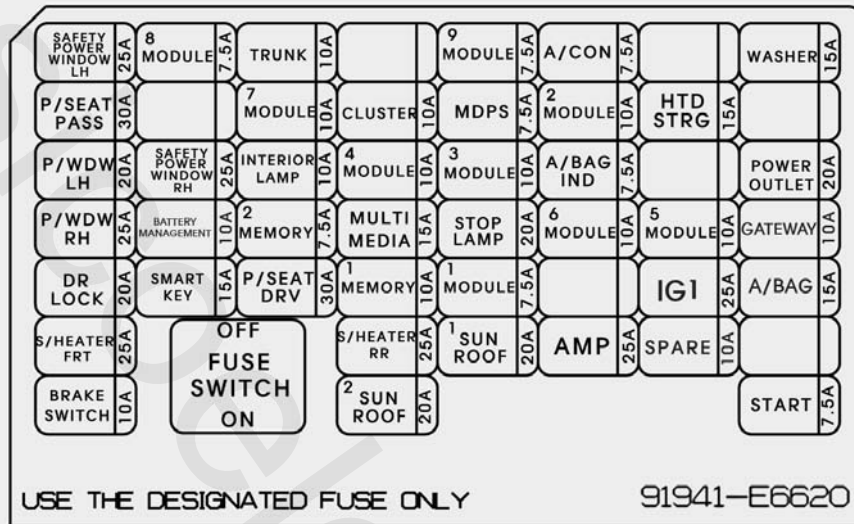

OLF075058N

Instrument panel fuse panel

Fuse Name	Fuse rating	Protected Component
SAFETY WINDOW LH	25A	Driver Safety Power Window Module
P/SEAT PASS	30A	Passenger Seat Manual Switch
P/WDW LH	20A	Power Window Main Switch, Rear Power Window Module LH
P/WDW RH	25A	Power Window Main Switch, Rear Power Window Module RH, Passenger Door Module, Passenger Power Window Switch
DR LOCK	20A	Door Lock Relay, Door Unlock Relay, ICM Relay Box (Two Turn Unlock Relay)
S/HEATER FRT	25A	Front Air Ventilation Seat Module, Front Seat Warmer Module
BRAKE SWITCH	10A	Stop Lamp Switch, Immobilizer Module, Smart Key Control Module
*MODULE	7.5A	BCM, Smart Key Control Module
SAFETY POWER WINDOW RH	25A	Passenger Safety Power Window Module
BATTERY MANAGEMENT	10A	BMS Control Module
SMART KEY	15A	Smart Key Control Module
TRUNK	10A	Trunk Lid Relay, Fuel Filler Door & Trunk Lid Switch
‡MODULE	10A	Driver/Passenger Door Module, Rear Parking Assist Sensor, Electric Parking Brake Module, Digital Clock, Blind Spot Detection Radar
INTERIOR LAMP	10A	Glove Box Lamp, Foot Lamp IND., Driver/Passenger Foot Lamp, Front Vanity Lamp Switch LH/RH, Overhead Console Lamp, Room Lamp, Rear Personal Lamp LH/RH, Trunk Room Lamp, Driver/Passenger Door Lamp
*MEMORY	7.5A	Electro Chromic Mirror
P/SEAT DRV	30A	Driver Seat Manual Switch, Driver IMS Module
CLUSTER	10A	Instrument Cluster

Fuse Name	Fuse rating	Protected Component
⁴ MODULE	10A	Smart Key Control Module
MULTI MEDIA	15A	Audio, A/V & Navigation Head Unit, TMU Unit
¹ MEMORY	10A	Driver/Passenger Door Module, Driver Ims Module, A/C Control Module, Auto Light & Photo Sensor, Rear Curtain Unit, Data Link Connector, Instrument Cluster, Rain Sensor, Tire Pressure Monitoring Module, BCM, Digital Clock, ICM Relay Box (Outside Mirror Folding/Unfolding Relay)
S/HEATER RR	25A	Rear Seat Warmer Module
² SUN ROOF	20A	Panorama Sunroof Motor
⁹ MODULE	7.5A	Front Air Ventilation Seat Module, Front Seat Warmer Module, Rear Seat Warmer Module, Rear Curtain Unit
MDPS	7.5A	MDPS Unit
³ MODULE	10A	BCM, Sport Mode Switch, Stop Lamp Switch
STOP LAMP	20A	Stop Signal Electronic Module
¹ MODULE	7.5A	Natural Vacuum Leak Detection, Active Air Flap, Driver/Passenger Smart Key Outside Handle, Driver/Passenger Power Outside Mirror, Driver/Passenger Door Module
¹ SUN ROOF	20A	Panorama Sunroof Motor
A/CON	7.5A	A/C Control Module, E/R Junction Block (RLY. 3 - Blower Relay), Electronic A/C Compressor
² MODULE	10A	Audio, A/V & Navigation Head Unit, TMU Unit, Digital Clock, BCM, AMP, Power Outside Mirror Switch, Digital Clock, Smart Key Control Module, Overhead Console Lamp
A/BAG IND	7.5A	Instrument Cluster
⁹ MODULE	10A	Multipurpose Check Connector, TMU Unit, A/C Control Module, Vess Unit, Electro Chromic Mirror, Rear Seat Warmer Module, A/T Shift Lever Ind., Front Air Ventilation Seat Module, Front Seat Warmer Module, Auto Head Lamp Leveling Device Module, Head Lamp LH/RH, Crash Pad Switch, A/V & Navigation Head Unit, Driver Ims Module
AMP	25A	AMP (JBL/MOBIS)

Fuse Name	Fuse rating	Protected Component
HTD STRG	15A	BCM
MODULE	10A	Front Console, Switch Fuel Filler Door & Trunk Lid Switch, Front Parking Assist Sensor, Tire Pressure Monitoring Module, Lane Departure Warning Unit, Smart Cruise Control Unit, Active Air Flap, BMS Control Module
IG1	25A	PCB Block (Fuse - F1/F2/F7/F8/F15/F16)
WASHER	15A	Multifunction Switch (Wiper Low & Washer Switch)
POWER OUTLET	20A	Front Power Outlet
A/BAG	15A	SRS Control Module, Occupant Detection Sensor
START	7.5A	Transaxle Range Switch, HPCU

Engine compartment main fuse panel

	Fuse Name	Fuse rating	Protected Component
MULTI FUSE (TYPE A)	IG2	30A	IGPM (Fuse - F8/F25/F31/F38/F42)
	BLOWER	40A	RLY. 9 (Blower Relay)
	² AHB	40A	Integrated Brake Actuation Unit
	¹ AHB	40A	Integrated Brake Actuation Unit
	REAR HEATED	50A	RLY. 12 (Rear Heated Relay)
	³ B+	50A	IGPM (IPS2 (4CH), IPS3 (4CH), Fuse - F28/F29)
	⁵ B+	50A	PCM Block (Fuse - F4/F5/F6/F13/F14/F18/F22, Engine Control Relay)
	EEWP	60A	Electric Water Pump
	¹ MDPS	80A	MDPS Unit
MULTI FUSE (TYPE B)	IG1	40A	IGPM (Fuse - F14/F19/F20/F26/F27/F33/F34/F40/F41/F47/F46)
	POWER OUTLET	40A	RLY. 10 (Power Outlet Relay)
	² B+	50A	IGPM (IPS1 (4CH), IPS4 (4CH), IPS5 (4CH), Fuse - F36/F42)
	¹ B+	60A	IGPM (Fuse - F1/F2/F10/F13/F17/F18/F23/F24/F30, Power Window Relay)
	COOLING FAN	60A	RLY.2 (Cooling Fan Relay)
FUSE	DEICER	20A	RLY. 6 (Deicer Relay)
	¹ OPCU	20A	Electric Oil Pump Unit
	¹ HEV ECU	10A	HPCU

	Fuse Name	Fuse rating	Protected Component
FUSE	H/LAMP HI	20A	RLY. 7 (Head Lamp High Relay)
	⁴ B+	40A	IGPM (Leak Current Autocut Device Fuse - F15/F16/F21/F22, Fuse - F5/F6/F7/F11/F12)
	² EPB	30A	Electric Parking Brake Module
	¹ EPB	30A	Electric Parking Brake Module
	HEATED MIRROR	10A	A/C Control Module, Driver/Passenger Power Outside Mirror
	³ ECU	10A	PCM
	² HEV ECU	10A	HPCU
	¹ POWER OUTLET	20A	Cigarette Lighter
	FUEL PUMP	20A	Fuel Pump Relay
	HORN	20A	Horn Relay, ICM Relay Box (Burglar Alarm Horn Relay)
	WIPER	30A	Front Wiper (Low) Relay, Front Wiper (High) Relay
	² TCU	15A	Transaxle Range Switch, Electric Water Pump
	³ AHB	10A	Integrated Brake Actuation Unit
	² POWER OUTLET	20A	Rear Power Outlet
	B/UP LAMP	10A	Transaxle Range Switch, PCM, Audio, Electro Chromic Mirror, Back-Up Lamp LH/RH, Rear Curtain Unit
	¹ SENSOR	15A	Oxygen Sensor (Up/Down)
	² SENSOR	10A	E/R Junction Block (RLY. 2 - Cooling Fan Relay), Mass Air Flow Sensor, Oil Control Valve #1/#2, Purge Control Solenoid Valve, Canister Close Valve, Camshaft Position Sensor #1/#2, Fuel Pump Relay
² ECU	10A	PCM	

	Fuse Name	Fuse rating	Protected Component
FUSE	'TCU	10A	PCM
	'OPCU	10A	Electric Oil Pump Unit
	EWP	10A	Electric Water Pump
	BATTERY C/FAN	15A	E/R Junction Block (RLY. 5 (Battery C/FAN))
	'ECU	20A	PCM
	IGN COIL	20A	Ignition Coil #1/#2/#3/#4
	AMS	10A	Battery Sensor

LIGHT BULBS

Consult an authorized HYUNDAI dealer to replace most vehicle light bulbs. It is difficult to replace vehicle light bulbs because other parts of the vehicle must be removed before you can get to the bulb. This is especially true for removing the headlamp assembly to get to the bulb(s).

Removing/installing the headlamp assembly can result in damage to the vehicle.

Information

After heavy driving, rain or washing, headlamp and trunk lenses could appear frosty. This condition is caused by the temperature difference between the lamp inside and the outside temperature. This is similar to the condensation on your windows inside your vehicle during the rain and doesn't indicate a problem with your vehicle. If the water leaks into the lamp bulb circuitry, have your vehicle checked by an authorized HYUNDAI dealer.

WARNING

- **Prior to replacing a lamp, depress the foot brake, move the shift lever into P (Park) apply the parking brake, place the ignition switch to the LOCK/OFF position, and take the key with you when leaving the vehicle to avoid sudden movement of the vehicle and to prevent possible electric shock.**
- **Be aware the bulbs may be hot and may burn your fingers.**

Headlamp, position lamp, turn signal lamp and side marker light bulb replacement

Type A



- (1) Headlamp (Low)
- (2) Headlamp (High)
- (3) Side marker
- (4) Turn signal lamp
- (5) Daytime running lamp/
Position lamp



Headlamp (Halogen bulb)

⚠ WARNING

- **Handle halogen bulbs with care. Halogen bulbs contain pressurized gas that will produce flying pieces of glass that could cause injuries if broken.**
- **Wear eye protection when changing a bulb. Allow the bulb to cool down before handling it.**

- Always handle them carefully, and avoid scratches and abrasions. If the bulbs are lit, avoid contact with liquids.
- Never touch the glass with bare hands. Residual oil may cause the bulb to overheat and burst when lit.
- A bulb should be operated only when installed in a headlamp.
- If a bulb becomes damaged or cracked, replace it immediately and carefully dispose of it.

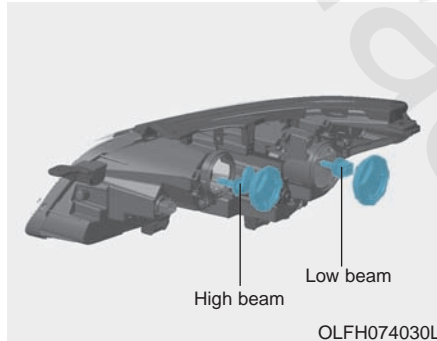

1. Open the hood.
2. Disconnect the negative battery cable.
3. Remove the headlamp bulb cover by turning it counterclockwise.
4. Disconnect the headlamp bulb socket-connector.
5. Unsnap the headlamp bulb retaining wire by pressing the end and pushing it upward.
6. Remove the bulb from the headlamp assembly.
7. Install a new headlamp bulb and snap the headlamp bulb retaining wire into position by aligning the wire with the groove on the bulb.
8. Connect the headlamp bulb socket-connector.
9. Install the headlamp bulb cover by turning it clockwise.

Information

The headlamp aiming should be adjusted after an accident or after the headlamp assembly is reinstalled at an authorized HYUNDAI dealer.

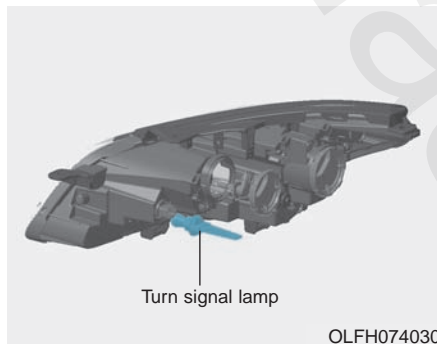

OLFH074030

Turn signal lamp

1. Open the hood.
2. Disconnect the negative battery cable.
3. Remove the socket from the assembly by turning the socket counterclockwise until the tabs on the socket align with the slots on the assembly.
4. Remove the bulb from the socket by pressing it in and rotating it counterclockwise until the tabs on the bulb align with the slots in the socket. Pull the bulb out of the socket.

5. Insert a new bulb by inserting it into the socket and rotating it until it locks into place.
6. Install the socket in the assembly by aligning the tabs on the socket with the slots in the assembly.
7. Push the socket into the assembly and turn the socket clockwise.

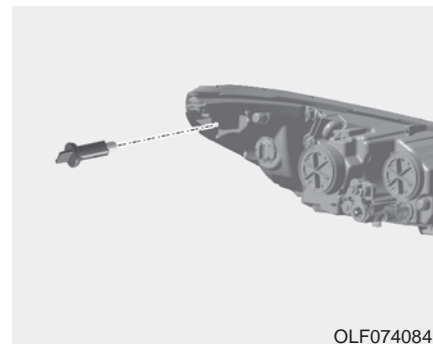

OLF074084N

Side marker

1. Open the hood.
2. Disconnect the negative battery cable.
3. Remove the socket from the assembly by turning the socket counterclockwise until the tabs on the socket align with the slots on the assembly.
4. Remove the bulb from the socket by pulling out the bulb.
5. Insert a new bulb.

Daytime running lamp/ Position lamp

If the LED lamp does not operate, have the vehicle checked by an authorized HYUNDAI dealer.

Type B



- (1) Headlamp (Low/High)
- (2) Side marker
- (3) Turn signal lamp
- (4) Daytime running lamp/
Position lamp

Headlamp (HID type)

WARNING

HID Headlamp low beam

Do not attempt to replace or inspect the low beam (XENON bulb) due to electric shock danger. If the low beam (XENON bulb) is not working, have your vehicle checked by an authorized HYUNDAI Dealer.

Information

If your vehicle is equipped with High Intensity Discharge (HID) headlamps, these headlamps contain mercury. So if you need to have your vehicle disposed, you should remove the HID Headlamps before disposal. The removed HID headlamps should be recycled, re-used or disposed as hazardous waste.

If the light bulb does not operate, have the vehicle checked by an authorized HYUNDAI dealer.

i Information

HID lamps have superior performance vs. halogen bulbs.

HID lamps are estimated by the manufacturer to last twice as long or longer than halogen bulbs depending on their frequency of use. They will probably require replacement at some point in the life of the vehicle. Cycling the headlamps on and off more than typical use will shorten HID lamps life. HID lamps do not fail in the same manner as halogen incandescent lamps. If a headlamp goes out after a period of operation but will immediately relight when the headlamp switch is cycled it is likely the HID lamp needs to be replaced. HID lighting components are more complex than conventional halogen bulbs thus have higher replacement cost.

NOTICE

The headlamp aiming should be adjusted after an accident or after the headlamp assembly is reinstalled at an authorized HYUNDAI dealer.

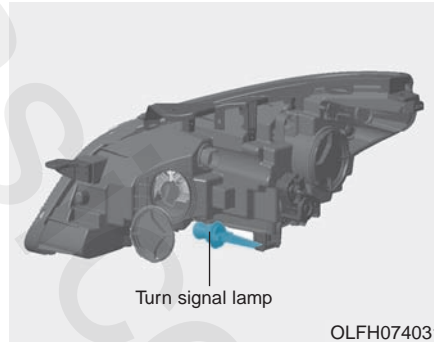

Turn signal lamp

1. Open the hood.
2. Disconnect the negative battery cable.
3. Remove the socket from the assembly by turning the socket counterclockwise until the tabs on the socket align with the slots on the assembly.
4. Remove the bulb from the socket by pressing it in and rotating it counterclockwise until the tabs on the bulb align with the slots in the socket. Pull the bulb out of the socket.

5. Insert a new bulb by inserting it into the socket and rotating it until it locks into place.
6. Install the socket in the assembly by aligning the tabs on the socket with the slots in the assembly.
7. Push the socket into the assembly and turn the socket clockwise.

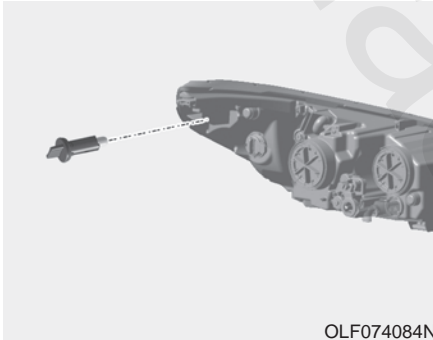

OLF074084N

Daytime running lamp/ Position lamp

If the LED lamp does not operate, have the vehicle checked by an authorized HYUNDAI dealer.

Side marker

1. Open the hood.
2. Disconnect the negative battery cable.
3. Remove the socket from the assembly by turning the socket counterclockwise until the tabs on the socket align with the slots on the assembly.
4. Remove the bulb from the socket by pulling out the bulb.
5. Insert a new bulb.

Side repeater lamp replacement

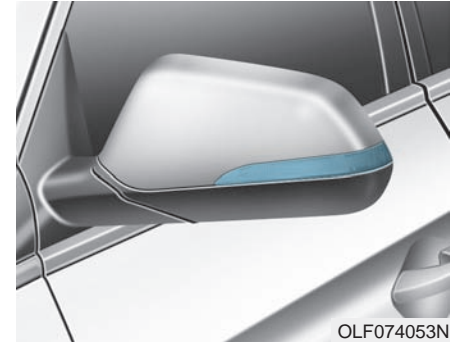

OLF074053N

If the LED lamp does not operate, have the vehicle checked by an authorized HYUNDAI dealer.

Rear combination light bulb replacement

Type A

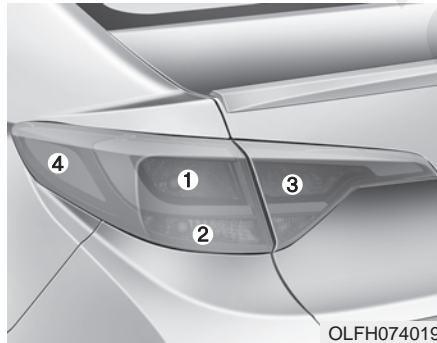

- (1) Stop/Tail lamp
- (2) Turn signal lamp
- (3) Tail lamp
- (4) Side marker

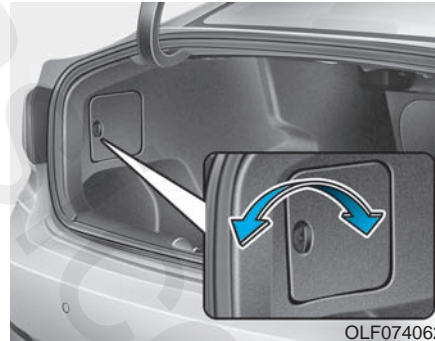

Stop/Tail lamp and Turn signal lamp

- 1. Open the trunk lid.
- 2. Remove the service cover by turning the lock counterclockwise and then pulling it out.

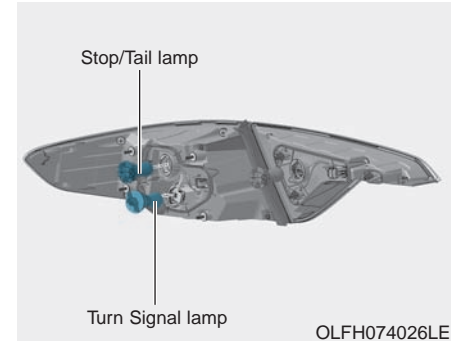

- 3. Remove the socket from the assembly by turning the socket counterclockwise until the tabs on the socket align with the slots on the assembly.
- 4. Remove the bulb from the socket by pressing it in and rotating it counterclockwise until the tabs on the bulb align with the slots in the socket. Pull the bulb out of the socket.
- 5. Insert a new bulb by inserting it into the socket and rotating it until it locks into place.

6. Install the socket in the assembly by aligning the tabs on the socket with the slots in the assembly. Push the socket into the assembly and turn the socket clockwise.

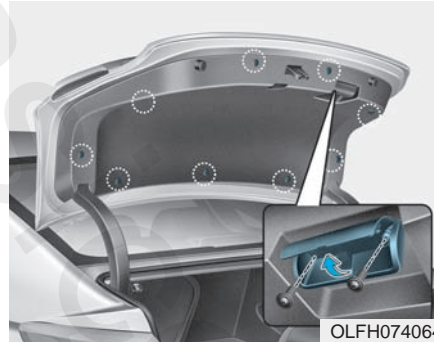

Tail lamp

1. Open the trunk.
2. Loosen the retaining screw of the trunk lid cover and then remove the cover.
3. Disconnect the connector and then remove the screws by turning the screws counterclockwise.

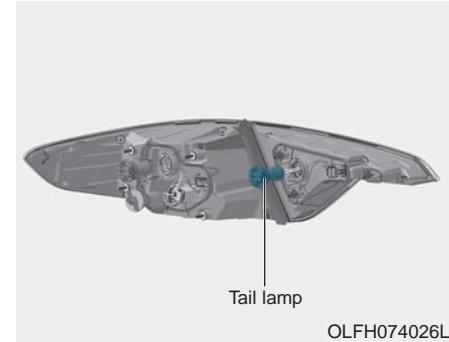

4. Remove the bulb by pulling it straight out.
5. Insert a new bulb by inserting it into the socket and rotating it until it locks into place.
6. Install the socket into the assembly by aligning the tabs on the socket with the slots in the assembly. Push the socket into the assembly and turn the socket clockwise.
7. Reinstall the trunk lid cover by pushing in the screw.

Side marker

If the LED lamp does not operate, have the vehicle checked by an authorized HYUNDAI dealer.

Type B

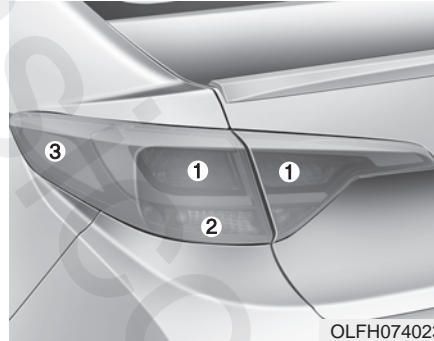

- (1) Stop/Tail lamp
- (2) Turn signal lamp
- (3) Side marker

Stop/Tail lamp

If the LED lamp does not operate, have the vehicle checked by an authorized HYUNDAI dealer.



Turn signal lamp

1. Open the trunk lid.
2. Remove the service cover by turning the lock counterclockwise and then pulling it out.

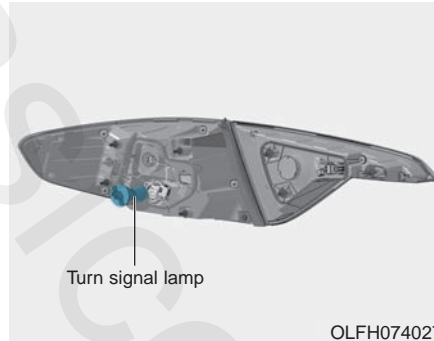

3. Remove the socket from the assembly by turning the socket counterclockwise until the tabs on the socket align with the slots on the assembly.
4. Remove the bulb from the socket by pressing it in and rotating it counterclockwise until the tabs on the bulb align with the slots in the socket. Pull the bulb out of the socket.
5. Insert a new bulb by inserting it into the socket and rotating it until it locks into place.
6. Install the socket in the assembly by aligning the tabs on the socket with the slots in the assembly. Push the socket into the assembly and turn the socket clockwise.

Side marker

If the LED lamp does not operate, have the vehicle checked by an authorized HYUNDAI dealer.

Back-up lamp

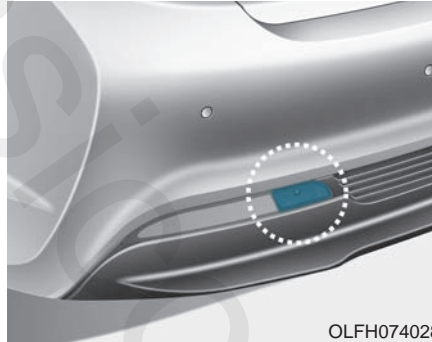

OLFH074028

1. Turn off the hybrid system.
2. Remove the under cover by rotating the screws.
3. Reach your hand into the back of the rear bumper.
4. Disconnect the power connector from the socket.
5. Remove the bulb-socket from the housing by turning the socket counter clockwise until the tabs on the socket align with the slots on the housing.
6. Install a new bulb-socket into the housing by aligning the tabs on the socket with the slots in the housing. Push the socket into the housing and turn the socket clockwise.
7. Connect the power connector to the socket.

High mounted stop lamp

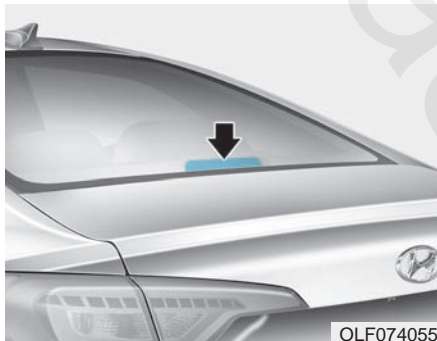

1. Remove the rear seat cushion assembly.
2. Remove the rear seat back assembly.
3. Slightly remove the rear door weather-strip.
4. Remove the rear door scuff trim.
5. Remove the rear pillar trim.
6. Remove the rear seat belt lower anchor.
7. Remove the rear package tray trim.
8. Remove the high mounted stop lamp after disengaging the mounting clip.
9. Install a new LED lamp.

License plate light bulb replacement

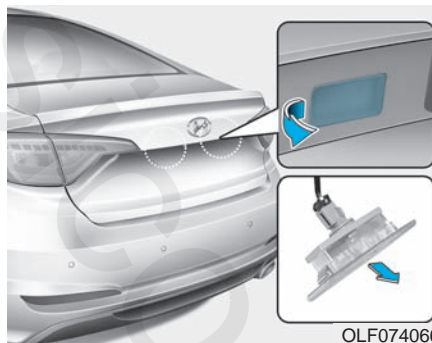

1. Loosen the lens retaining screws with a philips head screwdriver.
2. Remove the lens.
3. Remove the bulb by pulling it straight out.
4. Install a new bulb.
5. Reinstall the lens securely with the lens retaining screws.

Interior light bulb replacement

Map lamp and Room lamp

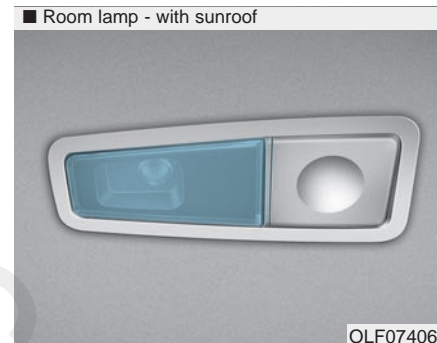

If the LED lamp does not operate, have the vehicle checked by an authorized HYUNDAI dealer.

Map lamp, Room lamp, Vanity mirror lamp and Luggage room lamp

■ Map lamp - without sunroof

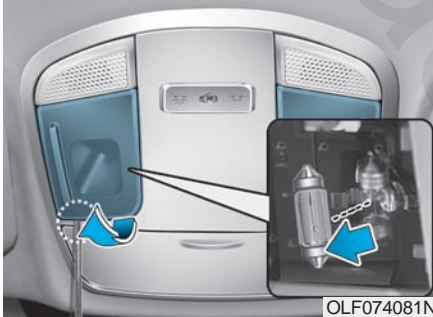

■ Room lamp - without sunroof

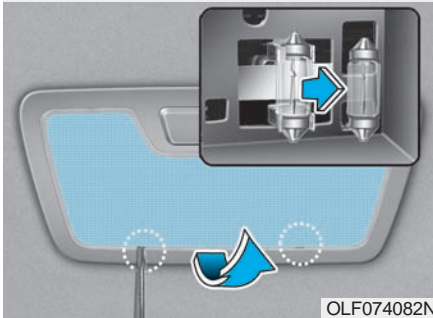

■ Vanity mirror lamp

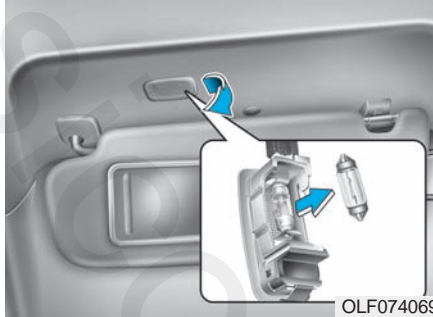

■ Trunk room lamp



1. Using a flat-head screwdriver, gently pry the lens from the interior light housing.
2. Remove the bulb by pulling it straight out.
3. Install a new bulb in the socket.
4. Align the lens tabs with the interior light housing notches and snap the lens into place.

If the lamps do not operating, have the vehicle checked by an authorized HYUNDAI dealer.

NOTICE

Use care not to dirty or damage lenses, lens tabs, and plastic housings.

APPEARANCE CARE

Exterior care

Exterior general caution

It is very important to follow the label directions when using any chemical cleaner or polish. Read all warning and caution statements that appear on the label.

Finish maintenance

Washing

To help protect your vehicle's finish from rust and deterioration, wash it thoroughly and frequently at least once a month with lukewarm or cold water.

If you use your vehicle for off-road driving, you should wash it after each off-road trip. Pay special attention to the removal of any accumulation of salt, dirt, mud, and other foreign materials. Make sure the drain holes in the lower edges of the doors and rocker panels are kept clear and clean.

Insects, tar, tree sap, bird droppings, industrial pollution and similar deposits can damage your vehicle's finish if not removed immediately.

Even prompt washing with plain water may not completely remove all these deposits. A mild soap, safe for use on painted surfaces, should be used.

After washing, rinse the vehicle thoroughly with lukewarm or cold water. Do not allow soap to dry on the finish.

WARNING

After washing the vehicle, test the brakes while driving slowly to see if they have been affected by water before getting on the road. If braking performance is impaired, dry the brakes by applying them lightly while maintaining a slow forward speed.

CAUTION

- **Do not use strong soap, chemical detergents or hot water, and do not wash the vehicle in direct sunlight or when the body of the vehicle is warm.**
- **Be careful when washing the side windows of your vehicle. Especially, with high-pressure water, water may leak through the windows and wet the interior.**
- **To prevent damage to the plastic parts, do not clean with chemical solvents or strong detergents.**



⚠ CAUTION

- **Water washing in the engine compartment including high pressure water washing may cause the failure of electrical circuits located in the engine compartment.**
- **Never allow water or other liquids to come in contact with electrical/electronic components inside the vehicle as this may damage them.**

Waxing

A good coat of wax is a barrier between your paint and contaminants. Keeping a good coat of wax on your vehicle will help protect it.

Wax the vehicle when water will no longer bead on the paint.

Always wash and dry the vehicle before waxing. Use a good quality liquid or paste wax, and follow the manufacturer's instructions. Wax all metal trim to protect it and to maintain its luster.

Removing oil, tar, and similar materials with a spot remover will usually strip the wax from the finish. Be sure to re-wax these areas even if the rest of the vehicle does not yet need waxing.

⚠ CAUTION

- **Wiping dust or dirt off the body with a dry cloth will scratch the finish.**
- **Do not use steel wool, abrasive cleaners, or strong detergents containing highly alkaline or caustic agents on chrome-plated or anodized aluminum parts. This may result in damage to the protective coating and cause discoloration or paint deterioration.**

Finish damage repair

Deep scratches or stone chips in the painted surface must be repaired promptly. Exposed metal will quickly rust and may develop into a major repair expense.

NOTICE

If your vehicle is damaged and requires any metal repair or replacement, be sure the body shop applies anti-corrosion materials to the parts repaired or replaced.

Bright-metal maintenance

- To remove road tar and insects, use a tar remover, not a scraper or other sharp object.
- To protect the surfaces of bright-metal parts from corrosion, apply a coating of wax or chrome preservative and rub to a high luster.
- During winter weather or in coastal areas, cover the bright metal parts with a heavier coating of wax or preservative. If necessary, coat the parts with non-corrosive petroleum jelly or other protective compound.

Underbody maintenance

Corrosive materials used for ice and snow removal and dust control may collect on the underbody. If these materials are not removed, accelerated rusting can occur on underbody parts such as the fuel lines, frame, floor pan and exhaust system, even though they have been treated with rust protection.

Thoroughly flush the vehicle underbody and wheel openings with lukewarm or cold water once a month, after off-road driving and at the end of each winter. Pay special attention to these areas because it is difficult to see all the mud and dirt. It will do more harm than good to wet down the road grime without removing it. The lower edges of doors, rocker panels, and frame members have drain holes that should not be allowed to clog with dirt; trapped water in these areas can cause rusting.

WARNING

After washing the vehicle, test the brakes while driving slowly to see if they have been affected by water. If braking performance is impaired, dry the brakes by applying them lightly while maintaining a slow forward speed.

Aluminum wheel maintenance

The aluminum wheels are coated with a clear protective finish.

CAUTION

- Do not use abrasive cleaner, polishing compound, solvent, or wire brushes on aluminum wheels.
- Clean the wheel when it has cooled.
- Use only a mild soap or neutral detergent, and rinse thoroughly with water. Also, clean the wheels after driving on salted roads.
- Do not wash the wheels with high-speed car wash brushes.
- Do not use any cleaners containing acid or alkaline detergents.

Corrosion protection

Protecting your vehicle from corrosion

By using the most advanced design and construction practices to combat corrosion, HYUNDAI produces cars of the highest quality. However, this is only part of the job. To achieve the long-term corrosion resistance your vehicle can deliver, the owner's cooperation and assistance is also required.

Common causes of corrosion

The most common causes of corrosion on your vehicle are:

- Road salt, dirt and moisture that is allowed to accumulate underneath the vehicle.
- Removal of paint or protective coatings by stones, gravel, abrasion or minor scrapes and dents which leave unprotected metal exposed to corrosion.

High-corrosion areas

If you live in an area where your vehicle is regularly exposed to corrosive materials, corrosion protection is particularly important. Some of the common causes of accelerated corrosion are road salts, dust control chemicals, ocean air and industrial pollution.

Moisture breeds corrosion

Moisture creates the conditions in which corrosion is most likely to occur. For example, corrosion is accelerated by high humidity, particularly when temperatures are just above freezing. In such conditions, the corrosive material is kept in contact with the car surfaces by moisture that is slow to evaporate.

Mud is particularly corrosive because it is slow to dry and holds moisture in contact with the vehicle. Although the mud appears to be dry, it can still retain the moisture and promote corrosion.

High temperatures can also accelerate corrosion of parts that are not properly ventilated so the moisture can be dispersed. For all these reasons, it is particularly important to keep your vehicle clean and free of mud or accumulations of other materials. This applies not only to the visible surfaces but particularly to the underside of the vehicle.

To help prevent corrosion

Keep your car clean

The best way to prevent corrosion is to keep your vehicle clean and free of corrosive materials. Attention to the underside of the vehicle is particularly important.

- If you live in a high-corrosion area — where road salts are used, near the ocean, areas with industrial pollution, acid rain, etc.—, you should take extra care to prevent corrosion. In winter, hose off the underside of your vehicle at least once a month and be sure to clean the underside thoroughly when winter is over.

- When cleaning underneath the vehicle, pay particular attention to the components under the fenders and other areas that are hidden from view. Do a thorough job; just dampening the accumulated mud rather than washing it away will accelerate corrosion rather than prevent it. Water under high pressure and steam are particularly effective in removing accumulated mud and corrosive materials.
- When cleaning lower door panels, rocker panels and frame members, be sure that drain holes are kept open so that moisture can escape and not be trapped inside to accelerate corrosion.

Keep your garage dry

Don't park your car in a damp, poorly ventilated garage. This creates a favorable environment for corrosion. This is particularly true if you wash your vehicle in the garage or drive it into the garage when it is still wet or covered with snow, ice or mud. Even a heated garage can contribute to corrosion unless it is well ventilated so moisture is dispersed.

Keep paint and trim in good condition

Scratches or chips in the finish should be covered with "touch-up" paint as soon as possible to reduce the possibility of corrosion. If bare metal is showing through, the attention of a qualified body and paint shop is recommended.

Bird droppings are highly corrosive and may damage painted surfaces in just a few hours. Always remove bird droppings as soon as possible.

Interior care

Interior general precautions

Prevent caustic solutions such as perfume and cosmetic oil, from contacting the interior parts because they may cause damage or discoloration. If they do contact the interior parts, wipe them off immediately. See the instructions for the proper way to clean vinyl.



CAUTION

- **Never allow water or other liquids to come in contact with electrical/electronic components inside the vehicle as this may damage them.**
- **When cleaning leather products (steering wheel, seats etc.), use neutral detergents or low alcohol content solutions. If you use high alcohol content solutions or acid/alkaline detergents, the color of the leather may fade or the surface may get stripped off.**

Cleaning the upholstery and interior trim

Vinyl

Remove dust and loose dirt from vinyl with a whisk broom or vacuum cleaner. Clean vinyl surfaces with a vinyl cleaner.

Fabric

Remove dust and loose dirt from fabric with a whisk broom or vacuum cleaner. Clean with a mild soap solution recommended for upholstery or carpets. Remove fresh spots immediately with a fabric spot cleaner. If fresh spots do not receive immediate attention, the fabric can be stained and its color can be affected. Also, its fire-resistant properties can be reduced if the material is not properly maintained.

 **CAUTION**

Using anything but recommended cleaners and procedures may affect the fabric's appearance and fire-resistant properties.

Cleaning the seat belt webbing

Clean the belt webbing with any mild soap solution recommended for cleaning upholstery or carpet. Follow the instructions provided with the soap. Do not bleach or re-dye the webbing because this may weaken the seat belt.

Cleaning the interior window glass

If the interior glass surfaces of the vehicle become fogged (that is, covered with an oily, greasy or waxy film), they should be cleaned with glass cleaner. Follow the directions on the glass cleaner container.

 **CAUTION**

Do not scrape or scratch the inside of the rear window. This may result in damage to the rear window defroster grid.

EMISSION CONTROL SYSTEM

The emission control system of your vehicle is covered by a written limited warranty. Please see the warranty information contained in the Owner's Handbook & Warranty Information booklet in your vehicle.

Your vehicle is equipped with an emission control system to meet all applicable emission regulations. There are three emission control systems, as follows.

- (1) Crankcase emission control system
- (2) Evaporative emission control system
- (3) Exhaust emission control system

In order to assure the proper function of the emission control systems, it is recommended that you have your vehicle inspected and maintained by an authorized HYUNDAI dealer in accordance with the maintenance schedule in this manual.

CAUTION

For the Inspection and Maintenance Test (With Electronic Stability Control (ESC) system)

- **To prevent the vehicle from ESC activation during dynamometer testing, turn the Electronic Stability Control (ESC) system off by pressing the ESC switch (ESC OFF light illuminated).**
- **After dynamometer testing is completed, turn the ESC system back on by pressing the ESC switch again.**

1. Crankcase emission control system

The positive crankcase ventilation system is employed to prevent air pollution caused by blow-by gases being emitted from the crankcase. This system supplies fresh filtered air to the crankcase through the air intake hose. Inside the crankcase, the fresh air mixes with blow-by gases, which then pass through the PCV valve into the induction system.

2. Evaporative emission control system including onboard refueling vapor recovery (ORVR)

The Evaporative Emission Control System is designed to prevent fuel vapors from escaping into the atmosphere. The ORVR system is designed to allow the vapors from the fuel tank to be loaded into a canister while refueling at the gas station, preventing the escape of fuel vapors into the atmosphere.

Canister

Fuel vapors generated inside the fuel tank are absorbed and stored in the onboard canister. When the engine is running, the fuel vapors absorbed in the canister are drawn into the surge tank through the purge control solenoid valve.

Purge Control Solenoid Valve (PCSV)

The purge control solenoid valve is controlled by the Engine Control Module (ECM); when the engine coolant temperature is low during idling, the PCSV closes so that evaporated fuel is not taken into the engine. After the engine warms-up during ordinary driving, the PCSV opens to introduce evaporated fuel to the engine.

3. Exhaust emission control system

The Exhaust Emission Control System is a highly effective system which controls exhaust emissions while maintaining good vehicle performance.

When the engine starts or fails to start, excessive attempts to restart the engine may cause damage to the emission system.

Vehicle modifications

- This vehicle should not be modified. Modification of your vehicle could affect its performance, safety or durability and may even violate governmental safety and emissions regulations.

In addition, damage or performance problems resulting from any modification may not be covered under warranty.

- If you use unauthorized electronic devices, it may cause the vehicle to operate abnormally, wire damage, battery discharge and fire. For your safety, do not use unauthorized electronic devices.

Engine exhaust (carbon monoxide) precautions

- Carbon monoxide can be present with other exhaust fumes. If you smell exhaust fumes of any kind in your vehicle, drive with all the windows fully open. Have your vehicle checked and repaired immediately.

⚠ WARNING

Engine exhaust gases contain carbon monoxide (CO). Though colorless and odorless, it is dangerous and could be lethal if inhaled. Follow the instructions on this page to avoid CO poisoning.

⚠ WARNING

**CALIFORNIA PROPOSITION 65
WARNING**

Engine exhaust and a wide variety of automobile components and parts, including components found in the interior furnishings in a vehicle, contain or emit chemicals known to the State of California to cause cancer and birth defects and reproductive harm. In addition, certain fluids contained in vehicles and certain products of component wear contain or emit chemicals known to the State of California to cause cancer and birth defects or other reproductive harm.

- Do not operate the engine in confined or closed areas (such as garages) any more than what is necessary to move the vehicle in or out of the area.
- When the vehicle is stopped in an open area for more than a short time with the engine running, adjust the ventilation system (as needed) to draw outside air into the vehicle.
- Never sit in a parked or stopped vehicle for any extended time with the engine running.
- When the engine stalls or fails to start, excessive attempts to restart the engine may cause damage to the emission control system.

Operating precautions for catalytic converters (if equipped)

⚠ WARNING

The exhaust system and catalytic converter are very hot during and immediately after the engine has been running. To avoid **SERIOUS INJURY** or **DEATH**:

- Do not park, idle, or drive the vehicle over or near flammable objects, such as grass, vegetation, paper, leaves, etc. A hot exhaust system can ignite flammable items under your vehicle.
- Keep away from the exhaust system and catalytic converter or you may get burned.

Also, Do not remove the heat sink around the exhaust system, do not seal the bottom of the vehicle, and do not coat the vehicle for corrosion control. It may present a fire risk under certain conditions.

Your vehicle is equipped with a catalytic converter emission control device.

To prevent damage to the catalytic converter and to your vehicle, take the following precautions:



CAUTION

- Use only **UNLEADED FUEL** for gasoline engines.
- Do not operate the vehicle when there are signs of engine malfunction, such as misfire or a noticeable loss of performance.
- Do not misuse or abuse the engine. Examples of misuse are coasting with the hybrid system off and descending steep grades in gear with the engine off.
- Do not operate the engine at high idle speed for extended periods (5 minutes or more).

(Continued)

(Continued)

- Do not modify or tamper with any part of the engine or emission control system. All inspections and adjustments must be made by an authorized HYUNDAI dealer.
- Avoid driving with extremely low fuel level. If you run out of gasoline, it could cause the engine to misfire and result in excessive loading of the catalytic converter.

CALIFORNIA PERCHLORATE NOTICE

Perchlorate Material-special handling may apply, See: www.dtsc.ca.gov/hazardouswaste/perchlorate.

Notice to California Vehicle Dismantlers:

Perchlorate containing materials, such as air bag inflators, seatbelt pretensioners and keyless remote entry batteries, must be disposed of according to Title 22 California Code of Regulations Section 67384.10 (a).

Specifications, Consumer information and Reporting safety defects

Dimensions	8-2
Engine	8-2
Bulb Wattage	8-3
Tires and Wheels	8-4
Volume and Weight.....	8-5
Air Conditioning System.....	8-5
Recommended Lubricants and Capacities	8-6
Recommended SAE Viscosity Number	8-7
Vehicle Identification Number (VIN)	8-8
Vehicle Certification Label.....	8-8
Tire Specification and Pressure Label.....	8-9
Engine Number	8-9
Refrigerant Label.....	8-9
Consumer Information.....	8-10
Reporting Safety Defects	8-11

DIMENSIONS

Items		in (mm)
Overall length		191.1 (4,855)
Overall width		73.4 (1,865)
Overall height		58.1 (1,475) / 58.5 (1,485) *1
Front tread	205/65R16	63.5 (1,614)
	215/55R17	63.0 (1,602)
Rear tread	205/65R16	63.8 (1,621)
	215/55R17	63.3 (1,609)
Wheelbase		110.4 (2,805)

*1 : Vehicle equipped with high suspension

ENGINE

Items	2.0 GDI
Displacement cu. in (cc)	121.98 (1,999)
Bore x Stroke in. (mm)	3.18x3.82 (81x97)
Firing order	1-3-4-2
No. of cylinders	4, In-line

BULB WATTAGE

		Light Bulb		Bulb Type	Wattage (W)	
Front	Headlamps	Type A	Low	9005L+	65	
			High	9005HL+	65	
		Type B	Low/High	D3S	35	
	Turn signal lamps				PY28/8W	28
	Position lamps				LED	LED
	Daytime running lights				LED	LED
	Side repeater lamps				LED	LED
	Side marker lamps				W5W	5
Rear	Rear combination lamp	Type A (Bulb)	Stop/Tail lamps (Outside)	P28/8W	28/8	
			Tail lamp	8W	8	
		Type B (LED)	Stop/Tail lamps (Outside)	LED	LED	
			Stop/Tail lamps (Inside)	LED	LED	
		All	Turn signal lamps	PY27W	27	
			Back up lamps	W16	16	
	High mounted stop lamp				LED	LED
	License plate lamps				W5W	5
Interior	Luggage room lamp				Festoon	10
	Map lamps	with sunroof		LED	LED	
		without sunroof		W10W	10	
	Room lamps	with sunroof		LED	LED	
		without sunroof		Festoon	10	
	Vanity mirror lamps				Festoon	10

TIRES AND WHEELS

Items	Tire Size	Wheel Size	Inflation pressure kPa (psi)				Wheel lug nut torque kg.m (lb.ft, N.m)
			Normal Load		Maximum Load		
			Front	Rear	Front	Rear	
Full size tire	205/65R16	6.5JX16	240 (35)	240 (35)	240 (35)	240 (35)	9~11 (65~79, 88~107)
	215/55R17	7.0JX17	240 (35)	240 (35)	240 (35)	240 (35)	

⚠ CAUTION

**When replacing tires, use the same size originally supplied with the vehicle.
Using tires of a different size can damage the related parts or not work properly.**

VOLUME AND WEIGHT

Items	2.0 GDI
Gross vehicle weight lbs. (kg)	4,630 (2,100)
Luggage volume cu ft (l)	16.3 (462)

AIR CONDITIONING SYSTEM

Items	Weight of Volume	Classification
Refrigerant oz. (g)	22.9 ± 0.8 (650 ± 25)	R-134a
Compressor lubricant oz. (cc)	4.59 ± 0.35 (130 ± 10)	POE (RB100EV)

Contact an authorized HYUNDAI dealer for more details.

RECOMMENDED LUBRICANTS AND CAPACITIES

To help achieve proper engine and powertrain performance and durability, use only lubricants of the proper quality. The correct lubricants also help promote engine efficiency that results in improved fuel economy.

Lubricant	Volume	Classification
Engine oil *1 *2 (drain and refill) Recommends 	4.33 US qt. (4.1 l)	API Service SM or above*/ILSAC GF-4 or above
Automatic transaxle fluid	6.34 US qt. (6.0 l)	MICHANG ATF SP-IV, SK ATF SP-IV NOCA ATF SP-IV, HYUNDAI genuine ATF & SP-IV or other brands meeting the above specification approved by Hyundai Motor Co.
Engine coolant	6.97~7.29 US qt. (6.6 ~ 6.9 l)	Mixture of antifreeze and water (Phosphate-based ethylene glycol coolant for aluminum radiator)
Inverter coolant	2.38 US qt. (2.26 l)	Mixture of antifreeze and water (Phosphate-based ethylene glycol coolant for aluminum radiator)
Brake fluid	0.74~0.85 US qt. (0.7~0.8 l)	FMVSS116 DOT-3 or DOT-4
Fuel	15.85 US gal. (60 l)	Refer to "Fuel Requirements" in the Foreword chapter.

*1 Refer to the recommended SAE viscosity numbers on the next page.

*2 Engine oils labeled Energy Conserving Oil are now available. Along with other additional benefits, they contribute to fuel economy by reducing the amount of fuel necessary to overcome engine friction. Often, these improvements are difficult to measure in everyday driving, but in a year's time, they can offer significant cost and energy savings.

*3 If the API service SM engine oil is not available in your country, you are able to use API service SL.

Recommended SAE viscosity number

CAUTION

Always be sure to clean the area around any filler plug, drain plug, or dipstick before checking or draining any lubricant. This is especially important in dusty or sandy areas and when the vehicle is used on unpaved roads. Cleaning the plug and dipstick areas will prevent dirt and grit from entering the engine and other mechanisms that could be damaged.

Engine oil viscosity (thickness) has an effect on fuel economy and cold weather operating (engine start and engine oil flowability). Lower viscosity engine oils can provide better fuel economy and cold weather performance, however, higher viscosity engine oils are required for satisfactory lubrication in hot weather. Using oils of any viscosity other than those recommended could result in engine damage.

When choosing an oil, consider the range of temperature your vehicle will be operated in before the next oil change. Proceed to select the recommended oil viscosity from the chart.

Temperature Range for SAE Viscosity Numbers										
Temperature	°C	-30	-20	-10	0	10	20	30	40	50
	(°F)	-10	0	20	40	60	80	100	120	
Engine Oil *1		10W-30								
		5W-20, 5W-30								

*1 For better fuel economy, it is recommended to use the engine oil of a viscosity grade SAE 5W-20 (API SM / ILSAC GF-4). However, if the engine oil is not available in your country, select the proper engine oil using the engine oil viscosity chart.



VEHICLE IDENTIFICATION NUMBER (VIN)

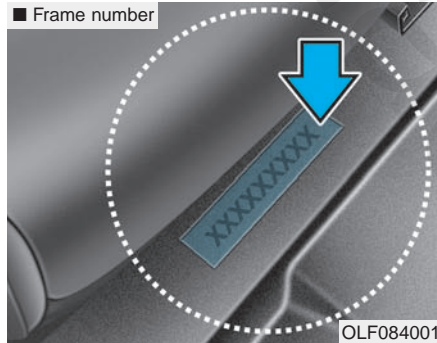

The vehicle identification number (VIN) is the number used in registering your car and in all legal matters pertaining to its ownership, etc.

The number is punched on the floor under the passenger seat. To check the number, open the cover.

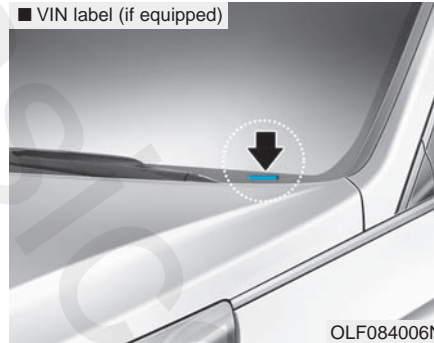

The VIN is also on a plate attached to the top of the dashboard. The number on the plate can easily be seen through the windshield from outside.

VEHICLE CERTIFICATION LABEL

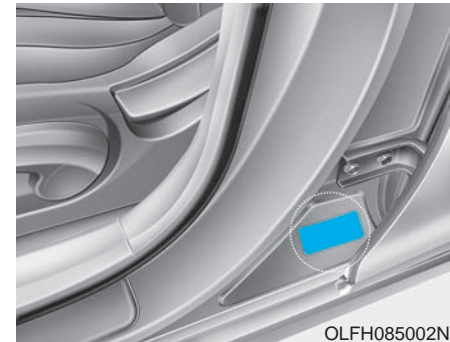

The vehicle certification label attached on the driver's side center pillar gives the Vehicle Identification Number (VIN).

TIRE SPECIFICATION AND PRESSURE LABEL

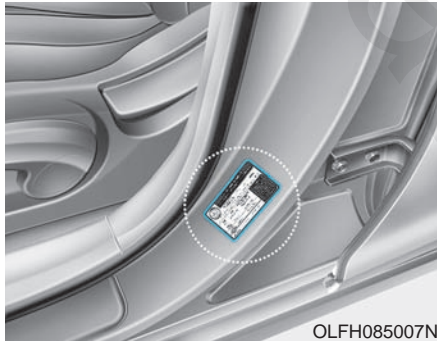

OLFH085007N

The tires supplied on your new vehicle are chosen to provide the best performance for normal driving.

The tire label located on the driver's side center pillar gives the tire pressures recommended for your car.

ENGINE NUMBER

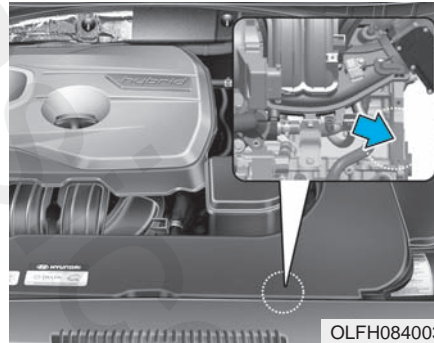

OLFH084003

The engine number is stamped on the engine block as shown in the drawing.

REFRIGERANT LABEL (IF EQUIPPED)

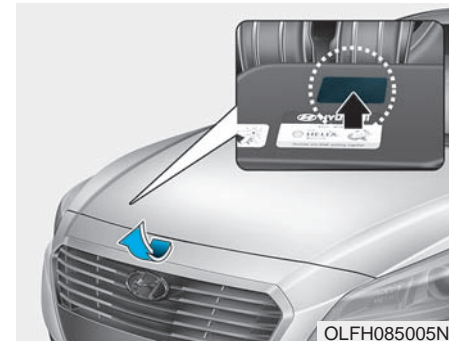

OLFH085005N

The refrigerant label provides information such as refrigerant type and amount.

The label is located on the underside of the hood.

CONSUMER INFORMATION

This consumer information has been prepared in accordance with regulations issued by the National Highway Traffic Safety Administration of the U.S. Department of Transportation. Your HYUNDAI dealer will help answer any questions you may have as you read this information.

HYUNDAI motor vehicles are designed and manufactured to meet or exceed all applicable safety standards.

For your safety, however, we strongly urge you to read and follow all directions in this Owner's Manual, particularly the information under the headings "**NOTICE**", "**CAUTION**" and "**WARNING**".

If, after reading this manual, you have any questions regarding the operation of your vehicle, please contact your nearest HYUNDAI Motor America Regional Office as listed in the following:

Eastern Region:

Connecticut, Delaware,
Maine, Massachusetts, New
Hampshire, New Jersey, New York,
Pennsylvania, Rhode Island,
Vermont.

Eastern Region
1122 Cranbury South River Road
Jamesburg, NJ 08831
(800) 633-5151

Southern Region:

Florida, Georgia, Maryland, North
Carolina, South Carolina, Virginia,
West Virginia.

Southern Region
3025 Chastain Meadows Parkway
Suite 100 Marietta, GA 30066
(800) 633-5151

South Central Region:

Alabama, Arkansas, Louisiana,
Mississippi, New Mexico, Oklahoma,
Tennessee, Texas.

South Central Region
1421 South Beltline Road, Suite 400
Coppell, TX 75019
(800) 633-5151

Central Region:

Illinois, Indiana, Iowa, Kentucky,
Michigan, Minnesota, Nebraska,
North Dakota, South Dakota, Ohio,
Wisconsin, Kansas, Missouri.

Central Region
1705 Sequoia Drive Aurora, Illinois
60506
(800) 633-5151

Western Region:

Alaska, Hawaii, Arizona, California,
Colorado, Idaho, Montana, Nevada,
Oregon, Utah, Washington,
Wyoming.

Western Region
10550 Talbert Avenue P.O.Box
20850 Fountain Valley, California
92728-0850
(800) 633-5151

REPORTING SAFETY DEFECTS

If you believe that your vehicle has a defect which could cause a crash or could cause injury or death, you should immediately inform the National Highway Traffic Safety Administration (NHTSA) in addition to notifying HYUNDAI MOTOR AMERICA.

If NHTSA receives similar complaints, it may open an investigation, and if it finds that a safety defect exists in a group of vehicles, it may order a recall and remedy campaign. However, NHTSA cannot become involved in individual problems between you, your dealer, or HYUNDAI MOTOR AMERICA.

To contact NHTSA, you may call the Vehicle Safety Hotline toll-free at 1-888- 327-4236 (TTY: 1-800-424-9153); go to <http://www.safercar.gov>;
or write to: Administrator, NHTSA
1200 New Jersey Ave, SE,
West Building Washington, D.C. 20590.

You can also obtain other information about motor vehicle safety from <http://www.safercar.gov>.

basic circuit

A

A/V mode.....3-90

Air bag warning labels.....2-70

Air bags.....2-47

 Additional safety precautions.....2-69

 Air bag collision sensors.....2-63

 Air bag inflation conditions.....2-65

 Air bag non-inflation conditions.....2-66

 Air bag warning labels.....2-70

 Curtain air bags.....2-51

 Do not install a child restraint on the front
 passenger seat.....2-58

 Driver’s front air bag.....2-49

 How does the air bag system operate?.....2-52

 Occupant Classification System (OCS).....2-58

 Passenger’s front air bag.....2-49

 Side air bags.....2-50

 SRS Care.....2-68

 SRS warning light.....2-53

 What to expect after an air bag inflates.....2-57

 Where are the air bags?.....2-49

 Why didn’t my air bag go off in a collision.....2-63

Air cleaner.....7-35

Air ventilation seats.....2-22

Airconditioning system

 Automatic climate control system.....3-128

 Manual climate control system.....3-129

 Refrigerant and Compressor.....8-5

Alarm system.....3-13

Antenna.....4-2

Anti-lock brake system (ABS).....5-32

Appearance care.....7-86

 Exterior care.....7-86

 Interior care.....7-91

Armrest.....2-14

Audio/Video/Navigation system (AVN).....4-4

Auto door lock/unlock features.....3-12

Auto hold.....5-28

Auto light position.....3-107

Automatic climate control system.....3-127

 Air conditioning.....3-136

 Automatic heating and air conditioning.....3-128

 Climate control air filter.....3-139

 Manual heating and air conditioning.....3-129

Automatic transaxle.....5-12

 Sports mode.....5-15

AUX, USB and iPod® port.....4-2

B

Back-up lamp.....	7-83
Battery.....	7-41
Battery saver function.....	3-113
Before driving.....	5-3
Blind spot detection system (BSD).....	5-70
<i>Bluetooth</i> [®] Wireless Technology Hands-Free.....	4-4
Brake fluid.....	7-33
Brake system.....	5-19
Disc brakes wear indicator.....	5-20
Electronic parking brake (EPB).....	5-22
Foot parking brake.....	5-20
Power brakes.....	5-19
Anti-lock brake system (ABS).....	5-32
Auto hold.....	5-28
Electronic stability control (ESC).....	5-34
Hill-start assist control (HAC).....	5-39
Vehicle Stability Management.....	5-37
Bulb replacement.....	7-73
Bulb wattage.....	8-3
Button start/stop, see engine start/stop button.....	5-4

C

California perchlorate notice.....	7-97
Capacities (Lubricants).....	8-6
Care	
Exterior care.....	7-86
Interior care.....	7-91
Tire care.....	7-44
Center console storage.....	3-145
Central door lock switch.....	3-10
Certification label.....	8-8
Chains	
Tire chains.....	5-83
Checking tire inflation pressure.....	7-46
Child restraint system (CRS).....	2-36
Children always in the rear.....	2-36
Installing a Child Restraint System (CRS).....	2-39
Lower anchors and tether for children (LATCH) system.....	2-40
Securing with lap/shoulder belt.....	2-44
Securing with Tether anchors.....	2-43
Selecting a Child Restraint System (CRS).....	2-37
Child-protector rear door lock.....	3-12
Climate control air filter.....	3-139, 7-37
Clock.....	3-150

Clothes hanger3-151
 Combined instrument, see instrument cluster3-57
 Consumer information8-9
 Coolant7-29
 Cooling fluid, see engine coolant7-29
 Cruise control.....5-43
 Cup holder.....3-147

D

Dashboard illumination, see instrument panel
 illumination.....3-58
 Dashboard, see instrument cluster3-57
 Day/night rearview mirror3-19
 Daytime running light3-114
 Defogging (Windshield)3-141
 Defroster (Rear window)3-126
 Defrosting (Windshield)3-141
 Digital speedometer3-102
 Dimensions8-2
 Disc brakes wear indicator5-20
 Display illumination, see instrument panel
 illumination.....3-58
 Display of hybrid systemH-3
 Displays, see instrument cluster3-57
 Do not install a child restraint on the front
 passenger seat2-62

Door courtesy lamp.....3-118
 Door locks.....3-9
 Auto door lock/unlock features3-12
 Central door lock switch3-10
 Child-protector rear door lock.....3-12
 Drinks holders, see cup holders.....3-147
 Drive mode integrated control system.....5-41
 Driver assis system3-122
 Rear parking assist system (RPAS).....3-123
 Rear view camera3-122
 Driver position memory system3-14
 Driver’s front air bag2-49
 Driving at night.....5-79
 Driving in flooded areas5-80
 Driving in the rain.....5-80
 Electronic chromic mirror (ECM)3-20
 Electric parking brake (EPB).....5-22
 Electric power steering (EPS).....3-16
 Electronic stability control (ESC).....5-34
 Emergency situationsH-24
 Emission control system7-93
 Engine8-2
 Engine compartment.....1-6, 7-3
 Engine compartment panel fuse7-62
 Engine coolant7-29
 Engine Coolant Temperature gauge.....3-61

Engine number	8-9
Engine oil	7-27
Engine start/stop button	5-4
Explanation of scheduled maintenance items	7-24
Exterior care.....	7-86
Exterior overview (front).....	1-2
Exterior overview (rear)	1-3

F

Flat tire (with Tire Mobility kit)	6-15
Floor mat anchor(s).....	3-152
Fluid	
Brake fluid.....	7-33
Washer fluid	7-34
Folding rear seats	2-12
Folding the outside rearview mirror	3-36
Foot parking brake	5-20
Forward collision warning system (FCWS)	5-63
Front lamp	3-116
Front seats	2-6
Fuel Economy	3-100
Fuel filler lid	3-53
Emergency fuel filler door release	3-53
Fuel Gauge	3-60
Fuel requirements	F-7
Fuse switch	7-62

Fuses	7-60
Engine compartment panel fuse.....	7-62
Fuse switch.....	7-62
Fuse/relay panel description.....	7-64
Instrument panel fuse	7-61
Main fuse.....	7-63
Multi fuse	7-63

G

Gauges.....	3-59
Glove box.....	3-145
Glove box lamp.....	3-119

H

Hazard warning flasher	6-2
Hazardous driving conditions	5-78
Head restraints	2-16
Headlamp bulb replacement	7-73
Headlamp delay function	3-113
Headlamp position	3-108
Heated steering wheel.....	3-17
Heater	
Automatic climate control system.....	3-128
Manual climate control system	3-129
HEV(Hybrid Electric Vehicle) system.....	H-2
High - beam operation	3-109
High mounted stop lamp.....	7-84

Highway driving	5-81
Hill-start assist control (HAC).....	5-39
Hood.....	3-46
Horn	3-18
How to use this manual	F-6
Hybrid Battery SOC (State of Charge) Gauge	3-60
Hybrid starter and generator belt (HSG belt).....	7-32
Hybrid System Gauge.....	3-59

I

If an accident occurs	6-26
If the engine overheats.....	6-7
If the vehicle stalls at a crossroad or crossing.....	6-2
If the vehicle stalls while driving	6-2
If the vehicle will not start.....	6-3
If you have a flat tire	6-15
If you have a flat tire while driving.....	6-3
Immobilizer system.....	3-7
Important safety precautions.....	2-2
Air bag hazards	2-2
Always wear your seat belt	2-2
Control your speed	2-3
Driver distraction.....	2-2
Keep your vehicle in safe condition.....	2-3
Restrain all children	2-2
In case of emergency while driving.....	6-2
Indicator lights (Instrument cluster)	3-63
Information Mode	3-91

Inside rearview mirror	3-19
Instrument cluster	3-57
Automtice transaxle shift indicator	3-72
Gauges	3-59
Instrument panel illumination	3-58
LCD Display Control	3-88
Instrument panel fuse.....	7-61
Instrument panel overview	1-5
Interior care.....	7-91
Interior features.....	3-147
Clock	3-150
Clothes hanger.....	3-151
Cup holder	3-147
Floor mat anchor(s).....	3-152
Power outlet.....	3-148
Side curtain.....	3-153
Sunvisor.....	3-148
Interior lamp AUTO cut.....	3-116
Interior light bulb replacement	7-84
Interior lights.....	3-116
Door courtesy lamp	3-118
Front lamp	3-116
Glove box lamp	3-119
Interior lamp AUTO cut	3-116
Rear lamp.....	3-118
Room lamp	3-116
Trunk room lamp.....	3-118
Vanity mirror lamp	3-119
Interior overview.....	1-4

J

Jump starting.....6-4

K

Keys3-3
Smart key.....3-3

L

Label
Air bag warning labels2-70
Tire sidewall labeling7-50
Tire specification and pressure label.....8-9
Vehicle certification label.....8-8
Lane departure warnings system (LDWS)5-66
LCD display3-88
A/V mode3-90
Information Mode3-91
LCD modes3-88
Trip computer modes.....3-88
Turn by turn (TBT) mode3-90
User settings mode3-93
Warning Messages.....3-76
LCD Display Control.....3-88
LCD modes3-88

License plate light bulb replacement7-84
Light3-107
Auto light position.....3-107
Battery saver function3-113
Daytime running light3-114
Headlamp delay function.....3-113
Headlamp position.....3-108
High - beam operation.....3-109
Interior lights3-116
Parking lamp position3-108
Smart high beam3-109
Turn signals3-112
Welcome system3-115
Light bulbs7-73
Lubricants and capacities.....8-6
Luggage net holder3-153

M

Main fuse7-63
Maintenance
Explanation of scheduled maintenance items7-24
Maintenance services7-4
Owner maintenance.....7-5
Tire maintenance7-50
Maintenance schedule.....7-8
Maintenance under severe usage conditions.....7-22
Normal maintenance schedule7-9

Index

Maintenance services	7-4
Mirrors	3-19
Day/night rearview mirror.....	3-19
Electric chromic mirror (ECM).....	3-20
Folding the outside rearview mirror.....	3-36
Inside rearview mirror.....	3-19
Outside rearview mirror	3-34
Reverse parking aid function	3-37
Moonroof, see panoramic sunroof.....	3-42
Multi box.....	3-146
Multi fuse.....	7-63
Multimedia system	
Antenna	4-2
Audio/Video/Navigation system(AVN)	4-4
AUX, USB and iPod® port.....	4-2
Bluetooth® Wireless Technology Hands-Free.....	4-4
Steering wheel audio control.....	4-3

O

Odometer.....	3-63
Oil (Engine)	7-27
Outside rearview mirror.....	3-34
Outside temperature gauge	3-62
Owner maintenance	7-5

P

Panoramic sunroof.....	3-42
Parking brake	7-34
Parking lamp position	3-108
Passenger's front air bag.....	2-49
Power brakes.....	5-19
Power outlet	3-148
Power window lock button	3-41

R

Rear combination light bulb replacement.....	7-79
Rear lamp	3-118
Rear parking assist system (RPAS)	3-123
Rear seats	2-12
Rear view camera	3-122
Recommended cold tire inflation pressures	7-45
Recommended lubricants and capacities	8-6
Recommended SAE viscosity number.....	8-7
Replacement light bulb	7-73
Back-up lamp	7-83
High mounted stop lamp	7-84
Interior light bulb replacement.....	7-84
License plate light bulb replacement	7-84
Reporting safety defects	8-10
Reverse parking aid function	3-37

Rocking the vehicle	5-78
Room lamp	3-116
Rotation (Tire)	7-47

S

Safety messages	F-6
Scheduled maintenance service	7-8
Seat belts	2-24
Additional seat belt safety precautions	2-32
Care of seat belts	2-35
Height adjustment	2-26
Pre-tensioner seat belt	2-29
Rear center seat belt	2-32
Seat belt restraint system	2-26
Seat belt safety precautions	2-24
Seat belt warning light	2-25
Seat warmers	2-20
Seatback pockets	2-11
Seats	2-4
Air ventilation seats	2-22
Armrest	2-14
Folding rear seats	2-12
Front seats	2-6
Head restraints	2-16
Rear seats	2-12
Safety precautions	2-5
Seat warmers	2-20
Seatback pockets	2-11
Shift lock system	5-16
Shift-lock release	5-16
Side air bags	2-50
Side curtain	3-153
Smart cruise control system	5-48
Smart high beam	3-109
Smart key	3-3
Smart trunk	3-50
Smooth cornering	5-79
Snow tires	5-82
Sonata HEV energy flow	H-11
Special driving conditions	5-78
Driving at night	5-79
Driving in flooded areas	5-80
Driving in the rain	5-80
Hazardous driving conditions	5-78
Highway driving	5-81
Rocking the vehicle	5-78
Smooth cornering	5-79
Speedometer	3-59
Sports mode	5-15
Starting difficulties, see engine will not start	6-3
Starting the hybrid vehicle (Smart key)	H-15
Steering wheel	3-16
Electric power steering (EPS)	3-16
Heated steering wheel	3-17
Horn	3-18
Telescope steering	3-17
Tilt steering	3-17

Steering wheel audio control	4-3
Storage compartment	3-145
Center console storage	3-145
Glove box	3-145
Multi box	3-146
Sunglass holder	3-146
Sunglass holder	3-146
Sunroof, see panoramic sunroof	3-42
Sunvisor	3-148

T

Telescope steering.....	3-17
The components of hybrid system.....	H-18
Theft-alarm system	3-13
Tilt steering	3-17
Tire chains.....	5-83
Tire Mobility kit.....	6-15
Tire pressure monitoring system(TPMS)	6-9
Tire rotation	7-47
Tire specification and pressure label	8-9
Tires and wheels.....	7-44, 8-4
Checking tire inflation pressure	7-46
Low aspect ratio tires	7-58
Recommended cold tire inflation pressures	7-45
Tire care.....	7-44
Tire maintenance	7-50
Tire replacement.....	7-48

Tire rotation.....	7-47
Tire sidewall labeling	7-50
Tire traction	7-49
Wheel alignment and tire balance.....	7-48
Wheel replacement.....	7-48
Towing	6-22
Trailer towing.....	5-92
Transaxle	
Automatic transaxle.....	5-12
Shift lock system	5-16
Shift-lock release.....	5-16
Trip A/B	3-99
Trip computer.....	3-98
Digital speedometer.....	3-102
Fuel Economy	3-100
Trip A/B.....	3-99
Trunk.....	3-47
Smart trunk.....	3-50
Trunk room lamp	3-118
Turn by turn (TBT) mode.....	3-90
Turn signals.....	3-112

U

User settings mode.....	3-93
-------------------------	------

V

Vanity mirror lamp	3-119
Vehicle break-in process	F-9
Vehicle certification label	8-8
Vehicle data collection and event data recorders	F-11
Vehicle identification number (VIN)	8-8
Vehicle load limit	5-87
Vehicle Stability Management	5-38
Volume and weight	8-5

W

Warning lights (Instrument cluster)	3-63
Warning Messages (LCD display)	3-76
Washer fluid	7-34
Welcome system	3-115
Wheel alignment and tire balance	7-48
Wheel replacement	7-48
Windows	3-38
Power window lock button	3-41
Windshield defrosting and defogging	3-141
Windshield washers	3-121
Windshield wipers	3-120
Winter driving	5-82
Snow tires	5-82
Tire chains	5-83
Winter precautions	5-84

Winter precautions	5-84
Wiper blades	7-39
Wipers and washers	3-120
Windshield washers	3-121
Windshield wipers	3-120

Hybrid system quick reference

HEV (HYBRID ELECTRIC VEHICLE) SYSTEM / 2
DISPLAY OF HYBRID SYSTEM / 3
ΣΟΠΑΤΑ HEV ΕΠΕΡΓΥ FLOW / 11
STARTING THE HYBRID VEHICLE (SMART KEY) / 15
THE COMPONENTS OF HYBRID VEHICLE / 18
EMERGENCY SITUATIONS / 24

HEV (HYBRID ELECTRIC VEHICLE) SYSTEM

The HYUNDAI Hybrid Electric Vehicle (HEV) uses both the gasoline engine and the electric motor for power. The electric motor is run by a 270V high-voltage HEV battery.

Depending on the driving conditions, the HEV computer selectively operates between the engine and the electric motor or even both at the same time.

Fuel efficiency increases when the engine is off at idle, or when the vehicle is driven by the electric motor with the HEV battery.

The HEV battery charge must be maintained, so at times the engine will come on even at idle to act as a generator. Charging also occurs when decelerating or by regenerative braking.

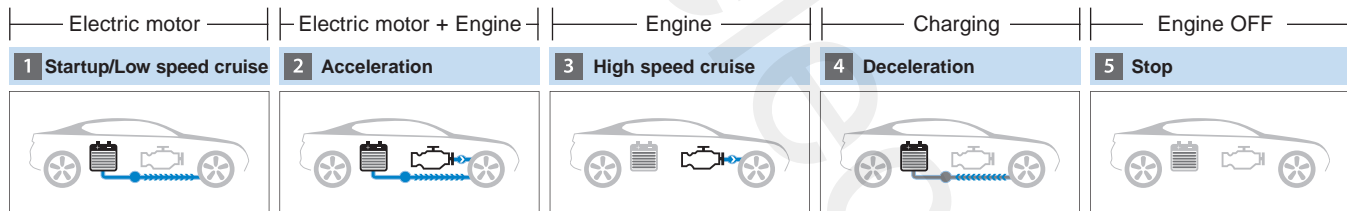

OLFH054001

DISPLAY OF HYBRID SYSTEM

Gauges

Hybrid System Gauge



The hybrid system gauge indicates whether the current driving condition is fuel efficient or not.

- **CHARGE :**
Shows that the energy made by the vehicle is being converted to electrical energy. (Regenerated energy)
- **ECO :**
Shows that the vehicle is being driven in an Eco-friendly manner.
- **POWER :**
Shows that the vehicle is exceeding the Eco-friendly range.

According to the hybrid system gauge area, the "EV" indicator comes on or off.

- "EV" indicator ON : Vehicle is driven using the electric motor or the gasoline engine is stopped.
- "EV" indicator OFF : Vehicle is driven using the gasoline engine.

Hybrid Battery SOC (State of Charge) Gauge

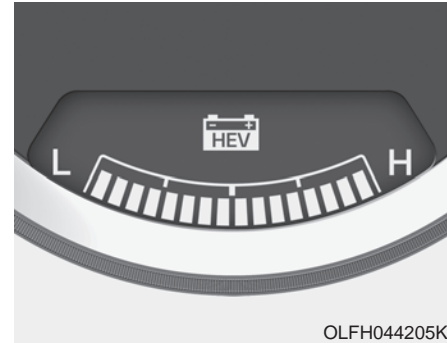

This gauge indicates the remaining hybrid battery power. If the SOC is near the "L (Low)" level, the vehicle automatically operates the engine to charge the battery. However, if the Service Indicator (⚠) and Malfunction Indicator Lamp (MIL) (🔧) turn on when the SOC (State of charge) gauge is near the "L (Low)" level, have the vehicle checked by an authorized HYUNDAI dealer.

DISPLAY OF HYBRID SYSTEM (CONT.)

Warning and indicator lights

Ready Indicator



- This indicator illuminates :
When the vehicle is ready to be driven.
- ON : Normal driving is possible.
 - OFF : Normal driving is not possible, or a problem has occurred.
 - Blinking : Emergency driving.

When the ready indicator goes OFF or blinks, there is a problem with the system. In this case, have your vehicle inspected by an authorized HYUNDAI dealer.

Service Warning Light



- This warning light illuminates :
- When the Engine Start/Stop button is in the ON position.
 - It illuminates for approximately 3 seconds and then goes off.
 - When there is a problem with the hybrid vehicle control system or hardware.

When the warning light illuminates while driving, or does not go OFF after starting the vehicle, have your vehicle inspected by an authorized HYUNDAI dealer.

EV Mode Indicator

EV

This indicator illuminates when the vehicle is driven by the electric motor.

Regenerative Brake Warning Light



This warning light illuminates :
When the regenerative brake does not operate and the brake does not perform well. This causes the Brake Warning light (red) and Regenerative Brake Warning Light (yellow) to illuminate simultaneously.

In this case, drive safely and have your vehicle inspected by an authorized HYUNDAI dealer.

The operation of the brake pedal may be more difficult than normal and the braking distance can increase.

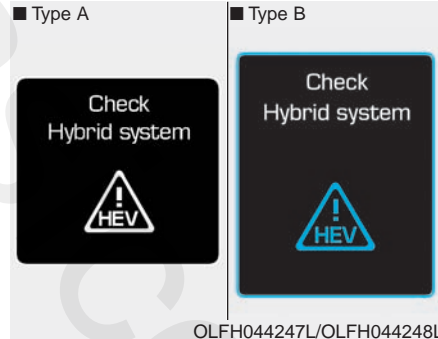

Check Hybrid system

This warning message illuminates when there is a problem with the hybrid control system.

Refrain from driving when the warning message is displayed.

In this case, have your vehicle inspected by an authorized HYUNDAI dealer.

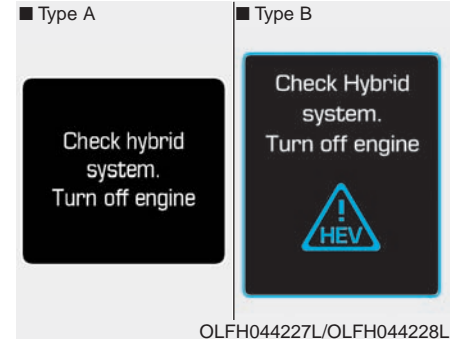

Check Hybrid system. Turn off engine.

This warning message illuminates when there is a problem with the hybrid system. The "!" indicator will blink and a warning chime will sound until the problem is solved.

In this case, have your vehicle inspected by an authorized HYUNDAI dealer.

DISPLAY OF HYBRID SYSTEM (CONT.)

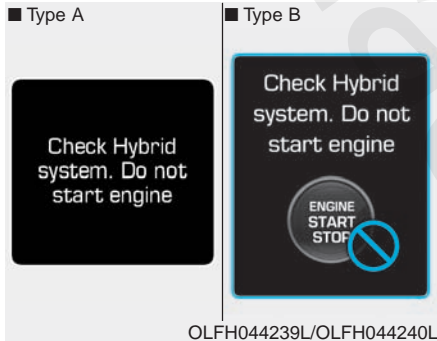

Check Hybrid system. Do not start engine.

This warning message illuminates when the hybrid battery power (SOC) level is low. A warning chime will sound until the problem is solved.

You may pull over to a complete stop with parking brake on hold the accelerator Down fully to the floor to attempt rapid Charge back of the battery at a controlled Speed. Watch the HEV Battery Gauge to make Sure it is moving higher. If not there may be a problem. In that case, have your vehicle inspected by An authorized HYUNDAI dealer.

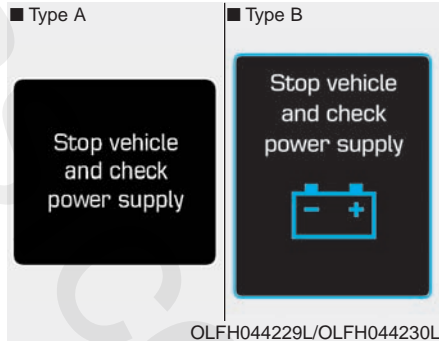

Stop vehicle and check power supply

This warning message illuminates when a failure occurs in the power supply system.

In this case, park the vehicle in a safe location and tow your vehicle to the nearest authorized HYUNDAI dealer and have the vehicle inspected.

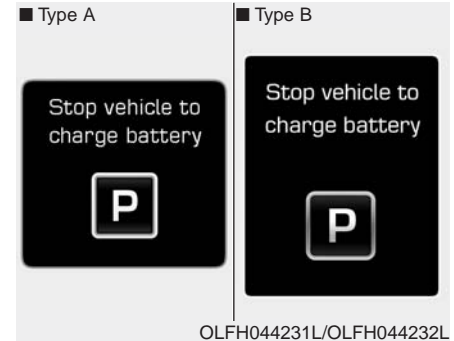

Stop vehicle to charge battery

This warning message illuminates when the hybrid battery power (SOC) level is low.

In this case, park the vehicle in a safe location and wait until the hybrid battery is charged.

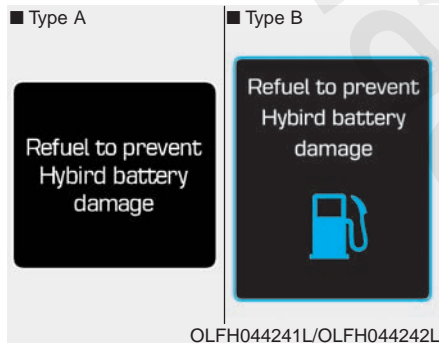

Refuel to prevent Hybrid battery damage

This warning message illuminates when the fuel tank is nearly empty. You should refill the fuel tank to prevent hybrid battery damage.

NOTICE

Do not continue to run the vehicle out of gas thinking that vehicle can continue to operate in EV only. it may damage the HEV Battery.

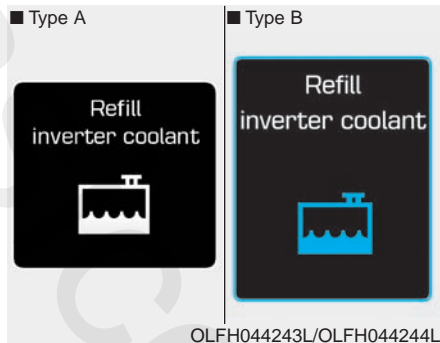

Refill inverter coolant

This warning message illuminates when the inverter coolant is nearly empty. You should refill the inverter coolant.

You should refill the inverter coolant.

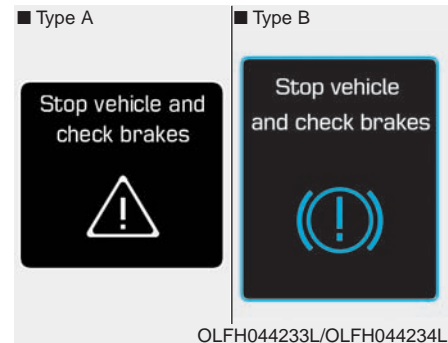

Stop vehicle and check brakes

This warning message illuminates when a failure occurs in the brake system.

In this case, park the vehicle in a safe location and tow your vehicle to the nearest authorized HYUNDAI dealer and have the vehicle inspected.

DISPLAY OF HYBRID SYSTEM (CONT.)

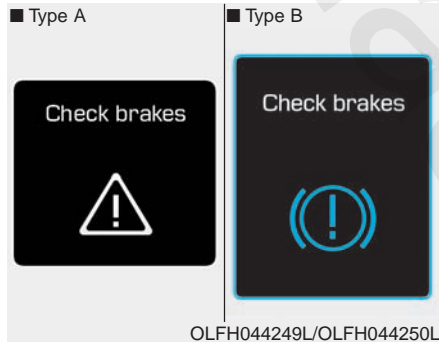

Check brakes

This warning message illuminates when the brake performance is low or the regenerative brake does not work properly due to a failure in the brake system.

In this case, it may take longer for the brake pedal to operate and the braking distance may become longer.

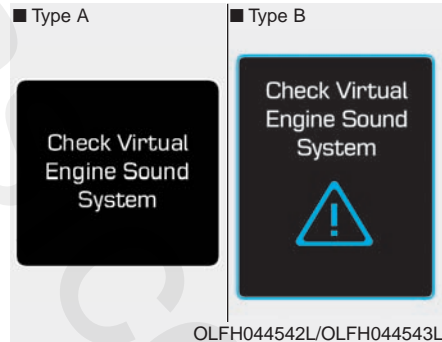

Check Virtual Engine Sound System

This message illuminates when there is a problem with the Virtual Engine Sound System (VESS).

In this case, have your vehicle inspected by an authorized HYUNDAI dealer.

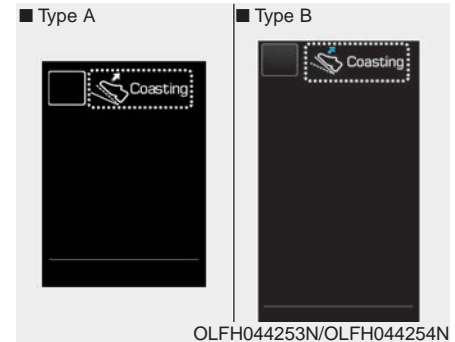

Coasting guide (if equipped)

It informs the driver when to take the foot off from the accelerator by anticipating a decelerating event* based on the analysis of driving routes and road conditions of the navigation. It induces the driver to coast the vehicle on a road only with the electrical-motor power. This prevents unnecessary fuel consumption and increases fuel efficiency

- ✳ Examples of decelerating events: U-turn, turnings to the right/left, traffic circles, highway junctions, tollgates, and roadside unmanned cameras to detect speeding.

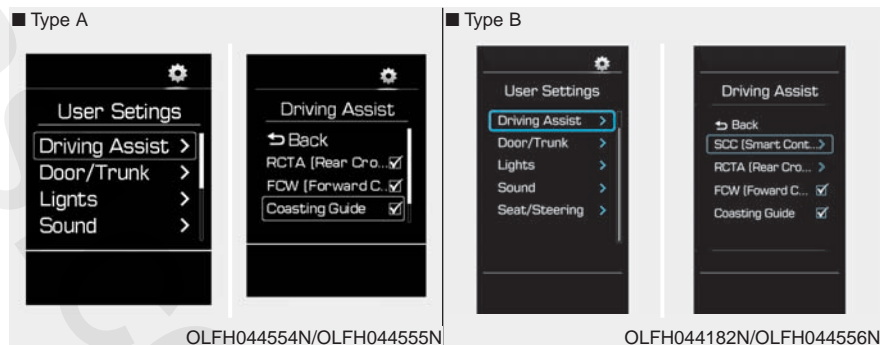

Operation conditions

Press the Engine Start/Stop button. In the User Settings Mode, select Driving Assistance, and then Coasting Guide to turn on the system.

Cancel the selection of coasting guide to turn off the system.

To activate the system, take the following procedures. Enter your destination information on the navigation and select the driving route. Select the ECO mode in the Integrated Driving Control System. Then, satisfy the following.

- The driving speed should be between 37 mph (60 km/h) and 99 mph (160 km/h).

- ✳ The operating condition (driving speed) varies in a situation, as there may be a difference in displaying the driving speeds between the instrument cluster and the navigation, and as there may a difference between the actual driving speed and the driving speed display in accordance with a tire inflating condition.

■ DISPLAY OF HYBRID SYSTEM (CONT.)

i Information

Coasting guide is only a supplemental system to promote the fuel-efficient driving. Thus, the operating conditions may be different in accordance with traffic/road conditions (i.e. driving in a traffic jam, driving on a slope, driving on a curve). Thus, take the actual driving conditions into consideration, such as distances from the vehicles ahead/behind, while referring to the coasting guide system as guidance.

SONATA HEV ENERGY FLOW

Energy flow

The hybrid system informs the drivers its energy flow in various operating modes. While driving, the current energy flow is specified in 11 modes.

Vehicle Stop

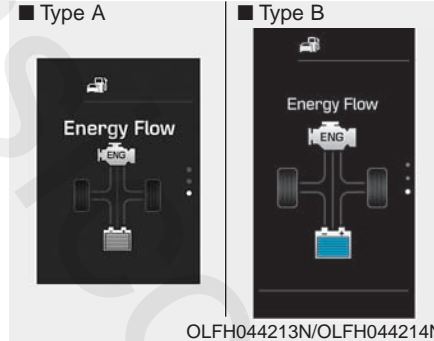

The vehicle is stopped.
(No energy flow)

EV Propulsion

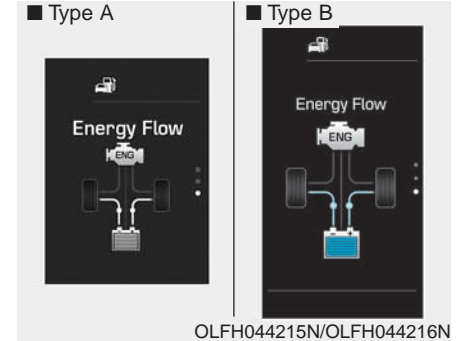

Only the motor power is used to drive the vehicle.
(Battery → Wheel)

SONATA HEV ENERGY FLOW (CONT.)

Power Assist

■ Type A



OLFH044217N/OLFH044218N

■ Type B

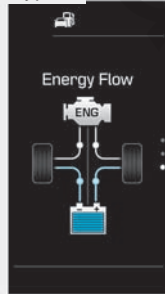

Both the motor and the engine power are used to drive the vehicle.
(Battery & Energy → Wheel)

Engine Only Propulsion

■ Type A

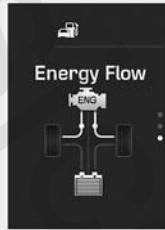

OLFH044219N/OLFH044220N

■ Type B

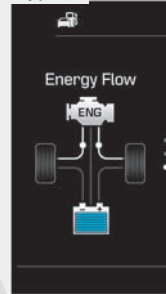

Only the engine power is used to drive the vehicle.
(Engine → Wheel)

Engine Generation

■ Type A

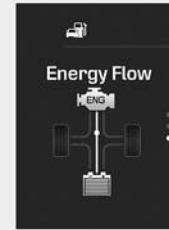

OLFH044221N/OLFH044222N

■ Type B

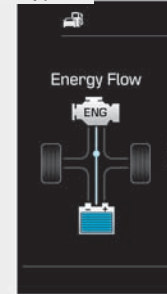

When the vehicle is stopped, the high-voltage battery is charged up by the engine.
(Engine → Battery)

Regeneration

■ Type A



OLF044215N/OLF044216N

■ Type B

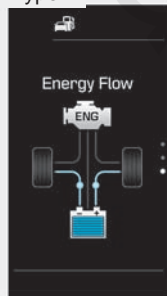

The high-voltage battery is charged up by the regenerative brake system.
(Wheel → Battery)

Engine Brake

■ Type A



OLF044219N/OLF044220N

■ Type B

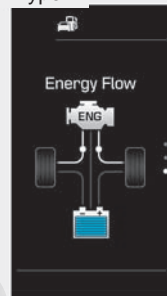

The engine braking is used to decelerate the vehicle.
(Wheel → Engine)

Power Reserve

■ Type A

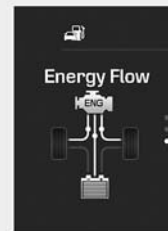

OLF044223N/OLF044224N

■ Type B

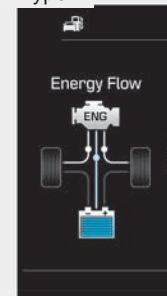

The engine is simultaneously used to drive the vehicle and to charge up the high-voltage battery.
(Engine → Wheel & Battery)

SONATA HEV ENERGY FLOW (CONT.)

Engine Generation/Motor Drive

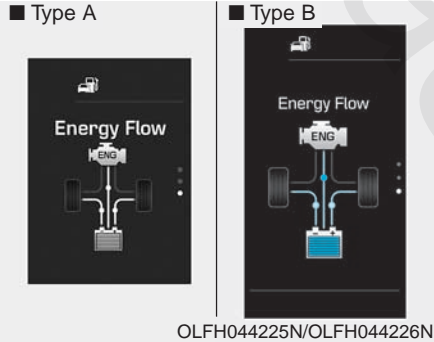

The engine charges up the high-voltage battery. The motor power is used to drive the vehicle.

(Engine → Battery → Wheel)

Engine Generation/Regeneration

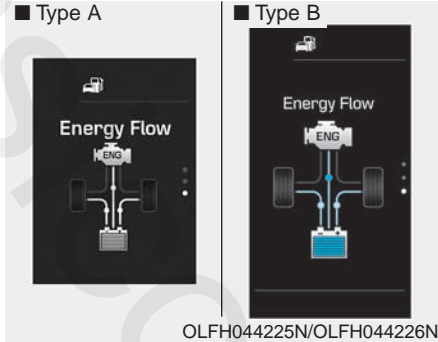

The engine and regenerative brake system charges up the high-voltage battery.

(Engine & Wheel → Battery)

Engine Brake/Regeneration

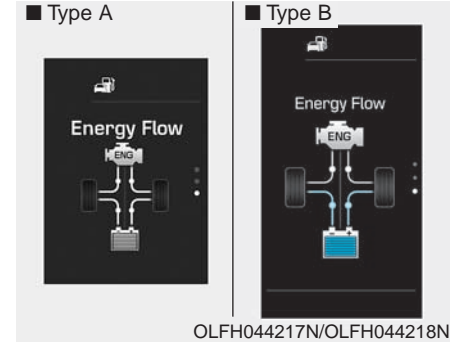

The engine braking is simultaneously used to decelerate the vehicle and to charge up the high-voltage battery.

(Wheel → Engine & Battery)

STARTING THE HYBRID VEHICLE (SMART KEY)

Starting the vehicle

1. Carry the smart key or leave it inside the vehicle.
2. Make sure the parking brake is firmly applied.
3. Place the shift lever in P (Park) with the shift lever in N (Neutral), you cannot start the vehicle.
4. Depress the brake pedal.
5. Press the Engine Start/Stop button. If the hybrid system starts, the "🚗" indicator will come on and a double chime can be heard.

Whether the engine is cold or warm, it should be started without depressing the accelerator.

After following the start procedures, "🚗" indicator on the instrument cluster will turn on.

For more information, please check Chapter 5.

ECONOMICAL and SAFE OPERATION of Hybrid system

- Drive smoothly. Accelerate at a moderate rate and maintain a steady cruising speed. Do not make "jack-rabbit" starts. Do not race between stoplights.

Avoid heavy traffic whenever possible. Always maintain a safe distance from other vehicles so you can avoid unnecessary braking. This also reduces brake wear out.

- The regenerative brake generates energy when the vehicle decelerates.
- When the hybrid battery power is low, the hybrid system automatically recharges the hybrid battery.
- When the engine runs with the shift lever in N (Neutral), the hybrid system cannot generate electricity. The hybrid battery cannot recharge with the shift lever in N (Neutral).

Information

In the hybrid system, the engine automatically runs and stops. When the hybrid system operates, the "🚗" indicator is illuminated.

In the following situation, the engine may operate automatically.

- When the engine is ready to run
- When the hybrid battery is being charged
- Depending on the temperature condition of the hybrid battery

WARNING

To avoid serious injury, turn off hybrid system and be sure "🚗" indicator is off before working under hood. Engine may start unexpectedly.



STARTING THE HYBRID VEHICLE (SMART KEY) (CONT.)

Special features of hybrid vehicle

Hybrid vehicles sound different than gasoline engine vehicles. When the hybrid system operates, you may hear a sound from the hybrid battery system behind the rear seat. If you apply the accelerator pedal rapidly, you may hear an unconventional sound. When you apply the brake pedal, you may hear a sound from the regenerative brake system. When the hybrid system is turned off or on, you may hear a sound in the engine compartment. If you depress the brake pedal repeatedly when the hybrid system is turned on, you may hear a sound in the engine compartment. None of these sounds indicate a problem. These are normal characteristics of hybrid vehicles.

If any of following occur, it's a normal condition if you hear a motor sound in the engine compartment:

- After turning off the hybrid system, the brake pedal is released.
- When the hybrid system is turned off, the brake pedal is applied.
- When the driver door is opened.

When the hybrid system is turned ON, the engine may run or may not. In this situation, you may feel a vibration. This does not indicate a malfunction. When the “” indicator illuminates, the hybrid system is ready to start. Even if the engine is off, you can operate the vehicle as long as the “” indicator is illuminated.

NOTICE

The hybrid system contains many electronic components. High voltage components, such as cables and other parts, may emit electromagnetic waves. Even when the electromagnetic cover blocks electromagnetic emissions, electromagnetic waves may have an effect on electronic appliances. When your vehicle is not for a long period of time, the hybrid system will discharge. You need to drive the vehicle several times a month. We recommend driving at least for 1 hour or 10 miles. When the hybrid battery is discharged, or when it is impossible to jump start the vehicle, contact your HYUNDAI dealer.

 **WARNING**

- When you start the hybrid system with the shift lever in P (Parking), the “” indicator illuminates on the instrument cluster. The driver can drive the vehicle, even when the engine is stopped.
- When you leave the vehicle, you should turn OFF the hybrid system or locate the shift lever in P (Park). When you depress the accelerator pedal by mistake, or when the shift lever is not in P (Park), the vehicle will abruptly move, possibly resulting in serious injury or death.

Virtual Engine Sound System (VESS)

The Virtual Engine Sound System generates engine sound for pedestrians to hear vehicle sound because there is limited sound while motor power is used.

THE COMPONENTS OF HYBRID VEHICLE

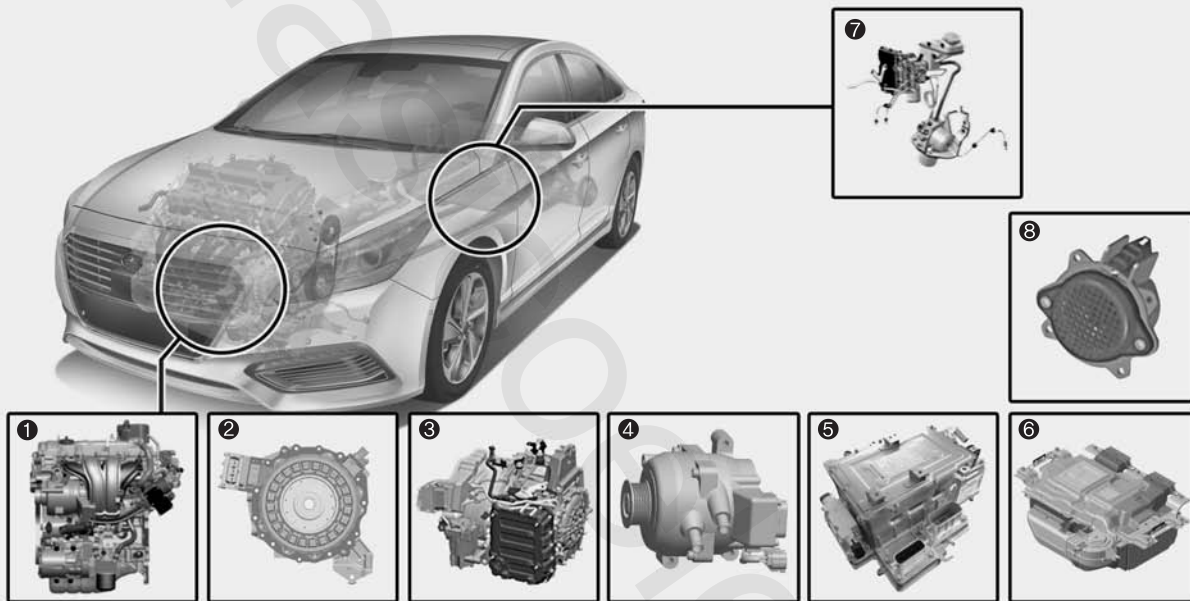

1. Engine : 2.0L

2. Drive Motor : 38kW

3. Transmission : 6AT

4. Hybrid Starter Generator (HSG)

5. Hybrid Power Control Unit (HPCU)

6. High voltage battery system

7. Generative brake system

8. Virtual Engine Sound System (VESS)

OLFHQ015001N

Hybrid vehicle components safety precautions

High voltage battery system

■ HPCU (Hybrid Power Control Unit)

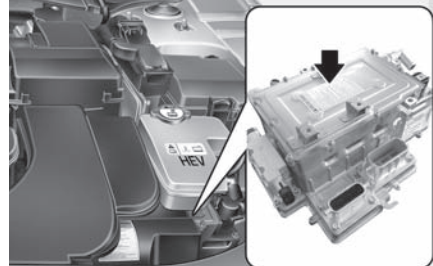

OLFHQ014002K

■ High voltage battery system

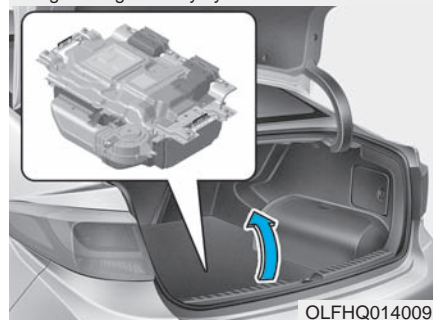

OLFHQ014009L

⚠ WARNING

Never touch orange colored or high voltage labeled components, including wires, cables, and connections. When the insulators or covers are damaged or removed, severe injury or death from electrocution may occur.

⚠ WARNING

While replacing the fuses in the engine compartment, never touch the HPCU. The HPCU carries high voltage. Touching the HPCU may result in electrocution, serious injury, or death.

⚠ WARNING

In the hybrid system, the hybrid battery uses high voltage to operate the motor and other components. This high voltage hybrid battery system can be very dangerous. Never touch the hybrid system. When you touch the hybrid battery system, serious injury or death may occur.

⚠ CAUTION

- Do not pile up any items in an area behind the high voltage battery. In a crash, the battery may become unstable, or its performance may degrade.
- Do not apply strong force nor pile up any items above the trunk. Such an attempt may distort the high voltage battery case, causing a safety problem or degrading the performance.

(Continued)

THE COMPONENTS OF HYBRID VEHICLE (CONT.)

(Continued)

- Be careful when loading inflammable liquid in trunk. It could cause operational and safety degradation if the liquid leaks and flows in high voltage battery

■ Drive motor

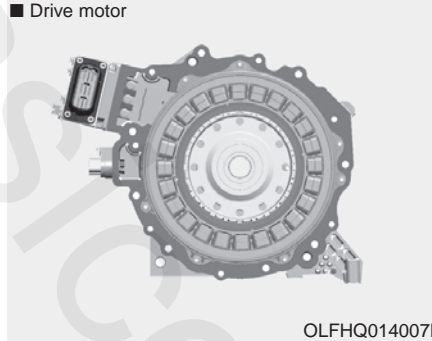

OLFHQ014007L

⚠ WARNING

- Do not disassemble the high voltage motor connector. The high voltage motor connector may contain residual high voltage. Coming in contact with high voltage may result in death or serious injury.
- Your vehicle's hybrid system should only be inspected or repaired by an authorized HYUNDAI dealer.

⚠ WARNING

- Do not disassemble or assemble the high voltage battery system. Doing so may result in electric shock, causing death or serious injury.
- If you disassemble or assemble hybrid system components improperly, it may damage the performance and reliability of your vehicle.
- If electrolyte comes in contact with your body, clothes or eyes, immediately flush with a large quantity of fresh tap water. Have your eyes examined by a doctor as soon as possible.

⚠ WARNING

Never assemble or disassemble the high voltage battery system.

- If you assemble or disassemble the high voltage battery system, the durability and performance of the vehicle may be damaged.
- When you want to check the high voltage battery system, have the vehicle checked and inspected by an authorized HYUNDAI dealer.
- Do not touch the high voltage battery and high voltage cable connected to motor (orange color). Severe burns and electric shock may occur. For your safety, do not touch the cover of electronic components and electronic cable. Do not remove the cover of electronic components and electronic cable. In particular, never touch the high voltage battery system when the hybrid system in operation. It may result in death or serious injury.

⚠ WARNING

- Never use the package modules (high voltage battery, inverter and converter) for any other purpose.
- Do not use an unauthorized battery charger to charge the high voltage battery. Doing so may result in death or serious injury.
- Never locate the high voltage system near or in a fire.
- Never drill into or strike the package module. Otherwise, it may be damaged. An electric shock may occur, resulting in serious injury or death.

NOTICE

- When the vehicle is paint baked, do not bake over 30 minutes in 158°F (70°C) or 20 minutes in 176°F (80°C) degree.
- Do not wash the engine compartment, using water. Water may cause an electric shock to and damage the electronic.

⚠ WARNING

This hybrid vehicle uses the hybrid battery system inverter and converter to generate high voltage. High voltage in the hybrid battery system is very dangerous and may cause severe burns and electric shock. This may result in serious injury or death.

(Continued)

THE COMPONENTS OF HYBRID VEHICLE (CONT.)

(Continued)

- For your safety, never touch, replace, disassemble or remove the hybrid battery system including components, cables and connectors. Severe burns or electric shock may result in serious injury or death when you fail to follow this warning.
- When the hybrid battery system operates, the hybrid battery system can be hot. Always be careful because burns or electric shock may be caused by high voltage.
- Do not drop water or liquid on to HPCU, HSG, motor and fuses. The hybrid system components are covered. If you drop water or liquid on to hybrid system components, it may result in electric shock.

Safety plug

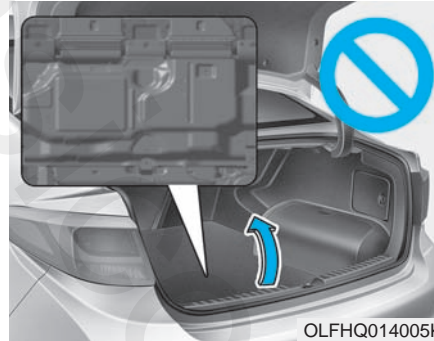

⚠ DANGER

Never touch the safety plug. Safety plug is attached to high voltage hybrid battery system. Touching safety plug will result in death or serious injury. Service personnel should follow procedure in service manual.

Hybrid battery air intake

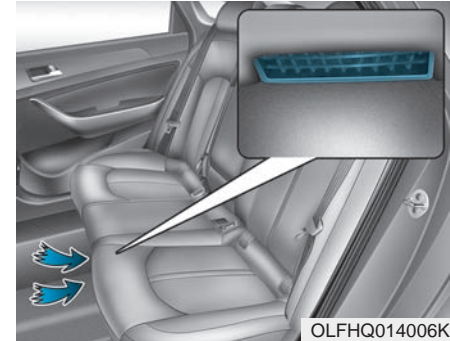

The hybrid battery air intake is located on bottom the rear seats. The air intake cools down the hybrid battery. When the hybrid battery air intake is blocked, the hybrid battery may be overheated and the vehicle performance may become limited and set a hybrid warning lamp. Do not obstruct the air intake with any other objects.

WARNING

- Never clean the air intake of the hybrid battery with a wet cloth. If any water enters in the air intake of the hybrid battery, the hybrid battery may cause an electric shock, resulting in a serious damage, an injury or a death.
- The hybrid battery is composed of lithium-ion polymer. If the hybrid battery is improperly handled, it is dangerous to the environment. Also it may cause electrical shock and severe burns, resulting in a serious injury or a death.
- Do not spill liquid over the air intake of the hybrid battery. Doing so is very dangerous. It may cause electric shock or serious injury.
- Do not cover the air intake with objects.

(Continued)

(Continued)

- Do not put any objects into the air intake of the hybrid battery. Doing so may cause loss of air-intake volume to the hybrid battery. When the air intake is blocked with any objects, immediately contact your HYUNDAI dealer.
- Never place a container of liquid on or near the air intake. If the liquid spills, the hybrid battery located in the trunk may be damaged.
- Secure all loads in the trunk to prevent them from being tossed about before driving. When a sharp or heavy load strike with a strong impact or pierce the interior trunk wall, the hybrid battery system may be damaged, deteriorating its performance.

Information

Clean the air intake for the hybrid battery with a dry cloth on a regular basis.

EMERGENCY SITUATIONS

If an accident occurs

WARNING

- For your safety, do not touch high voltage cables, connectors and package modules. High voltage components are orange in color.
- Exposed cables or wires may be visible inside or outside of the vehicle. Never touch the wires or cables, because an electrical shock, an injury, or a death may occur.
- Any gas or electrolyte leakage from your vehicle is not only poisonous but also flammable. Upon witnessing one of those, open the windows, and remain a safe distance from the vehicle out of the road.
Immediately contact an authorized HYUNDAI dealer and advise them that a hybrid vehicle is involved.

(Continued)

(Continued)

- When the vehicle is severely damaged, remain a safe distance of 50 feet (15 meter) or more between your vehicle and other vehicles/flammables.

WARNING

If a fire occurs :

Upon witnessing any sparks, gases, flames, or fuel leakage of your vehicle, immediately call 911 or contact an authorized HYUNDAI dealer. Also, advise them that a hybrid vehicle is involved.

WARNING

When a submersion in water occurs:

When your vehicle is flooded in water, a high-voltage battery may cause shock or fires. Thus, turn the hybrid system OFF, take the key in your possession and escape to a safe place. Never attempt physical contact with your flooded vehicle.

Immediately contact an authorized HYUNDAI dealer and advise them that a hybrid vehicle is involved.

When the hybrid vehicle shuts off

When the high voltage battery is discharged, when the 12-volt battery is discharged, or when the fuel tank is empty, the hybrid system may not operate while driving. When the Hybrid system does not operate, do the followings:

1. Gradually reduce the vehicle speed. Pull over your vehicle off the road in a safe area.
2. Locate the shift lever in P (Park).
3. Turn ON the hazard warning flashers.
4. Turn OFF the Engine Start/Stop button, and try to start the hybrid system, while depressing the brake pedal and pressing the Engine Start/Stop button.

5. When the hybrid system still does not operate, refer to "EMERGENCY STARTING" in the chapter 6.

Before jump-starting the vehicle, check the fuel level and the exact procedure to jump start. For further details, refer to "EMERGENCY STARTING" in the chapter 6. When the fuel level is low, do not attempt to drive the vehicle only with the battery power. The high voltage battery may be discharged, and the hybrid system will turn OFF.