

## TABLE OF CONTENTS

1	<b>Before driving</b>	Adjusting and operating features such as door locks, mirrors, and steering column.
2	<b>When driving</b>	Driving, stopping and safe-driving information.
3	<b>Interior features</b>	Air conditioning and audio systems, as well as other interior features for a comfortable driving experience.
4	<b>Maintenance and care</b>	Cleaning and protecting your vehicle, performing do-it-yourself maintenance, and maintenance information.
5	<b>When trouble arises</b>	What to do if the vehicle needs to be towed, gets a flat tire, or is involved in an accident.
6	<b>Vehicle specifications</b>	Detailed vehicle information.
7	<b>For owners</b>	Reporting safety defects for U.S. owners, seat belt and SRS airbag instructions for Canadian owners.
	<b>Index</b>	Alphabetical listing of information contained in this manual.

**1 Before driving**

**1-1. Key information**  
 Keys ..... 28

**1-2. Opening, closing and locking the doors**  
 Wireless remote control ..... 31  
 Side doors ..... 34  
 Back door ..... 38

**1-3. Adjustable components (seats, mirrors, steering wheel)**  
 Front seats ..... 43  
 Rear seats ..... 47  
 Head restraints ..... 51  
 Seat belts ..... 54  
 Steering wheel ..... 62  
 Anti-glare inside rear view mirror ..... 63  
 Outside rear view mirrors ..... 64

**1-4. Opening and closing the windows**  
 Power windows ..... 67

**1-5. Refueling**  
 Opening the fuel tank cap .... 69

**1-6. Theft deterrent system**  
 Engine immobilizer system ..... 72  
 Alarm (Puerto Rico) ..... 74  
 Theft prevention labels (except Canada) ..... 77

**1-7. Safety information**  
 Correct driving posture ..... 78  
 SRS airbags ..... 80  
 Front passenger occupant classification system ..... 92  
 Child restraint systems ..... 98  
 Installing child restraints ..... 102

**2 When driving**

**2-1. Driving procedures**  
 Driving the vehicle ..... 112  
 Engine (ignition) switch ..... 124  
 Automatic transmission ..... 127  
 Manual transmission ..... 129  
 Turn signal lever ..... 130  
 Parking brake ..... 131  
 Horn ..... 132

**2-2. Instrument cluster**  
 Gauges and meters ..... 133  
 Indicators and warning lights ..... 136  
 Multi-information display ..... 140

**2-3. Operating the lights and wipers**  
 Headlight switch ..... 145  
 Fog light switch ..... 148  
 Windshield wiper and washer ..... 150  
 Rear window wiper and washer ..... 153

## 2-4. Using other driving systems

- Cruise control..... 158
- Driving assist systems ..... 162

## 2-5. Driving information

- Cargo and luggage ..... 167
- Vehicle load limits ..... 171
- Winter driving tips ..... 172
- Trailer towing  
(except 3-door models  
for Canada)..... 176
- Trailer towing  
(3-door models  
for Canada)..... 177
- Dinghy towing (vehicles  
with an automatic  
transmission) ..... 187
- Dinghy towing (vehicles  
with a manual  
transmission) ..... 188

## 3-3. Using the interior lights

- Interior lights list ..... 202
- Personal lights..... 203
- Interior light ..... 203

## 3-4. Using the storage features

- List of storage features..... 204
- Glove box ..... 205
- Cup holders..... 205
- Bottle holders ..... 207

## 3-5. Other interior features

- Sun visors..... 208
- Vanity mirrors ..... 209
- Clock ..... 210
- Outside temperature  
display ..... 211
- Power outlet ..... 213
- Assist grips ..... 214
- Floor mat ..... 215
- Luggage compartment  
features ..... 217

## 3 Interior features

### 3-1. Using the air conditioning system and defogger

- Air conditioning system ..... 192
- Rear window and outside  
rear view mirror  
defoggers..... 199

### 3-2. Using the audio system

- Using the AUX port/  
USB port ..... 200
- Using the steering wheel  
audio switches ..... 201

## 4 Maintenance and care

### 4-1. Maintenance and care

- Cleaning and protecting  
the vehicle exterior ..... 222
- Cleaning and protecting  
the vehicle interior ..... 225

1

2

3

4

5

6

7

**4-2. Maintenance**

Maintenance requirements ..... 228  
 General maintenance ..... 230  
 Emission inspection and maintenance (I/M) programs ..... 234

**4-3. Do-it-yourself maintenance**

Do-it-yourself service precautions ..... 235  
 Hood ..... 238  
 Positioning a floor jack ..... 240  
 Engine compartment ..... 243  
 Tires ..... 254  
 Tire inflation pressure ..... 262  
 Wheels ..... 266  
 Air conditioning filter ..... 269  
 Wireless remote control battery ..... 271  
 Checking and replacing fuses ..... 275  
 Light bulbs ..... 287

**5 When trouble arises**

**5-1. Essential information**

Emergency flashers ..... 296  
 If your vehicle needs to be towed ..... 297  
 If you think something is wrong ..... 303  
 Fuel pump shut off system ..... 304

**5-2. Steps to take in an emergency**

If a warning light turns on or a warning buzzer sounds... ..... 305  
 If you have a flat tire ..... 315  
 If the engine will not start .... 327  
 If the shift lever cannot be shifted from P (vehicles with an automatic transmission) ..... 328  
 If you lose your keys ..... 329  
 If the vehicle battery is discharged ..... 330  
 If your vehicle overheats..... 334  
 If the vehicle becomes stuck ..... 337  
 If your vehicle has to be stopped in an emergency ..... 339

**6 Vehicle specifications**

**6-1. Specifications**

Maintenance data (fuel, oil level, etc.) ..... 342  
 Fuel information ..... 353  
 Tire information ..... 356

**6-2. Customization**

Customizable features ..... 368  
 Items to initialize ..... 370

## 7 For owners

Reporting safety defects for U.S. owners .....	372
Seat belt instructions for Canadian owners (in French) .....	373
SRS airbag instructions for Canadian owners (in French) .....	375

## Index

Abbreviation list .....	386
Alphabetical index.....	387
What to do if... ..	396

FarmaSOS.com

1

2

3

4

5

6

7

3-door models

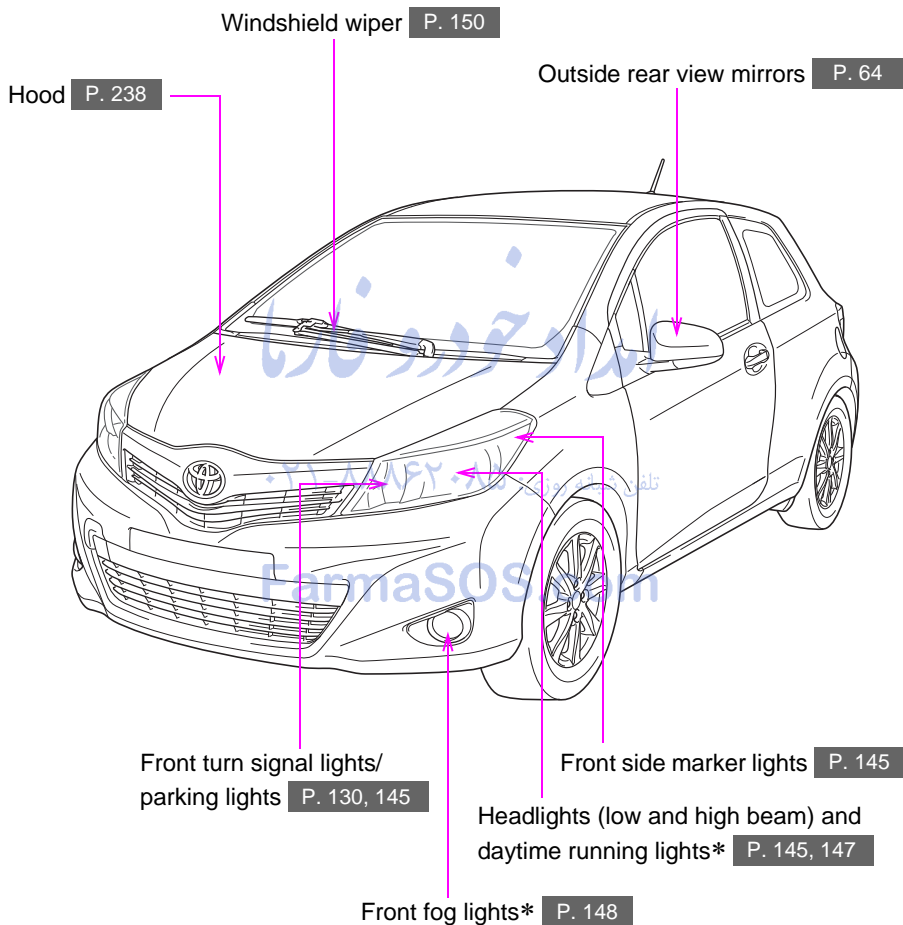

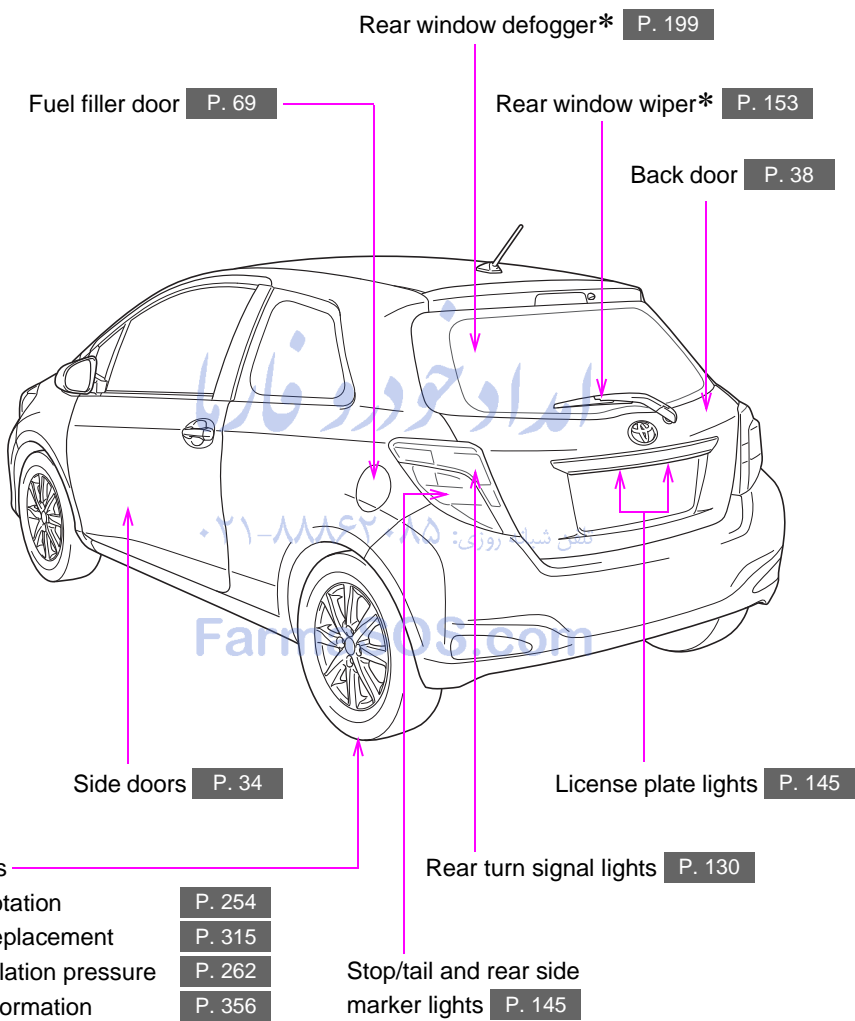

\*: If equipped

5-door models

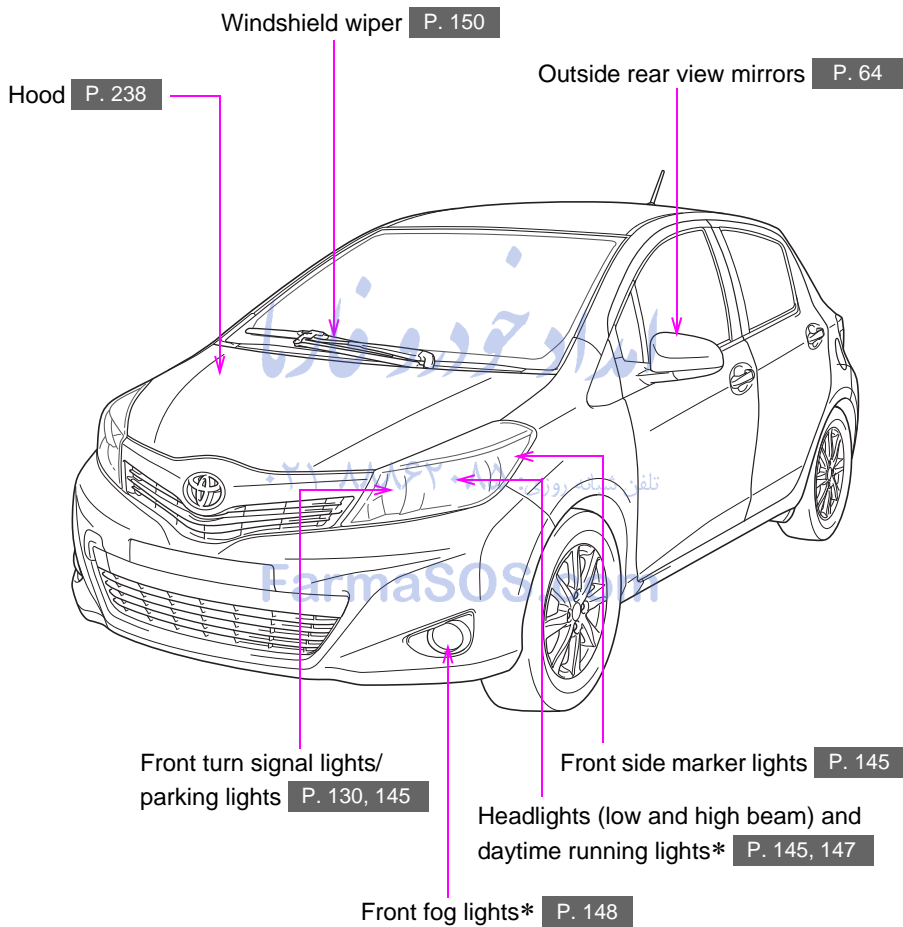



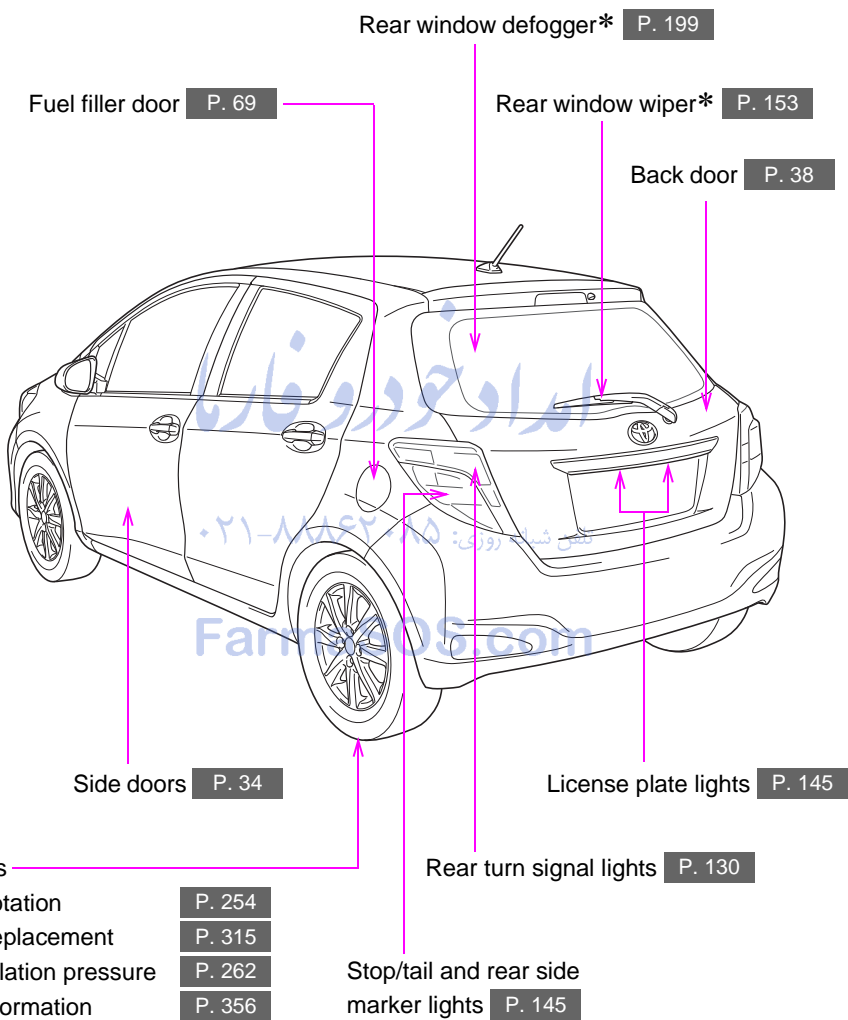

\*: If equipped

3-door models

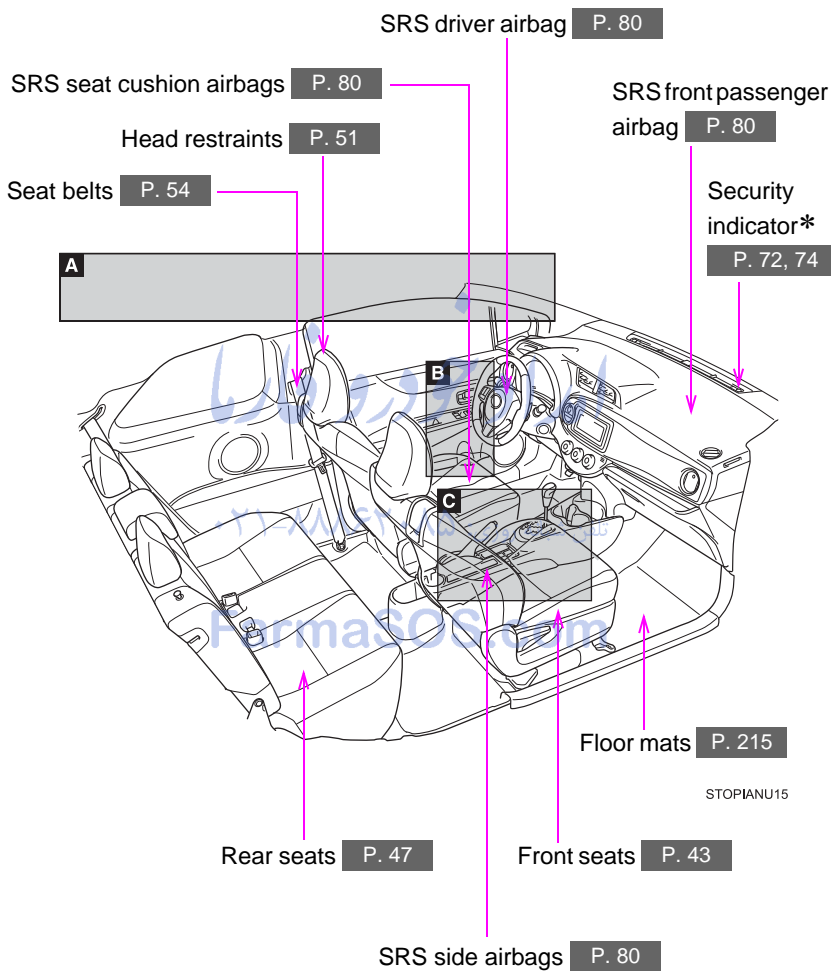

## 5-door models

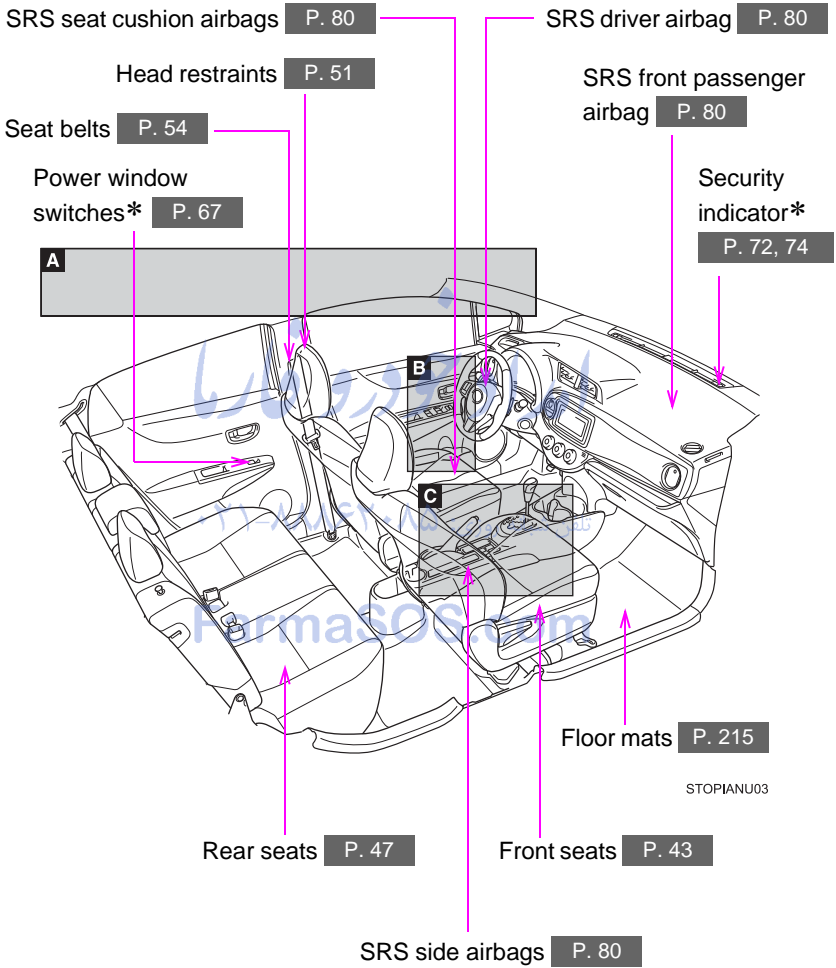

\*: If equipped

**A**

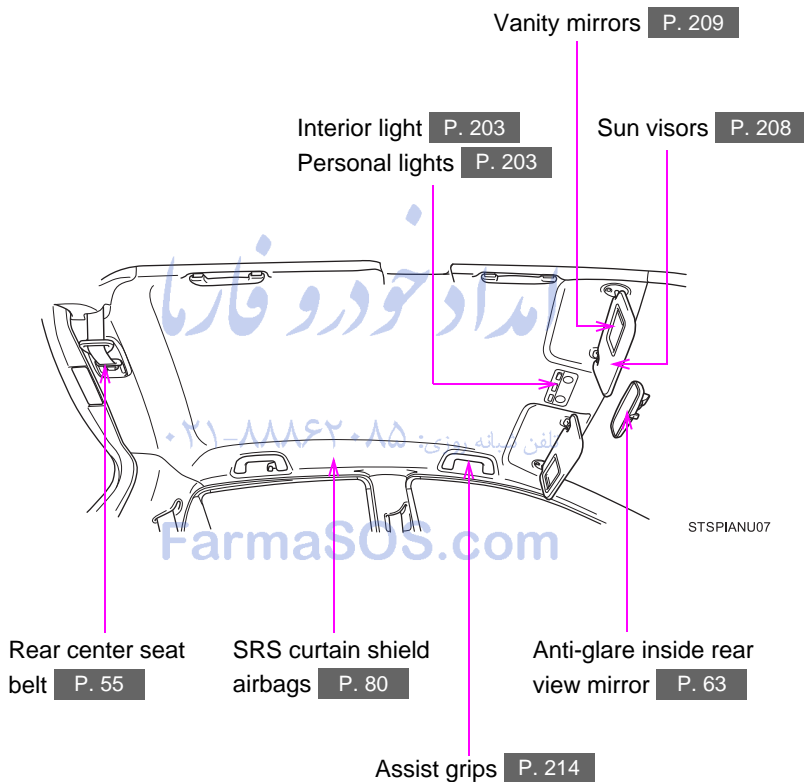

**B**

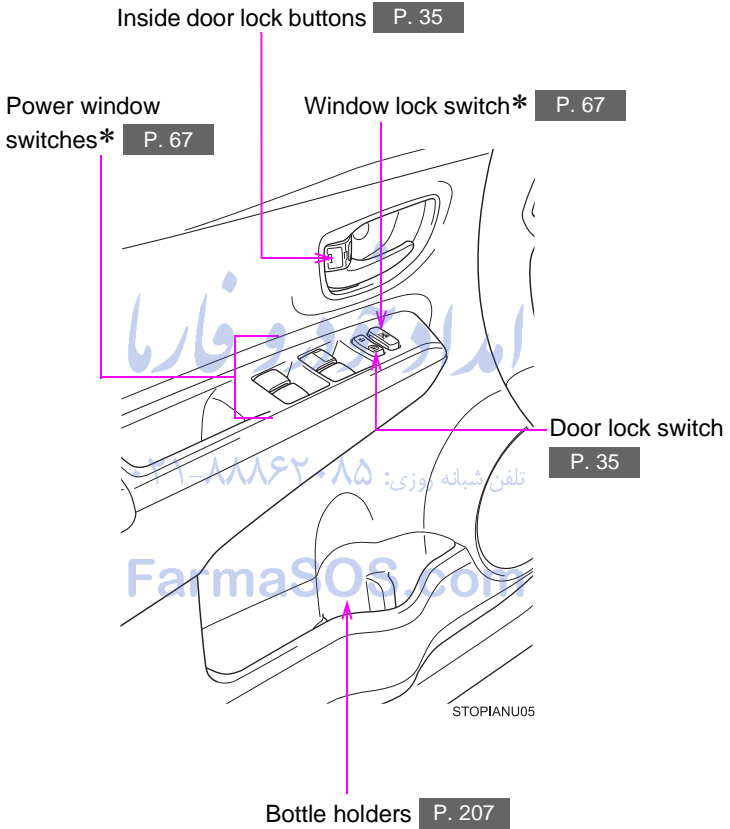

\*: If equipped

**C**

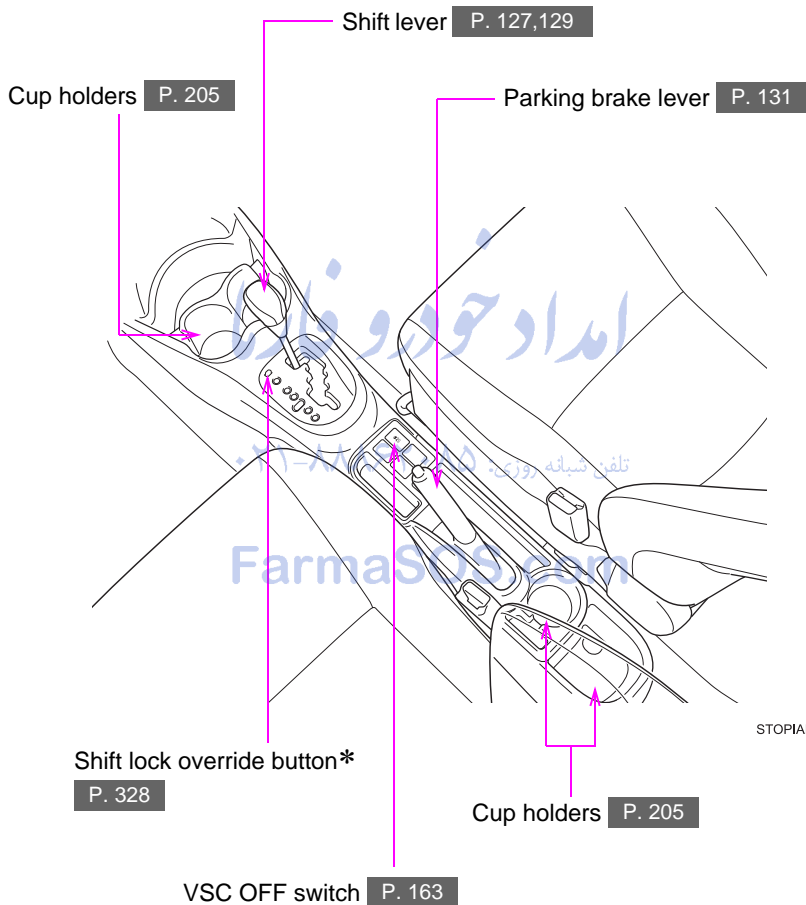

Gauges and meters P. 133

AUX port/USB port\* P. 200

Multi-information display P. 140

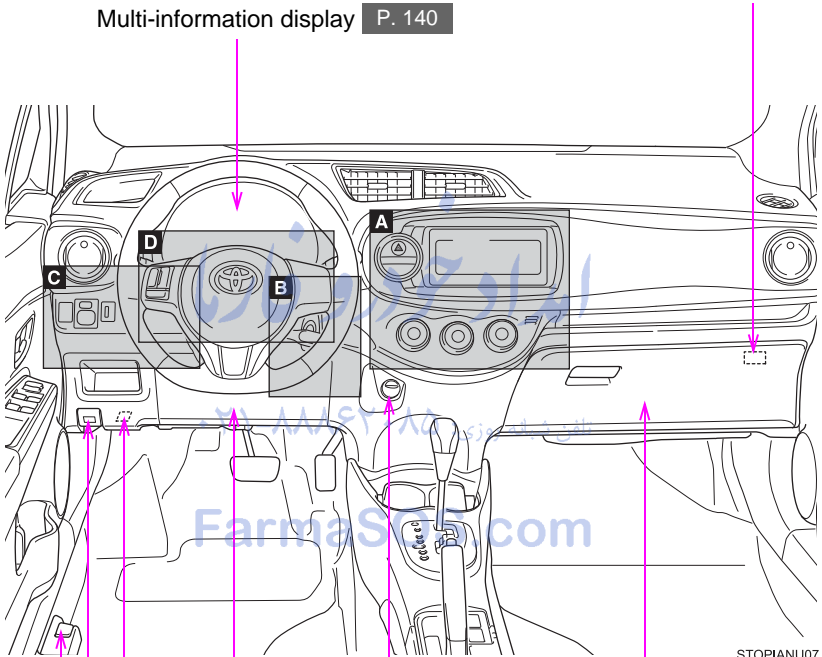

STOPIANU07

Power outlet P. 213

Glove box P. 205

SRS knee airbag P. 80

Tire pressure warning reset switch\* P. 255

Hood lock release lever P. 238

Fuel filler door opener P. 69

\*: If equipped

**A**

Front passenger "AIR BAG ON" and  
"AIR BAG OFF" indicator lights **P. 92**

Emergency flasher switch **P. 296**

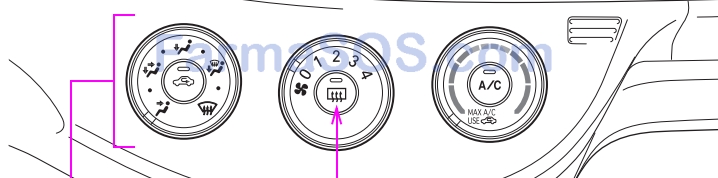
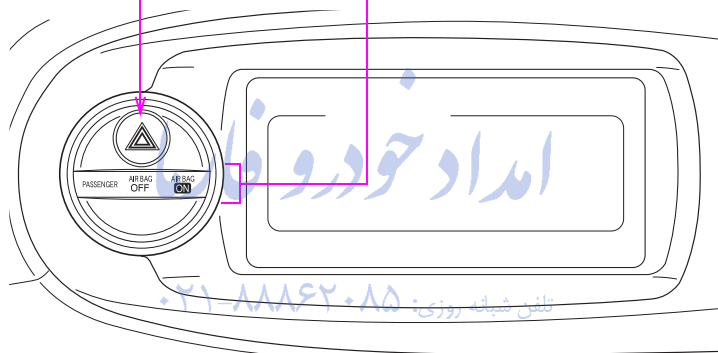

Rear window defogger switch\*/rear window and  
outside rear view mirror defoggers\* **P. 199**

Air conditioning system **P. 192**

STOPIANU08



**B**

Windshield wiper and washer switch P. 150

Rear window wiper and washer switch\* P. 153

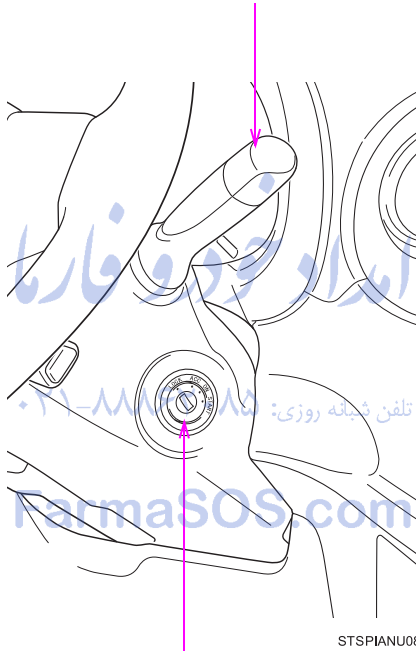

Engine (ignition) switch P. 124

\*: If equipped

**C**

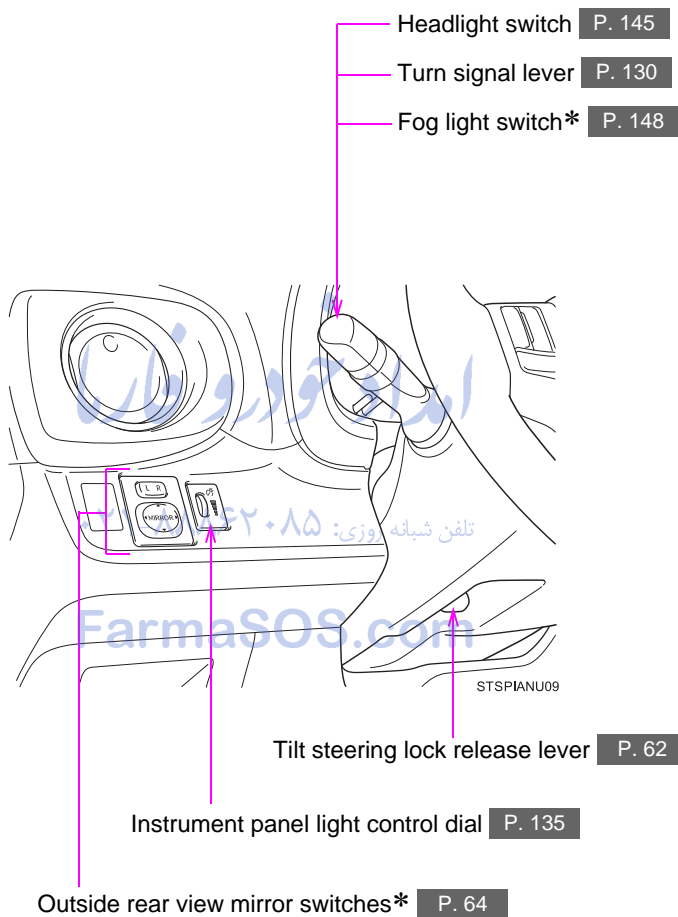

**D**

Audio switches\* P. 201

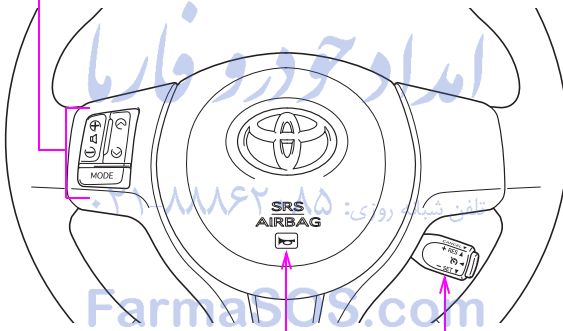

STOPIANU11

Cruise control switch\* P. 158

Horn P. 132

\*: If equipped

## For your information

### Main Owner's Manual

Please note that this manual applies to all models and all equipment, including options. Therefore, you may find some explanations for equipment not installed on your vehicle.

All specifications provided in this manual are current at the time of printing. However, because of the Toyota policy of continual product improvement, we reserve the right to make changes at any time without notice.

Depending on specifications, the vehicle shown in the illustrations may differ from your vehicle in terms of equipment.

### Noise from under vehicle after turning off the engine

Approximately five hours after the engine is turned off, you may hear a sound coming from under the vehicle for several minutes. This is the sound of a fuel evaporation leakage check and, it does not indicate a malfunction.

### Accessories, spare parts and modification of your Toyota

A wide variety of non-genuine spare parts and accessories for Toyota vehicles are currently available on the market. You should know that Toyota does not warrant these products and is not responsible for their performance, repair, or replacement, or for any damage they may cause to, or adverse effect they may have on, your Toyota vehicle.

This vehicle should not be modified with non-genuine Toyota products. Modification with non-genuine Toyota products could affect its performance, safety or durability, and may even violate governmental regulations. In addition, damage or performance problems resulting from the modification may not be covered under warranty.

## Installation of a mobile two-way radio system

The installation of a mobile two-way radio system in your vehicle could affect electronic systems such as:

- Multiport fuel injection system/sequential multiport fuel injection system
- Cruise control system
- Anti-lock brake system
- SRS airbag system
- Seat belt pretensioner system

Be sure to check with your Toyota dealer for precautionary measures or special instructions regarding installation of a mobile two-way radio system.

## Vehicle data recordings

Your Toyota is equipped with several sophisticated computers that will record certain data, such as:

- Engine speed
- Accelerator status
- Brake status
- Vehicle speed
- Shift position (except manual transmission)

The recorded data varies according to the vehicle grade level and options with which it is equipped. Furthermore, these computers do not record conversations, sounds or pictures.

### ● Data usage

Toyota may use the data recorded in these computers to diagnose malfunctions, conduct research and development, and improve quality.

Toyota will not disclose the recorded data to a third party except:

- With the consent of the vehicle owner or with the consent of the lessee if the vehicle is leased
- In response to an official request by the police, a court of law or a government agency
- For research purposes where the data is not tied to a specific vehicle or vehicle owner

## Event data recorder

This vehicle is equipped with an event data recorder (EDR). The main purpose of an EDR is to record, in certain crash or near crash-like situations, such as an air bag deployment or hitting a road obstacle, data that will assist in understanding how a vehicle's systems performed. The EDR is designed to record data related to vehicle dynamics and safety systems for a short period of time, typically 30 seconds or less.

The EDR in this vehicle is designed to record such data as:

- How various systems in your vehicle were operating;
- Whether or not the driver and passenger safety belts were buckled/fastened;
- How far (if at all) the driver was depressing the accelerator and/or brake pedal; and,
- How fast the vehicle was traveling.

These data can help provide a better understanding of the circumstances in which crashes and injuries occur.

NOTE: EDR data are recorded by your vehicle only if a nontrivial crash situation occurs; no data are recorded by the EDR under normal driving conditions and no personal data (e.g., name, gender, age, and crash location) are recorded. However, other parties, such as law enforcement, could combine the EDR data with the type of personally identifying data routinely acquired during a crash investigation.

To read data recorded by an EDR, special equipment is required, and access to the vehicle or the EDR is needed. In addition to the vehicle manufacturer, other parties, such as law enforcement, that have the special equipment, can read the information if they have access to the vehicle or the EDR.

● Disclosure of the EDR data

Toyota will not disclose the data recorded in an EDR to a third party except when:

- An agreement from the vehicle's owner (or the lessee for a leased vehicle) is obtained
- In response to an official request by the police, a court of law or a government agency
- For use by Toyota in a lawsuit

However, if necessary, Toyota may:

- Use the data for research on vehicle safety performance
- Disclose the data to a third party for research purposes without disclosing information about the specific vehicle or vehicle owner

### Scrapping of your Toyota

The SRS airbag and seat belt pretensioner devices in your Toyota contain explosive chemicals. If the vehicle is scrapped with the airbags and seat belt pretensioners left as they are, this may cause an accident such as fire. Be sure to have the systems of the SRS airbag and seat belt pretensioner removed and disposed of by a qualified service shop or by your Toyota dealer before you scrap your vehicle.

### Perchlorate Material

Special handling may apply,  
See [www.dtsc.ca.gov/hazardouswaste/perchlorate](http://www.dtsc.ca.gov/hazardouswaste/perchlorate).

Your vehicle has components that may contain perchlorate. These components may include airbag, seat belt pretensioners, and wireless remote control batteries.

 CAUTION

■ **General precautions while driving**

**Driving under the influence:** Never drive your vehicle when under the influence of alcohol or drugs that have impaired your ability to operate your vehicle. Alcohol and certain drugs delay reaction time, impair judgment and reduce coordination, which could lead to an accident that could result in death or serious injury.

**Defensive driving:** Always drive defensively. Anticipate mistakes that other drivers or pedestrians might make and be ready to avoid accidents.

**Driver distraction:** Always give your full attention to driving. Anything that distracts the driver, such as adjusting controls, talking on a cellular phone or reading can result in a collision with resulting death or serious injury to you, your occupants or others.

■ **General precaution regarding children's safety**

Never leave children unattended in the vehicle, and never allow children to have or use the key.

Children may be able to start the vehicle or shift the vehicle into neutral. There is also a danger that children may injure themselves by playing with the cigarette lighter, the windows, or other features of the vehicle. In addition, heat build-up or extremely cold temperatures inside the vehicle can be fatal to children.

FarmaSOS.com



## Symbols used throughout this manual

### Cautions & Notices

#### CAUTION

This is a warning against something which, if ignored, may cause death or serious injury to people. You are informed about what you must or must not do in order to reduce the risk of death or serious injury to yourself and others.

#### NOTICE

This is a warning against something which, if ignored, may cause damage to the vehicle or its equipment. You are informed about what you must or must not do in order to avoid or reduce the risk of damage to your Toyota and its equipment.

### Symbols used in illustrations تلفن شبانه روزی: ۰۸۵



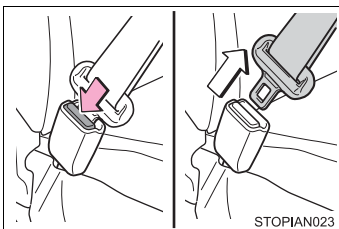

#### Safety symbol

The symbol of a circle with a slash through it means “Do not”, “Do not do this”, or “Do not let this happen”.



#### Arrows indicating operations

-  Indicates the action (pushing, turning, etc.) used to operate switches and other devices.
-  Indicates the outcome of an operation (e.g. a lid opens).

# امداد خودرو فارما

تلفن شبانه روزی: ۰۲۱-۸۸۸۶۲۰۸۵

**FarmaSOS.com**

## Before driving

# 1

### 1-1. Key information

Keys ..... 28

### 1-2. Opening, closing and locking the doors

Wireless remote control ..... 31

Side doors ..... 34

Back door ..... 38

### 1-3. Adjustable components (seats, mirrors, steering wheel)

Front seats ..... 43

Rear seats ..... 47

Head restraints ..... 51

Seat belts ..... 54

Steering wheel ..... 62

Anti-glare inside rear view mirror ..... 63

Outside rear view mirrors... 64

### 1-4. Opening and closing the windows

Power windows ..... 67

### 1-5. Refueling

Opening the fuel tank cap ..... 69

### 1-6. Theft deterrent system

Engine immobilizer system ..... 72

Alarm (Puerto Rico) ..... 74

Theft prevention labels (except Canada) ..... 77

### 1-7. Safety information

Correct driving posture ..... 78

SRS airbags ..... 80

Front passenger occupant classification system ..... 92

Child restraint systems ..... 98

Installing child restraints... 102

The following keys are provided with the vehicle.

## Vehicles without engine immobilizer system (type A)

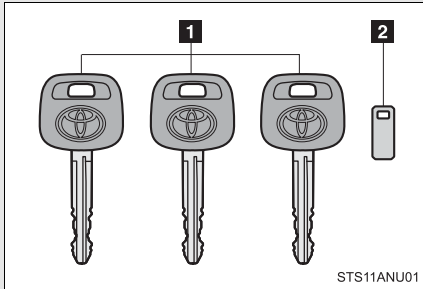

- 1** Master keys
- 2** Key number plate

## Vehicles without engine immobilizer system (type B)

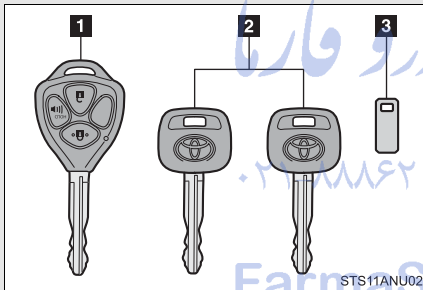

- 1** Master key (with a wireless remote control function)

Operating the wireless remote control function (→P. 31)

- 2** Master keys (without a wireless remote control function)
- 3** Key number plate

## Vehicles with engine immobilizer system (type A)

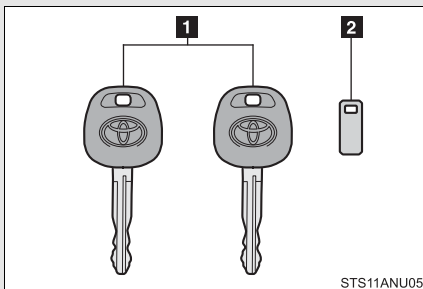

- 1** Master keys
- 2** Key number plate

### Vehicles with engine immobilizer system (type B)

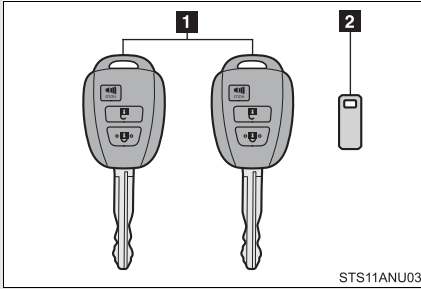

#### 1 Master keys

Operating the wireless remote control function (→P. 31)

#### 2 Key number plate

### Vehicles with engine immobilizer system (type C)

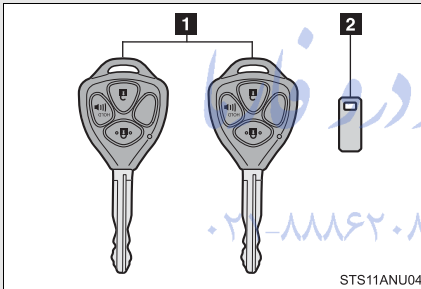

#### 1 Master keys

Operating the wireless remote control function (→P. 31)

#### 2 Key number plate

تلفن شبانه روزی: ۰۲۰-۸۸۶۲۰۸۵

FarmaSOS.com

#### ■ Key number plate

Keep the plate in a safe place such as your wallet, not in the vehicle. In the event that a key is lost, a new key can be made by your Toyota dealer using the key number plate. (→P. 329)

#### ■ When riding in an aircraft

When bringing a key with wireless remote control function onto an aircraft, make sure you do not press any buttons on the key while inside the aircraft cabin. If you are carrying the key in your bag etc, ensure that the buttons are not likely to be pressed accidentally. Pressing a button may cause the key to emit radio waves that could interfere with the operation of the aircraft.

 NOTICE

■ **To prevent key damage**

Observe the following:

- Do not subject the keys to strong shocks, expose them to high temperatures by placing them in direct sunlight, or get them wet.
- Do not expose the keys to electromagnetic materials or attach any material that blocks electromagnetic waves to the key surface.
- Do not disassemble the wireless remote control key.

امداد خودرو فارما

تلفن شبانه روزی: ۰۲۱-۸۸۶۲۰۸۵

FarmaSOS.com

## 1-2. Opening, closing and locking the doors Wireless remote control\*

The wireless remote control can be used to lock and unlock the vehicle.

### Type A

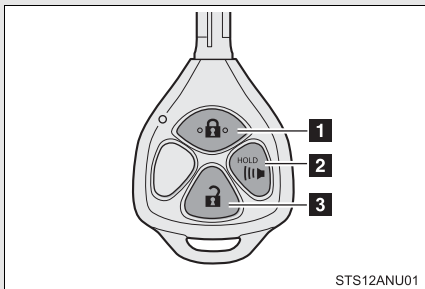

- 1 Locks all the doors
- 2 Sounds the alarm (press and hold)
- 3 Unlocks all the doors

Pressing the button unlocks the driver's door. Pressing the button again within 3 seconds unlocks the other doors.

### Type B

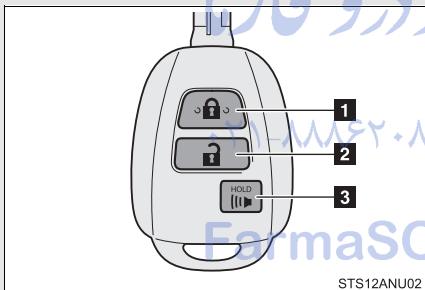

- 1 Locks all the doors
- 2 Unlocks all the doors

Pressing the button unlocks the driver's door. Pressing the button again within 3 seconds unlocks the other doors.

- 3 Sounds the alarm (press and hold)

\*: If equipped

### ■ Operation signals

The emergency flashers flash to indicate that the doors have been locked/unlocked. (Locked: once; Unlocked: twice)

### ■ Panic mode

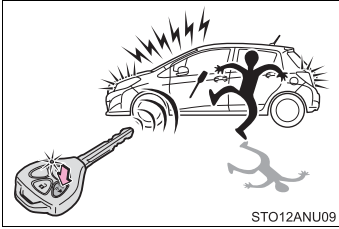

When **HOLD** (⏏) is pressed for longer than about 1 second, an alarm will sound intermittently and the vehicle lights will flash to deter any person from trying to break into or damage your vehicle.

To stop the alarm, press any button on the wireless remote control.

### ■ Security feature

If a door is not opened within approximately 60 seconds after the vehicle is unlocked, the security feature automatically locks the vehicle again.

### ■ Alarm (if equipped)

Using the wireless remote control to lock the doors will set the alarm system. (→P. 74)

### ■ Conditions affecting operation

The wireless remote control function may not operate normally in the following situations:

- When the wireless key battery is depleted
- Near a TV tower, electric power plant, gas station, radio station, large display, airport or other facility that generates strong radio waves or electrical noise
- When carrying a portable radio, cellular phone or other wireless communication device
- When the wireless key is in contact with, or is covered by a metallic object
- When another wireless key (that emits radio waves) is being used nearby
- If window tint with a metallic content or metallic objects are attached to the rear window



### ■ Key battery depletion

If the wireless remote control function does not operate, the battery may be depleted. Replace the battery when necessary. (→P. 271)

### ■ Customization that can be configured at Toyota dealer

Settings (e.g. wireless remote control system) can be changed. (Customizable features →P. 368)

### ■ Certification for wireless remote control

#### U.S.A.

FCC ID: HYQ12BBY

FCC ID: HYQ23AAA

#### NOTE:

This device complies with part 15 of the FCC Rules. Operation is subject to the following two conditions: (1) This device may not cause harmful interference, and (2) this device must accept any interference received, including interference that may cause undesired operation.

#### FCC WARNING:

Changes or modifications not expressly approved by the party responsible for compliance could void the user's authority to operate the equipment.

#### Canada

#### NOTE:

Operation is subject to the following two conditions: (1) this device may not cause interference, and (2) this device must accept any interference, including interference that may cause undesired operation of the device.

## 1-2. Opening, closing and locking the doors

### Side doors

The vehicle can be locked and unlocked using the key, wireless remote control or door lock switch.

#### ■ Wireless remote control (if equipped)

→P. 31

#### ■ Key

Turning the key operates the doors as follows:

#### Driver's door

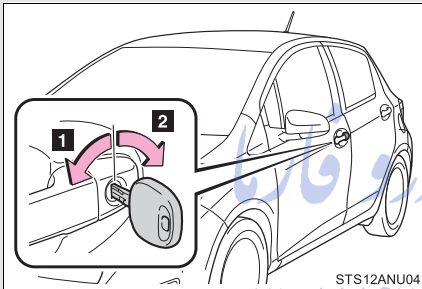

**1** Locks all the doors

**2** Unlocks all the doors

Turning the key unlocks the driver's door. Turning the key again unlocks the other doors.

#### Front passenger's door

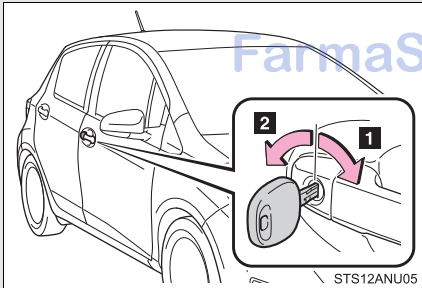

**1** Locks all the doors

**2** Unlocks all the doors

### ■ Door lock switch

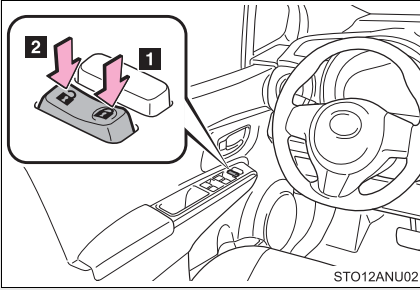

- 1 Locks all the doors
- 2 Unlocks all the doors

### ■ Inside door lock buttons

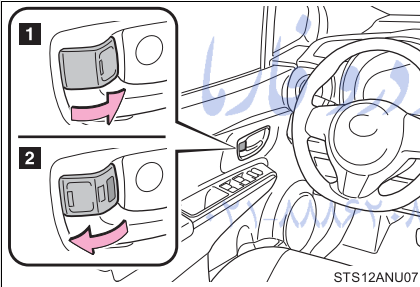

- 1 Locks the door
- 2 Unlocks the door

The front doors can be opened by pulling the inside handle even if the lock buttons are in the lock position.

تلفن شبانه روزی: ۵۵

FarmaSOS.com

### Locking the front doors from the outside without a key

**STEP 1** Move the inside door lock button to the lock position.

**STEP 2** Close the door.

The door cannot be locked if either of the front doors is open and the key is in the engine switch.

### Rear door child-protector lock (5-door models only)

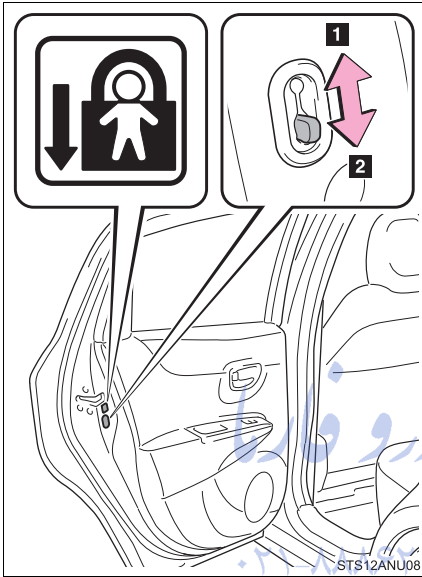

The door cannot be opened from inside the vehicle when the lock is set.

**1** Unlock

**2** Lock

These locks can be set to prevent children from opening the rear doors. Push down on each rear door switch to lock both rear doors.

#### ■ Customization that can be configured at Toyota dealer

Settings (e.g. unlocking function using a key) can be changed.  
(Customizable features →P. 368)

 CAUTION

**■ To prevent an accident**

Observe the following precautions while driving the vehicle.

Failure to do so may result in a door opening and an occupant falling out, resulting in death or serious injury.

- Always use a seat belt.
- Always lock all the doors.
- Ensure that all the doors are properly closed.
- Do not pull the inside handle of the doors while driving.

The doors may be opened and the passengers are thrown out of the vehicle and it may result in serious injury or death.

Be especially careful for the front doors, as the doors may be opened even if the inside lock buttons are in locked position.

- Set the rear door child-protector locks when children are seated in the rear seats.

تلفن شبانه روزی: ۰۲۱-۸۸۶۲۰۸۵

FarmaSOS.com

## 1-2. Opening, closing and locking the doors

### Back door

The back door can be locked/unlocked and opened by the following procedures.

#### ■ Locking and unlocking the back door

**Keys (from the back door: vehicles with a back door key cylinder)**

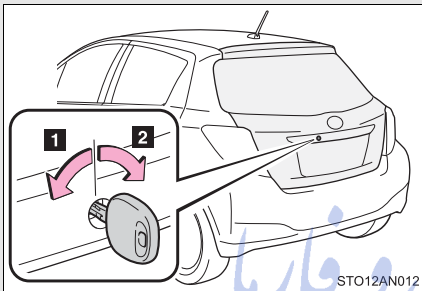

**1** Unlocks all the doors

**2** Locks all the doors

**Keys (from the front doors)**

→P. 34

**Wireless remote control (if equipped)** تلفن شبانه روزی ۰۲۱-۸۸۶۲۰۸۵

→P. 31

**Door lock switches** FarmaSOS.com

→P. 35

#### ■ Opening the back door from outside the vehicle

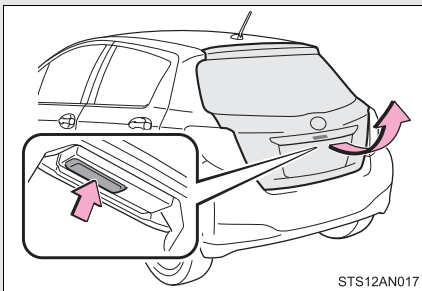

Raise the back door while pushing up the back door opener switch.

The back door cannot be closed immediately after the back door opener switch is pushed.

### ■ When closing the back door

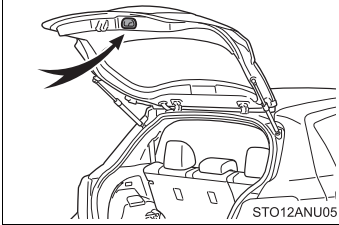

Lower the back door using the back door handle, and make sure to push the back door down from the outside to close it.

### ■ Luggage compartment light

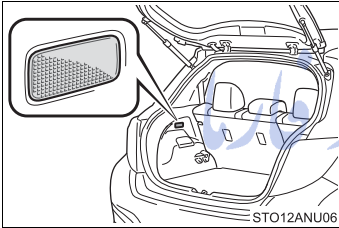

The luggage compartment light turn on when the back door is opened.

امداد خودرو اطلاعات  
تلفن شبانه روزی: ۰۲۱-۸۸۶۲۰۸۵

## ⚠ CAUTION

### ■ Caution while driving

- Keep the back door closed while driving.  
If the back door is left open, it may hit near-by objects while driving or luggage may be unexpectedly thrown out, causing an accident.  
In addition, exhaust gases may enter the vehicle, causing death or a serious health hazard. Make sure to close the back door before driving.
- Before driving the vehicle, make sure that the back door is fully closed. If the back door is not fully closed, it may open unexpectedly while driving, causing an accident.
- Never let anyone sit in the luggage compartment. In the event of sudden braking or a collision, they are susceptible to death or serious injury.

 CAUTION

■ **When children are in the vehicle**

Observe the following precautions.

Failure to do so may result in death or serious injury.

- Do not leave children alone in the luggage compartment.  
If a child is accidentally locked in the luggage compartment, they could have heat exhaustion.
- Do not allow a child to open or close the back door.  
Doing so may cause the back door to move unexpectedly, or cause the child's hands, head, or neck to be caught by the closing back door.

■ **Operating the back door**

Observe the following precautions.

Failure to do so may cause parts of the body to be caught, resulting in death or serious injury.

- Remove any heavy loads, such as snow and ice, from the back door before opening it. Failure to do so may cause the back door to suddenly shut again after it is opened.
- When opening or closing the back door, thoroughly check to make sure the surrounding area is safe.
- If anyone is in the vicinity, make sure they are safe and let them know that the back door is about to open or close.
- Use caution when opening or closing the back door in windy weather as it may move abruptly in strong wind.



**⚠ CAUTION**

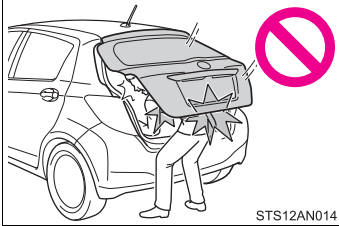

- The back door may suddenly shut if it is not opened fully. It is more difficult to open or close the back door on an incline than on a level surface, so beware of the back door unexpectedly opening or closing by itself. Make sure that the back door is fully open and secure before using the luggage compartment.

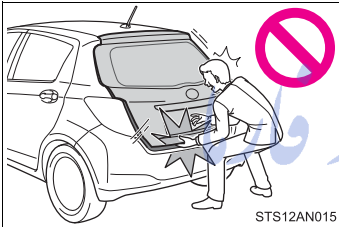

- When closing the back door, take extra care to prevent your fingers etc. from being caught.
- When closing the back door, make sure to press it lightly on its outer surface. If the back door handle is used to fully close the back door, it may result in hands or arms being caught.

- Do not pull on the back door damper stay to close the back door, and do not hang on the back door damper stay. Doing so may cause hands to be caught or the back door damper stay to break, causing an accident.
- If a bicycle carrier or similar heavy object is attached to the back door, it may suddenly shut again after being opened, causing someone's hands, head or neck to be caught and injured. When installing an accessory part to the back door, using a genuine Toyota part is recommended.

 NOTICE

■ **Back door damper stays**

The back door is equipped with damper stays that hold the back door in place.

Observe the following precautions.

Failure to do so may cause damage to the back door damper stay, resulting in malfunction.

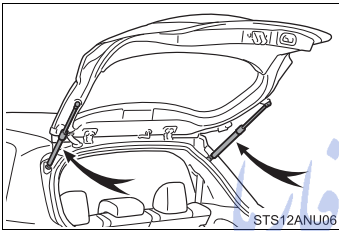

- Do not attach any foreign objects, such as stickers, plastic sheets, or adhesives to the damper stay rod.
- Do not touch the damper stay rod with gloves or other fabric items.
- Do not attach any accessories other than genuine Toyota parts to the back door.
- Do not place your hand on the damper stay or apply lateral forces to it.

FarmaSOS.com

## Front seats

### Driver's seat

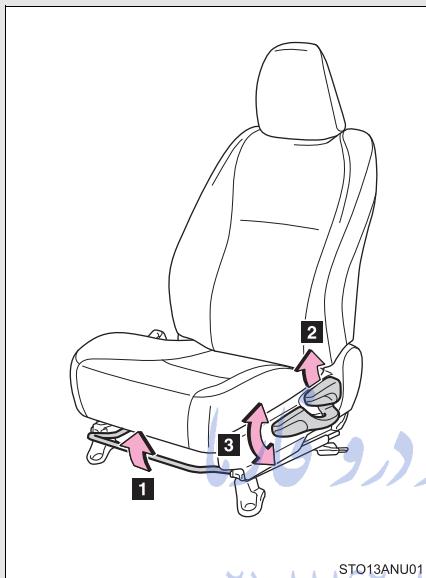

- 1** Seat position adjustment lever
- 2** Seatback angle adjustment lever
- 3** Vertical height adjustment lever (if equipped)

STO13ANU01

امداد خودرویی  
تلفن شبانه روزی: ۰۲۱-۸۸۷۶۰۸۵

FarmaSOS.com

### Front passenger's seat

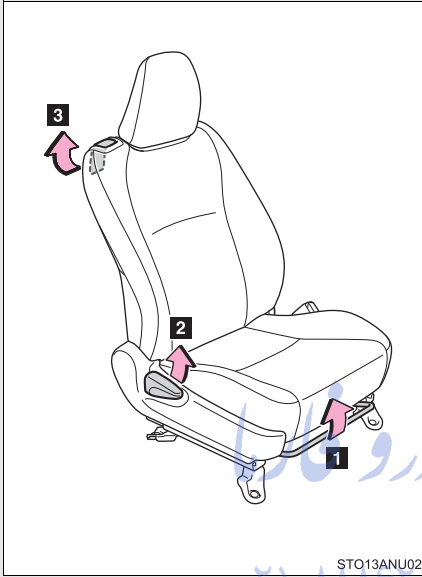

- 1 Seat position adjustment lever
- 2 Seatback angle adjustment lever
- 3 Seatback lock release lever (3-door models only)

امداد خودروکاران  
تلفن شبانه روزی: ۰۲۱-۸۸۷۶۰۸۵

FarmaSOS.com

**Moving front passenger seat for rear seat entry (3-door models only)****■ Getting in or out the vehicle**

For easy access to the rear seat, use the seatback lock release lever or seatback angle adjustment lever. When the seatback lock release lever or seatback angle adjustment lever is used, the seat's original slide position is memorized, so the seat may be returned to that original position. The seatback will be returned to the fully upright position.

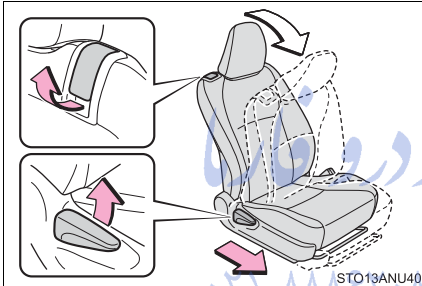

Lift the seatback lock release lever or seatback angle adjustment lever.

The seatback will fold forward, and the seat's slide lock will be released.

Move the seat all the way forward.

**■ Seat slide position memory function (3-door models only)**

Slide the seat backward and then lift the seatback. The seat will be set and locked to its previous slide position automatically, and the seatback will be returned to the fully upright position.

In the following situations, the seat slide position memory will not be saved or will be overwritten.

- The seatback is lifted upright at a slide position farther forward than the memorized position.
- The seat slide position is memorized when the seat is slid all the way or nearly all the way forward.
- The seat is slid farther back than the memorized position by using the seat position adjustment lever.

**■ If the seat cannot be returned to the memorized slide position**

Lift the seatback lock release lever or seatback angle adjustment lever after removing the luggage, or after having the passenger get out or sit properly so that the seat can be slid back to the previous position.

 CAUTION

■ **Seat adjustment**

- Be careful that the seat does not hit passengers or luggage.
- To reduce the risk of sliding under the lap belt during a collision, do not recline the seat more than necessary.

If the seat is too reclined, the lap belt may slide past the hips and apply restraint forces directly to the abdomen, or your neck may contact the shoulder belt, increasing the risk of death or serious injury in the event of an accident.

Adjustments should not be made while driving as the seat may unexpectedly move and cause the driver to lose control of the vehicle.

- After adjusting the seat, make sure that the seat is locked in position.
- Never allow anyone to touch seatback lock release levers while the vehicle is moving.
- If anyone is in the vicinity, make sure they are clear of the seat back path and let them know that the seat is about to move.

■ **After returning the seatback to the upright position**

Make sure the seatback is securely locked by pushing it forward and rearward. Failure to do so may result in death or serious injury.

 NOTICE

■ **To prevent the seat lock mechanism malfunction**

Do not use the seatback angle adjustment lever and seatback lock release lever at the same time. If they are used together, the seat lock mechanism may be damaged.

# 1-3. Adjustable components (seats, mirrors, steering wheel)

## Rear seats

The seatbacks of the rear seats can be folded down.

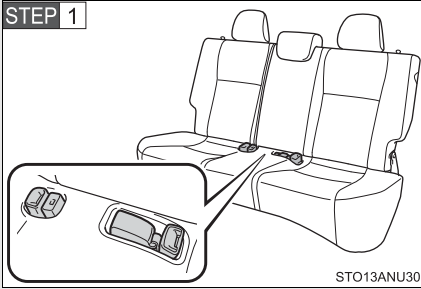

Stow the rear seat belt buckles as shown.

**STEP 2** Stow the seat belts.

**Center**

→P. 55

**Outside**

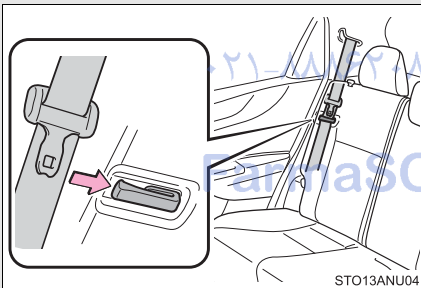

Use the seat belt hangers to prevent the belts from being tangled.

**STEP 3** Remove the outside head restraints. (→P. 51)

**Vehicles with a split rear seats**

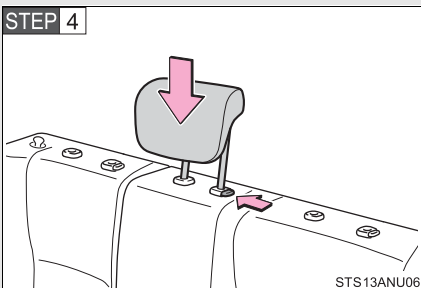

Lower the center head restraint to the lowest position.

### 1-3. Adjustable components (seats, mirrors, steering wheel)

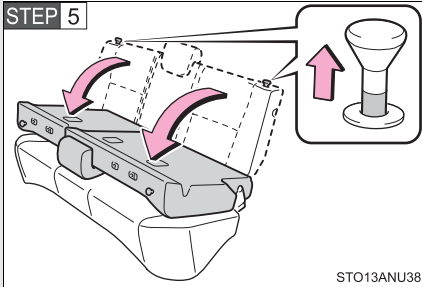

Pull the seatback lock release knob and fold the seatback down.

Each seatback may be folded separately.

#### Vehicles with a non-split rear seat

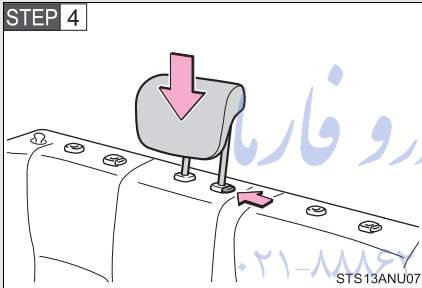

Lower the center head restraint to the lowest position.

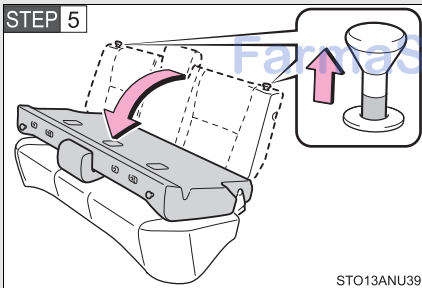

Pull both seatback lock release knobs at the same time and fold the seatback down.



**⚠ CAUTION****■ When folding the rear seatbacks down**

Observe the following precautions. Failure to do so may result in death or serious injury.

- Do not fold the seatbacks down while driving.
- Stop the vehicle on level ground, set the parking brake and shift the shift lever to P (vehicles with an automatic transmission) or N (vehicles with a manual transmission).
- Do not allow anyone to sit on a folded seatback or in the luggage compartment while driving.
- Do not allow children to enter the luggage compartment.
- For vehicles with a split rear seats, do not allow anyone sit on the rear center seat if the rear right seat is folded down, as the seat belt buckle for the rear center seat belt is then concealed under the folded seat and cannot be used.
- Be careful not to catch your hand when folding the rear seatbacks.
- If it is necessary to detach the head restraints, remove it from the vehicle or store it securely in the luggage compartment. This will prevent it from injuring passengers in the event of sudden braking, sudden swerving or an accident.
- Depending on the position of the front seat, it may interfere when trying to fold down the rear seatbacks. If this happens, adjust the position of the front seat.

**⚠ CAUTION**

■ **After returning the rear seatback to the upright position**

Observe the following precautions. Failure to do so may result in death or serious injury.

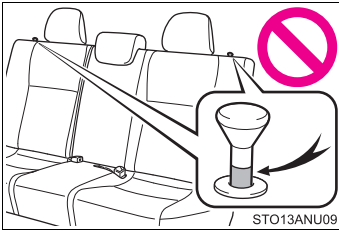

- Make sure that the seatback is securely locked in position by lightly pushing it back and forth.  
If the seatback is not securely locked, the red marking will be visible on the seatback lock release knob. Make sure that the red marking is not visible.

- Check that the seat belts are not twisted or caught in the seatback.

**⚠ NOTICE**

■ **Stowing the seat belts**

The seat belts and the buckles must be stowed before you fold down the rear seatbacks.

FarmaSOS.com

# 1-3. Adjustable components (seats, mirrors, steering wheel)

## Head restraints

Head restraints are provided for all seats.

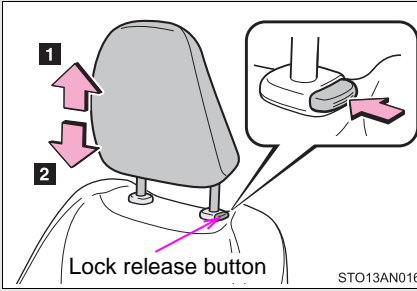

### 1 Up

Pull the head restraint up.

### 2 Down

Push the head restraint down while pushing the lock release button.

1

Before driving

## ■ Removing the head restraints

### Front and rear center head restraints

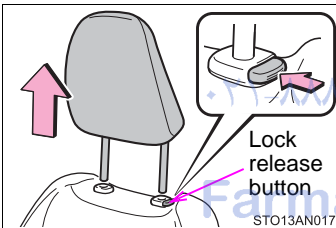

Pull the head restraint up while pressing the lock release button.

### Rear outside head restraints

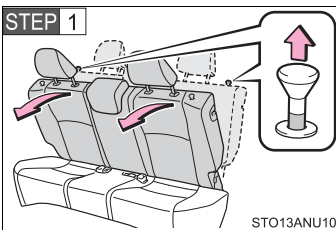

Pull the lock release knob and fold down the seatback until it reaches the position where the head restraints can be removed.

## 1-3. Adjustable components (seats, mirrors, steering wheel)

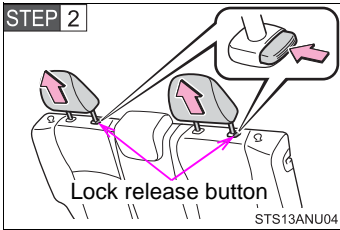

Pull the head restraint up while pressing the lock release button.

### ■ Installing the head restraints

#### Front and rear center head restraints

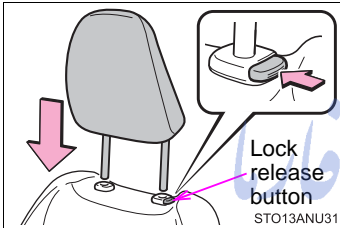

Align the head restraint with installation holes and push it down to the lock position.

Press and hold the lock release button when lowering the head restraint.

#### Rear outside head restraints

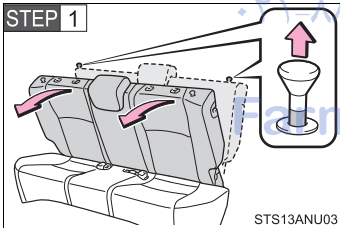

Pull the lock release knob and fold down the seatback until it reaches the position where the head restraints can be installed.

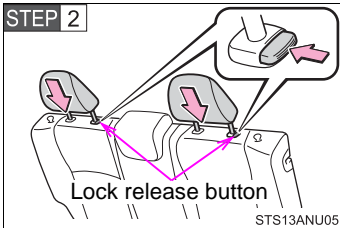

Align the head restraint with installation holes and push it down to the lock position.

Press and hold the lock release button when lowering the head restraint.

### ■ Adjusting the height of the head restraints

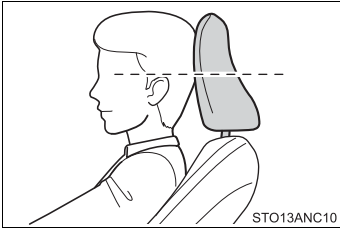

Make sure that the head restraints are adjusted so that the center of the head restraint is closest to the top of your ears.

### ■ Adjusting the rear center seat head restraint

Always raise the head restraint one level from the stowed position when using.

#### ▲ CAUTION

#### ■ Head restraint precautions

Observe the following precautions regarding the head restraints. Failure to do so may result in death or serious injury.

- Use the head restraints designed for each respective seat.
- Adjust the head restraints to the correct position at all times.
- After adjusting the head restraints, push down on them and make sure they are locked in position.
- Do not drive with the head restraints removed.

## 1-3. Adjustable components (seats, mirrors, steering wheel)

### Seat belts

**Make sure that all occupants are wearing their seat belts before driving the vehicle.**

#### ■ Correct use of the seat belts

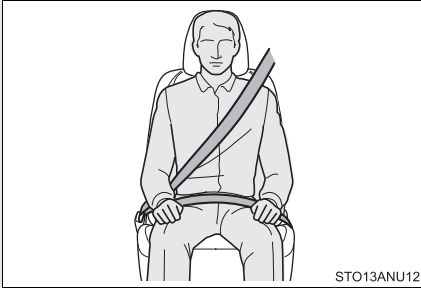

- Extend the shoulder belt so that it comes fully over the shoulder, but does not come into contact with the neck or slide off the shoulder.
- Position the lap belt as low as possible over the hips.
- Adjust the position of the seatback. Sit up straight and well back in the seat.
- Do not twist the seat belt.

#### ■ Fastening and releasing the seat belt

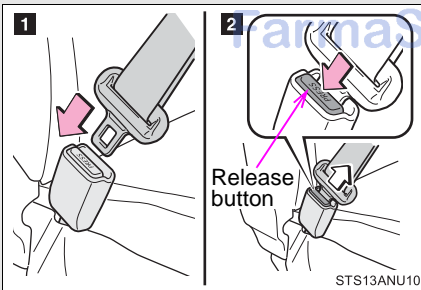

- 1 To fasten the seat belt, push the plate into the buckle until a click sound is heard.
- 2 To release the seat belt, press the release button.

**Rear center seat belt**

The rear center seat belt is a 3-point type restraint with 2 buckles. Both seat belt buckles must be correctly located and securely latched for proper operation.

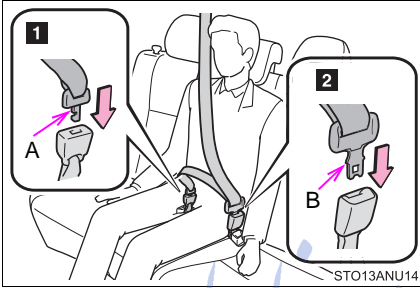

Make sure that the buckle **1** is securely latched ready for use of the center seat belt.

- 1** Matches the tab with hooked end (tab "A")
- 2** Matches the tab with concave end (tab "B")

**Release method**

The rear center seat belt can be completely released only when necessary such as when folding down the rear seat.

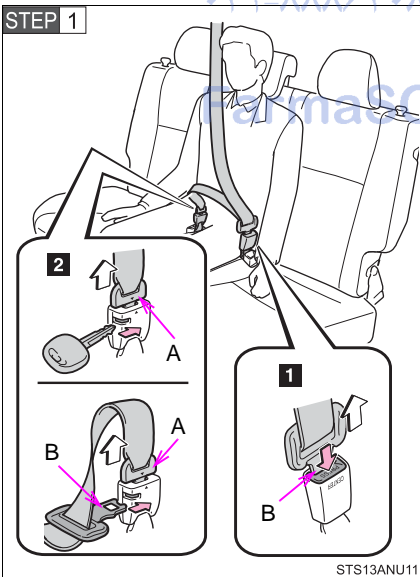

- 1** To release the tab "B", press the release button.
- 2** To release the tab "A", insert the key or tab "B" into the hole on the buckle.

Retract the belt slowly when releasing and stowing the seat belt.

### 1-3. Adjustable components (seats, mirrors, steering wheel)

**STEP 2**

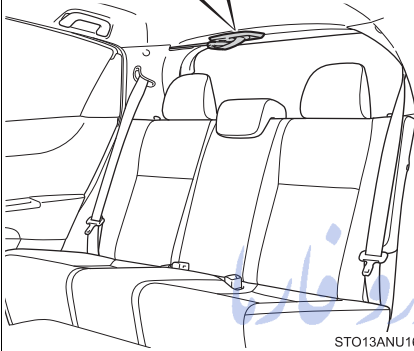
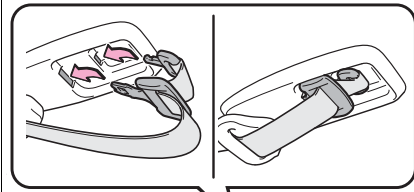

Stow the seat belt tabs in the cover set in the roof as shown.

#### ■ Extracting the belt

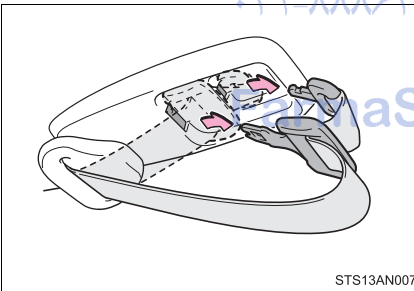

Remove the tabs from the cover.



## Seat belt pretensioners (front seats)

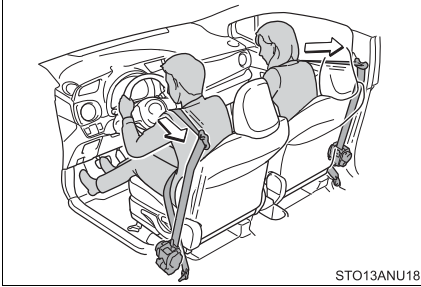

The pretensioner helps the seat belt to quickly restrain the occupant by retracting the seat belt when the vehicle is subjected to certain types of severe frontal or side collision.

The pretensioner does not activate in the event of a minor frontal impact, a minor side impact, a rear impact or a vehicle rollover.

1

Before driving

### ■ Emergency locking retractor (ELR)

The retractor will lock the belt during a sudden stop or on impact. It may also lock if you lean forward too quickly. A slow, easy motion will allow the belt to extend so that you can move around fully.

### ■ Automatic locking retractor (ALR)

When a passenger's shoulder belt is completely extended and then retracted even slightly, the belt is locked in that position and cannot be extended. This feature is to hold the child restraint system (CRS) firmly. To free the belt again, fully retract the belt and then pull the belt out once more. (→P. 102)

### ■ Pregnant women

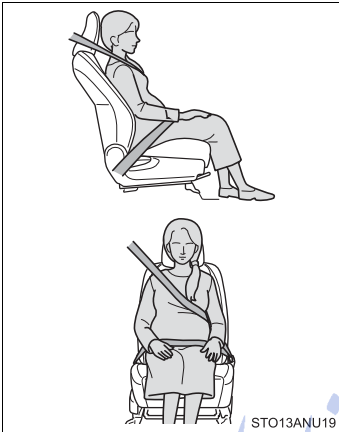

Obtain medical advice and wear the seat belt in the proper way. (→P. 54)

Women who are pregnant should position the lap belt as low as possible over the hips in the same manner as other occupants. Extend the shoulder belt completely over the shoulder and position the belt across the chest. Avoid belt contact over the rounding of the abdominal area.

If the seat belt is not worn properly, not only a pregnant woman, but also the fetus could suffer death or serious injury as a result of sudden braking or a collision.

### ■ People suffering illness

Obtain medical advice and wear the seat belt in the proper way. (→P. 54)

### ■ Child seat belt usage

The seat belts of your vehicle were principally designed for persons of adult size.

- Use a child restraint system appropriate for the child, until the child becomes large enough to properly wear the vehicle's seat belt. (→P. 98)
- When the child becomes large enough to properly wear the vehicle's seat belt, follow the instructions on P. 54 regarding seat belt usage.

### ■ Replacing the belt after the pretensioner has been activated

If the vehicle is involved in multiple collisions, the pretensioner will activate for the first collision, but will not activate for the second or subsequent collisions.

### ■ Seat belt extender

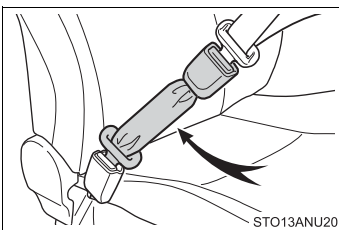

If your seat belts cannot be fastened securely because they are not long enough, a personalized seat belt extender is available from your Toyota dealer free of charge.

**⚠ CAUTION**

Observe the following precautions to reduce the risk of injury in the event of sudden braking, sudden swerving or an accident. Failure to do so may cause death or serious injury.

**■ Wearing a seat belt**

- Ensure that all passengers wear a seat belt.
- Always wear a seat belt properly.
- Each seat belt should be used by one person only. Do not use a seat belt for more than one person at once, including children.
- Toyota recommends that children be seated in the rear seat and always use a seat belt and/or an appropriate child restraint system.
- To achieve a proper seating position, do not recline the seat more than necessary. The seat belt is most effective when the occupants are sitting up straight and well back in the seats.
- Do not wear the shoulder belt under your arm.
- Always wear your seat belt low and snug across your hips.

**■ When children are in the vehicle**

Do not allow children to play with the seat belt. If the seat belt becomes twisted around a child's neck, it may lead to choking or other serious injuries that could result in death.

If this occurs and the buckle cannot be unfastened, scissors should be used to cut the belt.

**■ Seat belt pretensioners**

- Do not place anything, such as a cushion, on the front passenger's seat. Doing so will disperse the passenger's weight, which prevents the sensor from detecting the passenger's weight properly. As a result, the seat belt pretensioner for the front passenger's seat may not activate in the event of a collision.
- If the pretensioner has activated, the SRS warning light will come on. In that case, the seat belt cannot be used again and must be replaced at your Toyota dealer.

**CAUTION**

**Seat belt damage and wear**

- Do not damage the seat belts by allowing the belt, plate, or buckle to be jammed in the door.
- Inspect the seat belt system periodically. Check for cuts, fraying, and loose parts. Do not use a damaged seat belt until it is replaced. Damaged seat belts cannot protect an occupant from death or serious injury.
- Ensure that the belt and plate are locked and the belt is not twisted. If the seat belt does not function correctly, immediately contact your Toyota dealer.
- Replace the seat assembly, including the belts, if your vehicle has been involved in a serious accident, even if there's no obvious damage.
- Do not attempt to install, remove, modify, disassemble or dispose of the seat belts. Have any necessary repairs carried out by your Toyota dealer. Inappropriate handling of the pretensioner may prevent it from operating properly, resulting in death or serious injury.

**When using the rear center seat belt**

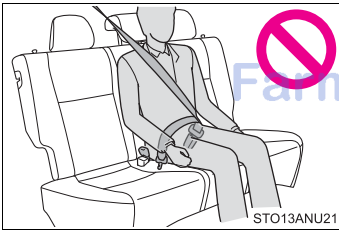

- Do not use the rear center seat belt with either buckle released.

Fastening only one of the buckles may result in death or serious injury in case of sudden braking or a collision.

- Do not allow anyone to sit on the rear center seat if the rear right seat is folded down, as the seat belt buckle for the rear center seat belt is then concealed under the folded seat and cannot be used.

 CAUTION

■ **Using a seat belt extender**

- Do not wear the seat belt extender if you can fasten the seat belt without the extender.
- Do not use the seat belt extender when installing a child restraint system because the belt will not securely hold the child restraint system, increasing the risk of death or serious injury in the event of an accident.
- The personalized extender may not be safe on another vehicle, when used by another person, or at a different seating position other than the one originally intended.

 NOTICE

■ **When using a seat belt extender**

When releasing the seat belt, press on the buckle release button on the extender, not on the seat belt.

This helps prevent damage to the vehicle interior and the extender itself.

FarmaSOS.com

## 1-3. Adjustable components (seats, mirrors, steering wheel)

### Steering wheel

The steering wheel can be adjusted to a comfortable position.

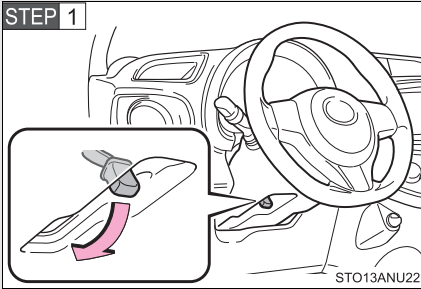

Hold the steering wheel and push the lever down.

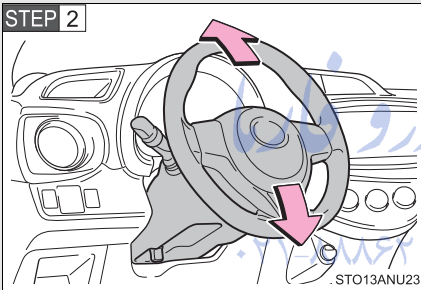

Adjust to the ideal position by moving the steering wheel.

After adjustment, pull the lever up to secure the steering wheel.

تلفن شبانه روزی: ۰۲۱۷۷۷۷۷۷۷۷ +۸۵

FarmaSOS.com

#### **⚠ CAUTION**

##### **■ Caution while driving**

Do not adjust the steering wheel while driving.

Doing so may cause the driver to mishandle the vehicle and cause an accident, resulting in death or serious injury.

##### **■ After adjusting the steering wheel**

Make sure that the steering wheel is securely locked.

Otherwise, the steering wheel may move suddenly, possibly causing an accident, and resulting in death or serious injury.

# 1-3. Adjustable components (seats, mirrors, steering wheel) Anti-glare inside rear view mirror

1  
Before driving

Glare from the headlights of vehicles behind can be reduced by using the following functions:

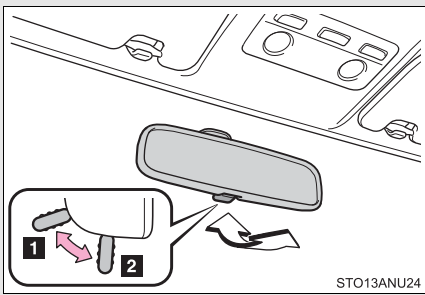

- 1 Normal position
- 2 Anti-glare position

## Adjusting the height of rear view mirror

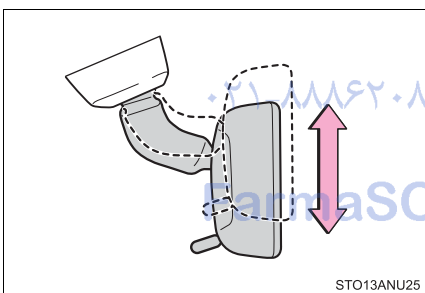

Adjust the height of the rear view mirror by moving it up and down.

### ⚠ CAUTION

#### ■ Caution while driving

Do not adjust the position of the mirror while driving. Doing so may lead to mishandling of the vehicle and cause an accident, resulting in death or serious injury.

# 1-3. Adjustable components (seats, mirrors, steering wheel)

## Outside rear view mirrors

Mirror angle can be adjusted.

### Vehicles with a manually adjustable type

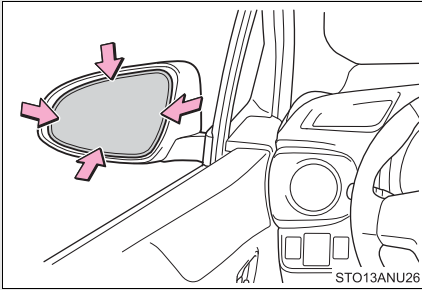

Adjust the mirror up, down, in or out by pushing the mirror surface.

### Vehicles with a power-adjustable type

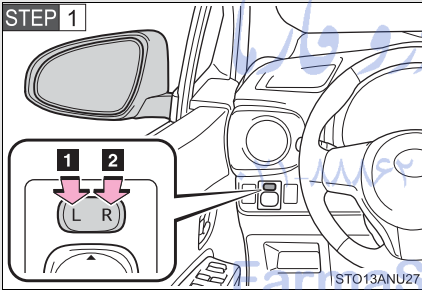

To select a mirror to adjust, press the switch.

- 1 Left
- 2 Right

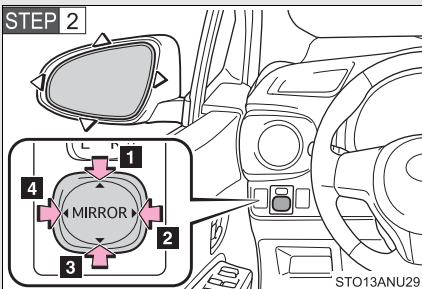

To adjust the mirror, press the switch.

- 1 Up
- 2 Right
- 3 Down
- 4 Left



## Folding the mirrors

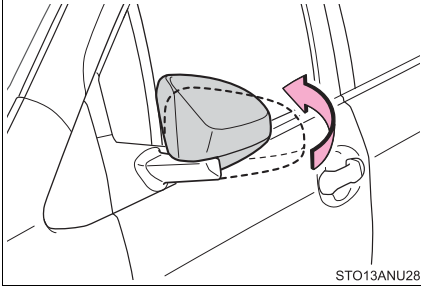

Push the mirror back in the direction of the vehicle's rear.

1

Before driving

- **Mirror angle can be adjusted when (vehicles with a power-adjustable type)**

The engine switch is in the "ACC" or "ON" position.

- **When the mirrors are fogged up (vehicles with an outside rear view mirror defoggers)**

Turn on the mirror defoggers to defog the mirrors. (→P. 199)

FarmaSOS.com

 CAUTION

■ **When driving the vehicle**

Observe the following precautions while driving.

Failure to do so may result in loss of control of the vehicle and cause an accident, resulting in death or serious injury.

- Do not adjust the mirrors while driving.
- Do not drive with the mirrors folded.
- Both the driver and passenger side mirrors must be extended and properly adjusted before driving.

■ **When a mirror is moving (vehicles with a power-adjustable type)**

To avoid personal injury and mirror malfunction, be careful not to get your hand caught by the moving mirror.

■ **When the mirror defoggers are operating (vehicles with an outside rear view mirror defoggers)**

Do not touch the rear view mirror surfaces, as they can become very hot and burn you.

تلفن شماره یوزن: ۰۲۱-۸۸۶۲۰۸۵

FarmaSOS.com

## 1-4. Opening and closing the windows Power windows\*

The power windows can be opened and closed using the switches.

Operating the switch moves the windows as follows:

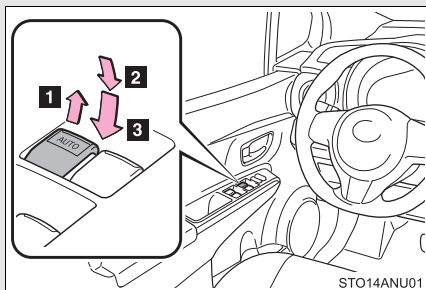

- 1 Closing
- 2 Opening
- 3 One-touch opening (driver's window only)\*

\*: To stop the window partway, operate the switch in the opposite direction.

### Window lock switch

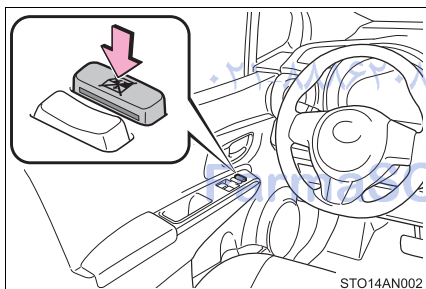

Press the switch down to lock the passenger window switches.

Use this switch to prevent children from accidentally opening or closing a passenger window.

#### ■ The power windows can be operated when

The engine switch is in the "ON" position.

#### ■ Operating the power windows after turning the engine off

The power windows can be operated for approximately 45 seconds even after the engine switch is turned to the "ACC" or "LOCK" position. They cannot, however, be operated once either front door is opened.

\*: If equipped

 CAUTION

■ **Closing the windows**

Observe the following precautions.

Failure to do so may result in death or serious injury.

- Check to make sure that all passengers do not have any part of their body in a position where it could be caught when a window is being operated.
- Do not allow children to operate the power windows.  
Closing a power window on someone can cause serious injury, and in some instances, even death.

امداد خودرو فارما

تلفن شبانه روزی: ۰۲۱-۸۸۸۶۲۰۸۵

FarmaSOS.com

## Opening the fuel tank cap

Perform the following steps to open the fuel tank cap:

### ■ Before refueling the vehicle

Turn the engine switch off and ensure that all the doors and windows are closed.

### ■ Opening the fuel tank cap

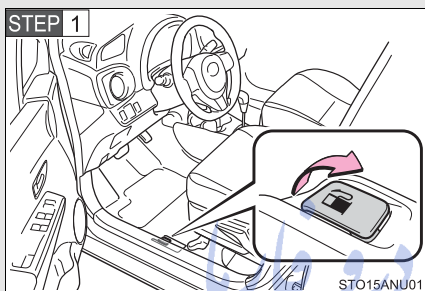

Pull up the opener to open the fuel filler door.

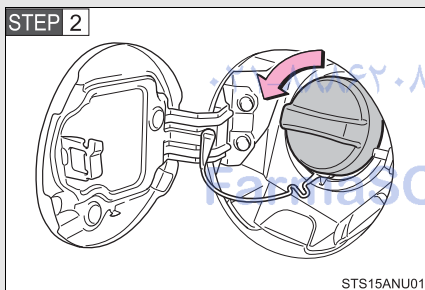

Turn the fuel tank cap slowly to open.

## Closing the fuel tank cap

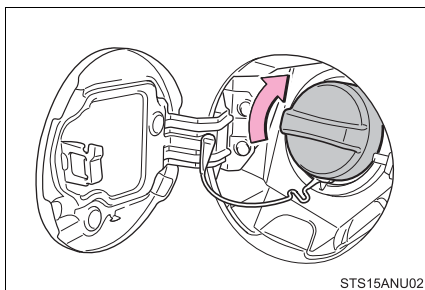

After refueling, turn the fuel tank cap until you hear a click. Once the cap is released, it will turn slightly in the opposite direction.

### ■ Fuel types

Unleaded gasoline. (Octane rating 87 [Research Octane Number 91] or higher)

### ■ Fuel tank capacity

Approximately 11.1 gal. (42 L, 9.2 Imp.gal.)

## ⚠ CAUTION

### ■ When refueling the vehicle

Observe the following precautions while refueling the vehicle.

Failure to do so may result in death or serious injury.

- After exiting the vehicle and before opening the fuel door, touch an unpainted metal surface to discharge any static electricity. It is important to discharge static electricity before refueling because sparks resulting from static electricity can cause fuel vapors to ignite while refueling.
- Always hold the grips on the fuel tank cap and turn it slowly to remove it. A whooshing sound may be heard when the fuel tank cap is loosened. Wait until the sound cannot be heard before fully removing the cap. In hot weather, pressurized fuel may spray out the filler neck and cause injury.
- Do not allow anyone that has not discharged static electricity from their body to come close to an open fuel tank.
- Do not inhale vaporized fuel. Fuel contains substances that are harmful if inhaled.
- Do not smoke while refueling the vehicle. Doing so may cause the fuel to ignite and cause a fire.
- Do not return to the vehicle or touch any person or object that is statically charged. This may cause static electricity to build up, resulting in a possible ignition hazard.

**⚠ CAUTION****■ When refueling**

Securely insert the fuel nozzle into the fuel filler neck. If fuel is added with the nozzle slightly lifted away from the fuel filler neck, the automatic shut off function may not operate, resulting in fuel overflowing from the tank.

**■ When replacing the fuel cap**

Do not use anything but a genuine Toyota fuel tank cap designed for your vehicle. Doing so may cause a fire or other incident which may result in death or serious injury.

**⚠ NOTICE****■ Refueling**

Do not spill fuel during refueling.

Doing so may damage the vehicle, such as causing the emission control system to operate abnormally or damaging fuel system components or the vehicle's painted surface.

امداد خودرو فارما

تلفن شبانه روزی: ۰۸۵ ۸۸۶۲۰۸۵

FarmaSOS.com

## 1-6. Theft deterrent system Engine immobilizer system\*

The vehicle's keys have built-in transponder chips that prevent the engine from starting if a key has not been previously registered in the vehicle's on-board computer.

**Never leave the keys inside the vehicle when you leave the vehicle.**

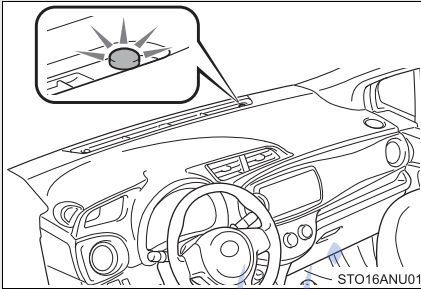

The indicator light flashes after the key has been removed from the engine switch to indicate that the system is operating.

The indicator light stops flashing after the registered key has been inserted into the engine switch to indicate that the system has been canceled.

تلفن شبانه روزی: ۰۲۱-۸۸۶۲۰۸۵

### ■ System maintenance

The vehicle has a maintenance-free type engine immobilizer system.

### ■ Conditions that may cause the system to malfunction

- If the grip portion of the key is in contact with a metallic object
- If the key is in close proximity to or touching a key to the security system (key with a built-in transponder chip) of another vehicle

\*: If equipped



## ■ Certifications for the engine immobilizer system

### U.S.A.

FCC ID: MOZRI-20BTY

FCC ID: MOZRI-33BTY

This device complies with part 15 of the FCC Rules. Operation is subject to the following two conditions: (1) This device may not cause harmful interference, and (2) this device must accept any interference received, including interference that may cause undesired operation.

### FCC WARNING:

Changes or modifications not expressly approved by the party responsible for compliance could void the user's authority to operate the equipment.

### Canada

Operation is subject to the following two conditions: (1) this device may not cause interference, and (2) this device must accept any interference, including interference that may cause undesired operation of the device.

## CAUTION

### ■ Certifications for the immobilizer system

Changes or modifications not expressly approved by the party responsible for compliance could void the user's authority to operate the equipment.

## NOTICE

### ■ To ensure the system operates correctly

Do not modify or remove the system. If modified or removed, the proper operation of the system cannot be guaranteed.

## 1-6. Theft deterrent system Alarm (Puerto Rico)

The system sounds the alarm and flashes the lights when forced entry is detected.

### ■ Triggering of the alarm

The alarm is triggered in the following situations when the alarm is set:

- A locked door is unlocked or opened in any way other than using a key or wireless remote control. (The doors will lock again automatically.)
- The hood is opened.
- The battery is reconnected.

### ■ Setting the alarm system

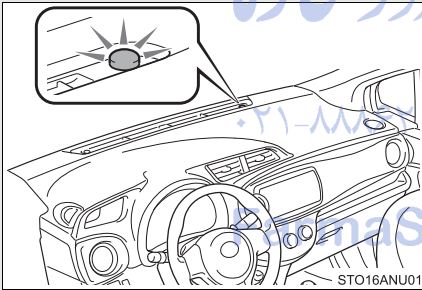

Close the doors and hood, and lock all the doors. The system will be set automatically after 30 seconds.

The indicator light changes from being on to flashing when the system is set.

### ■ Deactivating or stopping the alarm

Do one of the following to deactivate or stop the alarm:

- Unlock the doors.
- Turn the engine switch to the “ACC” or “ON” position, or start the engine. (The alarm will be deactivated or stopped after a few seconds.)

### ■ System maintenance

The vehicle has a maintenance-free type alarm system.

### ■ Items to check before locking the vehicle

To prevent unexpected triggering of the alarm and vehicle theft, make sure of the following:

- Nobody is in the vehicle.
- The windows are closed before the alarm is set.
- No valuables or other personal items are left in the vehicle.

### ■ Triggering of the alarm

The alarm may be triggered in the following situations:  
(Stopping the alarm deactivates the alarm system.)

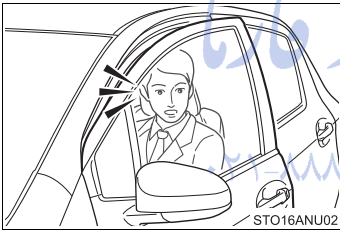

- A person inside the vehicle opens a door or hood.

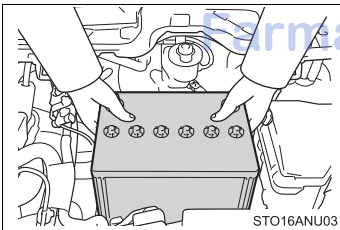

- The battery is recharged or replaced when the vehicle is locked.

### ■ When the battery is disconnected

Be sure to cancel the alarm system.

If the battery is disconnected before canceling the alarm, the system may be triggered when the battery is reconnected.

■ **Alarm-operated door lock**

- When the alarm is operating, the doors are locked automatically to prevent intruders.
- Do not leave the key inside the vehicle when the alarm is operating, and make sure the key is not inside the vehicle when recharging or replacing the battery.



**NOTICE**

■ **To ensure the system operates correctly**

Do not modify or remove the system. If modified or removed, the proper operation of the system cannot be guaranteed.

امداد خودرو فارما

تلفن شبانه روزی: ۰۲۱-۸۸۶۲۰۸۵

FarmaSOS.com

## 1-6. Theft deterrent system

### Theft prevention labels (except Canada)

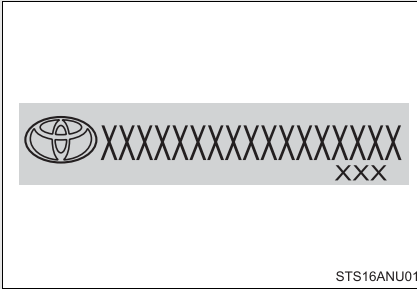

These labels are attached to the vehicle to reduce vehicle theft by facilitating the tracing and recovery of parts from stolen vehicles. Do not remove under penalty of law.

1

Before driving

# امداد خودرو فارما

تلفن شبانه روزی: ۰۲۱-۸۸۶۲۰۸۵

[FarmaSOS.com](http://FarmaSOS.com)

## Correct driving posture

Drive with a good posture as follows:

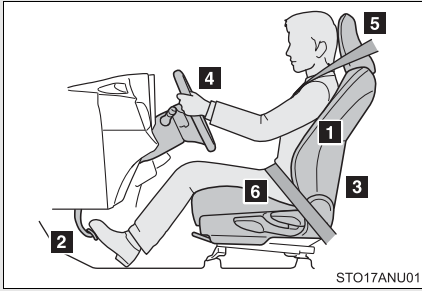

- 1** Sit upright and well back in the seat. (→P. 43)
- 2** Adjust the position of the seat forward or backward to ensure the pedals can be reached and easily depressed to the extent required. (→P. 43)
- 3** Adjust the seatback so that the controls are easily operable. (→P. 43)
- 4** Adjust the tilt positions of the steering wheel downward so the airbag is facing your chest. (→P. 62)
- 5** Lock the head restraint in place with the center of the head restraint closest to the top of your ears. (→P. 51)
- 6** Wear the seat belt correctly. (→P. 54)

 CAUTION

**■ While driving**

- Do not adjust the position of the driver's seat.  
Doing so could cause the driver to lose control of the vehicle.
- Do not place a cushion between the driver or passenger and the seatback.  
A cushion may prevent correct posture from being achieved, and reduce the effectiveness of the seat belt and head restraint, increasing the risk of death or serious injury to the driver or passenger.
- Do not place anything under the front seats.  
Objects placed under the front seats may become jammed in the seat tracks and stop the seat from locking in place. This may lead to an accident, resulting in death or serious injury. The adjustment mechanism may also be damaged.

**■ Adjusting the seat position**

- Take care when adjusting the seat position to ensure that other passengers are not injured by the moving seat.
- Do not put your hands under the seat or near the moving parts to avoid injury.  
Fingers or hands may become jammed in the seat mechanism.

## SRS airbags

The SRS airbags inflate when the vehicle is subjected to certain types of severe impacts that may cause significant injury to the occupants. They work together with the seat belts to help reduce the risk of death or serious injury.

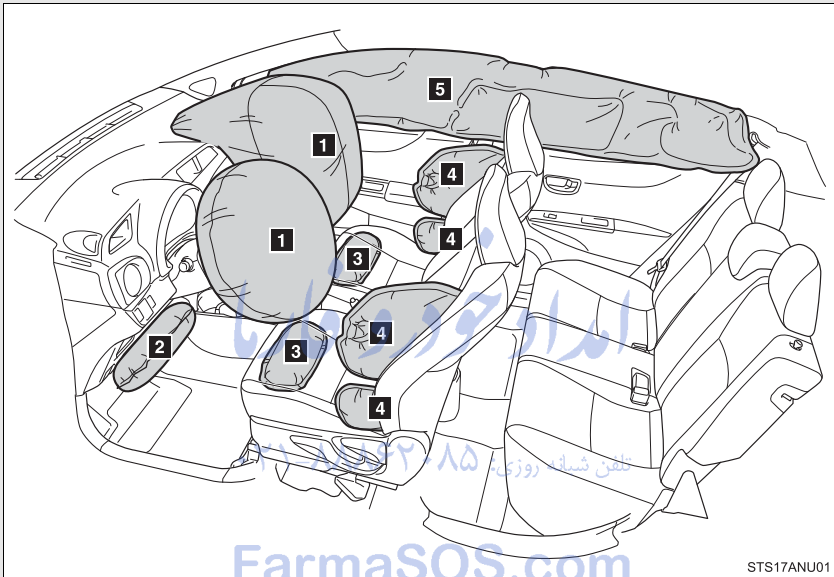

### SRS front airbags

- 1** SRS driver airbag/front passenger airbag  
Can help protect the head and chest of the driver and front passenger from impact with interior components.
- 2** SRS driver knee airbag  
Can help provide driver protection.
- 3** SRS seat cushion airbags  
Can help restrain the driver and front passenger.



**SRS side and curtain shield airbags****4** SRS side airbags

Can help protect the torso of the front seat occupants.

**5** SRS curtain shield airbags

Can help protect primarily the head of occupants in the outer seats.

1

Before driving

امداد خودرو فارما

تلفن شبانه روزی: ۰۲۱-۸۸۸۶۲۰۸۵

FarmaSOS.com

## SRS airbag system components

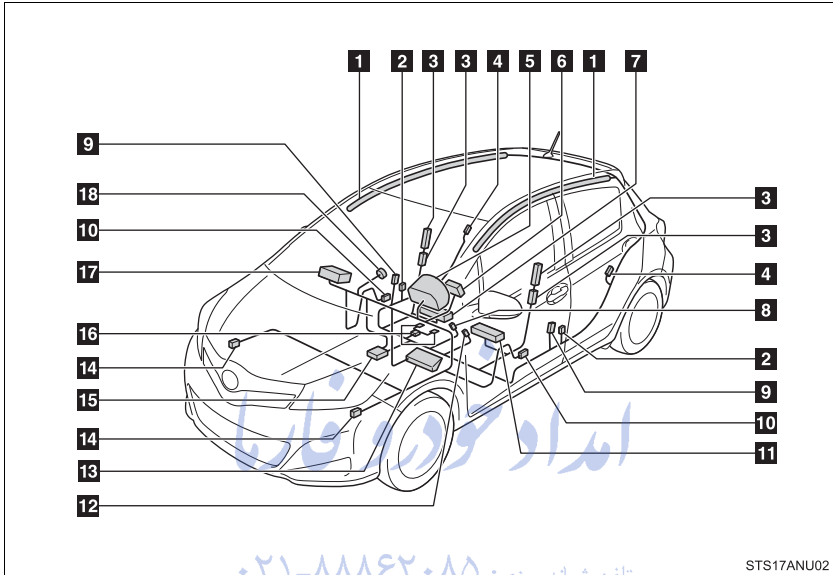

- |   |  |
|---|--|
| <b>1</b> Curtain shield airbags                     | <b>11</b> Driver seat cushion airbag                                       |
| <b>2</b> Side impact sensors (front)                | <b>12</b> Driver's seat belt buckle switch                                 |
| <b>3</b> Side airbags                               | <b>13</b> Driver knee airbag   |
| <b>4</b> Side impact sensors (rear)                 | <b>14</b> Front impact sensors   |
| <b>5</b> SRS warning light                          | <b>15</b> Airbag sensor assembly   |
| <b>6</b> Driver airbag                              | <b>16</b> Front passenger occupant classification system (ECU and sensors) |
| <b>7</b> Passenger seat cushion airbag              | <b>17</b> Front passenger airbag   |
| <b>8</b> Front passenger's seat belt buckle switch  | <b>18</b> "AIR BAG ON" and "AIR BAG OFF" indicator lights                  |
| <b>9</b> Seat belt pretensioners and force limiters |  |
| <b>10</b> Side impact sensors (front door)          |  |

Your vehicle is equipped with ADVANCED AIRBAGS designed based on the US motor vehicle safety standards (FMVSS208). The airbag sensor assembly (ECU) controls airbag deployment based on information obtained from the sensors etc. shown in the system components diagram above. This information includes crash severity and occupant information. As the airbags deploy, a chemical reaction in the inflators quickly fills the airbags with non-toxic gas to help restrain the motion of the occupants.

#### ■ If the SRS airbags deploy (inflate)

- Bruising and slight abrasions may result from contact with a deploying (inflating) SRS airbag.
- A loud noise and white powder will be emitted.
- Parts of the airbag module (steering wheel hub, airbag cover and inflator) as well as the front seats, parts of the front and rear pillars, and roof side rails, may be hot for several minutes. The airbag itself may also be hot.
- The windshield may crack.

#### ■ SRS airbag deployment conditions (SRS front airbags)

- The SRS front airbags and SRS seat cushion airbags will deploy in the event of an impact that exceeds the set threshold level (the level of force corresponding to an approximately 12 - 18 mph [20 - 30 km/h] frontal collision with a fixed wall that does not move or deform).

However, this threshold velocity will be considerably higher if the vehicle strikes an object, such as a parked vehicle and sign pole, which can move or deform on impact, or if the vehicle is involved in an underride collision (e.g. a collision in which the front of the vehicle “underrides”, or goes under, the bed of a truck etc.).

- Depending on the type of collision, it is possible that only the seat belt pretensioners will activate.
- The SRS front airbags and seat cushion airbag for the front passenger will not activate if there is no passenger sitting in the front passenger seat. However, the SRS front airbags and seat cushion airbag for the front passenger may deploy if luggage is put in the seat, even if the seat is unoccupied.
- The SRS seat cushion airbags on the front seats will not operate if the occupant is not wearing a seat belt.

■ **SRS airbag deployment conditions (SRS side and curtain shield airbags)**

The SRS side and curtain shield airbags will deploy in the event of an impact that exceeds the set threshold level (the level of force corresponding to the impact force produced by an approximately 3300 lb. [1500 kg] vehicle colliding with the vehicle cabin from a direction perpendicular to the vehicle orientation at an approximate speed of 12 - 18 mph [20 - 30 km/h]).

■ **Conditions under which the SRS airbags may deploy (inflate), other than a collision**

The SRS front airbags may also deploy if a serious impact occurs to the underside of your vehicle. Some examples are shown in the illustration.

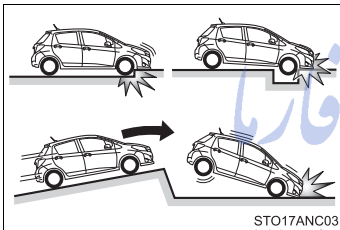

- Hitting a curb, edge of pavement or hard surface
- Falling into or jumping over a deep hole
- Landing hard or falling

■ **Types of collisions that may not deploy the SRS airbags (SRS front airbags)**

The SRS front airbags and SRS seat cushion airbags do not generally inflate if the vehicle is involved in a side or rear collision, if it rolls over, or if it is involved in a low-speed frontal collision. But, whenever a collision of any type causes sufficient forward deceleration of the vehicle, deployment of the SRS front airbags may occur.

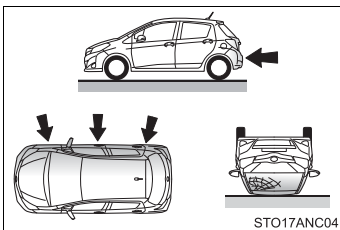

- Collision from the side
- Collision from the rear
- Vehicle rollover

### ■ Types of collisions that may not deploy the SRS airbags (SRS side and curtain shield airbags)

The SRS side and curtain shield airbags may not activate if the vehicle is subjected to a collision from the side at certain angles, or a collision to the side of the vehicle body other than the passenger compartment.

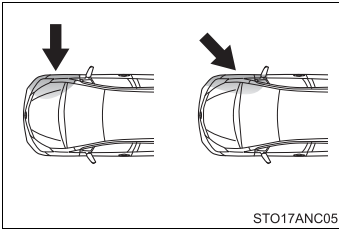

- Collision from the side to the vehicle body other than the passenger compartment
- Collision from the side at an angle

The SRS side and curtain shield airbags do not generally inflate if the vehicle is involved in a frontal or rear collision, if it rolls over, or if it is involved in a low-speed side collision.

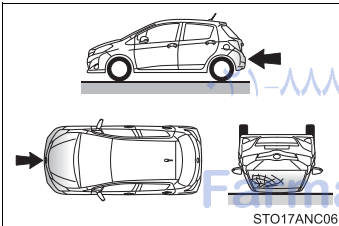

- Collision from the front
- Collision from the rear
- Vehicle rollover

### ■ When to contact your Toyota dealer

In the following cases, contact your Toyota dealer as soon as possible.

- Any of the SRS airbags have been inflated.

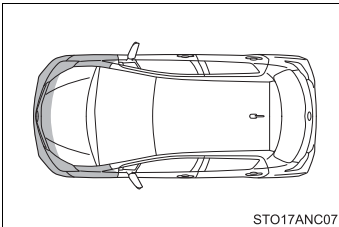

- The front of the vehicle is damaged or deformed, or was involved in an accident that was not severe enough to cause the SRS front airbags and SRS seat cushion airbags to inflate.

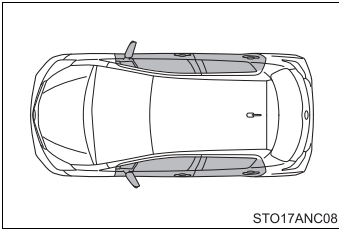

- A portion of a door is damaged or deformed, or the vehicle was involved in an accident that was not severe enough to cause the SRS side and curtain shield airbags to inflate.

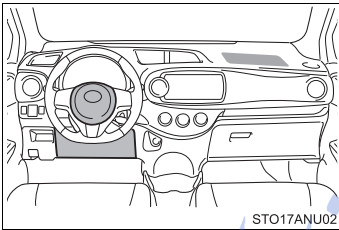

- The pad section of the steering wheel, dashboard near the front passenger airbag or lower portion of the instrument panel is scratched, cracked, or otherwise damaged.

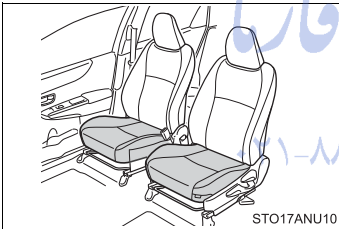

- The front seat cushion surface is scratched, cracked, or otherwise damaged.

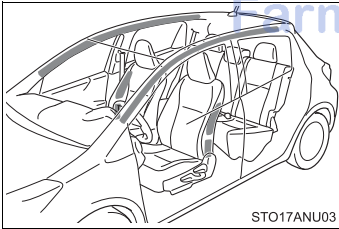

- The surface of the seats with the side airbag is scratched, cracked or otherwise damaged.
- The portion of the front pillars, rear pillars or roof side rail garnishes (padding) containing the curtain shield airbags is inside scratched, cracked, or otherwise damaged.

تلفن شبانه روزی: ۰۸۵-۸۸۶۲۰۱

Farma

**⚠ CAUTION****■ SRS airbag precautions**

Observe the following precautions regarding the SRS airbags. Failure to do so may cause death or serious injury.

- The driver and all passengers in the vehicle must wear their seat belts properly.

The SRS airbags are supplemental devices to be used with the seat belts.

- The SRS driver airbag deploys with considerable force, and can cause death or serious injury especially if the driver is very close to the airbag. The National Highway Traffic Safety Administration (NHTSA) advises:

Since the risk zone for the driver's airbag is the first 2 - 3 in. (50 - 75 mm) of inflation, placing yourself 10 in. (250 mm) from your driver airbag provides you with a clear margin of safety. This distance is measured from the center of the steering wheel to your breastbone. If you sit less than 10 in. (250 mm) away now, you can change your driving position in several ways:

- Move your seat to the rear as far as you can while still reaching the pedals comfortably.
- Slightly recline the back of the seat. Although vehicle designs vary, many drivers can achieve the 10 in. (250 mm) distance, even with the driver seat all the way forward, simply by reclining the back of the seat somewhat. If reclining the back of your seat makes it hard to see the road, raise yourself by using a firm, non-slippery cushion, or raise the seat if your vehicle has that feature.
- If your steering wheel is adjustable, tilt it downward. This points the airbag toward your chest instead of your head and neck.

The seat should be adjusted as recommended by NHTSA above, while still maintaining control of the foot pedals, steering wheel, and your view of the instrument panel controls.

**⚠ CAUTION**

**■ SRS airbag precautions**

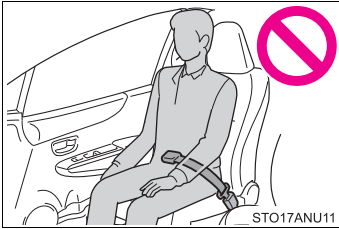

- If the seat belt extender has been connected to the front seat belt buckles but the seat belt extender has not also been fastened to the latch plate of the seat belt, the SRS front airbags will judge that the driver and front passenger are wearing the seat belt even though the seat belt has not been connected. In this case, the SRS front airbags may not activate correctly in a collision, resulting in death or serious injury in the event of a collision. Be sure to wear the seat belt with the seat belt extender.

- The SRS front passenger airbag also deploys with considerable force, and can cause death or serious injury especially if the front passenger is very close to the airbag. The front passenger seat should be as far from the airbag as possible with the seatback adjusted, so the front passenger sits upright.
- Improperly seated and/or restrained infants and children can be killed or seriously injured by a deploying airbag. An infant or child who is too small to use a seat belt should be properly secured using a child restraint system. Toyota strongly recommends that all infants and children be placed in the rear seats of the vehicle and properly restrained. The rear seats are safer for infants and children than the front passenger seat. (→P. 98)

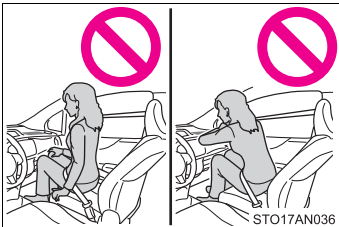

- Do not sit on the edge of the seat or lean against the dashboard.



**⚠ CAUTION**

**■ SRS airbag precautions**

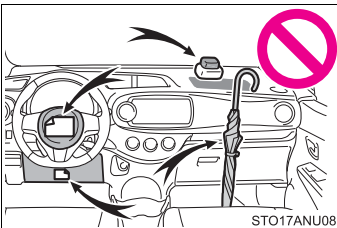
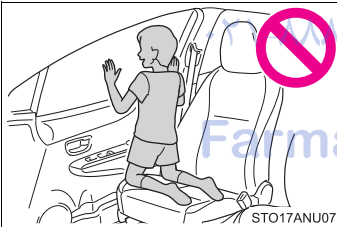
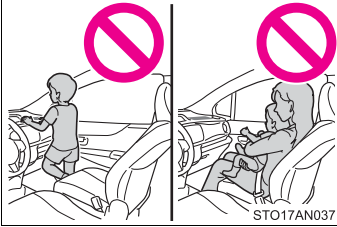

- Do not allow a child to stand in front of the SRS front passenger airbag unit or sit on the knees of a front passenger.
- Do not allow the front seat occupants to hold items on their knees.
- Do not lean against the door, the roof side rail or the front, side and rear pillars.
- Do not allow anyone to kneel on the passenger seat toward the door or put their head or hands outside the vehicle.
- Do not attach anything to or lean anything against areas such as the dashboard, steering wheel pad and lower portion of the instrument panel. These items can become projectiles when the SRS driver, front passenger and driver knee airbags deploy.

**! CAUTION**

**■ SRS airbag precautions**

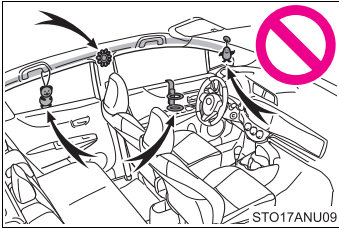

● Do not attach anything to areas such as a door, windshield glass, side door glass, front or rear pillar, roof side rail and assist grip.

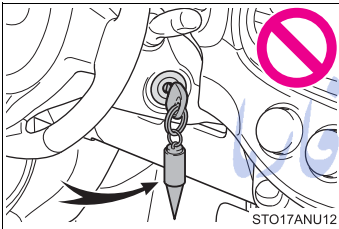

● Do not attach any heavy, sharp or hard objects such as keys and accessories to the key. The objects may restrict the SRS driver knee airbag inflation or be thrust into the driver's seat area by the force of the deploying airbag, thus causing a danger.

- Do not hang coat hangers or other hard objects on the coat hooks. All of these items could become projectiles and may cause death or serious injury, should the SRS curtain shield airbags deploy.
- If a vinyl cover is put on the area where the SRS driver knee airbag will deploy, be sure to remove it.
- Do not use seat accessories which cover the parts where the SRS side airbags and SRS seat cushion airbags inflate as they may interfere with inflation of the SRS airbags. Such accessories may prevent the side airbags and seat cushion airbags from activating correctly, disable the system or cause the side airbags and seat cushion airbags to inflate accidentally, resulting in death or serious injury.
- Do not strike or apply significant levels of force to the area of the SRS airbag components.  
Doing so can cause the SRS airbags to malfunction.
- Do not touch any of the component parts immediately after the SRS airbags have deployed (inflated) as they may be hot.

**⚠ CAUTION****■ SRS airbag precautions**

- If breathing becomes difficult after the SRS airbags have deployed, open a door or window to allow fresh air in, or leave the vehicle if it is safe to do so. Wash off any residue as soon as possible to prevent skin irritation.
- If the areas where the SRS airbags are stored, such as the steering wheel pad and front and rear pillar garnishes, are damaged or cracked, have them replaced by your Toyota dealer.
- Do not place anything, such as a cushion, on the front passenger's seat. Doing so will disperse the passenger's weight, which prevents the sensor from detecting the passenger's weight properly. As a result, the SRS front airbags for the front passenger may not deploy in the event of a collision.

**■ Modification and disposal of SRS airbag system components**

Do not dispose of your vehicle or perform any of the following modifications without consulting your Toyota dealer. The SRS airbags may malfunction or deploy (inflate) accidentally, causing death or serious injury.

- Installation, removal, disassembly and repair of the SRS airbags.
- Repairs, modifications, removal or replacement of the steering wheel, instrument panel, dashboard, seats or seat upholstery, front, side and rear pillars or roof side rails.
- Repairs or modifications of the front fender, front bumper, or side of the occupant compartment.
- Installation of snow plows, winches, etc. to the front grille (bull bars or kangaroo bar etc.).
- Modifications to the vehicle's suspension system.
- Installation of electronic devices such as mobile two-way radios and CD players.
- Modifications to your vehicle for a person with a physical disability.

## 1-7. Safety information

### Front passenger occupant classification system

Your vehicle is equipped with a front passenger occupant classification system. This system detects the conditions of the front passenger seat and activates or deactivates the devices for front passenger.

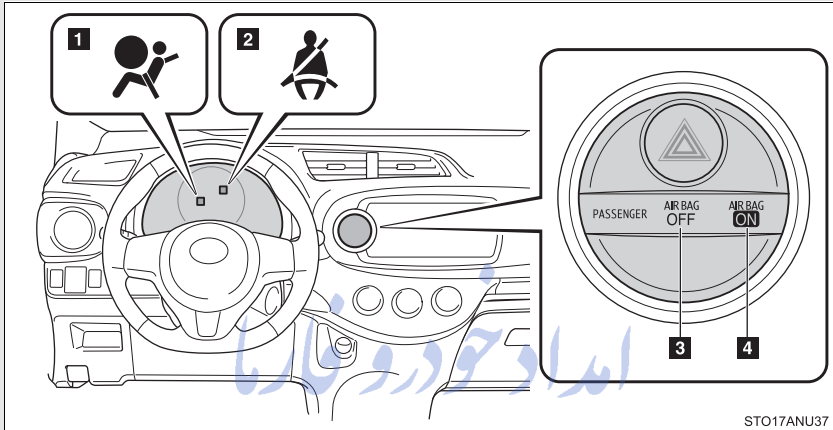

**1** SRS warning light

**2** Seat belt reminder light

**3** "AIR BAG OFF" indicator light

**4** "AIR BAG ON" indicator light

تلفن شبانه روزی: ۰۸۵ ۲۸۶۲۰۸۵  
FarmaSOS.com

<b>Condition and operation in the front passenger occupant classification system</b>
--

<p>■ <b>Adult*1</b></p>
-------------------------

Indicator/ warning light	"AIR BAG ON" and "AIR BAG OFF" indicator lights	"AIR BAG ON"
	SRS warning light	Off
	Seat belt reminder light	Off*2 or flashing*3
Devices	Front passenger airbag	Activated
	Side airbag on the front passenger seat	
	Curtain shield airbag in the front passenger side	
	Seat cushion airbag in the front passenger side	Activated*2 or deactivated*3
	Front passenger's seat belt pretensioner	Activated

<p>■ <b>Child*4</b></p>
-------------------------

Indicator/ warning light	"AIR BAG ON" and "AIR BAG OFF" indicator lights	"AIR BAG OFF" or "AIR BAG ON"*4
	SRS warning light	Off
	Seat belt reminder light	Off or flashing*3,*4
Devices	Front passenger airbag	Deactivated or activated*4
	Side airbag on the front passenger seat	Activated
	Curtain shield airbag in the front passenger side	
	Seat cushion airbag in the front passenger side	Deactivated or activated*4
	Front passenger's seat belt pretensioner	Activated

1

Before driving

■ Child restraint system with infant\*5

Indicator/ warning light	“AIR BAG ON” and “AIR BAG OFF” indicator lights	“AIR BAG OFF”*6
	SRS warning light	Off
	Seat belt reminder light	Off*2 or flashing*3
Devices	Front passenger airbag	Deactivated
	Side airbag on the front passenger seat	Activated
	Curtain shield airbag in the front passenger side	
	Seat cushion airbag in the front passenger side	Deactivated
	Front passenger’s seat belt pretensioner	Activated

■ Unoccupied

Indicator/ warning light	“AIR BAG ON” and “AIR BAG OFF” indicator lights	“AIR BAG OFF”
	SRS warning light	Off
	Seat belt reminder light	
Devices	Front passenger airbag	Deactivated
	Side airbag on the front passenger seat	Activated
	Curtain shield airbag in the front passenger side	
	Seat cushion airbag in the front passenger side	Deactivated
	Front passenger’s seat belt pretensioner	Activated

## ■ There is a malfunction in the system

Indicator/ warning light	“AIR BAG ON” and “AIR BAG OFF” indicator lights	“AIR BAG OFF”
	SRS warning light	On
	Seat belt reminder light	
Devices	Front passenger airbag	Deactivated
	Side airbag on the front passenger seat	Activated
	Curtain shield airbag in the front passenger side	
	Seat cushion airbag in the front passenger side	Deactivated
	Front passenger’s seat belt pretensioner	Activated

- \*1: The system judges a person of adult size as an adult. When a smaller adult sits in the front passenger seat, the system may not recognize him/her as an adult depending on his/her physique and posture.
- \*2: In the event the front passenger is wearing a seat belt.
- \*3: In the event the front passenger does not wear a seat belt.
- \*4: For some children, child in seat, child in booster seat or child in convertible seat, the system may not recognize him/her as a child. Factors which may affect this can be the physique or posture.
- \*5: Never install a rear-facing child restraint system on the front passenger seat. A forward-facing child restraint system should only be installed on the front passenger seat when it is unavoidable.  
(→P. 98)
- \*6: In case the indicator light is not illuminated, consult this manual on how to install the child restraint system properly. (→P. 102)

 CAUTION

**■ Front passenger occupant classification system precautions**

Observe the following precautions regarding the front passenger occupant classification system.

Failure to do so may cause death or serious injury.

- Wear the seat belt properly.
- Make sure the front passenger's seat belt plate has not been left inserted into the buckle before someone sits in the front passenger seat.
- Make sure the "AIR BAG OFF" indicator light is not illuminated when using the seat belt extender for the front passenger seat. If the "AIR BAG OFF" indicator light is illuminated, disconnect the extender tongue from the seat belt buckle, and reconnect the seat belt. Reconnect the seat belt extender after making sure the "AIR BAG ON" indicator light is illuminated. If you use the seat belt extender while the "AIR BAG OFF" indicator light is illuminated, the SRS airbags for the passenger may not activate correctly, which could cause death or serious injury in the event of collision.
- Do not apply a heavy load to the front passenger seat or equipment (e.g. seatback pocket). تلفن شبانه روزی: ۰۲۱-۸۸۶۲۰۸۵
- Do not put weight on the front passenger seat by putting your hands or feet on the front passenger seat seatback from the rear passenger seat.
- Do not let a rear passenger lift the front passenger seat with their feet or press on the seatback with their legs.
- Do not put objects under the front passenger seat.



 CAUTION

**Front passenger occupant classification system precautions**

- Do not recline the front passenger seatback so far that it touches a rear seat. This may cause the “AIR BAG OFF” indicator light to be illuminated, which indicates that the passenger’s airbags will not deploy in the event of a severe accident. If the seatback touches the rear seat, return the seatback to a position where it does not touch the rear seat. Keep the front passenger seatback as upright as possible when the vehicle is moving. Reclining the seatback excessively may lessen the effectiveness of the seat belt system.
- If an adult sits in the front passenger seat, the “AIR BAG ON” indicator light is illuminated. If the “AIR BAG OFF” indicator is illuminated, ask the passenger to sit up straight, well back in the seat, feet on the floor, and with the seat belt worn correctly. If the “AIR BAG OFF” indicator still remains illuminated, either ask the passenger to move to the rear seat, or if that is not possible, move the front passenger seat fully rearward.
- When it is unavoidable to install a forward-facing child restraint system on the front passenger seat, install the child restraint system on the front passenger seat in the proper order. (→P. 102) تلفن شبانه
- Do not modify or remove the front seats.
- Do not kick the front passenger seat or subject it to severe impact. Otherwise, the SRS warning light may come on to indicate a malfunction of the detection system. In this case, contact your Toyota dealer immediately.
- Child restraint systems installed on the rear seat should not contact the front seatbacks.
- Do not use a seat accessory, such as a cushion and seat cover, that covers the seat cushion surface.
- Do not modify or replace the upholstery of the front seat.

## Child restraint systems

**A child restraint system for a small child or baby must itself be properly restrained on the seat with the lap portion of the lap/shoulder belt.**

**The laws of all 50 states of the U.S.A. and Canada now require the use of child restraint systems.**

### Points to remember

Studies have shown that installing a child restraint on a rear seat is much safer than installing one on the front passenger seat.

- Choose a child restraint system that suits your vehicle and is appropriate to the age and size of the child.
- For installation details, follow the instructions provided with the child restraint system.

General installation instructions are provided in this manual.

(→P. 102)

تلفن شبانه روزی: ۰۲۱-۸۸۶۲۰۸۵

### Types of child restraints

Child restraint systems are classified into the following 3 types according to the age and size of the child:

#### Rear facing — Infant seat/convertible seat

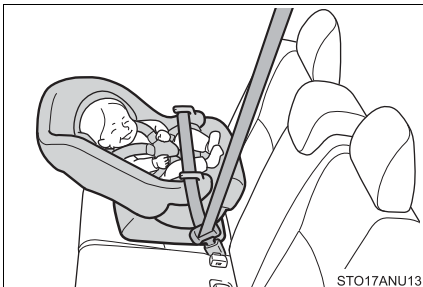

### Forward facing — Convertible seat



### Booster seat



#### ■ Selecting an appropriate child restraint system

- Use a child restraint system appropriate for the child until the child becomes large enough to properly wear the vehicle's seat belts.
- If a child is too large for a child restraint system, sit the child on a rear seat and use the vehicle's seat belt. (→P. 54)

 CAUTION

■ Child restraint precautions

- For effective protection in automobile accidents and sudden stops, a child must be properly restrained, using a seat belt or child restraint system depending on the age and size of the child. Holding a child in your arms is not a substitute for a child restraint system. In an accident, the child can be crushed against the windshield, or between you and the vehicle's interior.
- Toyota strongly urges the use of a proper child restraint system that conforms to the size of the child, installed on the rear seat. According to accident statistics, the child is safer when properly restrained in the rear seat than in the front seat.
- Never install a rear-facing child restraint system on the front passenger seat even if the "AIR BAG OFF" indicator light is illuminated. In the event of an accident, the force of the rapid inflation of the front passenger airbag can cause death or serious injury to the child if the rear-facing child restraint system is installed on the front passenger seat.
- A forward-facing child restraint system may be installed on the front passenger seat only when it is unavoidable. A child restraint system that requires a top tether strap should not be used in the front passenger seat since there is no top tether strap anchor for the front passenger seat. Adjust the seatback as upright as possible and always move the seat as far back as possible even if the "AIR BAG OFF" indicator light is illuminated, because the front passenger airbag could inflate with considerable speed and force. Otherwise, the child may be killed or seriously injured.
- Do not use the seat belt extender when installing a child restraint system on the front or rear passenger seat. If installing a child restraint system with the seat belt extender connected to the seat belt, the seat belt will not securely hold the child restraint system, which could cause death or serious injury to the child or other passengers in the event of sudden braking, sudden swerving or an accident.
- Do not allow the child to lean his/her head or any part of his/her body against the door or the area of the seat, front and rear pillars or roof side rails from which the SRS side airbags or SRS curtain shield airbags deploy even if the child is seated in the child restraint system. It is dangerous if the SRS side airbags and curtain shield airbags inflate, and the impact could cause death or serious injury to the child.

 **CAUTION****■ Child restraint precautions**

- Make sure you have complied with all installation instructions provided by the child restraint manufacturer and that the system is properly secured. If it is not secured properly, it may cause death or serious injury to the child in the event of a sudden stop or an accident.

**■ When children are in the vehicle**

Do not allow children to play with the seat belt. If the seat belt becomes twisted around a child's neck, it may lead to choking or other serious injuries that could result in death.

If this occurs and the buckle cannot be unfastened, scissors should be used to cut the belt.

**■ When the child restraint system is not in use**

- Keep the child restraint system properly secured on the seat even if it is not in use. Do not store the child restraint system unsecured in the passenger compartment.
- If it is necessary to detach the child restraint system, remove it from the vehicle or store it securely in the luggage compartment. This will prevent it from injuring passengers in the event of sudden braking, sudden swerving or an accident.

## Installing child restraints

Follow the child restraint system manufacturer's instructions. Firmly secure child restraints to the rear seats using the LATCH anchors or a seat belt. Attach the top tether strap when installing a child restraint.

The lap/shoulder belt can be used if your child restraint system is not compatible with the LATCH (Lower Anchors and Tethers for Children) system.

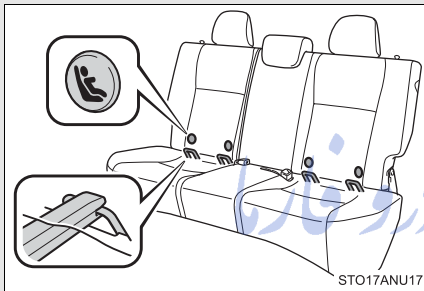

### Child restraint LATCH anchors

LATCH anchors are provided for the outside rear seats. (Buttons displaying the location of the anchors are attached to the seats.)

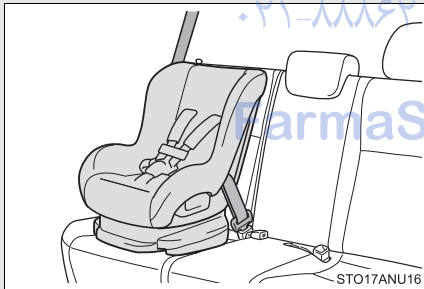

Seat belts equipped with a child restraint locking mechanism (ALR/ELR belts except driver's seat belt) (→P. 54)

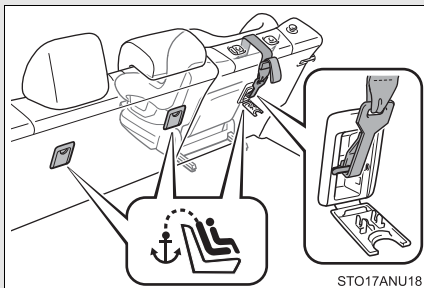

### Anchor brackets (for top tether strap)

An anchor bracket is provided for each rear seat.

## Installation with LATCH system

### Type A

**STEP 1** Widen the gap between the seat cushion and seatback slightly.

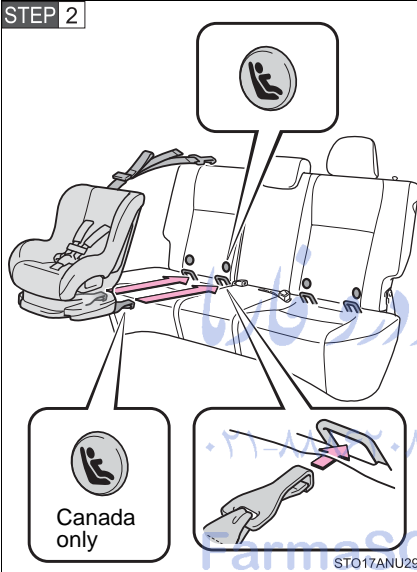

Latch the hooks of the lower straps onto the LATCH anchors. If the child restraint has a top tether strap, the top tether strap should be latched onto the top tether strap anchor.

For owners in Canada:

The symbol on a child restraint system indicates the presence of a lower connector system.

1

Before driving

تلفن شبانه روزی: ۰۲۶-۸۰۰-۰۸۵

FarmSOS.com

## Type B

**STEP 1** Widen the gap between the seat cushion and seatback slightly.

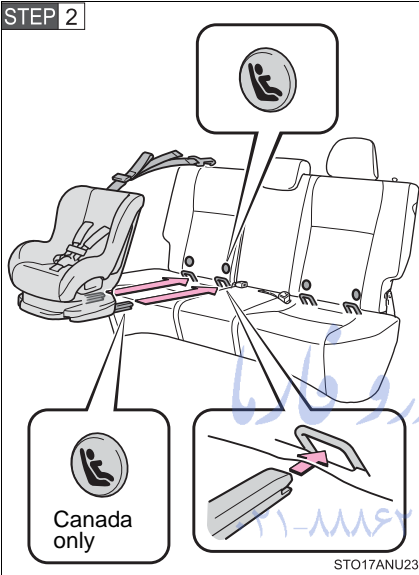

Latch the buckles onto the LATCH anchors. If the child restraint has a top tether strap, the top tether strap should be latched onto the top tether strap anchor.

For owners in Canada:

The symbol on a child restraint system indicates the presence of a lower connector system.

امداد خودرو روزی: ۸۵-۸۸۶۲-۲۱

### Installing child restraints using a seat belt (child restraint lock function belt)

#### ■ Rear facing — Infant seat/convertible seat

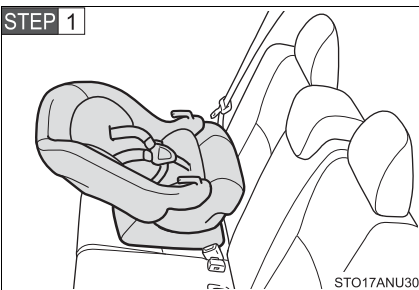

Place the child restraint system on the rear seat facing the rear of the vehicle.



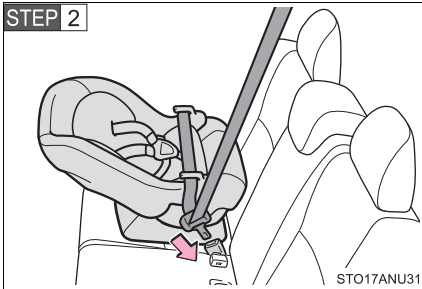

Run the seat belt through the child restraint system and insert the plate into the buckle. Make sure that the belt is not twisted.

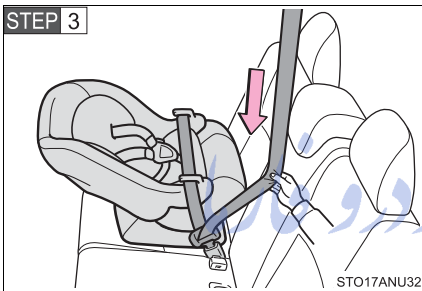

Fully extend the shoulder belt and allow it to retract to put it in lock mode. In lock mode, the belt cannot be extended.

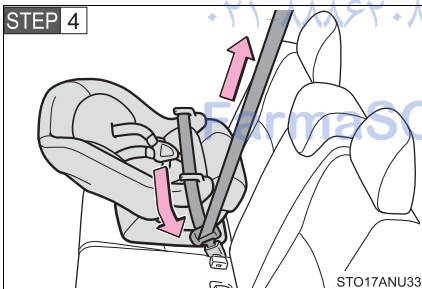

While pushing the child restraint system down into the rear seat, allow the shoulder belt to retract until the child restraint system is securely in place.

After the shoulder belt has retracted to a point where there is no slack in the belt, pull the belt to check that it cannot be extended.

### ■ Forward facing — Convertible seat

**STEP 1** Remove the head restraint. (→P. 51)

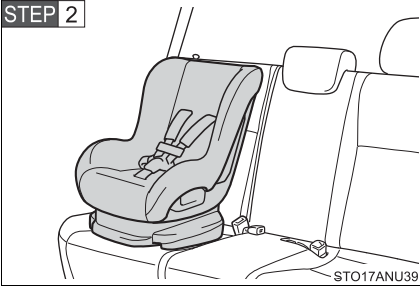

Place the child restraint system on the seat facing the front of the vehicle.

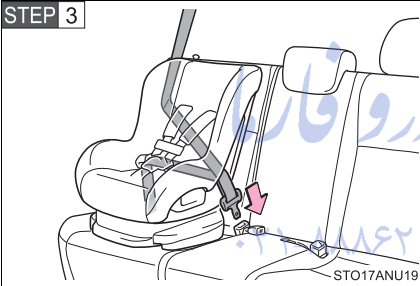

Run the seat belt through the child restraint system and insert the plate into the buckle. Make sure that the belt is not twisted.

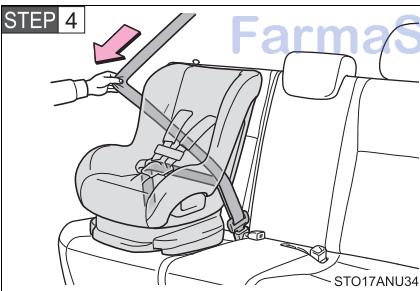

Fully extend the shoulder belt and allow it to retract to put it in lock mode. In lock mode, the belt cannot be extended.

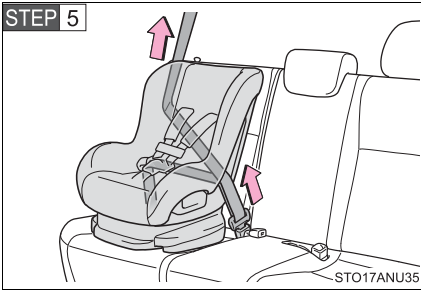

While pushing the child restraint system into the rear seat, allow the shoulder belt to retract until the child restraint system is securely in place.

After the shoulder belt has retracted to a point where there is no slack in the belt, pull the belt to check that it cannot be extended.

**STEP 6** If the child restraint has a top tether strap, the top tether strap should be latched onto the top tether strap anchor. (→P. 108)

### ■ Booster seat

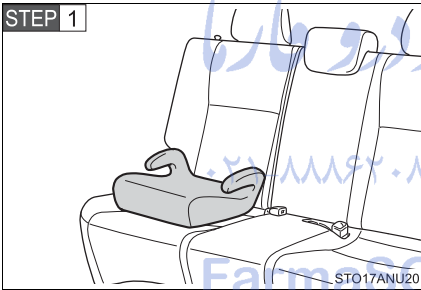

Place the child restraint system on the seat facing the front of the vehicle.



Sit the child in the child restraint system. Fit the seat belt to the child restraint system according to the manufacturer's instructions and insert the plate into the buckle. Make sure that the belt is not twisted.

Check that the shoulder belt is correctly positioned over the child's shoulder and that the lap belt is as low as possible. (→P. 54)

### Removing a child restraint installed with a seat belt

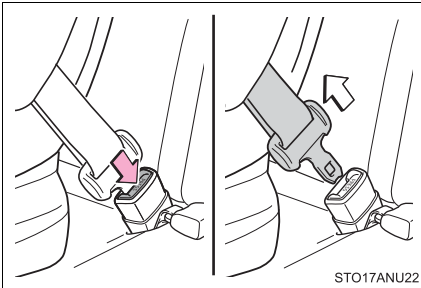

Push the buckle release button and fully retract the seat belt.

### Child restraint systems with a top tether strap

**STEP 1** Remove the luggage cover. (→P. 218)

**STEP 2** Remove the head restraint. (→P. 51)

**STEP 3** Secure the child restraint system using the LATCH anchors or a seat belt.

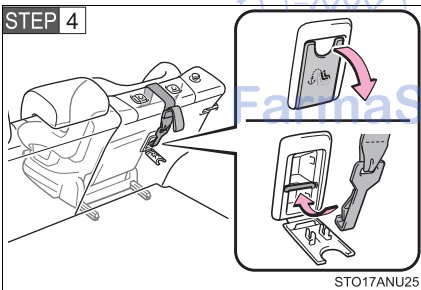

Open the anchor bracket cover, latch the hook onto the anchor bracket and tighten the top tether strap.

Make sure the top tether strap is securely latched.

**STEP 5** Reinstall the luggage cover.

### ■ Laws and regulations pertaining to anchorages

The LATCH system conforms to FMVSS225 or CMVSS210.2.

Child restraint systems conforming to FMVSS213 or CMVSS213 specifications can be used.

This vehicle is designed to conform to the SAE J1819.

## ⚠ CAUTION

### ■ When installing a booster seat

To prevent the belt from going into ALR lock mode, do not fully extend the shoulder belt. ALR mode causes the belt to tighten only. This could cause injury or discomfort to the child. (→P. 57)

### ■ When installing a child restraint system

Follow the directions given in the child restraint system installation manual and fix the child restraint system securely in place.

If the child restraint system is not correctly fixed in place, the child or other passengers may be seriously injured or even killed in the event of sudden braking, sudden swerving or an accident.

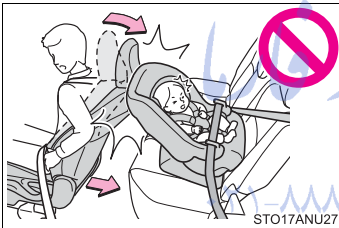

- If the driver's seat interferes with the child restraint system and prevents it from being attached correctly, attach the child restraint system to the right-hand rear seat.

- Adjust the front passenger seat so that it does not interfere with the child restraint system.

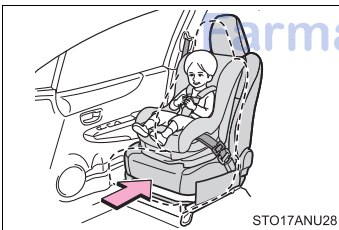

- Only put a forward-facing child restraint system on the front seat when unavoidable. When installing a forward-facing child restraint system on the front passenger seat, move the seat as far back as possible even if the "AIR BAG OFF" indicator light is illuminated. Failure to do so may result in death or serious injury if the airbags deploy (inflate).

- When a booster seat is installed, always ensure that the shoulder belt is positioned across the center of the child's shoulder. The belt should be kept away from the child's neck, but not so that it could fall off the child's shoulder. Failure to do so may result in death or serious injury in the event of sudden braking, sudden swerving or an accident.

- Ensure that the belt and plate are securely locked and the seat belt is not twisted.

**⚠ CAUTION**

**■ When installing a child restraint system**

- Push and pull the child restraint system from side to side and forward to be sure it is secure.
- After securing a child restraint system, never adjust the seat.
- Follow all installation instructions provided by the child restraint system manufacturer.
- When a child restraint system with a top tether strap is installed, do not install the head restraint. The head restraint may interfere with the top tether strap preventing secure installation of the child restraint system.
- Make sure to properly store the removed head restraint in a secure place when you use the child restraint system on the rear seat.



- When using the right side seat for the child restraint system, do not sit in the center seat. Seat belt function may be impaired, such as being positioned overly high or loose-fitting, which may result in death or serious injury in the event of sudden braking or an accident.

**■ Do not use a seat belt extender**

If a seat belt extender is used when installing a child restraint system, the seat belt will not securely hold the child restraint system, which could cause death or serious injury to the child or other passengers in the event of sudden braking, sudden swerving or an accident.

**■ To correctly attach a child restraint system to the anchors**

When using the LATCH anchors, be sure that there are no foreign objects around the anchors and that the seat belt is not caught behind the child restraint. Make sure the child restraint system is securely attached, or it may cause death or serious injury to the child or other passengers in the event of sudden braking, sudden swerving or an accident.

## When driving

# 2

### 2-1. Driving procedures

Driving the vehicle.....	112
Engine (ignition) switch....	124
Automatic transmission....	127
Manual transmission.....	129
Turn signal lever .....	130
Parking brake.....	131
Horn .....	132

### 2-2. Instrument cluster

Gauges and meters .....	133
Indicators and warning lights .....	136
Multi-information display.....	140

### 2-3. Operating the lights and wipers

Headlight switch.....	145
Fog light switch .....	148
Windshield wiper and washer .....	150
Rear window wiper and washer .....	153

### 2-4. Using other driving systems

Cruise control.....	158
Driving assist systems .....	162

### 2-5. Driving information

Cargo and luggage .....	167
Vehicle load limits .....	171
Winter driving tips .....	172
Trailer towing (except 3-door models for Canada).....	176
Trailer towing (3-door models for Canada).....	177
Dinghy towing (vehicles with an automatic transmission) .....	187
Dinghy towing (vehicles with a manual transmission) .....	188

## 2-1. Driving procedures

### Driving the vehicle

The following procedures should be observed to ensure safe driving:

#### ■ Starting the engine

→ P. 124

#### ■ Driving

##### Vehicles with an automatic transmission

**STEP 1** With the brake pedal depressed, shift the shift lever to D.  
(→P. 127)

**STEP 2** Release the parking brake. (→P. 131)

**STEP 3** Gradually release the brake pedal and gently depress the accelerator pedal to accelerate the vehicle.

##### Vehicles with a manual transmission

**STEP 1** While depressing the clutch pedal, shift the shift lever to 1.  
(→P. 129)

**STEP 2** Release the parking brake. (→P. 131) تلفن شبانه

**STEP 3** Gradually release the clutch pedal. At the same time, gently depress the accelerator pedal to accelerate the vehicle.

#### ■ Stopping

##### Vehicles with an automatic transmission

**STEP 1** With the shift lever in D, depress the brake pedal.

**STEP 2** If necessary, set the parking brake.

If the vehicle is to be stopped for an extended period of time, shift the shift lever to P or N. (→P. 127)

##### Vehicles with a manual transmission

**STEP 1** While depressing the clutch pedal, depress the brake pedal.

**STEP 2** If necessary, set the parking brake.

If the vehicle is to be stopped for an extended period of time, shift the shift lever to N. (→P. 129)



## ■ Parking the vehicle

### Vehicles with an automatic transmission

**STEP 1** With the shift lever in D, depress the brake pedal.

**STEP 2** Set the parking brake. (→P. 131)

**STEP 3** Shift the shift lever to P. (→P. 127)

If parking on a hill, block the wheels as needed.

**STEP 4** Turn the engine switch to the “LOCK” position to stop the engine.

**STEP 5** Lock the door, making sure that you have the key on your person.

### Vehicles with a manual transmission

**STEP 1** While depressing the clutch pedal, depress the brake pedal.

**STEP 2** Set the parking brake. (→P. 131)

**STEP 3** Shift the shift lever to N. (→P. 129)

If parking on a hill, shift the shift lever to 1 or R and block the wheels as needed.

**STEP 4** Turn the engine switch to the “LOCK” position to stop the engine.

**STEP 5** Lock the door, making sure that you have the key on your person.

## Starting off on a steep uphill

### Vehicles with an automatic transmission

**STEP 1** Make sure that the parking brake is set and shift the shift lever to D.

**STEP 2** Gently depress the accelerator pedal.

**STEP 3** Release the parking brake.

## Vehicles with a manual transmission

- STEP 1** With the parking brake firmly set and the clutch pedal fully depressed, shift the shift lever to 1.
  - STEP 2** Lightly depress the accelerator pedal at the same time as gradually releasing the clutch pedal.
  - STEP 3** Release the parking brake.
- 

### ■ Driving in the rain

- Drive carefully when it is raining, because visibility will be reduced, the windows may become fogged-up, and the road will be slippery.
- Drive carefully when it starts to rain, because the road surface will be especially slippery.
- Refrain from high speeds when driving on an expressway in the rain, because there may be a layer of water between the tires and the road surface, preventing the steering and brakes from operating properly.

### ■ Engine speed while driving

In the following conditions, the engine speed may become high while driving. This is due to automatic up-shifting control or down-shifting implementation to meet driving conditions. It does not indicate sudden acceleration.

- The vehicle is judged to be driving uphill or downhill
- When the accelerator pedal is released

### ■ Breaking in your new Toyota

To extend the life of the vehicle, observing the following precautions is recommended:

- For the first 200 miles (300 km):  
Avoid sudden stops.
- For the first 500 miles (800 km) (3-door models for Canada):  
Do not tow a trailer.
- For the first 1000 miles (1600 km):
  - Do not drive at extremely high speeds.
  - Avoid sudden acceleration.
  - Do not drive continuously in low gears.
  - Do not drive at a constant speed for extended periods.

## ■ Operating your vehicle in a foreign country

Comply with the relevant vehicle registration laws and confirm the availability of the correct fuel. (→P. 346)

## ■ Eco-friendly driving (vehicles with an automatic transmission)

### Vehicles without a tachometer

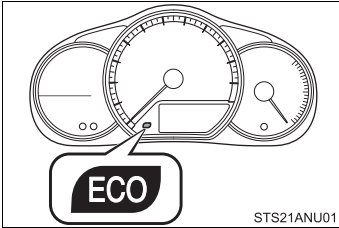

During Eco-friendly acceleration operation (Eco driving), Eco Driving Indicator Light will turn on. When the accelerator pedal is depressed excessively, and when the vehicle is stopped, the light turns off.

Eco Driving Indicator Light will not operate in the following conditions:

- The shift lever is in anything other than D.
- The vehicle speed is approximately 80 mph (130 km/h) or higher.

Eco Driving Indicator Light can be activated or deactivated. (→P. 143)

### Vehicles with a tachometer

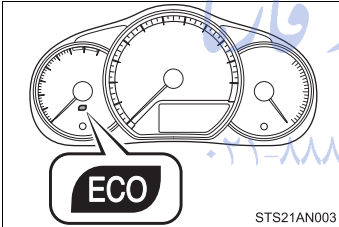

 CAUTION

**■ When starting the vehicle (vehicles with an automatic transmission)**

Always keep your foot on the brake pedal while stopped with the engine running. This prevents the vehicle from creeping.

**■ When driving the vehicle**

- Do not drive if you are unfamiliar with the location of the brake and accelerator pedals to avoid depressing the wrong pedal.
  - Accidentally depressing the accelerator pedal instead of the brake pedal will result in sudden acceleration that may lead to an accident that could result in death or serious injury.
  - When backing up, you may twist your body around, leading to a difficulty in operating the pedals. Make sure to operate the pedals properly.
  - Make sure to keep a correct driving posture even when moving the vehicle only slightly. This allows you to depress the brake and accelerator pedals properly.
  - Depress the brake pedal using your right foot. Depressing the brake pedal using your left foot may delay response in an emergency, resulting in an accident.
- Do not drive the vehicle over or stop the vehicle near flammable materials. The exhaust system and exhaust gases can be extremely hot. These hot parts may cause a fire if there is any flammable material nearby.
- On vehicles with an automatic transmission, do not let the vehicle roll backward while the shift lever is in a driving position, or roll forward while the shift lever is in R.  
Doing so may cause the engine to stall or lead to poor brake and steering performance, resulting in an accident or damage to the vehicle.
- If the smell of exhaust is noticed inside the vehicle, open the windows and check that the back door is closed. Large amounts of exhaust in the vehicle can cause driver drowsiness and an accident, resulting in death or a serious health hazard. Have the vehicle inspected by your Toyota dealer immediately.
- On vehicles with an automatic transmission, do not shift the shift lever to P while the vehicle is moving.  
Doing so can damage the transmission and may result in a loss of vehicle control.

## ⚠ CAUTION

- Do not shift the shift lever to R while the vehicle is moving forward. Doing so can damage the transmission and may result in a loss of vehicle control.
- Do not shift the shift lever to D (vehicles with an automatic transmission) or 1 (vehicles with a manual transmission) while the vehicle is moving backward. Doing so can damage the transmission and may result in a loss of vehicle control.
- Moving the shift lever to N while the vehicle is moving will disengage the engine from the transmission. Engine braking is not available when N is selected.
- During normal driving, do not turn off the engine. Turning the engine off while driving will not cause loss of steering or braking control, but the power assist to these systems will be lost. This will make it more difficult to steer and brake, so you should pull over and stop the vehicle as soon as it is safe to do so.  
However, in the event of an emergency, such as if it becomes impossible to stop the vehicle in the normal way: →P. 339 تلفن 339
- Use engine braking (downshift) to maintain a safe speed when driving down a steep hill.  
Using the brakes continuously may cause the brakes to overheat and lose effectiveness. (→P. 127, 129)
- When stopped on an inclined surface, use the brake pedal and parking brake to prevent the vehicle from rolling backward or forward and causing an accident.
- Do not adjust the positions of the steering wheel, the seat, or the inside or outside rear view mirrors while driving.  
Doing so may result in a loss of vehicle control that can cause accidents, resulting in death or serious injury.
- Always check that all passengers' arms, heads or other parts of their body are not outside the vehicle, as this may result in death or serious injury.

 **CAUTION**

- Do not drive in excess of the speed limit. Even if the legal speed limit permits it, do not drive over 85 mph (140 km/h) unless your vehicle has high-speed capability tires. Driving over 85 mph (140 km/h) may result in tire failure, loss of control and possible injury. Be sure to consult a tire dealer to determine whether the tires on your vehicle are high-speed capability tires or not before driving at such speeds.

■ **When driving on slippery road surfaces**

- Sudden braking, acceleration and steering may cause tire slippage and reduce your ability to control the vehicle, resulting in an accident.
- Sudden changes in engine speed, such as engine braking caused by up-shifting and down-shifting, may cause the vehicle to skid, resulting in an accident.
- After driving through a puddle, lightly depress the brake pedal to make sure that the brakes are functioning properly. Wet brake pads may prevent the brakes from functioning properly. If the brakes on only one side are wet and not functioning properly, steering control may be affected, resulting in an accident.

■ **When shifting the shift lever (vehicles with an automatic transmission)**

Be careful not to shift the shift lever with the accelerator pedal depressed. Shifting the shift lever to a gear other than P or N may lead to unexpected rapid acceleration of the vehicle that may cause an accident and result in death or serious injury.

■ **If you hear a squealing or scraping noise (brake pad wear limit indicators)**

Have the brake pads checked and replaced by your Toyota dealer as soon as possible.

Rotor damage may result if the pads are not replaced when needed.

It is dangerous to drive the vehicle when the wear limits of the brake pads and/or those of the brake discs are exceeded.

 **CAUTION**
**■ When the vehicle is stopped**

- Do not race the engine.  
If the vehicle is in any gear other than P (vehicles with an automatic transmission only) or N, the vehicle may accelerate suddenly and unexpectedly, causing an accident.
- Do not leave the vehicle with the engine running for a long time.  
If such a situation cannot be avoided, park the vehicle in an open space and check that exhaust fumes do not enter the vehicle interior.
- On vehicles with an automatic transmission, in order to prevent accidents due to the vehicle rolling away, always keep depressing the brake pedal while the engine is running, and apply the parking brake as necessary.
- If the vehicle is stopped on an incline, in order to prevent accidents caused by the vehicle rolling forward or backward, always depress the brake pedal and securely apply the parking brake as needed.
- Avoid revving or racing the engine.  
Running the engine at high speed while the vehicle is stopped may cause the exhaust system to overheat, which could result in a fire if combustible material is nearby.

**■ When the vehicle is parked**

- Do not leave glasses, cigarette lighters, spray cans, or soft drink cans in the vehicle when it is in the sun.  
Doing so may result in the following:
  - Gas may leak from a cigarette lighter or spray can, and may lead to a fire.
  - The temperature inside the vehicle may cause the plastic lenses and plastic material of glasses to deform or crack.
  - Soft drink cans may rupture, causing the contents to spray over the interior of the vehicle, and may also cause a short circuit in the vehicle's electrical components.
- Do not leave cigarette lighters in the vehicle. If a cigarette lighter is in a place such as the glove box or on the floor, it may be lit accidentally when luggage is loaded or the seat is adjusted, causing a fire.

 CAUTION

- Do not attach adhesive discs to the windshield or windows. Do not place containers such as air fresheners on the instrument panel or dashboard. Adhesive discs or containers may act as lenses, causing a fire in the vehicle.
- Do not leave a door or window open if the curved glass is coated with a metallized film such as a silver-colored one. Reflected sunlight may cause the glass to act as a lens, causing a fire.
- Always apply the parking brake, shift the shift lever to P (vehicles with an automatic transmission only), stop the engine and lock the vehicle. Do not leave the vehicle unattended while the engine is running.
- Do not touch the exhaust pipes while the engine is running or immediately after turning the engine off. Doing so may cause burns.
- Do not leave the engine running in an area with snow build-up, or where it is snowing. If snowbanks build up around the vehicle while the engine is running, exhaust gases may collect and enter the vehicle. This may lead to death or a serious health hazard.

■ Exhaust gases

Exhaust gases include harmful carbon monoxide (CO), which is colorless and odorless. Inhaling exhaust gases may lead to death or a serious health hazard.

- If the vehicle is in a poorly ventilated area, stop the engine. In a closed area, such as a garage, exhaust gases may collect and enter the vehicle. This may lead to death or a serious health hazard.
- The exhaust system should be checked occasionally. If there is a hole or crack caused by corrosion, damage to a joint or abnormal exhaust noise, be sure to have the vehicle inspected and repaired by your Toyota dealer. Failure to do so may allow exhaust gases to enter the vehicle, resulting in death or a serious health hazard.



 **CAUTION****■ When taking a nap in the vehicle**

Always turn the engine off. Otherwise, if you may accidentally move the shift lever or depress the accelerator pedal, this could cause an accident or fire due to engine overheating. Additionally, if the vehicle is parked in a poorly ventilated area, exhaust gases may collect and enter the vehicle, leading to death or a serious health hazard.

**■ When braking**

- When the brakes are wet, drive more cautiously.  
Braking distance increases when the brakes are wet, and this may cause one side of the vehicle to brake differently than the other side. Also, the parking brake may not securely hold the vehicle.
- If the power brake assist function does not operate, do not follow other vehicles closely and avoid hills or sharp turns that require braking.  
In this case, braking is still possible, but the brake pedal should be depressed more firmly than usual. Also, the braking distance will increase.
- Do not pump the brake pedal if the engine stalls.  
Each push on the brake pedal uses up the reserve for the power-assisted brakes.
- The brake system consists of 2 individual hydraulic systems; if one of the systems fails, the other will still operate. In this case, the brake pedal should be depressed more firmly than usual and the braking distance will increase.  
If this happens, do not continue to drive the vehicle. Have your brakes fixed immediately.

 NOTICE

■ **When driving the vehicle**

**Vehicles with an automatic transmission**

- Do not depress the accelerator and brake pedals at the same time during driving, as this may restrain driving torque.
- Do not use the accelerator pedal or depress the accelerator and brake pedals at the same time to hold the vehicle on a hill.

**Vehicles with a manual transmission**

- Do not depress the accelerator and brake pedals at the same time during driving, as this may restrain driving torque.
- Do not shift gears unless the clutch pedal is fully depressed. After shifting, do not release the clutch pedal abruptly. Doing so may damage the clutch, transmission and gears.
- Observe the following to prevent the clutch from being damaged.
  - Do not rest your foot on the clutch pedal while driving.  
Doing so may cause clutch trouble.
  - Do not use any gears other than the 1st gear when starting off and moving forward.  
Doing so may damage the clutch.
  - Do not use the clutch to hold the vehicle when stopping on an uphill grade.  
Doing so may damage the clutch.
- Do not shift the shift lever to R when the vehicle is still moving. Doing so may damage the clutch, transmission and gears.

■ **When parking the vehicle (vehicles with an automatic transmission)**

Always shift the shift lever to P. Failure to do so may cause the vehicle to move or the vehicle may accelerate suddenly if the accelerator pedal is accidentally depressed.

 NOTICE

**■ Avoiding damage to vehicle parts**

- Do not turn the steering wheel fully in either direction and hold it there for an extended period of time.  
Doing so may damage the power steering motor.
- When driving over bumps in the road, drive as slowly as possible to avoid damaging the wheels, underside of the vehicle, etc.

**■ If you get a flat tire while driving**

A flat or damaged tire may cause the following situations. Hold the steering wheel firmly and gradually depress the brake pedal to slow down the vehicle.

- It may be difficult to control your vehicle.
- The vehicle will make abnormal sounds or vibrations.
- The vehicle will lean abnormally.

Information on what to do in case of a flat tire. (→P. 315)

**■ When encountering flooded roads**

Do not drive on a road that has flooded after heavy rain etc. Doing so may cause the following serious damage to the vehicle:

- Engine stalling
- Short in electrical components
- Engine damage caused by water immersion

In the event that you drive on a flooded road and the vehicle is flooded, be sure to have your Toyota dealer check the following:

- Brake function
- Changes in quantity and quality of engine oil, and transmission fluid, etc.
- Lubricant condition for the bearings and suspension joints (where possible), and the function of all joints, bearings, etc.

## Engine (ignition) switch

### ■ Starting the engine

#### Vehicles with an automatic transmission

- STEP 1** Check that the parking brake is set.
- STEP 2** Check that the shift lever is set in P.
- STEP 3** Firmly depress the brake pedal.
- STEP 4** Turn the engine switch to the “START” position to start the engine.

#### Vehicles with a manual transmission

- STEP 1** Check that the parking brake is set.
- STEP 2** Check that the shift lever is set in N.
- STEP 3** Firmly depress the clutch pedal.
- STEP 4** Turn the engine switch to the “START” position to start the engine.

### ■ Changing the engine switch positions

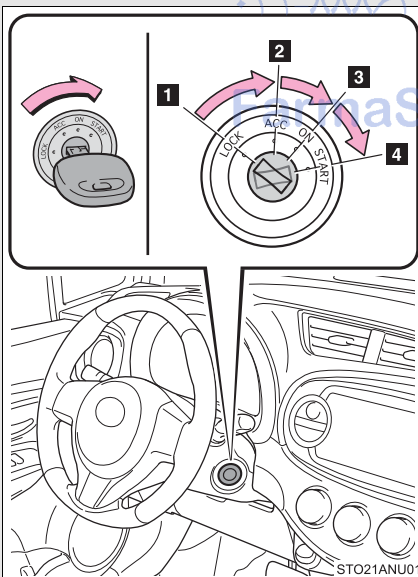

#### 1 “LOCK” تلفن شمس

The steering wheel is locked and the key can be removed. (Vehicles with an automatic transmission: The key can be removed only when the shift lever is in P.)

#### 2 “ACC”

Some electrical components such as the audio system can be used.

#### 3 “ON”

All electrical components can be used.

#### 4 “START”

For starting the engine.

## ■ Turning the key from “ACC” to “LOCK”

**STEP 1** Shift the shift lever to P (vehicles with an automatic transmission) or N (vehicles with a manual transmission). (→P. 127, 129)

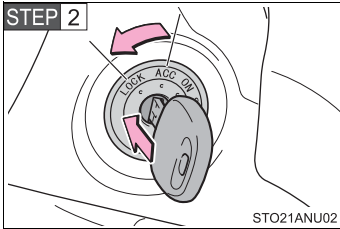

Push in the key and turn it to the “LOCK” position.

## ■ If the engine does not start (vehicles with an engine immobilizer system)

The engine immobilizer system may not have been deactivated. (→P. 72)

## ■ When the steering lock cannot be released

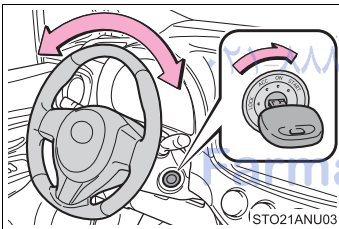

When starting the engine, the engine switch may seem stuck in the “LOCK” position. To free it, turn the key while turning the steering wheel slightly left and right.

## ■ Key reminder function

A buzzer sounds if the driver’s door is opened while the engine switch is in the “LOCK” or “ACC” position to remind you to remove the key.

 CAUTION

■ **When starting the engine**

Always start the engine while sitting in the driver's seat. Do not depress the accelerator pedal while starting the engine under any circumstances. Doing so may cause an accident resulting in death or serious injury.

■ **Caution while driving**

Do not turn the engine switch to the "LOCK" position while driving. If, in an emergency, you must turn the engine off while the vehicle is moving, turn the engine switch only to the "ACC" position to stop the engine. An accident may result if the engine is stopped while driving.

 NOTICE

■ **To prevent battery discharge**

Do not leave the engine switch in the "ACC" or "ON" position for long periods of time without the engine running.

■ **When starting the engine**

- Do not crank the engine for more than 30 seconds at a time. This may overheat the starter and wiring systems.
- Do not race a cold engine.
- If the engine becomes difficult to start or stalls frequently, have the engine checked immediately.

## 2-1. Driving procedures

### Automatic transmission\*

Select a shift position appropriate for the driving conditions.

#### ■ Shifting the shift lever

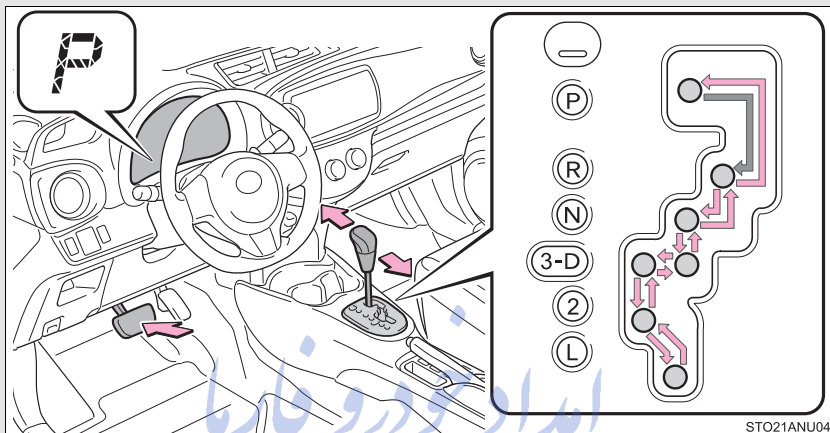

← While the engine switch is in the “ON” position, move the shift lever with the brake pedal depressed.

When shifting the shift lever between P and D, make sure that the vehicle is completely stopped.

#### ■ Shift position purpose

Shift position	Function
P	Parking the vehicle/starting the engine
R	Reversing
N	Neutral
D	Normal driving*
3	Position for engine braking
2	Position for more powerful engine braking
L	Position for maximum engine braking

\*: Shifting to the D position selects the most suitable gear for the particular driving condition. Setting the shift lever in the D position is recommended for normal driving.

\*: If equipped

### ■ Downshift restriction

The maximum allowable speeds are as follows.

Downshifting	Maximum speed mph (km/h)
3→2	53 (85)
2→L	25 (40)

### ■ AI-SHIFT

AI-SHIFT automatically selects the suitable gear according to driver performance and driving conditions.

AI-SHIFT automatically operates when the shift lever is in the D position.

When driving downhill, there may be cases where the vehicle shifts down automatically to obtain engine braking. As a result of the downshifting, the engine speed may increase.

### ■ When driving with the cruise control system (if equipped)

Engine braking will not occur when downshifting from D. (→P. 158)

### ■ If the shift lever cannot be shifted from P.

→P. 328

### ⚠ CAUTION

#### ■ When driving on slippery road surfaces

Do not accelerate or shift gears suddenly.

Sudden changes in engine braking may cause the vehicle to spin or skid, resulting in an accident.



## 2-1. Driving procedures

### Manual transmission\*

#### ■ Shifting the shift lever

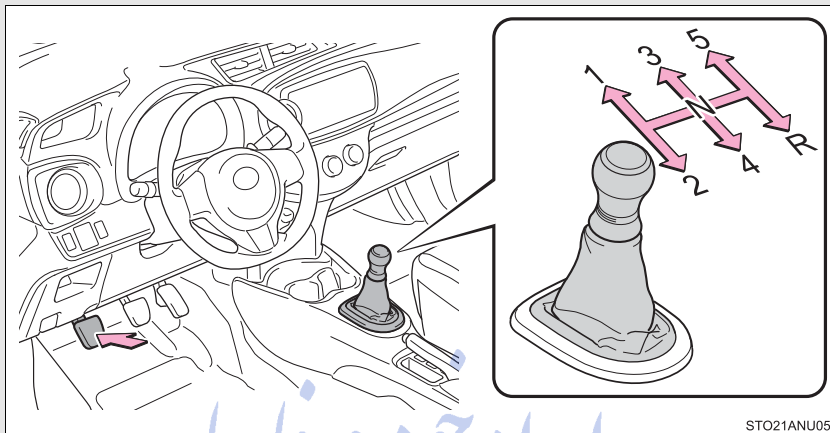

Fully depress the clutch pedal before operating the shift lever, and then release it slowly.

If it is difficult to shift in reverse, shift the shift lever to N, release the clutch pedal momentarily, and then try again. تلفن شبانه روزی: ۵

#### ■ Maximum downshifting speed

Observe the downshifting speeds in the following table to prevent over-revving the engine.

Shift position	Maximum speed mph (km/h)
1	30 (49)
2	57 (92)
3	83 (134)
4	113 (181)

\*: If equipped

## 2-1. Driving procedures

### Turn signal lever

The turn signal lever can be used to show the following intentions of the driver:

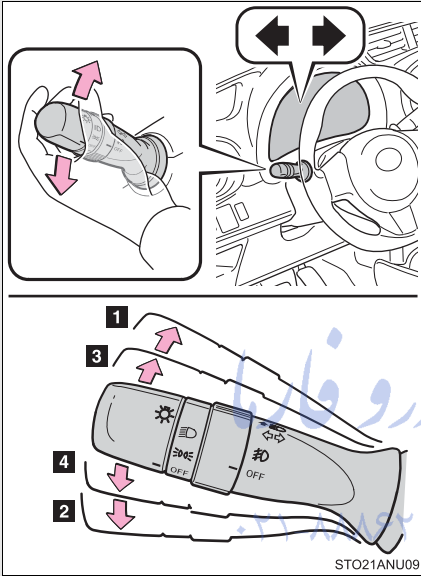

- 1 Right turn
- 2 Left turn
- 3 Lane change to the right (push and hold the lever partway)

The right hand signals will flash until you release the lever.

- 4 Lane change to the left (push and hold the lever partway)

The left hand signals will flash until you release the lever.

FarmaSOS.com

#### ■ Turn signals can be operated when

The engine switch is in the "ON" position.

#### ■ If the indicator flashes faster than usual

Check that a light bulb in the front or rear turn signal lights has not burned out.

## Parking brake

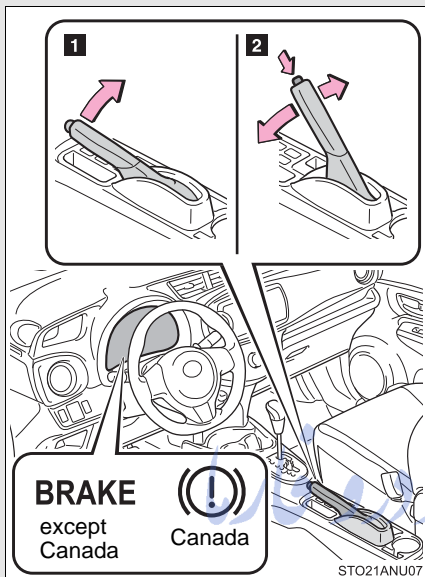

**1** To set the parking brake, fully pull the parking brake lever while depressing the brake pedal.

**2** To release the parking brake, slightly raise the lever and lower it completely while pressing the button.

تلفن شبانه روزی: ۰۲۱-۸۸۶۲۰۸۵

### ■ Usage in winter time

See "Winter driving tips" for parking brake usage in winter time. (→P. 172)

### ⚠ NOTICE

#### ■ Before driving

Fully release the parking brake.

Driving the vehicle with the parking brake set will lead to brake components overheating, which may affect braking performance and increase brake wear.

## 2-1. Driving procedures

### Horn

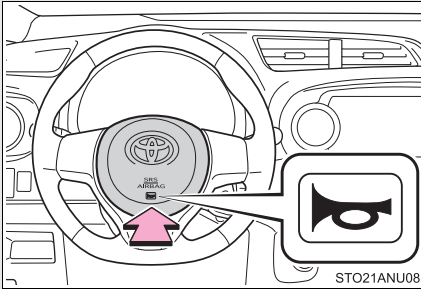

To sound the horn, press on or close to the  mark.

#### ■ After adjusting the steering wheel

Make sure that the steering wheel is securely locked.

The horn may not sound if the steering wheel is not securely locked.

(→P. 62)

تلفن شبانه روزی: ۰۲۱-۸۸۶۲۰۸۵

FarmaSOS.com

**Vehicles without a tachometer**

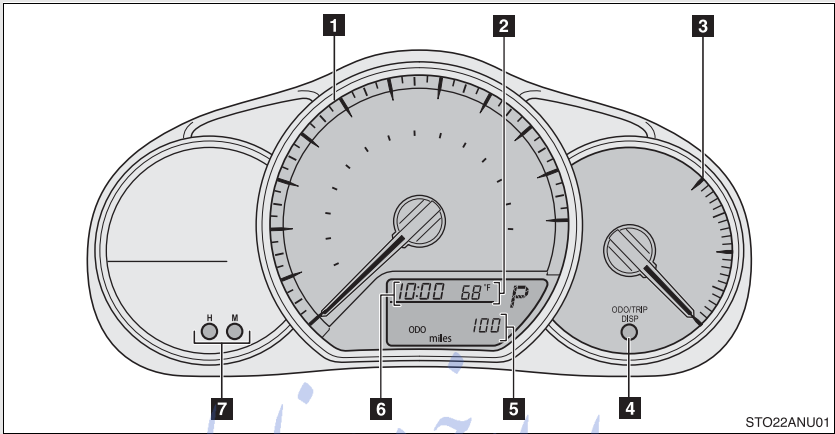

**1 Speedometer**

Displays the vehicle speed

**2 Outside temperature display**

→P. 211

**3 Fuel gauge**

Displays the quantity of fuel remaining in the tank

**4 Display change button**

→P. 140

**5 Odometer, trip meter and multi-information display**

→P. 140

**6 Clock**

→P. 210

**7 Clock adjusting buttons**

→P. 210

### Vehicles with a tachometer

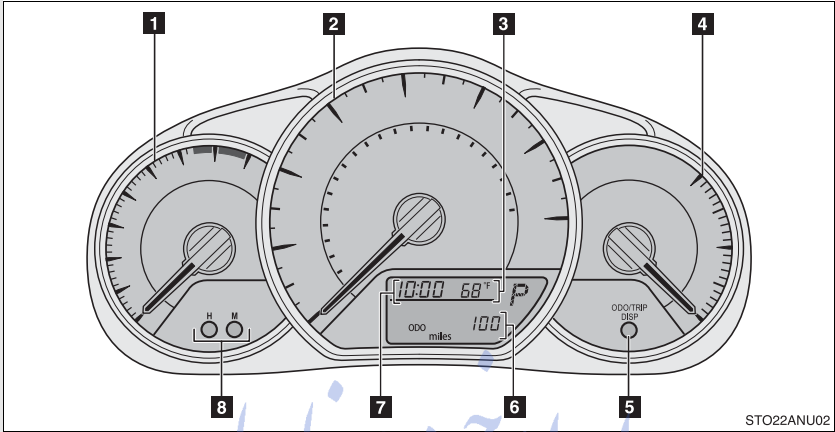

STO22ANU02

**1** Tachometer

Displays the engine speed in revolutions per minute

**2** Speedometer

Displays the vehicle speed

**3** Outside temperature display

→P. 211

**4** Fuel gauge

Displays the quantity of fuel remaining in the tank

**5** Display change button

→P. 140

**6** Odometer, trip meter and multi-information display

→P. 140

**7** Clock

→P. 210

**8** Clock adjusting buttons

→P. 210

## Instrument panel light control

The brightness of the instrument panel lights can be adjusted by turning the dial.

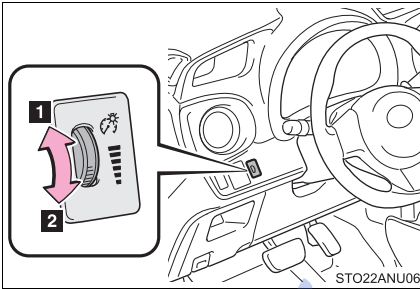

1 Brighter

2 Darker

### ■ The meters and display operate when

The engine switch is in the "ON" position.

#### ⚠ NOTICE

#### ■ To prevent damage to the engine and its components

- On vehicles with a tachometer, do not let the indicator needle of the tachometer enter the red zone, which indicates the maximum engine speed.
- The engine may be overheating if the high engine coolant temperature warning light flashes or comes on. In this case, immediately stop the vehicle in a safe place, and check the engine after it has cooled completely. (→P. 334)

# Indicators and warning lights

The indicators and warning lights on the instrument cluster, center panel and dashboard inform the driver of the status of the vehicle's various systems.

## Instrument cluster (vehicles without a tachometer)

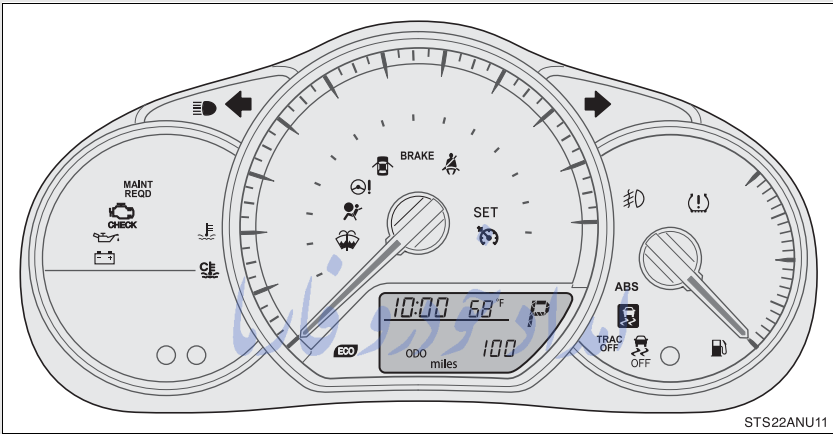

## Instrument cluster (vehicles with a tachometer)

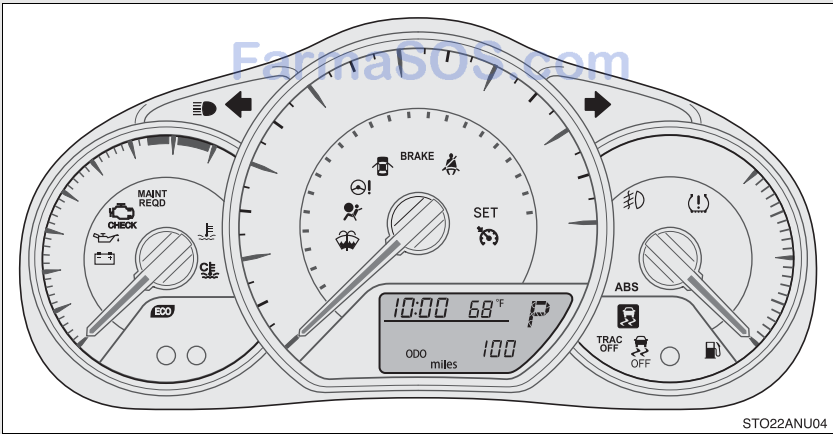



### Center panel

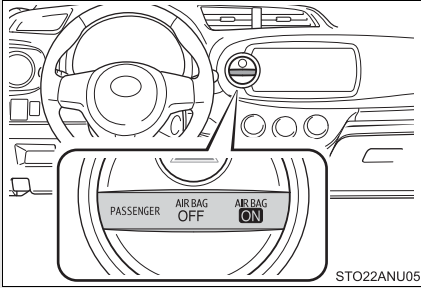

### Dashboard

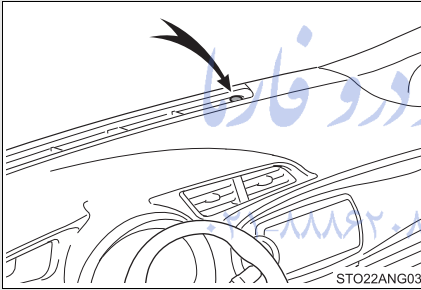

FarmaSOS.com

## ■ Indicators

The indicators inform the driver of the operating state of the vehicle's various systems.



Turn signal indicator  
(→P. 130)



Headlight high beam indicator (→P. 146)



(if equipped)

Front fog light indicator  
(→P. 148)



Low engine coolant temperature indicator  
Indicates the engine coolant temperature is cool.



(if equipped)

Engine immobilizer/alarm system indicator  
(→P. 72, 74)



(vehicles with an automatic transmission)

Eco Driving Indicator Light (→P. 115)



(vehicles with an automatic transmission)

Shift position and shift range indicator  
(→P. 127)



(if equipped)

Cruise control indicator  
(→P. 158)



(if equipped)

Cruise control "SET" indicator (→P. 158)



\*1,2

Slip indicator (→P. 163)



\*1

VSC OFF indicator  
(→P. 164)



\*1

"TRAC OFF" indicator  
(→P. 163)



\*1

"AIR BAG ON" indicator  
(→P. 92)



\*1

"AIR BAG OFF" indicator (→P. 92)

\*1: These lights turn on when the engine switch is turned to the "ON" position to indicate that a system check is being performed. They will turn off after the engine is started, or after a few seconds. There may be a malfunction in a system if a light does not come on, or if the lights do not turn off. Have the vehicle inspected by your Toyota dealer.

\*2: The light flashes to indicate that the system is operating.

## ■ Warning lights

Warning lights inform the driver of malfunctions in any of the vehicle's systems. (→P. 305)

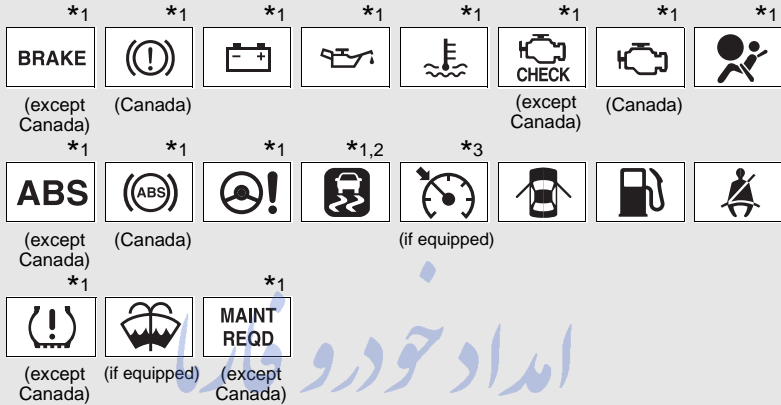

\*1: These lights turn on when the engine switch is turned to the “ON” position to indicate that a system check is being performed. They will turn off after the engine is started, or after a few seconds. There may be a malfunction in a system if a light does not come on, or if the lights do not turn off. Have the vehicle inspected by your Toyota dealer.

\*2: The light flashes to indicate that the system is operating and come on to indicate a malfunction.

\*3: The light flashes to indicate a malfunction.

### ⚠ CAUTION

#### ■ If a safety system warning light does not come on

Should a safety system light such as the ABS and SRS warning light not come on when you start the engine, this could mean that these systems are not available to help protect you in an accident, which could result in death or serious injury. Have the vehicle inspected by your Toyota dealer immediately if this occurs.

## Multi-information display

The multi-information display presents the driver with a variety of driving-related data.

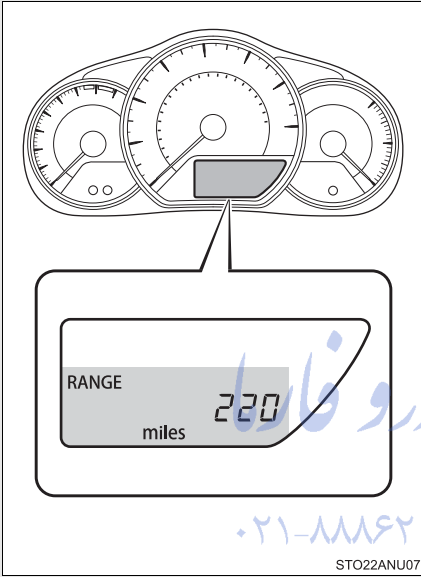

● Odometer (→P. 141)

● Trip meter (→P. 141)

● Trip information (→P. 141)

Displays driving range, fuel consumption and other cruising-related information.

● Eco Driving Indicator Light customization (vehicles with an automatic transmission) (→P. 143)

تلفن شبانه روزی: ۰۲۱-۸۸۶۲۰۸۵

FarmaSOS.com

### Changing the display

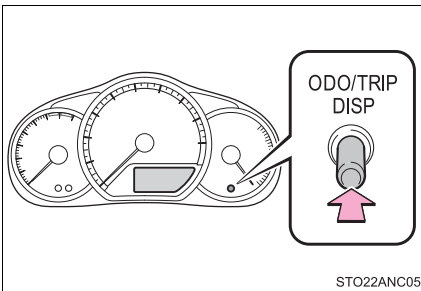

Items displayed can be switched by pressing the display change button.

## Display items

### ■ Odometer

#### Except Canada



Displays the total distance the vehicle has been driven.

#### Canada



### ■ Trip meter

#### Except Canada



Displays the distance the vehicle has been driven since the meter was last reset. Trip meters "A" and "B" can be used to record and display different distances independently.



Pressing and holding the display change button will reset the trip meter that is currently displayed.

#### Canada



### ■ Instantaneous fuel consumption

**Except Canada** Displays instantaneous fuel consumption.



**Canada**



### ■ Average fuel consumption

**Except Canada** Displays the average fuel consumption since the function was reset.

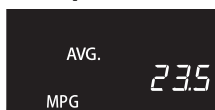

**Canada**

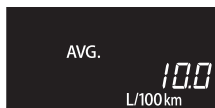

- The function can be reset by pressing and holding the display change button when the average fuel consumption is displayed.
- Use the displayed average fuel consumption as a reference.

FarmaSOS.com

## ■ Driving range

### Except Canada

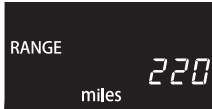

### Canada



Displays the estimated maximum distance that can be driven with the quantity of fuel remaining.

- This distance is computed based on your average fuel consumption. As a result, the actual distance that can be driven may differ from that displayed.
- When only a small amount of fuel is added to the tank, the display may not be updated. When adding fuel, turn the engine switch to the “LOCK” position. In case fuel is added without turning the engine switch to the “LOCK” position, the display may not be updated.

## ■ Average vehicle speed

### Except Canada



### Canada



Displays the average vehicle speed since the engine was started or the function was reset.

تلفن شبانه روزی: ۲۱-۸۸۶۲۰۸۵

FarmaSOS.com

## Eco Driving Indicator Light customization (vehicles with an automatic transmission)



Eco Driving Indicator Light can be activated or deactivated by pressing the display change button when the Eco Driving Indicator Light customization display is displayed.

To change the Eco Driving Indicator Light customization display, display the odometer and press and hold the button until the display changes.

### ■ When disconnecting and reconnecting battery terminals

The following information data will be reset:

- Average fuel consumption
- Driving range
- Average vehicle speed



### NOTICE

### ■ The multi-information display at low temperatures

Allow the interior of the vehicle to warm up before using the liquid crystal information display. At extremely low temperatures, the information display monitor may respond slowly, and display changes may be delayed.

تلفن شبانه روزی: ۰۲۱-۸۸۶۲۰۸۵

FarmaSOS.com



## 2-3. Operating the lights and wipers Headlight switch

The headlights can be operated manually.

Turning the end of the lever turns on the lights as follows:

### Type A



#### 1 OFF OFF

Vehicles with daytime running light system:  
The daytime running lights turn on.

#### 2

The side marker, parking, tail, license plate, daytime running lights (if equipped) and instrument panel lights turn on.

#### 3

The headlights and all lights listed above (except daytime running lights) turn on.

### Type B

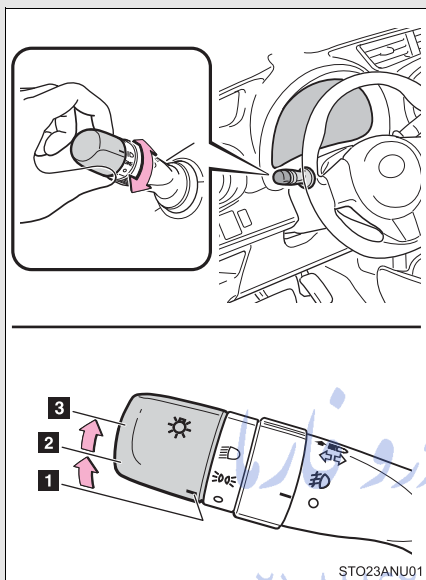

**1** ○ Off

Vehicles with daytime running light system:  
The daytime running lights turn on.

**2** ☰☽☷ The side marker, parking, tail, license plate, daytime running lights (if equipped) and instrument panel lights turn on.

**3** ☰☽☷ The headlights and all lights listed above (except daytime running lights) turn on.

### Turning on the high beam headlights

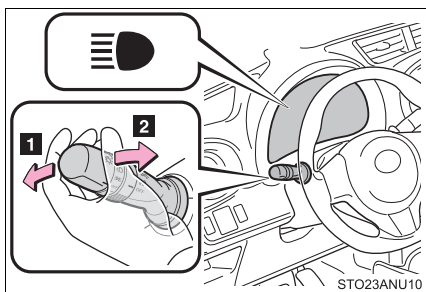

**1** With the headlights on, push the lever away from you to turn on the high beams.

Pull the lever toward you to the center position to turn the high beams off.

**2** Pull the lever toward you and release it to flash the high beams once.

You can flash the high beams with the headlights on or off.

### ■ Daytime running light system (if equipped)

- To make your vehicle more visible to other drivers, the headlights turn on automatically (at a reduced intensity) whenever the engine is started and the parking brake is released. Daytime running lights are not designed for use at night.
- Compared to turning on the headlights, the daytime running light system offers greater durability and consumes less electricity, so it can help improve fuel economy.

### ■ Light reminder buzzer

A buzzer sounds when the engine switch is turned to the "LOCK" or "ACC" position and the driver's door is opened while the lights are turned on.

### ■ Battery-saving function (vehicles with an alarm system or daytime running light system)

In all following conditions, the headlights and the other remaining lights will go off automatically after 20 minutes in order to prevent the vehicle battery from being discharged:

- The engine switch is in the "LOCK" position.
- The headlights and/or tail lights are on.

This function will be canceled in any of the following situations:

- When the engine switch is turned to the "ON" position.
- When the light switch is operated.
- When the door is opened or closed.

### NOTICE

#### ■ To prevent battery discharge

Do not leave the lights on longer than necessary when the engine is not running.

## 2-3. Operating the lights and wipers Fog light switch\*

The fog lights secure excellent visibility in difficult driving conditions, such as in rain and fog.

### Type A

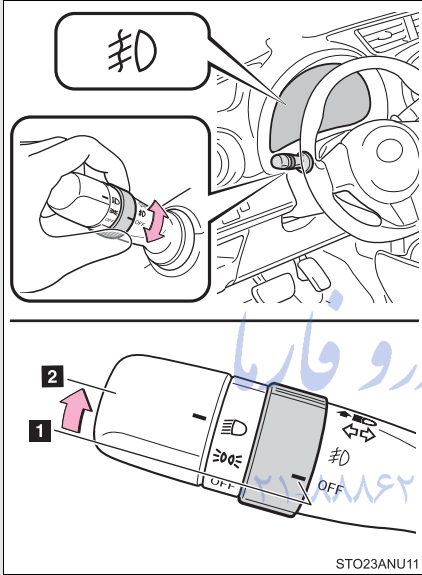

- 1 OFF** Turns the front fog lights off
- 2 ON** Turns the front fog lights on

FarmaSOS.com

\*: If equipped

## Type B

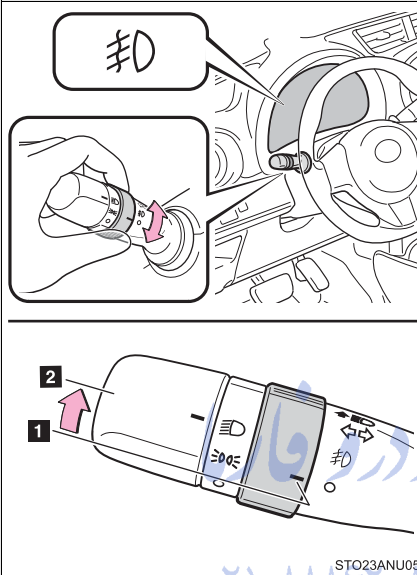

- 1 ○ Turns the front fog lights off
- 2 #D Turns the front fog lights on

■ Fog lights can be used when

The headlights are on in low beam.

## 2-3. Operating the lights and wipers Windshield wiper and washer

The wiper operation is selected by moving the lever as follows:

### Type A

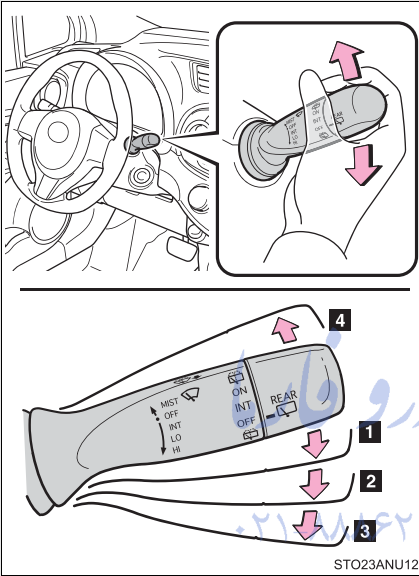

- 1 INT** Intermittent windshield wiper operation
- 2 LO** Low speed windshield wiper operation
- 3 HI** High speed windshield wiper operation
- 4 MIST** Temporary operation

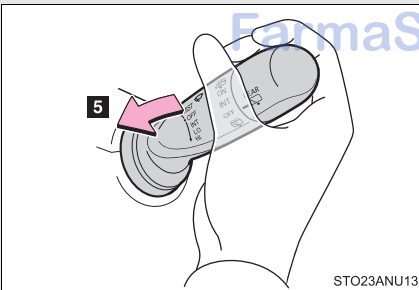



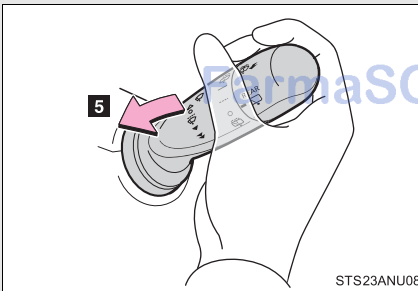
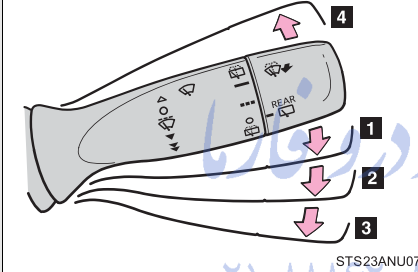
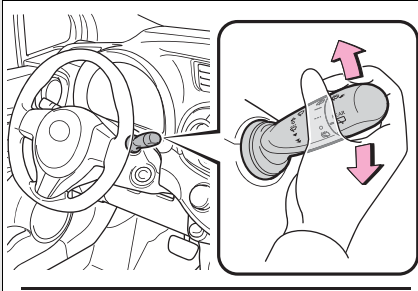

- 5 Washer/wiper dual operation**

The wipers will automatically operate a couple of times after the washer squirts.

## Type B



- 1  Intermittent windshield wiper operation
- 2  Low speed windshield wiper operation
- 3  High speed windshield wiper operation
- 4  Temporary operation

- 5 Washer/wiper dual operation

The wipers will automatically operate a couple of times after the washer squirts.

■ The windshield wiper and washer can be operated when

The engine switch is in the "ON" position.

■ If no windshield washer fluid sprays

Check that the washer nozzles are not blocked if there is washer fluid in the windshield washer fluid reservoir.

 NOTICE

■ **When the windshield is dry**

Do not use the wiper, as they may damage the windshield.

■ **When the washer fluid tank is empty**

Do not operate the switch continually as the washer fluid pump may over-heat.

■ **When a nozzle becomes blocked**

In this case, contact your Toyota dealer.

Do not try to clear it with a pin or other object. The nozzle will be damaged.

امداد خودرو فارما

تلفن شبانه روزی: ۰۲۱-۸۸۶۲۰۸۵

FarmaSOS.com





## Rear window wiper and washer\*

The wiper operation is selected by moving the lever as follows:

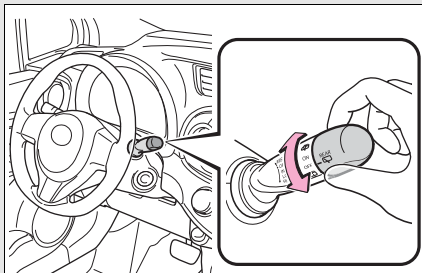
### Vehicles without intermittent rear wiper (Type A)





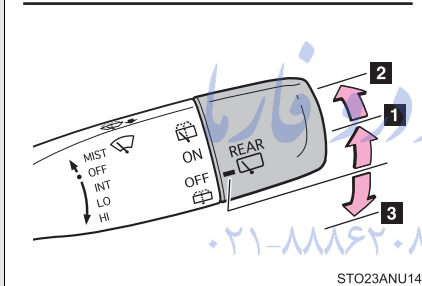

- 1 ON** Normal window wiper operation
- 2**  Washer/wiper dual operation
- 3**  Washer operation

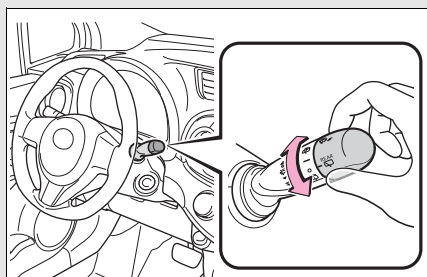

FarmaSOS.com

### Vehicles without intermittent rear wiper (Type B)



- 1**  Normal window wiper operation
- 2**  Washer/wiper dual operation
- 3**  Washer operation

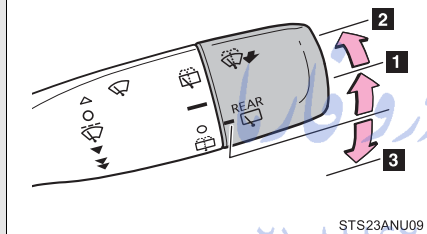



امداد خودرو  
تلفن شبانه روزی: ۰۸۵-۸۸۸۸۸۸۸۸-۲۱

FarmaSOS.com

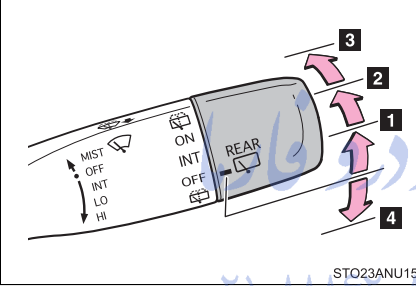
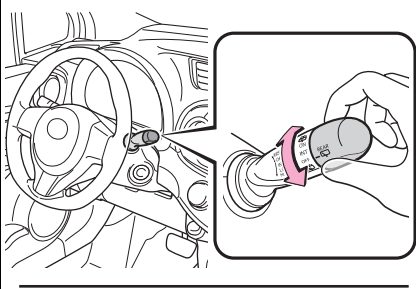
### Vehicles with intermittent rear wiper (Type A)



- 1 **INT** Intermittent window wiper operation
- 2 **ON** Normal window wiper operation
- 3  Washer/wiper dual operation
- 4  Washer/wiper dual operation

The wiper will automatically operate a couple of time after the wiper squirts.



STO23ANU15

تلفن شبانه روزی: ۰۲۱-۸۸۷۶۰۸۵

FarmaSOS.com

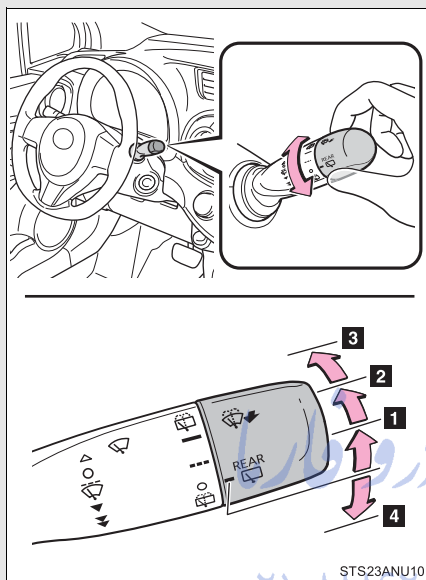
### Vehicles with intermittent rear wiper (Type B)



- 1 ■■■ Intermittent window wiper operation
- 2 — Normal window wiper operation
- 3  Washer/wiper dual operation
- 4  Washer/wiper dual operation

The wiper will automatically operate a couple of time after the wiper squirts.

#### ■ The rear window wiper and washer can be operated when

The engine switch is in the “ON” position.

#### ■ If no washer fluid sprays

Check that the washer nozzle is not blocked, if there is washer fluid in the washer fluid reservoir.

**NOTICE****■ When the rear window is dry**

Do not use the wipers, as it may damage the rear window.

**■ When the washer fluid tank is empty**

Do not operate the switch continually as the washer fluid pump may over-heat.

**■ When a nozzle becomes blocked**

In this case, contact your Toyota dealer.

Do not try to clear it with a pin or other object. The nozzle will be damaged.

امداد خودرو فارما

تلفن شبانه روزی: ۰۲۱-۸۸۶۲۰۸۵

FarmaSOS.com

## 2-4. Using other driving systems Cruise control\*

Use the cruise control to maintain a set speed without depressing the accelerator pedal.

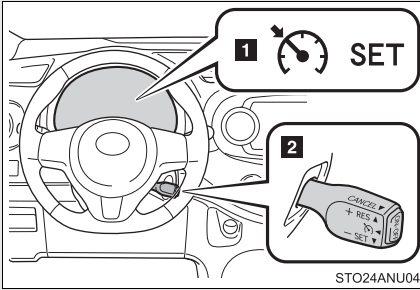

1 Indicators

2 Cruise control switch

### ■ Setting the vehicle speed

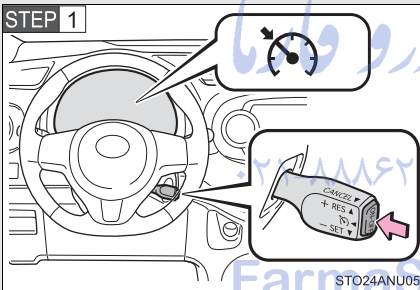

Press the “ON-OFF” button to activate the cruise control.

Cruise control indicator will come on.

Press the button again to deactivate the cruise control.

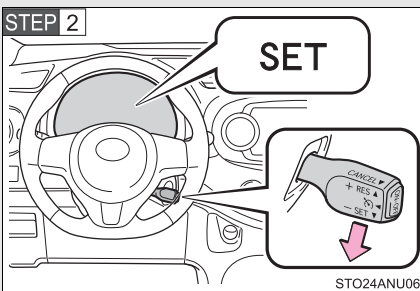

Accelerate or decelerate the vehicle to the desired speed, and push the lever down to set the speed.

“SET” indicator will come on.

The vehicle speed at the moment the lever is released becomes the set speed.

\*: If equipped

### ■ Adjusting the set speed

To change the set speed, operate the lever until the desired set speed is obtained.

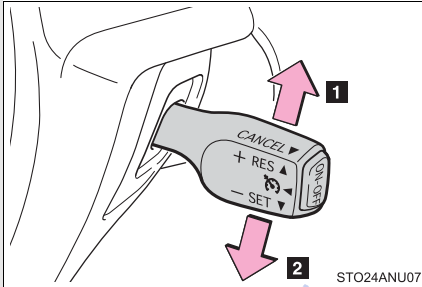

- 1 Increases the speed
- 2 Decreases the speed

Fine adjustment: Momentarily move the lever in the desired direction.

Large adjustment: Hold the lever in the desired direction.

The set speed will be increased or decreased as follows:

Fine adjustment: By approximately 1 mph (1.6 km/h) each time the lever is operated.

Large adjustment: The set speed can be increased or decreased continually until the lever is released.

### ■ Canceling and resuming the constant speed control

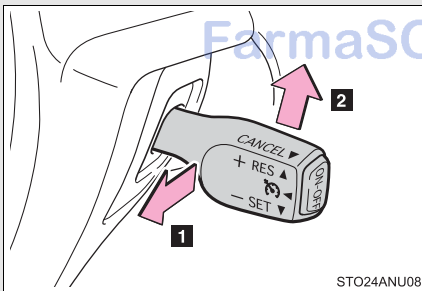

- 1 Pulling the lever toward you cancels the constant speed control.

The speed setting is also canceled when the brakes are applied or the clutch pedal (manual transmission only) is depressed.

- 2 Pushing the lever up resumes the constant speed control.

Resuming is available when the vehicle speed is more than approximately 25 mph (40 km/h).

■ **Cruise control can be set when**

- The shift lever is in the D or range 3. (vehicles with an automatic transmission)
- Vehicle speed is above approximately 25 mph (40 km/h).

■ **Accelerating after setting the vehicle speed**

- The vehicle can be accelerated normally. After acceleration, the set speed resumes.
- Even without canceling the cruise control, the set speed can be increased by first accelerating the vehicle to the desired speed and then pushing the lever down to set the new speed.

■ **Automatic cruise control cancelation**

Cruise control will stop maintaining the vehicle speed in any of the following situations.

- Actual vehicle speed falls more than approximately 10 mph (16 km/h) below the preset vehicle speed.  
At this time, the memorized set speed is not retained.
- Actual vehicle speed is below approximately 25 mph (40 km/h).
- VSC is activated.

■ **If the cruise control indicator light flashes**

Press the “ON-OFF” button once to deactivate the system, and then press the button again to reactivate the system.

If the cruise control speed cannot be set or if the cruise control cancels immediately after being activated, there may be a malfunction in the cruise control system. Have the vehicle inspected by your Toyota dealer.



 CAUTION

■ **To avoid operating the cruise control by mistake**

Switch the cruise control off using the “ON-OFF” button when not in use.

■ **Situations unsuitable for cruise control**

Do not use cruise control in any of the following situations.

Doing so may result in loss of control and could cause an accident resulting in death or serious injury.

- In heavy traffic
- On roads with sharp bends
- On winding roads
- On slippery roads, such as those covered with rain, ice or snow
- On steep hills  
Vehicle speed may exceed the set speed when driving down a steep hill.
- When your vehicle is towing a trailer or during emergency towing

تلفن شبانه روزی: ۰۲۱-۸۸۶۲۰۸۵

FarmaSOS.com

## Driving assist systems

To help enhance driving safety and performance, the following systems operate automatically in response to various driving situations. Be aware, however, that these systems are supplementary and should not be relied upon too heavily when operating the vehicle.

### ■ ABS (Anti-lock Brake System)

Helps to prevent wheel lock when the brakes are applied suddenly, or if the brakes are applied while driving on a slippery road surface.

### ■ Brake assist

Generates an increased level of braking force after the brake pedal is depressed when the system detects a panic stop situation.

### ■ VSC (Vehicle Stability Control)

Helps the driver to control skidding when swerving suddenly or turning on slippery road surfaces.

### ■ TRAC (Traction Control)

Helps to maintain drive power and prevent the drive wheels from spinning when starting the vehicle or accelerating on slippery roads.

### ■ EPS (Electric Power Steering)

Employs an electric motor to reduce the amount of effort needed to turn the steering wheel.

### When the TRAC/VSC systems are operating

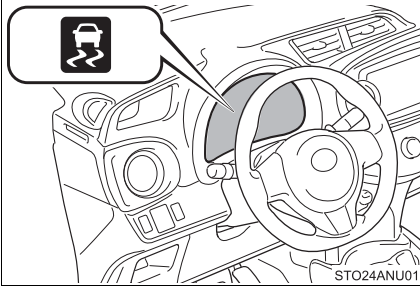

The slip indicator light flashes to indicate that the TRAC/VSC systems have been engaged.

### Disabling the TRAC/VSC systems

If the vehicle gets stuck in fresh snow or mud, TRAC/VSC systems may reduce power from the engine to the wheels. You may need to turn the system off to enable you to rock the vehicle in order to free it.

#### ■ Turning off the TRAC system only

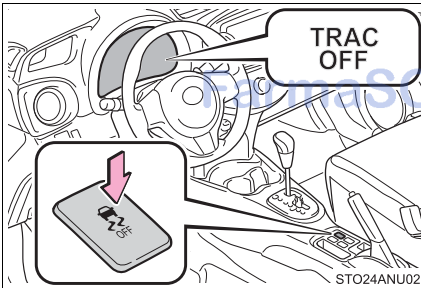

To turn the TRAC system off, quickly press and release the button.

The “TRAC OFF” indicator light will come on.

Press the button again to turn the system back on.

### ■ Turning off both TRAC and VSC systems

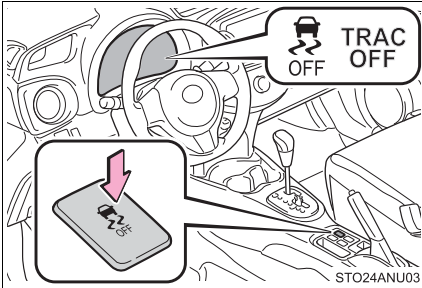

To turn the TRAC and VSC systems off, press and hold the button for more than 3 seconds while the vehicle is stopped.

The “TRAC OFF” indicator light and VSC OFF indicator light will come on.

Press the button again to turn the systems back on.

### ■ When the “TRAC OFF” indicator light comes on even if the VSC OFF switch has not been pressed

TRAC system cannot be operated. Contact your Toyota dealer.

### ■ Sounds and vibrations caused by the ABS, brake assist, VSC and TRAC

- A sound may be heard from the engine compartment when the engine is started or just after the vehicle begins to move. This sound does not indicate that a malfunction has occurred in any of these systems.
- Any of the following conditions may occur when the above systems are operating. None of these indicates that a malfunction has occurred.
  - Vibrations may be felt through the vehicle body and steering.
  - A motor sound may be heard after the vehicle comes to a stop.
  - The brake pedal may pulsate slightly after the ABS is activated.
  - The brake pedal may move down slightly after the ABS is activated.

### ■ EPS operation sound

When the steering wheel is operated, a motor sound (whirring sound) may be heard. This does not indicate a malfunction.

### ■ Reactivation of the TRAC/VSC systems after turning off the engine

Turning off the engine after turning off the TRAC/VSC systems will automatically reactivate them.

### ■ Reactivation of the TRAC system linked to vehicle speed

When only the TRAC system is turned off, the TRAC system will turn on when vehicle speed increases. However, when both TRAC and VSC systems are turned off, the systems will not turn on even when vehicle speed increases.

### ■ Reduced effectiveness of the EPS system

The effectiveness of the EPS system is reduced to prevent the system from overheating when there is frequent steering input over an extended period of time. The steering wheel may feel heavy as a result. Should this occur, refrain from excessive steering input or stop the vehicle and turn the engine off. The EPS system should return to normal within 10 minutes.

### ■ If the slip indicator comes on...

It may indicate a malfunction in the driving assist systems. Contact your Toyota dealer.

## ⚠ CAUTION

### ■ The ABS does not operate effectively when

- The limits of tire gripping performance have been exceeded (such as excessively worn tires on a snow covered road).
- The vehicle hydroplanes while driving at high speed on the wet or slick roads.

### ■ Stopping distance when the ABS is operating may exceed that of normal conditions

The ABS is not designed to shorten the vehicle's stopping distance. Always maintain a safe distance from the vehicle in front of you, especially in the following situations:

- When driving on dirt, gravel or snow-covered roads
- When driving with tire chains
- When driving over bumps in the road
- When driving over roads with potholes or roads with uneven surfaces

 CAUTION

■ **TRAC may not operate effectively when**

Directional control and power may not be achievable while driving on slippery road surfaces, even if the TRAC system is operating.

Be especially careful and drive the vehicle in conditions where stability and power may be lost.

■ **When the VSC is activated**

The slip indicator flashes. Always drive carefully. Reckless driving may cause an accident. Exercise particular care when the indicator light flashes.

■ **When the TRAC/VSC systems are turned off**

Be especially careful and drive at a speed appropriate to the road conditions. Do not turn the TRAC/VSC systems off unless necessary, as these are the systems to ensure vehicle stability and driving force by automatically controlling braking and engine outputs.

■ **Replacing tires**

Observe the following precautions.

Failure to do so may cause the ABS, VSC and TRAC systems not to function correctly.

- Make sure that all tires are of the specified size, brand, tread pattern and total load capacity.
- Do not use tires of noticeably different wear level.
- Make sure that the tires are inflated to the recommended tire inflation pressure level. (→P. 351)

Contact your Toyota dealer for further information when replacing tires or wheels.

■ **Handling of tires and the suspension**

Using tires with any kind of problem or modifying the suspension will affect the driving assist systems, and may cause a system to malfunction.

## 2-5. Driving information

# Cargo and luggage

### Take notice of the following information about storage precautions, cargo capacity and load:

- Stow cargo and luggage in the luggage compartment whenever possible.
- Be sure all items are secured in place.
- To maintain vehicle balance while driving, position luggage evenly within the luggage compartment.
- For better fuel economy, do not carry unnecessary weight.

### Capacity and distribution

Cargo capacity depends on the total weight of the occupants.

(Cargo capacity) = (Total load capacity) – (Total weight of occupants)

#### Steps for Determining Correct Load Limit—

- (1) Locate the statement “The combined weight of occupants and cargo should never exceed XXX kg or XXX lbs.” on your vehicle’s placard.
- (2) Determine the combined weight of the driver and passengers that will be riding in your vehicle.
- (3) Subtract the combined weight of the driver and passengers from XXX kg or XXX lbs.
- (4) The resulting figure equals the available amount of cargo and luggage load capacity.  
For example, if the “XXX” amount equals 1400 lbs. and there will be five 150 lb passengers in your vehicle, the amount of available cargo and luggage load capacity is 650 lbs. (1400 – 750 (5 × 150) = 650 lbs.)
- (5) Determine the combined weight of luggage and cargo being loaded on the vehicle. That weight may not safely exceed the available cargo and luggage load capacity calculated in Step 4.

(6) If your vehicle will be towing a trailer, load from your trailer will be transferred to your vehicle. Consult this manual to determine how this reduces the available cargo and luggage load capacity of your vehicle.

Except 3-door models for Canada:

Toyota does not recommend towing a trailer with your vehicle. Your vehicle is not designed for trailer towing.

**Calculation formula for your vehicle**

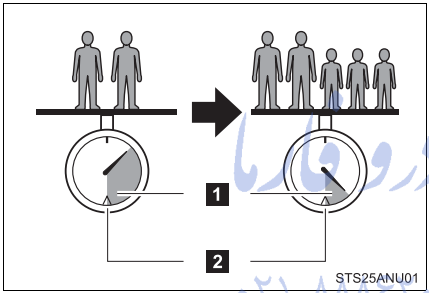

- 1** Cargo capacity
- 2** Total load capacity (vehicle capacity weight) (→P. 342)

When 2 people with the combined weight of A lb. (kg) are riding in your vehicle, which has a total load capacity (vehicle capacity weight) of B lb. (kg), the available amount of cargo and luggage load capacity will be C lb. (kg) as follows:

$$B^{*2} \text{ lb. (kg)} - A^{*1} \text{ lb. (kg)} = C^{*3} \text{ lb. (kg)}$$

- \*1: A = Weight of people
- \*2: B = Total load capacity
- \*3: C = Available cargo and luggage load

In this condition, if 3 more passengers with the combined weight of D lb. (kg) get on, the available cargo and luggage load will be reduced E lb. (kg) as follows:

$$C \text{ lb. (kg)} - D^{*4} \text{ lb. (kg)} = E^{*5} \text{ lb. (kg)}$$

- \*4: D = Additional weight of people
- \*5: E = Available cargo and luggage load



As shown in the example above, if the number of occupants increases, the cargo and luggage load will be reduced by an amount that equals the increased weight due to the additional occupants. In other words, if an increase in the number of occupants causes an excess of the total load capacity (combined weight of occupants plus cargo and luggage load), you must reduce the cargo and luggage on your vehicle.

### CAUTION

#### ■ Things that must not be carried in the luggage compartment

The following things may cause a fire if loaded in the luggage compartment:

- Receptacles containing gasoline
- Aerosol cans

#### ■ Storage precautions

Observe the following precautions.

Failure to do so may result in death or serious injury.

- Stow cargo and luggage in the luggage compartment whenever possible.
- Do not stack cargo and luggage in the luggage compartment higher than the seatbacks.  
Such items may be thrown about and possibly injure people in the vehicle in the event of sudden braking or in an accident.
- Do not place cargo or luggage in or on the following locations as the item may get under the clutch, brake or accelerator pedal and prevent the pedals from being depressed properly, block the driver's vision, or hit the driver or passengers, causing an accident:
  - At the feet of the driver
  - On the front passenger or rear seats (when stacking items)
  - On the luggage cover
  - On the instrument panel
  - On the dashboard
- Secure all items in the occupant compartment, as they may shift and injure someone in the event of an accident or sudden braking.

 CAUTION

- When you fold down the rear seats, long items should not be placed directly behind the front seats.
- Never allow anyone to ride in the luggage compartment. It is not designed for passengers. They should ride in their seats with their seat belts properly fastened. Otherwise, they are much more likely to suffer death or serious bodily injury, in the event of sudden braking or an accident.

■ **Capacity and distribution**

- Do not exceed the maximum axle weight rating or the total vehicle weight rating.
- Even if the total load of occupant's weight and the cargo load is less than the total load capacity, do not apply the load unevenly. Improper loading may cause deterioration of steering or braking control which may cause death or serious injury.

تلفن شبانه روزی: ۰۲۱-۸۸۶۲۰۸۵

FarmaSOS.com

**Vehicle load limits include total load capacity, seating capacity, towing capacity and cargo capacity.**

■ **Total load capacity (vehicle capacity weight): (→P. 342)**

Total load capacity means the combined weight of occupants, cargo and luggage.

■ **Seating capacity: 5 occupants (Front 2, Rear 3)**

Seating capacity means the maximum number of occupants whose estimated average weight is 150 lb. (68 kg) per person.

■ **Towing capacity (3-door models for Canada): (→P. 342)**

Towing capacity means the maximum gross trailer weight (trailer weight plus its cargo weight) that your vehicle is able to tow.

■ **Towing capacity (except 3-door models for Canada)**

Toyota does not recommend towing a trailer with your vehicle.

■ **Cargo capacity**

Cargo capacity may increase or decrease depending on the weight and the number of occupants.

FarmaSOS.com

■ **Total load capacity and seating capacity**

These details are also described on the tire and loading information label.(→P. 262)

**⚠ CAUTION**

■ **Overloading the vehicle**

Do not overload the vehicle.

It may not only cause damage to the tires, but also degrade steering and braking ability, resulting in an accident.

## 2-5. Driving information

### Winter driving tips

**Carry out the necessary preparations and inspections before driving the vehicle in winter. Always drive the vehicle in a manner appropriate to the prevailing weather conditions.**

#### ■ Pre-winter preparations

- Use fluids that are appropriate to the prevailing outside temperatures.
  - Engine oil
  - Engine coolant
  - Washer fluid
- Have a service technician inspect the level and specific gravity of battery electrolyte.
- Have the vehicle fitted with four snow tires or purchase a set of tire chains for the front tires.

Ensure that all tires are the same size and brand and that their wear level is not noticeably different with each other. Also make sure that chains match the size of the tires. تلفن شبانه روزی: ۸۵

#### ■ Before driving the vehicle

Perform the following according to the driving conditions:

- Do not try to forcibly open a window or move a wiper that is frozen. Pour warm water over the frozen area to melt the ice. Wipe away the water immediately to prevent it from freezing.
- To ensure proper operation of the climate control system fan, remove any snow that has accumulated on the air inlet vents in front of the windshield.
- Remove any ice that has accumulated on the vehicle chassis.
- Periodically check for and remove any excess ice or snow that may have accumulated in the wheel well or on the brakes.

### ■ When driving the vehicle

Accelerate the vehicle slowly and drive at a reduced speed suitable to the road conditions.

### ■ When parking the vehicle (in the winter time or in the cold latitudes)

Park the vehicle and move the shift lever to P (vehicles with an automatic transmission) or 1 or R (vehicles with a manual transmission) without setting the parking brake. The parking brake may freeze up, preventing it from being released. If necessary, block the wheels to prevent inadvertent sliding or creeping.

## Selecting tire chains

Use the correct tire chain size when mounting the tire chains. Chain size is regulated for each tire size.

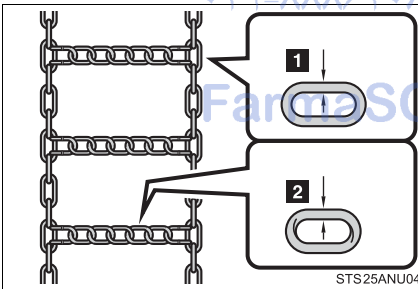

- 1 Side chain  
3 mm (0.12 in.) in diameter
- 2 Cross chain  
4 mm (0.16 in.) in diameter

## Regulations on the use of tire chains

Regulations regarding the use of tire chains vary depending on location and type of road. Always check local regulations before installing chains.

### ■ Tire chain installation

Observe the following precautions when installing and removing chains:

- Install and remove tire chains in a safe location.
- Install tire chains on the front tires only. Do not install tire chains on the rear tires.
- Install tire chains on front tires as tightly as possible. Retighten chains after driving 1/4 - 1/2 mile (0.5 - 1.0 km).
- Install tire chains following the instructions provided with the tire chains.
- If wheel ornaments are used, they will be scratched by the chain band, so remove the ornaments before putting on the chains. (→P. 317)

### ⚠ CAUTION

#### ■ Driving with snow tires

Observe the following precautions to reduce the risk of accidents.

Failure to do so may result in a loss of vehicle control and cause death or serious injury.

- Use tires of the size specified.
- Maintain the recommended level of air pressure.
- Do not drive in excess of 75 mph (120 km/h), regardless of the type of snow tires being used.
- Use snow tires on all, not just some wheels.
- Do not use tires of noticeably different wear level.

 CAUTION

**■ Driving with tire chains**

Observe the following precautions to reduce the risk of accidents. Failure to do so may result in the vehicle being unable to be driven safely, and may cause death or serious injury.

- Do not drive in excess of the speed limit specified for the tire chains being used, or 30 mph (50 km/h), whichever is lower.
- Avoid driving on bumpy road surfaces or over potholes.
- Avoid sudden turns and braking, as use of chains may adversely affect vehicle handling.
- Slow down sufficiently before entering a curve to ensure that vehicle control is maintained.

 NOTICE

**■ Repairing or replacing snow tires (vehicles with a tire pressure warning system)**

Request repairs or replacement of snow tires from Toyota dealers or legitimate tire retailers.

This is because the removal and attachment of snow tires affects the operation of the tire pressure warning valves and transmitters.

**■ Fitting tire chains (vehicles with a tire pressure warning system)**

The tire pressure warning valves and transmitters may not function correctly when tire chains are fitted.

## 2-5. Driving information

### Trailer towing (except 3-door models for Canada)

Toyota does not recommend towing a trailer with your vehicle. Toyota also does not recommend the installation of a tow hitch or the use of a tow hitch carrier for a wheelchair, scooter, bicycle, etc. Your vehicle is not designed for trailer towing or for the use of tow hitch mounted carriers.

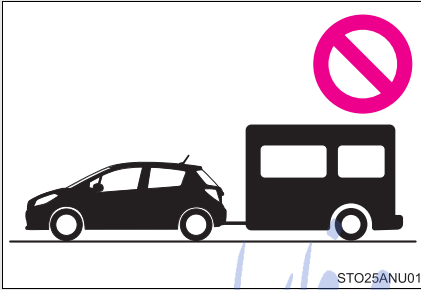

تلفن شبانه روزی: ۰۲۱-۸۸۶۲۰۸۵

FarmaSOS.com



## Trailer towing (3-door models for Canada)

Your vehicle is designed primarily as a passenger carrying vehicle. Towing a trailer will have an adverse effect on handling, performance, braking, durability, and fuel consumption. For your safety and the safety of others, do not overload the vehicle or trailer.

To tow a trailer safely, use extreme care and drive the vehicle in accordance with the trailer's characteristics and operating conditions.

The vehicle stability and braking performance are affected by trailer stability, brake setting and performance, and the hitch.

Toyota warranties do not apply to damage or malfunction caused by towing a trailer for commercial purposes.

Contact your Toyota dealer for further information about additional requirements such as a towing kits, etc.

### Weight limits

Confirm that the gross trailer weight, gross vehicle weight, gross axle weight and trailer tongue load are all within the limits.

- The gross trailer weight must never exceed 700 lb. (315 kg).

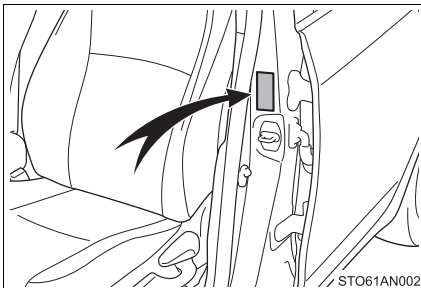

- The gross vehicle weight must never exceed the GVWR indicated on the Certification Label.
- The gross axle weight on each axle must never exceed the GAWR indicated on the Certification Label.

<b>Towing related term</b>
----------------------------

Towing related term	Meaning
GVWR (Gross Vehicle Weight Rating)	The maximum allowable gross vehicle weight. The gross vehicle weight is the total weight of the vehicle. When towing a trailer, it is the sum of the vehicle weight (including the occupants, cargo and any optional equipment installed on the vehicle) and the tongue load.
GAWR (Gross Axle Weight Rating)	The maximum allowable gross axle weight. The gross axle weight is the load placed on each axle (front and rear).
Gross trailer weight	The sum of the trailer weight and the weight of the cargo in the trailer
Towing capacity	The maximum allowable gross trailer weight. Towing capacity is calculated considering the base vehicle with necessary vehicle equipment and occupants. Additional optional equipment, passengers and cargo in the vehicle will reduce the towing capacity, gross trailer weight include the trailer, cargo and necessary equipment for towing.
Tongue load	The load placed on the trailer hitch ball

## Trailer tongue load

- A recommended tongue load varies in accordance with the types of trailers or towing as described below.
- In order to ensure the recommended values shown below, the trailer must be loaded by referring to the following instructions.  
The trailer cargo load should be distributed so that the tongue load is 9 to 11% of the gross trailer weight, not exceeding 70 lb. (31 kg).

(Tongue load / Gross trailer weight x 100 = 9 to 11%)

The gross trailer weight and tongue load can be measured with platform scales found at a highway weighing station, building supply company, trucking company, junk yard, etc.

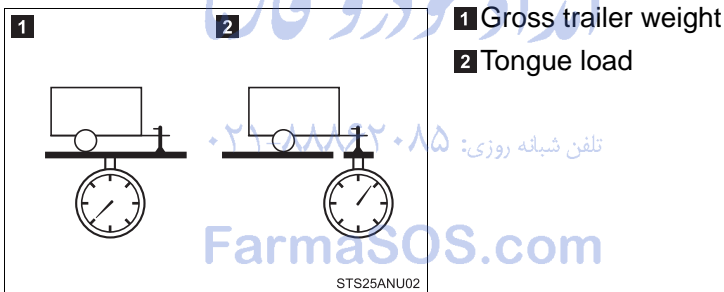

## Hitch

Trailer hitch assemblies have different weight capacities established by the hitch manufacturer. Even though the vehicle may be rated for towing a higher weight, the operator must never exceed the maximum weight rating specified for the trailer hitch.

## Connecting trailer lights

Please consult your dealer when installing trailer lights, as incorrect installation may cause damage to the vehicle's lights. Please take care to comply with your state's laws when installing trailer lights.

### Trailer towing tips

Your vehicle will handle differently when towing a trailer. In order to avoid accident, death or serious injury, keep the following in mind when towing:

- Before starting out, check the trailer lights and the vehicle-trailer connections. Recheck after driving a short distance.
- Practice turning, stopping and reversing with the trailer attached in an area away from traffic until you become accustomed to the feel of the vehicle.
- Reversing with a trailer attached is difficult and requires practice. Grip the bottom of the steering wheel and move your hand to the left to move the trailer to the left. Move your hand to the right to move the trailer to the right. (This is generally opposite to reversing without a trailer attached.) Avoid sharp or prolonged turning. Have someone guide you when reversing to reduce the risk of an accident.
- As stopping distance is increased when towing a trailer, vehicle-to-vehicle distance should be increased. For each 10 mph (16 km/h) of speed, allow at least one vehicle and trailer length.
- Avoid sudden braking as you may skid, resulting in jackknifing and loss of control. This is especially true on wet or slippery surfaces.
- Avoid jerky starts or sudden acceleration. Vehicles with a manual transmission, prevent excessive clutch slippage by keeping engine rpm low and not racing the engine. Always start out in first gear.
- Avoid jerky steering and sharp turns, and slow down before making turn.
- Note that when making a turn, the trailer wheels will be closer than the vehicle wheels to the inside of the turn. Compensate by making a larger than normal turning radius.

- Crosswinds and rough roads will adversely affect handling of your vehicle and trailer, causing sway. Periodically check the rear to prepare for being passed by large trucks or buses, which may cause your vehicle and trailer to sway. If swaying occurs, firmly grip the steering wheel, reduce speed immediately but gradually, and steer straight ahead. Never increase speed. If you make no extreme correction with the steering or brakes, your vehicle and trailer will stabilize.
- Take care when passing other vehicles. Passing requires considerable distance. After passing a vehicle, do not forget the length of your trailer, and be sure you have plenty of room before changing lanes.
- To maintain engine braking efficiency and charging system performance when using engine braking, do not use the transmission in D (vehicles with an automatic transmission) or 5 (vehicles with a manual transmission).
- Due to the added load of the trailer, your vehicle's engine may overheat on hot days (at temperatures over 85°F [30°C]) when driving up a long or steep grade. If the high engine coolant temperature warning light flashes or comes on overheating, immediately turn off the air conditioning (if in use), pull your vehicle off the road and stop in a safe place. (→P. 334)

- Always place wheel blocks under both the vehicle and the trailer wheels when parking. Apply the parking brake firmly, and put the transmission in P (vehicles with an automatic transmission) or in 1 or R (vehicles with a manual transmission). Avoid parking on a slope, but if unavoidable, do so only after performing the following:

**STEP 1** Apply the brakes and keep them applied.

**STEP 2** Have someone place wheel blocks under both the vehicle and trailer wheels.

**STEP 3** When the wheel blocks are in place, release the brakes slowly until the blocks absorb the load.

**STEP 4** Apply the parking brake firmly.

**STEP 5** Shift into P (vehicles with an automatic transmission) or 1 or R (vehicles with a manual transmission) and turn off the engine.

- When restarting after parking on a slope:

**STEP 1** With the transmission in P (vehicles with an automatic transmission) or the clutch pedal (vehicles with a manual transmission) depressed, start the engine. On vehicles with an automatic transmission, be sure to keep the brake pedal pressed.

**STEP 2** Shift into a forward gear. If reversing, shift into R.

**STEP 3** Release the parking brake (also brake pedal on vehicles with an automatic transmission), and slowly pull or back away from the wheel blocks. Stop and apply the brakes.

**STEP 4** Have someone retrieve the blocks.

### ■ Before towing

Check that the following conditions are met:

- Ensure that your vehicle's tires are properly inflated. (→P. 351)
- Trailer tires should be inflated according to the trailer manufacturer's recommendation.
- All trailer lights work as required by law.
- All lights work each time you connect them.
- The trailer ball is set at the proper height for the coupler on the trailer.
- The trailer is level when it is hitched.  
Do not drive if the trailer is not level, and check for improper tongue weight, overloading, worn suspension, or other possible causes.
- The trailer cargo is securely loaded.
- The rear view mirrors conform to any federal, state/provincial or local regulations. If they do not, install rear view mirrors appropriate for towing purposes.

### ■ Break-in schedule

If your vehicle is new or equipped with any new power train components (such as an engine, transmission, differential and wheel bearing), Toyota recommends that you do not tow a trailer until it has been driven for over 500 miles (800 km).

However, avoid full throttle acceleration.

### ■ Maintenance

- If you tow a trailer, your vehicle will require more frequent maintenance due to the additional load. (See "Scheduled Maintenance Guide" or "Owner's Manual Supplement".)
- Retighten the fixing bolts of the towing ball and bracket after approximately 600 miles (1000 km) of trailer towing.

 CAUTION

■ **Trailer towing precautions**

- Follow all the instructions described in this section. Failure to do so could cause an accident resulting in death or serious injury.
- Exceeding the towing capacity, GVWR or GAWR can cause an accident resulting in death or serious personal injuries.

■ **To avoid accident or injury**

- Do not exceed 45 mph (72 km/h) or the posted towing speed limit, whichever is lower. As instability (swaying) of the towing vehicle-trailer combination increases as speed increases, exceeding 45 mph (72 km/h) may cause loss of control.
- Do not exceed the trailer hitch assembly weight, gross vehicle weight, gross axle weight and trailer tongue load capacities.
- Never load more weight in the back than in the front of the trailer. About 60% of the load should be in the front half of the trailer, and the remaining 40% in the rear.
- Do not use cruise control when you are towing.
- Slow down and downshift before descending steep or long downhill grades. Do not make sudden downshifts while descending steep or long downhill grades.
- Avoid holding the brake pedal down too long or applying the brakes too frequently. This could cause the brakes to overheat and result in reduced braking efficiency.
- Do not tow the vehicle with the compact spare tire installed.



**⚠ CAUTION****■ Hitches**

Trailer hitch assemblies have different weight capacities established by the hitch manufacturer. Even though the vehicle may be rated for towing a higher weight, the operator must never exceed the maximum weight rating specified for the trailer hitch.

- If you wish to install a trailer hitch, contact your Toyota dealer.
- Use only a hitch that conforms to the gross trailer weight requirement.
- The towing capacity of 700 lb. (315 kg) can only be guaranteed when using a genuine Toyota hitch assembly or equivalent.
- Follow the directions supplied by the hitch manufacturer.
- Lubricate the hitch ball with a light coat of grease.
- Remove the trailer hitch whenever you are not towing a trailer. After removing the hitch, seal any mounting hole in the vehicle body to prevent entry of any substances into the vehicle.

**■ When towing a trailer**

- Never tap into your vehicle's hydraulic system, as this will lower the vehicle's braking effectiveness.
- Never tow a trailer without using a safety chain securely attached to both the trailer and the vehicle. If damage occurs to the coupling unit or hitch ball, there is danger of the trailer wandering into another lane.

 NOTICE

■ **When installing a trailer hitch**

- Use only the position recommended by your Toyota dealer. Do not install the trailer hitch on the bumper; this may cause body damage.
- Do not use axle-mounted hitches, as they can cause damage to the axle housing, wheel bearings, wheels or tires.

■ **Safety chain**

A safety chain must always be used between the towing vehicle and the trailer. Leave sufficient slack in the chain for turns. The chain should cross under the trailer tongue to prevent the tongue from dropping to the ground in the case that it becomes damaged or separated. For the correct safety chain installation procedure, ask your Toyota dealer.

■ **Do not directly splice trailer lights**

Directly splicing trailer lights may damage your vehicle's electrical system and cause a malfunction.

تلفن شبانه روزی: ۰۲۱-۸۸۶۲۰۸۵

FarmaSOS.com

Your vehicle is not designed to be dinghy towed (with 4 wheels on the ground) behind a motor home.



 NOTICE

**■ To avoid serious damage to your vehicle**

Do not tow your vehicle with the four wheels on the ground.

تلفن شبانه روزی: ۰۲۱-۸۸۶۲۰۸۵

FarmaSOS.com

Your vehicle can be dinghy towed in a forward direction (with 4 wheels on the ground) behind a motor home.

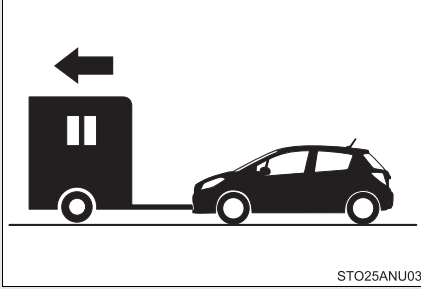

### Towing your vehicle with 4 wheels on the ground

To prevent damage to your vehicle, perform the following procedures before towing:

**STEP 1** Shift the shift lever to N. تلفن شبانه روزی: ۰۸۵-۲۰۴۲۰۸۵

**STEP 2** Turn the engine switch to the "ACC" position.

Ensure that the audio system and other powered devices are turned off.

**STEP 3** Release the parking brake.

After towing, leave the engine in idle for at least 3 minutes before driving the vehicle.

### ■ Necessary equipment and accessories

Specialized equipment and accessories are required for dinghy towing. Contact the service branch of the motor home manufacturer regarding recommended equipment.

 NOTICE

■ **Dinghy towing direction**

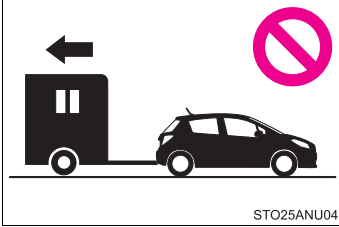

Do not tow the vehicle backward.  
Doing so may cause serious damage.

■ **To prevent the steering from locking**

Ensure the engine switch is in the "ACC" position.

تلفن شبانه روزی: ۰۲۱-۸۸۶۲۰۸۵

FarmaSOS.com

# امداد خودرو فارما

تلفن شبانه روزی: ۰۲۱-۸۸۸۶۲۰۸۵

**FarmaSOS.com**

## Interior features

# 3

### 3-1. Using the air conditioning system and defogger

- Air conditioning system .... 192
- Rear window and outside rear view mirror defoggers..... 199

### 3-2. Using the audio system

- Using the AUX port/  
USB port ..... 200
- Using the steering wheel audio switches ..... 201

### 3-3. Using the interior lights

- Interior lights list ..... 202
  - Personal lights ..... 203
  - Interior light ..... 203

### 3-4. Using the storage features

- List of storage features .... 204
  - Glove box..... 205
  - Cup holders ..... 205
  - Bottle holders ..... 207

### 3-5. Other interior features

- Sun visors ..... 208
- Vanity mirrors ..... 209
- Clock ..... 210
- Outside temperature display ..... 211
- Power outlet ..... 213
- Assist grips..... 214
- Floor mat..... 215
- Luggage compartment features ..... 217

### 3-1. Using the air conditioning system and defogger

## Air conditioning system

#### Vehicles without an air conditioning on/off button

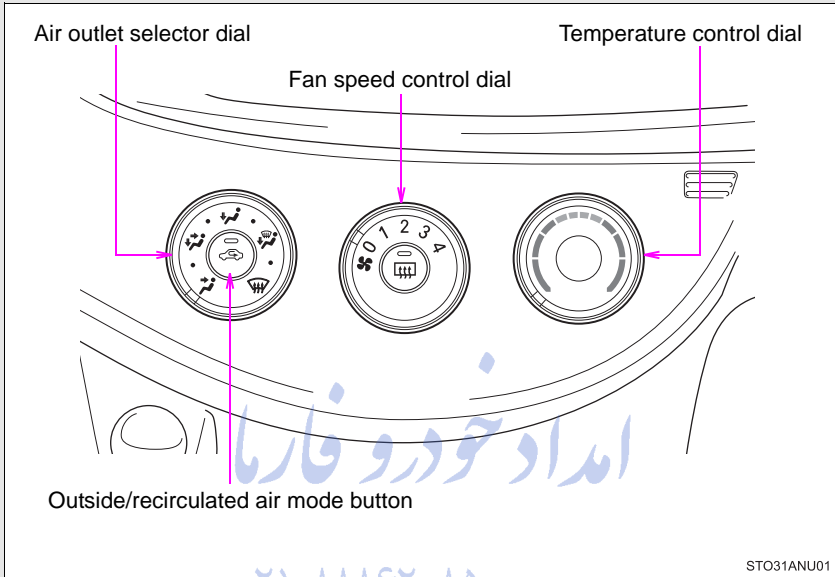

#### Vehicles with an air conditioning on/off button

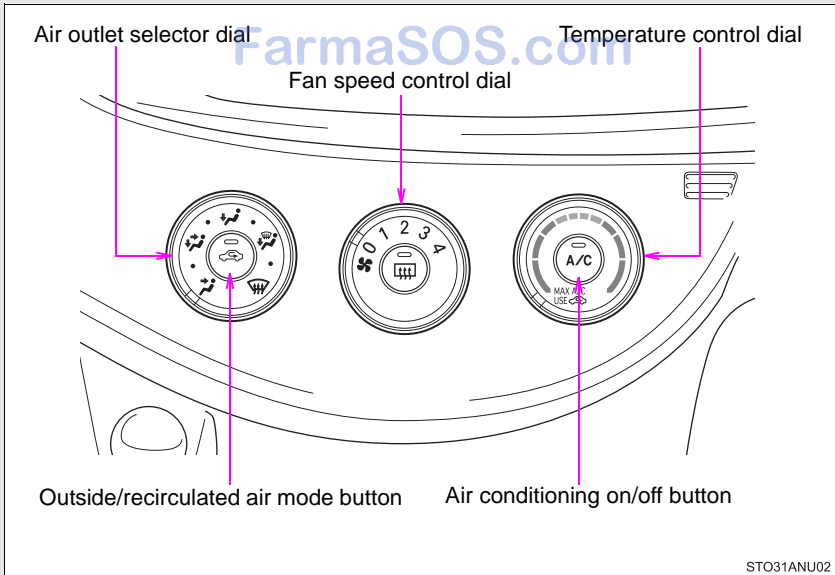



## Adjusting the settings

**STEP 1** To adjust the fan speed, turn the fan speed control dial clockwise (increase) or counterclockwise (decrease).

Turning the dial to "0" turns off the fan.

**STEP 2** Vehicles without an air conditioning on/off button:

Turn the temperature control dial clockwise to increase the temperature.

Vehicles with an air conditioning on/off button:

To adjust the temperature setting, turn the temperature control dial clockwise (warm) or counterclockwise (cool).

If  is not pressed, the system will blow ambient temperature air or heated air.

For quick cooling, turn the temperature control dial to "MAX A/C" position and set the outside/recirculated air mode button to recirculated air mode.

**STEP 3** To select the air outlets, set the air outlet selector dial to the desired position.

The positions between the air outlet selections shown below can also be selected for more delicate adjustment.

## Defogging the windshield

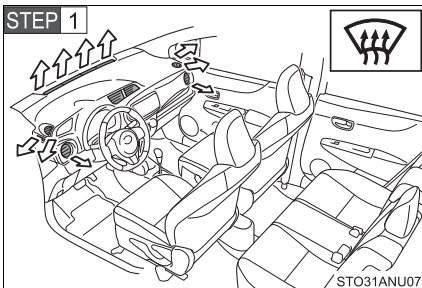

Set the air outlet selector dial to  position.

If the recirculated air mode is used, it will automatically switch to the outside air mode.

In this position, the outside/recirculated air mode cannot be changed to the recirculated air mode.

**STEP 2** Perform the following operations accordingly:

- To adjust the fan speed, turn the fan speed control dial.
- To adjust the temperature setting, turn the temperature control dial.
- If the dehumidification function is not operating, press



to operate the dehumidification function.

To defog the windshield and the side windows early, turn the air flow and temperature up.

### Air outlets and air flow

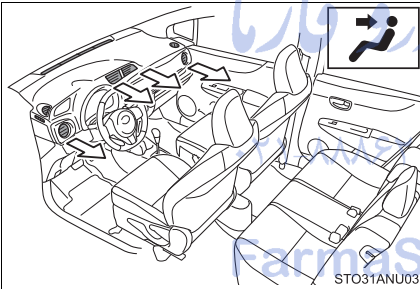

Air flows to the upper body.

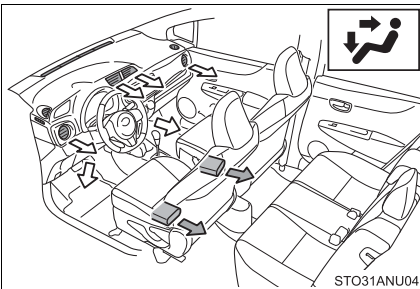

Air flows to the upper body and feet.

← : Some models

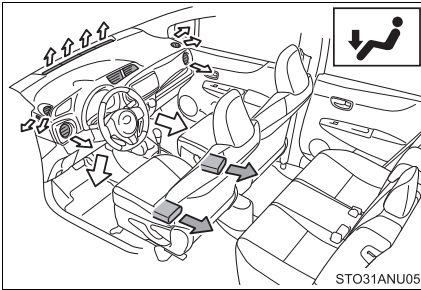

Air flows mainly to the feet.

← : Some models

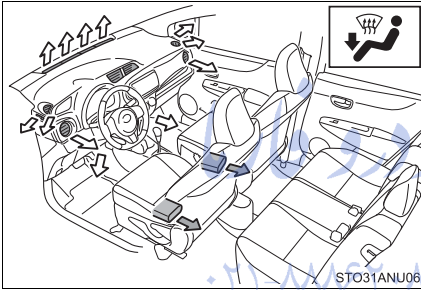

Air flows to the feet and the windshield defogger operates.

If the recirculated air mode is used, it will automatically switch to the outside air mode.

In this position, the outside/recirculated air mode cannot be changed to the recirculated air mode.

← : Some models

### Switching between outside air and recirculated air modes

Press .

The mode switches between outside air mode (introduces air from outside the vehicle) (indicator off) and recirculated air mode (recycles air inside the vehicle) (indicator on) each time the button is pressed.

**Adjusting the position of and opening and closing the air outlets**

**Center outlets**

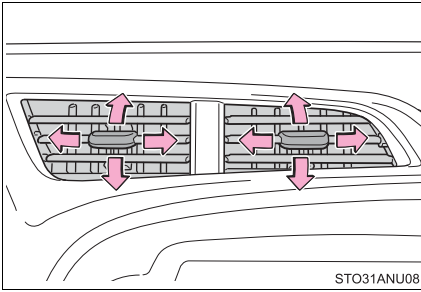

Direct air flow to the left or right, up or down.

**Right and left side outlets**

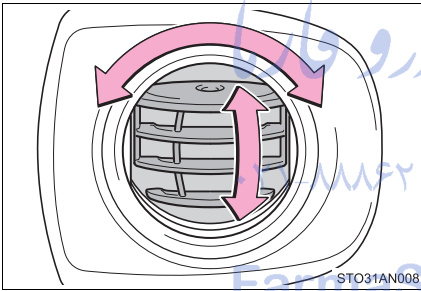

Direct air flow to the left or right, up or down.

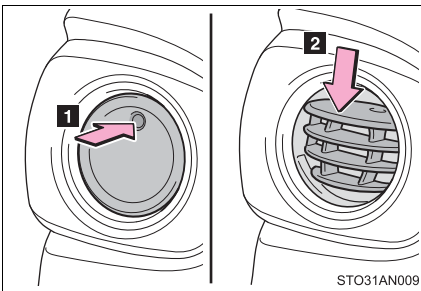

- 1** Open the vent.
- 2** Close the vent.

### ■ Fogging up of the windows

- The windows will easily fog up when the humidity in the vehicle is high.

Turning  on will dehumidify the air from the outlets and defog the windshield effectively. (vehicles with an air conditioning on/off button)

- If you turn  off, the windows may fog up more easily. (vehicles with an air conditioning on/off button)
- The windows may fog up if the recirculated air mode is used.

### ■ Outside/recirculated air mode

When driving on dusty roads such as tunnels or in heavy traffic, set the outside/recirculated air mode button to the recirculated air mode. This is effective in preventing outside air from entering the vehicle interior. During cooling operation, setting the recirculated air mode will also cool the vehicle interior effectively.

### ■ When the indicator light on goes off by itself (vehicles with an air conditioning on/off button)

Press  to turn off the dehumidification function and turn it on again.

There may be a problem in the air conditioning system if the indicator light goes off again. Turn the air conditioning system off and have it inspected by your Toyota dealer.

### ■ When the outside temperature falls to nearly 32°F (0°C) (vehicles with an air conditioning on/off button)

The dehumidification function may not operate even when  is pressed.

■ **Air conditioning odors**

- During use, various odors from inside and outside the vehicle may enter into and accumulate in the air conditioning system. This may then cause odor to be emitted from the vents.
- To reduce potential odors from occurring:  
It is recommended that the air conditioning system be set to outside air mode prior to turning the vehicle off.

■ **Air conditioning filter**

→P. 269

 **CAUTION**

■ **To prevent the windshield from fogging up**

Do not use  during cool air operation in extremely humid weather. The difference between the temperature of the outside air and that of the windshield can cause the outer surface of the windshield to fog up, blocking your vision.

 **NOTICE**

■ **To prevent battery discharge**

Do not leave the air conditioning system on longer than necessary when the engine is stopped.

### 3-1. Using the air conditioning system and defogger Rear window and outside rear view mirror defoggers\*

**Defoggers are used to defog the rear window, and to remove rain-drops, dew and frost from the outside rear view mirrors (if equipped).**

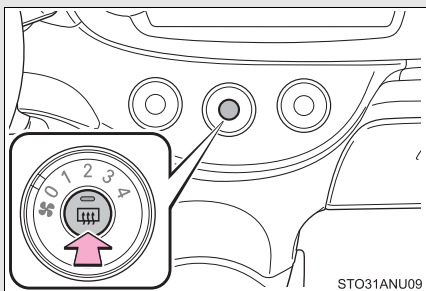

Turn the defoggers on/off

The defoggers will automatically turn off after approximately 15 minutes.

■ **The defoggers can be operated when**

The engine switch is in the "ON" position.

■ **The outside rear view mirror defoggers (if equipped)**

Turning the rear window defogger on will turn the outside rear view mirror defoggers on.

**⚠ CAUTION**

■ **When the outside rear view mirror defoggers are on (if equipped)**

Do not touch the outside surface of the rear view mirrors, as they can become very hot and burn you.

## 3-2. Using the audio system

### Using the AUX port/USB port\*

This port can be used to connect a portable audio device and listen to it through the vehicle's speakers.

For more information, please refer to the "Toyota Audio System Owner's Manual" or "Toyota Navigation System Owner's Manual".

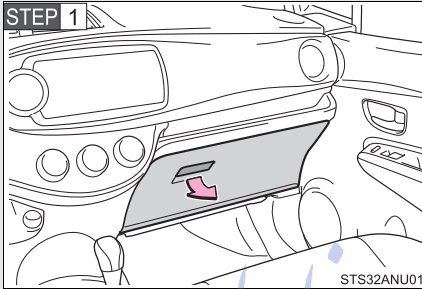

Pull up the lever to open the glove box.

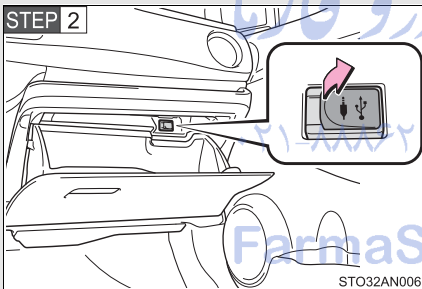

Open the cover and connect the portable audio device.

#### ■ When using a portable audio device connected to the power outlet

Noise may occur during playback. Use the power source of the portable audio device.

\*: If equipped



## 3-2. Using the audio system

### Using the steering wheel audio switches\*

Some audio features (audio volume control, radio, CD player etc.) can be controlled using the switches on the steering wheel.

For more information, please refer to the "Toyota Audio System Owner's Manual" or "Toyota Navigation System Owner's Manual".

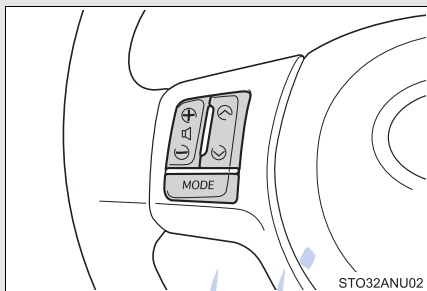

#### **⚠ CAUTION**

■ **To reduce the risk of an accident** تلفن شبانه روزی: ۸۵

Exercise care when operating the audio switches on the steering wheel.

[FarmaSOS.com](http://FarmaSOS.com)

### 3-3. Using the interior lights

## Interior lights list

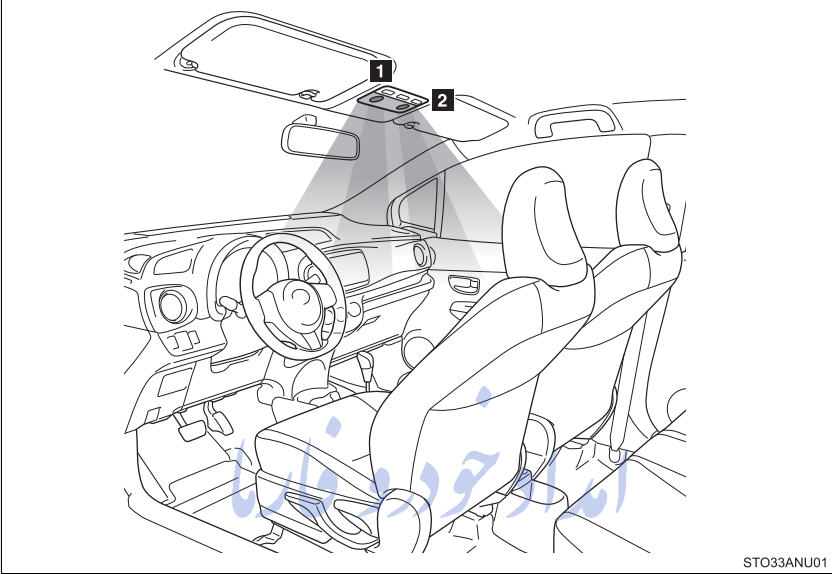

STO33ANU01

**1** Personal lights (→P. 203)

**2** Interior light (→P. 203)

FarmaSOS.com

## Personal lights

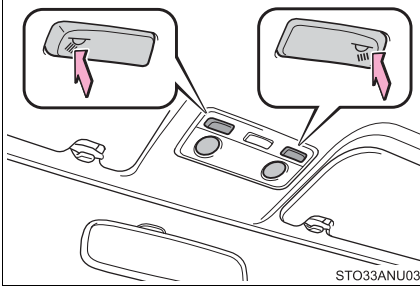

Turns the lights on/off

## Interior light

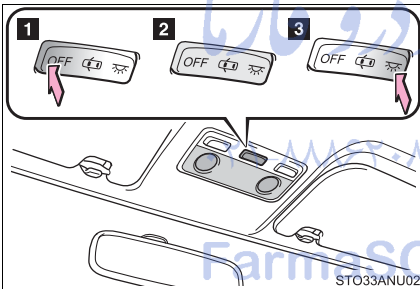

- 1 Turns the lights off
- 2 Turns the lights on/off linked to door position
- 3 Turns the lights on

تلفن شبانه روزی: ۵

FarmSOS.com

### ■ Illuminated entry system

The lights automatically turn on/off according to the engine switch position, whether the doors are locked/unlocked, and whether the doors are open/closed.

### ■ To prevent battery discharged

If the interior light remains on when the door is not fully closed and the interior light switch is in the door position, the lights will go off automatically after 20 minutes.

### ■ Customization that can be configured at Toyota dealer

Settings (e.g. the time elapsed before lights turn off) can be changed.  
(Customizable features →P. 368)

### 3-4. Using the storage features

## List of storage features

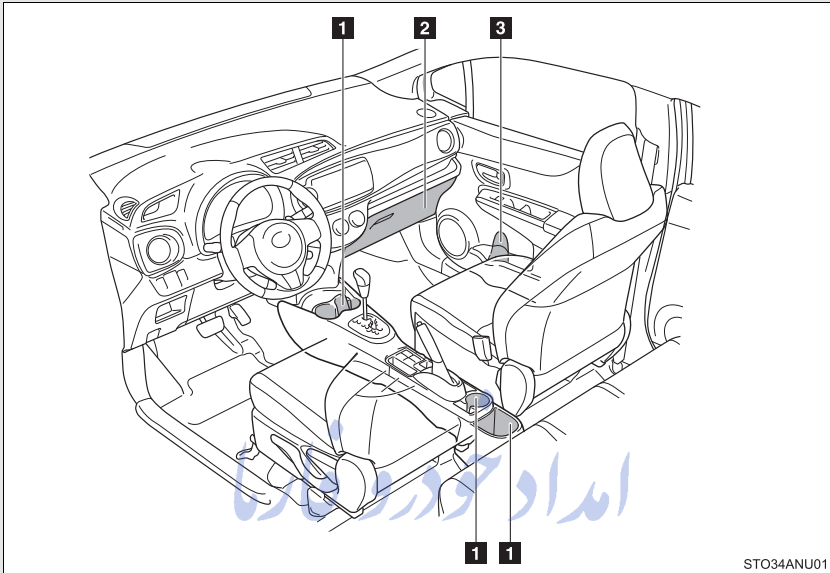

- 1 Cup holders
- 2 Glove box
- 3 Bottle holders

تلفن شبانه روزی: ۰۲۱-۸۸۶۲۰۸۵

FarmaSOS.com

#### CAUTION

##### ■ Items that should not be left in the storage spaces

Do not leave glasses, lighters or spray cans in the storage spaces, as this may result in the following when cabin temperature becomes high:

- Glasses may be deformed by heat or cracked if they come into contact with other stored items.
- Lighters or spray cans may explode. If they come into contact with other stored items, the lighter may catch fire or the spray can may release gas, causing a fire hazard.

## Glove box

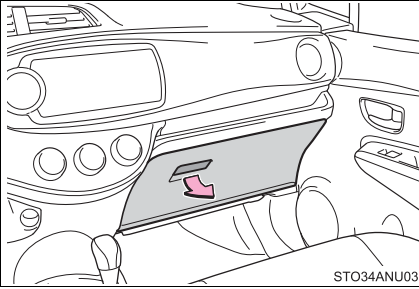

STO34ANU03

Pull up the lever to open the glove box.

### ⚠ CAUTION

#### ■ Caution while driving

Keep the glove box closed. In the event of sudden braking or sudden swerving, an accident may occur due to an occupant being struck by the open glove box or the items stored inside.

تلفن شبانه روزی: ۰۲۱-۸۸۶۲۰۸۵

## Cup holders

### Front

FarmaSOS.com

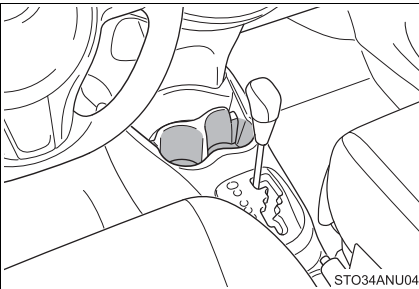

STO34ANU04

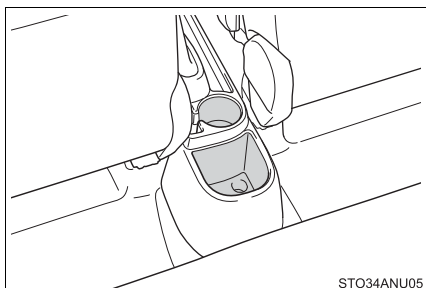
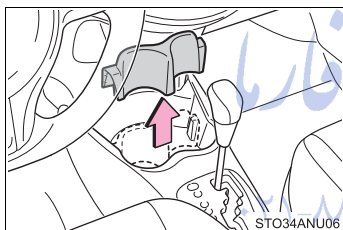
**Rear****■ Remove the separator**

Pull the separator up.

**⚠ CAUTION****■ Items unsuitable for the cup holder**

Do not place anything other than cups or beverage cans in the cup holders. Other items may be thrown out of the holders in the event of an accident or sudden braking, causing injury. If possible, cover hot drinks to prevent burns.

## Bottle holders

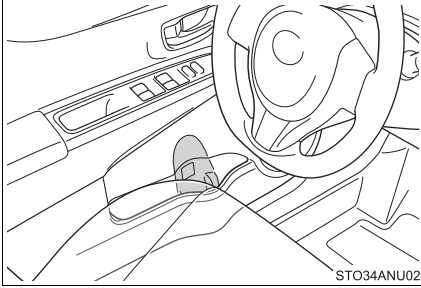

### ■ When using the bottle holder

- When storing a bottle, close the cap.
- The bottle may not be stored depending on its size or shape.

### ▲ CAUTION

#### ■ Items unsuitable for the bottle holder

Do not place anything other than a bottle in the bottle holders. Other items may be thrown out of the holders in the event of an accident or sudden braking and cause injury.

### ▲ NOTICE

#### ■ Items that should not be stowed in the bottle holders

Put the cap on before stowing a bottle. Do not place open bottles in the bottle holders, or glasses and paper cups containing liquid. The contents may spill and glasses may break.

## Sun visors

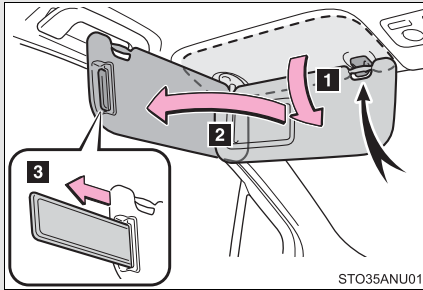

- 1** To set the visor in the forward position, flip it down.
- 2** To set the visor in the side position, flip down, unhook, and swing it to the side.
- 3** To use the side extender, place the visor in the side position, then slide it backward. (if equipped)

امداد خودرو فارما

تلفن شبانه روزی: ۰۲۱-۸۸۶۲۰۸۵

FarmaSOS.com



## Vanity mirrors

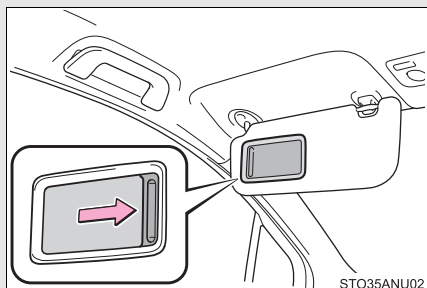

Slide the cover to open.

امداد خودرو فارما

تلفن شبانه روزی: ۰۲۱-۸۸۶۲۰۸۵

FarmaSOS.com

### 3-5. Other interior features

## Clock

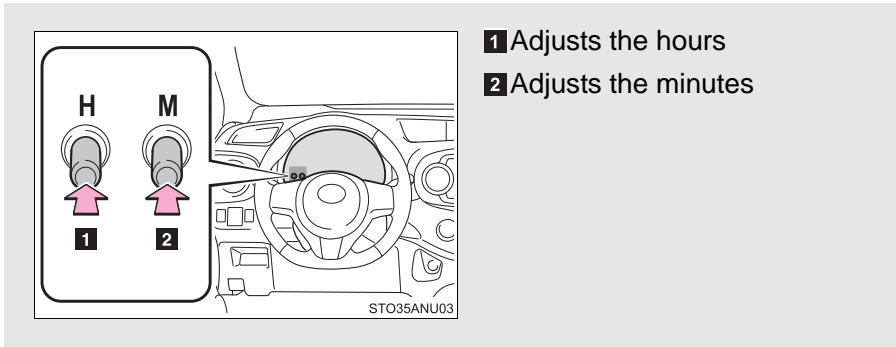

#### ■ The clock is displayed when

The engine switch is in the "ON" position.

#### ■ When disconnecting and reconnecting battery terminals

The clock data will be reset.

تلفن شبانه روزی: ۰۲۱-۸۸۶۲۰۸۵

FarmaSOS.com

## Outside temperature display

The temperature display shows temperatures within the ranges of -40°F (-40°C) and 122°F (50°C).

### Except Canada

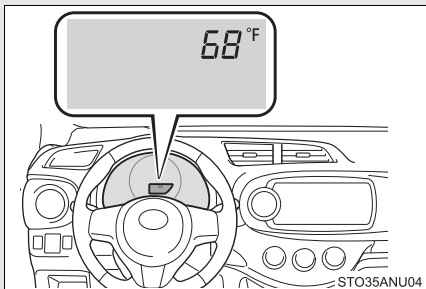

### Canada

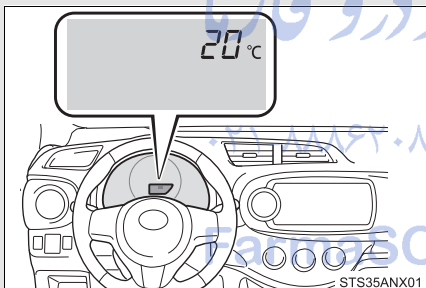

■ **The outside temperature is displayed when**

The engine switch is in the “ON” position.

■ **Display**

In the following situations, the correct outside temperature may not be displayed, or the display may take longer than normal to change:

- When the vehicle is stopped, or moving at low speeds (less than 16 mph [25 km/h])
- When the outside temperature has changed suddenly (at the entrance/ exit of a garage, tunnel, etc.)

■ **When “—” or “E” is displayed**

The system may be malfunctioning. Take your vehicle to your Toyota dealer.

امداد خودرو فارما

تلفن شبانه روزی: ۰۲۱-۸۸۶۲۰۸۵

FarmaSOS.com

## Power outlet

The power outlet can be used for 12 V accessories that run on less than 10 A.

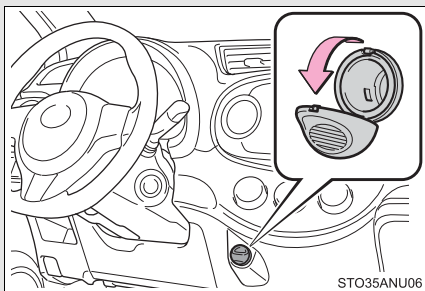

■ **The power outlet can be used when**

The engine switch is in the “ACC” or “ON” position.

⚠ **NOTICE**

تلفن شبانه روزی: ۰۲۱-۸۸۶۲۰۸۵

■ **To avoid damaging the power outlet**

Close the power outlet lid when the power outlet is not in use. Foreign objects or liquids that enter the power outlet may cause a short circuit.

■ **To prevent blown fuse**

Do not use an accessory that uses more than 12 V 10 A.

■ **To prevent battery discharge**

Do not use the power outlet longer than necessary when the engine is not running.

## Assist grips

An assist grip installed on the ceiling can be used to support your body while sitting on the seat.

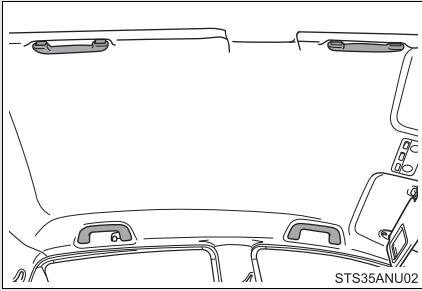

### ⚠ CAUTION

#### ■ Assist grip

Do not use the assist grip when getting in or out of the vehicle or rising from your seat.

تلفن شبانه روزی: ۰۲۱-۸۸۶۲۰۸۵

### ⚠ NOTICE

#### ■ To prevent damage to the assist grip

Do not hang any heavy object or put a heavy load on the assist grip.

FarmaSOS.com

## Floor mat

Use only floor mats designed specifically for vehicles of the same model and model year as your vehicle. Fix them securely in place onto the carpet.

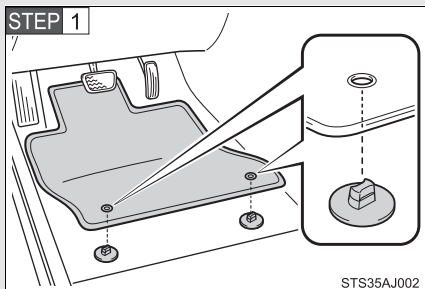

Insert the retaining hooks (clips) into the floor mat eyelets.

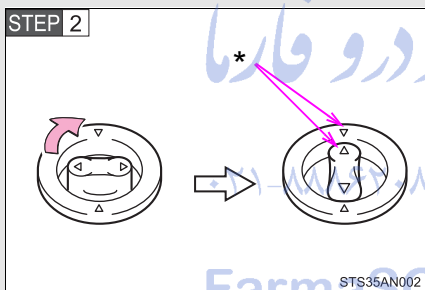

Turn the upper knob of each retaining hook (clip) to secure the floor mats in place.

\*: Always align the  $\Delta$  marks.

The shape of the retaining hooks (clips) may differ from that shown in the illustration.

**⚠ CAUTION**

Observe the following precautions.

Failure to do so may cause the driver's floor mat to slip, possibly interfering with the pedals while driving. An unexpectedly high speed may result or it may become difficult to stop the vehicle, leading to a serious accident.

**■ When installing the driver's floor mat**

- Do not use floor mats designed for other models or different model year vehicles, even if they are Toyota Genuine floor mats.
- Only use floor mats designed for the driver's seat.
- Always install the floor mat securely using the retaining hooks (clips) provided.
- Do not use two or more floor mats on top of each other.
- Do not place the floor mat bottom-side up or upside-down.

**■ Before driving**

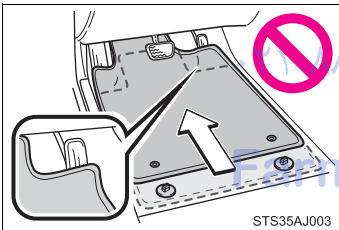

- Check that the floor mat is securely fixed in the correct place with all the provided retaining hooks (clips). Be especially careful to perform this check after cleaning the floor.
- With the engine stopped and the shift lever in P (vehicles with an automatic transmission) or N (vehicles with a manual transmission), fully depress each pedal to the floor to make sure it does not interfere with the floor mat.



## Luggage compartment features

### ■ Deck board

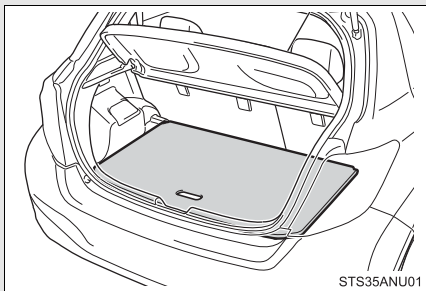

### Removing the deck board

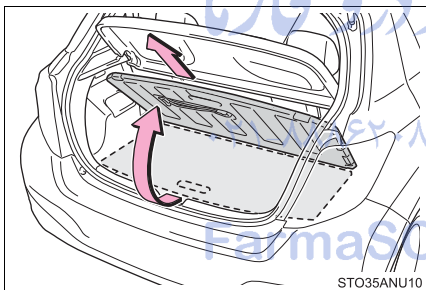

Lift up the deck board and pull it towards you to remove it.

### Securing the deck board

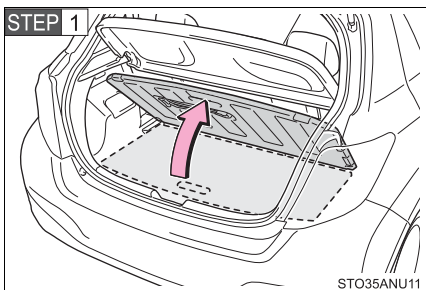

Lift up the deck board.

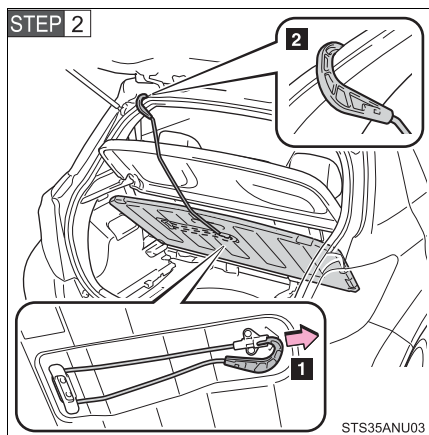

- 1 Remove the hook on the back-side of the deck board.
- 2 Attach the hook to the upper edge of the back door opening as shown.

### ■ Removing the luggage cover

The luggage cover can be removed by the following procedure:

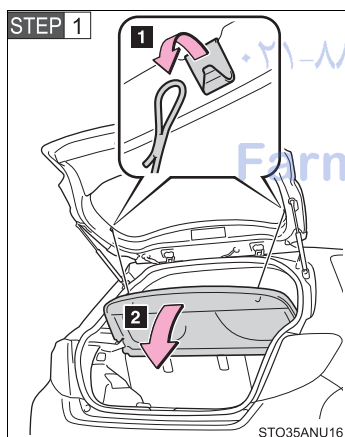

- 1 Unhook the cords.
- 2 Return the luggage cover to horizontal position.

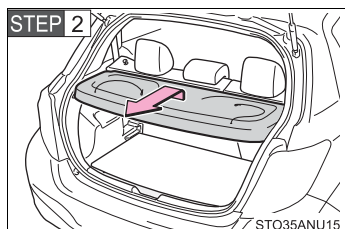

Lift the luggage cover and pull it forward.

**⚠ CAUTION****■ When operating the deck board**

Do not place anything on the deck board when operating the board. Otherwise, your fingers may be caught or an accident may result causing injuries.

امداد خودرو فارما

تلفن شبانه روزی: ۰۲۱-۸۸۶۲۰۸۵

FarmaSOS.com

امداد خودرو فارما

تلفن شبانه روزی: ۰۲۱-۸۸۸۶۲۰۸۵

**FarmaSOS.com**

## 4-1. Maintenance and care

- Cleaning and protecting the vehicle exterior..... 222
- Cleaning and protecting the vehicle interior..... 225

## 4-2. Maintenance

- Maintenance requirements..... 228
- General maintenance..... 230
- Emission inspection and maintenance (I/M) programs..... 234

## 4-3. Do-it-yourself maintenance

- Do-it-yourself service precautions ..... 235
- Hood ..... 238
- Positioning a floor jack ..... 240
- Engine compartment..... 243
- Tires ..... 254
- Tire inflation pressure ..... 262
- Wheels ..... 266
- Air conditioning filter..... 269
- Wireless remote control battery ..... 271
- Checking and replacing fuses ..... 275
- Light bulbs..... 287

## Cleaning and protecting the vehicle exterior

**Perform the following to protect the vehicle and maintain it in prime condition:**

- Working from top to bottom, liberally apply water to the vehicle body, wheel wells and underside of the vehicle to remove any dirt and dust.
- Wash the vehicle body using a sponge or soft cloth, such as a chamois.
- For hard-to-remove marks, use car wash soap and rinse thoroughly with water.
- Wipe away any water.
- Wax the vehicle when the waterproof coating deteriorates.

If water does not bead on a clean surface, apply wax when the vehicle body is cool.

---

تلفن شبانه روزی: ۰۲۱ ۸۸۶۲۰۸۵

### ■ Automatic car washes

- Fold the mirrors and remove the antenna before washing the vehicle. Start washing from the front of the vehicle. Make sure to re-install the antenna and extend the mirrors before driving.
- Brushes used in automatic car washes may scratch the vehicle surface and harm your vehicle's paint.
- For vehicles with the rear spoiler, in certain automatic car washes, the rear spoiler may interfere with machine operation. This may prevent the vehicle from being cleaned properly or result in damage to the rear spoiler.

### ■ High pressure car washes

- Do not allow the nozzles of the car wash to come within close proximity of the window and door borders, and high mounted stoplight.
- Before using the car wash, check that the fuel filler door on your vehicle is closed properly.

### ■ Aluminum wheels (if equipped)

- Remove any dirt immediately by using a neutral detergent. Do not use hard brushes or abrasive cleaners. Do not use strong or harsh chemical cleaners.  
Use the same mild detergent and wax as used on the paint.
- Do not use detergent on the wheels when they are hot, for example after driving for long distance in the hot weather.
- Wash detergent from the wheels immediately after use.
- To preserve the wheels' luster, do not allow hot water, such as from steam cleaning, to contact them directly.

### ■ Bumpers

Do not scrub with abrasive cleaners.

#### ▲ CAUTION

#### ■ When washing the vehicle

Do not apply water to the inside of the engine compartment. Doing so may cause the electrical components etc. to catch fire: تلفن

#### ■ Precautions regarding the exhaust pipe

Exhaust gasses cause the exhaust pipe to become quite hot.

When washing the vehicle, be careful not to touch the pipe until it has cooled sufficiently, as touching a hot exhaust pipe can cause burns.

 NOTICE

■ **To prevent paint deterioration and corrosion on the body and components (aluminum wheels etc.)**

● Wash the vehicle immediately in the following cases:

- After driving near the sea coast
- After driving on salted roads
- If coal tar or tree sap is present on the paint surface
- If dead insects, insect droppings or bird droppings are present on the paint surface
- After driving in an area contaminated with soot, oily smoke, mine dust, iron powder or chemical substances
- If the vehicle becomes heavily soiled with dust or mud
- If liquids such as benzene and gasoline are spilled on the paint surface

● If the paint is chipped or scratched, have it repaired immediately.

● To prevent the wheels from corroding, remove any dirt and store in a place with low humidity when storing the wheels.

■ **Cleaning the exterior lights**

● Wash carefully. Do not use organic substances or scrub with a hard brush. This may damage the surfaces of the lights.

● Do not apply wax to the surfaces of the lights. Wax may cause damage to the lenses.

■ **Antenna installation and removal precautions**

● Before driving, ensure that the antenna is installed.

● When the antenna is removed, such as before entering an automatic car wash, make sure to store it in a suitable place so as not to lose it. Also, before driving, make sure to reinstall the antenna in its original position.

■ **To prevent damage to the antenna**

Remove the antenna in the following situations:

- When the antenna will touch the ceiling of a garage or other such places
- When a car cover is to be used to cover the vehicle



## Cleaning and protecting the vehicle interior

**The following procedures will help protect your vehicle's interior and keep it in top condition:**

### ■ Protecting the vehicle interior

Remove dirt and dust using a vacuum cleaner. Wipe dirty surfaces with a cloth dampened with lukewarm water.

### ■ Cleaning the leather areas

- Remove dirt and dust using a vacuum cleaner.
- Wipe off any excess dirt and dust with a soft cloth dampened with diluted detergent.

Use a diluted water solution of approximately 5% neutral wool detergent.

- Wring out any excess water from the cloth and thoroughly wipe off all remaining traces of detergent.
- Wipe the surface with a dry, soft cloth to remove any remaining moisture. Allow the leather to dry in a shaded and ventilated area.

### ■ Cleaning the synthetic leather areas

- Remove loose dirt using a vacuum cleaner.
- Apply a mild soap solution to the synthetic leather using a sponge or soft cloth.
- Allow the solution to soak in for a few minutes. Remove the dirt and wipe off the solution with a clean, damp cloth.

### ■ Caring for leather areas

Toyota recommends cleaning the interior of the vehicle at least twice a year to maintain the quality of the vehicle's interior.

### ■ Shampooing the carpets

There are several commercial foaming-type cleaners available. Use a sponge or brush to apply the foam. Rub in overlapping circles. Do not use water. Wipe dirty surfaces and let them dry. Excellent results are obtained by keeping the carpet as dry as possible.

### ■ Seat belts

Clean with mild soap and lukewarm water using a cloth or sponge. Also check the belts periodically for excessive wear, fraying or cuts.

## ▲ CAUTION

### ■ Water in the vehicle

- Do not splash or spill liquid in the vehicle.  
Doing so may cause electrical components etc. to malfunction or catch fire.
- Do not get any of the SRS components or wiring in the vehicle interior wet.  
(→P. 82)  
An electrical malfunction may cause the airbags to deploy or not function properly, resulting in death or serious injury.

### ■ Cleaning the interior (especially instrument panel)

Do not use polish wax or polish cleaner. The instrument panel may reflect off the windshield, obstructing the driver's view and leading to an accident, resulting in death or serious injury.

 NOTICE

### ■ Cleaning detergents

- Do not use the following types of detergent, as they may discolor the vehicle interior or cause streaks or damage to painted surfaces:
  - Non-seat portions: Organic substances such as benzene or gasoline, alkaline or acidic solutions, dye, and bleach
  - Seats: Alkaline or acidic solutions, such as thinner, benzene, and alcohol
- Do not use polish wax or polish cleaner. The instrument panel's or other interior part's painted surface may be damaged.

### ■ Preventing damage to leather surfaces

Observe the following precautions to avoid damage to and deterioration of leather surfaces:

- Remove any dust or dirt from leather surfaces immediately.
- Do not expose the vehicle to direct sunlight for extended periods of time. Park the vehicle in the shade, especially during summer.
- Do not place items made of vinyl, plastic, or containing wax on the upholstery, as they may stick to the leather surface if the vehicle interior heats up significantly.

### ■ Water on the floor

Do not wash the vehicle floor with water.

Vehicle systems such as the audio system may be damaged if water comes into contact with electrical components such as the audio system above or under the floor of the vehicle. Water may also cause the body to rust.

### ■ Cleaning the inside of the rear window

- Do not use glass cleaner to clean the rear window, as this may cause damage to the rear window defogger heater wires. Use a cloth dampened with lukewarm water to gently wipe the window clean. Wipe the window in strokes running parallel to the heater wires.
- Be careful not to scratch or damage the heater wires.

## Maintenance requirements

**To ensure safe and economical driving, day-to-day care and regular maintenance are essential. It is the owner's responsibility to perform regular checks. Toyota recommends performing the following maintenance:**

### ■ General maintenance

General maintenance should be performed on a daily basis. This can be done by yourself or by a Toyota dealer.

### ■ Scheduled maintenance

Scheduled maintenance should be performed at specified intervals according to the maintenance schedule.

For details about maintenance items and schedules, refer to the "Scheduled Maintenance Guide" or "Owner's Manual Supplement".

### ■ Do-it-yourself maintenance

You can perform some maintenance procedures by yourself. Please be aware that do-it-yourself maintenance may affect warranty coverage. تلفن شبانه روزی: ۰۲۱-۸۸۶۲۰۸۵

The use of Toyota Repair Manuals is recommended.

For details about warranty coverage, see the separate "Owner's Warranty Information Booklet" or "Owner's Manual Supplement".

---

### ■ Repair and replacement

It is recommended that genuine Toyota parts be used for repairs to ensure performance of each system. If non-Toyota parts are used in replacement or if a repair shop other than a Toyota dealer performs repairs, confirm the warranty coverage.

### ■ Reset the maintenance data (except Canada)

After the required maintenance is performed according to the maintenance schedule, please reset the maintenance data.

To reset the data, follow the procedures described below:

**STEP 1** Switch the display to the trip meter “A” when the engine is running. (→P. 133)

**STEP 2** Turn the engine switch to the “LOCK” position.

**STEP 3** While pressing the display change button (→P. 133), turn the engine switch to the “ON” position (do not start the engine because reset mode will be canceled). Continue to press and hold the button until the trip meter displays “000000”.

### ■ Allow inspection and repairs to be performed by a Toyota dealer

- Toyota technicians are well-trained specialists and are kept up to date with the latest service information. They are well informed about the operations of all systems on your vehicle.
- Keep a copy of the repair order. It proves that the maintenance that has been performed is under warranty coverage. If any problem should arise while your vehicle is under warranty, your Toyota dealer will promptly take care of it.

تلفن شبانه روزی: ۰۲۱-۸۸۶۲۰۸۵

### ⚠ CAUTION

#### ■ If your vehicle is not properly maintained

Improper maintenance could result in serious damage to the vehicle and possible serious injury or death.

#### ■ Handling of the battery

- Engine exhaust, some of its constituents, and a wide variety of automobile components contain or emit chemicals known to the State of California to cause cancer and birth defects and other reproductive harm. Work in a well ventilated area.
- Oils, fuels and fluids contained in vehicles as well as waste produced by component wear contain or emit chemicals known to the State of California to cause cancer and birth defects or other reproductive harm. Avoid exposure and wash any affected area immediately.
- Battery posts, terminals and related accessories contain lead and lead compounds which are known to cause brain damage. Wash your hands after handling. (→P. 250)

## General maintenance

Listed below are the general maintenance items that should be performed at the intervals specified in the “Owner’s Warranty Information Booklet” or “Owner’s Manual Supplement/Scheduled Maintenance Guide”. It is recommended that any problem you notice should be brought to the attention of your Toyota dealer or qualified service shop for advice.

<b>Engine compartment</b>
---------------------------

Items	Check points
Battery	Check the battery fluid and connections. (→P. 250)
Brake fluid	Is the brake fluid at the correct level? (→P. 249)
Engine coolant	Is the engine coolant at the correct level? (→P. 247)
Engine oil	Is the engine oil at the correct level? (→P. 244)
Exhaust system	There should not be any fumes or strange sounds.
Radiator/condenser	The radiator and condenser should be free from foreign objects. (→P. 248)
Washer fluid	Is there sufficient washer fluid? (→P. 253)

<b>Vehicle interior</b>
-------------------------

Items	Check points
Accelerator pedal	<ul style="list-style-type: none"> <li>The accelerator pedal should move smoothly (without uneven pedal effort or catching).</li> </ul>
Automatic transmission "Park" mechanism	<ul style="list-style-type: none"> <li>When parked on a slope and the shift lever is in P, is the vehicle securely stopped?</li> </ul>
Brake pedal	<ul style="list-style-type: none"> <li>Does the brake pedal move smoothly?</li> <li>Does the brake pedal have appropriate clearance from the floor? (→P. 350)</li> <li>Does the brake pedal have the correct amount of free play? (→P. 350)</li> </ul>
Brakes	<ul style="list-style-type: none"> <li>The vehicle should not pull to one side when the brakes are applied.</li> <li>The brakes should work effectively.</li> <li>The brake pedal should not feel spongy.</li> <li>The brake pedal should not get too close to the floor when the brakes are applied.</li> </ul>
Clutch pedal	<ul style="list-style-type: none"> <li>Does the clutch pedal move smoothly?</li> <li>Does the clutch pedal have appropriate clearance from the floor?</li> <li>Does the clutch pedal have the correct amount of free play? (→P. 349)</li> </ul>
Head restraints	<ul style="list-style-type: none"> <li>Do the head restraints move smoothly and lock securely?</li> </ul>

Items	Check points
Indicators/buzzers	<ul style="list-style-type: none"> <li>• Do the indicators and buzzers function properly?</li> </ul>
Lights	<ul style="list-style-type: none"> <li>• Do all the lights come on?</li> </ul>
Parking brake	<ul style="list-style-type: none"> <li>• Does the parking brake lever move smoothly?</li> <li>• When parked on a slope and the parking brake is on, is the vehicle securely stopped?</li> </ul>
Seat belts	<ul style="list-style-type: none"> <li>• Do the seat belts operate smoothly?</li> <li>• The seat belts should not be damaged.</li> </ul>
Seats	<ul style="list-style-type: none"> <li>• Do the seat controls operate properly?</li> </ul>
Steering wheel	<ul style="list-style-type: none"> <li>• Does the steering wheel rotate smoothly?</li> <li>• Does the steering wheel have the correct amount of free play?</li> <li>• There should not be any strange sounds coming from the steering wheel.</li> </ul>



## Vehicle exterior

Items	Check points
Doors	<ul style="list-style-type: none"> <li>• Do the doors operate smoothly?</li> </ul>
Engine hood	<ul style="list-style-type: none"> <li>• Does the engine hood lock system work properly?</li> </ul>
Fluid leaks	<ul style="list-style-type: none"> <li>• There should not be any signs of fluid leakage after the vehicle has been parked.</li> </ul>
Tire	<ul style="list-style-type: none"> <li>• Is the tire inflation pressure correct?</li> <li>• The tires should not be damaged or excessively worn.</li> <li>• Have the tires been rotated according to the maintenance schedule?</li> <li>• The wheel nuts should not be loose.</li> </ul>

### CAUTION

#### ■ If the engine is running

Turn the engine off and ensure that there is adequate ventilation before performing maintenance checks.

**Some states have vehicle emission inspection programs which include OBD (On Board Diagnostics) checks. The OBD system monitors the operation of the emission control system.**

■ **If the malfunction indicator lamp comes on**

The OBD system determines that a problem exists somewhere in the emission control system. Your vehicle may not pass the I/M test and may need to be repaired. Contact your Toyota dealer to service the vehicle.

■ **Your vehicle may not pass the I/M test in the following situations:**

- When the battery is disconnected or discharged

Readiness codes that are set during ordinary driving are erased.

Also, depending on your driving habits, the readiness codes may not be completely set.

- When the fuel tank cap is loose

The malfunction indicator lamp comes on indicating a temporary malfunction and your vehicle may not pass the I/M test.

■ **When the malfunction indicator lamp still remains on after several driving trips**

The error code in the OBD system will not be cleared unless the vehicle is driven 40 or more times.

■ **If your vehicle does not pass the I/M test**

Contact your Toyota dealer to prepare the vehicle for re-testing.

## Do-it-yourself service precautions

**If you perform maintenance by yourself, be sure to follow the correct procedures as given in these sections.**

Items	Parts and tools
Battery condition (→P. 250)	<ul style="list-style-type: none"> <li>• Warm water</li> <li>• Baking soda</li> <li>• Grease</li> <li>• Conventional wrench (for terminal clamp bolts)</li> <li>• Distilled water</li> </ul>
Brake fluid level (→P. 249)	<ul style="list-style-type: none"> <li>• FMVSS No.116 DOT 3 or SAE J1703 brake fluid</li> <li>• Rag or paper towel</li> <li>• Funnel (used only for adding brake fluid)</li> </ul>
Engine coolant level (→P. 247)	<ul style="list-style-type: none"> <li>• “Toyota Super Long Life Coolant” or similar high quality ethylene glycol-based non-silicate, non-amine, non-nitrite and non-borate coolant with long-life hybrid organic acid technology.</li> <li>Except Canada: “Toyota Super Long Life Coolant” is pre-mixed with 50% coolant and 50% deionized water.</li> <li>Canada: “Toyota Super Long Life Coolant” is pre-mixed with 55% coolant and 45% deionized water.</li> <li>• Funnel (used only for adding engine coolant)</li> </ul>
Engine oil level (→P. 244)	<ul style="list-style-type: none"> <li>• “Toyota Genuine Motor Oil” or equivalent</li> <li>• Rag or paper towel</li> <li>• Funnel (used only for adding engine oil)</li> </ul>

Items	Parts and tools
Fuses (→P. 275)	<ul style="list-style-type: none"> <li>• Fuse with same amperage rating as original</li> </ul>
Light bulbs (→P. 287)	<ul style="list-style-type: none"> <li>• Bulb with same number and wattage rating as original</li> <li>• Phillips-head screwdriver</li> <li>• Flathead screwdriver</li> <li>• Wrench</li> </ul>
Radiator and condenser (→P. 248)	—
Tire inflation pressure (→P. 262)	<ul style="list-style-type: none"> <li>• Tire pressure gauge</li> <li>• Compressed air source</li> </ul>
Washer fluid (→P. 253)	<ul style="list-style-type: none"> <li>• Water or washer fluid containing antifreeze (for winter use)</li> <li>• Funnel (used only for adding water or washer fluid)</li> </ul>

### ⚠ CAUTION

The engine compartment contains many mechanisms and fluids that may move suddenly, become hot, or become electrically energized. To avoid death or serious injury, observe the following precautions:

#### ■ When working on the engine compartment:

- Keep hands, clothing and tools away from the moving fan and engine drive belt.
- Be careful not to touch the engine, radiator, exhaust manifold, etc. right after driving as they may be hot. Oil and other fluids may also be hot.
- Do not leave anything that may burn easily, such as paper and rags, in the engine compartment.
- Do not smoke, cause sparks or expose an open flame to fuel or the battery. Fuel and battery fumes are flammable.
- Be extremely cautious when working on the battery. It contains poisonous and corrosive sulfuric acid.

 **CAUTION**

■ **When working near the electric cooling fan or radiator grille**

Be sure the engine switch is off.

With the engine switch on, the electric cooling fan may automatically start to run if the air conditioning is on and/or the coolant temperature is high.

(→P. 248)

■ **Safety glasses**

Wear safety glasses to prevent flying or falling material, fluid spray, etc. from getting in your eyes.

 **NOTICE**

■ **If you remove the air cleaner filter**

Driving with the air cleaner filter removed may cause excessive engine wear due to dirt in the air.

تلفن شبانه روزی: ۰۲۱-۸۸۶۲۰۸۵

FarmaSOS.com

## 4-3. Do-it-yourself maintenance

### Hood

**Release the lock from the inside of the vehicle to open the hood.**

**STEP 1**

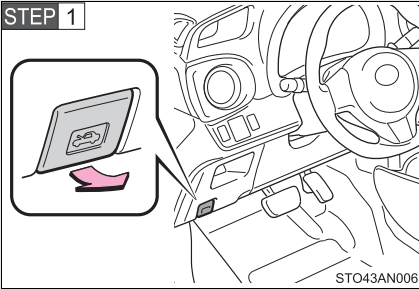

Pull the hood lock release lever.

The hood will pop up slightly.

**STEP 2**

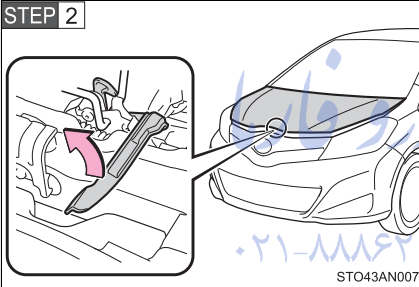

Pull up the auxiliary catch lever and lift the hood.

**STEP 3**

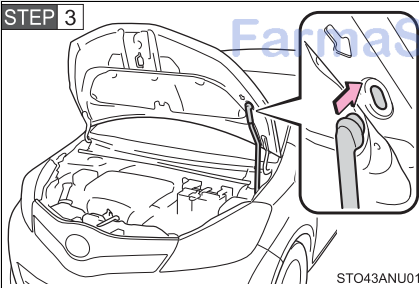

Hold the hood open by inserting the supporting rod into the slot.

**⚠ CAUTION****■ Pre-driving check**

Check that the hood is fully closed and locked.

If the hood is not locked properly, it may open while the vehicle is in motion and cause an accident, which may result in death or serious injury.

**■ After installing the support rod into the slot**

Make sure the rod supports the hood securely from falling down on to your head or body.

**⚠ NOTICE****■ When closing the hood**

Be sure to return the support rod to its clip before closing the hood. Closing the hood with the support rod up could cause the hood to bend.

تلفن شبانه روزی: ۰۲۱-۸۸۶۲۰۸۵

FarmaSOS.com

## 4-3. Do-it-yourself maintenance Positioning a floor jack

When raising your vehicle with a floor jack, position the jack correctly. Improper placement may damage your vehicle or cause injury.

### Front

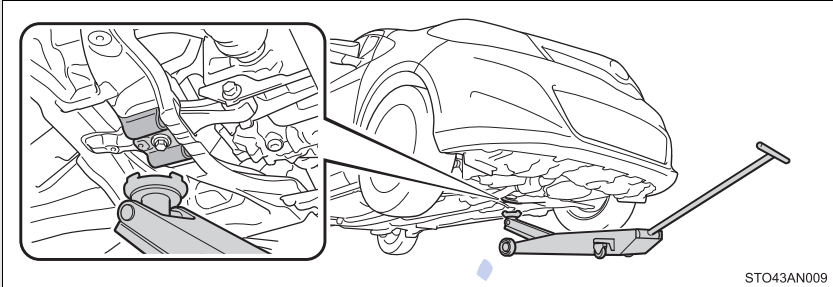

### Rear

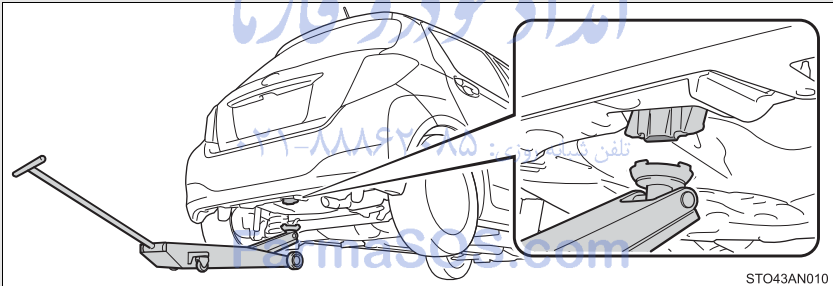



## ⚠ CAUTION

### ■ When raising your vehicle

Make sure to observe the following precautions to reduce the possibility of death or serious injury:

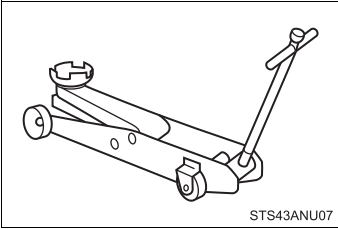

- Lift up the vehicle using a floor jack such as the one shown in the illustration.

- When using a floor jack, follow the instructions of the manual provided with the jack.
- Do not use the jack that was supplied with your vehicle.
- Do not put any part of your body underneath the vehicle when it is supported only by the floor jack.
- Always use floor jack and/or automotive jack stands on a solid, flat, level surface.
- Do not start the engine while the vehicle is supported by the floor jack.
- Stop the vehicle on level, firm ground, firmly set the parking brake and shift the shift lever to P (vehicles with an automatic transmission) or R (vehicles with a manual transmission).
- Make sure to set the floor jack properly at the jack point.  
Raising the vehicle with an improperly positioned floor jack will damage the vehicle and may cause the vehicle to fall off the floor jack.

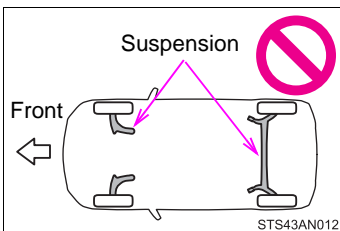

- Do not jack the vehicle at the suspension. The suspension may be damaged.

 CAUTION

- Do not raise the vehicle while someone is in the vehicle.
- When raising the vehicle, do not place any object on top of or underneath the floor jack.

امداد خودرو فارما

تلفن شبانه روزی: ۰۲۱-۸۸۸۶۲۰۸۵

FarmaSOS.com

# Engine compartment

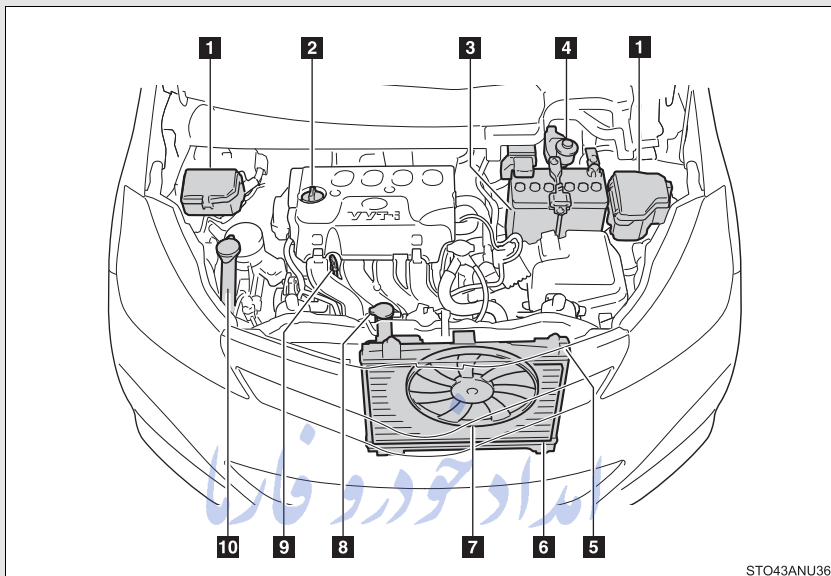

- |  |  |
|--|--|
| <b>1</b> Fuse boxes (→P. 275)            | <b>6</b> Condenser (→P. 248)                 |
| <b>2</b> Engine oil filler cap (→P. 245) | <b>7</b> Electric cooling fan                |
| <b>3</b> Battery (→P. 250)               | <b>8</b> Engine coolant reservoir (→P. 247)  |
| <b>4</b> Brake fluid reservoir (→P. 249) | <b>9</b> Engine oil level dipstick (→P. 244) |
| <b>5</b> Radiator (→P. 248)              | <b>10</b> Washer fluid tank (→P. 253)        |

## Engine oil

With the engine at operating temperature and turned off, check the oil level on the dipstick.

### ■ Checking the engine oil

**STEP 1** Park the vehicle on level ground. After warming up the engine and turning it off, wait more than 5 minutes for the oil to drain back into the bottom of the engine.

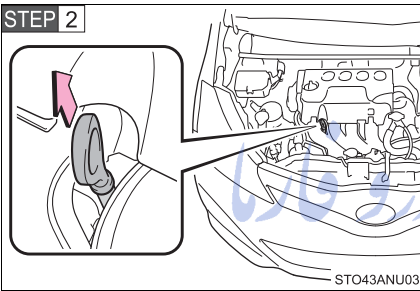

Holding a rag under the end, pull the dipstick out.

**STEP 3** Wipe the dipstick clean.

**STEP 4** Reinsert the dipstick fully.

**STEP 5** Holding a rag under the end, pull the dipstick out and check the oil level.

**STEP 6** Wipe the dipstick and reinsert it fully.

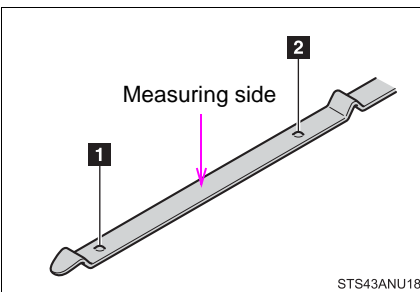

**1** Low

**2** Full

## ■ Adding engine oil

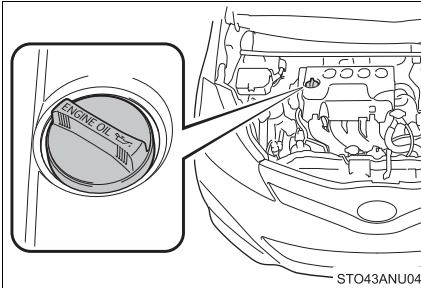

If the oil level is below or near the low level mark, add engine oil of the same type as that already in the engine.

Make sure to check the oil type and prepare the items needed before adding oil.

Engine oil selection	→P. 346
Oil quantity (Low → Full)	1.6 qt. (1.5 L, 1.3 Imp.qt.)
Item	Clean funnel

**STEP 1** Remove the oil filler cap by turning it counterclockwise.

**STEP 2** Add engine oil slowly, checking the dipstick.

**STEP 3** Install the oil filler cap by turning it clockwise.

## ■ Engine oil consumption

A certain amount of engine oil will be consumed while driving. In the following situations, oil consumption may increase, and engine oil may need to be refilled in between oil maintenance intervals.

- When the engine is new, for example directly after purchasing the vehicle or after replacing the engine
- If low quality oil or oil of an inappropriate viscosity is used
- When driving at high engine speeds or with a heavy load, when towing, or when driving while accelerating or decelerating frequently
- When leaving the engine idling for a long time, or when driving frequently thorough heavy traffic

 CAUTION

■ **Used engine oil**

- Used engine oil contains potentially harmful contaminants which may cause skin disorders such as inflammation and skin cancer, so care should be taken to avoid prolonged and repeated contact. To remove used engine oil from your skin, wash thoroughly with soap and water.
- Dispose of used oil and filters only in a safe and acceptable manner. Do not dispose of used oil and filters in household trash, in sewers or onto the ground. Call your Toyota dealer, service station or auto parts store for information concerning recycling or disposal.
- Do not leave used engine oil within the reach of children.

 NOTICE

■ **To prevent serious engine damage**

Check the oil level on a regular basis.

■ **When replacing the engine oil**

- Be careful not to spill engine oil on the vehicle components.
- Avoid overfilling, or the engine could be damaged.
- Check the oil level on the dipstick every time you refill the vehicle.
- Be sure the engine oil filler cap is properly tightened.

## Engine coolant

The coolant level is satisfactory if it is between the “FULL” and “LOW” lines on the reservoir when the engine is cold.

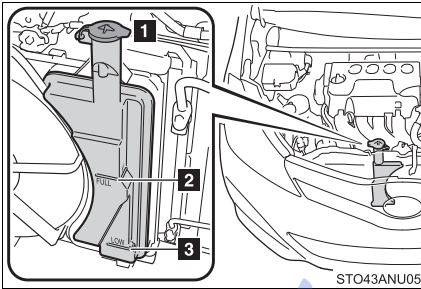

1 Reservoir cap

2 “FULL” line

3 “LOW” line

If the level is on or below the “LOW” line, add coolant up to the “FULL” line.

STO43ANU05

### ■ Coolant selection

Only use “Toyota Super Long Life Coolant” or a similar high quality ethylene glycol based non-silicate, non-amine, non-nitrite, and non-borate coolant with long-life hybrid organic acid technology.

Except Canada: “Toyota Super Long Life Coolant” is a mixture of 50% coolant and 50% deionized water. (Minimum temperature: -31°F [-35°C])

Canada: “Toyota Super Long Life Coolant” is a mixture of 55% coolant and 45% deionized water. (Minimum temperature: -44°F [-42°C])

For more details about engine coolant, contact your Toyota dealer.

### ■ If the coolant level drops within a short time of replenishing

Visually check the radiator, hoses, engine coolant reservoir cap, radiator cap, drain cock and water pump.

If you cannot find a leak, have your Toyota dealer test the cap and check for leaks in the cooling system.

 CAUTION

■ **When the engine is hot**

Do not remove the radiator cap.

The cooling system may be under pressure and may spray hot coolant if the cap is removed, causing serious injuries, such as burns.

 NOTICE

■ **When adding coolant**

Coolant is neither plain water nor straight antifreeze. The correct mixture of water and antifreeze must be used to provide proper lubrication, corrosion protection and cooling. Be sure to read the antifreeze or coolant label.

■ **If you spill coolant**

Be sure to wash it off with water to prevent it from damaging parts or paint.

**Radiator and condenser**

Check the radiator and condenser and clear away any foreign objects.

If either of the above parts are extremely dirty or you are not sure of their condition, have your vehicle inspected by your Toyota dealer.

 CAUTION

■ **When the engine is hot**

Do not touch the radiator or condenser as they may be hot and cause serious injuries, such as burns.



## Brake fluid

### ■ Checking fluid level

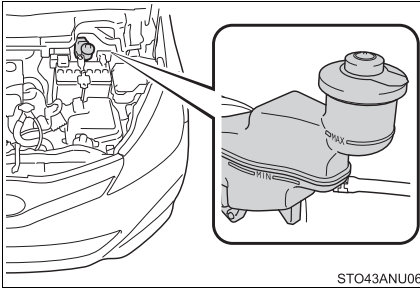

The brake fluid level should be between the “MAX” and “MIN” lines on the tank.

### ■ Adding fluid

Make sure to check the fluid type and prepare the necessary item.

Fluid type	FMVSS No.116 DOT 3 or SAE J1703 brake fluid
Item	Clean funnel

### ■ Brake fluid can absorb moisture from the air

Excess moisture in the brake fluid can cause a dangerous loss of braking efficiency. Use only newly opened brake fluid.

## ⚠ CAUTION

### ■ When filling the reservoir

Take care as brake fluid can harm your hands and eyes and damage painted surfaces.

If fluid gets on your hands or in your eyes, flush the affected area with clean water immediately.

If you still experience discomfort, consult a doctor.

 NOTICE

**■ If the fluid level is low or high**

It is normal for the brake fluid level to go down slightly as the brake pads wear out or when the fluid level in the accumulator is high.

If the reservoir needs frequent refilling, there may be a serious problem.

**Battery**

Check the battery as follows:

**■ Battery exterior**

Make sure that the battery terminals are not corroded and that there are no loose connections, cracks, or loose clamps.

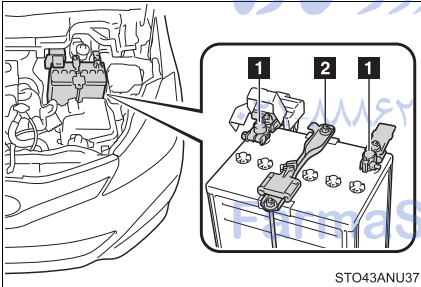

**1** Terminals

**2** Hold-down clamp

**■ Checking battery fluid**

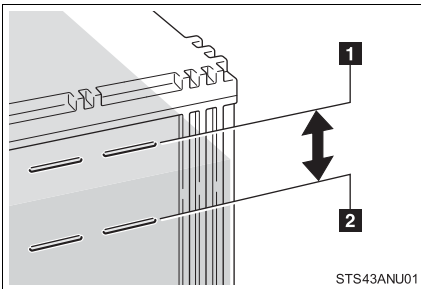

Check that the level is between the “UPPER LEVEL” and “LOWER LEVEL” lines.

**1** “UPPER LEVEL” line

**2** “LOWER LEVEL” line

If the fluid level is at or below the “LOWER LEVEL” line, add distilled water.

### ■ Adding distilled water

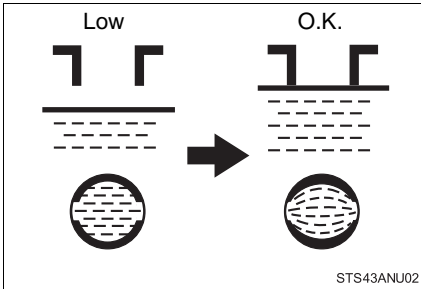

**STEP 1** Remove the vent plug.

**STEP 2** Add distilled water.

If the “UPPER LEVEL” line cannot be seen, check the fluid level by looking directly at the cell.

**STEP 3** Put the vent plug back on and close it securely.

### ■ Before recharging

When recharging, the battery produces hydrogen gas which is flammable and explosive. Therefore, observe the following before recharging:

- If recharging with the battery installed on the vehicle, be sure to disconnect the ground cable.
- Make sure the power switch on the charger is off when connecting and disconnecting the charger cables to the battery.

### ⚠ CAUTION

#### ■ Chemicals in the battery

Batteries contain poisonous and corrosive sulfuric acid and may produce hydrogen gas which is flammable and explosive. To reduce the risk of death or serious injury, take the following precautions while working on or near the battery:

- Do not cause sparks by touching the battery terminals with tools.
- Do not smoke or light a match near the battery.
- Avoid contact with eyes, skin and clothes.

 **CAUTION**

- Never inhale or swallow electrolyte.
- Wear protective safety glasses when working near the battery.
- Keep children away from the battery.

■ **Where to safety charge the battery**

Always charge the battery in an open area. Do not charge the battery in a garage or closed room where there is insufficient ventilation.

■ **Emergency measures regarding electrolyte**

- If electrolyte gets in your eyes  
Flush your eyes with clean water for at least 15 minutes and get immediate medical attention. If possible, continue to apply water with a sponge or cloth while traveling to the nearest medical facility.
- If electrolyte gets on your skin  
Wash the affected area thoroughly. If you feel pain or burning, get medical attention immediately.
- If electrolyte gets on your clothes  
It can soak through clothing on to your skin. Immediately take off the clothing and follow the procedure above if necessary.
- If you accidentally swallow electrolyte  
Drink a large quantity of water or milk. Get emergency medical attention immediately.

 **NOTICE**

■ **When recharging the battery**

Never recharge the battery while the engine is running. Also, be sure all accessories are turned off.

■ **When adding distilled water**

Avoid overfilling. Water spilled during battery recharging may cause corrosion.

## Washer fluid

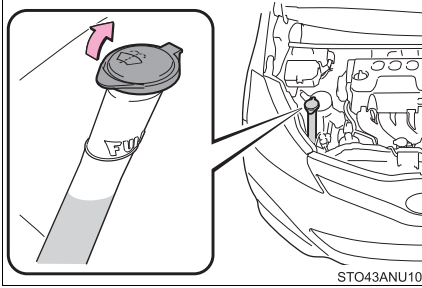

If neither washer does not work or the low windshield washer fluid warning light comes on (if equipped), the washer tank may be empty. Add washer fluid to “FULL” line.

### ⚠ CAUTION

#### ■ When adding washer fluid

Do not add washer fluid when the engine is hot or running as washer fluid contains alcohol and may catch fire if spilled on the engine etc.

### ⚠ NOTICE

#### ■ Do not use any fluid other than washer fluid

Do not use soapy water or engine antifreeze instead of washer fluid. Doing so may cause streaking on the vehicle's painted surfaces.

#### ■ Diluting washer fluid

Dilute washer fluid with water as necessary.

Refer to the freezing temperatures listed on the label of the washer fluid bottle.

## Tires

Replace or rotate tires in accordance with maintenance schedules and treadwear.

### ■ Checking tires

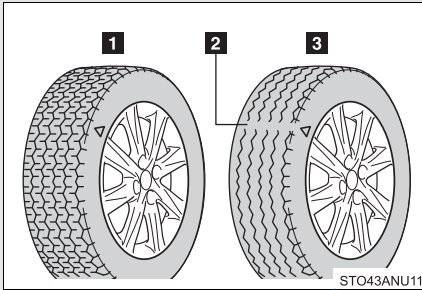

- 1 New tread
- 2 Treadwear indicator
- 3 Worn tread

The location of treadwear indicators is shown by the “TWI” or “△” marks, etc., molded on the sidewall of each tire.

Check spare tire condition and pressure if not rotated.

### ■ Tire rotation

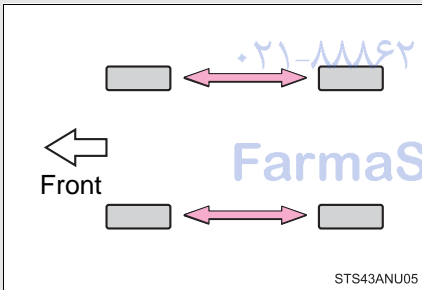

Rotate the tires in the order shown.

To equalize tire wear and extend tire life, Toyota recommends that tire rotation is carried out at the same interval as tire inspection.

Vehicles with P195/50R16 tires:

Do not fail to initialize the tire pressure warning system after tire rotation.

### ■ Tire pressure warning system (if equipped)

Your vehicle is equipped with a tire pressure warning system that uses tire pressure warning valves and transmitters to detect low tire inflation pressure before serious problems arise.  
(→P. 307)

The compact spare tire is not equipped with a tire pressure warning valve and transmitter.

### Installing tire pressure warning valves and transmitters (vehicles with a tire pressure warning system)

When replacing tires or wheels, tire pressure warning valves and transmitters must also be installed.

When new tire pressure warning valves and transmitters are installed, new ID codes must be registered in the tire pressure warning computer and the tire pressure warning system must be initialized. Have tire pressure warning valve and transmitter ID codes registered by your Toyota dealer. (→P. 256)

### ■ The tire pressure warning system must be initialized in the following circumstances:

- For vehicles with P195/50R16 tires, when rotating front and rear tires which have different tire inflation pressures
- When the tire inflation pressure is changed such as when changing traveling speed

When the tire pressure warning system is initialized, the current tire inflation pressure is set as the benchmark pressure.

### ■ How to initialize the tire pressure warning system

**STEP 1** Park the vehicle in a safe place and turn the engine switch to the "LOCK" position.

Initialization cannot be performed while the vehicle is moving.

**STEP 2** Adjust the tire pressure to the specified cold tire inflation pressure level. (→P. 351)

Make sure to adjust the tire pressure to the specified cold tire inflation pressure level. The tire pressure warning system will operate based on this pressure level.

**STEP 3** Turn the engine switch to the “ON” position.

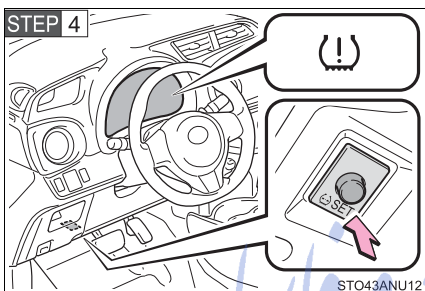

Press and hold the tire pressure warning reset switch until the tire pressure warning light blinks slowly 3 times.

**STEP 5** Wait for a few minutes with the engine switch in the “ON” position and then turn the engine switch to the “LOCK” position.

### Registering ID codes (vehicles with a tire pressure warning system)

The tire pressure warning valve and transmitter is equipped with a unique ID code. When replacing a tire pressure warning valve and transmitter, it is necessary to register the ID code. Have the ID code registered by your Toyota dealer.

#### ■ When to replace your vehicle's tires

Tires should be replaced if:

- You have tire damage such as cuts, splits, cracks deep enough to expose the fabric, and bulges indicating internal damage
- A tire goes flat repeatedly or cannot be properly repaired due to the size or location of a cut or other damage

If you are not sure, consult with your Toyota dealer.



### ■ Replacing tires and wheels (vehicles with a tire pressure warning system)

If the ID code of the tire pressure warning valve and transmitter is not registered, the tire pressure warning system will not work properly. After driving for about 20 minutes, the tire pressure warning light blinks for 1 minute and stays on to indicate a system malfunction.

### ■ Tire life

Any tire over 6 years old must be checked by a qualified technician even if it has seldom or never been used or damage is not obvious.

### ■ Routine tire inflation pressure checks (vehicles with a tire pressure warning system)

The tire pressure warning system does not replace routine tire inflation pressure checks. Make sure to check tire inflation pressure as part of your routine of daily vehicle checks.

### ■ Low profile tires (vehicles with P195/50R16 tires)

Generally, low profile tires will wear more rapidly and tire grip performance will be reduced on snowy and/or icy roads when compared to standard tires. Be sure to use snow tires or tire chains on snowy and/or icy roads and drive carefully at a speed appropriate for road and weather conditions.

### ■ Maximum load of tire

Check that the maximum load of the replacement tire is greater than 1/2 of the Gross Axle Weight Ratings (GAWR) of either the front axle or the rear axle, whichever is greater.

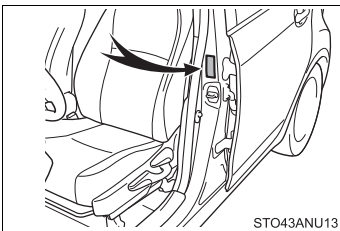

For the GAWR, see the Certification Label. For the maximum load of the tire, see the load limit at maximum cold tire inflation pressure mentioned on the sidewall of the tire. (→P. 356)

## ■ Tire types

### ● Summer tires

Summer tires are high-speed performance tires best suited to highway driving under dry conditions. Since summer tires do not have the same traction performance as snow tires, summer tires are inadequate for driving on snow-covered or icy roads. For driving on snow-covered roads or icy roads, the use of snow tires is recommended. When installing snow tires, be sure to replace all four tires.

### ● All season tires

All season tires are designed to provide better traction in snow and to be adequate for driving in most winter conditions as well as for use year-round. All season tires, however, do not have adequate traction performance compared with snow tires in heavy or loose snow. Also, all season tires fall short in acceleration and handling performance compared with summer tires in highway driving.

### ● Snow tires

For driving on snow-covered roads or icy roads, we recommend using snow tires. If you need snow tires, select tires of the same size, construction and load capacity as the originally installed tires. Since your vehicle has radial tires as original equipment, make sure your snow tires also have radial construction. Do not install studded tires without first checking local regulations for possible restrictions. Snow tires should be installed on all wheels. (→P. 172)

## ■ Initializing the tire pressure warning system (vehicles with a tire pressure warning system)

Initialize the system with the tire inflation pressure adjusted to the specified level.

### ■ If the tread on snow tires wears down below 0.16 in. (4 mm)

The effectiveness of the tires as snow tires is lost.

### ■ If you press the tire pressure warning reset switch accidentally (vehicles with a tire pressure warning system)

If initialization is performed, adjust the tire inflation pressure to the specified level and initialize the tire pressure warning system again.

### ■ When the initialization of the tire pressure warning system has failed (vehicles with a tire pressure warning system)

Initialization can be completed in a few minutes. However, in the following cases, the settings has not been recorded and the system will not operate properly. If repeated attempts to record tire inflation pressure settings are unsuccessful, have the vehicle inspected by your Toyota dealer.

- When operating the tire pressure warning reset switch, the tire pressure warning light does not blink 3 times.
- After driving for a certain period of time since the initialization has been completed, the warning light comes on after blinks for 1 minute.

### ■ Tire pressure warning system certification

**FCC ID: PAXPMVC010**

**FCC ID: HYQ23AAD**

**For vehicles sold in U.S.A.**

**NOTE:**

This device complies with part 15 of the FCC Rules. Operation is subject to the following two conditions: (1) This device may not cause harmful interference, and (2) this device must accept any interference received, including interference that may cause undesired operation.

**FCC WARNING:**

Changes or modifications not expressly approved by the party responsible for compliance could void the user's authority to operate the equipment.

 CAUTION

■ **When inspecting or replacing tires**

Observe the following precautions to prevent accidents.

Failure to do so may cause damage to parts of the drive train as well as dangerous handling characteristics, which may lead to an accident resulting in death or serious injury.

- Do not mix tires of different makes, models or tread patterns.  
Also, do not mix tires of remarkably different treadwear.
- Do not use tire sizes other than those recommended by Toyota.
- Do not mix differently constructed tires (radial, bias-belted or bias-ply tires).
- Do not mix summer, all season and snow tires.
- Do not use tires that have been used on another vehicle.  
Do not use tires if you do not know how they were used previously.
- Do not tow if your vehicle has a compact spare tire installed.

■ **When initializing the tire pressure warning system (vehicles with a tire pressure warning system)**

Do not operate the tire pressure warning reset switch without first adjusting the tire inflation pressure to the specified level. Otherwise, the tire pressure warning light may not come on even if the tire inflation pressure is low, or it may come on when the tire inflation pressure is actually normal.

 NOTICE

■ **Repairing or replacing tires, wheels, tire pressure warning valves, transmitters and tire valve caps (vehicles with a tire pressure warning system)**

- When removing or fitting the wheels, tires or the tire pressure warning valves and transmitters, contact your Toyota dealer as the tire pressure warning valves and transmitters may be damaged if not handled correctly.
- When replacing tire valve caps, do not use tire valve caps other than those specified. The cap may become stuck.

■ **To avoid damage to the tire pressure warning valves and transmitters (vehicles with a tire pressure warning system)**

When a tire is repaired with liquid sealants, the tire pressure warning valve and transmitter may not operate properly. If a liquid sealant is used, contact your Toyota dealer or other qualified service shop as soon as possible. Make sure to replace the tire pressure warning valve and transmitter when replacing the tire. (→P. 255)

■ **Driving on rough roads** تلفن شبانه روزی: ۰۸۵ ۸۸۶۲۰۸۵

Take particular care when driving on roads with loose surfaces or potholes.

These conditions may cause losses in tire inflation pressure, reducing the cushioning ability of the tires. In addition, driving on rough roads may cause damage to the tires themselves, as well as the vehicle's wheels and body.

■ **Low profile tires (vehicles with P195/50R16 tires)**

Low profile tires may cause greater damage than usual to the tire wheel when sustaining impact from the road surface. Therefore, pay attention to the following:

- Be sure to use proper tire inflation pressure. If tires are under-inflated, they may be damaged more severely.
- Avoid potholes, uneven pavement, curbs and other road hazards. Failure to do so may lead to severe tire and wheel damage.

■ **If tire inflation pressure of each tire becomes low while driving**

Do not continue driving, or your tires and/or wheels may be ruined.

## 4-3. Do-it-yourself maintenance

### Tire inflation pressure

#### ■ Tire inflation pressure

The recommended cold tire inflation pressure and tire size are displayed on the tire and loading information label. (→P. 351)

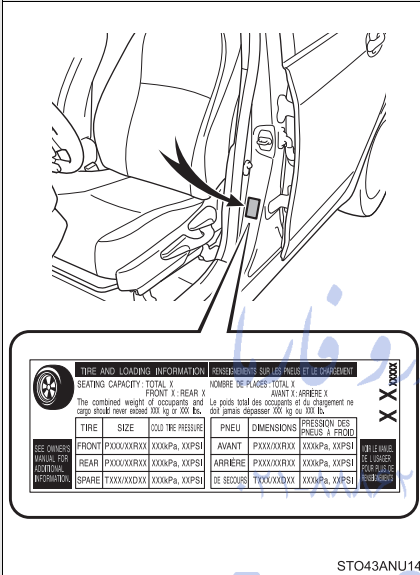

FarmaSOS.com

## ■ Inspection and adjustment procedure

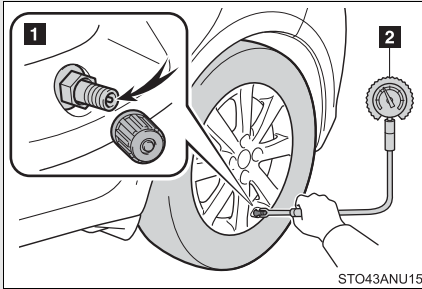

- 1 Tire valve
- 2 Tire pressure gauge

**STEP 1** Remove the tire valve cap.

**STEP 2** Press the tip of the tire pressure gauge onto the tire valve.

**STEP 3** Read the pressure using the gauge gradations.

**STEP 4** If the tire inflation pressure is not at the recommended level, adjust the pressure.

If you add too much air, press the center of the valve to deflate.

**STEP 5** After completing the tire inflation pressure measurement and adjustment, apply soapy water to the valve and check for leakage.

**STEP 6** Put the tire valve cap back on.

#### ■ Tire inflation pressure check interval

You should check tire inflation pressure every two weeks, or at least once a month.

Do not forget to check the spare.

#### ■ Effects of incorrect tire inflation pressure

Driving with incorrect tire inflation pressure may result in the following:

- Reduced fuel efficiency
- Reduced driving comfort and tire life
- Reduced safety
- Damage to the drive train

If a tire needs frequent inflating, have it checked by your Toyota dealer.

#### ■ Instructions for checking tire inflation pressure

When checking tire inflation pressure, observe the following:

- Check only when the tires are cold.

If your vehicle has been parked for at least 3 hours or has not been driven for more than 1 mile or 1.5 km, you will get an accurate cold tire inflation pressure reading.

- Always use a tire pressure gauge.

The appearance of the tire can be misleading. In addition, tire inflation pressures that is even just a few pounds off can affect ride quality and handling.

- Do not reduce tire inflation pressure after driving. It is normal for tire inflation pressure to be higher after driving.

- Never exceed the vehicle capacity weight.

Passengers and luggage weight should be placed so that the vehicle is balanced.



 CAUTION

■ **Proper inflation is critical to save tire performance**

Keep your tires properly inflated. Otherwise, the following conditions may occur and result in an accident causing death or serious injury:

- Excessive wear
- Uneven wear
- Poor handling
- Possibility of blowouts resulting from overheated tires
- Poor sealing of the tire bead
- Wheel deformation and/or tire separation
- A greater possibility of tire damage from road hazards

 NOTICE

■ **When inspecting and adjusting tire inflation pressure**

Be sure to put the tire valve caps back on. تلفن شبانه روزی: ۰۲۱-۸۸۰۳۰۰۰۰

Without the valve caps, dirt or moisture could get into the valve and cause air leakage, which could result in an accident. If the caps are lost, replace them as soon as possible. FarmasOS.com

## Wheels

**If a wheel is bent, cracked or heavily corroded, it should be replaced. Otherwise, the tire may separate from the wheel or cause a loss of handling control.**

### ■ Wheel selection

When replacing wheels, care should be taken to ensure that they are equivalent to those removed in load capacity, diameter, rim width and inset\*.

Replacement wheels are available at your Toyota dealer.

\*: Conventionally referred to as "offset".

Toyota does not recommend using the following:

- Wheels of different sizes or types
- Used wheels
- Bent wheels that have been straightened

### ■ Aluminum wheel precautions (if equipped)

- Use only Toyota wheel nuts and wrenches designed for use with your aluminum wheels.
- When rotating, repairing or changing your tires, check that the wheel nuts are still tight after driving 1000 miles (1600 km).
- Be careful not to damage the aluminum wheels when using tire chains.
- Use only Toyota genuine balance weights or equivalent and use a plastic or rubber hammer when balancing your wheels.

### ■ When replacing wheels (vehicles with a tire pressure warning system)

The wheels of your vehicle, except for the compact spare tire, are equipped with tire pressure warning valves and transmitters that allow the tire pressure warning system to provide advance warning in the event of a loss in tire inflation pressure. Whenever wheels are replaced, tire pressure warning valves and transmitters must be installed.

(→P. 255)

### ⚠ CAUTION

#### ■ When replacing wheels

- Do not use wheels that are a different size from those recommended in the Owner's Manual, as this may result in a loss of handling control.
- Never use an inner tube in a leaking wheel which is designed for a tubeless tire. Doing so may result in an accident, causing death or serious injury.

#### ■ When installing the wheel nuts

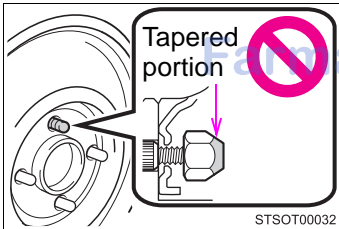

- Be sure to install the wheel nuts with the tapered end facing inward. Installing the nuts with the tapered end facing outward can cause wheel to break and eventually cause a wheel to come off while driving, which could lead to an accident resulting in death or serious injury.

- Never use oil or grease on the wheel bolts or wheel nuts. Oil and grease may cause the wheel nuts to be excessively tightened, leading to bolt or disc wheel damage. In addition, the oil or grease can cause the wheel nuts to loosen and the wheel may fall off, causing an accident and resulting in death or serious injury. Remove any oil or grease from the wheel bolts or wheel nuts.

 NOTICE

■ **Replacing tire pressure warning valves and transmitters (vehicles with a tire pressure warning system)**

- Because tire repair or replacement may affect the tire pressure warning valves and transmitters, make sure to have tires serviced by your Toyota dealer or other qualified service shop. In addition, make sure to purchase your tire pressure warning valves and transmitters at your Toyota dealer.
- Ensure that only genuine Toyota wheels are used on your vehicle. Tire pressure warning valves and transmitters may not work properly with non-genuine wheels.

امداد خودرو فارما

تلفن شبانه روزی: ۰۲۱-۸۸۶۲۰۸۵

FarmaSOS.com

## 4-3. Do-it-yourself maintenance

### Air conditioning filter

The air conditioning filter must be changed regularly to maintain air conditioning efficiency.

#### ■ Replacement method

**STEP 1** Turn the engine switch to the “LOCK” position.

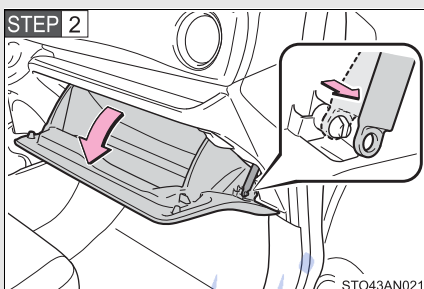

Open the glove box. Slide off the damper.

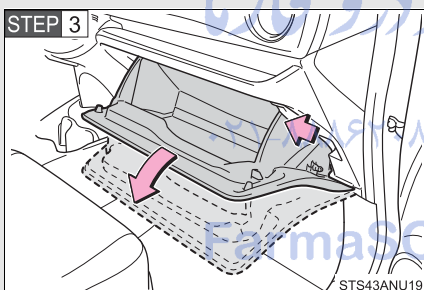

Press the outer facing side of the glove box to disconnect the upper claws.

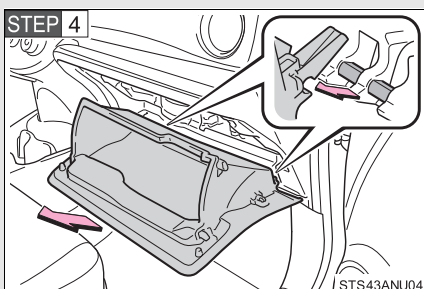

Pull out the glove box and disconnect the lower claws.

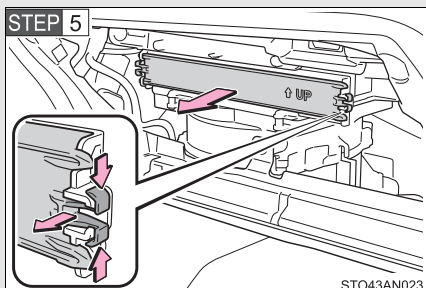

Remove the filter cover.

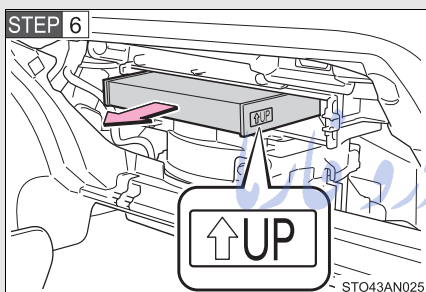

Remove the air conditioning filter and replace it with a new one.

The “↑UP” marks shown on the filter should be pointing up.

### ■ Checking interval [FarmaSOS.com](http://FarmaSOS.com)

Inspect and replace the air conditioning filter according to the maintenance schedule. In dusty areas or areas with heavy traffic flow, early replacement may be required. (For scheduled maintenance information, please refer to the “Scheduled Maintenance Guide” or “Owner’s Manual Supplement”.)

### ■ If air flow from the vents decreases dramatically

The filter may be clogged. Check the filter and replace if necessary.

#### NOTICE

#### ■ When using the air conditioning system

Make sure that a filter is always installed.

Using the air conditioning system without a filter may cause damage to the system.

## Wireless remote control battery\*

Replace the battery with a new one if it is depleted.

■ You will need the following items:

- Flathead screwdriver
- Lithium battery CR2016

■ Replacing the battery

### Type A

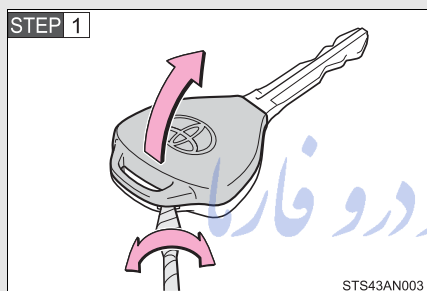

Remove the cover.

To prevent damage to the key, cover the tip of the screwdriver with a tape.

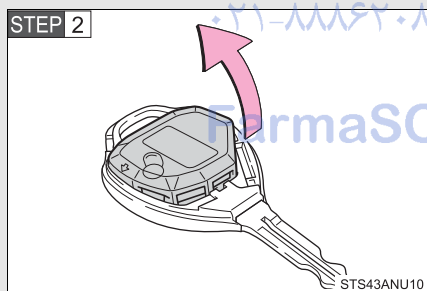

Remove the module.

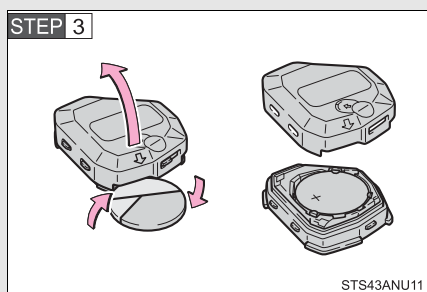

Open the case cover using a coin protected with tape etc. and remove the depleted battery.

Insert a new battery with the "+" terminal facing up.

\*: If equipped

## Type B

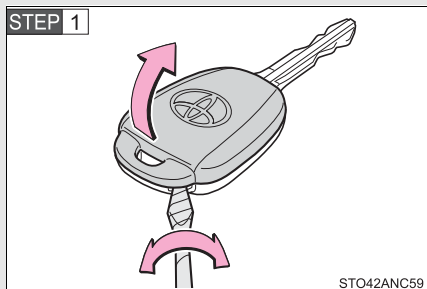

Remove the cover.

To prevent damage to the key, cover the tip of the screwdriver with a tape.

To prevent the buttons from being disassembled, face the button surface downward.

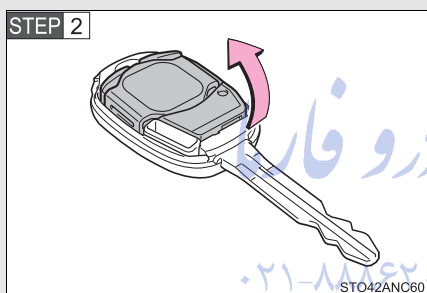

Remove the module.

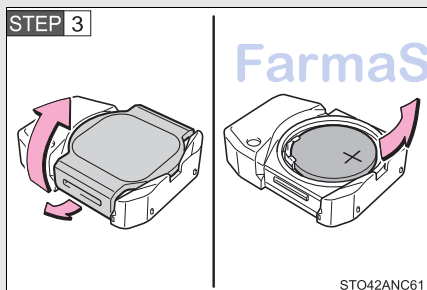

Open the case cover and remove the depleted battery.

Insert a new battery with the “+” terminal facing up.



### ■ Use a CR2016 lithium battery

- Batteries can be purchased at your Toyota dealer, local electrical appliance shops or camera stores.
- Replace only with the same or equivalent type recommended by the manufacturer.
- Dispose of used batteries according to local laws.

### ■ If the key battery is depleted

The following symptoms may occur:

- The wireless remote control will not function properly.
- The operational range will be reduced.

### ■ When replacing the module (type B only)

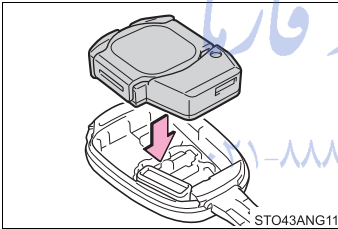

Replace the module from right above. Replacing it from diagonally above may prevent the key buttons from operating properly.

FarmaSOS.com

### ⚠ CAUTION

#### ■ Removed battery and other parts

These parts are small and if swallowed by a child, they can cause choking. Keep away from children. Failure to do so could result in death or serious injury.

 NOTICE

■ **For normal operation after replacing the battery**

Observe the following precautions to prevent accidents:

- Always work with dry hands.  
Moisture may cause the battery to rust.
- Do not touch or move any other components inside the remote control.
- Do not bend either of the battery terminals.

امداد خودرو فارما

تلفن شبانه روزی: ۰۲۱-۸۸۸۶۲۰۸۵

FarmaSOS.com

## 4-3. Do-it-yourself maintenance

### Checking and replacing fuses

If any of the electrical components do not operate, a fuse may have blown. If this happens, check and replace the fuses as necessary.

**STEP 1** Turn the engine switch to the “LOCK” position.

**STEP 2** Open the fuse box cover.

#### Engine compartment (type A fuse box)

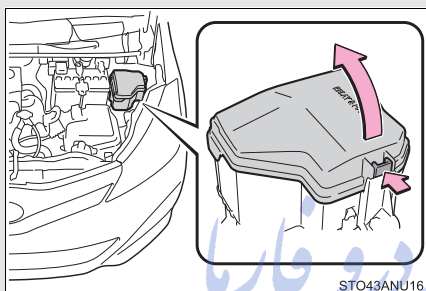

Push the tab in and lift the lid off.

#### Engine compartment (type B fuse box)

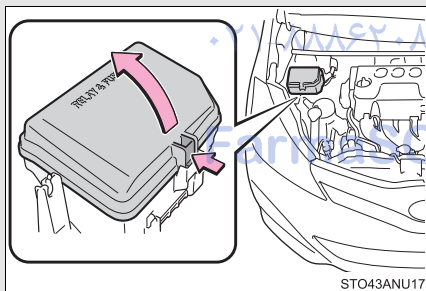

Push the tab in and lift the lid off.

#### Engine compartment (type C fuse box)

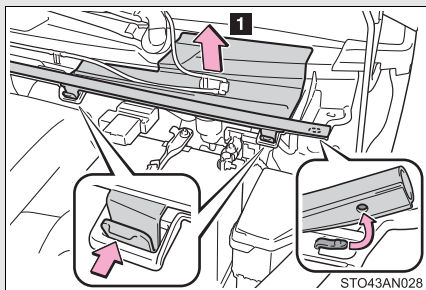

**1** Pull the rubber strip on the edge to unhook it from the cover, and then push the tabs in and lift the cover off.

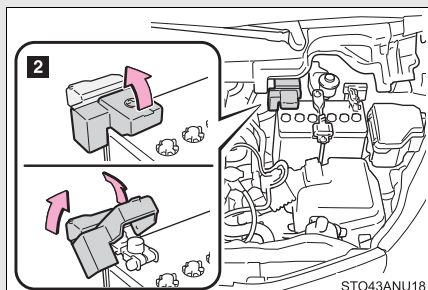

- 2 Remove the battery terminal cover and then the fuse box cover.

### Under the driver's side instrument panel

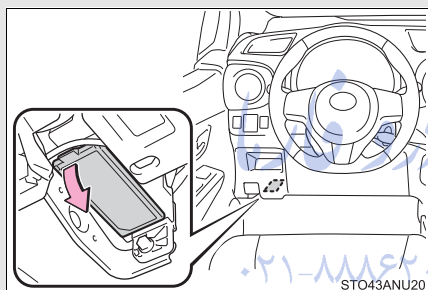

Remove the lid.

**STEP 3** After a system failure, see “Fuse layout and amperage ratings” (→P. 279) for details about which fuse to check.

**STEP 4** Remove the fuse.

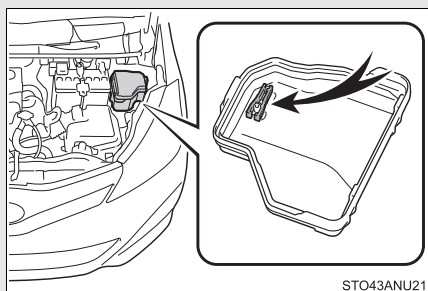

Only type A fuse can be removed using the pullout tool.

The pullout tool is located on the back of the type A fuse box cover.

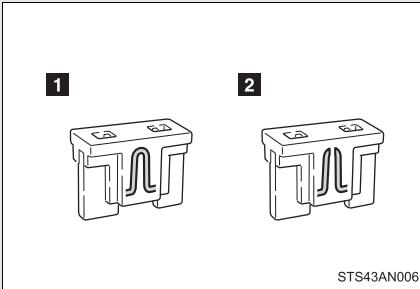
**STEP 5** Check if the fuse is blown.**Type A****1** Normal fuse**2** Blown fuse

Replace the blown fuse with a new fuse of an appropriate amperage rating. The amperage rating can be found on the fuse box lid.

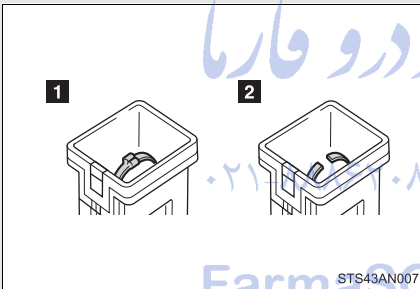
**Type B****1** Normal fuse**2** Blown fuse

Replace the blown fuse with a new fuse of an appropriate amperage rating. The amperage rating can be found on the fuse box lid.

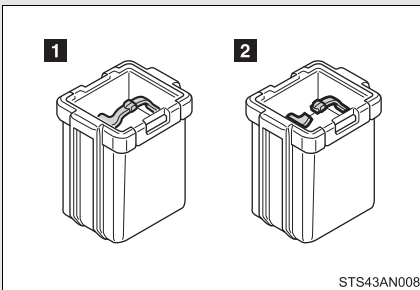
**Type C****1** Normal fuse**2** Blown fuse

Replace the blown fuse with a new fuse of an appropriate amperage rating. The amperage rating can be found on the fuse box lid.

### Type D

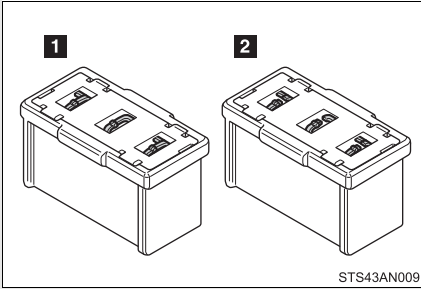

**1** Normal fuse

**2** Blown fuse

Replace the blown fuse with a new fuse of an appropriate amperage rating. The amperage rating can be found on the fuse box lid.

### Type E

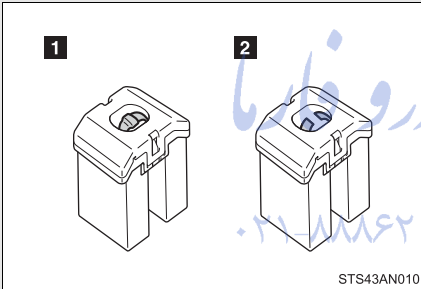

**1** Normal fuse

**2** Blown fuse

Replace the blown fuse with a new fuse of an appropriate amperage rating. The amperage rating can be found on the fuse box lid.

### Type F

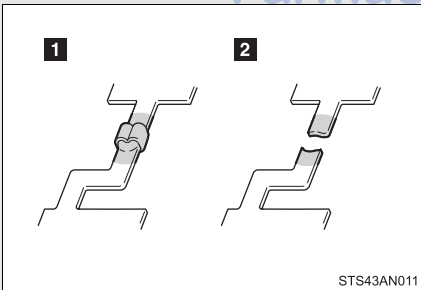

**1** Normal fuse

**2** Blown fuse

Contact your Toyota dealer.

## Fuse layout and amperage ratings

### Engine compartment (type A fuse box)

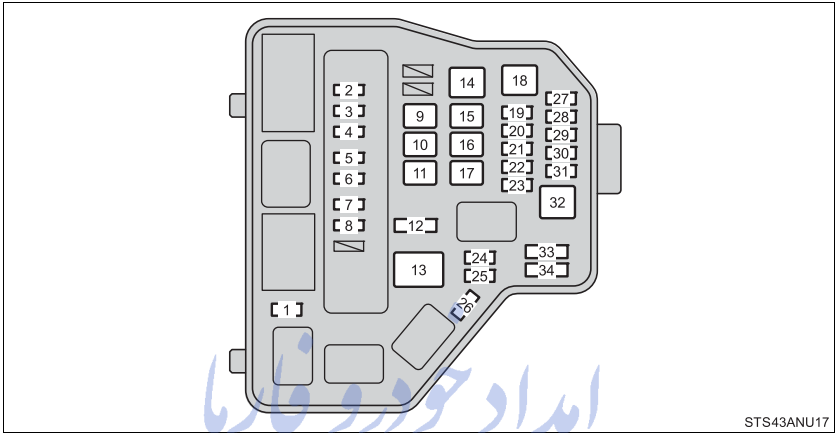

Fuse		Ampere	Circuit
1	ID/UP	7.5 A	Multiport fuel injection system/ sequential multiport fuel injection system
2	EFI MAIN	20 A	Multiport fuel injection system/ sequential multiport fuel injection system
3	EFI NO.3	7.5 A	Multiport fuel injection system/ sequential multiport fuel injection system
4	HORN	10 A	Horn
5	EFI NO.2	10 A	Multiport fuel injection system/ sequential multiport fuel injection system
6	IG2	10 A	Multiport fuel injection system/ sequential multiport fuel injection system, airbag system, stop lights, front passenger occupant classifi- cation system

Fuse		Ampere	Circuit
7	IGN	15 A	Multiport fuel injection system/ sequential multiport fuel injection system
8	MET	7.5 A	Gauges and meters
9	EPS	50 A	Electric power steering system
10	ABS NO.2	30 A	Anti-lock brake system, vehicle sta- bility control system
11	DEF	30 A	Rear window defogger, outside rear view mirror defoggers
12	SPARE	10 A	Spare fuse
13	PTC	80 A	PTC heater, outside rear view mir- ror defoggers
14	HTR	40 A	Air conditioning system
15	H-LP CLN	30 A	No circuit
16	RDI FAN	30 A	Electric cooling fan
17	ABS NO.1	50 A	Anti-lock brake system, vehicle sta- bility control system
18	BBC	40 A	No circuit
19	ST	30 A	Starting system
20	AMP	15 A	No circuit
21	D/L NO.2	25 A	No circuit
22	D.C.C	30 A	DOME, ECU-B NO.1, ECU-B NO.2
23	STR LOCK	20 A	No circuit
24	ECU-B NO.1	5 A	Multiport fuel injection system/ sequential multiport fuel injection system, main body ECU
25	DOME	15 A	Interior light, personal lights, audio system, vehicle stability control system
26	MIR-HTR	10 A	No circuit



Fuse		Ampere	Circuit
27	ETCS	10 A	Multiport fuel injection system/ sequential multiport fuel injection system
28	HAZ	15 A	Turn signal lights, emergency flashers
29	AM2	7.5 A	Multiport fuel injection system/ sequential multiport fuel injection system, starting system
30	ECU-B NO.2	5 A	Gauges and meters, wireless remote control system, tire pres- sure warning system, front passen- ger occupant classification system
31	ALT-S	7.5 A	Charging system
32	R/I	50 A	EFI MAIN, EFI NO.2, EFI NO.3, IG2, IGN, MET, HORN
33	SPARE	20 A	Spare fuse
34	SPARE	30 A	Spare fuse

FarmaSOS.com

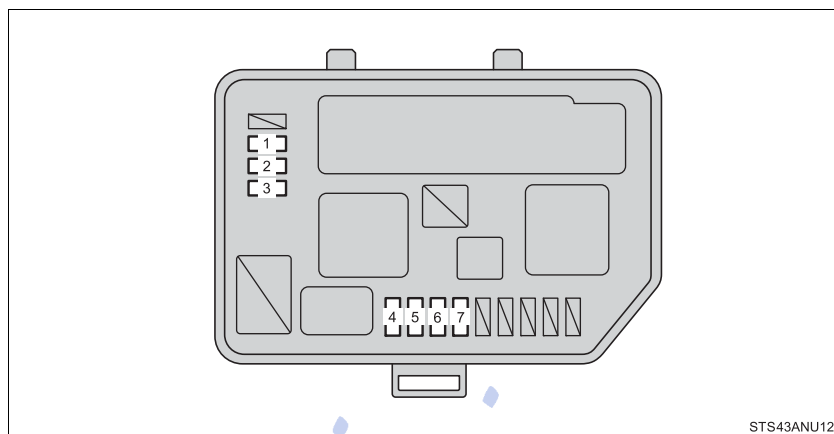
**Engine compartment (type B fuse box)**

Fuse		Ampere	Circuit
1	EU-DRL	15 A	No circuit
2	S-HORN	10 A	Multiport fuel injection system/ sequential multiport fuel injection system
3	H-LP MAIN	7.5 A	Headlights
4	H-LP RH HI	10 A	Right-hand headlight (high beam)
5	H-LP LH HI	10 A	Left-hand headlight (high beam), gauges and meters
6	H-LP RH LO	10 A	Right-hand headlight (low beam)
7	H-LP LH LO	10 A	Left-hand headlight (low beam), front fog lights

### Engine compartment (type C fuse box)

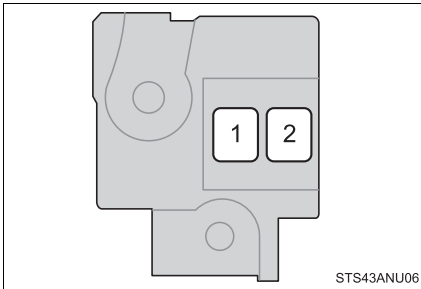

Fuse		Ampere	Circuit
1	ALT	120 A	ID/UP, EPS, ABS NO.2, DEF, PTC, HTR, H-LP CLN, RDI FAN, ABS NO.1, TAIL NO.2, PANEL, DOOR R/R, DOOR P, ECU-IG NO.1, ECU-IG NO.2, A/C, GAUGE, WASHER, WIPER, WIPER RR, P/W, DOOR R/L, DOOR, CIG, ACC, D/L, OBD, STOP, AM1, FOG FR
2	MAIN	80 A	BBC, ST, AMP, D/L NO.2, D.C.C, STR LOCK, MIR-HTR, ETCS, HAZ, AM2, ALT-S, R/I, EU-DRL, S-HORN, H-LP MAIN, H-LP RH HI, H-LP LH HI, H-LP RH LO, H-LP LH LO

### Under the driver's side instrument panel

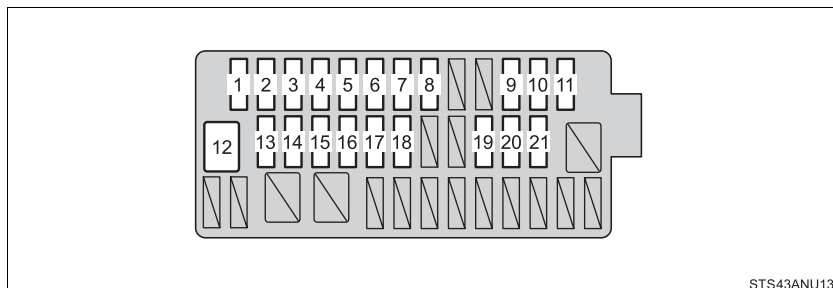

Fuse		Ampere	Circuit
1	TAIL NO.2	10 A	Parking lights, tail lights, license plate lights, side marker lights
2	PANEL	5 A	Gauges and meters, instrument panel lights, switch illumination
3	DOOR R/R	20 A	Power windows
4	DOOR P	20 A	Power windows
5	ECU-IG NO.1	5 A	Electric cooling fan, rear window defogger, vehicle stability control system, electric power steering system, main body ECU, wireless remote control system, tire pressure warning system
6	ECU-IG NO.2	5 A	Vehicle stability control system
7	A/C	7.5 A	Air conditioning system, rear window defogger, outside rear view mirror defoggers
8	GAUGE	10 A	Back-up lights, shift lock control system, audio system, charging system, multiport fuel injection system/ sequential multiport fuel injection system
9	WASHER	15 A	Windshield washer
10	WIPER	20 A	Windshield wiper

Fuse		Ampere	Circuit
11	WIPER RR	15 A	Rear window wiper
12	P/W	30 A	Power windows
13	DOOR R/L	20 A	Power windows
14	DOOR	20 A	Power windows
15	CIG	15 A	Power outlets
16	ACC	5 A	Main body ECU, outside rear view mirrors, audio system, shift lock control system
17	D/L	25 A	Power door lock system, main body ECU
18	OBD	7.5 A	On-board diagnosis system
19	STOP	7.5 A	Multipoint fuel injection system/ sequential multipoint fuel injection system, vehicle stability control system, stop lights, high mounted stop-light
20	AM1	7.5 A	Starting system, engine switch
21	FOG FR	15 A	Front fog lights

#### ■ After a fuse is replaced

- If the lights do not turn on even after the fuse has been replaced, a bulb may need replacement. (→P. 287)
- If the replaced fuse blows again, have the vehicle inspected by your Toyota dealer.

#### ■ If there is an overload in a circuit

The fuses are designed to blow, protecting the wiring harness from damage.

#### ■ When replacing light bulbs

Toyota recommends that you use genuine Toyota products designed for this vehicle.

Because certain bulbs are connected to circuits designed to prevent overload, non-genuine parts or parts non designed for this vehicle may be unusable.

■ **When reinstalling the cover (type C fuse box cover only)**

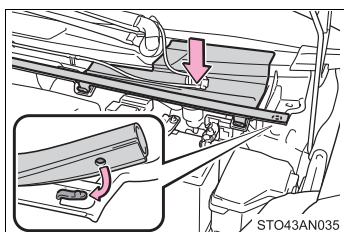

Reinstall the cover, and then hook the rubber strip's groove onto the cover.

**⚠ CAUTION**

■ **To prevent system breakdowns and vehicle fire**

Observe the following precautions.

Failure to do so may cause damage to the vehicle, and possibly a fire or injury.

- Never use a fuse of a higher amperage rating than that indicated, or use any other object in place of a fuse.
- Always use a genuine Toyota fuse or equivalent. تلفن شیا
- Never replace a fuse with a wire, even as a temporary fix.
- Do not modify the fuses or fuse boxes.

**⚠ NOTICE**

■ **Before replacing fuses**

Have the cause of electrical overload determined and repaired by your Toyota dealer as soon as possible.

## Light bulbs

You may replace the following bulbs by yourself. The difficulty level of replacement varies depending on the bulb. If necessary bulb replacement seems difficult to perform, contact your Toyota dealer.

For more information about replacing other light bulbs, contact your Toyota dealer.

### ■ Preparing for light bulb replacement

Check the wattage of the light bulb to be replaced. (→P. 352)

### ■ Front bulb locations

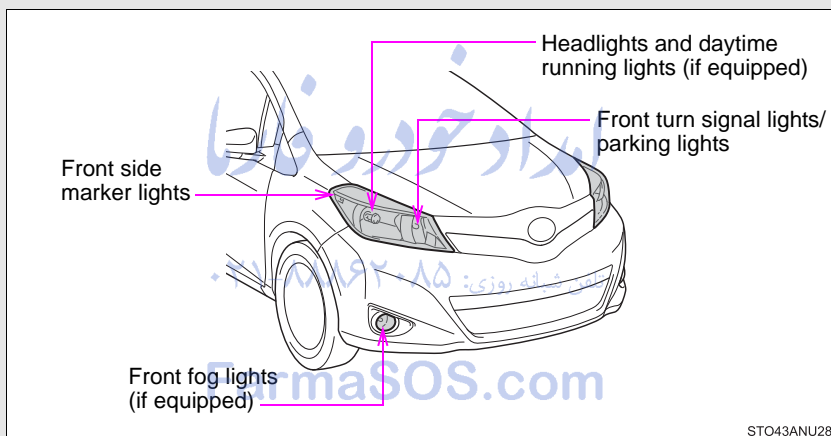

### ■ Rear bulb locations

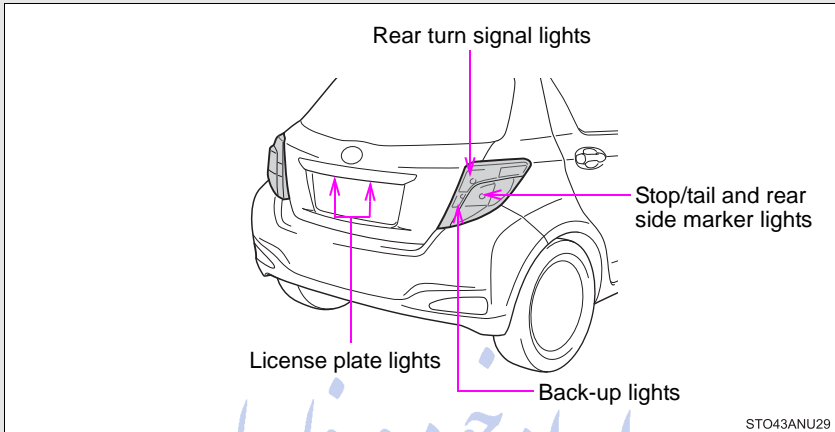

### Replacing light bulbs

#### ■ Headlights and daytime running lights (if equipped)

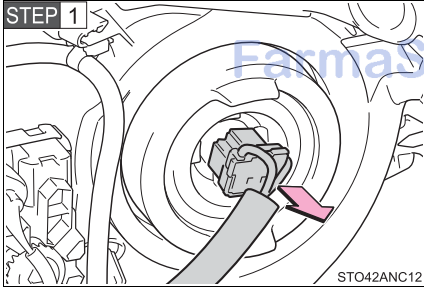

Unplug the connector.

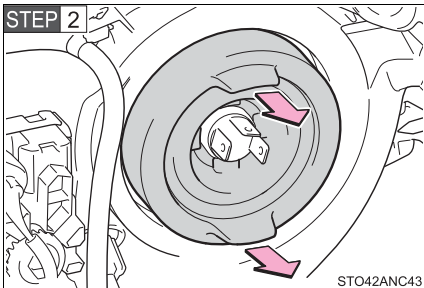

Remove the rubber cover.



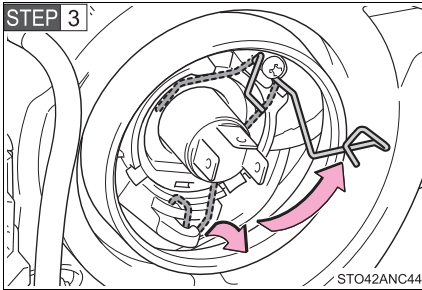

Release the bulb retaining spring.

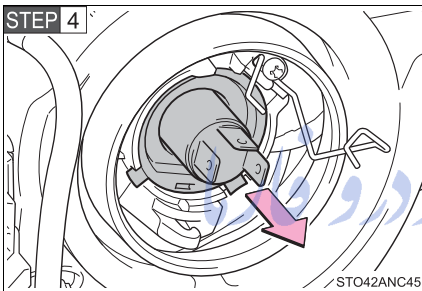

Remove the bulb.

To install a new bulb, align the tabs of the bulb with the cutouts of the mounting hole.

■ Front fog lights (if equipped)

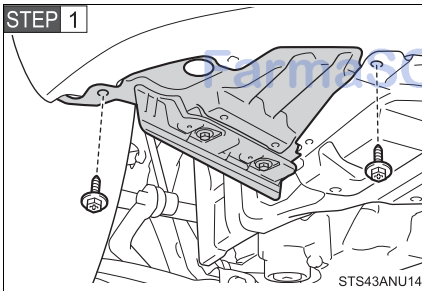

Remove the screws.

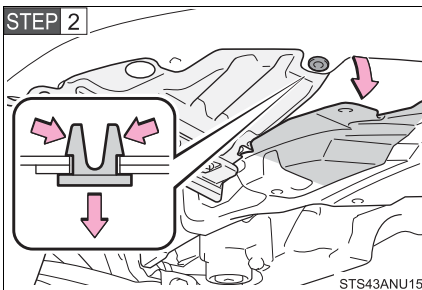

Remove the grommet.

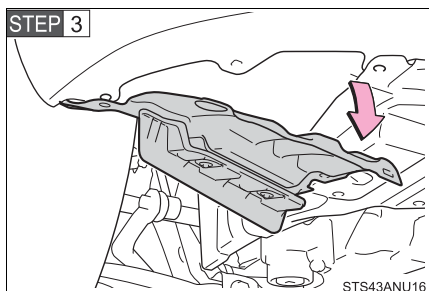

Partly remove the fender liner.

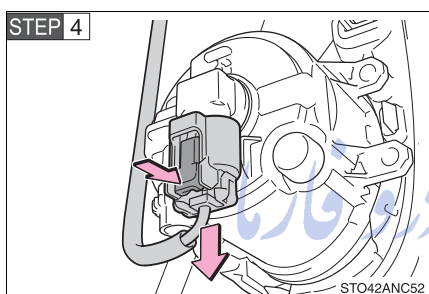

Unplug the connector while depressing the lock release.

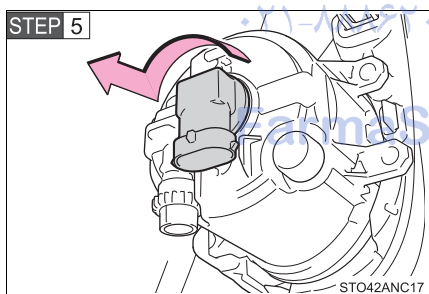

Turn the bulb base counterclockwise.

### ■ Front side marker lights

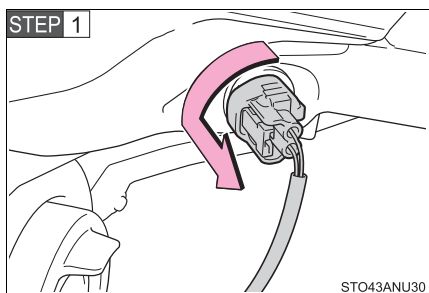

Turn the bulb base counterclockwise.

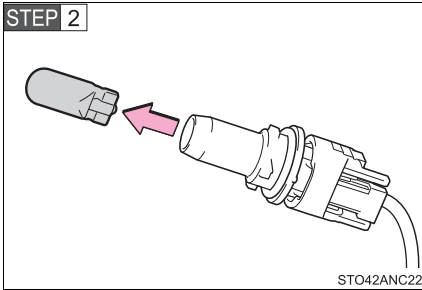

Remove the light bulb.

■ Front turn signal lights/parking lights

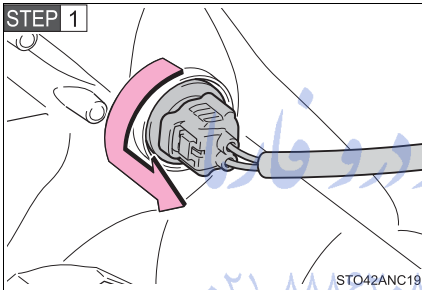

Turn the bulb base counterclockwise.

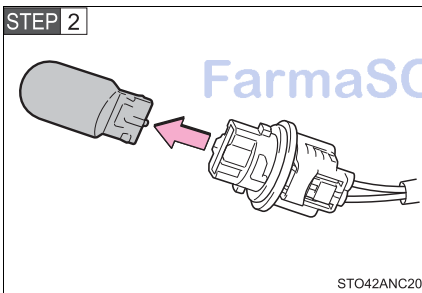

Remove the light bulb.

امداد خودرو بازرسی  
تلفن شبانه روزی: ۰۲۱ ۸۸۷۷۱۸۵  
FarmaSOS.com

### ■ Back-up lights, stop/tail and rear side marker lights, and rear turn signal lights

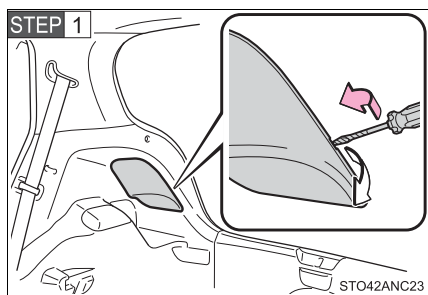

Open the back door and remove the cover.

To prevent damaging the vehicle, wrap the screwdriver with a tape.

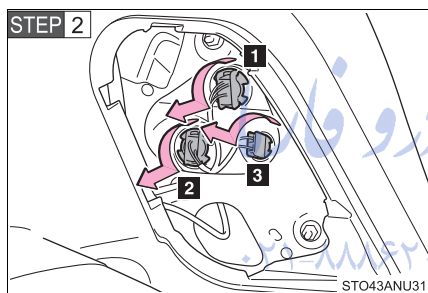

Turn the bulb base counterclockwise.

- 1 Rear turn signal light
- 2 Stop/tail and rear side marker lights
- 3 Back-up light

تلفن شبانه روزی: ۰۲۱-۸۸۴۲۸۵

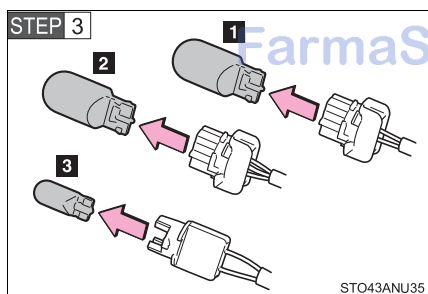

Remove the light bulb.

- 1 Rear turn signal light
- 2 Stop/tail and rear side marker lights
- 3 Back-up light

### ■ License plate light

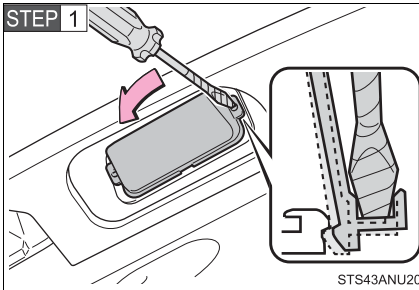

Remove the cover.

Insert a properly sized screwdriver into the hole of the cover, and pry off the cover as shown in the illustration.

To prevent damaging the vehicle, wrap the screwdriver with a tape.

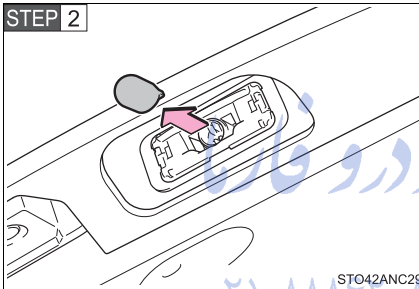

Remove the light bulb.

### ■ Lights other than the above

If the high mounted stoplight has burnt out, have it replaced by your Toyota dealer.

### ■ LED high mounted stoplight

The high mounted stoplight consists of a number of LEDs. If any of the LEDs burn out, take your vehicle to your Toyota dealer to have the light replaced.

### ■ Condensation build-up on the inside of the lens

Contact your Toyota dealer for more information in the following situations. Temporary condensation build-up on the inside of the headlight lens does not indicate a malfunction.

- Large drops of water have built up on the inside of the lens.
- Water has built up inside the headlight.

### ■ When replacing light bulbs

→P. 285

 CAUTION

■ **Replacing light bulbs**

- Turn off the lights. Do not attempt to replace the bulb immediately after turning off the lights.

The bulbs become very hot and may cause burns.

- Do not touch the glass portion of the light bulb with bare hands. Hold the bulb by the plastic or metal portion.

If the bulb is scratched or dropped, it may blow out or crack.

- Fully install light bulbs and any parts used to secure them. Failure to do so may result in head damage, fire, or water entering the headlight unit. This may damage the headlights or cause condensation to build up on the lens.

■ **To prevent damage or fire**

Make sure bulbs are fully seated and locked.

امداد خودرو فارما  
تلفن شبانه روزی: ۰۲۱-۸۸۶۲۰۸۵

FarmaSOS.com

## When trouble arises

# 5

### 5-1. Essential information

Emergency flashers .....	296
If your vehicle needs to be towed .....	297
If you think something is wrong .....	303
Fuel pump shut off system .....	304

### 5-2. Steps to take in an emergency

If a warning light turns on or a warning buzzer sounds.....	305
If you have a flat tire.....	315
If the engine will not start.....	327
If the shift lever cannot be shifted from P (vehicles with an automatic transmission) .....	328
If you lose your keys .....	329
If the vehicle battery is discharged .....	330
If your vehicle overheats .....	334
If the vehicle becomes stuck .....	337
If your vehicle has to be stopped in an emergency .....	339

## 5-1. Essential information

### Emergency flashers

Use the emergency flashers if the vehicle malfunctions or is involved in an accident.

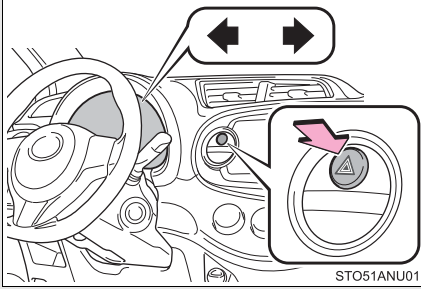

Press the switch to flash all the turn signal lights. To turn them off, press the switch once again.

#### NOTICE

#### ■ To prevent battery discharge

Do not leave the emergency flashers on longer than necessary when the engine is not running.

تلفن شبانه روزی: ۰۸۵-۸۸۶۲۰۲۱

FarmaSOS.com



## If your vehicle needs to be towed

**If towing is necessary, we recommend having your vehicle towed by your Toyota dealer or a commercial towing service, using a lift-type truck or flatbed truck.**

**Use a safety chain system for all towing, and abide by all state/provincial and local laws.**

### Before towing

The following may indicate a problem with your transmission. Contact your Toyota dealer before towing.

- The engine is running but the vehicle will not move.
- The vehicle makes an abnormal sound.

### Emergency towing

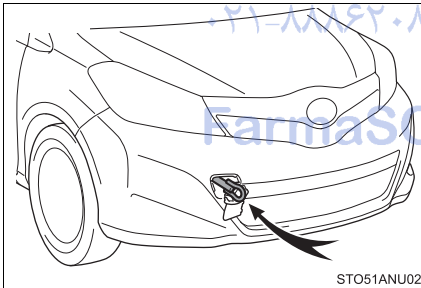

If a tow truck is not available in an emergency, your vehicle may be temporarily towed using a cable or chain secured to the emergency towing eyelet. This should only be attempted on hard surfaced roads for short distances at low speeds.

A driver must be in the vehicle to steer and operate the brakes. The vehicle's wheels, drive train, axles, steering and brakes must be in good condition.

## Installing towing eyelet

### Type A

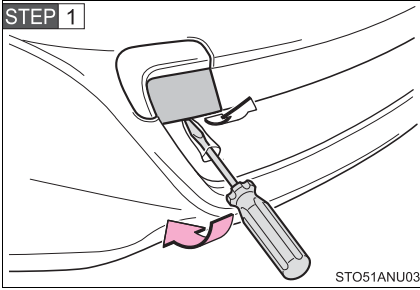

Remove the eyelet cover using a flathead screwdriver.

To protect the bodywork, place a rag between the screwdriver and the vehicle body as shown in the illustration.

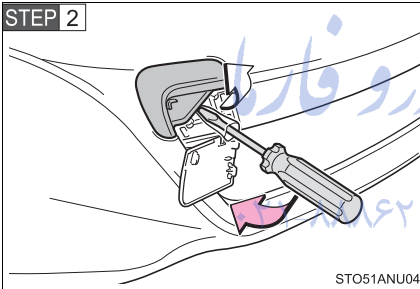

Remove the eyelet cover using a flathead screwdriver.

To protect the bodywork, place a rag between the screwdriver and the vehicle body as shown in the illustration.

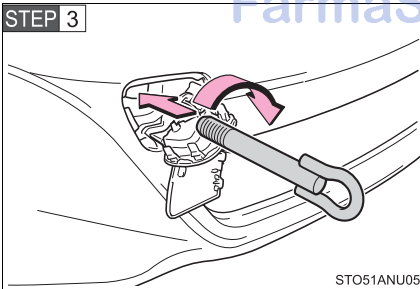

Insert the towing eyelet into the hole and tighten partially by hand.

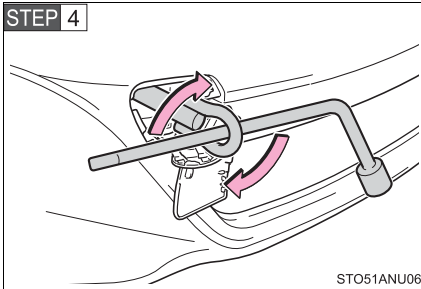

Tighten down the towing eyelet securely using a wheel nut wrench.

### Type B

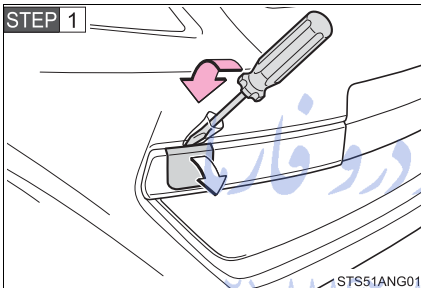

Remove the eyelet cover using a flathead screwdriver.

To protect the bodywork, place a rag between the screwdriver and the vehicle body as shown in the illustration.

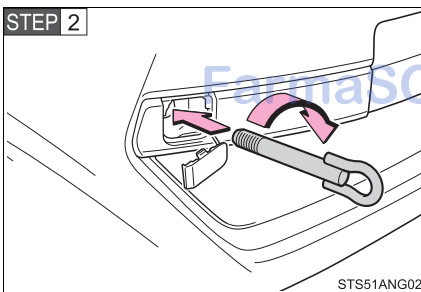

Insert the towing eyelet into the hole and tighten partially by hand.

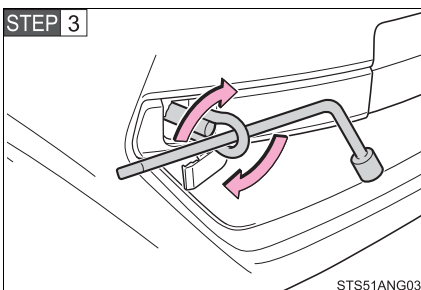

Tighten down the towing eyelet securely using a wheel nut wrench.

### Towing with a sling-type truck

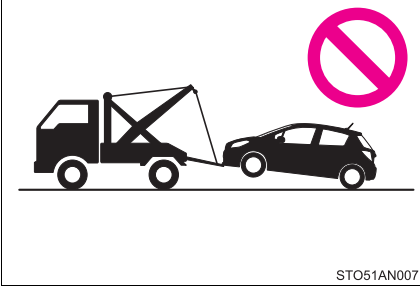

STO51AN007

Do not tow with a sling type truck to prevent body damage.

### Towing with a wheel-lift type truck

#### From the front

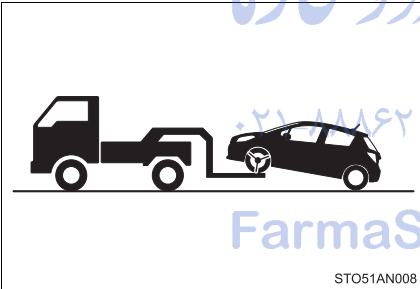

STO51AN008

Release the parking brake.

#### From the rear

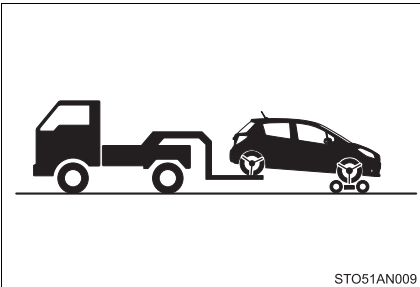

STO51AN009

Vehicles with an automatic transmission: Use a towing dolly under the front wheels.

Vehicles with a manual transmission: We recommend using a towing dolly under the front wheels.

When not using a towing dolly, turn the engine switch to the "ACC" position and shift the shift lever to N.

## Using a flatbed truck

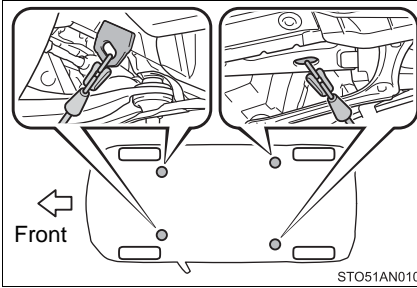

If your Toyota is transported by a flatbed truck, it should be tied down at the locations shown in the illustration.

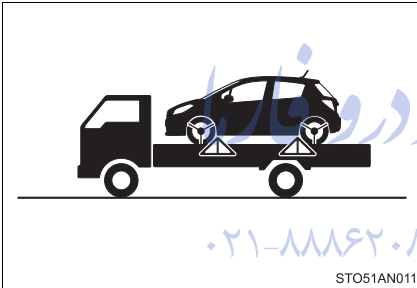

If you use chains or cables to tie down your vehicle, the angles shaded in black must be 45°.

Do not overly tighten the tie downs or the vehicle may be damaged.

تلفن شبانه روزی: ۰۲۱-۸۸۶۲۰۸۵

### ■ Before emergency towing

**STEP 1** Release the parking brake.

**STEP 2** Shift the shift lever to N.

**STEP 3** Turn the engine switch to the "ACC" (engine off) or "ON" (engine running) position.

### ■ Emergency towing eyelet location

→P. 315

FarmaSOS.com

 CAUTION

■ **Caution while towing**

- Use extreme caution when towing the vehicle.  
Avoid sudden starts or erratic driving maneuvers which place excessive stress on the emergency towing eyelet and the cables or chains. Always be cautious of the surroundings and other vehicles while towing.
- If the engine is not running, the power assist for the brakes and steering will not function, making steering and braking more difficult.

■ **Installing towing eyelet to the vehicle**

Make sure that towing eyelet is installed securely.  
If not securely installed, towing eyelet may come loose during towing. This may lead to accidents that cause serious injury or even death.

 NOTICE

■ **To prevent causing serious damage to the transmission when towing using a wheel-lift type truck (vehicles with an automatic transmission)**

Never tow this vehicle from the rear with the front wheels on the ground.

■ **To prevent damage to the vehicle when towing using a wheel-lift type truck (vehicles with an automatic transmission)**

When raising the vehicle, ensure adequate ground clearance for towing at the opposite end of the raised vehicle. Without adequate clearance, the vehicle could be damaged while being towed.

■ **To prevent damage to the vehicle when towing using a wheel-lift type truck (vehicles with a manual transmission)**

- Do not tow the vehicle from the rear when the engine switch is in the "LOCK" position or the key is removed.  
The steering lock mechanism is not strong enough to hold the front wheel straight.
- When raising the vehicle, ensure adequate ground clearance for towing at the opposite end of the raised vehicle. Without adequate clearance, the vehicle could be damaged while being towed.

■ **To prevent body damage when towing with a sliding-type truck**

Do not tow with a sliding-type truck, either from the front or rear.

## If you think something is wrong

**If you notice any of the following symptoms, your vehicle probably needs adjustment or repair. Contact your Toyota dealer as soon as possible.**

### ■ Visible symptoms

- Fluid leaks under the vehicle  
(Water dripping from the air conditioning after use is normal.)
- Flat-looking tires or uneven tire wear
- High engine coolant temperature warning light flashes or comes on
- Low engine coolant temperature indicator comes on or does not come on continuously

### ■ Audible symptoms

- Changes in exhaust sound
- Excessive tire squeal when cornering
- Strange noises related to the suspension system
- Pinging or other noises related to the engine

### ■ Operational symptoms

- Engine misfire, stumbling or running roughly
- Appreciable loss of power
- Vehicle pulls heavily to one side when braking
- Vehicle pulls heavily to one side when driving on a level road
- Loss of brake effectiveness, spongy feeling, pedal almost touches the floor

## Fuel pump shut off system

**To minimize the risk of fuel leakage when the engine stalls or when an airbag inflates upon collision, the fuel pump shut off system stops the supply of fuel to the engine.**

Follow the procedure below to restart the engine after the system is activated.

**STEP 1** Turn the engine switch to the “ACC” or “LOCK” position.

**STEP 2** Restart the engine.

 **NOTICE**

■ **Before starting the engine**

Inspect the ground under the vehicle.

If you find that fuel has leaked onto the ground, the fuel system has been damaged and is in need of repair. Do not restart the engine.

تلفن شبانه روزی: ۰۲۱-۸۸۶۲۰۸۵

FarmaSOS.com





## 5-2. Steps to take in an emergency

If a warning light turns on or a warning buzzer sounds...

**Calmly perform the following actions if any of the warning lights comes on or flashes. If a light comes on or flashes, but then goes off, this does not necessarily indicate a malfunction in the system. However, if this continues to occur, have the vehicle inspected by your Toyota dealer.**

**Stop the vehicle immediately. Continuing to drive the vehicle may be dangerous.**

The following warnings indicate a possible problem in the brake system. Immediately stop the vehicle in a safe place and contact your Toyota dealer.



Warning light	Warning light/Details
 (except Canada)	<b>Brake system warning light (warning buzzer)*</b> <ul style="list-style-type: none"><li>• Low brake fluid</li><li>• Malfunction in the brake system</li></ul> This light also comes on when the parking brake is not released. If the light turns off after the parking brake is fully released the system is operating normally.
 (Canada)	

\*: Parking brake engaged warning buzzer:

The buzzer sounds to indicate that the parking brake is still engaged (with the vehicle having reached a speed of 3 mph [5 km/h]).



### Stop the vehicle immediately.





The following warnings indicate the possibility of damage to the vehicle that may lead to an accident. Immediately stop the vehicle in a safe place and contact your Toyota dealer.

Warning light	Warning light/Details
	<b>Charging system warning light</b> Indicates a malfunction in the vehicle's charging system.
	<b>Low engine oil pressure warning light</b> Indicates that the engine oil pressure is too low.
 (Flashes or comes on)	<b>High engine coolant temperature warning light</b> Indicates that the engine is almost overheating. (→P. 334)

### Have the vehicle inspected immediately.



Failure to investigate the cause of the following warnings may lead to the system operating abnormally and possibly cause an accident. Have the vehicle inspected by your Toyota dealer immediately.



Warning light	Warning light/Details
 (except Canada)  (Canada)	<b>Malfunction indicator lamp</b> Indicates a malfunction in: <ul style="list-style-type: none"> <li>• The electronic engine control system;</li> <li>• The electronic throttle control system; or</li> <li>• The electronic automatic transmission control system.</li> </ul>
	<b>SRS warning light</b> Indicates a malfunction in: <ul style="list-style-type: none"> <li>• The SRS airbag system;</li> <li>• The front passenger occupant classification system; or</li> <li>• The seat belt pretensioner system.</li> </ul>

Warning light	Warning light/Details
 (except Canada)  (Canada)	<b>ABS warning light</b> Indicates a malfunction in: <ul style="list-style-type: none"> <li>• The ABS; or</li> <li>• The Brake assist system.</li> </ul>
	<b>Electric power steering system warning light (warning buzzer)</b> Indicates a malfunction in the EPS system.
	<b>Slip indicator light</b> Indicates a malfunction in: <ul style="list-style-type: none"> <li>• VSC system; or</li> <li>• TRAC system.</li> </ul>
 (Flashes)	<b>Cruise control indicator light (if equipped)</b> Indicates a malfunction in the cruise control system.

### Follow the correction procedures.

After taking the specified steps to correct the suspected problem, check that the warning light goes off.

Warning light	Warning light/Details	Correction procedure
	<b>Open door warning light (warning buzzer)*<sup>1</sup></b> Indicates that a door is not fully closed.	Check that all the doors are closed.
	<b>Low fuel level warning light</b> Indicates remaining fuel is approximately 1.7 gal. (6.3 L, 1.4 Imp.gal.) or less.	Refuel the vehicle.

Warning light	Warning light/Details	Correction procedure
	<p><b>Driver's and front passenger's seat belt reminder light (warning buzzer)*2</b>                      Warns the driver and front passenger to fasten their seat belts.</p>	<p>Fasten the seat belt.</p>
 (except Canada)	<p><b>Tire pressure warning light</b></p> <p>When the light comes on:                      Low tire inflation pressure such as</p> <ul style="list-style-type: none"> <li>• Natural causes (→P. 311)</li> <li>• Flat tire (→P. 315)</li> </ul> <p>When the light comes on after blinking for 1 minute:                      Malfunction in the tire pressure warning system. (→P. 312)</p>	<p>Adjust the tire inflation pressure to the specified level.</p> <p>The light will turn off after a few minutes. In case the light does not turn off even if the tire inflation pressure is adjusted, have the system checked by your Toyota dealer.</p> <p>Have the system checked by your Toyota dealer.</p>
 (if equipped)	<p><b>Low windshield washer fluid warning light</b>                      Low level of washer fluid</p>	<p>Fill the tank.</p>

Warning light	Warning light/Details	Correction procedure
<div style="border: 1px solid black; padding: 2px; display: inline-block; text-align: center;"> <b>MAINT REQD</b> </div> (except Canada)	<b>Maintenance required reminder light</b> Indicates that maintenance is required according to the driven distance on the maintenance schedule. *3	
	Illuminates for about 3 seconds and then flashes for about 15 seconds approximately 4500 miles (7200 km) after the maintenance data has been reset.	If necessary, perform maintenance.
	Comes on and remains on if the distance driven exceeds 5000 miles (8000 km) after the maintenance data has been reset. (The indicator will not work properly unless the maintenance data has been reset.)	Perform the necessary maintenance. Please reset the maintenance data after the maintenance is performed. (→P. 229)

\*1: Open door warning buzzer:

A buzzer will sound if the vehicle reaches a speed of 3 mph (5 km/h) or more with any door open.

\*2: Driver's and front passenger's seat belt buzzer:

The driver's and front passenger's seat belt buzzer sounds to alert the driver and front passenger that their seat belt is not fastened. Once the engine switch is turned to the "ON" or "START" position, the buzzer sounds for 6 seconds. The buzzer sounds once if the driver's or front passenger's seat belt is unfastened when the vehicle reaches a speed of 12 mph (20 km/h). Then, if the seat belt is still unfastened after 30 seconds elapse, the buzzer will sound intermittently for approximately 10 seconds, followed by a different tone for approximately 20 more seconds.

\*3: Refer to the separate "Scheduled Maintenance Guide" or "Owner's Manual Supplement" for the maintenance interval applicable to your vehicle.

### ■ SRS warning light

This warning light system monitors the airbag sensor assembly, front impact sensors, side impact sensors, driver's seat belt buckle switch, front passenger occupant classification system (ECU and sensors), "AIR BAG ON" indicator light, "AIR BAG OFF" indicator light, front passenger's seat belt buckle switch, seat belt pretensioner assemblies, airbags, interconnecting wiring and power sources. (→P. 80)

### ■ Front passenger detection sensor, passenger seat belt reminder and warning buzzer

- If luggage is placed on the front passenger seat, the front passenger detection sensor may cause the warning light to flash and the warning buzzer to sound even if a passenger is not sitting in the seat.
- If a cushion is placed on the seat, the sensor may not detect a passenger, and the warning light may not operate properly.

### ■ Electric power steering system warning light (warning buzzer)

When the battery charge becomes insufficient or the voltage temporarily drops, the electric power steering system warning light may come on and the warning buzzer may sound.

### ■ If the malfunction indicator lamp comes on while driving

First check the following:

- Is the fuel tank empty?  
If it is, fill the fuel tank immediately.
- Is the fuel tank cap loose?  
If it is, tighten it securely.

The malfunction indicator lamp will go off after several driving trips. If the malfunction indicator lamp does not go off even after several trips, contact your Toyota dealer as soon as possible.

### ■ When the tire pressure warning light comes on (vehicles with a tire pressure warning system)

Check the tire inflation pressure and adjust to the appropriate level. Pushing the tire pressure warning reset switch will not turn off the tire pressure warning light.

■ **The tire pressure warning light may come on due to natural causes (vehicles with a tire pressure warning system)**

The tire pressure warning light may come on due to natural causes such as natural air leaks and tire inflation pressure changes caused by temperature. In this case, adjusting the tire inflation pressure will turn off the warning light (after a few minutes).

■ **When a tire is replaced with a spare tire (vehicles with a tire pressure warning system)**

The compact spare tire is not equipped with a tire pressure warning valve and transmitter. If a tire goes flat, the tire pressure warning light will not turn off even though the flat tire has been replaced with the spare tire. Replace the spare tire with the repaired tire and adjust the tire inflation pressure. The tire pressure warning light will go off after a few minutes.

■ **If the tire pressure warning system is not functioning (vehicles with a tire pressure warning system)**

The system will be disabled in the following conditions:

(When the condition becomes normal, the system will work properly.)

- If tires not equipped with tire pressure warning valves and transmitters are used
- If the ID code on the tire pressure warning valves and transmitters are not registered in the tire pressure warning computer
- If the tire inflation pressure is 73 psi (500 kPa, 5.1 kgf/cm<sup>2</sup> or bar) or higher

The tire pressure warning system may be disabled in the following conditions:

(When the condition becomes normal, the system will work properly.)

- If electronic devices or facilities using similar radio wave frequencies are nearby
- If a radio set at a similar frequency is in use in the vehicle
- If a window tint that affects the radio wave signals is installed
- If there is a lot of snow or ice on the vehicle, particularly around the wheels or wheel housings

- If non-genuine Toyota wheels are used (Even if you use Toyota wheels, the tire pressure warning system may not work properly with some types of tires.)
- If tire chains are used

■ **If the tire pressure warning light frequently comes on after blinking for 1 minute (vehicles with a tire pressure warning system)**

If the tire pressure warning light frequently comes on after blinking for 1 minute when the engine switch is turned to the "ON" position, have it checked by your Toyota dealer.

■ **Customization that can be configured at Toyota dealer**

The vehicle speed linked seat belt reminder buzzer can be disabled. (Customizable features →P. 368) However, Toyota recommends that the seat belt reminder buzzer be operational to alert the driver and front passenger when seat belts are not fastened.

 CAUTION

■ **When the electric power steering system warning light comes on**

The steering wheel may become extremely heavy.

If the steering wheel becomes heavier than usual when operating, hold firmly and operate using more force than usual.

■ **If the tire pressure warning light comes on (vehicles with a tire pressure warning system)**

Be sure to observe the following precautions. Failure to do so could cause a loss of vehicle control and result in death or serious injury.

- Stop your vehicle in a safe place as soon as possible. Adjust the tire inflation pressure immediately.
- If the tire pressure warning light comes on even after tire inflation pressure adjustment, it is probable that you have a flat tire. Check the tires. If a tire is flat, change it with the spare tire and have the flat tire repaired by the nearest Toyota dealer.
- Avoid abrupt maneuvering and braking. If the vehicle tires deteriorate, you could lose control of the steering wheel or the brakes.



 CAUTION**■ If a blowout or sudden air leakage should occur (vehicles with a tire pressure warning system)**

The tire pressure warning system may not activate immediately.

**■ Maintenance of the tire (vehicles with a tire pressure warning system)**

Each tire, including the spare (if provided), should be checked monthly when cold and inflated to the inflation pressure recommended by the vehicle manufacturer on the vehicle placard or tire inflation pressure label (tire and load information label). (If your vehicle has tires of a different size than the size indicated on the vehicle placard or tire inflation pressure label [tire and load information label], you should determine the proper tire inflation pressure for those tires.)

As an added safety feature, your vehicle has been equipped with a tire pressure monitoring system (TPMS-tire pressure warning system) that illuminates a low tire pressure telltale (tire pressure warning light) when one or more of your tires is significantly under-inflated. Accordingly, when the low tire pressure telltale (tire pressure warning light) illuminates, you should stop and check your tires as soon as possible, and inflate them to the proper pressure. Driving on a significantly under-inflated tire causes the tire to overheat and can lead to tire failure. Under-inflation also reduces fuel efficiency and tire tread life, and may affect the vehicle's handling and stopping ability.

Please note that the TPMS (tire pressure warning system) is not a substitute for proper tire maintenance, and it is the driver's responsibility to maintain correct tire pressure, even if under-inflation has not reached the level to trigger illumination of the TPMS low tire pressure telltale (tire pressure warning light).

 CAUTION

Your vehicle has also been equipped with a TPMS (tire pressure warning system) malfunction indicator to indicate when the system is not operating properly. The TPMS (tire pressure warning system) malfunction indicator is combined with the low tire pressure telltale (tire pressure warning light). When the system detects a malfunction, the telltale will flash for approximately one minute and then remain continuously illuminated. This sequence will continue upon subsequent vehicle start-ups as long as the malfunction exists. When the malfunction indicator is illuminated, the system may not be able to detect or signal low tire pressure as intended.

TPMS (tire pressure warning system) malfunctions may occur for a variety of reasons, including the installation of replacement or alternate tires or wheels on the vehicle that prevent the TPMS (tire pressure warning system) from functioning properly. Always check the TPMS (tire pressure warning system) malfunction telltale after replacing one or more tires or wheels on your vehicle to ensure that the replacement or alternate tires and wheels allow the TPMS (tire pressure warning system) to continue to function properly.

تلفن شبانه روزی: ۰۸۵ ۸۶۲۰۸۵

 NOTICE

FarmaSOS.com

■ **Precaution when installing a different tire (vehicles with a tire pressure warning system)**

When a tire of a different specification or maker is installed, the tire pressure warning system may not operate properly.

## 5-2. Steps to take in an emergency If you have a flat tire

**Remove the flat tire and replace it with the spare tire provided.**

### ■ Before jacking up the vehicle

- Stop the vehicle on a hard, flat surface.
- Set the parking brake.
- Shift the shift lever to P (vehicles with an automatic transmission) or R (vehicles with a manual transmission).
- Stop the engine.
- Turn on the emergency flashers.

### ■ Location of the spare tire, jack and tools

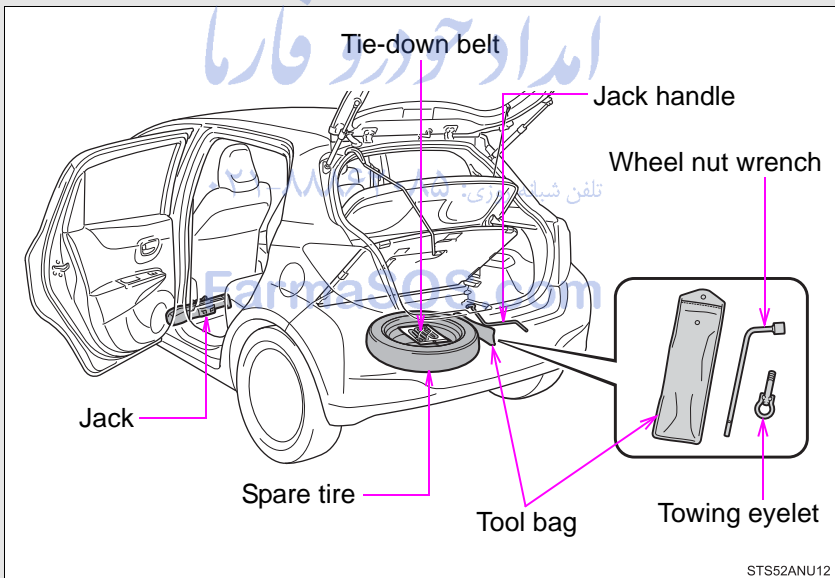

### Taking out the jack

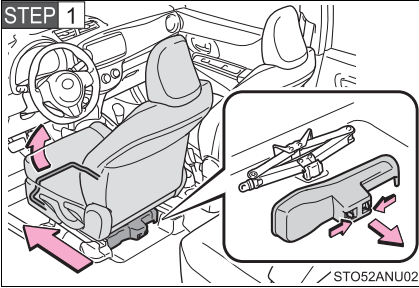

Move the driver seat to the front most position and remove the cover.

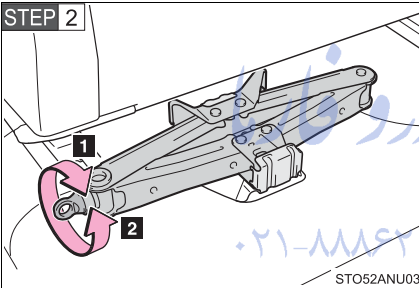

Take out the jack.

- 1 For tightening
- 2 For loosening

تلفن شبانه روزی: ۰۲۱-۸۸۶۲۰۸۵

### Taking out the spare tire

**STEP 1** Lift the deck board and attach the hook. (→P. 217)

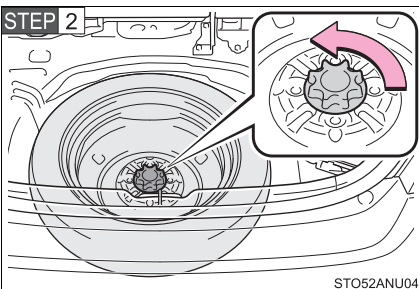

Loosen the center fastener that secures the spare tire.

**Replacing a flat tire**

**STEP 1**

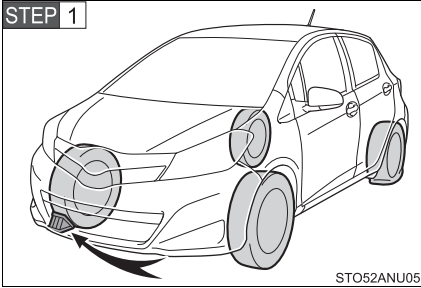

Chock the tires.

Flat tire		Wheel chock positions
Front	Left-hand side	Behind the rear right-hand side tire
	Right-hand side	Behind the rear left-hand side tire
Rear	Left-hand side	In front of the front right-hand side tire
	Right-hand side	In front of the front left-hand side tire

**STEP 2**

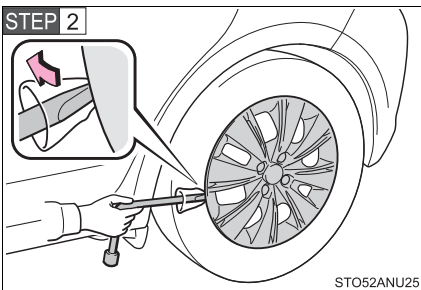

For vehicles with steel wheels, remove the wheel ornament using the wrench.

To protect the wheel ornament, place a rag between the wrench and the wheel ornament.

امداد خودرو فارما  
 ۰۲۱-۸۸۶۲۰۸۵  
 FarmaSOS.com

## 5-2. Steps to take in an emergency

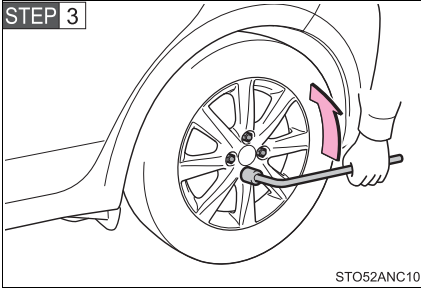

Slightly loosen the wheel nuts (one turn).

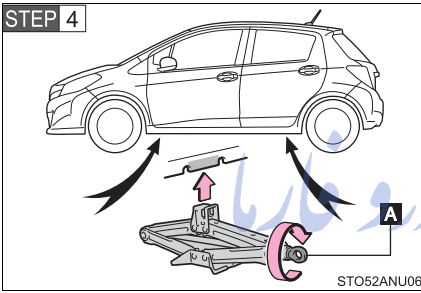

Turn the jack portion "A" by hand until the notch of the jack is in contact with the jack point.

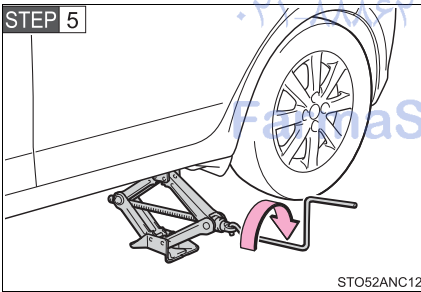

Raise the vehicle until the tire is slightly raised off the ground.

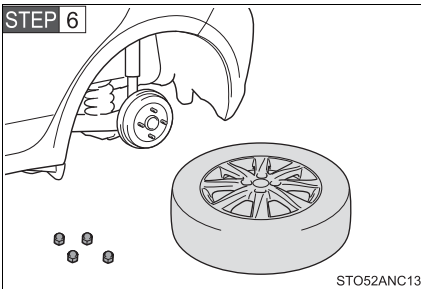

Remove all the wheel nuts and the tire.

When resting the tire on the ground, place the tire so that the wheel design faces up to avoid scratching the wheel surface.

## Installing the tire

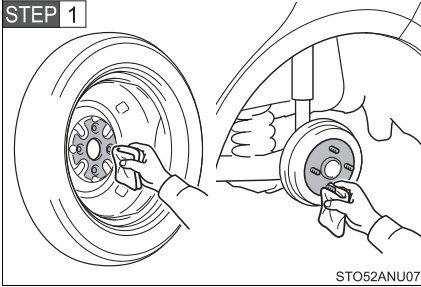

Remove any dirt or foreign matter from the wheel contact surface.

If foreign matter is on the wheel contact surface, the wheel nuts may loosen while the vehicle is in motion, causing the tire to come off.

**STEP 2** Install the spare tire and loosely tighten each wheel nut by hand by approximately the same amount.

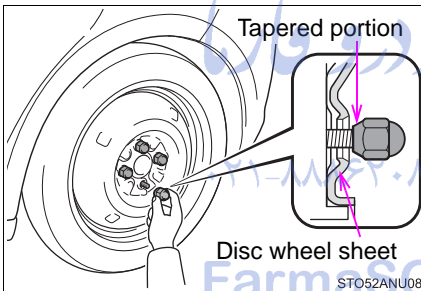

When replacing a steel wheel with a compact spare tire, tighten the wheel nuts until the tapered portion comes into loose contact with the disc wheel sheet.

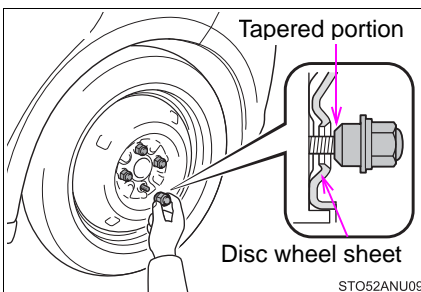

When replacing an aluminum wheel with a compact spare tire, tighten the wheel nuts until the tapered portion comes into loose contact with the disc wheel sheet.

## 5-2. Steps to take in an emergency

STEP 3

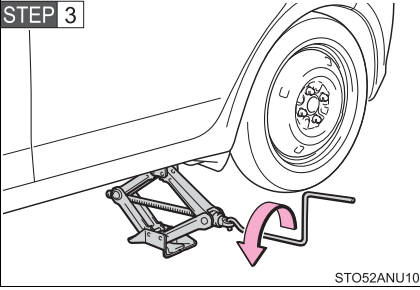

Lower the vehicle.

STEP 4

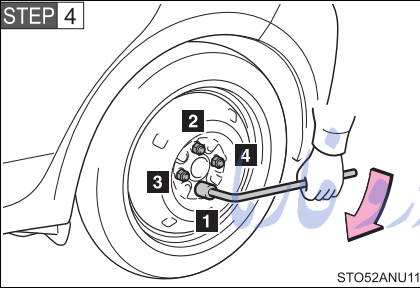

Firmly tighten each wheel nut two or three times in the order shown in the illustration.

**Tightening torque:**  
76 ft·lbf (103 N·m, 10.5 kgf·m)

**Stowing the flat tire, jack and all tools** تلفن شبانه روزی

STEP 1 Stow the jack and all tools.

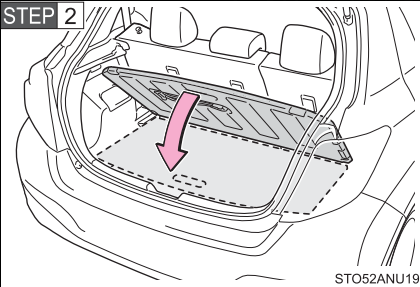

Return the deck board.



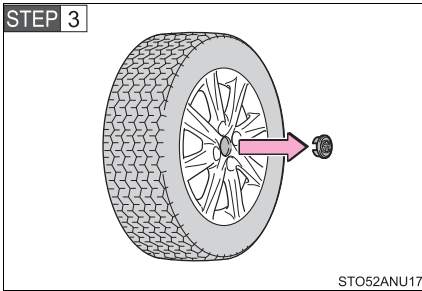

Vehicles with an aluminum wheels, remove the center wheel ornament by pushing from the reverse side.

Be careful not to lose the wheel ornament.

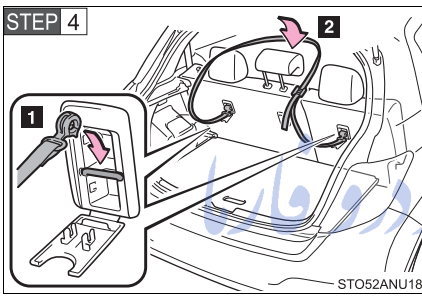

**1** Hook each belt end to the corresponding anchor brackets.

**2** Put the center portion of the belt onto the rear center head restraint.

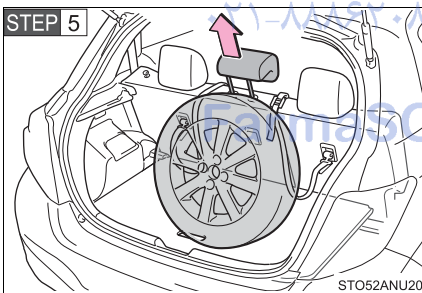

Lay the flat tire on the luggage floor so that the outer side of the tire wheel faces toward the rear of the vehicle. Detach the rear center head restraint from the seat and release the belt.

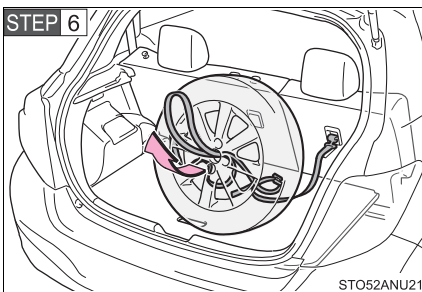

Pass the belt through the center hole of the flat tire wheel.

## 5-2. Steps to take in an emergency

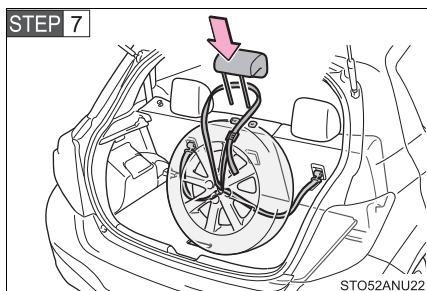

Put the center portion of the belt onto the rear center head restraint position and then return the rear center head restraint.

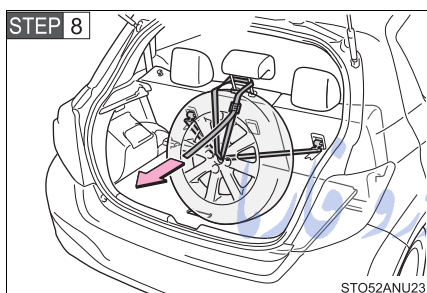

Hold the buckle and pull the belt to secure the tire.

After stowing the flat tire, check that the tire and belt are secured.

### ■ The compact spare tire

- The compact spare tire is identified by the label “TEMPORARY USE ONLY” on the tire sidewall. Use the compact spare tire temporarily, and only in an emergency.
- Make sure to check the tire inflation pressure of the compact spare tire. (→P. 351)

### ■ After completing the tire change (vehicles with a tire pressure warning system)

The tire pressure warning system must be reset. (→P. 255)

### ■ When using the compact spare tire (vehicles with a tire pressure warning system)

As the compact spare tire is not equipped with a tire pressure warning valve and transmitter, low inflation pressure of the spare tire will not be indicated by the tire pressure warning system. Also, if you replace the compact spare tire after the tire pressure warning light comes on, the light remains on.

■ **If you have a flat front tire on a road covered with snow or ice**

Install the compact spare tire on one of the rear wheels of the vehicle. Perform the following steps and fit tire chains to the front tires:

**STEP 1** Replace a rear tire with the compact spare tire.

**STEP 2** Replace the flat front tire with the tire removed from the rear of the vehicle.

**STEP 3** Fit tire chains to the front tires.

**⚠ CAUTION**

■ **When using the compact spare tire**

- Remember that the compact spare tire provided is specifically designed for use with your vehicle. Do not use your compact spare tire on another vehicle.
- Do not use more than one compact spare tire simultaneously.
- Replace the compact spare tire with a standard tire as soon as possible.
- Avoid sudden acceleration, deceleration and braking, as well as sharp cornering.

■ **When storing the compact spare tire**

Be careful not to catch fingers or other body parts between the compact spare tire and the body of the vehicle.

■ **When the compact spare tire is attached**

The vehicle speed may not be correctly detected, and the following systems may not operate correctly:

- ABS
- Brake assist
- VSC
- TRAC
- Cruise control (if equipped)

 CAUTION

■ **Speed limit when using the compact spare tire**

Do not drive at speeds in excess of 50 mph (80 km/h) when a compact spare tire is installed on the vehicle.

The compact spare tire is not designed for driving at high speeds. Failure to observe this precaution may lead to an accident causing death or serious injury.

■ **Using the tire jack**

Improper use of the tire jack may cause the vehicle to suddenly fall off the jack, leading to death or serious injury.

- Do not use the tire jack for any purpose other than replacing tires or installing and removing tire chains.
- Only use the tire jack that comes with this vehicle for replacing a flat tire.  
Do not use it on other vehicles, and do not use other jacks for replacing tires on this vehicle.
- Always check that the tire jack is securely set to the jack point.
- Do not put any part of your body under the vehicle while it is supported by the jack.
- Do not start or run the engine while your vehicle is supported by the jack.
- Do not raise the vehicle while someone is inside.
- When raising the vehicle, do not put an object on or under the jack.
- Do not raise the vehicle to a height greater than that required to replace the tire.
- Use a jack stand if it is necessary to get under the vehicle.

Take particular care when lowering the vehicle to ensure that no one working on or near the vehicle may be injured.

 CAUTION

**■ Replacing a flat tire**

- Do not touch the disc wheels or the area around the brakes immediately after the vehicle has been driven.  
After the vehicle has been driven the disc wheels and the area around the brakes will be extremely hot. Touching these areas with hands, feet or other body parts while changing a tire, etc. may result in burns.
- Failure to follow these precautions could cause the wheel nuts to loosen and the tire to fall off, resulting in death or serious injury.
  - Have the wheel nuts tightened with a torque wrench to 76 ft·lbf (103 N·m, 10.5 kgf·m) as soon as possible after changing wheels.
  - When installing a tire, only use wheel nuts that have been specifically designed for that wheel.
  - If there are any cracks or deformations in the bolt screws, nut threads or bolt holes of the wheel, have the vehicle inspected by your Toyota dealer.
  - When installing the wheel nuts, be sure to install them with the tapered ends facing inward. (→P. 267) تلفن شبانه روزی: ۰۲۰-۸۸۸۸۸۸۸۸

**■ When stowing the flat tire**

- Make sure the rear seats are in their original position.
- Secure it using a tire tie-down belt. Otherwise, the flat tire may fly out in case of the sudden braking or an accident, resulting in death or serious injury.

 NOTICE

■ **Do not drive the vehicle with a flat tire**

Do not continue driving with a flat tire.

Driving even a short distance with a flat tire can damage the tire and the wheel beyond repair.

■ **Be careful when driving over bumps with the compact spare tire installed on the vehicle**

The vehicle becomes lower when driving with the compact spare tire compared to when driving with standard tires. Be careful when driving over uneven road surfaces.

■ **Driving with tire chains and the compact spare tire**

Do not fit tire chains to the compact spare tire.

Tire chains may damage the vehicle body and adversely affect driving performance.

■ **When replacing the tires (vehicles with a tire pressure warning system)**

When removing or fitting the wheels, tires or the tire pressure warning valve and transmitter, contact your Toyota dealer as the tire pressure warning valve and transmitter may be damaged if not handled correctly.

■ **To avoid damage to the tire pressure warning valves and transmitters (vehicles with a tire pressure warning system)**

When a tire is repaired with liquid sealants, the tire pressure warning valve and transmitter may not operate properly. If a liquid sealant is used, contact your Toyota dealer or other qualified service shop as soon as possible. Make sure to replace the tire pressure warning valve and transmitter when replacing the tire. (→P. 255)

## 5-2. Steps to take in an emergency If the engine will not start

**If the engine will not start even though correct starting procedures are being followed (→P. 124), consider each of the following points:**

■ **The engine will not start even though the starter motor operates normally.**

One of the following may be the cause of the problem:

- There may not be sufficient fuel in the vehicle's tank.  
Refuel the vehicle.
- The engine may be flooded.  
Try to restart the engine again following correct starting procedures. (→P. 124)
- Vehicles with engine immobilizer system: There may be a malfunction in the engine immobilizer system. (→P. 72)

■ **The starter motor turns over slowly, the interior lights and headlights are dim, or the horn does not sound or sounds at a low volume.**

One of the following may be the cause of the problem:

- The battery may be discharged. (→P. 330)
- The battery terminal connections may be loose or corroded.

■ **The starter motor does not turn over, the interior lights and headlights do not turn on, or the horn does not sound.**

One of the following may be the cause of the problem:

- One or both of the battery terminals may be disconnected.
- The battery may be discharged. (→P. 330)

Contact your Toyota dealer if the problem cannot be repaired, or if repair procedures are unknown.

## 5-2. Steps to take in an emergency

If the shift lever cannot be shifted from P (vehicles with an automatic transmission)

If the shift lever cannot be shifted with your foot on the brake pedal, there may be a problem with the shift lock system (a system to prevent accidental operation of the shift lever). Have the vehicle inspected by your Toyota dealer immediately.

The following steps may be used as an emergency measure to ensure that the shift lever can be shifted:

**STEP 1** Set the parking brake.

**STEP 2** Turn the engine switch to the "ACC" position.

**STEP 3** Depress the brake pedal.

**STEP 4**

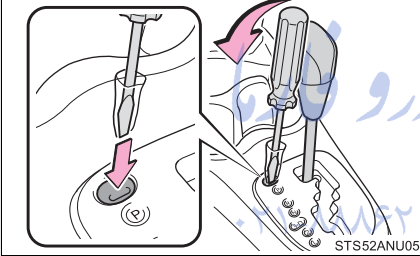

Pry the cover up with a flat-head screwdriver or equivalent tool.

To prevent damage to the cover, cover the tip of the screwdriver with a rag.

**STEP 5**

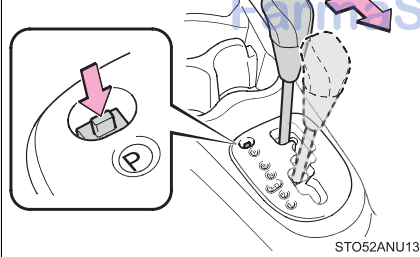

Press the shift lock override button.

The shift lever can be shifted while the button is pressed.



## If you lose your keys

**New genuine Toyota keys can be made by your Toyota dealer using the other key and the key number stamped on your key number plate.**

امداد خودرو فارما

تلفن شبانه روزی: ۰۲۱-۸۸۸۶۲۰۸۵

[FarmaSOS.com](http://FarmaSOS.com)

## 5-2. Steps to take in an emergency

### If the vehicle battery is discharged

The following procedures may be used to start the engine if the vehicle's battery is discharged.

You can also call your Toyota dealer or qualified repair shop.

If you have a set of jumper (or booster) cables and a second vehicle with a 12-volt battery, you can jump start your vehicle by following the steps below.

**STEP 1** Open the hood (→P. 238)

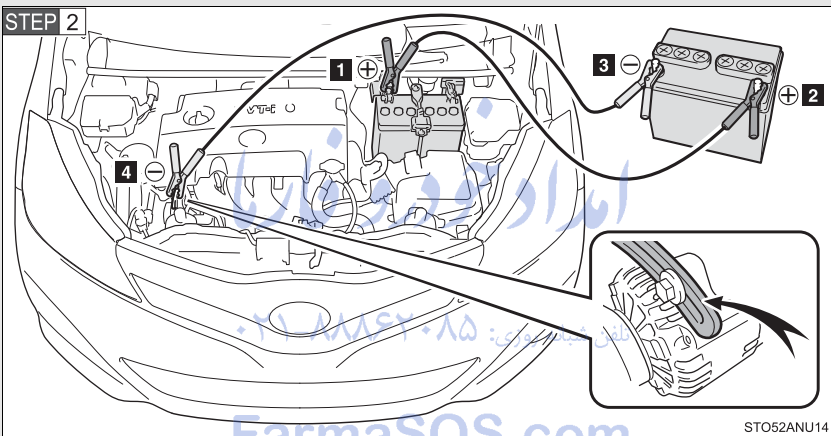

Connect the jumper cables according to the following procedure:

- 1** Connect a positive jumper cable clamp to the positive (+) battery terminal on your vehicle.
- 2** Connect the clamp on the other end of the positive cable to the positive (+) battery terminal on the second vehicle.
- 3** Connect a negative cable clamp to the negative (-) battery terminal on the second vehicle.
- 4** Connect the clamp at the other end of the negative cable to a solid, stationary, unpainted metallic point away from the battery and any moving parts, as shown in the illustration.

**STEP 3** Start the engine of the second vehicle. Increase the engine speed slightly and maintain at that level for approximately 5 minutes to recharge the battery of your vehicle.

**STEP 4** Maintain the engine speed of the second vehicle and start the engine of your vehicle by turning the engine switch to the “ON” position.

**STEP 5** Once the vehicle's engine has started, remove the jumper cables in the exact reverse order from which they were connected.

Once the engine starts, have the vehicle inspected at your Toyota dealer as soon as possible.

#### ■ Starting the engine when the battery is discharged (vehicles with an automatic transmission)

The engine cannot be started by push-starting.

#### ■ To prevent battery discharge

- Turn off the headlights and the air conditioning system while the engine is off.
- Turn off any unnecessary electrical components when the vehicle is running at a low speed for an extended period, such as in heavy traffic.

#### ■ When the battery is removed or discharged (vehicles with an alarm system)

Make sure that the key is not inside the vehicle when recharging or replacing the battery. The key may be locked in the vehicle if the alarm is activated. (→P. 75)

#### ■ Charging the battery

The electricity stored in the battery will discharge gradually even when the vehicle is not in use, due to natural discharge and the draining effects of certain electrical appliances. If the vehicle is left for a long time, the battery may discharge, and the engine may be unable to start. (The battery recharges automatically during driving.)

 CAUTION

■ **Avoiding battery fires or explosions**

Observe the following precautions to prevent accidentally igniting the flammable gas that may be emitted from the battery:

- Make sure each jumper cable is connected to the correct terminal and that it is not unintentionally in contact with any other than the intended terminal.
- Do not allow the + and - clamps of the jumper cables to come into contact with each other.
- Do not smoke, use matches, cigarette lighters or allow open flame near the battery.

■ **Battery precautions**

The battery contains poisonous and corrosive acidic electrolyte, while related parts contain lead and lead compounds. Observe the following precautions when handling the battery:

- When working with the battery, always wear safety glasses and take care not to allow any battery fluids (acid) to come into contact with skin, clothing or the vehicle body. *تلفن شبانه روزی: ۰۸۵-۸۸۶۲۰۲۱*
- Do not lean over the battery.
- In the event that battery fluid comes into contact with the skin or eyes, immediately wash the affected area with water and seek medical attention. Place a wet sponge or cloth over the affected area until medical attention can be received.
- Always wash your hands after handling the battery support, terminals, and other battery-related parts.
- Do not allow children near the battery.

■ **To prevent damaging to the vehicle**

Do not pull- or push-start the vehicle as the three-way catalytic converter may overheat and become a fire hazard.



## NOTICE

### ■ When handling jumper cables

When connecting the jumper cables, ensure that they do not become entangled in the cooling fans or belt.

امداد خودرو فارما

تلفن شبانه روزی: ۰۲۱-۸۸۶۲۰۸۵

FarmaSOS.com

## 5-2. Steps to take in an emergency If your vehicle overheats

The following may indicate that your vehicle is overheating.

- The high engine coolant temperature warning light (→P. 306) comes on or flashes, or a loss of engine power is experienced. (For example, the vehicle speed does not increase.)
- Steam comes out from under the hood.

Follow the correction procedure as described below.

**STEP 1** Stop the vehicle in a safe place and turn off the air conditioning system, and then stop the engine.

**STEP 2** If you see steam:

Carefully lift the hood after the steam subsides.

If you do not see steam:

Carefully lift the hood.

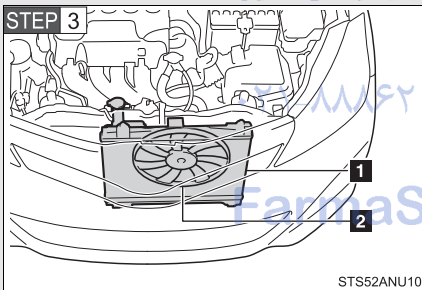

After the engine has cooled down sufficiently, inspect the hoses and radiator core (radiator) for any leaks.

- 1 Radiator
- 2 Cooling fan

If a large amount of coolant leaks, immediately contact your Toyota dealer.

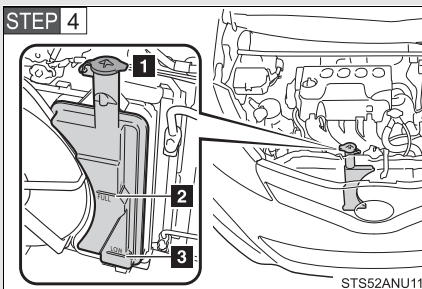

The coolant level is satisfactory if it is between the “FULL” and “LOW” lines on the reservoir.

- 1 Reservoir
- 2 “FULL” line
- 3 “LOW” line

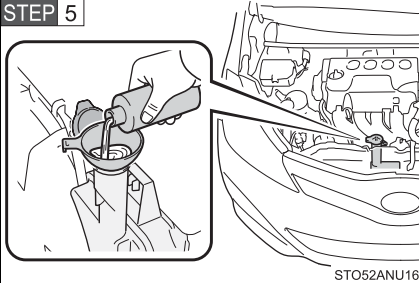
**STEP 5**

Add coolant if necessary.

Water can be used in an emergency if coolant is unavailable.

**STEP 6** Start the engine and turn the air conditioning system on to check that the radiator cooling fan operates and to check for coolant leaks from the radiator or hoses.

The fan operates when the air conditioning system is turned on immediately after a cold start. Confirm that the fan is operating by checking the fan sound and air flow. If it is difficult to check these, turn the air conditioning system on and off repeatedly. (The fan may not operate in freezing temperatures.)

**STEP 7** If the fan is not operating: تلفن شبانه روزی: ۸۵

Stop the engine immediately and contact your Toyota dealer.

If the fan is operating: [FarmSOS.com](http://FarmSOS.com)

Have the vehicle inspected at the nearest Toyota dealer.

 CAUTION

■ **To prevent an accident or injury when inspecting under the hood of your vehicle**

- If steam is seen coming from under the hood, do not open the hood until the steam has subsided. The engine compartment may be very hot, causing serious injuries such as burns.
- Keep hands and clothing (especially a tie, a scarf or a muffler) away from the fans and belts. Failure to do so may cause the hands or clothing to be caught, resulting in serious injury.
- Do not loosen the radiator cap and the coolant reservoir cap while the engine and radiator are hot.  
Serious injury, such as burns, may result from hot coolant and steam released under pressure.

 NOTICE

■ **When adding engine coolant**

Wait until the engine has cooled down before adding engine coolant. When adding coolant, do so slowly. Adding cool coolant to a hot engine too quickly can cause damage to the engine.

■ **To prevent damage to the cooling system**

Observe the following precautions:

- Avoid contaminating the coolant with foreign matter (such as sand or dust etc.).
- Do not use commercially available coolant additives.



## 5-2. Steps to take in an emergency If the vehicle becomes stuck

**Carry out the following procedures if the tires spin or the vehicle becomes stuck in mud, dirt, or snow:**

**STEP 1** Stop the engine. Set the parking brake and shift the shift lever to P (vehicles with an automatic transmission) or N (vehicles with a manual transmission).

**STEP 2** Remove the mud, snow or sand from around the stuck tire.

**STEP 3** Place wood, stones or some other material under the tires to help provide traction.

**STEP 4** Restart the engine.

**STEP 5** Shift the shift lever to the D or R position (vehicles with an automatic transmission) or 1 or R position (vehicles with a manual transmission) and carefully apply the accelerator to free the vehicle.

Turn off TRAC and VSC if these functions are hampering your attempts to free the vehicle. (→P. 163)

تلفن شبانه روزی: ۰۲۱-۸۸۶۲۰۸۵

### ■ Emergency hook

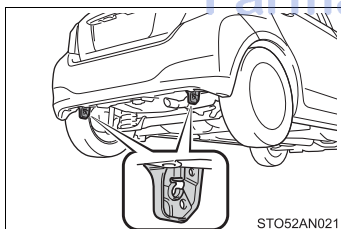

When your vehicle becomes stuck and cannot move, the emergency hook is used for another vehicle to pull your vehicle out in an emergency.

Your vehicle is not designed to tow another vehicle.

 CAUTION

■ **When attempting to free a stuck vehicle**

If you choose to push the vehicle back and forth to free it, make sure the surrounding area is clear to avoid striking other vehicles, objects or people. The vehicle may also lunge forward or lunge back suddenly as it becomes free. Use extreme caution.

■ **When shifting the shift lever (vehicles with an automatic transmission)**

Be careful not to shift the shift lever with the accelerator pedal depressed. This may lead to unexpected rapid acceleration of the vehicle that may cause an accident resulting in death or serious injury.

 NOTICE

■ **To avoid damaging to the transmission and other components**

- Avoid spinning the wheels and depressing the accelerator pedal more than necessary.
- If the vehicle remains stuck even after these procedures are performed, the vehicle may require towing to be freed.

FarmaSOS.com

## 5-2. Steps to take in an emergency

### If your vehicle has to be stopped in an emergency

**Only in an emergency, such as if it becomes impossible to stop the vehicle in the normal way, stop the vehicle using the following procedure:**

**STEP 1** Steadily step on the brake pedal with both feet and firmly depress it.

Do not pump the brake pedal repeatedly as this will increase the effort required to slow the vehicle.

**STEP 2** Shift the shift lever to N.

**If the shift lever is shifted to N**

**STEP 3** After slowing down, stop the vehicle in a safe place by the road.

**STEP 4** Stop the engine.

**If the shift lever cannot be shifted to N**

**STEP 3** Keep depressing the brake pedal with both feet to reduce vehicle speed as much as possible.

**STEP 4**

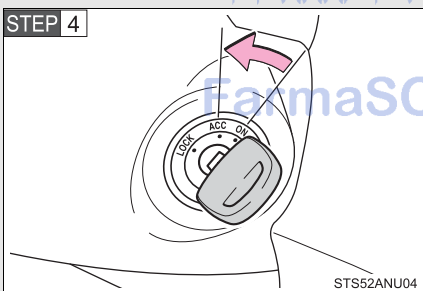

Stop the engine by turning the engine switch to the "ACC" position.

**STEP 5** Stop the vehicle in a safe place by the road.

 CAUTION

■ **If the engine has to be turned off while driving**

- Power assist for the brakes and steering wheel will be lost, making the brake pedal harder to depress and the steering wheel heavier to turn. Decelerate as much as possible before turning off the engine.
- Never attempt to remove the key, as doing so will lock the steering wheel.

امداد خودرو فارما

تلفن شبانه روزی: ۰۲۱-۸۸۶۲۰۸۵

FarmaSOS.com

## Vehicle specifications

# 6

### 6-1. Specifications

Maintenance data (fuel, oil level, etc.) .....	342
Fuel information .....	353
Tire information .....	356

### 6-2. Customization

Customizable features .....	368
Items to initialize .....	370

FarmaSOS.com

## 6-1. Specifications

### Maintenance data (fuel, oil level, etc.)

#### Dimensions and weights

Overall length	153.5 in. (3900 mm) <sup>*2</sup> 154.7 in. (3930 mm) <sup>*3</sup>
Overall width	66.7 in. (1695 mm)
Overall height <sup>*1</sup>	59.4 in. (1510 mm)
Wheelbase	98.8 in. (2510 mm)
Tread	Front 58.5 in. (1485 mm) <sup>*2</sup> 57.5 in. (1460 mm) <sup>*3</sup>
	Rear 57.9 in. (1470 mm) <sup>*2</sup> 56.9 in. (1445 mm) <sup>*3</sup>
Vehicle capacity weight (Occupants + luggage)	845 lb. (380 kg)
Towing capacity <sup>*4</sup> (Trailer weight + cargo)	700 lb. (315 kg)

\*1: Unladen vehicles

\*2: P175/65R15 tires

\*3: P195/50R16 tires

\*4: Canada only

تلفن شبانه روزی: ۰۲۱-۸۸۶۲۰۸۵

FarmaSOS.com

## Vehicle identification

### ■ Vehicle identification number

The vehicle identification number (VIN) is the legal identifier for your vehicle. This is the primary identification number for your Toyota. It is used in registering the ownership of your vehicle.

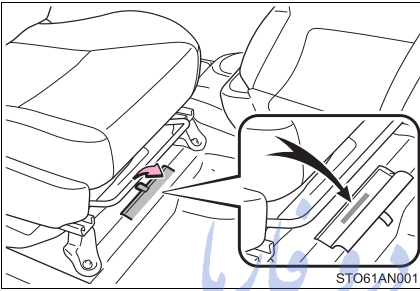

This number is stamped under the front passenger's seat.

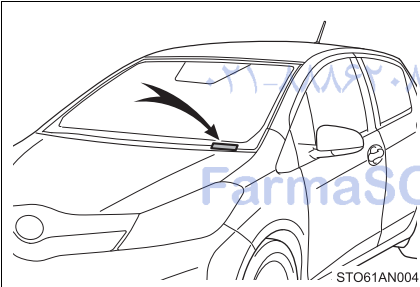

This number is stamped on the top left of the instrument panel.

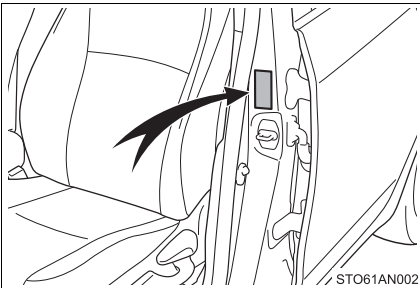

This number is also on the Certification Label on the driver's side center pillar.

■ **Engine number**

The engine number is stamped on the engine block as shown.

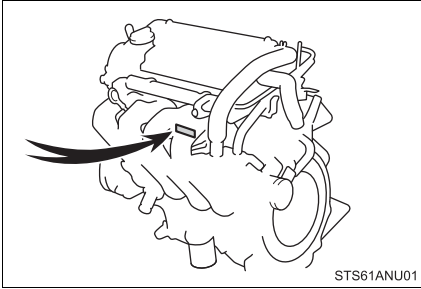

امداد خودرو فارما

تلفن شبانه روزی: ۰۲۱-۸۸۸۶۲۰۸۵

FarmaSOS.com

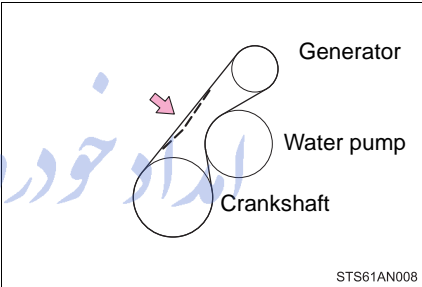
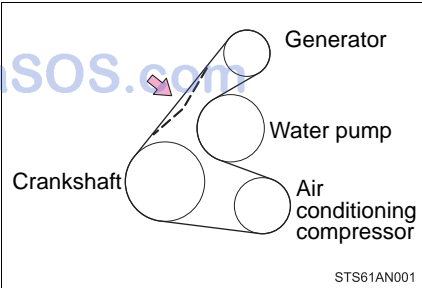

## Engine

Model	1NZ-FE
Type	4-cylinder in line, 4-cycle, gasoline
Bore and stroke	2.95 × 3.33 in. (75.0 × 84.7 mm)
Displacement	91.3 cu.in. (1497 cm <sup>3</sup> )
Drive belt tension	<p>68 — 90 lbf (300 — 400 N, 31 — 41kgf)*            Vehicles without an air conditioning system:</p>  <p style="text-align: right;">STS61AN008</p> <p>Vehicles with an air conditioning system:</p>  <p style="text-align: right;">STS61AN001</p> <p>*: Drive belt tension measured with Borouhgs drive belt tension gauge No. BT-33-73F when the engine is cold (used belt)</p>

**Fuel**

Fuel type	Unleaded gasoline only
Octane rating	87 (Research Octane Number 91) or higher
Fuel tank capacity (Reference)	11.1 gal. (42 L, 9.2 Imp.gal.)

**Lubrication system**

Oil capacity (Drain and refill -reference)	
With filter	3.9 qt. (3.7 L, 3.3 Imp.qt.)
Without filter	3.6 qt. (3.4 L, 3.0 Imp.qt.)

**■ Engine oil selection**

“Toyota Genuine Motor Oil” is used in your Toyota vehicle. Use Toyota approved “Toyota Genuine Motor Oil” or equivalent to satisfy the following grade and viscosity.

Oil grade: ILSAC multigrade engine oil

Recommended viscosity: SAE 5W-30

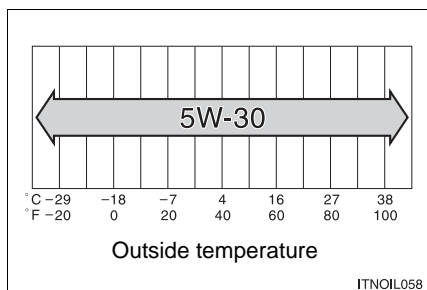

SAE 5W-30 is the best choice for good fuel economy and good starting in cold weather.

If SAE 5W-30 is not available, SAE 10W-30 oil may be used. However, it should be replaced with SAE 5W-30 at the next oil change.

Oil viscosity (5W-30 is explained here as an example):

- The 5W in 5W-30 indicates the characteristic of the oil which allows cold startability. Oils with a lower value before the W allow for easier starting of the engine in cold weather.
- The 30 in 5W-30 indicates the viscosity characteristic of the oil when the oil is at high temperature. An oil with a higher viscosity (one with a higher value) may be better suited if the vehicle is operated at high speeds, or under extreme load conditions.

How to read oil container label:

The ILSAC (International Lubricant Standardization and Approval Committee) Certification Mark is added to some oil containers to help you select the oil you should use.



### Cooling system

Capacity (Reference)	Vehicles with an automatic transmission: 4.9 qt. (4.6 L, 4.0 Imp.qt.) Vehicles with a manual transmission: 5.0 qt. (4.7 L, 4.1 Imp.qt.)
Coolant type	Use either of the following: <ul style="list-style-type: none"> <li>• “Toyota Super Long Life Coolant”</li> <li>• A similar high-quality ethylene glycol-based non-silicate, non-amine, non-nitrite, and non-borate coolant with long-life hybrid organic acid technology</li> </ul> Do not use plain water alone.

## Ignition system

Spark plug	
Make	DENSO SK16R11 NGK IFR5A11
Gap	0.043 in. (1.1 mm)

### NOTICE

#### ■ Iridium-tipped spark plugs

Use only iridium-tipped spark plugs. Do not adjust the spark plug gap.

## Electrical system

Battery	
Specific gravity reading at 68°F (20°C):	1.250 — 1.290 Fully charged 1.160 — 1.200 Half charged 1.060 — 1.100 Discharged
Charging rates	
Quick charge	15 A max.
Slow charge	5 A max.

### Automatic transmission

Fluid capacity*	6.8 qt. (6.4 L, 5.6 Imp.qt.)
Fluid type	Toyota Genuine ATF WS

\*: The fluid capacity is a reference quantity. If replacement is necessary, contact your Toyota dealer.

### NOTICE

#### ■ Transmission fluid type

Using transmission fluid other than “Toyota Genuine ATF WS” may cause deterioration in shift quality, locking up of the transmission accompanied by vibration and, ultimately, damage to the vehicle’s transmission.

### Manual transmission

Gear oil capacity (Reference)	2.0 qt. (1.9 L, 1.7 Imp.qt.)
Gear oil type	Gear oil API GL-4 or GL-5
Recommended gear oil viscosity	SAE 75W-90

### Clutch

Clutch pedal free play	0.2 — 0.6 in. (5 — 15 mm)
Fluid type	SAE J1703 or FMVSS No.116 DOT 3

**Brakes**

Pedal clearance *1	Vehicles with rear drum brakes 3.5 in. (90 mm) Min. Vehicles with rear disc brakes 3.7 in. (93 mm) Min.
Pedal free play	0.04 — 0.24 in. (1 — 6 mm)
Brake pad wear limit	0.04 in. (1.0 mm)
Brake lining wear limit	0.04 in. (1.0 mm)
Parking brake lever travel*2	Vehicles with rear drum brakes 8 — 11 clicks Vehicles with rear disc brakes 6 — 9 clicks
Fluid type	SAE J1703 or FMVSS No.116 DOT 3

\*1: Minimum pedal clearance when depressed with a force of 67 lbf (300 N, 31 kgf) while the engine is running.

\*2: Parking brake lever travel when pulled up with a force of 45 lbf (200 N, 20 kgf).

**Steering**

Free play	Less than 1.2 in. (30 mm)
-----------	---------------------------

<b>Tires and wheels</b>
-------------------------

**15-inch tires**

Tire size	P175/65R15 84H, T125/70D16 96M (spare)
Tire inflation pressure (recommended cold tire inflation pressure)	Driving under normal conditions Front: 33 psi (230 kPa, 2.3 kgf/cm <sup>2</sup> or bar) Rear: 33 psi (230 kPa, 2.3 kgf/cm <sup>2</sup> or bar) Spare: 60 psi (420 kPa, 4.2 kgf/cm <sup>2</sup> or bar) Never exceed the maximum cold tire inflation pressure indicated on the tire side-wall.
Wheel size	15 × 5J, 16 × 4T (spare)
Wheel nut torque	76 ft-lbf (103 N·m, 10.5 kgf·m)

**16-inch tires**

Tire size	P195/50R16 83V, T125/70D16 96M (spare)
Front and rear tire inflation pressure (recommended cold tire inflation pressure)	Driving under normal conditions Front: 32 psi (220 kPa, 2.2 kgf/cm <sup>2</sup> or bar) Rear: 29 psi (200 kPa, 2.0 kgf/cm <sup>2</sup> or bar) Spare: 60 psi (420 kPa, 4.2 kgf/cm <sup>2</sup> or bar) Never exceed the maximum cold tire inflation pressure indicated on the tire side-wall.
Wheel size	16 × 6J, 16 × 4T (spare)
Wheel nut torque	76 ft-lbf (103 N·m, 10.5 kgf·m)

<b>Light bulbs</b>
--------------------

	Light Bulbs	Bulb No	W	Type
Exterior	Headlights and daytime running lights (if equipped)	9003	60/55	A
	Front fog lights (if equipped)	—	55	B
	Front side marker lights	—	5	C
	Front turn signal lights/ parking lights	7444NA	28/8	D
	Rear turn signal lights	—	21	D
	Stop/tail and rear side marker lights	7443	21/5	C
	Back-up lights	921	16	C
	License plate light	—	5	C
Interior	Personal lights/Interior light	—	5	C
	Luggage compartment light	—	5	E

A: HB2 halogen bulbs

B: H11 halogen bulbs

C: Wedge base bulbs (clear)

D: Wedge base bulbs (amber)

E: Double end bulbs



**You must only use unleaded gasoline in your vehicle.**

**Select octane rating 87 (Research Octane Number 91) or higher. Use of unleaded gasoline with an octane rating lower than 87 may result in engine knocking. Persistent knocking can lead to engine damage.**

At minimum, the gasoline you use should meet the specifications of ASTM D4814 in the U.S.A. and CGSB3.5-M93 in Canada.

---

■ **Fuel tank opening for unleaded gasoline**

To help prevent incorrect fueling, your vehicle has a fuel tank opening that only accommodates the special nozzle on unleaded fuel pumps.

■ **Gasoline quality**

In very few cases, driveability problems may be caused by the brand of gasoline you are using. If driveability problems persist, try changing the brand of gasoline. If this does not correct the problem, consult your Toyota dealer.

■ **Gasoline quality standards**

- Automotive manufacturers in the U.S.A., Europe and Japan have developed a specification for fuel quality called World-Wide Fuel Charter (WWFC), which is expected to be applied worldwide.
- The WWFC consists of four categories that are based on required emission levels. In the U.S., category 4 has been adopted.
- The WWFC improves air quality by lowering emissions in vehicle fleets, and improves customer satisfaction through better performance.

■ **Recommendation of the use of gasoline containing detergent additives**

- Toyota recommends the use of gasoline that contains detergent additives to avoid the build-up of engine deposits.
- All gasoline sold in the U.S.A. contains minimum detergent additives to clean and/or keep clean intake systems, per EPA's lowest additives concentration program.
- Toyota strongly recommends the use of Top Tier Detergent Gasoline. For more information on Top Tier Detergent Gasoline and a list of marketers, please go to the official website [www.toptiergas.com](http://www.toptiergas.com).

### ■ Recommendation of the use of cleaner burning gasoline

Cleaner burning gasoline, including reformulated gasoline that contains oxygenates such as ethanol or MTBE (Methyl Tertiary Butyl Ether) is available in many areas.

Toyota recommends the use of cleaner burning gasoline and appropriately blended reformulated gasoline. These types of gasoline provide excellent vehicle performance, reduce vehicle emissions and improve air quality.

### ■ Non-recommendation of the use of blended gasoline

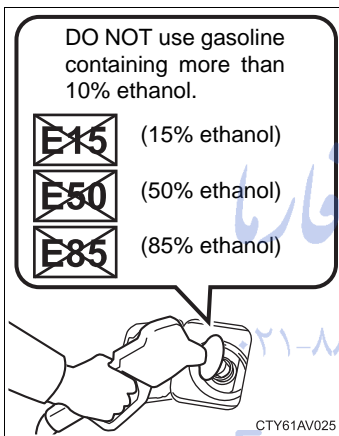

- Use only gasoline containing a maximum of 10% ethanol.

DO NOT use any flex-fuel or gasoline that could contain more than 10% ethanol, including from any pump labeled E15, E30, E50, E85 (which are only some examples of fuel containing more than 10% ethanol).

- If you use gasohol in your vehicle, be sure that it has an octane rating no lower than 87.
- Toyota does not recommend the use of gasoline containing methanol.

### ■ Non-recommendation of the use of gasoline containing MMT

Some gasoline contains an octane enhancing additive called MMT (Methylcyclopentadienyl Manganese Tricarbonyl).

Toyota does not recommend the use of gasoline that contains MMT. If fuel containing MMT is used, your emission control system may be adversely affected.

The malfunction indicator lamp on the instrument cluster may come on. If this happens, contact your Toyota dealer for service.

### ■ If your engine knocks

- Consult your Toyota dealer.
- You may occasionally notice light knocking for a short time while accelerating or driving uphill. This is normal and there is no need for concern.

### NOTICE

#### ■ Notice on fuel quality

- Do not use improper fuels. If improper fuels are used, the engine will be damaged.
- Do not use leaded gasoline.  
Leaded gasoline can cause damage to your vehicle's three-way catalytic converters causing the emission control system to malfunction.
- Do not use gasohol other than the type previously stated.  
Other gasohol may cause fuel system damage or vehicle performance problems.
- Using unleaded gasoline with an octane number or rating lower than the level previously stated will cause persistent heavy knocking.  
At worst, this will lead to engine damage.

#### ■ Fuel-related poor driveability

If poor driveability is encountered after using a different type of fuel (poor hot starting, vaporization, engine knocking, etc.), discontinue the use of that type of fuel.

#### ■ When refueling with gasohol

Take care not to spill gasohol. It can damage your vehicle's paint.

# 6-1. Specifications

## Tire information

### Typical tire symbols

#### Full-size tire

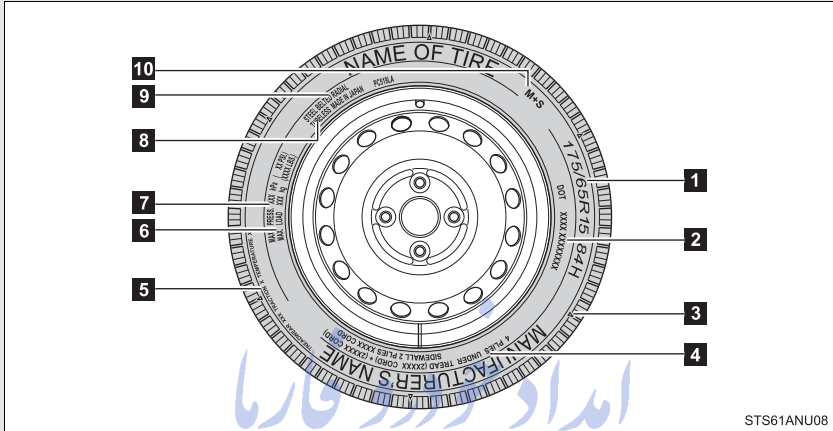

#### Compact spare tire

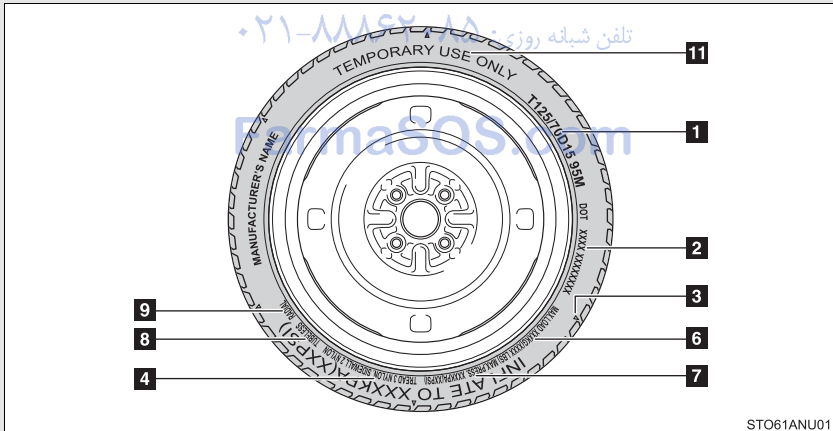

- 1 Tire size (→P. 359)
- 2 DOT and Tire Identification Number (TIN) (→P. 358)
- 3 Location of treadwear indicators (→P. 254)
- 4 Tire ply composition and materials

Ply is a layer of rubber-coated parallel cords. Cords are the strands which form the plies in a tire.

**5** Uniform tire quality grading

For details, see “Uniform Tire Quality Grading” that follows.

**6** Load limit at maximum cold tire inflation pressure (→P. 362)**7** Maximum cold tire inflation pressure (→P. 351)

This means the pressure to which a tire may be inflated.

**8** TUBELESS or TUBE TYPE

A tubeless tire does not have a tube and air is directly put into the tire. A tube type tire has a tube inside the tire and the tube maintains the air pressure.

**9** Radial tires or bias-ply tires

A radial tire has “RADIAL” on the sidewall. A tire not marked “RADIAL” is a bias-ply tire.

**10** Summer tires or all season tires (→P. 258)

An all season tire has “M+S” on the sidewall. A tire not marked “M+S” is a summer tire.

**11** “TEMPORARY USE ONLY” (→P. 322)

A compact spare tire is identified by the phrase “TEMPORARY USE ONLY” molded on its sidewall. This tire is designed for temporary emergency use only.

## Typical DOT and Tire Identification Number (TIN)

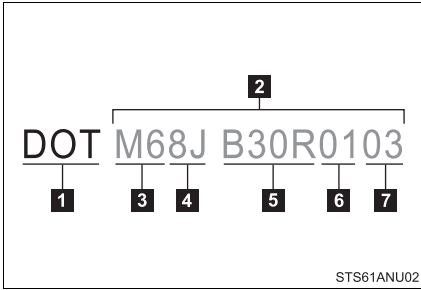

- 1 DOT symbol\*
- 2 Tire Identification Number (TIN)
- 3 Tire manufacturer's identification mark
- 4 Tire size code
- 5 Manufacturer's optional tire type code (3 or 4 letters)
- 6 Manufacturing week
- 7 Manufacturing year

\*:The DOT symbol certifies that the tire conforms to applicable Federal Motor Vehicle Safety Standards.

تلفن شبانه روزی: ۰۲۱-۸۸۶۲۰۸۵

FarmaSOS.com

## Tire size

### ■ Typical tire size information

The illustration indicates typical tire size.

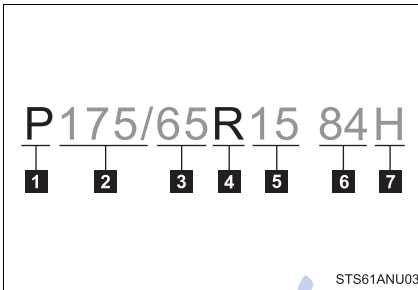

#### 1 Tire use

(P = Passenger car,  
T = Temporary use)

#### 2 Section width (millimeters)

#### 3 Aspect ratio

(tire height to section width)

#### 4 Tire construction code

(R = Radial, D = Diagonal)

#### 5 Wheel diameter (inches)

#### 6 Load index (2 digits or 3 digits)

#### 7 Speed symbol

(alphabet with one letter)

### ■ Tire dimensions

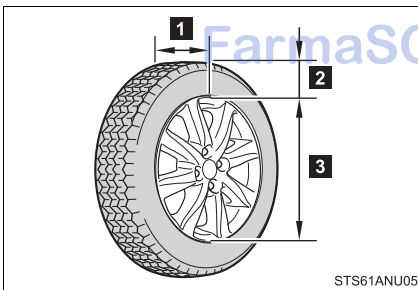

#### 1 Section width

#### 2 Tire height

#### 3 Wheel diameter

## Tire section names

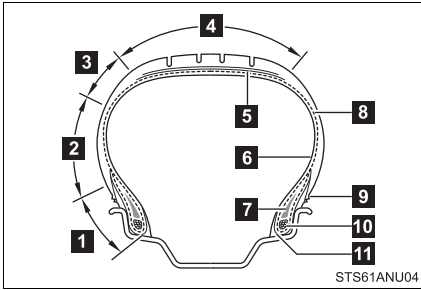

- 1 Bead
- 2 Sidewall
- 3 Shoulder
- 4 Tread
- 5 Belt
- 6 Inner liner
- 7 Reinforcing rubber
- 8 Carcass
- 9 Rim lines
- 10 Bead wires
- 11 Chafer

## Uniform Tire Quality Grading

This information has been prepared in accordance with regulations issued by the National Highway Traffic Safety Administration of the U.S. Department of Transportation.

It provides the purchasers and/or prospective purchasers of Toyota vehicles with information on uniform tire quality grading.

Your Toyota dealer will help answer any questions you may have as you read this information.

### ■ DOT quality grades

All passenger vehicle tires must conform to Federal Safety Requirements in addition to these grades. Quality grades can be found where applicable on the tire sidewall between tread shoulder and maximum section width.

For example: Treadwear 200 Traction AA Temperature A



### ■ Treadwear

The treadwear grade is a comparative rating based on the wear rate of the tire when tested under controlled conditions on a specified government test course.

For example, a tire graded 150 would wear one and a half (1 - 1/2) times as well on the government course as a tire graded 100.

The relative performance of tires depends upon the actual conditions of their use. Performance may differ significantly from the norm due to variations in driving habits, service practices and differences in road characteristics and climate.

### ■ Traction AA, A, B, C

The traction grades, from highest to lowest, are AA, A, B and C, and they represent the tire's ability to stop on wet pavement as measured under controlled conditions on specified government test surfaces of asphalt and concrete.

A tire marked C may have poor traction performance.

Warning: The traction grade assigned to this tire is based on braking (straight ahead) traction tests and does not include cornering (turning) traction.

### ■ Temperature A, B, C

The temperature grades are A (the highest), B, and C, representing the tire's resistance to the generation of heat and its ability to dissipate heat when tested under controlled conditions on a specified indoor laboratory test wheel.

Sustained high temperature can cause the material of the tire to degenerate and reduce tire life, and excessive temperature can lead to sudden tire failure.

Grade C corresponds to a level of performance which all passenger car tires must meet under the Federal Motor Vehicle Safety Standard No. 109.

Grades B and A represent higher levels of performance on the laboratory test wheel than the minimum required by law.

Warning: The temperature grades of a tire assume that it is properly inflated and not overloaded.

Excessive speed, underinflation, or excessive loading, either separately or in combination, can cause heat buildup and possible tire failure.

### Glossary of tire terminology

Tire related term	Meaning
Cold tire inflation pressure	Tire pressure when the vehicle has been parked for three hours or more, or has not been driven more than 1 mile or 1.5 km under that condition
Maximum inflation pressure	The maximum cold inflated pressure to which a tire may be inflated, shown on the sidewall of the tire
Recommended inflation pressure	Cold tire inflation pressure recommended by a manufacturer
Accessory weight	The combined weight (in excess of those standard items which may be replaced) of automatic transmission, power steering, power brakes, power windows, power seats, radio and heater, to the extent that these items are available as factory-installed equipment (whether installed or not)
Curb weight	The weight of a motor vehicle with standard equipment, including the maximum capacity of fuel, oil and coolant, and if so equipped, air conditioning and additional weight optional engine
Maximum loaded vehicle weight	The sum of: (a) Curb weight (b) Accessory weight (c) Vehicle capacity weight (d) Production options weight

Tire related term	Meaning
Normal occupant weight	150 lb. (68 kg) times the number of occupants specified in the second column of Table 1* that follows
Occupant distribution	Distribution of occupants in a vehicle as specified in the third column of Table 1* below
Production options weight	The combined weight of installed regular production options weighing over 5 lb. (2.3 kg) in excess of the standard items which they replace, not previously considered in curb weight or accessory weight, including heavy duty brakes, ride levelers, roof rack, heavy duty battery, and special trim
Rim	A metal support for a tire or a tire and tube assembly upon which the tire beads are seated
Rim diameter (Wheel diameter)	Nominal diameter of the bead seat
Rim size designation	Rim diameter and width
Rim type designation	The industry manufacturer's designation for a rim by style or code
Rim width	Nominal distance between rim flanges
Vehicle capacity weight (Total load capacity)	The rated cargo and luggage load plus 150 lb. (68 kg) times the vehicle's designated seating capacity
Vehicle maximum load on the tire	The load on an individual tire that is determined by distributing to each axle its share of the maximum loaded vehicle weight, and dividing by two
Vehicle normal load on the tire	The load on an individual tire that is determined by distributing to each axle its share of curb weight, accessory weight, and normal occupant weight (distributed in accordance with Table 1* below), and dividing by two

Tire related term	Meaning
Weather side	The surface area of the rim not covered by the inflated tire
Bead	The part of the tire that is made of steel wires, wrapped or reinforced by ply cords and that is shaped to fit the rim
Bead separation	A breakdown of the bond between components in the bead
Bias ply tire	A pneumatic tire in which the ply cords that extend to the beads are laid at alternate angles substantially less than 90 degrees to the centerline of the tread
Carcass	The tire structure, except tread and sidewall rubber which, when inflated, bears the load
Chunking	The breaking away of pieces of the tread or sidewall
Cord	The strands forming the plies in the tire
Cord separation	The parting of cords from adjacent rubber compounds
Cracking	Any parting within the tread, sidewall, or innerliner of the tire extending to cord material
CT	A pneumatic tire with an inverted flange tire and rim system in which the rim is designed with rim flanges pointed radially inward and the tire is designed to fit on the underside of the rim in a manner that encloses the rim flanges inside the air cavity of the tire
Extra load tire	A tire designed to operate at higher loads and at higher inflation pressures than the corresponding standard tire
Groove	The space between two adjacent tread ribs
Innerliner	The layer(s) forming the inside surface of a tubeless tire that contains the inflating medium within the tire

Tire related term	Meaning
Innerliner separation	The parting of the innerliner from cord material in the carcass
Intended outboard sidewall	(a)The sidewall that contains a whitewall, bears white lettering, or bears manufacturer, brand, and/or model name molding that is higher or deeper than the same molding on the other sidewall of the tire, or (b)The outward facing sidewall of an asymmetrical tire that has a particular side that must always face outward when mounted on a vehicle
Light truck (LT) tire	A tire designated by its manufacturer as primarily intended for use on lightweight trucks or multipurpose passenger vehicles
Load rating	The maximum load that a tire is rated to carry for a given inflation pressure
Maximum load rating	The load rating for a tire at the maximum permissible inflation pressure for that tire
Maximum permissible inflation pressure	The maximum cold inflation pressure to which a tire may be inflated
Measuring rim	The rim on which a tire is fitted for physical dimension requirements
Open splice	Any parting at any junction of tread, sidewall, or innerliner that extends to cord material
Outer diameter	The overall diameter of an inflated new tire
Overall width	The linear distance between the exteriors of the sidewalls of an inflated tire, including elevations due to labeling, decorations, or protective bands or ribs
Passenger car tire	A tire intended for use on passenger cars, multipurpose passenger vehicles, and trucks, that have a gross vehicle weight rating (GVWR) of 10,000 lb. or less

Tire related term	Meaning
Ply	A layer of rubber-coated parallel cords
Ply separation	A parting of rubber compound between adjacent plies
Pneumatic tire	A mechanical device made of rubber, chemicals, fabric and steel or other materials, that, when mounted on an automotive wheel, provides the traction and contains the gas or fluid that sustains the load
Radial ply tire	A pneumatic tire in which the ply cords that extend to the beads are laid at substantially 90 degrees to the centerline of the tread
Reinforced tire	A tire designed to operate at higher loads and at higher inflation pressures than the corresponding standard tire
Section width	The linear distance between the exteriors of the sidewalls of an inflated tire, excluding elevations due to labeling, decoration, or protective bands
Sidewall	That portion of a tire between the tread and bead
Sidewall separation	The parting of the rubber compound from the cord material in the sidewall
Snow tire	A tire that attains a traction index equal to or greater than 110, compared to the ASTM E-1136 Standard Reference Test Tire, when using the snow traction test as described in ASTM F-1805-00, Standard Test Method for Single Wheel Driving Traction in a Straight Line on Snow-and Ice-Covered Surfaces, and which is marked with an Alpine Symbol (  ) on at least one sidewall
Test rim	The rim on which a tire is fitted for testing, and may be any rim listed as appropriate for use with that tire

Tire related term	Meaning
Tread	That portion of a tire that comes into contact with the road
Tread rib	A tread section running circumferentially around a tire
Tread separation	Pulling away of the tread from the tire carcass
Treadwear indicators (TWI)	The projections within the principal grooves designed to give a visual indication of the degrees of wear of the tread
Wheel-holding fixture	The fixture used to hold the wheel and tire assembly securely during testing

\*:Table 1 — Occupant loading and distribution for vehicle normal load for various designated seating capacities

Designated seating capacity, Number of occupants	Vehicle normal load, Number of occupants	Occupant distribution in a normally loaded vehicle
2 through 4	2	2 in front
5 through 10	3	2 in front, 1 in second seat
11 through 15	5	2 in front, 1 in second seat, 1 in third seat, 1 in fourth seat
16 through 20	7	2 in front, 2 in second seat, 2 in third seat, 1 in fourth seat

## Customizable features

**Your vehicle includes a variety of electronic features that can be personalized to suit your preferences. Programming these preferences requires specialized equipment and may be performed by your Toyota dealer.**

Some function settings are changed simultaneously with other functions being customized. Contact your Toyota dealer for further details.

Item	Function	Default setting	Customized setting
Wireless remote control (→P. 31)	Wireless remote control	On	Off
	Unlocking operation	The driver's door unlocked in one step, all the doors unlocked in two steps	All the doors unlocked in one step
	Time elapsed before automatic door lock function is activated if a door is not opened after being unlocked	60 seconds	30 seconds
			120 seconds
	Operation signal (Emergency flashers)	On	Off
Panic function	On	Off	
Door lock (→P. 34)	Unlocking using a key	The driver's door unlocked in one step, all the doors unlocked in two steps	All the doors unlocked in one step



Item	Function	Default setting	Customized setting
Illumination (→P. 202) (vehicles with alarm system or daytime run- ning light system)	Time elapsed before lights turn off	15 seconds	7.5 seconds 30 seconds
	Operation after the engine switch is turned to the "LOCK" position	On	Off
	Operation when the doors are unlocked	On	Off
Seat belt reminder buzzer (→P. 307)	Vehicle speed linked seat belt reminder buzzer	On	Off

امداد خودرو فارما

تلفن شبانه روزی: ۰۲۱-۸۸۶۲۰۸۵

FarmaSOS.com

## 6-2. Customization Items to initialize

**The following items must be initialized for normal system operation after such cases as the battery being reconnected, or maintenance being performed on the vehicle:**

Item	When to initialize	Reference
Maintenance data (except Canada)	After the maintenance is performed	P. 229
Tire pressure warning system (if equipped)	When rotating the tires on vehicles with differing front and rear tire inflation pressures	P. 255

امداد خودرو فارما

تلفن شبانه روزی: ۰۲۱-۸۸۶۲۰۸۵

FarmaSOS.com

For owners

7

Reporting safety defects for U.S. owners .....	372
Seat belt instructions for Canadian owners (in French) .....	373
SRS airbag instructions for Canadian owners (in French) .....	375

تلفن شبانه روزی: ۰۲۱-۸۸۸۶۲۰۸۵

[FarmaSOS.com](http://FarmaSOS.com)

## Reporting safety defects for U.S. owners

If you believe that your vehicle has a defect which could cause a crash or could cause injury or death, you should immediately inform the National Highway Traffic Safety Administration (NHTSA) in addition to notifying Toyota Motor Sales, U.S.A., Inc. (Toll-free: 1-800-331-4331).

If NHTSA receives similar complaints, it may open an investigation, and if it finds that a safety defect exists in a group of vehicles, it may order a recall and remedy campaign. However, NHTSA cannot become involved in individual problems between you, your dealer, or Toyota Motor Sales, U.S.A., Inc.

To contact NHTSA, you may call the Vehicle Safety Hotline toll-free at 1-888-327-4236 (TTY: 1-800-424-9153); go to <http://www.safercar.gov>; or write to: Administrator, NHTSA, 1200 New Jersey Ave, S.E., Washington, DC 20590. You can also obtain other information about motor vehicle safety from <http://www.safercar.gov>.

تلفن شبانه روزی: ۰۲۱-۸۸۶۲۰۸۵

FarmaSOS.com

## Seat belt instructions for Canadian owners (in French)

The following is a French explanation of seat belt instructions extracted from the seat belt section in this manual.

See the seat belt section for more detailed seat belt instructions in English.

### Utilisation correcte des ceintures de sécurité

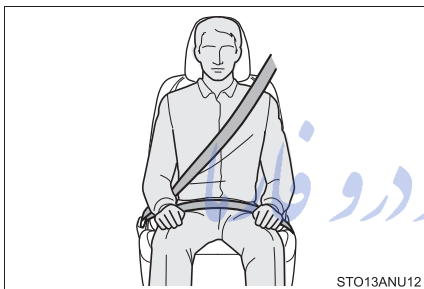

- Déroulez la sangle diagonale de telle sorte qu'elle passe bien sur l'épaule, sans pour autant être en contact avec le cou ou glisser de l'épaule.
- Placez la sangle abdominale le plus bas possible sur les hanches.
- Réglez la position du dossier de siège. Asseyez-vous le dos le plus droit possible et caliez-vous bien dans le siège.
- Ne pas vriller la ceinture de sécurité.

تلفن شبانه روزی: ۰۲۱-۸۸۶۲۰۸۵

FarmaSOS.com

**⚠ ATTENTION**

■ **Lorsque vous utilisez la ceinture de sécurité du siège central arrière**

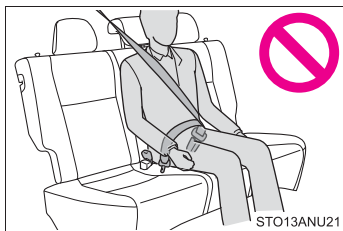

Ne pas utiliser la ceinture de sécurité du siège central arrière avec une de ses deux boucles déverrouillée.

Si une seule des boucles est verrouillée, tout freinage brusque ou collision peut entraîner des blessures graves, voire mortelles.

**Entretien et soin**

■ **Ceintures de sécurité**

Nettoyez avec un chiffon ou une éponge humectée d'eau savonneuse tiède. Par ailleurs, vérifiez régulièrement que les ceintures ne sont pas effilochées, entaillées, ou ne paraissent pas exagérément usées.

**⚠ ATTENTION**

■ **État et usure des ceintures de sécurité**

Inspectez les ceintures de sécurité périodiquement. Vérifiez qu'elles ne sont pas entaillées, effilochées, et que leurs ancrages ne sont pas desserrés. Ne pas utiliser une ceinture de sécurité défectueuse avant qu'elle ne soit remplacée. Des ceintures de sécurité défectueuses n'apportent aucune garantie de protection de l'occupant contre des blessures graves, voire mortelles.

The following is a French explanation of SRS airbag instructions extracted from the SRS airbag section in this manual.

See the SRS airbag section for more detailed SRS airbag instructions in English.

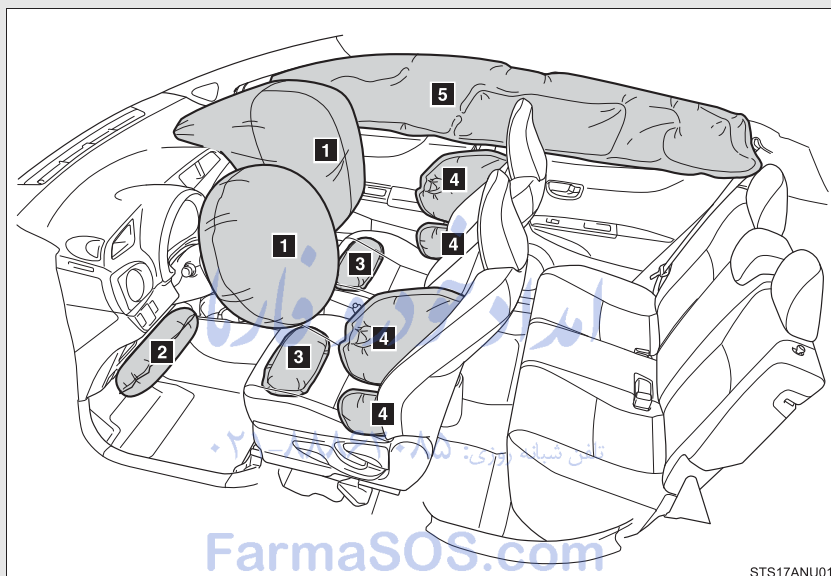

## Sacs de sécurité gonflables SRS frontaux

- 1** Sacs de sécurité gonflables SRS conducteur/passager avant  
Participent à la protection de la tête et du thorax du conducteur et du passager avant contre les chocs avec les éléments de l'habitacle.
- 2** Sac de sécurité gonflable SRS de genoux conducteur  
Contribue à accroître la protection du conducteur.
- 3** Sacs de sécurité gonflables SRS d'assise de siège  
Peuvent contribuer à retenir le conducteur et le passager avant.

## Sacs de sécurité gonflables SRS latéraux et rideaux

### 4 Sacs de sécurité gonflables SRS latéraux

Participent à la protection du haut du corps des occupants des sièges avant.

### 5 Sacs de sécurité gonflables SRS rideaux

Participent principalement à la protection de la tête des occupants assis aux places latérales.

## Composition du système de sacs de sécurité gonflables SRS

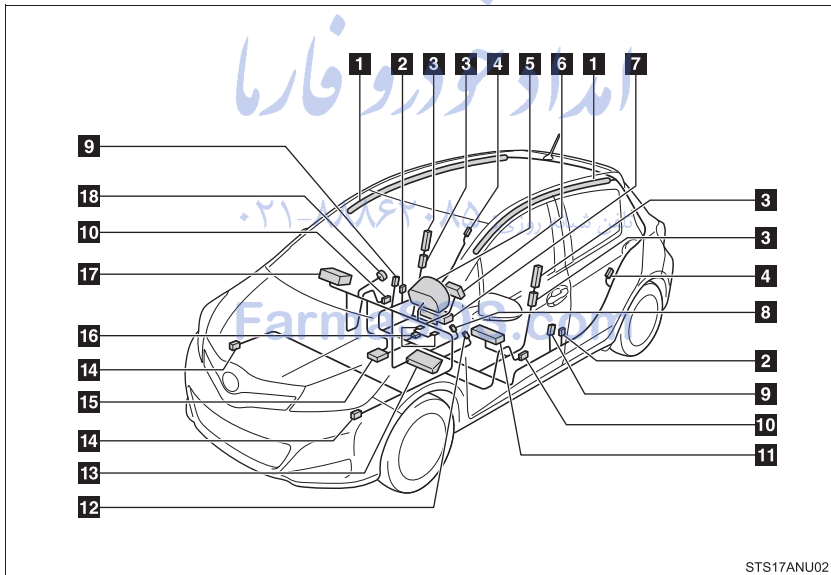



- 1** Sacs de sécurité gonflables rideau
- 2** Capteurs d'impact latéral (avant)
- 3** Sacs de sécurité gonflables latéraux
- 4** Capteurs d'impact latéral (arrière)
- 5** Témoin d'alerte SRS
- 6** Sac de sécurité gonflable conducteur
- 7** Sac de sécurité gonflable coussin de siège du passager
- 8** Contacteur de boucle de ceinture de sécurité du passager avant
- 9** Prétensionneurs de ceintures de sécurité
- 10** Capteurs d'impact latéral (porte avant)
- 11** Sac de sécurité gonflable coussin de siège du conducteur
- 12** Contacteur de boucle de ceinture de sécurité du conducteur
- 13** Sac de sécurité gonflable genoux conducteur
- 14** Capteurs d'impact avant
- 15** Boîtier électronique de sacs de sécurité gonflables
- 16** Système de classification d'occupant du siège passager avant (ECU et capteurs)
- 17** Sac de sécurité gonflable passager avant
- 18** Témoins indicateurs "AIR BAG ON" et "AIR BAG OFF"

Votre véhicule est équipé de SACS DE SÉCURITÉ GONFLABLES ÉVOLUÉS, dont la conception est basée sur les normes de sécurité des véhicules automobiles américains (FMVSS208). L'ensemble de capteurs des sacs de sécurité gonflables (ECU) contrôle le déploiement des sacs de sécurité gonflables en fonction des informations obtenues des capteurs, etc. figurant sur le schéma de composition du système ci-dessus. Ces informations comprennent des informations sur la gravité de la collision et les occupants. Le déploiement rapide des sacs de sécurité gonflables est obtenu au moyen d'une réaction chimique dans les dispositifs pyrotechniques, qui produit un gaz inoffensif permettant d'amortir le mouvement des occupants.

امداد خودرو فارما

تلفن شبانه روزی: ۰۲۱-۸۸۶۲۰۸۵

FarmaSOS.com

 ATTENTION

■ **Précautions avec les sacs de sécurité gonflables SRS**

Respectez les précautions suivantes concernant les sacs de sécurité gonflables SRS.

À défaut, des blessures graves, voire mortelles, pourraient s'ensuivre.

- Le conducteur et tous les passagers à bord du véhicule doivent porter leur ceinture de sécurité correctement.

Les sacs de sécurité gonflables SRS sont des dispositifs de protection complémentaires aux ceintures de sécurité.

- Le sac de sécurité gonflable SRS conducteur se déploie avec une violence considérable, qui peut être très dangereuse voire mortelle si le conducteur se trouve très près du sac de sécurité gonflable. Conseils de la National Highway Traffic Safety Administration (NHTSA):

Étant donné que la zone dangereuse pour le sac de sécurité gonflable du conducteur est constituée par les premiers 2 à 3 in. de gonflage (50 à 75 mm), il suffit de vous placer à 10 in. (250 mm) de votre sac de sécurité gonflable conducteur. Cette distance est à mesurer entre le moyeu du volant de direction et le sternum. Si vous êtes assis à moins de 10 in. (250 mm), vous pouvez changer votre position de conduite de plusieurs façons:

- Reculez votre siège le plus possible, tout en continuant à pouvoir atteindre confortablement les pédales.
- Inclinez légèrement le dossier du siège. Bien que les conceptions des véhicules varient, beaucoup de conducteurs peuvent obtenir la distance de 10 in. (250 mm), avec le siège du conducteur complètement avancé, en inclinant simplement un peu le dossier du siège. Si vous avez des difficultés à voir la route après avoir incliné votre siège, utilisez un coussin ferme et antidérapant pour vous rehausser ou, si votre véhicule est équipé du réglage en hauteur du siège, remontez-le.
- Si votre volant de direction est réglable, inclinez-le vers le bas. Cela a pour effet d'orienter le sac de sécurité gonflable en direction de votre poitrine plutôt que de votre tête et de votre cou.

Le siège doit être réglé selon les recommandations de la NHTSA ci-dessus, tout en conservant le contrôle des pédales et du volant, et la vue des commandes au tableau de bord.

**! ATTENTION**

**■ Précautions avec les sacs de sécurité gonflables SRS**



● Si vous attachez une rallonge de ceinture de sécurité aux boucles des ceintures de sièges avant, mais pas au pêne de la ceinture de sécurité proprement dite, les sacs de sécurité gonflables SRS frontaux déterminent que le conducteur et le passager avant portent leur ceinture de sécurité, alors même qu'elle n'est pas attachée. Dans ce cas, les sacs de sécurité gonflables SRS frontaux risquent de ne pas se déployer correctement en cas de collision, causant des blessures graves, voire mortelles. Veillez à porter la ceinture de sécurité avec la rallonge de ceinture de sécurité.

- Le sac de sécurité gonflable SRS passager avant se déploie également avec une violence considérable, qui peut être très dangereuse voire mortelle si le passager avant se trouve très près du sac de sécurité gonflable. Éloignez le siège passager avant au maximum du sac de sécurité gonflable, et réglez le dossier de siège de sorte à être assis bien droit dans le siège.
- Les nourrissons et les enfants qui ne sont pas correctement assis et/ou protégés peuvent être grièvement blessés ou tués par le déploiement d'un sac de sécurité gonflable. Installez dans un siège de sécurité enfant les enfants trop jeunes pour pouvoir utiliser la ceinture de sécurité. Toyota recommande vivement que tous les nourrissons et enfants soient installés dans les sièges arrière du véhicule et convenablement attachés. Les sièges arrière sont plus sûrs pour les nourrissons et les enfants que le siège passager avant.

**⚠ ATTENTION**

**■ Précautions avec les sacs de sécurité gonflables SRS**

● Ne jamais installer un siège de sécurité enfant type dos à la route sur le siège passager avant, même si le témoin indicateur "AIR BAG OFF" est allumé. En cas d'accident, la force engendrée par le gonflage rapide du sac de sécurité gonflable du passager avant peut causer des blessures graves voire mortelles à l'enfant si le siège de sécurité enfant de type dos à la route est installé sur le siège passager avant.

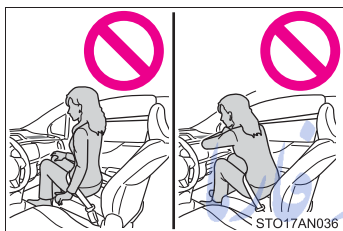

● Ne pas s'asseoir sur le bord du siège et ne pas s'appuyer contre la planche de bord.

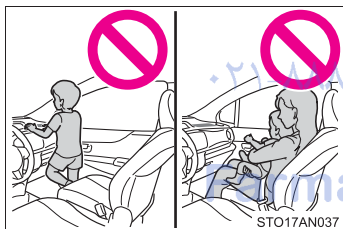

● Ne pas laisser un enfant rester debout devant le sac de sécurité gonflable SRS passager avant ou bien s'asseoir sur les genoux du passager avant.

● Ne pas laisser les occupants des sièges avant voyager avec un objet sur les genoux.



● Ne pas s'appuyer contre la porte, contre le rail latéral de toit ou contre les montants avant, latéraux et arrière.

**⚠ ATTENTION**

**■ Précautions avec les sacs de sécurité gonflables SRS**



- Interdire à quiconque de s'agenouiller sur le siège passager en appui contre la porte ou de sortir la tête ou les mains à l'extérieur du véhicule.

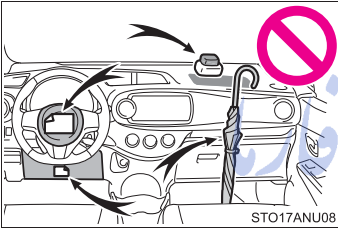

- Ne fixez ni ne posez aucun objet sur la planche de bord, la garniture centrale du volant de direction et la partie inférieure du tableau de bord.

Au déploiement des sacs de sécurité gonflables SRS conducteur, passager avant et de genoux conducteur, tout objet risque de se transformer en projectile.

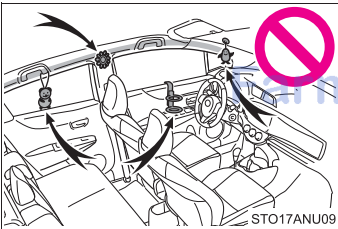

- Ne fixez aucun objet sur les portières, le pare-brise, les vitres latérales, les montants avant et arrière, le rail latéral de toit et la poignée de maintien.

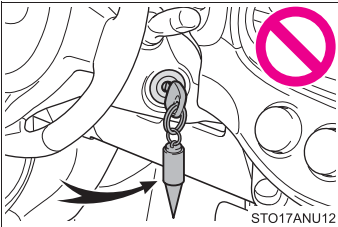

- Ne pas attacher à la clé des objets lourds, pointus ou très durs, comme d'autres clés par exemple. Ces objets risquent d'entraver le déploiement du sac de sécurité gonflable SRS de genoux conducteur ou d'être projetés vers le siège conducteur par la force de déploiement, constituant ainsi un danger potentiel.

## ATTENTION

### ■ Précautions avec les sacs de sécurité gonflables SRS

- Ne suspendez aux crochets à vêtements aucun cintre nu ni aucun objet dur. En cas de déploiement des sacs de sécurité gonflables SRS rideau, tous ces objets pourraient se transformer en projectiles et causer des blessures graves, voire mortelles.
- Si une housse en vinyle recouvre la partie où le sac de sécurité gonflable SRS de genoux conducteur se déploie, veillez à l'enlever.
- N'utilisez aucun accessoire de siège venant recouvrir les zones de déploiement des sacs de sécurité gonflables SRS latéraux et des sacs de sécurité gonflables SRS d'assise de siège, car il risquerait d'en gêner le déploiement. De tels accessoires peuvent empêcher les sacs de sécurité gonflables latéraux et les sacs coussins de siège de fonctionner correctement, neutraliser le système ou provoquer le déploiement accidentel des sacs de sécurité latéraux et des sacs coussins de siège, provoquant ainsi des blessures graves, voire mortelles.
- Évitez de faire subir des chocs ou des pressions excessives aux parties renfermant les composants des sacs de sécurité gonflables SRS. En effet, cela pourrait entraîner un mauvais fonctionnement des sacs de sécurité gonflables SRS.
- Ne touchez aucun composant du système immédiatement après le déclenchement (déploiement) des sacs de sécurité gonflables SRS, car ils sont alors encore très chauds.
- Si vous avez des difficultés à respirer après le déploiement des sacs de sécurité gonflables SRS, ouvrez une porte ou une vitre pour faire entrer de l'air frais, ou bien descendez du véhicule si cela ne présente pas de danger. Nettoyez tout résidu dès que possible afin d'éviter d'éventuelles irritations de la peau.
- Si les endroits où sont stockés les sacs de sécurité gonflables SRS, comme la garniture centrale du volant et les garnitures des montants avant et arrière sont endommagés ou fissurés, faites les remplacer par votre concessionnaire Toyota.

## ATTENTION

### ■ Précautions avec les sacs de sécurité gonflables SRS

- Ne placez aucun objet, comme un coussin, sur le siège du passager avant. Cela risque de disperser le poids du passager, ce qui empêche le capteur de détecter correctement son poids. En conséquence, les sacs de sécurité gonflables SRS frontaux du passager avant peuvent ne pas se déployer en cas de collision.

### ■ Modification et élimination en fin de vie des éléments du système de sacs de sécurité gonflables SRS

Ne pas éliminer votre véhicule ou effectuer les modifications suivantes sans consulter votre concessionnaire Toyota. Les sacs de sécurité gonflables SRS peuvent ne pas fonctionner correctement ou de déployer (gonfler) accidentellement, provoquant ainsi des blessures graves, voire mortelles.

- Installation, dépose, démontage et réparations des sacs de sécurité gonflables SRS.
- Réparations, modifications, démontage ou remplacement du volant, du tableau de bord, de la planche de bord, des sièges ou de leur garnissage, des montants avant, latéraux et arrière ou des rails latéraux de toit.
- Réparations ou modifications de l'aile avant, du bouclier avant, ou du côté de l'habitacle.
- Installation de chasse-neige, de treuils, etc. sur la calandre (pare-buffle, pare-kangourou, etc.).
- Modifications des suspensions du véhicule.
- Installation d'appareils électroniques tels qu'un émetteur-récepteur radio ou des lecteurs de CD.
- Modifications de votre véhicule pour une personne ayant un handicap physique.



## Index

Abbreviation list ..... 386

Alphabetical index ..... 387

What to do if... ..... 396

تلفن شبانه روزی: ۰۲۱-۸۸۸۶۲۰۸۵

[FarmaSOS.com](http://FarmaSOS.com)

## Abbreviation/Acronym list

ABBREVIATIONS	MEANING
A/C	Air Conditioning
ABS	Anti-Lock Brake System
ACC	Accessory
AI-SHIFT	Artificial Intelligence Shift Control
ALR	Automatic Locking Retractor
CRS	Child Restraint System
ECU	Electronic Control Unit
EDR	Event Data Recorder
ELR	Emergency Locking Retractor
EPS	Electric Power Steering
GAWR	Gross Axle Weight Ratings
GVWR	Gross Vehicle Weight Rating
I/M	Emission inspection and maintenance
LATCH	Lower Anchors and Tethers for Children
LED	Light Emitting Diode
M + S	Mud + Snow
MMT	Methylcy clopentadienyl Manganese Tricarbonyl
MTBE	Methyl Tertiary Butyl Ether
OBD	On Board Diagnostics
SRS	Supplemental Restraint System
TIN	Tire Identification Number
TPMS	Tire Pressure Warning System
TRAC	Traction Control
TWI	Treadwear Indicators
VIN	Vehicle Identification Number
VSC	Vehicle Stability Control

**A**

**A/C** ..... 192

**ABS**

ABS ..... 162

Warning light ..... 306

**Air conditioning filter** ..... 269

**Air conditioning system**

Air conditioning filter ..... 269

Air conditioning system ..... 192

**Airbags**

Airbag operating conditions .... 83

Airbag precautions for your child ..... 87

Curtain shield airbag operating conditions ..... 84

Curtain shield airbag precautions ..... 87

Front passenger occupant classification system ..... 92

General airbag precautions .... 87

Indicators ..... 92

Locations of airbags ..... 80

Modification and disposal of airbags ..... 91

Proper driving posture ..... 78, 87

Side airbag operating conditions ..... 84

Side airbag precautions ..... 87

SRS airbags ..... 80

Warning light ..... 306

**Alarm** ..... 74

**Antenna** ..... 222, 224

**Anti-lock brake system**

Anti-lock brake system ..... 162

Warning light ..... 306

**Assist grips** ..... 214

**Audio input** ..... 200

**Audio system**

Antenna ..... 222, 224

Audio input ..... 200

AUX port/USB port ..... 200

Portable music player ..... 200

Steering wheel audio switches ..... 201

**Automatic transmission**

Automatic transmission ..... 127

Fluid ..... 349

If the shift lever cannot be shifted from P ..... 328

Indicators ..... 136

Shift lock system ..... 328

**AUX port/USB port** ..... 200

**B**

**Back-up lights**

Replacing light bulbs ..... 287

Wattage ..... 352

**Back door** ..... 38

**Battery**

Checking ..... 250

Gravity ..... 348

If the vehicle battery is discharged ..... 330

Preparing and checking before winter ..... 172

Warning light ..... 305, 306

**Bottle holders** ..... 207

**Brake assist** ..... 162

**Brakes**

Fluid ..... 249

Parking brake ..... 131

Specifications ..... 350

Warning light ..... 305

**Break-in tips** ..... 114

**C**

**Care**  
 Exterior ..... 222  
 Interior ..... 225  
 Seat belts ..... 226  
**Cargo capacity** ..... 167  
**Chains** ..... 172  
**Child restraint system**  
 Booster seats, definition ..... 98  
 Booster seats, installation ..... 102  
 Convertible seats,  
 definition ..... 98  
 Convertible seats,  
 installation ..... 102  
 Front passenger occupant  
 classification system ..... 92  
 Infant seats, definition ..... 98  
 Infant seats, installation ..... 102  
 Installing CRS with LATCH  
 system ..... 103  
 Installing CRS with seat  
 belts ..... 104  
 Installing CRS with top  
 tether straps ..... 108  
**Child safety**  
 Airbag precautions ..... 87  
 Battery precautions ..... 251, 332  
 Child restraint system ..... 98  
 Child-protectors ..... 36  
 How your child should wear  
 the seat belt ..... 58  
 Installing child restraints ..... 102  
 Power window lock switch ..... 67  
 Power window precautions ..... 68  
 Removed key battery  
 precautions ..... 273  
 Seat belt extender  
 precautions ..... 61  
 Seat belt precautions ..... 59

**Child-protectors** ..... 36  
**Cleaning**  
 Exterior ..... 222  
 Interior ..... 225  
 Seat belts ..... 226  
**Clock** ..... 133, 210  
**Clutch**  
 Fluid ..... 349  
 Pedal ..... 112, 129  
**Condenser** ..... 248  
**CRS** ..... 98  
**Cruise control** ..... 158  
**Cup holders** ..... 205  
**Curtain shield airbags** ..... 80  
**Customizable features** ..... 368  
  
**D**  
**Daytime running light  
 system** ..... 147  
**Defogger**  
 Rear window ..... 199  
 Side mirrors ..... 199  
**Dimension** ..... 342  
**Do-it-yourself maintenance** ..... 235  
**Doors**  
 Back door ..... 38  
 Door glasses ..... 67  
 Door lock ..... 34  
 Side doors ..... 34  
 Side mirrors ..... 64  
 Warning light ..... 307  
**Driver's seat belt reminder  
 light** ..... 307  
**Driving**  
 Break-in tips ..... 114  
 Correct posture ..... 78  
 Procedures ..... 112  
 Winter driving tips ..... 172

**E**

**Electric power steering**

- Electric power steering ..... 162
- Warning light ..... 306

**Emergency flashers**

- Switch ..... 296

**Emergency, in case of**

- If the engine will not start..... 327
- If the shift lever cannot be shifted from P ..... 328
- If the vehicle battery is discharged ..... 330
- If the warning buzzer sounds ..... 305
- If the warning light turns on ..... 305
- If you have a flat tire ..... 315
- If you lose your keys..... 329
- If you think something is wrong ..... 303
- If the vehicle becomes stuck..... 337
- If your vehicle has to be stopped in an emergency... 339
- If your vehicle needs to be towed ..... 297
- If your vehicle overheats ..... 334

**Engine**

- Compartment..... 243
- Engine switch ..... 124
- Hood..... 238
- How to start the engine ..... 124
- Identification number ..... 344
- If the engine will not start..... 327
- Ignition switch..... 124
- Immobilizer system..... 72
- Overheating ..... 334
- Specifications ..... 345
- Warning light ..... 306

**Engine coolant**

- Capacity ..... 347
- Checking ..... 247
- Indicator ..... 136
- Preparing and checking before winter ..... 172
- Type ..... 347
- Warning light ..... 306

**Engine immobilizer system.....72**

**Engine oil**

- Capacity ..... 346
- Checking ..... 244
- Grade ..... 346
- Initializing the maintenance data ..... 229
- Preparing and checking before winter ..... 172
- Warning light ..... 306, 307

**Engine switch.....124**

**EPS**

- EPS ..... 162
- Warning light ..... 306

**Event data recorder .....22**

**Floor mat.....215**

**Fluid**

- Automatic transmission ..... 349
- Brake ..... 249, 350
- Clutch ..... 349
- Warning light ..... 305, 307
- Washer ..... 253

**Fog lights**

- Indicator ..... 136
- Replacing light bulbs ..... 287
- Switch..... 148
- Wattage ..... 352

**Front passenger's seat belt reminder light.....307**

**Front seats**

- Adjustment ..... 43

**Front side marker lights**

- Replacing light bulbs .....287
- Switch.....145
- Wattage.....352

**Front turn signal lights**

- Indicator ..... 136
- Lever ..... 130
- Replacing light bulbs .....287
- Switch..... 130
- Wattage.....352

**Fuel**

- Capacity .....346
- Fuel pump shut off system....304
- Gas station information .....400
- Gauge ..... 133
- Indicator ..... 136
- Information ..... 353
- Refueling.....69
- Type .....346

**Fuel door.....69**

**Fuel filler door .....69**

**Fuel gauge.....133**

**Fuel pump shut off system .....304**

**Fuses.....275**

**G Gas station information.....400**

**Gauges.....133**

**Glove box.....205**

**H Hazard lights**

- Switch.....296

**Head restraints**

- Adjusting .....51

**Headlights**

- Indicator ..... 136
- Replacing light bulbs .....287
- Switch..... 145
- Wattage.....352

**Hood.....238**

**Horn.....132**

**I I/M test .....234**

**Identification**

- Engine..... 344
- Tire..... 356
- Vehicle ..... 343

**Ignition switch.....124**

**Illuminated entry system.....202**

**Immobilizer system .....72**

**Indicator lights ..... 136**

**Initialization**

- Items to initialize ..... 370

**Inside rear view mirror .....63**

**Interior light**

- Switch .....203
- Wattage.....352

**J Jack**

- Positioning a floor jack ..... 240
- Vehicle-equipped jack..... 315

**Jack handle .....315**

**K Keys**

- Engine switch..... 124
- If you lose your keys ..... 329
- Ignition switch ..... 124
- Key battery .....271
- Key number plate.....28
- Keys .....28
- Wireless remote control ..... 31

**L**

**License plate lights**

- Replacing light bulbs ..... 287
- Switch ..... 145
- Wattage ..... 352

**Light bulbs**

- Replacing ..... 287
- Wattage ..... 352

**Lights**

- Emergency flashers
  - switch ..... 296
- Fog lights switch ..... 148
- Hazard lights switch ..... 296
- Headlights switch ..... 145
- Instrument panel lights
  - switch ..... 145
- Interior light switch ..... 203
- License plate lights switch ..... 145
- Parking lights switch ..... 145
- Personal lights switch ..... 203
- Replacing light bulbs ..... 287
- Side marker lights switch ..... 145
- Tail lights switch ..... 145
- Turn signal lights switch ..... 130

**Load capacity ..... 171**

**Lock steering column ..... 125**

**Luggage compartment**

**features**

- Deck board ..... 217
- Luggage cover ..... 218

**Luggage compartment light**

- Wattage ..... 352

**M**

**Maintenance**

- Do-it-yourself
  - maintenance ..... 235
- Emission inspection and
  - maintenance (I/M)
    - programs ..... 234
- General maintenance ..... 230
- Maintenance data ..... 342
- Maintenance requirements ..... 228
- Reset the maintenance
  - data ..... 229
- Vehicle exterior ..... 222
- Vehicle interior ..... 225

**Manual transmission**

- Manual transmission ..... 129
- Oil ..... 349

**Meter**

- Instrument panel light
  - control ..... 135
- Meters ..... 133
- Multi-information display ..... 140

**Mirrors**

- Inside rear view mirror ..... 63
- Side mirror heaters ..... 199
- Side mirrors ..... 64
- Vanity mirrors ..... 209

**Multi-information display ..... 140**

**N**

**Noise from under vehicle ..... 20**

<b>O</b>	<b>Odometer</b> .....	<b>141</b>
	<b>Oil</b>	
	Engine oil .....	244
	Manual transmission .....	349
	Warning light .....	306, 307
	<b>Opener</b>	
	Fuel door .....	69
	Fuel filler door .....	69
	Hood.....	238
	<b>Outside rear view mirrors</b>	
	Adjusting .....	64
	Folding .....	65
	<b>Outside temperature display</b> .....	<b>211</b>
	<b>Overheating, Engine</b> .....	<b>334</b>
<b>P</b>	<b>Parking brake</b> .....	<b>131</b>
	<b>Parking lights</b>	
	Replacing light bulbs .....	287
	Switch.....	145
	Wattage.....	352
	<b>Personal lights</b>	
	Switch.....	203
	Wattage.....	352
	<b>Power outlet</b> .....	<b>213</b>
	<b>Power windows</b> .....	<b>67</b>
<b>R</b>	<b>Radiator</b> .....	<b>248</b>
	<b>Rear seat</b>	
	Folding down.....	47
	<b>Rear side marker lights</b>	
	Replacing light bulbs .....	287
	Switch.....	145
	Wattage.....	352
	<b>Rear turn signal lights</b>	
	Indicator .....	136
	Lever .....	130
	Replacing light bulbs .....	287
	Switch.....	130
	Wattage.....	352
	<b>Rear window defogger</b> .....	<b>199</b>
	<b>Rear window wiper</b> .....	<b>153</b>

<b>Replacing</b>	
Key battery .....	271
Fuses .....	275
Light bulbs.....	287
Tires.....	254, 315
<b>Reporting safety defects for U.S. owners</b> .....	<b>372</b>

<b>S</b>	<b>Seat belts</b>	
	ALR .....	57
	Automatic Locking Retractor.....	57
	Child restraint system installation.....	98, 102
	Cleaning and maintaining .....	226
	ELR .....	57
	Emergency Locking Retractor.....	57
	How to wear your seat belt .....	54
	How your child should wear the seat belt.....	58
	Pregnant women, proper seat belt use .....	58
	Reminder light.....	307
	Seat belt extenders .....	58
	Seat belt pretensioners .....	57

<b>Seats</b>	
Adjustment .....	43
Adjustment precautions .....	46
Child seats/child restraint system installation .....	98, 102
Cleaning .....	225
Folding down the rear seat .....	47
Folding down the rear seat precautions .....	49
Front seat adjustment .....	43
Front seat adjustment precautions .....	46
Head restraint .....	51
Properly sitting in the seat.....	78

<b>Service reminder indicators</b> .....	<b>136</b>
--	------------



**Shift lever**  
 Automatic transmission ..... 127  
 If the shift lever cannot be shifted from P ..... 328  
 Manual transmission ..... 129

**Shift lock system..... 328**

**Side airbags..... 80**

**Side marker lights**  
 Replacing light bulbs ..... 287  
 Switch ..... 145  
 Wattage ..... 352

**Side mirror**  
 Adjusting ..... 64  
 Defogger ..... 199  
 Folding ..... 65

**Spare tire**  
 Identification number ..... 356  
 Inflation pressure ..... 262, 351  
 Information ..... 356  
 Replacing ..... 315  
 Size ..... 351  
 Storage location ..... 315

**Spark plug..... 348**

**Specifications..... 342**

**Speedometer ..... 133**

**Steering wheel**  
 Adjustment ..... 62  
 Column lock release ..... 125  
 Electric power steering ..... 162  
 EPS ..... 162  
 Specification ..... 350  
 Warning light ..... 306

**Stop lights**  
 Replacing light bulbs ..... 287  
 Wattage ..... 352

**Storage features**  
 Bottle holders ..... 204, 207  
 Cup holders ..... 204, 205  
 Glove box ..... 204, 205

**Storage precautions ..... 169**

**Stuck**  
 If the vehicle becomes stuck ..... 337

**Sun visors.....208**

**Switch**  
 Cruise control ..... 158  
 Emergency flashers switch ..... 296  
 Engine switch ..... 124  
 Fog lights switch ..... 148  
 Hazard lights switch ..... 296  
 Headlights switch ..... 145  
 Ignition switch ..... 124  
 Light switch ..... 145  
 Power door lock switch ..... 35  
 Power window switch ..... 67  
 Steering wheel audio switches ..... 201  
 Turn signal lights ..... 130  
 VSC OFF switch ..... 163  
 Window lock switch ..... 67  
 Wiper and washer ..... 150, 153

**T**

**Tachometer.....133**

**Tail lights**  
 Replacing light bulbs ..... 287  
 Switch ..... 145  
 Wattage ..... 352

**Theft deterrent system**  
 Alarm ..... 74  
 Engine immobilizer system ..... 72  
 Theft prevention labels ..... 77

**Theft prevention labels.....77**

**Tire inflation pressure .....262, 351**

**Tire information**  
 Glossary ..... 362  
 Size ..... 359  
 Tire identification number ..... 358  
 Uniform tire quality grading ..... 360

**Tires**

Chains ..... 172  
 Checking ..... 254  
 If you have a flat tire ..... 315  
 Identification number ..... 356  
 Inflation pressure ..... 262, 351  
 Inflation pressure sensor ..... 255  
 Information ..... 356  
 Replacing ..... 254, 315  
 Rotating tires ..... 254  
 Size ..... 351  
 Snow tires ..... 172  
 Spare tire ..... 315  
 Tire pressure warning  
 system ..... 255, 307  
 Warning light ..... 307

**Tools ..... 315**

**Total load capacity ..... 171**

**Towing**

Dinghy towing ..... 187, 188  
 Emergency towing ..... 297  
 Trailer towing ..... 176, 177

**Trip meter ..... 141**

**Turn signal lights**

Indicator ..... 136  
 Lever ..... 130  
 Replacing light bulbs ..... 287  
 Switch ..... 130  
 Wattage ..... 352

**V**

**Vanity mirrors ..... 209**

**Vehicle data recordings ..... 21**

**Vehicle identification**

number ..... 343

**Vehicle stability control ..... 162**

**VSC ..... 162**

**W**

**Warning buzzers**

Brake system ..... 305  
 Seat belt reminder ..... 307

**Warning lights**

ABS ..... 306  
 Airbag system ..... 306  
 Anti-lock brake system ..... 306  
 Brake system ..... 305  
 Charging system ..... 306  
 Cruise control ..... 306  
 Driver's seat belt ..... 307  
 Electric power steering  
 system ..... 306  
 Electronic engine control  
 system ..... 306  
 Engine oil replacement ..... 307  
 EPS system ..... 306  
 Front passenger occupant  
 classification system ..... 306  
 Front passenger's seat  
 belt ..... 307  
 High engine coolant  
 temperature ..... 306  
 Low brake fluid ..... 305  
 Low engine oil pressure ..... 306  
 Low tire inflation pressure ..... 307  
 Low washer fluid ..... 307  
 Malfunction ..... 306  
 Open door ..... 307  
 Seat belt ..... 307  
 Seat belt pretensioner  
 system ..... 306  
 Slip ..... 306  
 SRS ..... 306  
 SRS airbag system ..... 306  
 Tire pressure ..... 307  
 Tire pressure warning  
 system ..... 307

**Washer**

- Checking ..... 253
- Preparing and checking
  - before winter ..... 172
- Switch..... 150, 153
- Warning light ..... 307

**Washing and waxing..... 222**

**Weight**

- Cargo capacity ..... 167
- Load limits ..... 171
- Weight ..... 342

**Wheels..... 266**

**Window**

- glasses ..... 67, 199, 222, 225

**Window lock switch ..... 67**

**Windows**

- Cleaning and protecting ..... 222, 225
- Power windows ..... 67
- Rear window defogger ..... 199
- Washer ..... 150, 153

**Windshield wipers..... 150**

**Wireless remote control key**

- Replacing the key battery..... 271
- Wireless remote control..... 31

امداد خودرو فاریا  
 تلفن شبانه روی: ۰۲۱-۸۸۸۶۳۸۵  
 FarmaSOS.com

What to do if...

What to do if...

A tire punctures	P. 315	If you have a flat tire
The engine does not start	P. 327	If the engine will not start
	P. 72	Engine immobilizer system
	P. 330	If the vehicle battery is discharged
The shift lever cannot be moved out	P. 328	If the shift lever cannot be shifted from P
The engine coolant temperature warning light flashes or comes on	P. 334	If your vehicle overheats
Steam can be seen coming from under the hood		
The key is lost	P. 329	If you lose your keys
The battery runs out	P. 330	If the vehicle battery is discharged
The doors cannot be locked	P. 34	Side doors
	P. 38	Back door
The horn begins to sound	P. 74	Alarm
The vehicle is stuck in mud or sand	P. 337	If the vehicle becomes stuck

The warning light or indicator light comes on

P. 305 If a warning light turns on

## ■ Instrument cluster

### Vehicles without a tachometer

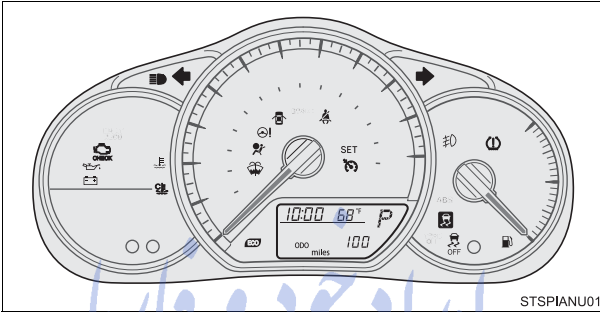

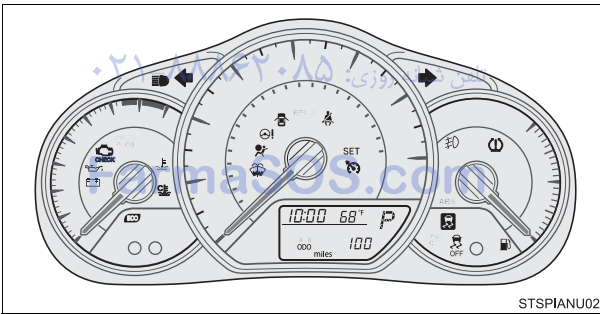

### Vehicles with a tachometer





## ■ Warning lights

<b>BRAKE</b>	Brake system warning light	
or		
		P. 305

	Charging system warning light	P. 306
---	-------------------------------	--------

	Low engine oil pressure warning light	P. 306
---	---------------------------------------	--------

	High engine coolant temperature warning light	P. 306
---	---	--------

	Malfunction indicator lamp	
or		

		P. 306
---	--	--------

	SRS warning light	P. 306
---	-------------------	--------

<b>ABS</b>	ABS warning light	
or		
		P. 307

	Electric power steering system warning light	P. 307
---	--	--------

	Slip indicator light <sup>*1</sup>	P. 307
---	------------------------------------	--------

	Cruise control indicator light <sup>*2</sup>	P. 307
---	--	--------

	Open door warning light	P. 307
---	-------------------------	--------

	Low fuel level warning light	P. 307
---	------------------------------	--------

	Driver's and front passenger's seat belt reminder light	P. 308
---	---	--------

	Tire pressure warning light	P. 308
---	-----------------------------	--------

	Low windshield washer fluid warning light	P. 308
---	---	--------

<b>MAINT REQD</b>	Maintenance required reminder light	P. 309
-------------------	-------------------------------------	--------

\*1: Slip indicator comes on.

\*2: The light flashes to indicate a malfunction.

# امداد خودرو فارما

تلفن شبانه روزی: ۰۲۱-۸۸۸۶۲۰۸۵

**FarmaSOS.com**

## GAS STATION INFORMATION

**Auxiliary catch lever**

P. 238

**Hood lock release lever**

P. 238

**Fuel filler door**

P. 69

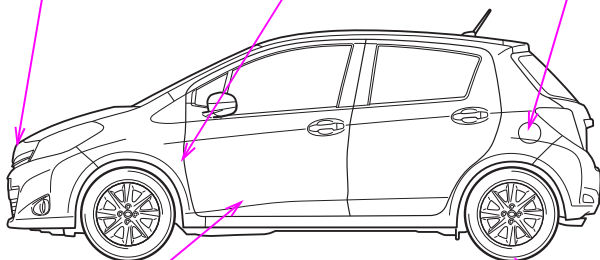

STOPIANU12

**Fuel filler door opener**

P. 69

**Tire inflation pressure**

P. 351

Fuel tank capacity (Reference)	11.1 gal. (42 L, 9.2 Imp.gal.)	
Fuel type	Unleaded gasoline, Octane Rating 87 (Research Octane Number 91) or higher	
Cold tire inflation pressure	P. 351	
Engine oil capacity (Drain and refill -reference)	With filter	qt. (L, Imp.qt.) 3.9 (3.7, 3.3)
	Without filter	3.6 (3.4, 3.0)
Engine oil type	Toyota Genuine Motor Oil or equivalent Oil grade: ILSAC multigrade engine oil. Recommended oil viscosity: SAE 5W-30	
	P. 346	