

Item	Specification	Capacity	
		CM500	CM600
Engine oil	Quality class: Ssangyong genuine engine oil (Approved by MB Sheet 229.1 or 229.3) Viscosity: MB sheet No. 224.1	≈ 7.0 ℓ	←
Automatic transmission	SHELL Fuchs ATF 3353	≈ 8.0 ℓ	←
Rear axle oil	BP Olex GO 4927	1.3 ℓ	←
Engine Coolant	SYC-310	11.5 ~ 12.0 ℓ	←
Power steering fluid	ATF DEXRON II or III	≈ 1.0 ℓ	←
Brake fluid	DOT4	as required	←

⚠ WARNING

- Use only Ssangyong recommended fluids and lubricants.
- Keep the specified levels when adding or replacing the fluids.
- Do not mix any different types or brands of oils or fluids. This may cause damages.

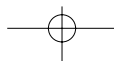

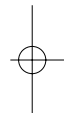
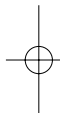
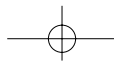
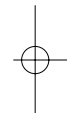
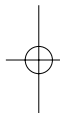
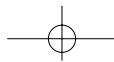

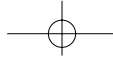

FOREWORD

This manual has been prepared to acquaint you with the operation and maintenance of your **NEW CHAIRMAN** and to provide important safety information. We urge you to read it carefully and follow the recommendations to help assure the most enjoyable, safe, and trouble-free operation of your vehicle.

When it comes to service, remember that your **SSANGYONG** Distributor knows your vehicle best and is interested in your complete satisfaction.

We would like to take this opportunity to thank you for choosing a **SSANGYONG** product and assure you of our continued interest in your motoring pleasure and satisfaction.

This manual should be considered as a permanent part of your vehicle, and must remain with the vehicle at the time of resale.



SSANGYONG reserves the right to change specifications or design at any time without prior notice and without incurring any obligation whatsoever.

IMPORTANT NOTICE

Please read this manual and follow the instructions carefully. Signal words such as "WARNING", "CAUTION" and "NOTE" have special meanings.

WARNING

WARNING

WARNING indicates a potentially hazardous situation which, if not avoided, could result in death or serious injury.

CAUTION

CAUTION

CAUTION indicates a potentially hazardous situation which, if not avoided, may result in minor or moderate injury or property damage.

NOTE

NOTE

NOTE indicates information to assist maintenance and instructions.

For product design changes

For a highest level of safety and quality, we are innovating our vehicles through our continual research and development efforts. As a result, the specifications are subject to change for the purpose of improvement without any notice and you may find material in this manual that does not apply to your specific vehicle.

All information, illustrations and specifications in this manual are based on the latest product information available at the time of publication.

Ssangyong reserves the right to change specifications or design at any time without notice and without incurring any obligation whatsoever.

This vehicle may not comply with the standards or regulations of other countries. Before attempting to register this vehicle in any other country, check all applicable regulations and make any necessary modifications.

This manual describes options and trim levels available at the time of printing, and therefore, some of the items covered may not apply to your vehicle. If any doubt exists about any of the options or trim levels, please do not hesitate to contact your Ssangyong Distributor for information on the latest specifications.

* : This asterisk in this manual signifies that an item of equipment is not included in all vehicles (model variants, engine options, models specific to one country, optional equipment, etc.).

We would like to point out that non Ssangyong Genuine parts and accessories have not been examined and approved by Ssangyong, and in spite of continuous market product monitoring, we cannot certify the suitability nor the safety of such products whether they are installed or intended for fitment in our vehicles. Ssangyong is not liable for any damage caused by the use of non-Ssangyong Genuine parts and accessories.

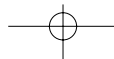
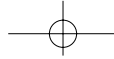

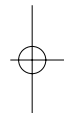
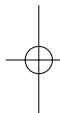
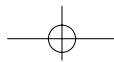

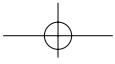
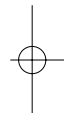
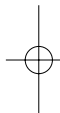
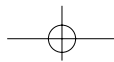

TABLE OF CONTENTS

- General Section 0**
- Safety Precautions Section 1**
- Ignition Key, Remote Control Key and Door ... Section 2**
- Opening and Closing (Windows and Others) .. Section 3**
- Interior Switches Section 4**
- Instrument Cluster Section 5**
- Transmission and Controls Section 6**
- Seats and Controls Section 7**
- Seat Belt and Air Bag Section 8**
- Ventilation, Heating and Air Conditioning ... Section 9**
- Storage and Convenience Devices Section 10**
- In Case of Emergency Section 11**
- Service and Maintenance Section 12**
- Lamps Section 13**
- Vehicle Care Section 14**
- Index Section 15**





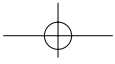

TABLE OF CONTENTS

Lubricant Specifications 0-2

Vehicle Dimension 0-3

Vehicle Identification 0-4

Specifications 0-5

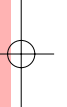

Section 0
General

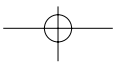

LUBRICANT SPECIFICATIONS

Item	Specification	Capacity	
		CM500	CM600
Engine oil	Quality class: Ssangyong genuine engine oil (Approved by MB Sheet 229.1 or 229.3) Viscosity: MB sheet No. 224.1	≈ 7.0 ℓ	←
Automatic transmission	SHELL Fuchs ATF 3353	≈ 8.0 ℓ	←
Rear axle oil	BP Olex GO 4927	1.3 ℓ	←
Engine Coolant	SYC-310	11.5 ~ 12.0 ℓ	←
Power steering fluid	ATFDEXRON II or III	≈ 1.0 ℓ	←
Brake fluid	DOT4	as required	←

* Use only designated oil and fluid.

⚠ CAUTION

- Automatic transmission oil check and replenishment should be performed with Ssangyong special tool and oil level gauge. Let only qualified technicians work on your automatic transmission and do not check or replenish by yourself.
- The rear axle does not need regular oil changes and you do not need to replace it. However, if you have to change or replenish the oil due to axle changes or oil leakage, use only designated oil.

⚠ WARNING

- Use only Ssangyong recommended fluids and lubricants.
- Keep the specified levels when adding or replacing the fluids.
- Do not mix any different types or brands of oils or fluids. This may cause damages.

VEHICLE DIMENSION

Top



Front



Side

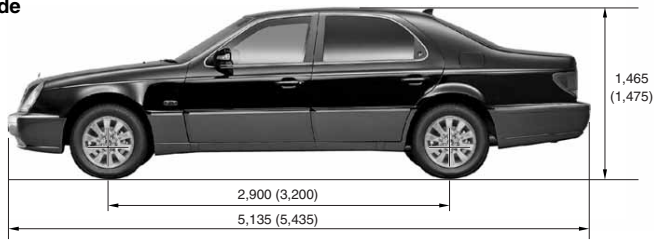

Rear



* () : Limousine

VEHICLE IDENTIFICATION

1. Chassis Number

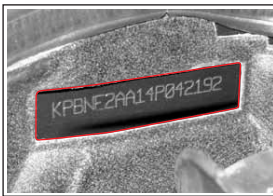

The chassis number is stamped on the bulkhead (passenger side) in engine compartment.

2. Certification Label

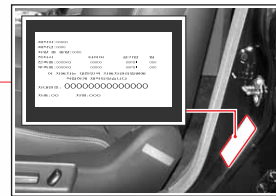

The certification label is located on the lower B-pillar.

3. Engine Number

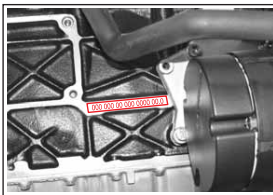

The engine number is stamped on the lower cylinder block behind alternator bracket.

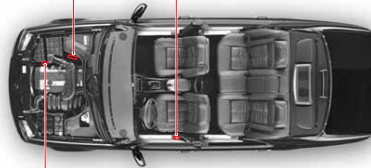

SPECIFICATIONS

Item		CM500S	CM500L	CM600S	CM600L
General	Overall length (mm)	5135	5435	5135	5435
	Overall width (mm)	1825	←	←	←
	Overall height (mm)	1465	1475	1465	1475
	Ground clearance (mm)	180	192	180	192
	Min. turning radius (m)	5.4	5.9	5.4	5.9
	Fuel	Gasoline	←	←	←
	Fuel tank capacity (L)	80	←	←	←
	Curb weight (kg) Total	1761 ~ 1788	1856 ~ 1876	1775 ~ 1819	1856 ~ 1876
	Gross vehicle weight (kg) Total	2280	2280	2280	2280
Engine	Model	162 944 [E28]	←	162 994 [E32]	←
	Type	In-line 6	←	←	←
	Total displacement (cc)	2799	←	3199	←
	Compression ratio	10.0:1	←	←	←
	Max. Power (PS/rpm)	197/6000	←	220/6000	←
	Max. Torque (kg.m/rpm)	27.6/4600	←	31/4600	←
	Idle speed (mm)	700 ± 50	←	←	←
	Firing order	1-5-3-6-2-4	←	←	←
	Camshaft arrangement	DOHC	←	←	←

() : Optional item

Item		CM500S	CM500L	CM600S	CM600L	
Engine	Lubrication	Gear pump forced circulation	←	←	←	
	Max. oil capacity (L) (when shipping)	8.2	←	←	←	
	Oil filter type	Full flow type	←	←	←	
	Cooling system	Water cooling, forced circulation	←	←	←	
	Coolant capacity (L)	11.5 ~ 12.0	←	←	←	
	Cooling fan type	Viscous clutch fan	←	←	←	
	Thermostat opening temp.(°C)	87	←	←	←	
	Air cleaner type	Dry, paper element	←	←	←	
	Fuel injection type	Electronic control type	←	←	←	
Automatic transmission	Type	Planetary gear type	←	←	←	
	Operating type	Floor change type	←	←	←	
	Oil capacity (L)	≒ 8.0	←	←	←	
	Gear ratio	1st	3.951	←	←	←
		2nd	2.423	←	←	←
		3rd	1.486	←	←	←
		4th	1.000	←	←	←
		5th	0.833	←	←	←
Reverse	1st	3.147	←	←	←	
	2nd	1.930	←	←	←	

0-6 GENERAL

NEW CHAIRMAN

Item		CM500S	CM500L	CM600S	CM600L
Clutch (automatic)	Type	3 elements 1stage 2 phases	←	←	←
	Operation type	Torque converter	←	←	←
Suspension	Front	Suspension type	Damper strut	←	←
		Spring type	Coil spring (EAS)	←	←
	Rear	Suspension type	Multi-link	←	←
		Spring type	Coil spring (EAS)	←	←
Brake	Type	Front	Disc	←	←
		Rear	Disc	←	←
	Master cylinder type	Tandem type	←	←	
	Brake operation type	Vacuum booster hydraulic type	←	←	
	Parking brake type	Foot brake (EPB)	←	←	
	Parking brake wheels	Rear	←	←	
Others	Battery	MF 115AH	←	←	
	Alternator capacity (V-A)	12-140	←	←	
	Starter capacity (V-KW)	12-1.7	←	←	
	Tires	215/60 R16 (215/55 R17)	←	←	

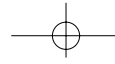

TABLE OF CONTENTS

Checks before Starting a Journey 1-2
 Daily Check 1-2
 Check the Vehicle outside 1-2
 Checking and Adjustment 1-2

Starting the Engine 1-3
 Engine Stop 1-3

Safety Precautions 1-4
 Check Engine Indicator 1-9

Vehicle Care 1-10
 Running-in Period 1-10

**Precautions Regarding Unauthorized
 Modification & Alteration 1-12**

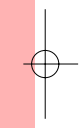

Section 1
Safety Precautions

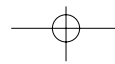

CHECKS BEFORE STARTING A JOURNEY

DAILY CHECK

- Check the engine oil, brake fluid and washer fluid level.
 - Check the drive belts for wear and looseness.
 - Check the fluid leaks underbody.
- ※ Perform daily check everyday before starting a journey.

CHECK THE VEHICLE OUTSIDE

1. Check the tire inflation and wear.
2. Check the engine oil and other fluid/oil levels in the engine compartment.
3. Clean the windshield and rear glasses, side mirrors, and room mirrors.
4. Make sure that the engine hood and trunk are properly closed.
5. Make sure that there are no obstacles in the danger area around the vehicle.

CHECKING AND ADJUSTMENT

- Make sure that the doors, sunroof, trunk and fuel filler door are completely closed before driving.
- Adjust the driver's seat, head restraint and rearview mirrors for comfortable driving.
- Put away things that interfere with driving.

CAUTION

- Do not place any objects such as can under the driver's feet as it might interfere with applying your brake, clutch or accelerator pedals.
- Make sure that the floor mat is firmly fixed and has proper thickness. Otherwise, it might interfere with your pedal operation.

- Adjust the outside and inside rearview mirrors to the desired position.

CAUTION

Do not attempt to adjust the driver's seat, rearview mirrors, or steering wheel while driving. Adjustments should be done before driving.

- Before driving, all occupants should fasten their seat belts.
- Check all warning lights, indicators and gauges (fuel, vehicle speed, tachometer etc.) with the ignition switch "ON".
- Check the pedal (brake, accelerator, clutch) operations.
- Make sure that there are not any obstacles around the vehicle.

STARTING THE ENGINE

1. Apply the parking brake.
2. Make sure that there are no persons or obstacles in the danger area around the vehicle.
3. Move the shift lever to the **"P"** position and depress the brake pedal.
4. Turn the ignition key to **"ON"** position.
5. Turn the ignition key to the **"START"** position and hold it until the engine starts. But do not hold the ignition key at the **"START"** position for more than 10 seconds.
6. If the engine fails to start, even if the engine does not start, turn the key back to the **"LOCK"** position and wait for 10 seconds.
7. Do not operate the starter for more than 10 seconds at a time. (The starter motor may be damaged.)
8. The engine in an automatic transmission equipped vehicle can be started only when the shift lever is at the **"P"** or **"N"** position.
9. Do not leave the key at the **"ACC"** or **"ON"** position when engine is not running. Otherwise, the battery could run down.

ENGINE STOP

1. Keep the brake pedal depressed even after the vehicle has been stopped.
2. Place the gear shift lever to **"P"** position.
3. Apply the parking brake.
4. Remove the ignition key from the key cylinder.

CAUTION

- The vehicle is controlled by various electronic control systems, which may malfunction if any device generating electromagnetic fields or waves is used near the ignition key or the vehicle.

SAFETY PRECAUTIONS

SAFETY PRECAUTIONS (I)

Ignition Key/Remote Control Key

1. Never use any duplicated key not provided by Ssangyong. It may cause a fire due to an overload in the electric circuit.
2. If you lose your keys, you have to replace the whole key set to prevent from theft.
3. Avoid shock to the transmitter in the remote control key and do not get it wet.
4. Only use the batteries with the same specifications to replace the discharged battery. Do not reverse the polarity.

Air Bag

1. Never impact the air bag installations by hands or tools.
2. The air bag system serves as a supplement to the seat belt. Make sure that you and your passengers always fasten the seat belts properly even if the air bags are installed in the vehicle.
3. Do not place any objects on the air bag inflation location. You may be injured by those objects during deployment.
4. The air bag system should be inspected 10 years after installation regardless of its appearance and other conditions.
5. Repairs to the air bag system should be done only at the nearest Ssangyong Dealer or Ssangyong Authorized Workshop.

6. Do not diagnose the circuit with a circuit tester. Do not attempt to modify any air bag components including the steering wheel, air bag mounting area, and harness.
7. Never install a child restraint in the front seat. The children on the restraint could be seriously injured by the air bag in a collision.
8. The deployed air bag unit should be removed from the vehicle and replaced with a new one.
9. When the air bag is deployed, the relevant components will be very hot, so do not touch them until they have cooled down.
10. A person who is smaller than 140 cm should sit in the rear.

Hazardous Materials

Do not store any flammable items or disposable lighters in the console box or other spaces. In hot weather, they can explode and cause a fire.

Genuine Parts

Always use only Ssangyong genuine parts for replacement. Ssangyong is not liable for any damage caused by the use of non-Ssangyong genuine parts and accessories.

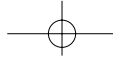

SAFETY PRECAUTIONS (II)

Tire

1. Be sure to use the same size and type of tires from the same manufacturer on all wheels. Otherwise, damage can be caused to the powertrain.
2. Keep the specified tire inflation pressure.
3. Make sure that the spare tire is ready for use at any time. After installing the spare tire on a wheel, do not drive for a long distance. Instead, visit a nearby dealer or tire shop to replace the spare tire with a regular tire for driving.
4. Always check the tire surface for damage and uneven wear before driving and replace it if needed.
5. Using tires of different specifications may cause high fuel consumption, long stopping distance, vehicle body vibration, heavy steering operation, and poor ABS operation.

Power Window

1. When you operate the rear windows from the driver's seat while a child sits in the rear, make sure that no body part of the child is between the window and the window frame.
2. When carrying children in the rear seat, press the rear door window lock switch to make the rear door switches inoperative.
3. Make sure that all passengers have their body parts such as hands inside the vehicle.
4. When closing the windows, be aware of safety conditions before operation.

Warming Up the Engine

1. Do not drive without warming up the engine. Driving immediately after starting the engine may decrease the engine's life expectancy. Warm up the engine before moving your vehicle.
 2. Do not warm up the engine excessively. Warm up the engine just until the coolant temperature gauge begins to move.
 3. Excessive engine warming increases the fuel consumption and air pollution. An optimized warming up time is approx. 2 minutes.
- ※ Do not accelerate the engine during the warming up period.

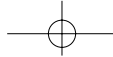

SAFETY PRECAUTIONS (III)

Driving OFF the Vehicle

1. Keep the brake pedal depressed and shift the gear selection lever into the "D" position. Make sure that the "D1" light is on the instrument cluster.
Drive off the vehicle by releasing the brake pedal slowly.
2. To avoid any possible damage to the automatic transmission, do not abruptly drive off or accelerate the vehicle after shifting the gear selection lever into the "D" position. Especially on a hill, move the lever to the "D" position with the brake pedal depressed and wait for a couple of seconds until the position indicator of "D1" is on the instrument cluster.
3. Your vehicle may move backward on a steep hill even if the shift lever is engaged into the "D" position. Therefore, always depress the brake pedal when you need to stop on such a hill.

Cautions While Driving

1. Do not turn off the engine while the vehicle is in motion. The power steering function and the brake assist function will be deactivated.
2. Do not attempt to adjust the driver's seat, rear view mirrors, or steering wheel while driving. Adjustments should be done before driving.
3. Do not operate the steering wheel abruptly. This will cause unstable driving situations and can end with an unexpected accident.
4. Abrupt Start, Acceleration and Stop
 - Avoid abrupt starts, acceleration or stops. It may cause high fuel consumption or an accident.
 - Gently accelerate and decelerate the engine.

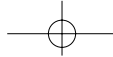

SAFETY PRECAUTIONS (IV)

Stopping and Parking the Vehicle

1. Never leave infants and children unattended in the vehicle with the doors locked. They can move the vehicle unexpectedly. They can be suffocated in especially hot weather.
2. When parking the vehicle on a hilly road, apply the parking brake and chock the blocks under the wheels. Place the gear shift lever to the “P” position.
3. If possible, do not stop and park the vehicle on the steep road.
4. Do not park in places where hay, foliage, paper, rags, oil, or other easily inflammable materials are kept. While driving or after immediately driving, the muffler and exhaust pipe are hot; inflammable materials near the vehicle might cause a fire.

Extinguisher

Keep it ready for use at any time. Be familiar with how to use it. For more information, read the label on the surface of the fire extinguisher.

Precautions for Children or Elderly Car Passengers

- Do not leave infants, children or old people alone in the vehicle. An accident can take place if they misuse some devices in the vehicle. In addition, the temperature inside the car can rise when doors or windows are closed during summer, placing passengers at risk for suffocation.
- Do not let children, infants, old people, or a pregnant woman sit in the front passenger seat with the airbag. The degree of shock of the airbag's expansion can be fatal or inflict serious injuries to such passengers.
- Keep devices such as the ignition key out of children's reach to avoid damaging the vehicle or prevent accidents.

Do Not Stick Any Part of Your Body Out of the Window

Do not stick any part of your body out of the window and sunroof while the car is running or while you are maneuvering to park. You might be hurt by the passing vehicles or other unseen obstacles.

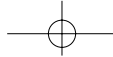

SAFETY PRECAUTIONS (V)

When Sleeping in Your Vehicle

- Do not sleep in a parked car with closed windows. In particular, if you stay or sleep in the car with the engine running and the air-conditioner or heater turned on, you can suffocate to death.
- Sleeping in a closed space with the engine running puts you at high risk of suffocation from the exhausts.
- While sleeping, you may accidentally touch the gear shift lever or accelerator and thereby cause an accident.
- While sleeping in the car with the engine running, you may accidentally step on the accelerator, thereby overheating the engine and exhaust pipe and causing a fire.

No Alcohol and Drugs! Take A Rest!

- Avoid driving for an extended period of time. Driving continuously without rest makes you prone to dozing off and thus causes an accident. For your safety, take a rest every 2 hours.
- Driving under the influence of alcohol or drugs is prohibited. It impairs judgment, making driving highly risky. Drunk driving is also a legal offense.

Do not drive with Trunk or Doors Open

- Do not drive with the trunk open. Otherwise, you can be suffocated by the exhaust gas.
- If you drive your vehicle with the trunk open, loose objects inside the vehicle may cause an accident.
- Driving the vehicle with the doors open puts the passenger at risk of being thrown out, which can cause serious injury.
- Always drive the vehicle with the doors and trunk closed. Doors can be accidentally opened and doors are opened by children touching knobs. Those may cause a serious accident.

Check for any Passing Vehicle when Getting Off

When getting off, check the rear and side of the car for passing vehicles or pedestrians. Vehicles or motorcycles coming from the rear, if unchecked, might stumble on you when you open the door.

Use Only Ssangyong Dealer or Ssangyong Authorized Workshop

Have your vehicle checked or repaired at the Ssangyong Dealer or Ssangyong Authorized Workshop. Repairing your vehicle by other service stations will not be covered under the terms of our warranty. And the warranty is also not liable for the problems caused by such repair.

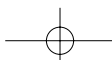

CHECK ENGINE INDICATOR



The check engine indicator on the instrument cluster comes on when the fuel or major electronic systems of the engine are not working properly. As a result, the engine's power output may decrease or the engine may stall. If this happens, please visit the nearest Ssangyong dealer or authorized service operator.

VEHICLE CARE

RUNNING-IN PERIOD

There are no particular running-in rules for your new vehicle. However, following a few simple precautions for the first 1,000 km can add to good future performance, fuel economy and long life of your vehicle.

- Allow the engine to warm up after starting.
- Avoid harsh operations such as abrupt fast starts, sudden acceleration and prolonged high speed driving.
- Do not race the engine.
- Drive at proper speeds, trying not to "strain" the engine.
- Avoid overload when climbing.

Bumper Washing

1. Remove the dirt or dust first with water and a sponge.
2. If the bumper is contaminated by engine oil or any lubricants, wipe it off using mild soapy water.

CAUTION

Do not use abrasive wax and strong cleaning materials such as steel wool which will scratch the vehicle body and bumper.

Cleaning the Outside of the Windshield

If your windshield is not clear after using the windshield washer, or if the wiper blade chatters when running, wax or another material may be on the blade or windshield, clean the outside of the windshield with cleaning powder or an equivalent non abrasive cleaner. Your windshield is clean if beads do not form when rinsing with water.

CAUTION

Do not clean the windshield with oily or waxy cloth. It may cause noise or vibration while operating the wipers, poor front view, and light reflection at night time. In addition, the windshield may not be wiped off completely when it rains.

Cleaning Aluminum Wheels, Alloy Wheels, and Wheel Covers

Preserve the original appearance of wheels or wheel covers by keeping them clean and free from build-up of road dirt and/or road salt. Wash the parts regularly. Do not use abrasive cleaners or cleaning brushes, as they could damage the finish.

All wheels and wheel trim, especially aluminum and chrome plated wheels should be cleaned regularly with mild soap and water to prevent corrosion. To remove heavy soil, select a non-abrasive, non-acidic cleaner. Do not use scouring pads, steel wool, a bristle brush or metal polishes. Avoid automatic car washes that use acidic solutions or harsh brushes that may damage the wheels' protective finish.

Clean the wheels after driving on a coastal road or on a road where the snow removal chemicals (calcium chloride etc.) has been spreaded.

CAUTION

Never clean the aluminum wheel or alloy wheel with acidic or alkaline detergents. Otherwise, wheel's protective finish could be damaged.

Engine Brake

When the accelerator pedal is released while the vehicle is in motion, the engine speed decreases. This decreased engine speed creates an extra braking force. On a down hill, engaging a lower gear can generate a slower engine speed and eventually slow down the vehicle speed. By using this engine brake, you can decrease your vehicle speed without excessively using the brake system. The lower gear, the more braking force.

CAUTION

- Do not excessively apply the brake pedal while going down a long hill. The brake system will overheat, experience vapor lock or the fade phenomenon, and lose the braking force.

Fade?

Reduction or loss in braking force due to loss of friction between brake pads and disc.

Vapor Lock?

When the brake system is overheated, the fluid in the brake lines will boil and form bubbles. Only the bubbles will be compressed when the brake pedal is depressed. So the brakes cannot work properly due to loss of braking force.

PRECAUTIONS REGARDING UNAUTHORIZED MODIFICATION & ALTERATION

PRECAUTIONS REGARDING UNAUTHORIZED MODIFICATION & ALTERATION (I)

Do not modify this vehicle.

If unauthorized modification is made on the vehicle, the company is not liable for repairing the modified parts even during the term of warranty. Other part problems caused by modification are also not covered.

The vehicle you bought is equipped with a large number of precision parts that have passed through countless experiments and tests. These parts are deeply and systematically interwoven. Therefore, if any part is modified or altered without authorization, said parts may be damaged from the decrease in performance or overloading, which can then cause critical damage to the vehicle and human life.

Do not modify without authorization the driving gear system, including the engine, just to upgrade the vehicle's performance and beauty.

- Prohibition of using unauthorized modification of the engine or parts for the exhaust

Changing without authorization the preset value in the fuel supply system and inlet, exhaust and electric systems, and changing or adding unauthorized parts is illegal and may cause serious problem with the vehicle's durability.

In particular, modifying your vehicle into the LPG vehicle might bring serious damage to the vehicle's performance and durability. Not only the engine but also the transmission and wheel alignment are excluded from the warranty.

If you install a wheel dust cover on the tires to enhance the beauty of tire parts, the heat caused by friction in braking might bring serious problems in performance, causing Vapor Lock and Fade phenomena.

Do not modify the car's audio system and install other additional electronic devices such as wireless communication equipment, rear view camera, LCD TV, and remote starting device.

This vehicle's electronic system contains electronic circuits and fuses for the installation of standard electric and electronic devices. If you add new devices or circuits using the several existing devices and circuits at a time, electric and electronic devices can be damaged from overloading and may ignite. In addition, when you do drilling work in installing devices such as an antenna may expose the vehicle to rusting.

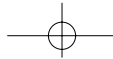

⚠ PRECAUTIONS REGARDING UNAUTHORIZED MODIFICATION & ALTERATION (II)

Do not use the nonstandard tires, wheels, and other related parts.

Installing nonstandard tires such as tires with greater width than prescribed can wear out the power delivery system or friction-damage related parts. In addition, other problems such as increase of fuel consumption and braking distance, vehicle's shudder, and decrease of steering power can all degrade the vehicle's performance. The speedometer and odometer can also become inaccurate. The vehicle with automatic transmission may have the shock in changing the speed.

Do not use duplicate key

A duplicate key might cause malfunction to the ignition key cylinder and deter the ignition motor to return to the original state. If so, electronic circuitry can be damaged and may ignite from the ignition motor's continuing rotation.

Do not equip the sunroof or color glasses at your discretion.

If you install a sunroof by cutting the vehicle's roof, rust and leakage may occur in the cut part. Installing color glasses to block ultraviolet rays and better appearance may cause leakage and other many problems.

Do not equip the vehicle with bumper guards sold in the market.

Installing bumper guard or other guard bars that are being sold in the market may cause problems in parking and stopping due to the extended length of vehicle, and increase in fuel cost due to additional vehicle weight, and rusting may occur in the holes for equipping the guards. And because of the absence of shock absorber in the bumper guard, even accidents during low-speed driving will be much serious compared with the damage that unmodified cars might sustain.

Do not modify or replace the vehicle flooring or the seats at your discretion.

- When replacing the interior flooring of vehicle with laminated paper

To improve the comfort of cushion and to facilitate the cleaning of the vehicle, some drivers replace the flooring with laminated paper after removing the seats. However, this may cause damage to the various electronic system control units and wiring. This also may hinder the function of the seat rail that enables for the seat to move forward and backward. In this case, the locking system to fix the location of seats may malfunction, which might lead to a serious accident if the loose seats tilt forward or backward during an uphill climb or downhill descent.

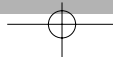

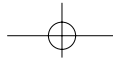

PRECAUTIONS REGARDING UNAUTHORIZED MODIFICATION & ALTERATION (III)

- When exchanging the seats with new ones or equipping separate seat covers.

There are several types of seat covers according to role and function although with the same vehicle type. Replacing the seats with new ones may alter the wiring system or over-use the wires because a seat has various electric connections and wiring diagram. As mentioned earlier, this may damage the wiring and related equipment or cause fire due to the overloading on the rated capacity.

In addition, replacing the seat cover may damage the electronic equipment caused by cut or pressured wire. Such a situation may also cause ventilation problems, fire, or noise.

Do not equip with a separate accessory or assistant device on the vehicle operational device.

Making the selection lever longer or equipping with an accelerator pedal and brake pedal pad may make the driver prone to make a mistake while driving.

Do not install products that may decrease the driving resistance such as sticker, molding, air dam, or wind-proofing products.

The sticker's adhesives may damage the coated surface of the vehicle. If parts of the car are drilled to attach molding and other functional parts, the area near the holes will rust and other unfamiliar sound may occur while driving. Especially if the attached parts are not fixed well, it may damage the vehicle or even cause a fatal accident.

In using audio in the vehicle, do not use illegally copied CD and DVD, which violates relevant laws. Such discs can also cause malfunction of the audio head unit and changer. In addition, such discs may also not play properly.

When installing the vehicle with unauthorized parts or modifying it in ways including the cases mentioned previously, please keep in mind that the changed parts and related problems with changed auto parts shall not be covered by warranty.

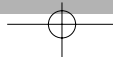

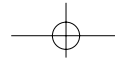

TABLE OF CONTENTS

Ignition Key and Remote Control Key 2-2
 Key Functions 2-3

Remote Control Key 2-4
 Door Lock Button 2-4
 When a Remote Control Key is Lost 2-4
 Door Unlock Button 2-4
 Trunk Open Button* 2-5
 Battery Replacement 2-5
 Panic (Emergency Alarm) Button 2-5
 Starting the Engine 2-6

Opening and Closing (Door, Glove Box and Trunk Lid) 2-8
 Coupled Operation (Window, Outside Rearview Mirror and Sunroof) 2-9

Immobilizer System 2-10

Theft Deterrent System 2-11
 Theft Deterrent System Activation 2-11
 Theft Deterrent System Operational Conditions 2-11
 Theft Alarm 2-11
 Theft Deterrent Deactivation 2-11

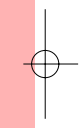

Section 2
Ignition Key,
Remote Control Key
and Door

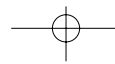

IGNITION KEY AND REMOTE CONTROL KEY

1. Master Keys (2 units)

1. Engine starting
2. Opening and Closing (Door/Glove box/Trunk lid)
3. Coupled operation (Window, Outside rearview mirror, and Sunroof)
4. Battery specification: 625A

2. Secondary Key (1 unit)

1. Engine starting
2. Door opening
3. Linked operation (Window, Outside rearview mirror, Sunroof)

This key can only open/close the door and start the engine. It cannot open the trunk lid or glove box. To prevent from valuables from being stolen, give only this key when valet parking.

3. Remote Control Key

- 3A: Door lock button
- 3B: Door unlock button
- 3C: Panic (emergency alarm) button
- 3D: Trunk open button (with power trunk)

Range of operation

- Approx. 5 meters from the vehicle (depending on the conditions around the vehicle)

CAUTION

- Please keep the master key in a separate place. Ssangyong will not provide additional keys when you lose your keys. If you lose your keys, you have to replace whole key set to prevent from theft.
- Never use any duplicated key not provided from Ssangyong.

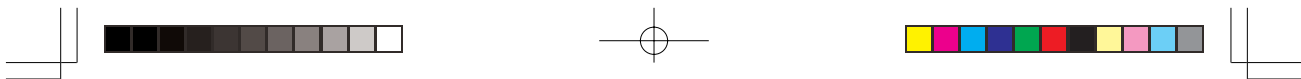

KEY FUNCTIONS

The ignition key set consists of two master keys and one secondary key.

Please refer to the table below for their functions.

By pressing the button on the master key fob, the key illumination lamp will help you find the door lock when dark.

Master keys

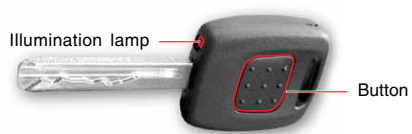

Secondary key

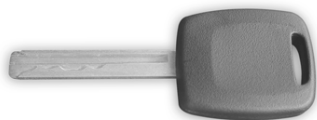

Key functions

	Master key	Secondary key
Engine starting	O	O
Door opening	O	O
Glove box opening	O	X
Trunk lid opening	O	X
Coupled operation for window, Outside rearview mirror, and Sunroof	O	O

REMOTE CONTROL KEY

Functions: 1. Door locking/unlocking and Coupled operation for windows, outside rearview mirrors and the power trunk.
2. Panic (emergency alarm) operation

DOOR LOCK BUTTON

Door Lock Operation

Shortly press this button once to lock all doors. Hazard warning lamps will flash twice with a single "beep" sound. All doors, must be fully closed for this operation.

Folding Exterior Rearview Mirrors

To fold exterior rearview mirrors, briefly press the door lock button of the remote control keys and press it again within 5 seconds.

Unfolding the Exterior Rearview Mirrors

To unfold exterior rearview mirrors, briefly press the door unlock button of the remote control keys and press it again within 5 seconds.

Door Auto-relock

If doors are not opened within 30 seconds after unlocking doors using the remote control key, all doors will be automatically locked.



DOOR UNLOCK BUTTON

Briefly press this switch to unlock all doors. Hazard warning lamps will flash once within one second in order to make sure for being open.

CAUTION

- If the door is not opened within 30 seconds after unlocking the door with remote control key, all the doors will be locked automatically.
- All doors, engine hood and trunk lid must be fully closed to lock the doors by remote control key or ignition key.
- The buttons on the remote control key cannot be operated when the engine is running.
- Lock and unlock buttons on the remote control key cannot be operated when the tail lamps or driving lights are turned on.

WHEN A REMOTE CONTROL KEY IS LOST

When one of the remote control keys is lost and a new remote control key is purchased, bring the duplicate of the old remote control key (dual REKES type) to the nearest Ssangyong Dealer or Ssangyong Authorized Workshop and have it recoded. Otherwise, the old key will not work.

TRUNK OPEN BUTTON*

To open the trunk, briefly press the door unlock button (🔓) to deactivate the anti-theft mode, and press and hold the power trunk open button.

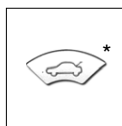

PANIC (EMERGENCY ALARM) BUTTON

If you are near your vehicle and feel threatened, you may activate the alarm to call attention.

If you press this button, the warning siren will sound for approx. 28 seconds. The siren will stop when any of the buttons on the remote control key is pressed.

CAUTION

This function operates only when the vehicle is in theft deterrent mode.

BATTERY REPLACEMENT



Flip open the rear cover using a suitable tool and replace the battery with new one.

Specification

- CR2025 (DC 3V)

NOTE

The battery life varies according to its usage. Very frequent usage of the transmitter will reduce the life of the battery.

STARTING THE ENGINE



LOCK position

- Insertion/removal of key
- Steering wheel locking

ACC position: Accessory

- Some electrical accessories are activated

ON position

- Electrical accessories are activated
- Driving or engine running condition

START position

- Engine starting
- The key automatically returns to ON position after starting

Starting the Engine

1. Move the shift lever to “P” position.
2. Depress the brake pedal.
3. Turn the key to “START” position.
4. Release the key when the engine starts.

Unlocking the Steering Wheel

If the ignition key does not turn, it means that the steering wheel is locked. At this time, gently turn it to ACC or ON position while slightly moving the steering wheel right and left.

Key Reminder

The buzzer will sound if the driver's door is opened while the key is left in the ignition switch on the condition that the ignition key is in the ACC or ON position.

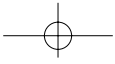

⚠ WARNING

- Never press down the accelerator pedal while starting.
- Immediately release the key when the engine starts.
- Do not operate the starter for more than 10 seconds at a time.
- If the engine does not start, wait 10 seconds before trying again.
- To start the engine again, turn the key to “**LOCK**” position and turn to “**START**” position again.
- Keep your foot on the brake pedal while starting the engine.
- To unlock the steering wheel, insert the key and turn it gently while rotating the steering slightly right and left.
- Engine can be started at “**N**” position. But for safety, please start the engine at “**P**” position.
- Do not leave the key at “**ON**” position when engine is not running. Otherwise, the battery could run down.

⚠ WARNING

- After starting the engine, let it run for approx. 1 ~ 2 minutes at idle speed. Do not accelerate the engine during the warming up period.
- A warning buzzer sounds when opening the driver's door with the key positioned at the “**ACC**” or “**LOCK**” position.
- Never turn the key to the “**LOCK**” position or withdraw the ignition key from the ignition switch while driving. The steering wheel will be locked and you may end up with serious injuries.
- Never use any duplicated key not provided from Ssangyong.

The duplicated key might not turn back to the “**ON**” position. It may cause a fire due to an overload in the electric circuit. In addition, the engine with the immobilizer system cannot be started with the duplicated key.

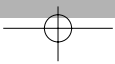

OPENING AND CLOSING (DOOR, GLOVE BOX AND TRUNK LID)

Door

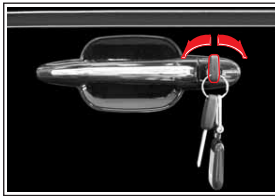

To unlock the door:

Turn the key to the unlock position (toward the rear of the vehicle) from driver's door or passenger's door. All doors will be unlocked.

To lock the door:

Turn the key to the lock position (toward the front of the vehicle) from driver's door or passenger's door. All doors will be locked.

Glove Box (master key)

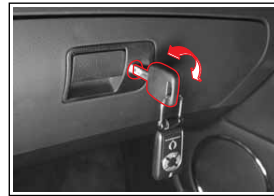

Turn the master key clockwise to unlock the glove box.

Trunk Lid (master key)



Turn the master key clockwise to open the trunk lid.

CAUTION

- Even when the trunk lid opening lever and opening switch cannot be operated due to the discharged battery, the trunk lid can be opened with master key.
- The secondary key can only open/close the door and start the engine. It cannot open the trunk lid or glove box. To prevent from valuables from being stolen, give only this key when valet parking.

COUPLED OPERATION (WINDOW, OUTSIDE REARVIEW MIRROR AND SUNROOF)

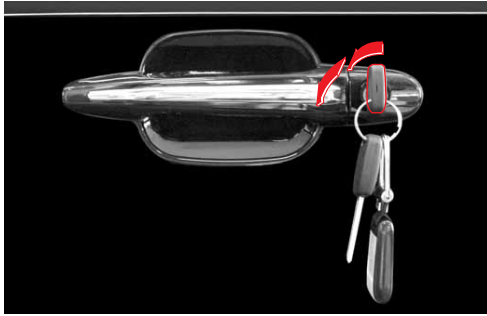

To close the windows:

1. Insert the key into the driver's or passenger's door lock, and turn to lock position toward the front of the vehicle for more than 2 seconds.
2. While you are holding the key, the windows will be closed, the outside rearview mirrors will be folded and the sunroof will be closed (if equipped).
All the doors should be closed beforehand.



To open the windows:

1. Insert the key into the driver's or passenger's door lock, and fully turn to the lock position toward the front of the vehicle.
2. Turn the key to unlock position toward the rear of the vehicle for more than 2 seconds within 5 seconds of opening the windows. Then the windows will be opened, the outside rearview mirrors will be unfolded and the sunroof will be opened (if equipped).

IMMOBILIZER SYSTEM

The immobilizer system is the system that only allows the authorized key to start the engine to prevent theft. The transponder integrated in the key and the engine control unit have the same code. When you try to start the engine by turning the ignition switch on, the engine control unit checks the code and allows the engine start only when the code is correct.

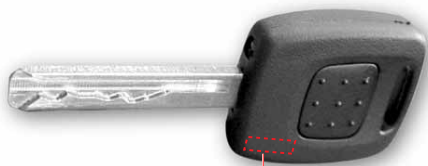

Transponder

The transponder is an integration of all the keys (including the secondary key) and has its unique crypto code.

Transponder Code

The transponders of three keys (including secondary key) are coded.

When the Key Has Been Lost

The code for lost key should be deleted from engine control unit at the nearest Ssangyong Dealer or Ssangyong Authorized Workshop.

When the Transponder is Damaged

To start the engine, all the transponders should be replaced with new ones and new codes should be registered to engine control unit at the Ssangyong Dealer or Ssangyong Authorized Workshop.

WARNING

- Never remove or modify the immobilizer system in any case. If the system has been damaged, the engine cannot be started.
- Remote starting device cannot be installed in the vehicle equipped with the immobilizer system.

CAUTION

- Dropping or impacting the key may damage the integrated transponder.
- All the transponder systems should be replaced when replacing engine control unit.
- Any service works related with the immobilizer system should be done by qualified personnel at the Ssangyong Dealer or Ssangyong Authorized Workshop.
- The vehicle owner must observe the service works when deleting the transponder codes or registering additional keys.

CAUTION

In the following cases, you may be unable to start the vehicle with the immobilizer.

- When two or more immobilizer keys are in contact with each other.
- When the key is used near any device generating electromagnetic fields or waves.
- When the key is used near any electronic or electric devices such as lighting equipment, security keys or security cards.
- When the key is used near a magnetic or metallic object or battery.

THEFT DETERRENT SYSTEM

THEFT DETERRENT SYSTEM ACTIVATION

Theft deterrent system will be activated under the following conditions:

- When the doors are locked using the remote control key (including the cases of automatic locks of doors after unlocking the doors without getting on it).
- When the doors are locked by using the ignition key.

CAUTION

For the theft deterrent system activation, the ignition key should be removed from ignition switch, all doors including trunk lid and hood should be closed completely.

THEFT DETERRENT SYSTEM OPERATIONAL CONDITIONS

If somebody tries to open the door, trunk lid, or the hood without using the ignition key or the remote control key, the alarm will be activated.

- The alarm will be activated when the door or the engine hood is opened without the ignition key or remote control key after closing the door for more than 2 seconds.
- The alarm will be activated when the trunk lid is opened without using the ignition key after closing the trunk lid for more than 2 seconds.

THEFT ALARM

The alarm will sound and the tail lamps will flash.

- The alarm will sound for 30 seconds. If another alarm condition is met during this period, then another 30 seconds will be added from that point.
- The tail lamps will flash for 5 minutes. If another alarm condition is met during this period, then another 5 minutes will be added from that point.

THEFT DETERRENT DEACTIVATION

- To deactivate the theft deterrent mode during alarm activation, unlock the doors using the ignition key or the remote control key.
- To stop the alarm, open the door or trunk lid using the ignition key or press any button on the remote control key. However, alarm will sound again when theft deterrent system is reactivated.
- The theft deterrent mode will be cancelled when doors are unlocked using the ignition key or the remote control key.

NOTE

When the trunk lid is opened and then closed, a siren ("beep" sound) will sound and the vehicle will be newly alarmed after 2 seconds until a release signal is given.

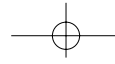

TABLE OF CONTENTS

Doors 3-2
 Central Door Locking System 3-3
 Automatic Door Locking System 3-3
 Automatic Door Locking Release 3-3

Opening and Closing (Windows and Others) 3-4

Power Window 3-5
 Driver's Window Switch 3-5
 Passenger's and Rear Window Switch 3-6
 Time Lag Operation of Window 3-6

Sunroof* 3-7
 Coupled Operation with Ignition Key 3-7

Sunroof Manual Operation 3-8

Engine Hood 3-9

Fuel Filler 3-10
 Recommended Fuel 3-11

Trunk 3-12
 Standard Trunk 3-12
 Power Trunk* 3-13

Section 3
Opening and Closing
(Windows and Others)

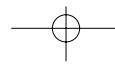

DOORS

Be sure to completely close all doors before driving.

To Open the Driver's Door (from inside)

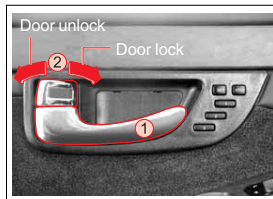

1. Move the driver's door lock button (2) to unlock position (rearward) to unlock the driver's door.
2. Pull the door handle (1) to open the door.

NOTE

- All doors will be locked when moving the driver's door lock button (2) to the lock position, but only the driver's door can be unlocked when moving it to unlock position.
- All doors will be unlocked when the engine is turned off.

CAUTION

All the doors will be automatically locked when the vehicle is at speed of over 50 km/h without locking the doors.

To Open the Passenger's Door (from inside)

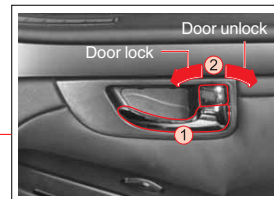

If you move the passenger's door lock button (2) to the lock position, all doors except driver's door will be locked.

CAUTION

- If you move the passenger's door lock button (2) to the unlock position, only the passenger's door can be unlocked.
- When you lock the doors with door lock button or door lock control switch, the theft deterrent alarm system will not be alarmed.



Door Lock Control Switch

► To lock all doors:

Move this switch to the lock position (front of the vehicle) to lock all doors at once.

► To unlock all doors:

Move this switch to the unlock position (rear of the vehicle) to unlock all doors at once.



CENTRAL DOOR LOCKING SYSTEM

Selecting the Door Lock Button Using the Ignition Key

If you select the door lock button position to lock or unlock position from outside of the driver's or passenger's door by using the ignition key, all the door locks will be locked or unlocked.



Selecting the Driver's Door Lock Button to Lock or Unlock Position

If you move the driver's door lock button to the lock position, all door locks will be locked.

Only the driver's door will be unlocked if you move the driver's door lock button to unlock position when all door locks are locked.

Selecting the Passenger's Door Lock Button to Lock or Unlock Position

If you move the passenger's door lock button to the lock position, all door locks except driver's door will be locked.

Only the passenger's door will be unlocked if you move the passenger's door lock button to the unlock position.

AUTOMATIC DOOR LOCKING SYSTEM

Automatic Door Locking

All the doors except the driver's door will be automatically locked when the vehicle speed goes up 50 km/h without locking the doors.

Automatic Door Unlocking

If you turn the ignition switch to "OFF", all the doors will be unlocked automatically.



AUTOMATIC DOOR LOCKING RELEASE

All the locked doors will be automatically released if you have any accidents while driving over a certain speed.

**WARNING**

Automatic door locking system may not function when the door or the body is deformed by collision.

OPENING AND CLOSING (WINDOWS AND OTHERS) *Be sure to close all doors securely before driving.*

1. Window



1A: Driver's window switch
1B, 1C, 1D: Passenger's and rear windows switch

2. Fuel Filler Lid

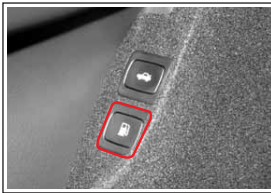

Fuel filler lid opening switch

3. Engine Hood



Hood opening lever

4. Sunroof



Sunroof switch

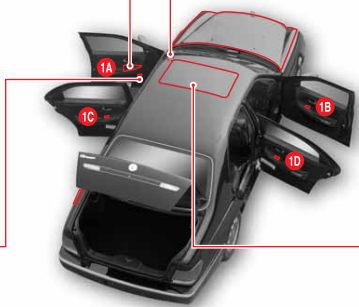

POWER WINDOW

DRIVER'S WINDOW SWITCH

1. Driver's Window Switch

The power window switches on the driver's door trim will operate all windows.

If the window lock switch is pushed, all windows are operated only by the driver's window switches.

Coupled operation of windows by using remote control key and the ignition key (including the outside rearview mirror)

This feature is very useful to ventilate the hot air before getting into the vehicle during summer. (For more information, refer to section 2 "Ignition Key, Remote control Key and Door")

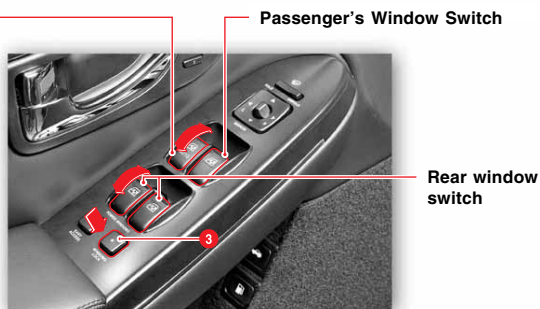

2. Window Lock Switch

If the window lock switch is pressed down, passenger's and rear windows cannot be operated by their switches.

Press this switch again to release the window lock (switch up).

⚠ WARNING

For the safe driving, push this switch when you have children on board.

When carrying children in the rear seat, press the window lock switch to make the rear window switches inoperative. Do not allow children to play with the power window switch and rear door window switches.

⚠ CAUTION

When closing the passenger's and rear windows from driver's seat, be aware of safety conditions before operation. Parts of the body can be trapped by the window.

Driver's Window Switch

► When opening the window

- When the front of the switch is lightly pressed, the window will be lowered while the switch is pressed.
- When pressed to its end, the window will automatically open until it is fully open. If you want to stop the window while automatic lowering, lightly pull the switch up.

► When closing the window

- When you lightly pull the switch up, the window will move up only while the switch is being operated.

► When the window lock switch is in lock position

If the window lock switch is pressed down, passenger's and rear windows cannot be operated by their switches.

⚠ WARNING

- Make sure that all passengers have their body parts such as hands inside the vehicle before closing the windows.
- Make sure that passengers should not stick out their hands or heads from the vehicle.
- When closing the windows, be aware of safety conditions before operation. Parts of the body can be trapped by the window and hit by passing objects.
- Do not allow children to operate the power window. Accidental operation of power window can result serious injuries.

PASSENGER'S AND REAR WINDOW SWITCH



► To open or close the window

To move the passenger's and rear windows up or down, pull up or press the corresponding switch for the window.

TIME LAG OPERATION OF WINDOW

The power window can be operated for 30 seconds even after the ignition key is turned to another position. However, this function stops immediately when a front door is opened.

SUNROOF*

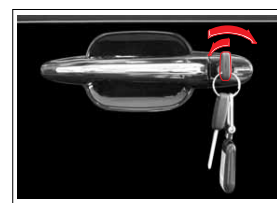
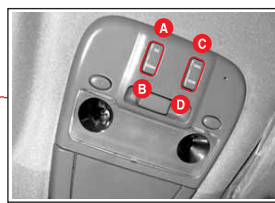

⚠ WARNING

- When you re-open the sunroof by using the coupled operation with the ignition key after closing, the sun roof will be opened to the original position before closing. If you closed the sunroof during tilted position, sunroof will be opened that tilted position.
- You cannot open the sunroof by using the coupled operation with remote control key.

To open the sunroof

1. Flip the sun shade backwards.
2. Press and hold the **OPEN** switch (C) to open the sun roof. When the sunroof reaches the desired position, release it.
3. Press and hold the **CLOSE** switch (D) to close the sun roof.

To tilt the sunroof

1. To tilt, press and hold the **TILT** switch (A) when the sunroof is completely closed.
2. To close, press and hold the **DOWN** switch (B).

COUPLED OPERATION WITH IGNITION KEY

To open the sun roof with ignition key

1. To activate the coupled operation mode, turn the ignition key to the door lock position (toward the front of the vehicle).
2. Turn the ignition key to the door unlock position (toward the rear of the vehicle) (more than 2 seconds). At this time, the windows will be opened and the outside rearview mirrors will be unfolded.

To close the sunroof with ignition key

To close the sunroof, turn the ignition key to the door lock position (toward the front of the vehicle) until the sunroof closes (more than 2 seconds). At this time, the windows will be closed and the outside rearview mirrors will be folded.

SUNROOF MANUAL OPERATION

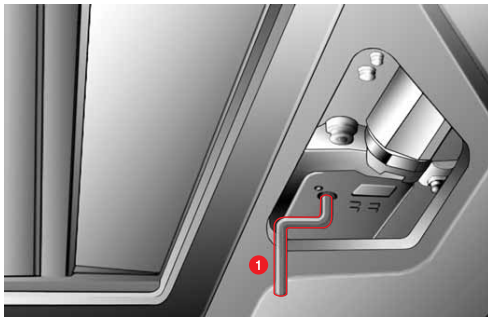

1. Manual operation hole and emergency crank

When the sunroof is not working properly, you can operate manually as following:

1. Remove the front room lamp assembly using the driver.
2. Insert the emergency crank special tool into the hole located at the left side of the sunroof motor.
3. Rotate it counter-clockwise to slide backward or tilt down.
4. Rotate it clockwise to slide forward or tilt up.

► To switch from Open to Close (from sliding backward to sliding forward) or from Tilt down to Tilt up

1. Rotate the emergency crank counter-clockwise to tilt down.
2. Keep on rotating it to tilt up after closing the sunroof.

► To switch from Close to Open (from sliding forward to sliding backward)

1. Rotate the emergency crank counter-clockwise to tilt down.

⚠ CAUTION

- The emergency crank is inside of the glove box (sunroof equipped vehicle only).
- Operate sunroof manually in emergency only. Remember to have the sunroof repaired at the nearest Ssangyong Dealer or Ssangyong Authorized Workshop.

ENGINE HOOD

1. Engine Hood Opening Lever

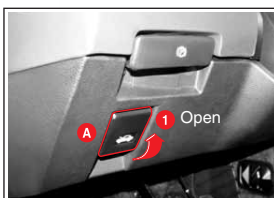

To unlock the hood, pull up the engine hood opening lever (A).

2. Hood Lock Release Lever

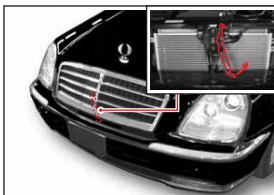

To raise the hood, pull the hood lock release lever located at the radiator grill and lift the hood up. The hood will be opened to a degree of up to 47°.

3. Hood

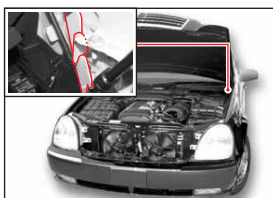

CAUTION

For safety reasons, make sure that the lower part of the hinge is securely fixed (V-shaped groove).

4. Hood Hinge Lever

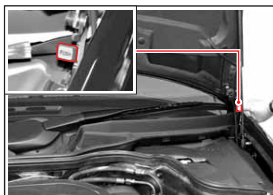

To raise or lower the hood up or down from 47° (90°) to 90° (47°), slightly lower the hood and raise or lower it while pressing the hood hinge lever.

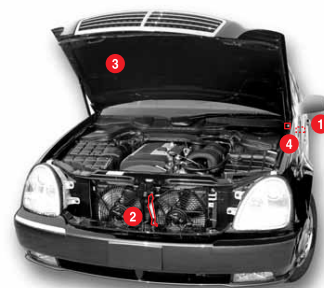

WARNING

- Make sure that your clothes or tools do not contact or tangle with any moving parts in the engine compartment when the hood is open.
- Before driving, always check that the hood is firmly closed and locked.
- When it is windy, extra caution is needed to prevent personal injury. Wind might be able to lift up the hood and the prop rod may be disengaged from its slot. This may result in an unexpected closing of the hood.

FUEL FILLER

1. Fuel Filler Lid Opening Switch

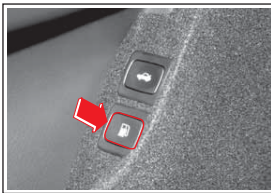

To open the fuel filler lid, push the opening switch at the driver's door trim.

2. Fuel Filler Cap

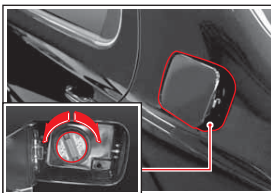

To open the fuel filler cap, turn it counterclockwise. After refueling, tighten the fuel filler cap by turning it clockwise until click is heard. Then close the fuel filler lid.

3. Fuel Filler Lid Emergency Release

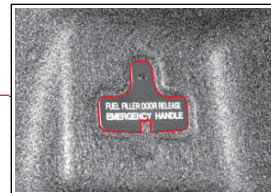

If the fuel filler lid opening switch does not function, pull the fuel filler lid emergency release lever located at the left-hand side wall in trunk to open it.

WARNING

If you use low grade fuel or put improper fuel additives into the fuel tank, the engine may be damaged. Use only unleaded gasoline.

CAUTION

- Always stop the engine when refueling.
- Fuel filler lid may not open during cold weather. Push or tap the lid lightly to open.
- If the engine produce severe engine knocking, have the system checked at the nearest Ssangyong Dealer or Ssangyong Authorized Workshop.



RECOMMENDED FUEL

Fuel with too low an octane number can cause pre-ignition (detonation), severe engine knocking, poor acceleration and poor fuel consumption. Ssangyong can not be held liable for resultant damage.

CAUTION

- There are various types of gasoline with different octane ratings. There are also some low-quality gasoline types whose octane number is not specified. Never use low-quality gasoline; doing so may cause drops in power, waste fuel, produce excessive exhaust gas and severe vibration.
- Do not add any additive into the fuel tank. Using non-prescribed fuel additives could severely damage the vehicle. Ssangyong can not be held liable for such damage.
- Using fuel with inappropriate grade or pouring improper fuel additives into the fuel tank may seriously damage the engine and catalytic converter. Use only the recommended unleaded gasoline.

Knocking

Knocking occurs when the fuel is incompletely burned due to premature or abnormal combustion in a spark-ignition internal combustion engine. If this happens, the pinging sound, abnormal vibration or a drop in power may occur.

Octane Number

The octane number is a rating of a gasoline that indicates its propensity to cause knocking, i.e. anti-knocking.

A fuel with a high octane number exhibits better resistance to knocking and has fine combustion. Engines that have been designed to have higher efficiencies and power outputs require gasoline with a high octane number.

CAUTION

For correct octane rating setting and other use of gasoline (ex. Leaded), consult your Ssangyong Dealer.

CAUTION

Engine and exhaust system will be damaged.

- Do not use leaded fuel to the vehicle for unleaded fuel.
- Use the fuel with specified or higher Research Octane Number recommended for your country by Ssangyong.

It is not covered by warranty.

WARNING

Gasoline vapor is highly flammable.
It burns violently and that can cause very bad injuries.
When refueling,

- Switch off engine.
- No smoking.
- No naked flame.
- No sparking material.

CAUTION

Gasoline damages paintwork.
If gasoline spills onto paintwork wash with cold water immediately.

TRUNK

STANDARD TRUNK

Trunk Lid Open Switch

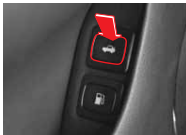

To open the trunk, put the trunk lock switch in the glove box to the unlock position and press this switch.



Trunk Lid Ajar Warning Lamp



This warning lamp comes on when the trunk is not securely closed.

To Open the Trunk Lid

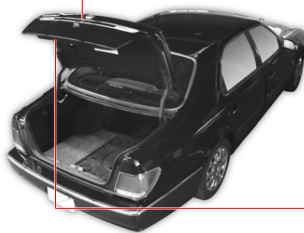

Insert the ignition key (master key) into the key hole and turn it clockwise.

NOTE

It is not possible to open the trunk lid with the secondary key.

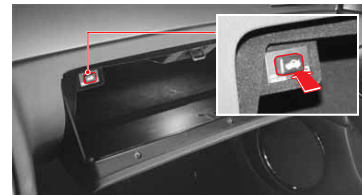

Trunk Lid Lock Switch (Glove Box)

Emergency Release Lever



If you are accidentally trapped in the vehicle's trunk, turn the emergency release lever to open the trunk.



If this switch in the glove box is in the **LOCK** position, the trunk lid cannot be opened with the trunk lid open switch. However, the trunk lid can be opened with the master key in any case.

POWER TRUNK*

For the vehicle with the power trunk, the trunk lid is opened/closed with the actuator. The trunk lid open switch, trunk lid close switch and trunk lid open button (remote control key) have been added to open/close the lid electrically.



Trunk Lid Open Button

To open the trunk lid, press and hold this button with the anti-theft mode deactivated.

However, the button operates only when the ignition key is removed from the ignition switch.

Trunk Lid Open Switch

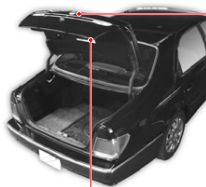

To open the trunk, press and hold this switch when the vehicle is stationary and not in the anti-theft mode.

Trunk Lid Close Switch



To close the trunk, press this switch.

CAUTION WHEN USING THE TRUNK

- The trunk cannot be opened under the following conditions:
 - When the vehicle is in anti-theft mode (the doors are locked with the ignition key or the door lock button on the remote control key)
 - When panic mode is activated
 - When the vehicle's speed exceeds 3 km/h
 - When the trunk lock switch in the glove box is in the lock position
- Before closing the trunk, ensure that your body is safely out of the way.
- Operating the power trunk several times in a short period of time causes the trunk to stop protecting the system. In this case, wait for 5 minutes and operate the trunk lid again. If the trunk lid still does not operate, visit a Ssangyong Dealer or Ssangyong Authorized Workshop for check.
- The trunk lid cannot be opened using the switch on the trunk lid when the vehicle is in anti-theft mode. However, if the anti-theft mode does not activate despite locking the doors with the door lock/unlock knob or door lock/unlock switch in the vehicle, the trunk lid can be opened with the trunk open switch on the lid. When resting in the vehicle, lock the trunk lid by pushing the trunk lock switch in the glove box.

INTERIOR SWITCHES

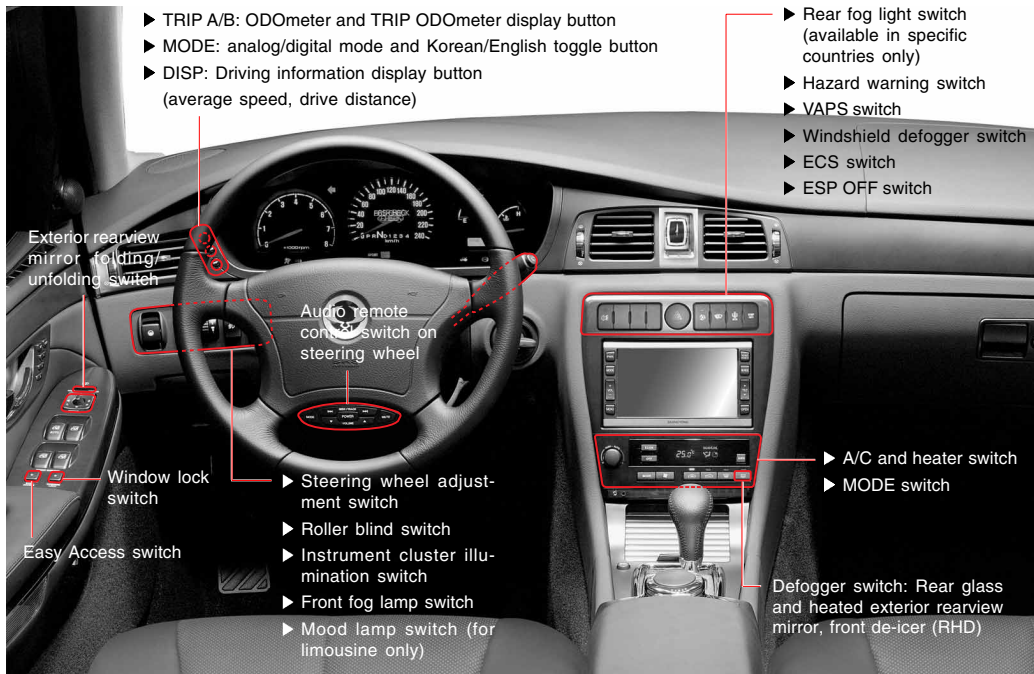

LIGHT SWITCH (WITH BATTERY SAVING SYSTEM)

LIGHT SWITCH RELATED DEVICES

Light Switch



Turn the barrel on the end of the lever as shown, then lights will be operated as follows:

Lamps	OFF			AUTO
	OFF	Tail lamp	Headlamp	AUTO
Headlamp	X	X	O	Auto
Position lamp	X	O	O	Lighting
Tail lamp	X	O	O	
License plate lamp	X	O	O	
Front fog lamp	X	O	O	
Front mood lamp and instrument panel	X	O	O	
Others	X	O	O	

The fog lamp in the above table is turned on or off when the front fog lamp switch is at "ON".

Fog Lamp Switch

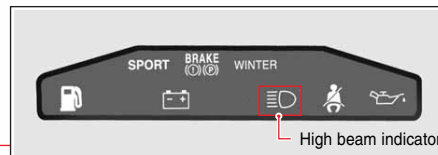

High beam indicator

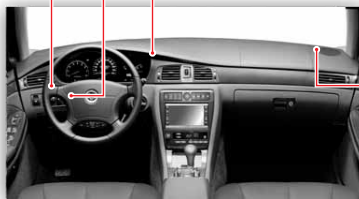

Auto Light Sensor

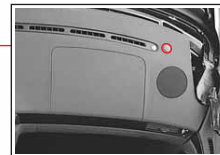

This senses the ambient illumination intensity to determine the timing for turning the headlamp and tail lamp on or off automatically when the light switch is set to "AUTO".



Front Lamp



Rear Lamp

CAUTION

- Do not leave the light on while engine is off.

AUTO LIGHT, HIGH BEAM, PASSING AND BATTERY SAVER

Auto Headlamp

Headlamp and tail lamp will automatically come on and off according to the ambient illumination intensity when the light switch is at AUTO (►: AUTO) position.

CAUTION

- Do not place any objects blocking the sensor. Do not clean the sensor with detergent or wax.
- In a foggy, snowing, raining, or cloudy day, use manual mode. The operating time of the lamps varies according to the climate, season, or circumstances.
- The tinted window may cause the improper operation of the auto light system.

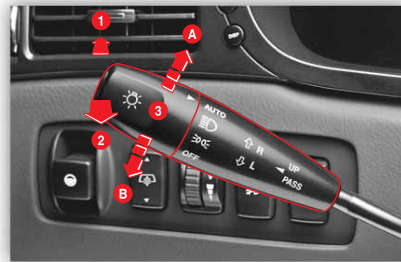

Battery Saver (Automatically Turning OFF the Tail Lamp)

To prevent the battery from discharging, the tail lamp will automatically go out when the driver gets off (or when the driver's door is open and close) with the tail lamp on.

With the tail lamps on, if you get off the vehicle (you open and close the driver's door) after the ignition key is removed, the tail lamps will automatically turn off.

You may turn the tail lamp on by positioning the ignition switch on or turning the light switch off and then turn on again.

1. High Beam

After turning on the headlamp, push the lever to turn on the headlamp high beam. Then, the indicator lamp on the instrument cluster will come on.

2. Passing

Pull the lever toward you temporarily to turn on the headlamp high beam and release the lever to turn it off regardless of its position.

3. Turn Signal Lamp

Push the lever up or down to signal a turning direction, then the turn signal lamps will blink. It shuts off automatically as you complete the turn.

- (A) Upward: right turn signal lamp
- (B) Downward: left turn signal lamp

WARNING

Driving with high beam headlamps disturbs the approaching vehicle's visibility. Use the high beam headlamp only during very dark situations when it is very hard to see the road.

WINDSHIELD WIPER AND WASHER SWITCH

RELATED DEVICES

1. Windshield Wiper and Washer Switch

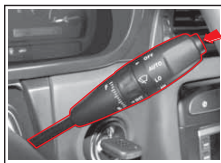

- 1. OFF:**
Stop the operation
- 2. AUTO:**
F (FAST) and S (SLOW)
- 3. LO:**
Low wiping speed
- 4. HI:**
Fast wiping speed
- 5. Washer Switch**
Push and hold: the washer spray with two or three cycles of sweep of the windshield
Push briefly: the washer spray with one cycle of sweep of the windshield

2. Low Washer Fluid Level Indicator

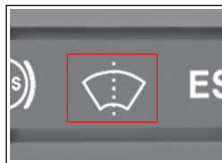

This indicator lights when the washer fluid is low.

3. Washer Fluid Filler

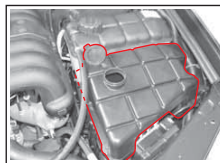

Add the washer fluid when needed.
Use the specified seasonal washer fluid.

4. Rain Sensor

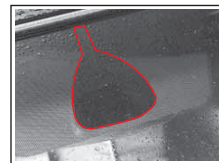

The rain sensor detects the amount of rain drops to control the wiper in AUTO mode.

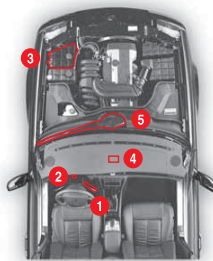

5. Wiper/Wiper Blade

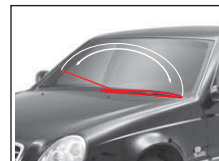

RAIN SENSING WIPER

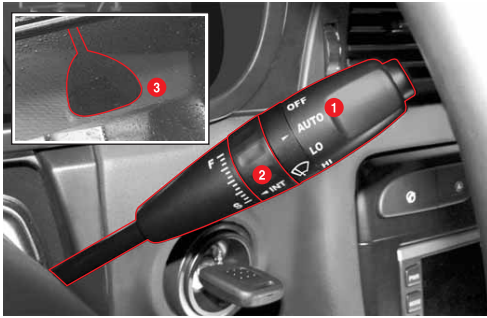

When the windshield wiper switch is at **AUTO** (1), the rain sensor (3) automatically turns on and off the wiper. And it controls the wiping speed by detecting the amount of rain drops.

AUTO Position

You can control the wiping speed manually by turning **INT** switch (2).

F (FAST): Fast wiping speed

S (SLOW): Slow wiping speed

AUTO Position Recognition Function

- When you start the engine with the wiper switch “**AUTO**” position, the wiper will operate once to remind you that the wiper switch is in “**AUTO**” position.
- When you move the wiper switch to “**AUTO**” from “**OFF**” position, the wiper will operate once.

CAUTION

- Auto position recognition, especially in winter, may reduce the life span of the wiper blade. Make sure the wiper switch is at “**OFF**” position unless it rains.
- During winter time, the wiper blade can be frozen to windshield. Wiper operation while blade is frozen can damage wiper motor. Be sure to check the blade before operation.
- The wiper operation on dry windshield can scratch glass and wear the blade prematurely. Do not operate wiper when the windshield is dry.
- When you clean the windshield over the sensor with damp cloth, the wiper may operate suddenly. It could cause serious injury. Make sure to place the wiper switch and ignition switch to “**OFF**” position when not in use.
- Make sure to place the wiper switch to “**OFF**” position before washing the vehicle.

OUTSIDE REARVIEW MIRROR AND INSIDE REARVIEW MIRROR

Outside Rearview Mirror Control

1. Select driver side mirror (L) or passenger side mirror (R) with the mirror selector switch (1).
2. Adjust the outside rearview mirror by pushing appropriate edge of the switch.

NOTE

Move the mirror selector switch to select left or right mirror to activate aiming down by 4° function during reversing (refer to "Transmission" section).

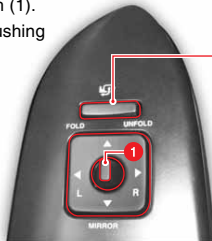

Outside Rearview Mirror Folding

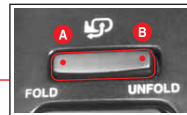

To fold the outside rearview mirrors, press "A" of the switch. To unfold, press "B" of the switch.

NOTE

You can fold or unfold the outside rearview mirrors by coupled operation of ignition key and remote control key.

CAUTION

- This function is not available when the vehicle speed exceeds 3 km/h.
- You can fold and unfold the mirrors for 30 seconds after ignition OFF.
- The anti-dazzle function of the rearview mirror will be hampered if the rear glass is coated.

WARNING

Tinted windows hamper the "anti-dazzle function"* of the exterior rearview mirror (*varies according to the option).

CAUTION

- You can fold and unfold the mirrors within 30 seconds after the ignition is turned OFF. However, this function is overridden when any of the front doors is opened with the ignition switch OFF.
- Do not manually fold or unfold the exterior rearview mirrors. It may cause a malfunction of the mirror folding system.

NOTE

You can fold or unfold the exterior rearview mirrors by coupled operation of the ignition key and remote control key (refer to "ignition key" and "remote control key").

Inside Rearview Mirror Control

1. Place the mirror selector switch to the center position.
2. Adjust the inside rearview mirror by pushing appropriate edge of the switch.

Mirror selector switch

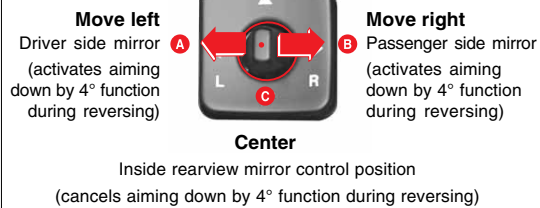

LEFT SWITCH PANEL

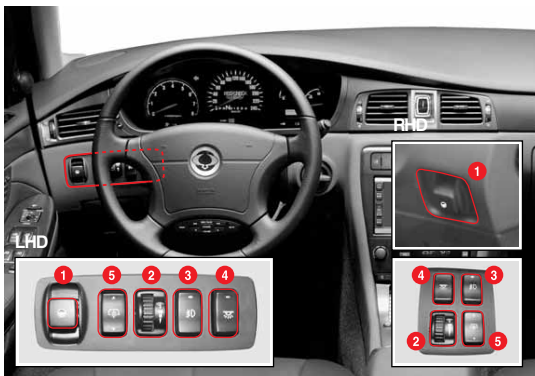

1. Steering Wheel Adjustment Switch



Move the switch until you get the desired position of the steering wheel.

- (1) Tilt-up
- (2) Tilt-down
- (3) Telescopic-up
- (4) Telescopic-down

CAUTION

- Do not adjust the steering wheel while vehicle is moving.
- Make sure the steering wheel is secured before driving off.

2. Instrument Panel Illumination Switch

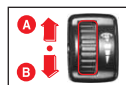

Turn the dial to adjust the brightness of the instrument panel.

- (A) direction: brighten
(B) direction: darken

CAUTION

When the tail lamps are on, the instrument cluster gets dim. Turning the instrument cluster illumination switch to the darkest setting makes the information on the instrument cluster hard to read. Especially, if the automatic light switch is set to "AUTO" and the vehicle is driven into a tunnel, the headlamps and tail lamps come on and the instrument cluster gets dim. Be careful.

3. Front Fog Lamp Switch



With light switch ON,

- Press (A): turns fog lamp on
Press (B): turns fog lamp off

4. Mood Lamp Switch (for Limousine only)



- Press (A): turns mood lamp on
Press (B): turns mood lamp off

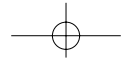

5. Roller Blind Switch*

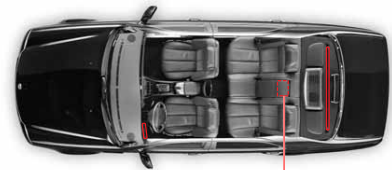
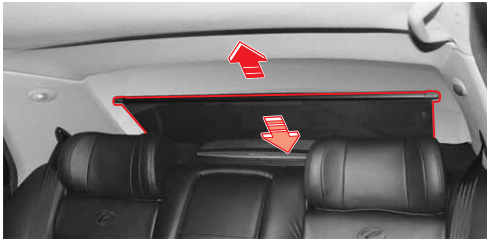

Roller blind switches are located in the left switch panel and on the rear center armrest switch panel.

Roller blind can be operated from the driver's seat or rear seat respectively.

If the switch is briefly pressed, the roller blind is fully raised/lowered.

Rear Seat Center Armrest Switch



CAUTION

An object on the panel behind the rear seat may obstruct the operation of the roller blind and damage the roller blind motor and relevant components.

CENTER SWITCH PANEL

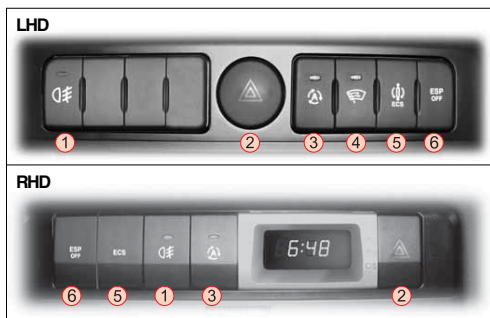

1. Rear Fog Light Switch (Available in Specific Countries Only)

If the switch is pressed when the tail lamps are on, the rear fog lights come on. To turn off, press again.

2. Hazard Warning Switch

Push this switch to turn on the hazard warning lamps. All turn signal lamps will flash simultaneously. Push this switch again to turn them off.

3. AQS (Air Quality System) Switch

Push this switch to automatically convert between recirculation mode and fresh air intake mode depending on the interior air conditions (For details, refer to "Air conditioner system" section).

4. Windshield Defogger Switch

If the switch is pressed, the windshield defogger is activated for 12 minutes. To turn it off, press again. It is used to deicing the windshield wiper. (The right-hand drive vehicle has the front deicer function in the defogger switch on the air conditioner's control panel.)

5. ECS Switch*

The vehicle equipped with the ECS (electronically controlled suspension) system minimizes the vertical vibration of the vehicle and provides comfortable ride. The ECS is always operated unless "SPORT" mode (Hard suspension) is not activated by pressing this switch. When you select "SPORT" mode for driving on rough road or curves, the "SPORT" indicator will be displayed on the instrument cluster. If you press this switch again, the indicator will go out and the ECS system will be re-activated.

6. ESP OFF Switch*

If the switch is pressed, ESP (Electronic Stability Program) is deactivated and ESP warning light on the instrument cluster comes on. If the switch is pressed again, ESP is activated and ESP warning light goes out.

AIR SOURCE SELECTION SYSTEM(WITH AQS)

New Chairman is equipped with automatic air conditioner system and AQS (Air Quality System). AQS automatically adjust from Fresh Air mode to recirculation mode when polluted air is detected through AQS sensor. It also has air purification function to clean the cabin air (See below for details).



Air conditioner control panel



Air Source Mode Switch

AQS automatically adjusts from the fresh air intake mode to the recirculation mode when polluted air is detected by the AQS sensor.

You may choose between Fresh Air mode and recirculation mode manually or press AQS switch to activate AQS.

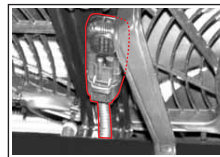

AQS & Ambient Sensor

The AQS sensor detects air polluting elements from outside air and measures the degree of pollution when AQS is in operation.

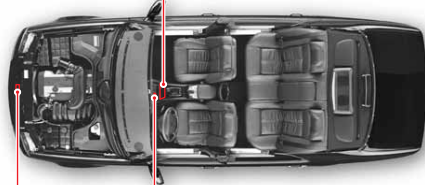

AQS switch
AQS & ambient sensor

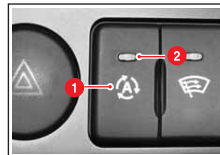

AQS Switch

The LED (2) on the switch comes on when AQS is in operation.

AQS Operation

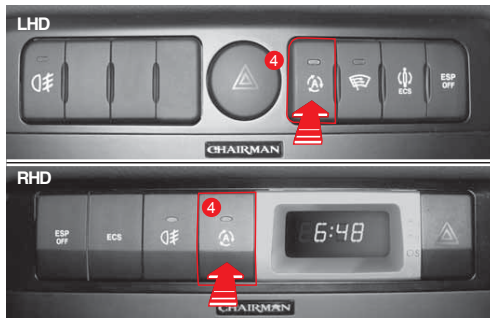

If the indicator light on the switch comes on when the AQS switch (4) is pressed, the AQS system is functioning properly.

Operation procedures

Press AQS switch → Indicator on the switch will lit the AQS sensor detects polluted air → changes into interior recirculation mode (🔄) → out of polluted area → changes into fresh air mode (🌬️)

CAUTION

- When the vehicle is started, the AQS will be preheated and diagnosed for 40 seconds. During this period, AQS will not operate.
- If AQS becomes defective, the system returns to the state (fresh air intake mode/interior air recirculation mode) just before the AQS switch operation.
- If you press the switch again while the recirculation mode is activated, it returns to automatic control.

WARNING

Using recirculation mode for a long period of time can cause stuffness, headache, drowsiness, and fogged window.
If exhaust gas comes in, there can be danger of Carbon monoxide toxication. Set to fresh air mode after passing through dusty or polluted area.

ECS Switch*



The electronic controlled ECS system minimizes the vertical vibration of the vehicle to enhance driving comforts and steering stability.

The ECS function works continuously until this switch is pushed and the "SPORT" indicator comes on at the instrument cluster. When the switch is pushed again, the ECS function resumes and the SPORT mode indicator lamp on the instrument cluster turns off.

ESP OFF Switch*



► Turning on of ESP warning lamp:

It comes on when the vehicle posture control function is stopped by pressing the ESP OFF switch or when the ESP related system is defective.

► ESP warning lamp flickering and buzzer

ESP (vehicle posture control) function is working under extremely unstable vehicle driving conditions.

ESP SYSTEM

The ESP system is an electronic vehicle stability control system and driving safety supplementary system that helps to avoid dangerous situations by applying brakes on the wheels or the engine torque to compensate vehicle stability when it is extremely unstable under conditions such as sharp cornering. This system also includes brake assist function for the handicapped persons because they depress the brake pedal softly even when hard braking is required. If the system recognizes that it is an emergency case requires hard braking, it delivers high braking pressure to the wheels. The ESP function works when vehicle stability is very unstable. The ESP system does not work under normal driving conditions. However, you can check the ESP operation with flickering ESP warning lamp on the instrument panel and warning alarm sounds.

ESP Warning Lamp and Warning Alarm During ESP Operations

When the ESP is operating, the ESP warning lamp on the instrument panel flickers and warning alarm sounds to warn the driver. When the ESP operation stops, the ESP warning lamp goes off. The ESP warning lamp flickers at least 4 times even when the ESP system activates for a very short period of time. This means the ESP system activates when the vehicle is unstable to correct the vehicle stability. When the Esp warning lamp and the warning alarm turn on, reduce the speed and pay extra attention to the road.

Stopping ESP Function With ESP OFF Switch

When the ESP switch is pushed once, the ESP function stops and the vehicle is driven independently from the sensor outputs. At this moment, the ESP warning lamp on the instrument panel comes on and the ESP (vehicle stability control) function will be cancelled. However, the ABS works normally.

Resuming ESP Function With ESP OFF Switch

If you push the ESP OFF switch again when the ESP function is released (when ESP warning lamp is turned on), the system will be resumed and the ESP warning lamp on the instrument panel goes out by resuming the ESP system.

CAUTION

- The ESP system turns off when the ignition is turned off. It will resume when the engine is started again.
- If the vehicle is controlled by ESP during driving, the ESP OFF switch will not work.
- If the ESP warning lamp comes on, the ESP related system is defective. At this moment, the ABS works in a basic way. However, make sure to check the vehicle at the nearest Ssangyong Dealer or Ssangyong Authorized Workshop.
- If the ESP warning lamp and the ABS warning lamp come on simultaneously, both ESP and ABS system are not working. Do not over speed your vehicle and be sure to check or repair the vehicle at the nearest Ssangyong Dealer or Ssangyong Authorized Workshop.
- If the ESP warning light flickers and the alarm sounds, it means that the vehicle stability is controlled by the ESP function when vehicle stability is extremely unstable. In this situation, drive the vehicle with maximum safety.
- If the ESP activates while vehicle is running, the ESP warning lamp on the instrument panel flickers and alarm sounds at 0.1 second intervals.

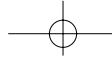

WARNINGS ON ESP SYSTEM

- The ESP operation means that the vehicle stability is extremely unstable.
- The ESP system is only a supplementary device for the vehicle. When the vehicle exceeds its physical limits, it cannot be controlled. Do not rely on the system. Keen on the safe driving.

DRIVING IMPRESSION WHEN ESP IS WORKING

When the ESP system activates, the driving impression can be different depending on vehicle driving conditions. For example, you will feel differently when the ESP system is activated during (1) when the ABS is operating with the brakes applied and (2) when the brakes are not applied on a curve.

If the ESP system operates when the brake is applied, the brake pressure will be increased on the corresponding wheel which already has braking pressure for the ESP controls. Thus, the ESP system would make the driver feel more abruptly when the brakes are applied during the ESP system activation.

NOISE AND VIBRATION THAT DRIVER SENSE WHEN ESP SYSTEM IS OPERATING

The ESP system may transfer noise and vibration to the driver due to the pressure changes caused by the motor and valve operations in a very short period of time. Extreme cornering will trigger the ESP operation and this will make the driver feel noise and vibration due to sudden brake application. Also, the ESP system controls the engine output. So, the driver may notice the engine output decrease even when the accelerator pedal is being applied.

REMOTE AUDIO CONTROL SWITCH



The remote audio control switch is located at the bottom of the steering wheel.

NOTE

For details, refer to the separately provided Audio and Multivision manual.

You can control the audio system using audio remote control switches on steering wheel. For more information, refer to the separately provided Audio and AV manual.

SEEK/TRACK

In radio mode

- Press briefly: Manual searching for a station
- Press and hold: Automatic searching for a station

In CD (DVD) player/Cassette tape mode

- Press briefly: Playing the next/previous track
- Press and hold: Moving forwards/backwards from the current track

MUTE

Stops audio output from the audio system. To resume the audio output, press the button again.

POWER

Turns on/off the audio system.

VOLUME

Increases/decrease the volume.

MODE

Changes into a different mode.

INSTRUMENT CLUSTER SWITCHES

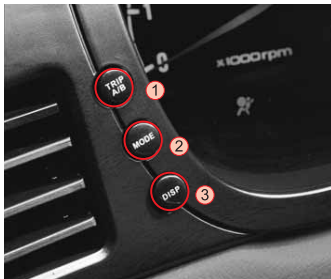

TRIP ODOMETER A/B (TRIP A/B) SWITCH

- **Toggling the Driving Distance Display Mode**

Each time the TRIP A/B switch is pressed lightly, the indicators are changed as follows: ODO - TRIP A - TRIP B - ODO.

- **TRIP A and TRIP B Resetting Procedure**

To reset the TRIP A/B display to 0 km, press and hold the TRIP A/B switch.

MODE SWITCH

- **Toggling between digital and analog modes**

Pressing this switch toggles the EL display between the digital and analog modes.

- **Toggling between the Korean and English mode**

Pressing this switch for over 5 seconds toggles the EL display between the English and the Korean mode.

DISP switch

- **Toggling between average speed, drive distance, tire inflation pressure and lane departure warning**

Pressing this switch briefly toggles the EL display.

- **Resetting the average speed and drive time**

To reset the average speed and drive time to 0 (zero), press and hold the DISP switch.

VEHICLE AIR PURIFIER SYSTEM (VAPS)*

VAPS automatically detects the various kinds of indoor dusts, smoke and exhaust gas, and filters them through its internal filter. Moreover, the system is equipped with an anion generator and an aromatic, which make the environment clean and pleasant.



VAPS switch



- ▶ **OFF:** Stops the operation
- ▶ **AUTO:** Automatic operation
- ▶ **LOW:** Low-speed operation
- ▶ **HIGH:** High-speed operation

Indications of the VAPS Switch

VAPS ON: The LED comes on.

Filter replacement warning: Blinks every 0.5 sec.

System malfunction warning: Comes on for 0.5 sec. and goes out for 2 sec repeatedly.

Air purifier



LED



CAUTION

If this warning lamp comes on for 0.5 seconds and goes out for 2 seconds repeatedly, have the VAPS system checked immediately at the nearest Ssangyong Dealer or Ssangyong Authorized Workshop.

NOTE

If the LED blinks every 0.5 seconds, replace the air purifier filter. For instructions on replacing the filter, refer to the "Air Purifier Filter Replacement."

AIR PURIFIER SWITCH



In AUTO mode, the system works regardless of air pollution

- When the interior humidity has dramatically changed.
- When the exhaust gas flows into the inside.

In AUTO mode, the system does not work

- When smoking within 2 minutes after selecting AUTO mode.
- When inside air quality is low.
- When the temperature around the sensor (around the grille) is low.

OFF

Stops the operation

AUTO

The sensor detects the condition of the internal air pollution and let the system automatically operate in LOW/MID/HIGH modes.

Turning on the ignition switch while the VAPS switch is in AUTO position makes the sensor operate in LOW for 2 minutes and then it is controlled to LOW/MID/HIGH automatically according to pollution level.

LOW

Air blowing and purifying performance is weakened.

HIGH

Air blowing and purifying performance is strengthened.

AIR PURIFIER FILTER REPLACEMENT

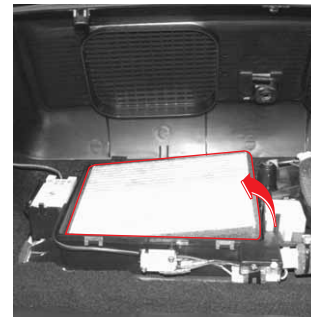
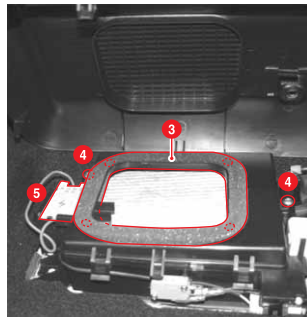
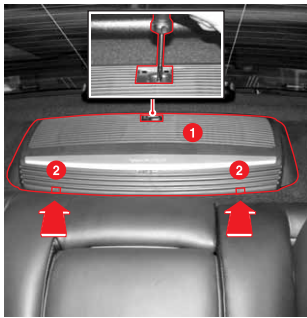

1. Remove the ignition key from the ignition switch.
2. Remove the air purifier cover (1) with a flat blade (-) driver.
3. Remove the cover fixing bolts with driver from OVM tools.
4. Separate the cover by pressing the air purifier fixing push buttons (2).

5. Unscrew the filter cover (3) fixing screws (4) and remove the filter cover (3). Then replace the used filter with a Ssangyong genuine filter.

6. Be careful of installing direction.

⚠ WARNING

- Remove the ignition key before replacing the air purifier filter.
- Never touch the negative ion generator (5) while removing the air purifier filter cover. (Danger! High voltage!)

⚠ CAUTION

- Once the air purifier filter has been contaminated, it cannot be reused.

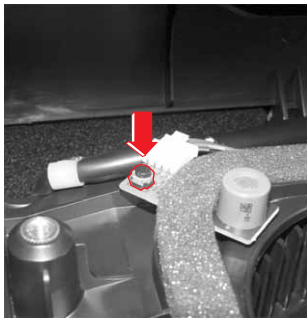
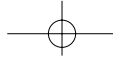

7. After replacing the filter, make sure to reset the timer to 0 by pressing the reset switch.

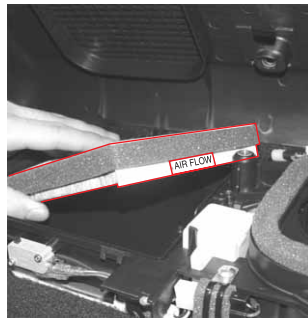

8. Installation is the reverse order of removal. However, be sure to face the labeled side down when installing.

Installation of Air Freshener

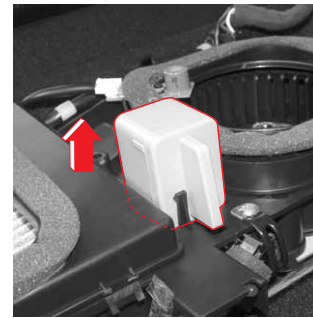

1. Stretch out the fixed holders on both sides and remove the aromatic case toward the arrow direction.
2. Separate the cover from removed air freshner case.
3. Insert new air freshner and install the air freshner case.

CAUTION

- Air freshner is not factory-equipped item. Select preferred aromatic in market.
- Installation direction is stamped on the aromatic case. Be careful of the direction while installing.

REAR FOG LAMP*



The rear fog light is activated when the tail lamp is on.
The rear fog lights are located in the back-up lamp positions.

HEADLAMP LEVELING SWITCH*

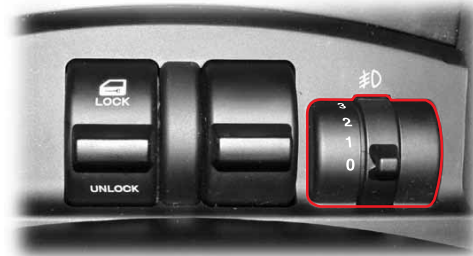

Headlamp Leveling Knob (available in specific countries only)

The higher the stage of the knob, the lower the level of headlamps.

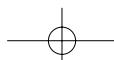

READING LAMP (WITH SUNROOF)



READING LAMP (WITHOUT SUNROOF)



Press the switch to turn on the lamp. To turn it off, press the switch again.

COOLING/HEATING SWITCH FOR CUP HOLDER

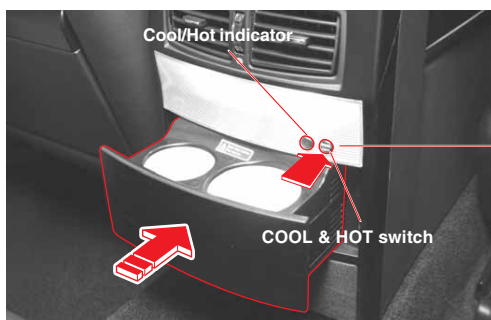

To use the cup holder, pull it out. Remember to push it back in after using.

The cooling/heating function operates only when the cup holder is out, and stops after the cup holder is pushed in. It also stops when the engine is turned off.

If there is a cup in the cup holder with the cooling/heating function in operation, the inner side of the holder gets cool or warm to keep the beverage fresh.

⚠ CAUTION

- Sudden brake or start may spill liquid in the vehicle.
- Be careful of burns! Do not store a hot beverage in the cup holder.
- Keep the cup holder pushed in when not in use.

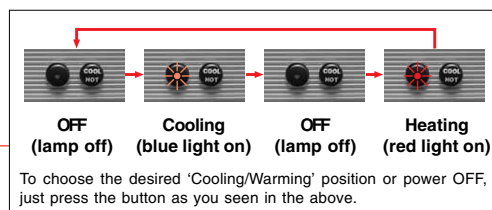

The indicator blinking in purple indicates a malfunction in the system.

Cooling function (blue LED on)

Activate the cooling function by pressing the COOL & HOT switch. The inner side of the cup holder gets cool in 10 - 15 minutes.

Heating function (red LED on)

Activate the heating function by pressing the COOL & HOT switch. The inner side of the cup holder gets warm in 10 - 15 minutes.

⚠ CAUTION

- The cup holder is not waterproof. If liquid is spilled on the cup holder, wipe it dry immediately.
- Do not touch the inner side of the cup holder when the heating function is in operation. You may get burned.
- A blinking indicator indicates system malfunction. Have the system checked at the nearest Ssangyong Dealer or Ssangyong Authorized Workshop.

REAR ARMREST SWITCH PANEL

AV SYSTEM CONTROL SWITCH PANEL

For detailed information for each switch, refer to the provided A/V operating instructions.

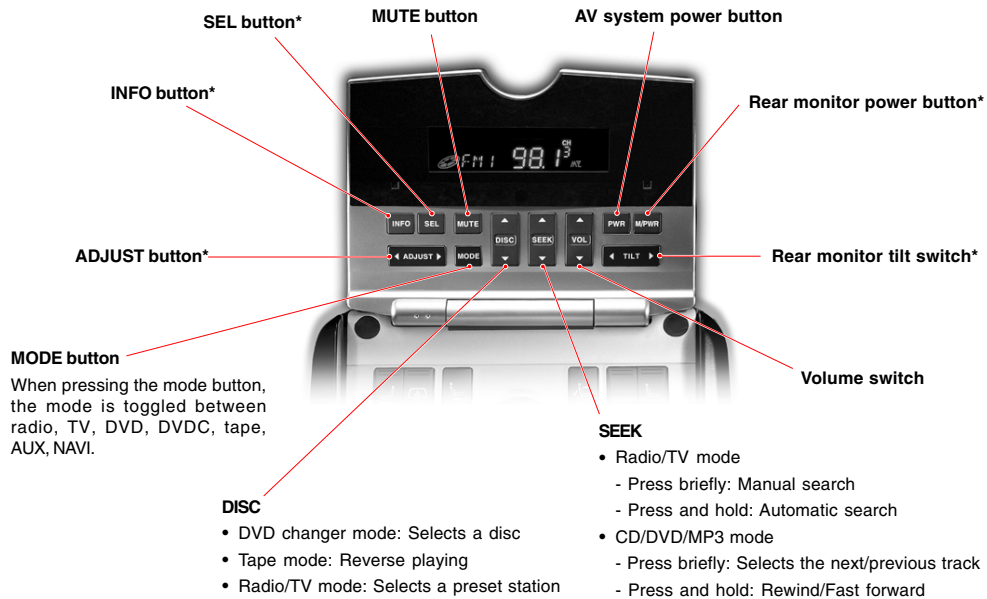

SEAT CONTROL SWITCHES

For more information, refer to Section 7.

Massage switch*: Rear right seat only

Moves massage roller backward
Press briefly: Stops massage function
Press and hold: Moves massage roller downward

Press briefly: Automatic operation
Press and hold: Moves massage roller upward
Moves massage roller forward

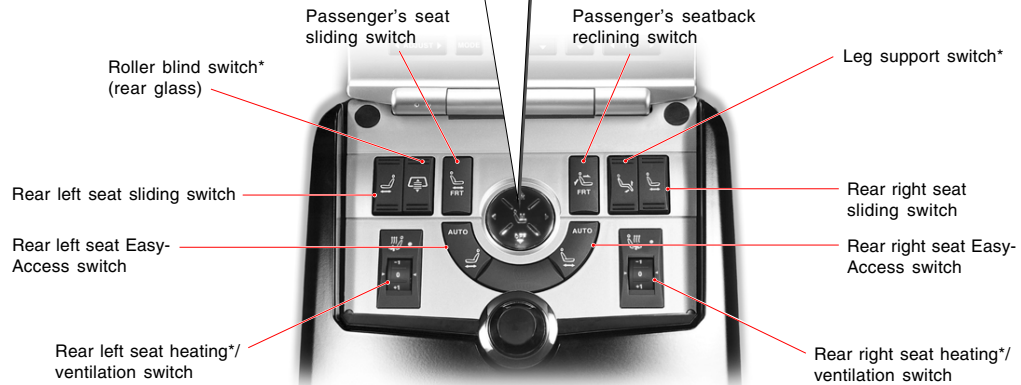

AUTO CRUISE CONTROL*

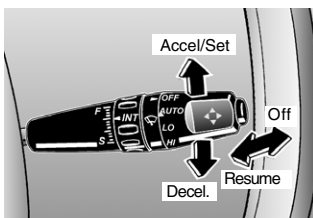

The cruise control system provides a constant cruising speed for your comfort when driving on a highway or on other road where frequent deceleration and acceleration are not required. Our cruise control system can maintain a constant vehicle speed from 40 KPH to maximum vehicle speed.

And this system is directly controlled only by MSE (Engine Management System) of EGAS-V (Electronic acceleration control system version 5) without other components.

Setting a Desired Speed

1. To operate the cruise control, accelerate to your desired speed using the acceleration pedal more over 40 KPH.
2. When the desired speed is reached, push up the ACC•SET switch of a cruise control lever or push down the DEC switch for 1 second per one switching and then release the acceleration pedal, slowly.
3. Now, the vehicle is cruised by this system with set speed.
4. And you can set to other vehicle speed again with above steps after acceleration pedal intervention during cruise control running.

Accelerating With Cruise Control System

- While cruise control system is running
 1. Push up the ACC•SET switch of a cruise control lever and hold it until the desired speed is reached without an acceleration pedal intervention.
 2. When the desired speed is reached, release the lever.
- While cruise control system is not running
 1. Accelerate using the acceleration pedal more over 40 KPH.
 2. Push up the ACC•SET switch of a cruise control lever and hold it.
 3. And then release the acceleration pedal, slowly.
 4. When the desired speed is reached, release the lever. (Tap up while cruise control system is running)
- Tap up while cruise control system is running
 1. Push up the ACC•SET switch of a cruise control lever less than 0.5 second per one switching while the cruise control system is running. This is a tap up switching.
 2. When you operate a tap-up switching, the vehicle is accelerated for 1 KPH over the previous set speed.
 3. If you want to accelerate for 10 KPH, operate the tap-up switching ten times without accelerating with cruise control system.

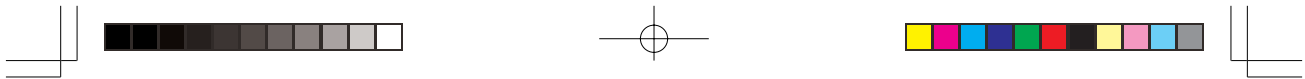

- Decelerating with cruise control system (While Cruise control system is running)

1. Push down the DEC Switch of a cruise control lever and hold it until the desired speed is reached without a brake pedal intervention. But the cruise control system cannot maintain the cruise function at less than 40 KPH.
2. When the desired speed is reached, release the lever.

- When Cruise control system is not running

1. Push up the DEC switch of a cruise control lever and hold it.
2. And then release the acceleration pedal, slowly.
3. When the desired speed is reached, release the lever. But the cruise control system cannot maintain the cruise function at less than 40 KPH.

- Tap down while cruise control system is running

1. Push down the DEC switch of a cruise control lever less than 0.5 second per one switching while the cruise control system is running. This is a tap down switching.
2. When you operate a tap-down switching, the vehicle is decelerated for 1 KPH below the previous set speed.
3. If you want to decelerate for 10 KPH, operate the tap-down switching ten times without brake pedal intervention.

Recovery of Set Speed

Even if the cruise control is canceled, the previous set cruise speed can be recovered by pushing toward the resume switch of a cruise control lever when the current vehicle speed is higher than 40 KPH without acceleration intervention. But if you turn off the ignition switch, the memorized set speed is cleared and you cannot recover the previous set speed.

Normal Cancellation of Cruise Control

The cruise control system will be canceled when one or more items of the following conditions is applied;

1. When the brake pedal is depressed.
2. When the automatic transmission is shifted to the 'N', 'P' or 'R' position.
3. When the cruising speed is downed less than 40 KPH.
4. When the off switch is operated by pulling rearward the cruise control lever.
5. When ABD or ESP is activated or wheel slip occurs.

And the cruise control system can be operated again in driving state.

Abnormal Cancellation of Cruise Control

1. When the rapid deceleration is applied without braking.
2. When the rapid acceleration is applied without acceleration pedal intervention.
3. When the cruise control lever is failed.
4. When the brake switch and brake light switch input signal is plausible.

And the cruise control system cannot be operated again in driving state. In this case, you should stop the vehicle, and turn off the ignition switch and then turn it on again. After you do that, you can use the cruise control system again. But if the cruise control system isn't recovered, you should contact Ssangyong Distributor for diagnosis of the cruise control system.

CAUTION

- Keep the main cruise control switch as neutral position when not using the cruise control.
- For safety, do not use the cruise control system when driving in heavy traffic, winding roads, in snow or on slushy surfaces.
- Pay particular attention to the driving conditions whenever using the cruise control system.

CAUTION

Risk of accident!

Do not use the cruise control function when the road is slippery.

CAUTION

The speed can be increased briefly (for example for overtaking) by using the accelerator. When the accelerator is released the previously set speed is resumed.

The speed cannot always be maintained on steep inclines. When the incline levels out, the set speed is resumed.

Only use cruise control if traffic conditions make it possible to travel at a steady speed.

The resume position should only be used if the driver is fully aware of this speed and wishes to resume this particular speed.

TABLE OF CONTENTS

Instrument Cluster	5-2	Headlamp High/Low Beam Indicator	5-12
Trip Odometer/Odometer Switch and		Seat Belt Warning Lamp	5-13
Instrument Panel Mode Switch	5-4	Engine Oil Pressure Warning Lamp	5-13
Trip Odometer A/B (Trip A/B) Switch	5-4	Door Ajar Warning Lamp	5-13
Mode Switch*	5-5	Trunk Lid Ajar Warning Lamp	5-14
Disp Switch*	5-6	Winter Mode Indicator	5-14
Warnings in EI Display Window*	5-7	Low Washer Fluid Level Warning Lamp	5-14
Warning Display	5-7	Turn Signal/Hazard Warning Indicator	5-15
Text Type Display (EI Display Window)	5-8	ECS Warning Lamp and Sport Mode Indicator .	5-15
Meters and Gauges	5-9	Brake System and Warning Lamps	5-16
Tachometer	5-9		
Speedometer	5-9		
Fuel Gauge/Coolant Temperature Gauge	5-9		
Shift Lever Position Indicator	5-10		
Deluxe Version (EI Display Window)	5-10		
Standard Version	5-10		
Warning Lamps and Indicators	5-11		
Air Bag Warning Lamp	5-11		
Low Coolant Level Warning Lamp	5-11		
Low Fuel Level Warning Lamp	5-11		
Engine Check Warning Lamp	5-12		
Charge Warning Lamp	5-12		

Section 5 Instrument Cluster

INSTRUMENT CLUSTER

DELUXE VERSION (BLACK FACE GLASS + EL DISPLAY WINDOW)

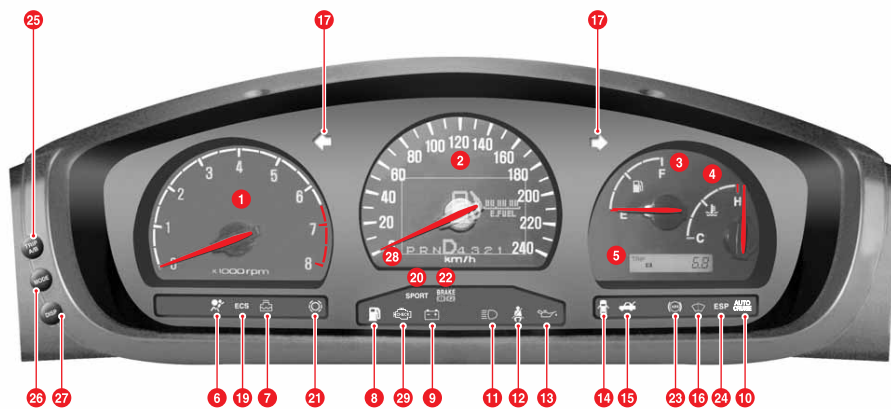

- | | | |
|-----------------------------------|-----------------------------------------|------------------------------------|
| 1. Tachometer | 11. Headlamp high-beam indicator | 21. Brake pad wear warning lamp |
| 2. Speedometer | 12. Seat belt warning lamp | 22. Brake warning lamp |
| 3. Fuel guage | 13. Engine oil pressure warning lamp | 23. ABS warning lamp |
| 4. Coolant temperature guage | 14. Door ajar warning lamp | 24. ESP warning lamp |
| 5. Trip odometer/Odometer | 15. Trunk lid ajar warning lamp | 25. TRIP A/B switch |
| 6. Air bag warning lamp | 16. Low washer fluid level warning lamp | 26. MODE switch |
| 7. Low coolant level warning lamp | 17. Turn signal indicators | 27. DISP switch |
| 8. Low fuel level warning lamp | 18. WINTER mode indicator | 28. Shift lever position indicator |
| 9. Charge warning lamp | 19. ECS warning lamp | 29. Engine CHECK warning lamp |
| 10. Auto cruise indicator | 20. SPORT mode indicator | |

5-2 INSTRUMENT CLUSTER

NEW CHAIRMAN

STANDARD VERSION (BLACK FACE GLASS)

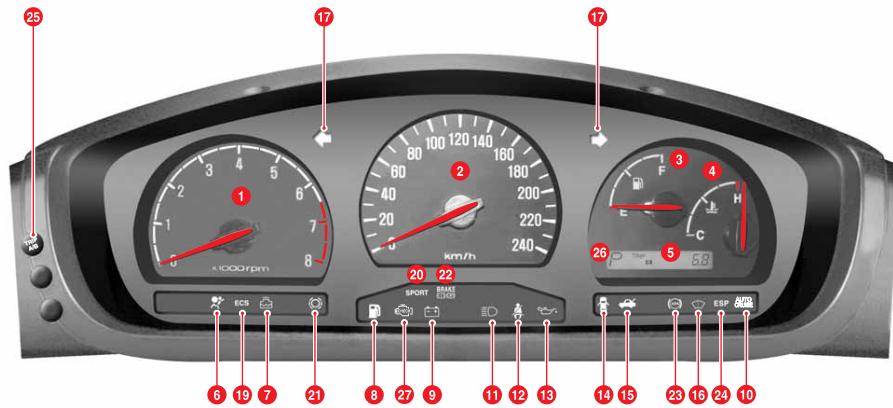

- | | | |
|-----------------------------------|-----------------------------------------|------------------------------------|
| 1. Tachometer | 10. Auto cruise indicator | 19. ECS warning lamp |
| 2. Speedometer | 11. Headlamp high-beam indicator | 20. SPORT mode indicator |
| 3. Fuel gauge | 12. Seat belt warning lamp | 21. Brake pad wear warning lamp |
| 4. Coolant temperature gauge | 13. Engine oil pressure warning lamp | 22. Brake warning lamp |
| 5. Trip odometer/Odometer | 14. Door ajar warning lamp | 23. ABS warning lamp |
| 6. Air bag warning lamp | 15. Trunk lid ajar warning lamp | 24. ESP warning lamp |
| 7. Low coolant level warning lamp | 16. Low washer fluid level warning lamp | 25. TRIP A/B switch |
| 8. Low fuel level warning lamp | 17. Turn signal indicators | 26. Shift lever position indicator |
| 9. Charge warning lamp | 18. WINTER mode indicator | 27. Engine CHECK warning lamp |

NEW CHAIRMAN

INSTRUMENT CLUSTER

5-3

TRIP ODOMETER/ODOMETER SWITCH AND INSTRUMENT PANEL MODE SWITCH

TRIP ODOMETER A/B (TRIP A/B) SWITCH



TRIP A/B switch is used for the display mode: TRIP A, TRIP B, and ODO (total driving distance)

1. TRIP A and TRIP B Resetting Procedure

TRIP A/B display will be initialized to 0 km when the distance of individual trip exceeds 999.9 km. To reset it to 0 km before it reaches to 999.9 km, press the TRIP A/B switch for more than one second.

NOTE

Shift lever position display:

- Deluxe version - EL display window
- Standard version - Trip display window

2. Toggling The Driving Distance Display Mode

To choose the desired driving distance display mode, press the TRIP A/B switch:

Toggle sequence: ODO - TRIP A - TRIP B - ODO

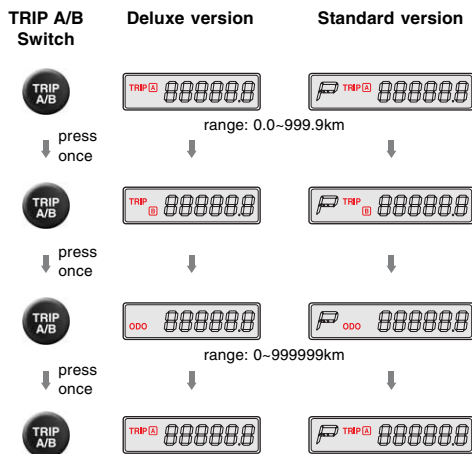

MODE SWITCH*



To choose the desired instrument panel display mode, press the MODE switch.

MODE Toggling

1. Toggling between Digital mode and Analog mode
2. Toggling between Korean mode and English mode

Toggling between Digital mode and Analog mode

MODE press briefly

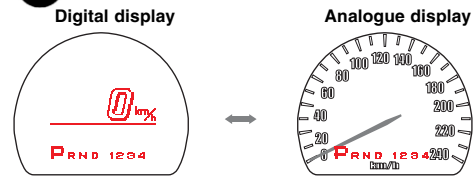

Toggling between Korean mode and English mode

MODE press and hold for 5 seconds

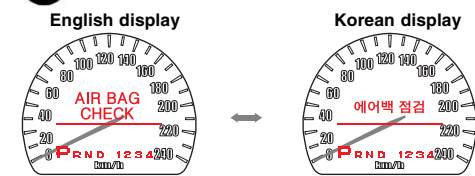

NOTE

Refer to the DISP switch display mode.

DISP SWITCH*

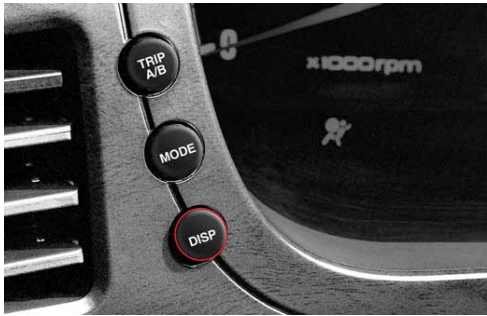

DISP Switch (Distance Information System)

By using the DISP switch, the instrument cluster with EL display window shows the average speed and drive time as well as generally displayed information in analog or digital mode.

The average speed and drive time includes the speed and elapsed time when the vehicle is stopped with the engine still running. It is not the actual average speed of the vehicle.

1. DISP Resetting Procedure

To reset the average speed and individual drive time to 0 (zero), press the DISP switch for 3 seconds in DISP mode.

DISP mode toggling sequence:

Basic - Average speed - Drive time - Basic

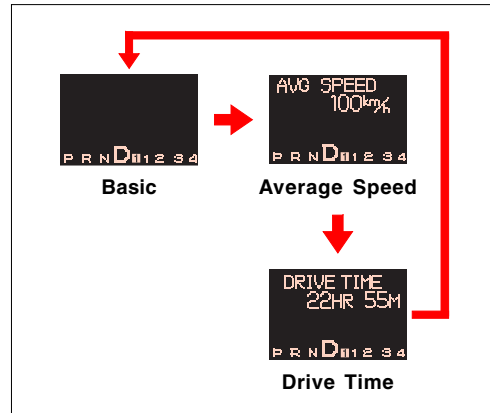

WARNINGS IN EL DISPLAY WINDOW*

WARNING DISPLAY

EL display window uses warnings with animation to enhance driver's recognition.

Door Ajar Warning



When a door is opened, the opened door will be displayed with animation.

Trunk Lid Ajar Warning



When the trunk lid is opened, the animation with the trunk lid open will be displayed.

Parking Aid Sensor Warning

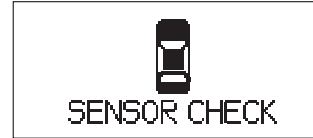

Korean mode: 센서 점검
This warning lamp comes on to indicate malfunctioning parking aid sensors.

Low Fuel Level Warning



ing fuel is displayed with bars.

After the fuel warning lamp turns on, 4 bars will disappear when approximately 1.5 liters are consumed. Then when remaining fuel level goes below 5 liters, the bars will flicker.

CAUTION

This warning lamp may come on while the vehicle is on a steep hill and the remaining fuel is more or less than 9.5 litres.

When the fuel level goes less than about 9.5 liters, the EL display shows warning indication as shown in the figure. The remain-

Parking Aid System Warning

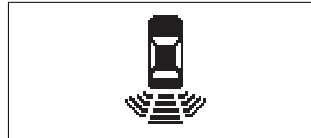

When the shift lever is positioned at **R** while the ignition switch is ON or while the engine is running, the reverse lamp comes on and the parking aid system operates. The distance from the obstacle can be measured with warning beeps. When distance from the obstacle becomes nearer, the number of bars reduces and the warning beep comes on more frequently.

NEW CHAIRMAN

INSTRUMENT CLUSTER

5-7

TEXT TYPE DISPLAY (EL DISPLAY WINDOW)

The vehicle logo comes on when ignition key is turned on and the seatbelt indicator comes on. If a system is defective, the following warning light comes at the EL display.

Warning Displays

1. Engine oil level check

Korean mode	엔진 오일 점검
English mode	OIL LEVEL CHECK

2. Brake pad wear check

Korean mode	브레이크 패드 점검
English mode	BRAKE PAD WEAR

3. Parking brake check

Korean mode	브레이크 점검
English mode	BRAKE CHECK (P) (P)

4. Air bag check

Korean mode	에어백 점검
English mode	AIR BAG CHECK

5. ABS check

Korean mode	ABS 점검
English mode	ABS CHECK

6. ECS check

Korean mode	ECS 점검
English mode	ECS CHECK

7. Coolant level check

Korean mode	냉각수 보충
English mode	LOW WATER LEVEL

8. Washer fluid level check

Korean mode	워셔액 보충
English mode	LOW WASHER FLUID

WARNING

If a check indicator comes on or other warning light comes on or flickers on the EL display on instrument cluster, have the corresponding system checked immediately at the nearest Ssangyong Dealer or Ssangyong Authorized Workshop.

METERS AND GAUGES

TACHOMETER



This gauge indicates the engine speed in revolutions per minute. The pointer number multiplied by 1000 is the current engine rpm.

⚠ WARNING

Excessive speed can damage the engine. Be careful not to let the pointer go beyond the red zone (6,500-8,000 rpm).

SPEEDOMETER



This gauge indicates the vehicle speed in km per hour. The center display window shows additional information.

⚠ WARNING

Before driving, make sure that all the warning lamps are turned off. If any of warning lamps comes on, have the corresponding system checked immediately at the nearest Ssangyong Dealer or Ssangyong Authorized Workshop.



The central display window shows the vehicle speed in digital mode.

FUEL GAUGE/COOLANT TEMPERATURE GAUGE

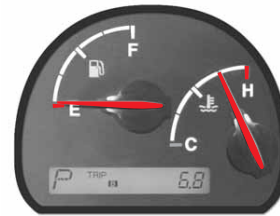

Fuel Gauge

This gauge indicates the level of fuel remaining in the fuel tank. Refuel before the pointer reaches "E".

Coolant Temperature Gauge

This gauge indicates the engine coolant temperature.

⚠ CAUTION

If the pointer indicates over the normal range (beyond "H"), stop the vehicle immediately. If the engine is overheated, continued operation of the vehicle may seriously damage the engine.

SHIFT LEVER POSITION INDICATOR

DELUXE VERSION (EL DISPLAY WINDOW)

STANDARD VERSION



Analog mode
P R N D 1 2 3 4

Digital mode
D 1

P R N D 4 3 2 1

D5 D4 D3 D2 D1

This indicator shows the current shift lever position (**P, R, N, D, 1, 2, 3, 4, D₁, D₂, D₃, D₄** and **D₅**).

When the shift lever is in the **D** position, this indicator shows **D₁, D₂, D₃, D₄** or **D₅** depending on the driving condition.

The number on the indicator (**1, 2, 3** and **4**) changes as the shift lever is moved to the right or left.

WARNING LAMPS AND INDICATORS

AIR BAG WARNING LAMP



This warning lamp comes on when the ignition is switched on, and turns off if there is no system error.

If this lamp does not go out after engine starting or comes on while driving, it means that there is a malfunction in the system. Have the air bag system checked immediately at the nearest Ssangyong Dealer or Ssangyong Authorized Workshop.

NOTE

For more information, refer to the "Seat Belt and Air Bag" section.

LOW COOLANT LEVEL WARNING LAMP



This warning lamp comes on when the engine coolant level is low.

If this warning lamp comes on during normal driving, stop the vehicle immediately. Check the engine coolant level and add the coolant if needed.

CAUTION

If the engine coolant level is too low, the engine can be seriously damaged due to overheating.

LOW FUEL LEVEL WARNING LAMP



This warning lamp comes on when the fuel level goes below 9.5 liters.

The time it takes to turn on, however, varies according to the vehicle conditions or gradient of the road.

Refuel preferably before the warning lamp comes on.



ENGINE CHECK WARNING LAMP



If the light stays on or comes on while driving, it indicates that some of the engine control components including sensors and devices are defective. When this happens, have the system checked at the nearest Ssangyong Dealer or Ssangyong Authorized Workshop.

WARNING

When the warning light comes on, the vehicle shifts into the safety mode to maintain minimum driving conditions and to prevent damage to the system. In this mode, the engine driving force may be decreased or it may stall. When this happens, have the system checked at the nearest Ssangyong Dealer or Ssangyong Authorized Workshop.

CHARGE WARNING LAMP



This warning lamp comes on when the ignition switch is turned on, and turn off when the engine is started.

If this lamp doesn't turn off after engine starting or comes on while driving, it means there is a malfunction in the system. Have the charging system checked at the nearest Ssangyong Dealer or Ssangyong Authorized Workshop.

HEADLAMP HIGH BEAM INDICATOR



High beam indicator

This indicator comes on when the high beam headlamp is on.

WARNING

Driving with high beam headlamp disturbs the approaching vehicle's visibility. Use the high beam headlamp only during very dark situations when it is very hard to see the road.

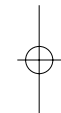
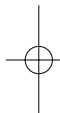



SEAT BELT WARNING LAMP

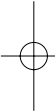

This warning lamp and buzzer remind you to fasten your seat belt. The warning lamp comes on whenever the ignition is switched on. The lamp goes off whenever the driver's seat belt is securely fastened. At the same time, the buzzer will sound for about six seconds until the driver's seat belt is securely fastened.

ENGINE OIL PRESSURE WARNING LAMP



This warning lamp comes on when the ignition switch is turned on, and turn off when the engine is started.

If this lamp does not turn off after engine starting or comes on while driving, it means there is malfunction in the system. Have the lubricating system checked at the nearest Ssangyong Dealer or Ssangyong Authorized Workshop.

 **WARNING**

Running the engine with the oil pressure warning lamp on can cause serious damage to the engine.

DOOR AJAR WARNING LAMP



This warning lamp comes on when any of the doors is not securely closed.

 **WARNING**

Driving with any doors open can cause injury for the passengers and people outside the vehicle. Close all doors before driving off. Check if this warning lamp is turned off.



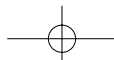

TRUNK LID AJAR WARNING LAMP



This warning lamp comes on when the trunk lid is not securely closed.

WARNING

- Ensure that the trunk is firmly locked; driving with the trunk open may pose danger to other motorists with falling objects from the trunk.
- Driving with the trunk lid open may also impair the driver's rear view.

WINTER MODE INDICATOR



This indicator comes on when the WINTER mode (W) is selected.

(For more information, refer to "Transmission" section.)

CAUTION

Under WINTER mode, the vehicle starts at 2nd gear, so the vehicle may lack power.

LOW WASHER FLUID LEVEL WARNING LAMP



This warning lamp comes on when the washer fluid level is too low.

Add the washer fluid when this warning lamp comes on.

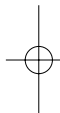

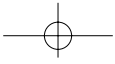

TURN SIGNAL/HAZARD WARNING INDICATOR

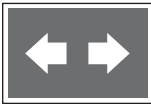

Turn Signal Indicator

This indicator flashes when the turn signal switch is turned on.

Hazard Warning Indicator

Both turn signal indicator lamps flash when the hazard warning switch is turned on.

ECS WARNING LAMP AND SPORT MODE INDICATOR

The ECS system to the New Chairman is a sophisticated supplementary system that continuously controls the suspension system depending on the road conditions for comfort driving.



ECS Warning Lamp

This warning lamp comes on when the ignition switch is turned on and turn off when the engine is started.

If this lamp does not turn off after engine starting or comes on while driving, it means there is malfunction in the system. Have the ECS system checked at the nearest Ssangyong Dealer or Ssangyong Authorized Workshop.



SPORT Mode Indicator

This indicator comes on when the ECS switch is pushed. In this mode, the ECS control stops and the damping force of suspension system changes to HARD mode.



BRAKE SYSTEM AND WARNING LAMPS

Brake Pad Wear Warning Lamp



This warning lamp comes on when the brake pad is worn. If this warning lamp comes on, replace the brake pads with new ones.

ESP Indicator



When the ESP function is cancelled by pressing the ESP OFF switch, the indicator lamp comes on. If ESP function operates, the indicator lamp flickers.

ABS Warning Lamp



This warning lamp comes on when the ignition switch is turned on and turn off when the engine is started. If this lamp does not turn off after engine starting or comes on while driving, it means there is malfunction in the system. Have the ABS system checked at the nearest Ssangyong Dealer or Ssangyong Authorized Workshop.

Parking Brake Warning Lamp



This warning lamp comes on when the parking brake is applied and/or the brake fluid is lower than specified level.

Cruise Control Indicator*



This indicator comes on when the cruise control is switched on.

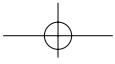

⚠ WARNINGS ON ABS

- ABS is a device that prevents wheels from locking during braking to allow steering. However, the ABS system does not shorten the stopping distance.
- ABS is a supplementary device for safety. Keep enough distance for safety.
- If the warning lamp does not turn off after engine starting or comes on while driving, some of the ABS related components may be defective. When this occurs, the ABS system will not work. But conventional brake system will work normally. Visit Ssangyong Dealer or Ssangyong Authorized Workshop immediately for service.

⚠ CAUTION
 The vehicle equipped with ABS or ESP performs self-diagnosis on the system when the engine is started and drives off. During the diagnosis, brake pedal vibration and noise may be apparent when the driving motors discharge the hydraulic pressure from the internal hydraulic device. This means the ABS or ESP is properly functioning.

Parking Brake Operation

Park at a safe place and depress the parking brake pedal firmly. When the pedal is depressed, the parking brake indicator on the instrument panel comes on.

Parking Brake Release

To release the parking brake, pull up the lever.

⚠ CAUTION
 Before driving off, be sure to check that the parking brake warning lamp is turned off.

Warning Sound When Driving While the Parking Brake is Engaged

If you drive the vehicle without releasing the parking brake, the parking brake warning lamp flickers and buzzer sounds to warn the driver when the vehicle speed exceeds 3 to 5 km/h. When this happens, stop the vehicle immediately and release the parking brake.



SHIFT LEVER IN AUTOMATIC TRANSMISSION

Mode Selection Switch

- **W:** Winter mode
- **S:** Standard mode

Use the standard mode in normal driving conditions.

Shift Lever Lock Release Hole

If you cannot shift out of "P", depress the brake pedal and push down this hole with a stick such as a pen.

Adjusting the Shiftable Gear

The shiftable gear can be adjusted by moving the shift lever to left (-) or right (+).

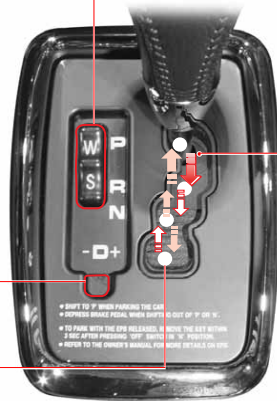

Always apply the brake when shifting from the "P" position with the ignition on.

The shift lever moves only when the brake pedal is depressed.

The shift lever moves without depressing the brake pedal. However, for safety reasons, the brake pedal should also be depressed.

The shift lever moves without depressing the brake pedal.

WARNING

- Never depress the accelerator pedal when moving the shift lever.
- If you have to stop on a hill, securely depress the brake pedal.

DRIVING VEHICLE WITH A/T

STARTING THE ENGINE AND DRIVING THE VEHICLE

1. Move the shift lever to the “P” position and start the engine while stepping on the brake pedal. The engine can be started with the shift lever in the “N” position. However, to ensure safety, start the engine with the shift lever in the “P” position.
2. Check if the engine speed is in the normal range (less than 1,000 rpm). Keep the brake pedal depressed and shift into the “D” or “R” position.
3. Release the parking brake. Keep the brake pedal depressed and shift into the “D” position. Wait for a few seconds before driving off.
4. Slowly release the brake pedal. Before depressing the accelerator pedal, make sure that the vehicle is moving slowly (creep effect).

WARNING

- To ensure safety, depress the brake pedal when moving the shift lever.
- Never depress the accelerator pedal when moving the shift lever.
- If you have to stop on a hill, depress the brake pedal securely.
- Starting the engine with the accelerator depressed may abruptly move your vehicle and cause an accident.
- When the parking brake is released while the engine is running at a high rpm, your vehicle may abruptly move. Therefore, wait until the engine speed becomes stable.
- To avoid any mechanical damage or accidents, never shift into “P” or “N” while the vehicle is in motion.
- When driving at a high speed, any sudden attempt to shift from a higher to a lower gear can severely damage the vehicle. In addition, your vehicle may lose its stability and place you at a high risk for an accident.

CAUTION

- Do not abruptly drive off or sharply accelerate the vehicle after shifting into “D”; doing so may damage the transmission. Especially, when you start off on a hill after stopping and parking the vehicle, wait for a while until the “D” shift indicator comes on for several seconds with the brake pedal depressed.
- When driving down a gentle slope, never shift the shift lever to “N”; doing so may damage the driving train.
- Although you can start the engine with the shift lever in both “P” or “N”, to ensure your safety, always start the engine with the shift lever in “P”.
- Never shift into “R” when the vehicle is moving.

CHARACTERISTICS OF A/T VEHICLE

Creep Phenomenon

Without stepping on the accelerator pedal, your vehicle can move slowly if the shift lever is in any position other than "P" or "N". This is called the creep effect. You can control your vehicle's movement by only applying the brake in heavy traffic or narrow areas.

CAUTION

- On a steep decline or incline, your vehicle may move in the opposite direction of the intended direction in spite of the creep effect. When stopping on a steep hill, always depress the brake pedal.
- Shifting the shift lever to the "N" position while driving may cause the engine brake to fail and cause an accident.

Kickdown Function

To rapidly accelerate, depress the accelerator pedal completely to the floor, which automatically engages a one- or two-lever gear. This is called the Kickdown function.

CAUTION

- Do not use the kickdown operation while driving on slippery or sharply curved roads. It may cause skidding and loss of control and may lead to an accident.
- Using the kickdown function too frequently may negatively affect the durability and fuel economy of the vehicle.

Engine Brake

When the accelerator pedal is released while the vehicle is in motion, the engine speed decreases. This decreased engine speed creates an extra braking force. On a downward slope, engaging a lower gear can generate a slower engine speed and eventually slow down the vehicle. Using this engine brake lets you decrease your vehicle speed without excessively using the brake system. The lower the gear, the greater the braking force.

CAUTION

- Extended use of the brake pedal on a downward slope without using the engine brake may significantly reduce the braking potential of your vehicle due to the "vapor lock" or "fade" phenomenon.
- Be aware that the engine brake does not work when the gear shift lever is in the "N" position.
- Avoid any abrupt engine braking on slippery roads to prevent slipping of the tires.

SHIFT LEVER AND SHIFT MODE

P : PARKING



Select this position to park, start the engine, warm-up, and stop the vehicle for a long time.

Always apply the brake when shifting out from the **P** position.

⚠ WARNING

- Never shift into **P** position while the vehicle is moving. The automatic transmission can be damaged.
- Stop the vehicle completely before shifting into **P** position.
- To shift from the **P** position to another position, the ignition switch must be turned ON and the brake pedal should be depressed. Any forcible attempts to move the shift lever from **P** without the two procedures may damage the shift lever.

R : REVERSE



Select this position to reverse the vehicle.

Always apply the brake and stop the vehicle completely to shift into **R** position from **P** or **N** position.

When the shift lever is in **R** position, the rearview camera and parking aid system will be activated. (optional)

⚠ WARNING

- Never shift into **R** position when the vehicle is moving.
- The parking aid system is a supplement system to help parking the vehicle. However, it cannot guarantee safety. Monitoring the back of the vehicle during reversing is the driver's primary responsibility.
- Please note that the vehicle may slowly move rearward when the shift lever is at **R**.

N : NEUTRAL



Select this position to stop the vehicle temporarily. At this position, the engine does not transfer power to the wheels and the vehicle will not move. However, for safety, apply the brake while at rest.

⚠ WARNING

- Do not shift into **N** position while the vehicle is moving. Your automatic transmission could be damaged.
- Always depress the brake pedal when the vehicle is stopped on a slope.
- Always depress the brake pedal when shifting into **D** or **R** position from **N** position after stopping.
- Never attempt to move the shift lever to **N** when the vehicle is in motion.

D : DRIVE



Select this position for normal forward driving on public roads and highways. At this position, the transmission is automatically shifted from the **1st** gear through the **5th** gear according to the vehicle speed.

⚠ WARNING

- Abruptly driving off or sharply accelerating the vehicle after shifting into **D** may damage the transmission. Especially, when you start off on a hill after stopping and parking the vehicle, wait for a while until the **D** shift indicator comes on with the brake pedal depressed.
- It is important to depress the brake pedal as the vehicle can roll down even while the gear is in **D**.

⚠ CAUTION

Please note that the vehicle may slowly move forward on level ground when the shift lever is in **D**.

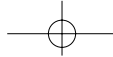

Shift Lock

The shift lock function can be activated only when the ignition switch is in the ON position. For safety reasons, this device is designed for deactivating the shifting operation depending on the driving conditions to protect the driver and the vehicle.

Shift lever lock in “P” position

If the vehicle is stationary, the ignition switch is in other positions than “ON” or the brake pedal is not depressed, you cannot shift out of “P”. To shift from “P”, the ignition switch must be turned to ON and the brake pedal must be depressed.

SHIFT LEVER LOCK RELEASE FOR A/T

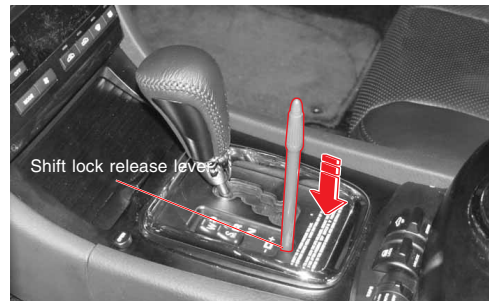

To shift from “P”, the ignition switch must be turned to ON and the brake pedal must be depressed. If you cannot shift out of “P” with the ignition switch in ON, and the brake pedal depressed:

1. Apply the parking brake firmly and turn the ignition off.
2. Depress the brake pedal and push down the shift lock release lever with a stick such as a pen. Then, shift the lever to “N”.
3. Start the engine, release the parking brake, and place the shift lever at “D”.

WARNING

If this happens, have your vehicle repaired at the nearest Ssangyong dealer or Ssangyong Authorized Workshop as soon as possible.

MANUAL SHIFTING

Manually move the shift lever into the desired position to shift a gear.
Moving the shift lever to the left (-) or the right (+) shifts the gear up or down.

Down shifting

1 ← 2 ← 3 ← 4 ← D

- ▶ Each time the shift lever is moved to the left side, the gear will be shifted down.
- ▶ Pushing and holding the shift lever to the left (-) shifts the gear down depending on the depressed amount of the accelerator pedal.

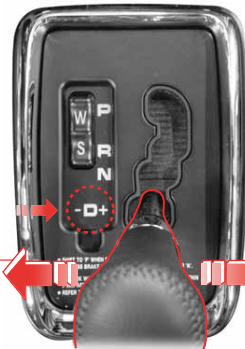

Up shifting

1 → 2 → 3 → 4 → D

- ▶ Each time the shift lever is moved to the right side, the gear will be shifted up.
- ▶ If you push and hold the shift lever to the right (+) direction, the gear is shifted to D.

1

- In this position, you can only use the first gear in the transmission. Use this position on long mountainous terrains, steep hills, and rough off-roads. This also provides the engine brake effect on steep downhill roads.

2

- The drive position prevents the transmission from shifting into the third or fourth gear. Select the drive range 2 for more power when climbing hills, and for the engine braking effects when driving down steep hills.

3

- At this position, the transmission is automatically shifted from the first gear up to the third gear according to vehicle speed. You can get the engine brake effect when using this position during downhill driving.

4

- At this position, the transmission is automatically shifted from the first gear up to the third gear. Use this position when driving down gently sloping roads.

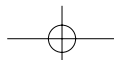

⚠ WARNING

- Be careful not to touch the shift lever while driving (especially during the winter season); doing so may change the shiftable gear and make the vehicle unstable.
- Do not downshift abruptly (3, 2, or 1) when the vehicle speed is high (D or 4). You could lose control and hit people or objects (especially on a slippery road).
- If low-range maximum speeds are exceeded when the shift lever is in low gears, the transmission can be damaged.

⚠ CAUTION

- When pushing and holding the shift lever to the left (-)/right (+), the gear may be shifted through several steps in a series. Make sure to shift one step at a time.
- It is recommended to gently move the shift lever to the left (-)/right (+); sudden shifting may cause the gear to not shift.
- Please note that the gear may be upshifted if you fully depress the accelerator pedal while driving with the first, second, third, and fourth gear.

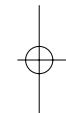
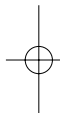

PARKING AID SYSTEM*

PARKING AID SYSTEM

When the shift lever is shifted into "R", the parking aid system is activated and the sensors in the rear bumper detect the distance to any obstacle. When an obstacle is detected, the alarm sounds and the EL display shows the rear area.

The alarm interval becomes faster and the number of bars on the EL display decreases as your vehicle approaches the object.

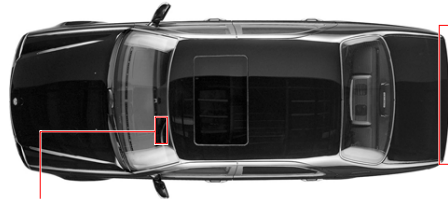

EL display

The EL display shows (in bars) the vehicle's distance from obstacles. For more information, refer to "Parking Aid System Display."

CAUTION

- The alarm does not sound if the distance between sensor and obstacle is less than 25 cm. However, if the sensor detects the obvious obstacle, the alarm stays on.
- Do not rely on the parking aid system while the shift lever is in the "R" position. Drive backward while checking the rear side of your vehicle.
- If the alarm sounds for 3 seconds when you select the "R" position with the engine running or ignition "ON", it means that there is a malfunction in the system.

EL display on the instrument cluster

Detecting rear right obstacle



Detecting rear center obstacle



Detecting rear left obstacle



Obstacle Sensor











The sensor informs you of the vehicle's distance from the obstacle. However, it cannot sense thin and narrow objects, such as wires, ropes, or chains.













PARKING AID SYSTEM DISPLAYS

- When the shift lever is shifted into "R" while the engine is running, the parking aid system is activated. When an object is detected, the alarm sounds and the EL display shows the rear area to inform the driver of the vehicle's distance from the obstacle.
- The alarm interval becomes faster as your vehicle approaches the object.

Display type

Center			
Distance	Display type	Distance	Display type
Over 120 cm	 R	80cm ~ 71cm	 R
120cm ~ 111cm	 R	70cm ~ 61cm	 R
110cm ~ 101cm	 R	60cm ~ 51cm	 R
100cm ~ 91cm	 R	50cm ~ 41cm	 R
90cm ~ 81cm	 R	Below 40 cm	 R

Left			
Distance	Display type	Distance	Display type
Over 100 cm	 R	70cm ~ 61cm	 R
100cm ~ 91cm	 R	60cm ~ 51cm	 R
90cm ~ 81cm	 R	50cm ~ 41cm	 R
80cm ~ 71cm	 R	Below 40 cm	 R

Sensor malfunction	
English mode	Korean mode
 R	 R

NOTE

The EL display shows the distance from the obstacle to the vehicle. The information shown in the EL display may differ from the actual distance depending on the sensor's condition and the obstacle's location.

This table also applies to the RH sensor.

MODE SELECTION

W : WINTER

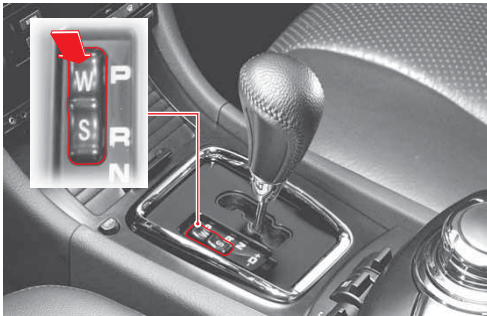

Select this mode to start or drive off on a slippery road during winter.

NOTE

If you select the **W** mode, the vehicle will start in the **2nd** gear on slippery surfaces. Move the shift lever to **D** or **R** position to minimize the slips on slippery surfaces for better traction.

CAUTION

- Do not use the **W** mode unless the vehicle is on slippery surfaces.

S : STANDARD

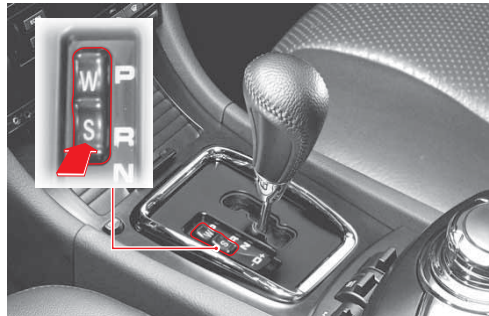

Select this mode for normal driving.

Starting off with the second forward/reverse gear

- Press the "**W**" portion of the mode switch to select "WINTER" driving mode.
- Move the shift lever to the "**D**" position and check if "**D₂**" is on the instrument cluster.
- Now the vehicle can be driven off with the second forward gear.
- The vehicle can be driven off with the second reverse gear if shifting the shift lever to the "**R**" position.

CAUTION

It is recommended to depress the brake pedal because even while the gear is in "**D**", the vehicle can roll down an uphill depending on the gradients.

AUTOMATIC TRANSMISSION SAFETY MODE

INDICATIONS THAT THE VEHICLE IS IN SAFETY MODE

When the transmission has an electric or mechanical fault, the transmission operates in safety mode to maintain minimum driving conditions and to prevent damage to the transmission.

If the transmission has an electric or mechanical fault, the following symptoms can happen:

- Heavy shock when moving the shift lever
- Decrease in the vehicle's driving force
- Current gear fixed and no acceleration regardless of the depressing of accelerator pedal
- "D", not "D_i", is displayed on the indicator when moving the shift lever to "D"

RESETTING SAFETY MODE

How to reset the safety mode

1. Stop the vehicle and move the shift lever to the "P" position.
2. Stop the engine and wait for over 10 seconds.
3. Start the engine.

Symptoms after resetting the safety mode

- Trouble has been corrected if the vehicle operates normally after resetting.
- The gear may be fixed at the second forward gear in "D" position or the second reverse gear in the "R" position. When this happens, have the vehicle checked at the nearest Ssangyong Dealer or Ssangyong Authorized Workshop.

CAUTION

- If you find any symptom caused by mechanical or electrical defects in transmission, stop the vehicle immediately and reset the safety mode.
- If there is still a mechanical or electrical problem despite the reset, have the system checked at the nearest Ssangyong dealer or Ssangyong Authorized Workshop.
- If there is still any mechanical or electrical defect in transmission after resetting, stop the vehicle immediately and have the system checked at the nearest Ssangyong dealer or Ssangyong Authorized Workshop.

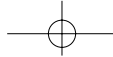

WARNING ABOUT THE PARKING AID SYSTEM

Check the surroundings before parking or reversing the vehicle.

- The parking aid system is a supplementary system to help your parking. It is not intended to replace the driver's attentiveness.
- Do not apply any shocks to the sensors by hitting or using a high-pressure water gun while washing. The sensors may be damaged.
- Normally, when you select the **R** position with the ignition ON, the alarm sounds "beep" once.
- If the alarm sounds for 3 seconds when you select the **R** position with the engine running or ignition "ON", it means that there is a malfunction in the system. Have the parking aid system checked at the nearest Ssangyong Dealer or Ssangyong Authorized Workshop. However, do not misinterpret this alarm system that beeps when nearing the obstacle (within 50 cm).

The alarm may not work or improperly operate under following conditions.

► The Obstacles That Sensors Cannot Detect

- Wire, ropes, chains
- Materials that absorb ultrasonic waves: Cotton, sponge, clothes, and snow
- Obstacles that are lower than the bumper: Drainage or puddle

► Sensors Cannot Detect

- When they are frozen
- When they are covered by snow or mud
- When they receive other ultrasonic signals (metallic sound, air braking noise from heavy duty vehicle)
- When a high-power radio is turned on

► Weak Sensing Scopes

- When they are partially covered by snow or mud
- When the ambient temperature is too high (above 80°C)
- When the ambient temperature is too low (below -30°C)

► Not Defective, But May Operate Improperly

- When driving on a rough road, gravel road, hill or grass
- When the bumper height is lowered due to loading
- When the sensing area is frozen
- When the sensing area is covered by rain, water drops, snow or mud
- When they receive other ultrasonic signals (metallic sound, air braking noise from heavy duty vehicle)
- When a high-power radio is turned on
- When the sensor is hindered by improperly installed accessories

REARVIEW CAMERA SYSTEM*

The A/V system does not function when the front monitor displays the rearview.

This is a support system to display rear area when the shift lever is in **R** position.

R position

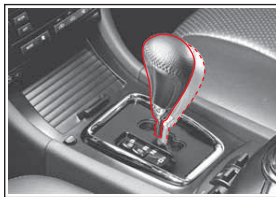

Select **R** position.

Power supply

Rearview Camera



Sending video signals.

Front Monitor



Display

Rear Monitor

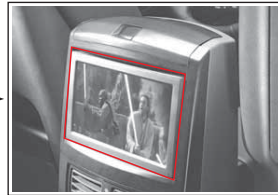

* Displays the rear view when the monitor is not in use

► When selecting **R** position while A/V system is in use

- The A/V screen is changed to rear view monitoring mode
- It returns to the A/V mode when shifting out from "R" position
- The audio stays ON in rear area monitoring mode

► When selecting **R** position while A/V system is not in use

- The monitor turns on automatically and displays rear view
- The monitor turns off when shifting to other position

The rear monitor does not change to rear view monitoring mode when DVD or VCD is playing.

⚠ CAUTION

- The real distance is different from what you see in monitor because the camera uses wide-angle lens.
- Note that the display does not show everything in the rear area.
- Keep the camera lens clean with a lens cleaner.

4° AIMING DOWN OF OUTSIDE REARVIEW MIRROR DURING REVERSING



1. Select left (L) or right (R) side mirror with the mirror select switch.
(For details, refer to "Control Switches" section)
2. The mirror aims down by 4° when the shift lever is moved to **R** position.
3. The outside rearview mirror returns to the original position when shifting out from "R" position.

NOTE

The outside rearview mirrors are heated and the rearview mirrors are automatically controlled against light intensity (anti-dazzle*).

CAUTION

- This function does not operate when the mirror select switch is at center position.
- This is a supplementary system to help your driving. It is not intended to replace the driver's attentiveness.
- The outside mirror stops moving when you use the front window switch in driver's switch panel during operation. The re-starts after completion of the window operation. During this operation, however, if you move the shift lever to another position other than **R**, the setting angle of 4° may be changed.
- If you need to operate the windows, complete it before shifting to **R** position.

FOOT BRAKE

The brake pedal (foot brake) is designed to slow down and stop the vehicle. Do not apply excessive pressure on the brake pedal while going down a long hill. The brake system may overheat and cause the vapor lock or fade phenomenon, thus losing braking force. Use the foot brake along with the engine braking effects by selecting a lower gear.

CAUTION

Avoid abrupt engine braking on slippery roads, or the tires may slip.

Fade?

Reduction or loss in braking force due to loss of friction between brake pads and disc. Caused by heat buildup through repeated or prolonged braking.

Vapor Lock?

When the brake system is overheated, the fluid in the brake lines will boil and form bubbles. Only the bubbles will be compressed when the brake pedal is depressed. So the brakes cannot work properly due to the loss of braking force.

Engine brake?

A system that allows the slowing of a vehicle independent of conventional braking systems. A driver would normally down-shift to slow the driver's descent of a hill, using engine compression. The engine brake increases the effectiveness of this regarding force.

Checking Pedal for Obstacles



Any obstacle, such as a can, around the brake pedal or accelerator pedal may impede in the proper operation.

Make sure there is no obstacle around the pedals before driving.

Inspection and Replacement of Brake Pad and Disc



If the brake pad wear warning lamp on the instrument cluster comes on, replace the brake pads immediately.

Check the brake pads/discs for wear after every 10,000 km of driving and replace if necessary.

CAUTION

The service interval is subject to your driving style.

ESP* (ELECTRONIC STABILITY PROGRAM)

ESP SYSTEM?

The ESP system is an electronic vehicle-stability control and a supplementary safety driving system that helps to avoid dangerous situations by controlling the brakes on the wheels or the engine torque to compensate vehicle stability during extremely unstable conditions such as sharp cornering.

ESP Warning Lamp



ESP

Turning on of ESP Warning Lamp

Pressing the ESP OFF switch stops the ESP function and lights up the indicator lamp in the instrument cluster. Press this switch again to resume the ESP function.

Flickering ESP Warning Lamp

Operating the ESP function while driving makes the indicator lamp flicker and sets off the alarm.

WARNING

The ESP warning light indicates defect in the ESP system. Have the vehicle checked at the nearest Ssangyong Dealer or Ssangyong Authorized Workshop.

ESP OFF Switch (Cancellation/Resume of ESP Function)

Driving on slippery snowy or icy roads may prevent the engine's rpm from increasing despite stepping on the accelerator pedal, and may bog you down. In this case, stop the ESP function by pressing the ESP OFF switch, which allows the vehicle to be driven independently from the sensor outputs.

ABS (ANTI-LOCK BRAKE SYSTEM)

ABS SYSTEM?

Braking suddenly or braking on slippery roads locks the wheels and makes the vehicle slide forward, which is dangerous. The ABS helps you to prevent it by maintaining directional stability and control of the vehicle.

ABS Warning Lamp



(ABS)

When the ignition switch is turned "ON", this warning lamp comes on and goes out under normal operation.

WARNING

- If this light does not come on when the ignition is switched on or if this light does not go out, contact your nearest Ssangyong Dealer or Ssangyong Authorized Workshop. If it lights up while driving, it indicates an ABS malfunction.
- ABS is a device that prevents wheels from locking up during braking. However, the ABS system does not shorten the stopping distance.
- According to road conditions, the stopping distance of the vehicle with ABS may either be longer or shorter than that of the vehicle without ABS.

REGULAR PARKING BRAKE

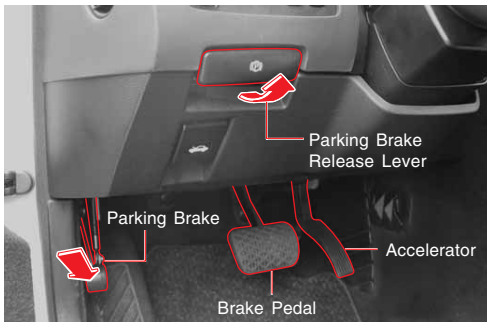

Parking Brake Operation

Park at a safe place, and depress the parking brake pedal firmly.

When the pedal is depressed, the brake warning light () on the instrument cluster comes on.

Parking Brake Release

To release the parking brake, pull up the lever.

Warning Sounds While Driving with Engaged Parking Brake



If you drive the vehicle without releasing the parking brake, the brake warning light blinks and the buzzer sounds to warn the driver when the vehicle speed exceeds 10 km/h for more than 2 seconds. When this happens, stop the vehicle immediately and release the parking brake.

CAUTION

- Before driving off, be sure to check that the brake warning light is turned off.
- If you drive the vehicle without releasing the parking brake, the brake system will be damaged. Make sure that you fully release the parking brake before driving.
- If the brake warning light () doesn't go out after releasing the parking brake, have the brake system checked at the nearest Ssangyong Dealer or Ssangyong Authorized Workshop.

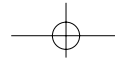

TABLE OF CONTENTS

Seats and Controls 7-2
 Warning and Caution 7-3

Front Seats 7-4
 Seat Adjustment (Based on Driver's Seat) 7-4
 Head Restraint 7-5
 Easy Access System (Driver's Seat) 7-6
 Position Memory Setting* 7-7
 Passenger's Seat Control Switch (On the Left Side of the Seat) 7-8
 Passenger's Seat Control Switch (Rear Armrest) 7-8

Rear Seats 7-9
 Rear Seat Control Switch Panel 7-9
 Rear Seat Control Switches 7-10
 Passenger's Seat Control Switch and Roller Blind Switch (Rear Glass) 7-11

Seat Heating*/Ventilation System* 7-12
 Vehicle Seat Heating Without the Seat Ventilation Function 7-13
 Rear Seat Heater Switch* 7-14
 Massage Switch* 7-15

**Section 7
Seats and Controls**

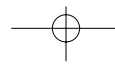
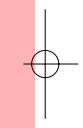

SEATS AND CONTROLS

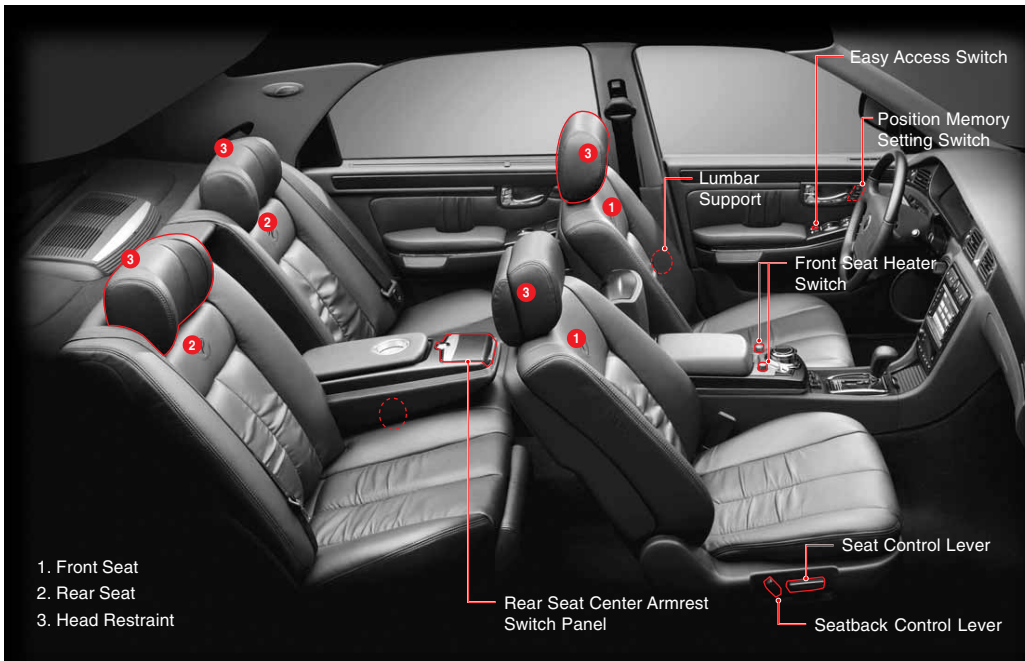

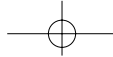

WARNING AND CAUTION

WARNING

- Do not adjust the driver's seat while driving.
- After adjustment, gently rock the seat to make sure it is securely locked.
- If the seatback is reclined too much, the risk of sliding under the lap belt and being injured are increased.
- Do not operate the position memory switch while vehicle is moving. If the power seat does not operate, check and correct the problem before driving off.
- Do not put anything hard or heavy on the seat. This may cause damage to the seat.
- Do not operate the seat heater for a long time when the passenger is infant, child, old or handicapped person, person with sensitive skin, exhausted person or drunk person. They may get burnt.
- Make sure the head restraints are in place and adjusted before driving. Driving without the head restraints can lead to a serious injury.
- Do not recline the seatback more than needed for comfort while vehicle is in use. Seat belt is the most effective when the passenger sits back and straight up in the seat. If the seatback is reclined too much, then the risks of sliding under the lap belt and getting injured are increased.
- Do not put anything on the seat that insulates heat, such as a blanket, cushion or seat cover.

CAUTION

- The power seats are operated even when the ignition switch is turned to "OFF" position. However, to prevent from battery discharge, operate the seats when the engine is running.
- Do not attempt multi-operation for your seat at a time. It can damage the seat motor. Please operate the seat motor one at a time.
- When cleaning the seats, do not use organic solvents such as benzene or thinner. The seat surface may get deteriorated.
- Do not forcibly operate any power adjustment switch if the seat comes in contact with other object and cannot be adjusted anymore.
- If the power seats are not operational, the seats should be checked and fixed before any driving.

FRONT SEATS

Note: In manual passenger seats, use the control lever under the seat cushion for sliding control.

SEAT ADJUSTMENT (BASED ON DRIVER'S SEAT)

Sliding, Seat Height and Cushion Inclination, and Seatback Tilting Lever

Sliding (driver's seat, passenger's seat)

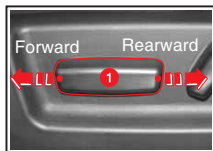

To slide the seat forward or backward, move the seat sliding lever (1).

Seat height (driver's seat)

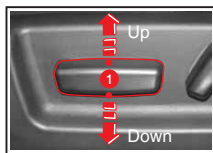

To move the seat up or down, lift the center of seat cushion height lever (1) up or down.

Cushion inclination (driver's seat)

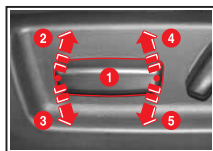

To adjust the inclination of the seat cushion, lift the edge of the inclination lever (1) up or down.

- (2): Front part of the cushion goes up
- (3): Front part of the cushion goes down
- (4): Rear part of the cushion goes up
- (5): Rear part of the cushion goes down

Lumbar support (driver's seat)

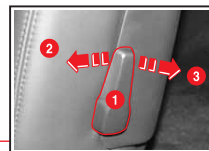

Turn the lever (1) forward (2) or backward (3) to support the spine correctly.

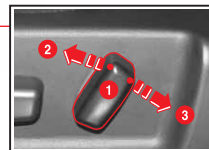

Seatback tilting (driver's seat, passenger's seat)

Turn the lever (1) forward (2) or backward (3) to adjust the seatback angle.

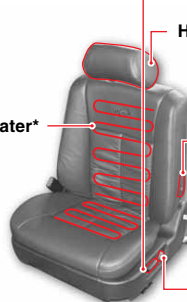

HEAD RESTRAINT

Front Head Restraints



The front head restraint can be adjusted vertically and in inclination.

You can pull it up until it locks in place. To lower it, push down while pressing and holding the lock knob.

To remove the head restraint completely, press and hold the lock knob and lift it out.

Hold and move it forward or backward for inclination.

The inclined head restraint returns to its normal position when you pull it forward completely and then release it.

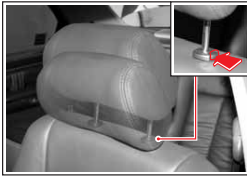

⚠ WARNING

Driving without the head restraints can lead to a serious injury.

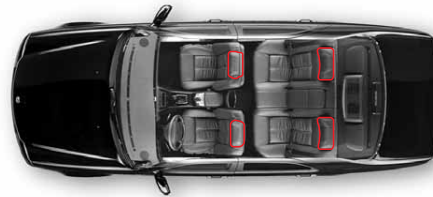

Rear Head Restraints

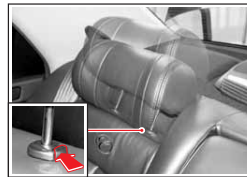

The rear head restraint can be adjusted vertically and in inclination. Hold the head restraint and move it forward or rearward to adjust its inclination.

To raise the head restraint, pull it up until it locks in place. To lower it, press and hold the lock knob and push it down. To remove it completely, lift it up by pressing and holding the lock knob.

EASY ACCESS SYSTEM (DRIVER'S SEAT)

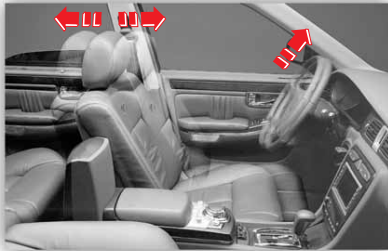

CAUTION

- The front and rear "Easy Access" functions can be operated only when the relevant switch is pressed in.
- The moving distance of the seat is based on when the seat is located at its front end. It varies according to the initial position.
- If the steering wheel is fully tilted up, it will not move during Easy Access operation.
- There could be some differences when the seat move back to its original position. The differences of the passenger weights and electrical loads can cause the differences in its distance, and this is normal, not defective.

Easy Access



This system is designed to provide the driver sufficient space to access and exit.

The easy access functions can be operated only when the easy access switch is pressed.

To operate

To use this function, press the Easy Access button (1) located at driver's window switch panel.

- To exit :**
1. Turn the ignition switch to "OFF" position and remove the key from the key switch. The seat moves backward.
 2. If you open the driver's door, the steering wheel tilts up.

- To access :**
1. Open the driver's door and sit. Close the door and turn the ignition switch to "ON" position.
 2. The seat and the steering wheel move back to their original position automatically. If you drive off before completion of this movement, this operation stops at that point

To release

To release this function, press the Easy Access button again.

POSITION MEMORY SETTING*

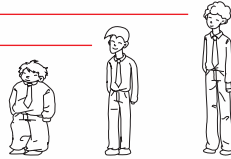
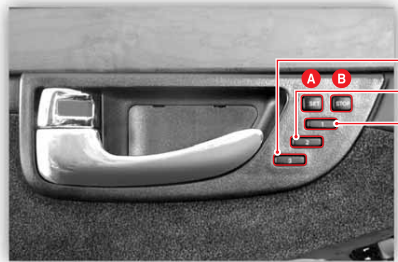

The position memory is available for up to three drivers. Each driver can set his/her own driver's seat, steering wheel, outside mirrors and interior rearview mirror positions and it will be separately stored in the integrated computer. If somebody has moved the seat, the memory positions can be recalled automatically by pressing the position button.

To store the memory settings

→ Memorized →

To operate the memory settings

1. Position the transmission shift lever to **P** with the ignition switch "ON" (for your safety, do not start the engine).
2. Adjust the driver's seat, steering wheel, outside mirrors and interior rearview mirror to the desired positions.
3. Press **(SET)** (A) switch. The indicator on the switch comes on.
4. Within 5 seconds, press the button **(1, 2, 3)** you want to set.

1. Position the transmission shift lever to **P** with the ignition switch "ON" (for your safety, do not start the engine).
2. Press and hold the button **(1, 2, 3)**, the driver's seat, steering wheel, outside mirrors and interior rearview mirror start to move.
3. Wait until they stop moving.

IT CAUTION

- Never operate any of the driver's seat, steering wheel, outside mirrors, or interior rearview mirror during memory setting, otherwise memory setting is cancelled.
- If you do not press within 5 seconds after pressing set switch, memory setting is cancelled.

NEW CHAIRMAN

SEATS AND CONTROLS

7-7

PASSENGER'S SEAT CONTROL SWITCH (ON THE LEFT SIDE OF THE SEAT)

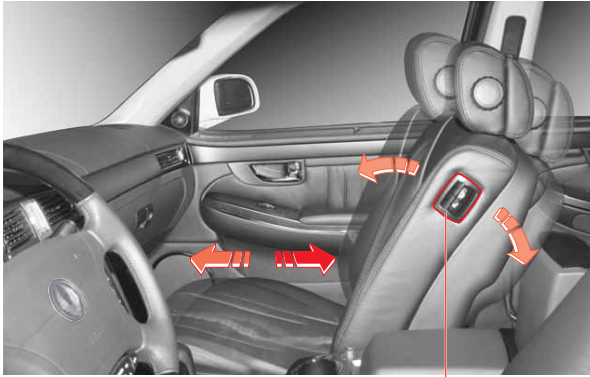

Seat Sliding Switch
Move this switch forward or backward to slide the seat forward or backward.

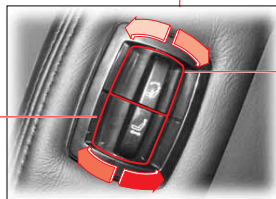

PASSENGER'S SEAT CONTROL SWITCH (REAR ARMREST)

Passenger's seat sliding switch

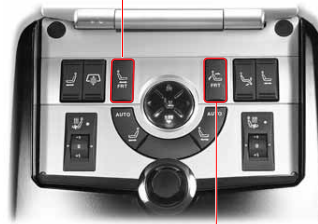

Passenger's seatback tilting switch

Seatback Tilting Switch
Move this switch forward or backward to tilt down or tilt up the seatback.

REAR SEATS

REAR SEAT CONTROL SWITCH PANEL

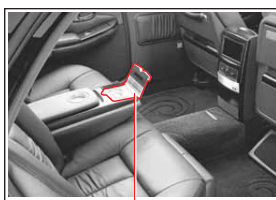

To use this function, press this easy access button. To release the function, press the button again.

This system is designed to provide the driver with sufficient space to access and exit.

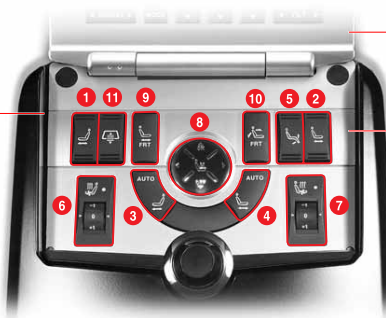

Rear A/V System Control Switch Panel
*(refer to separate A/V operating instruction)

Rear Seat Control Switch Panel
(including passenger's seat and roller blind controls)

- | | |
|---------------------------------------|-------------------------------------------|
| 1. Rear Left Seat Sliding Switch | 7. Rear Right Seat Heating Switch* |
| 2. Rear Right Seat Sliding Switch | 8. Massage Switch (Rear Right seat only)* |
| 3. Rear Left Seat Easy Access Switch | 9. Passenger's Seat Sliding Switch |
| 4. Rear Right Seat Easy Access Switch | 10. Passenger's Seatback Tilting Switch |
| 5. Leg Support Switch* | 11. Roller Blind Switch (Rear glass)* |
| 6. Rear Left Seat Heating Switch* | |

REAR SEAT CONTROL SWITCHES

Rear Seat Easy Access Switch



3. For Rear Left Seat
4. For Rear Right Seat

This system is designed to provide for sufficient space to access and exit for Passengers.

To operate

1. Press the AUTO switches.
2. The corresponding rear seat moves to its rear end when opening the rear door.
3. The corresponding rear seat moves back to its original position when closing the rear door.

CAUTION

- The rear "Easy Access" function can be operated only when the corresponding AUTO switch is pressed in.
- The moving distance of the seat is based on when the seat is located at its front end. It varies according to the initial position.
- There could be some differences when the seat moves back to its original position. The differences of the passenger weights and electrical loads can cause the differences in its distance, and this is normal, not defective.



Rear Seat Sliding Switch



1. For Rear Left Seat
2. For Rear Right Seat

To slide the rear seat forward or backward, press this switch.

Leg Support Switch*

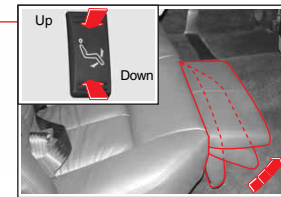

The leg support is installed at rear right seat. To fold the leg support, press this switch.

PASSENGER'S SEAT CONTROL SWITCH AND ROLLER BLIND SWITCH (REAR GLASS)



Passenger's Seat Sliding Switch

Press this switch to slide the passenger's seat forward (1) or backward (2).

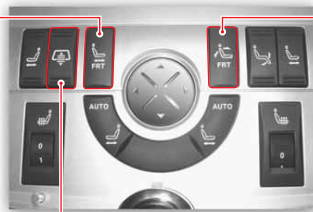

Passenger's Seatback Tilting Switch

Press this switch to tilt down (1) or tilt up (2) the passenger's seatback.

Roller Blind Switch (Rear Glass)*



Press this switch to raise (1) or lower (2) the roller blind.

* The driver's switch panel also has the roller blind switch for the rear glass.

WARNING

For safety, do not use the passenger's seat sliding switch and the seatback tilting switch while the passenger's seat is occupied.

SEAT HEATING*/VENTILATION SYSTEM*



Seat Heating

Heated cushions and seatbacks create a pleasant driving environment by keeping the surface of the seats comfortably warm.

Ventilation System

The seat cushion has a ventilation function to give you a pleasant driving environment. (There is no ventilation function on the seatback.)

Rear Left Seat Heating/
Ventilation Switch

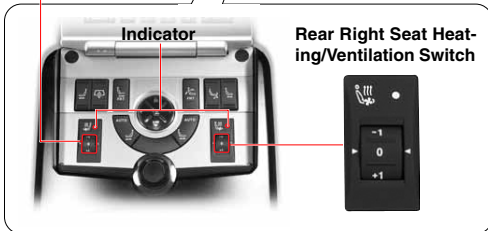

Driver's Seat Heating/
Ventilation Switch

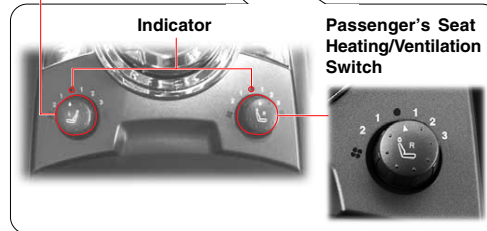

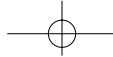

Heating (red light on)

Front seats: Turn the switch clockwise (three stages)

Rear seats: Put the switch to +1, +2 or +3 position (three stages)

Ventilation (blue light on)

Front seats: Turn the switch counter-clockwise (two stages)

Rear seats: Put the switch to -1 or -2 position (two stages)

Stop (indicator off)

To turn off the heating/ventilation, turn the front switch to the indicator and the rear switch to the "0" position.

VEHICLE SEAT HEATING WITHOUT THE SEAT VENTILATION FUNCTION

Turn the seat heating switch from ● (OFF) to the desired position (1–5).

To turn off the heating function, turn the front switch to the indicator and the rear switch to the "0" position.



Front seat heating switch



Rear seat heating switch

WARNING

- To avoid causing minor burns, do not prolong the seat heating for certain passengers, such as infants, young children, the elderly, or the handicapped; those with sensitive skin, are under the influence of alcohol, or excessively fatigued.
- Be careful when using the heated seat; prolonged skin contact may cause burns.
- Do not put anything on the seat that insulates heat, such as a blanket, cushion or seat cover.
- If the temperature continues to rise, turn the switch off and have the system checked at the nearest Ssangyong Dealer or Ssangyong Authorized Workshop.
- Excessive seat heating of the driver's seat may make the driver sleepy and pose safety risks.
- Do not place any sharp objects on the seat, which may damage the seat heater.

CAUTION

- When cleaning the seats, never use oil-based solvents such as benzene, alcohol, gasoline, or thinner, which may cause heating/ventilation system malfunction and dull the seats' surface.
- Do not spill any liquid on the seats' surface, which may clog the vent duct and affect the ventilation.
- Do not store objects, such as vinyl bag and paper, under the seat. They may block the vent duct and cause poor ventilation or malfunction.

NOTE

The seat heating/ventilation function turns off when you turn the ignition switch off while the seat heater is on. To turn on the seat heating/ventilation function again, switch the seat heating/ventilation OFF and select the desired setting.

REAR SEAT HEATER SWITCH*



- 6: Rear Left Seat Heating Switch (control range: 1 to 5)
7: Rear Right Seat Heating Switch (control range: 1 to 5)

This system is designed to provide temporary heating system for passengers.

To Heat the Rear Seats

1. Start the engine.
2. Turn the seat heater switch from 0 (OFF) to the desired position (1 to 5).
3. The seat cushion and the seatback will be warmed up.

WARNING

- Do not operate the seat heater for a long time when the passenger is an infant, child, old or handicapped person, person with sensitive skin, exhausted person or drunk person. They may get burnt.
- Do not put anything on the seat that insulates heat, such as a blanket, cushion or seat cover.
- If the temperature continues to rise, turn the switch off and have the system checked at the nearest Ssangyong Dealer or Ssangyong Authorized Workshop.
- Do not place anything sharp on the seat. This may cause damages to the seat heater.
- The seat heater turns off when you turn the ignition switch off while the seat heater is operating. If you want to operate the seat heater again, turn the seat heater switch to OFF position and select the desired position.
- When cleaning the seats, do not use organic solvents such as benzene or thinner. The seat surfaces may get deteriorated.

MASSAGE SWITCH*

Rear right seat has the massage and lumbar support function.

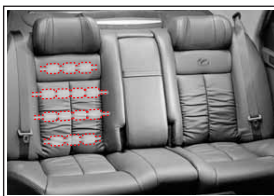

To operate the massage function

► To start the AUTO massage operation

To operate massage function, press the "1" switch. The massage roller operates automatically for 10 minutes unless interrupted by another operation.

► To stop the massage operation

To stop the massage function, press the "2" switch. The massage roller returns to its original position.

To adjust the massage strength

- To increase the massage strength, press the "3" switch. The massage roller moves forward.
- To decrease the massage strength, press the "4" switch. The massage roller moves backward.



Lumbar support function of the massage roller

You can use the massage roller as a lumbar support with changing its position.

1. Stop the massage operation by pressing "2" switch.
2. To move the massage roller up or down, press and hold the "1 (up)" or "2 (down)" switch. Release the switch when it reaches the desired position.
3. To move the massage roller forward or backward, press and hold the "3 (forward)" or "4 (backward)" switch. Release the switch when it reaches the desired position.

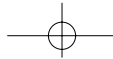

TABLE OF CONTENTS

Seat Belt and Air Bag 8-2

- Occupant Safety 8-3
- Warning 8-3
- Seat Belt 8-4
- Infant and Child Safety 8-8
- Child Anchor (Australia only) 8-8

Air Bag 8-13

- Cautions with the Air Bag 8-14
- Air Bag Inspection 8-14

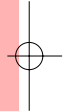

Section 8
Seat Belt and
Air Bag

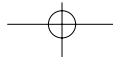

SEAT BELT AND AIR BAG

1. Three Point Seat Belts (Front seats, rear left & right seat)

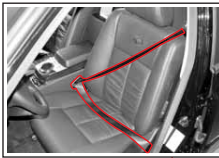

2. Seat Belt Height Adjustment (Front seats)

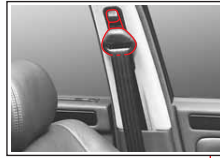

3. Lap Belts (Rear center seat)

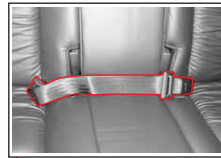

4. Buckle Compartment (Rear seat)

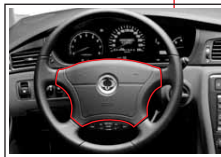
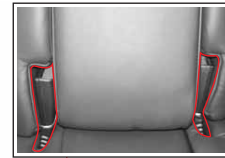

5. Driver's Air Bag

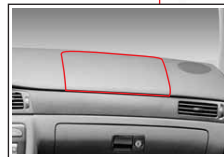

6. Passenger's Air Bag



7. Side Air Bag

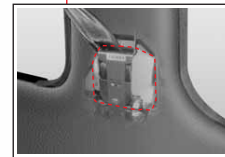

8. Seat Belt Pretensioner (Front seats)

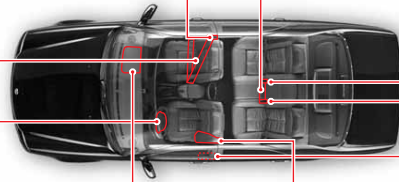

OCCUPANT SAFETY



The Restarint Systems Include:

- Air Bags
- Child or Infant Seats
- Seat Belts
- Seat Belt Pretensioners

As independent systems, their protective functions complement one another.

This section contains all the most important information about the restraint systems of the vehicle.

Fastening the Seat Belt

When seat belts are not used or improperly worn, they may not only work as designed, but also cause some injuries to occupants. In addition, air bags can protect occupants when the occupants are wearing their seat belts. Air bags may cause injuries to occupants if they do not wear or inappropriately use their seat belts.

WARNING

- Before driving, all occupants should wear the seat belts. If not, the occupant can be injured seriously in collisions or sudden operation.
In many countries, there are regulations concerning the use of the seat belts. Please observe local laws and regulations.
- Never use a seat belt for more than one person at a time.
- Improper maintenance of the seat belts can cause the restraint systems to malfunction.
- Always work on the seat belts at the Ssangyong Dealer or Ssangyong Authorized Workshop, which has the knowledge and special tools to carry out the required work.
- An infant or small child should always be secured to an appropriate restraint.

SEAT BELT

1. Three Point Seat Belt

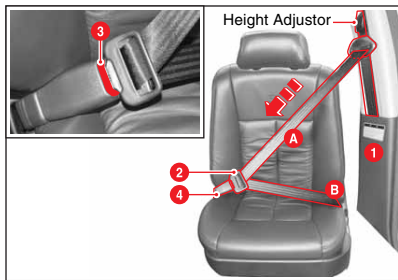

1. Sit back in the seat with the seatback in an upright position and wear the seat belt.
2. If the shoulder belt (A) crosses your neck, then adjust the seat belt height with height adjuster (front seat).
3. Pull out the latch plate (2) from the retractor (1). Check if the seat belt is not twisted.
4. Position the shoulder belt (1) across the body and the lap belt (B) as low as possible across the hips. Insert the latch plate (2) into the buckle (4) until it clicks.
5. Pull the latch plate to make sure it is securely locked.
6. To remove the belt, press the red button (3) on the buckle.



2. Lap Belt (Rear Center Seat)

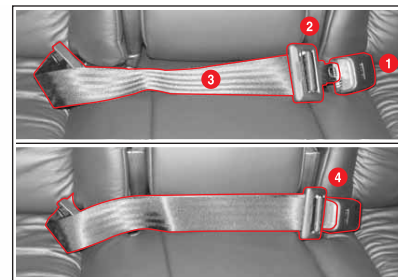

1. Pull the latch plate (2) to position the lap belt (3) across the hips as low as possible.
2. Insert the latch plate into the buckle (1) until it clicks.
3. Pull the latch plate to make sure it is securely locked.
4. To lengthen, hold the latch plate (2) at right angle to the belt and pull the belt. To shorten, pull the free end of the belt away from the latch plate, then pull the belt clip to take up the slack.
5. To remove the belt, press the red button (4) on the buckle.



3. Seat Belt Height Adjustor (Front Seat)

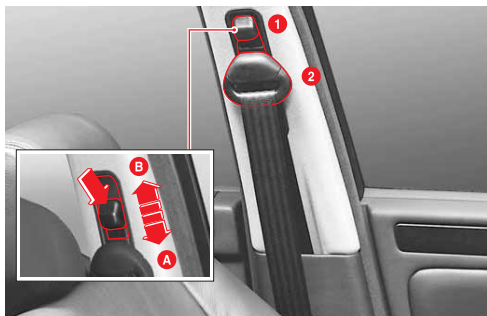

The seat belt height adjusters are provided for the front seat to adjust the seat belt height.

Down (A): Press the knob (1) and slide the retractor down to obtain the snug and fit position.

Up (B): Hold the D-ring (2) and slide the retractor up to obtain the snug and fit position.

⚠ WARNING

- Adjust the seat belt before driving off.
- Adjust the seat belt so that it does not cross your neck.

4. Buckle Stowage (Rear Seat)

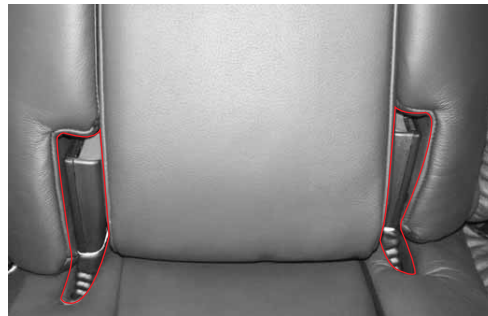

The rear seat belt can be stored into the stowage when it is not used. This stowage is located at the bottom edges of the center armrest.

⚠ WARNING

Improperly worn seat belts could cause serious injury or death.

- Put the lap belt as low as possible across the hips. Do not put it across the waist. In an accident, the belt may apply pressure to your abdomen. This may cause internal injuries.
- The shoulder belt should be positioned midway over the shoulder, never across the neck.

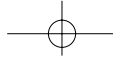

WARNING

- Always put on your shoulder belt over the shoulder and across the chest. Do not put the shoulder belt across your neck.
- Put the lap belt as low as possible across the hips. Do not put it across the waist. In an accident, the belt may pressurize on your abdomen.
- Do not wear the shoulder belt under the arm. It increases the danger of sliding out of the belt and can cause serious injury or even death. The belt may also tighten the chest which is not as strong as the shoulders. This may also result serious internal injuries.
- Do not lock the seat belt with a clip or a clamp. If the seat belt is too loose, it may not protect your body from injury or death in an accident.
- Before driving, all occupants should wear the seat belts. If not, occupants could be seriously injured in collisions or sudden maneuvers. In many countries, there are regulations regarding the use of the seat belts. Please observe local laws and regulations.
- Do not use the seat belt for more than one person at a time.
- Do not wear the seat belt over any hard or breakable objects in pockets or on clothes.
- Infants and small children must be restrained in a child restraint system. Note that the three point seat belt is designed for a person who is taller than 140 cm.
- Periodically check that the seat belt and its component work properly. Damaged seat belt can cause serious injuries. Repair or replace the damaged seat belt immediately at the Ssangyong Dealer or Ssangyong Authorized Workshop.
- The warning lamp comes on whenever the ignition is switched on. The lamp goes out when the driver's seat belt is securely fastened. If the lamp does not turn off after fastening the seat belt, it means that there is a malfunction in the system. Have the seat belt system checked at the nearest Ssangyong Dealer or Ssangyong Authorized Workshop.
- Additional device or accessory on the seat belt may result in improper operation. Do not add any adjusting devices which restrict the seat belt operation.
- Periodically inspect all parts of the belt and have the damaged parts replaced. The belt that has been overstretched in an accident must be replaced with new one. Ssangyong recommends replacing all component parts of the seat belt after a collision. No replacement is required after a minor collision if a Ssangyong Dealer or Ssangyong Authorized Workshop finds that no damage has occurred and everything is in proper working order. The seat belts and components that were not used during a collision must also be inspected and replaced if they show signs of damage or faulty operation.
- Replace the entire seat belt assembly after a severe impact even if the damage is not obvious.
- Never modify the seat belt.
- Always keep the seat belts clean and dry. Care should be taken to avoid contamination of the webbing with polishes, oil and chemicals, and particularly battery acid. Use mild soap and water for cleaning. The seat belt must be replaced if webbing becomes frayed, contaminated or damaged.

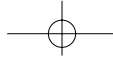

WARNING

- Adjust the seat properly before wearing the seat belt.
- Sit back in the seat with the seatback in an upright position and wear seat belt. If the seat belt is positioned too high or fastened too loose, it may not protect your body from an injury or death in the event of a collision.
- Do not recline the seatback more than needed for comfort while vehicle is in use. Seat belt is the most effective when the passenger sits back and straight up in the seat. If the seatback is reclined too much, then the risks of sliding under the lap belt and getting injured are increased.
- If the latch plate is inserted into a wrong buckle, the belt may exert pressure on your abdomen instead of your pelvis. This may cause serious internal injury.
- If the seat belt is twisted, there will not be enough contact of the belt to spread the impact pressure.
- Make sure that the latch plate is securely locked.
- When pregnant women use the seat belt, consult with a doctor for specific recommendations.
- Keep the buckle clean.
- Seat belts are designed to bear upon the bony structure of the body, and should be worn low across the front of the pelvis or the pelvis, chest and shoulders, as applicable; wearing the lap section of the belt across the abdominal area must be avoided.
- Seat belts should be adjusted as firmly as possible, consistent with comfort, to provide the protection for which they have been designed. A slack belt will greatly reduce the protection afforded to the wearer.
- Care should be taken to avoid contamination of the webbing with polishes, oils and chemicals, and particularly battery acid. Cleaning may safely be carried out using mild soap and water. The belt should be replaced if webbing becomes frayed, contaminated or damaged.
- It is essential to replace the entire assembly after it has been worn in a severe impact even if damage to the assembly is not obvious.
- Belts should not be worn with straps twisted.
- Each belt assembly must only be used by one occupant; it is dangerous to put a belt around a child being carried on the occupant's lap.
- No modifications or additions should be made by the user which will either prevent the seat belt adjusting devices from operating to remove slack, or prevent the seat belt assembly from being adjusted to remove slack.

INFANT AND CHILD SAFETY

Child Seat

Children that are too small to use the seat belts must be properly secured in a child restraint system.

Please note that the three point seat belt is designed for a person who is taller than 140 cm.

WARNING

- Do not place a child restraint system in the front seat. The infant or child could be severely injured by an air bag inflation in case of an accident.
- Use only the qualified child restraint systems. Follow the manufacturer's instructions for installation and use of the child restraint systems.
- Do not carry your child on your lap while driving. You cannot resist against the impact pressure in an accident. The child could be crushed between you and the parts of vehicle.
- Remember that a child restraint seat left in a concealed vehicle can cause it to be very hot. Check the seating surface before putting your child in the child restraint.
- When your child restraint is not in use, store it in the trunk or keep it secured with a seat belt to prevent it from being thrown forward in case of a sudden stop or an accident.
- Never leave children or old persons unattended in a concealed vehicle. When the inside temperature increases very high, they may be in danger.
- When installing a child restraint, do not let the seat belts come across the child's neck.

CHILD ANCHOR (Australia Only)

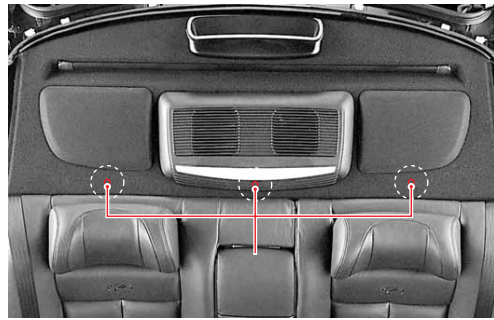

How to use Child Anchor

1. Engage the attaching clip of the child seat with one of the child restraint anchorages provided on the rear parcel shelf.
2. Secure the child seat with the seat belt.
3. Ensure that the child seat is correctly installed and fastened properly.

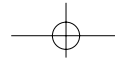

Anchorage Locations

Child restraint anchor fittings have been installed to coincide with the rear seating positions as follows.

WARNING

- Unrestrained infants and small children could be injured.
- Never transport them unless they are properly restrained.
- Use restraint system which meet safety standard.
- Follow directions provided by the manufacturer.

NOTE

Use the child restraint anchorage for designed purpose only.

NOTE

- Front seat (with Passenger Air Bag)
"It is possible to the forward facing universal category child seat."
- Front seat (without Passenger Air Bag)
"It is possible to install the forward and rearward facing univesal category child seat."
- Rear seat (3 points s/belt)
"It is possible to install the forward and rearward facing univesal category child seat."
- Rear seat (2 points s/belt)
"It is possible to install the forward facing universal category child seat."

Child Restraint Installation

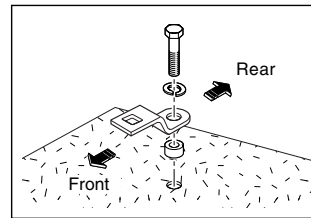

Your vehicle has been designed to accommodate a child restraint on the rear seat. When using a child restraint, read the installation instructions supplied with the child restraint and follow the directions for fitment carefully.

When installing the child restraint, use the correct anchor bolt (5/16" bolt).

The anchor bolt must be engaged at least 5 full threads in the anchorage.

The child restraint system should be secured in conjunction with the vehicle's seat belt. After installation, push and pull the child restraint to be sure it is secure.

Secure the child in the restraint in accordance with the manufacturer's instructions.

If you have any queries regarding the installation of a child restraint, consult a Ssangyong Dealer.

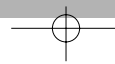

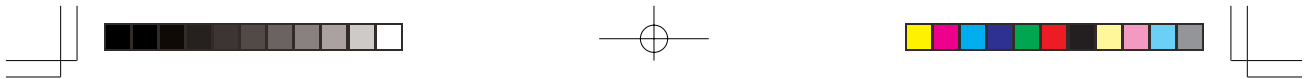

⚠ WARNING

Child restraint system placed in the front seat could cause more serious injury or death

- NEVER INSTALL A REAR-FACING CHILD RESTRAINT IN FRONT SEAT WITH FRONT PASSENGER AIR BAG.

A child in a rear-facing child restraint installed in the front seat can be seriously injured if the front passenger air bag inflates.

Secure a rear-facing child restraint in the rear seat.

A front-facing child restraint should be secured in the rear seat whenever possible. If installed in the front passenger seat, adjust the seat as far back as it will go.

⚠ CAUTION

Exhaust gases could enter the vehicle interior.

Cover the unused anchor holes with the supplied plug or suitable bolts.

NOTE

Since a safety belt or child restraint system can become very hot if it is left in a closed vehicle, be sure and check the seat cover and buckles before placing a child there.



⚠ WARNING

Loosely secured child restraint system can cause serious injury.

- Tighten anchor bolt firmly.
- Anchor bolt must be engaged at least 5 full threads in the anchorage.
- Adjust restraint system as firmly as possible.
- Never use infant carrier or child safety seat that hooks over a seat back.

⚠ CAUTION

Unused child restraint system could move forward.

Remove child restraint system if not in use, or secure it with safety belt.

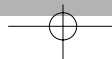
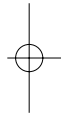

Installation of the attaching clip

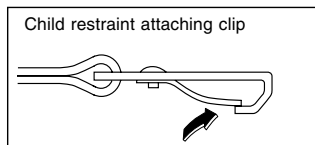

Positive engagement of the child restraint attaching clip is achieved by depressing retainer spring and then opening of the anchor fitting as shown in the illustration.

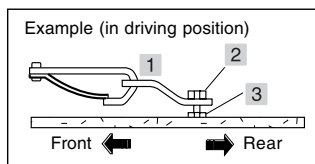

Method of installation of anchor engagement

1. Child restraint anchor fitting
2. Attachment bolt
3. Lock washer

A 5/16"-UNC-2B-bolt with a thread length of 30 mm is used to attach the anchor fittings to the vehicle anchorage.

For fitting advice, please contact your authorized Ssangyong dealer.

⚠ WARNING

Child restraint anchorages are designed to withstand only those loads imposed by correctly fitted child restraints. Under no circumstances are they to be used for adult seat belts or harnesses or for attaching other items or equipment to the vehicle.

⚠ WARNING

- When installing a child restraint system, follow the instructions provided by the manufacturer.
- When not in use, keep your child restraint system secured with a seat belt or remove it from the vehicle.
- Do not hold a child while riding in a vehicle.
- Never let a child stand or kneel on any seat.
- Do not allow a child in the cargo areas while the vehicle is moving.
- Children who have outgrown child restraint systems should sit in the rear seat and be restrained with the seat belt.

If child's seating position has a shoulder belt which is on or very close to the face or neck, move the child close to the center of the vehicle, slightly inboard of the shoulder belt, or move the child to a position without a shoulder belt if possible.

Child Safety Rear Door Lock

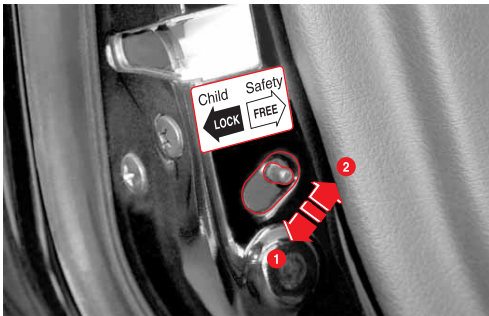

When the child safety lock lever is in "LOCK (1)" position, the rear doors can only be opened from the outside. When it is moved to "FREE (2)" position, the door lock is released.

⚠ WARNING

Move this lever to "LOCK (1)" position whenever children are present in the rear seats. This prevents children from opening the rear door.

AIR BAG

Driver's Air Bag

The driver's air bag is located at the center of the steering wheel.

Side Air Bag

The side air bag is located at the outer corner of the seatback of the front seats.

⚠ WARNING

- The air bag system serves as supplement to the seat belt. Make sure you and your passengers always wear seat belts properly, even if air bags are installed in the vehicle.
- Even if a seat is not occupied, air bag is triggered in an accident that meets the deployment requirements.

Pretensioner (for Front Seat)

When a severe frontal impact occurs, seat belt pretensioners rewind the seat belts immediately to restrain the occupants to their seats. It helps the effective operation of the seat belts and airbags. The load limiter is integrated into each seat belt pretensioner.

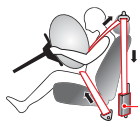

Pretensioner Activation

The seat belt pretensioners remove slack from the driver and passenger front seat belts during a frontal impact.



Load Limiter Activation

Immediately after a collision, they loose the belts to prevent from injuring the body from the belt's pressure.

Air Bag Warning Light



If this lamp does not go out after engine starting or comes on while driving, it means that there is a malfunction in the system. Have the air bag system checked immediately at the nearest Ssangyong Dealer or Ssangyong Authorized Workshop.

Passenger's Air Bag

The front passenger's air bag is located on the dashboard.

CAUTIONS WITH THE AIR BAG

Side Air Bag Operation

► **The air bag inflates when:**

- Strong side frontal impact exceeding the operation conditions. (intensity, angle, speed and position)

► **The air bag can inflate when:**

- Vehicle rolls onto its side and causes a severe side impact.

► **The air bag does not inflate when:**

- Frontal collision while vehicle stops or is moving at a low speed.
- Rear end collision
- If the severity of impact to the vehicle is not significant.

► **The air bag seldom inflates when:**

- Oblique impact (diagonal direction)
- Frontal impact or rear impact
- Rollover but without a severe impact
- The air bag warning lamp is on

AIR BAG INSPECTION

The air bag system should be inspected 10 years from its installation regardless of its appearance and other conditions.

Front Air Bag Operation (Driver's and Passenger's)

► **The air bag inflates when:**

- The seat belt can't protect occupants from a severe frontal collision.

► **The air bag can inflate when:**

- Underbody impact from the road surface; impact against the curb at a very high speed; dropping impact onto the road surface with a large angle

► **The air bag does not inflate when:**

- Rollover, side impact or rear impact
- If the severity of impact to the vehicle is not significant.

► **The air bag seldom inflates when:**

- Oblique impact, rollover
- Weak impact in which the sensor is unable to detect (under the inflation requirements)
- Impact against narrow objects such as a utility pole or a tree
- The vehicle falls into a drainage or a puddle
- The front of the vehicle crashes into high-impact point vehicle such as a vehicle.
- Impact on the hood by falling stones
- The air bag warning lamp is on
- Moderate or severe impact to the middle of the vehicle body's side structure. In that case, only the side air bags deploy.

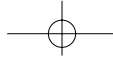

WARNINGS FOR AIR BAG

- Do not diagnose the circuit with a circuit tester. Do not attempt to modify any air bag components including the steering wheel, air bag mounting area, and harness.
- Do not impact any air bag components including the steering wheel, air bag mounting area, and harness by hand or tools. You may get injured by sudden deployment.
- The air bag components will be very hot after deployment. Do not touch them.
- Once the air bag system is triggered, the triggered air bag assembly should be removed from the vehicle and replaced with new one.
- The air bag contains explosive materials, so contact the Ssangyong Dealer or Ssangyong Authorized Workshop when trashing or replacing it.
- Incorrect air bag inspection can be dangerous and cause injuries. The air bag system must be disposed only at the nearest Ssangyong Dealer or Ssangyong Authorized Workshop.
- Replace the steering wheel with only Ssangyong genuine part.
- When the engine starts, the air bag warning lamp comes on for a system check. It goes out after 6 seconds when the system is normal. If this warning lamp stays ON, then the system may be defective. Have the air bag system checked immediately at the nearest Ssangyong Dealer or Ssangyong Authorized Workshop.
- The seat belt and air the bags are the most effective when you are sitting well back and upright in the seat.
- A child restraint system must not be placed on the front seat. The infant or child can be severely injured by an air bag inflation in case of an accident.
- Do not carry your child on your lap while driving. You cannot resist against the impact pressure in an accident. The child could be crushed between you and the parts of the vehicle.
- Do not place any objects on the air bag inflation location. You may get injured by those objects during deployment.
- Do not attach any objects such as a sticker, scent bottle, or phone holder on the steering wheel pad and to the dashboard.
- Do not move your seat too close to the steering wheel or dashboard. If you lower your head, the air bag can hit your head during inflation and can cause severe injury or even death.
- Hold only the outer rim of the steering so that the air bag can inflate without any hindrance.
- Do not place your face or chest near the steering wheel and dashboard. Also, do not allow anyone to place their hands, leg or face on the dashboard. The air bag cannot work properly.

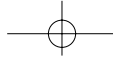

WARNINGS FOR AIR BAG

- Do not hold and operate the steering wheel by crossing your arms. You could get seriously injured when the air bag deploys.
- When the air bag inflates, it makes a loud noise and smoke. However, the smoke is a non-toxic nitrogen gas.
- When the air bag is deployed, non-toxic gas will come out. This gas may cause skin, eyes or nose irritation. Wash it out with cold and clean water and consult the doctor if irritation continues.
- When any repairs are needed for the steering wheel, or when an accident occurred without the air bag deployment, have the air bag system checked at the nearest Ssangyong Dealer or Ssangyong Authorized Workshop.
- The windshield glass may be broken when the passenger's air bag is deployed.
- The air bag deployment can cause abrasion on your hands and face.
- The air bag system does not need to be inspected. However, it must be replaced in the 10th year from the installation.

Locations of Air Bag Warning Label

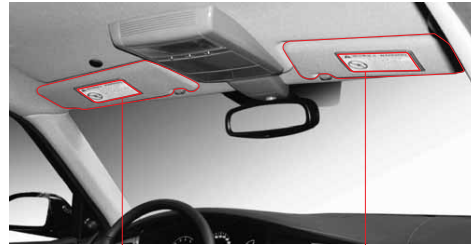

WARNING STATEMENT:

“Extreme Hazard! Do not use a rearward facing child restraint on a seat protected by an airbag in front of it.”

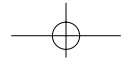

⚠ WARNINGS FOR AIR BAG

**Locations of Air Bag Warning Label
(Australia Only)**



WARNING STATEMENT:
"Extreme Hazard! Do not use a rearward facing child restraint on a seat protected by an airbag in front of it."



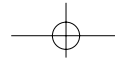

TABLE OF CONTENTS

Climate Control System 9-2

- Air Flow Directions 9-2
- Air Vent 9-4
- Operation Tips for the Air Conditioner 9-5

Air Conditioner 9-6

- Automatic Air Conditioner Control Panel 9-6
- Automatic Operation Mode 9-6
- Manual Operation Mode 9-6
- Air Conditioner Auto/Off Switch/VFD 9-7
- Fan Switch 9-8
- Mode Switch 9-9
- Air Source Mode 9-10
- AMB Switch 9-12
- Defogger Switch 9-12
- Replacing A/C Filter 9-13



Section 9

**Ventilation, Heating
and Air Conditioning**

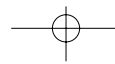

CLIMATE CONTROL SYSTEM

AIR FLOW DIRECTIONS

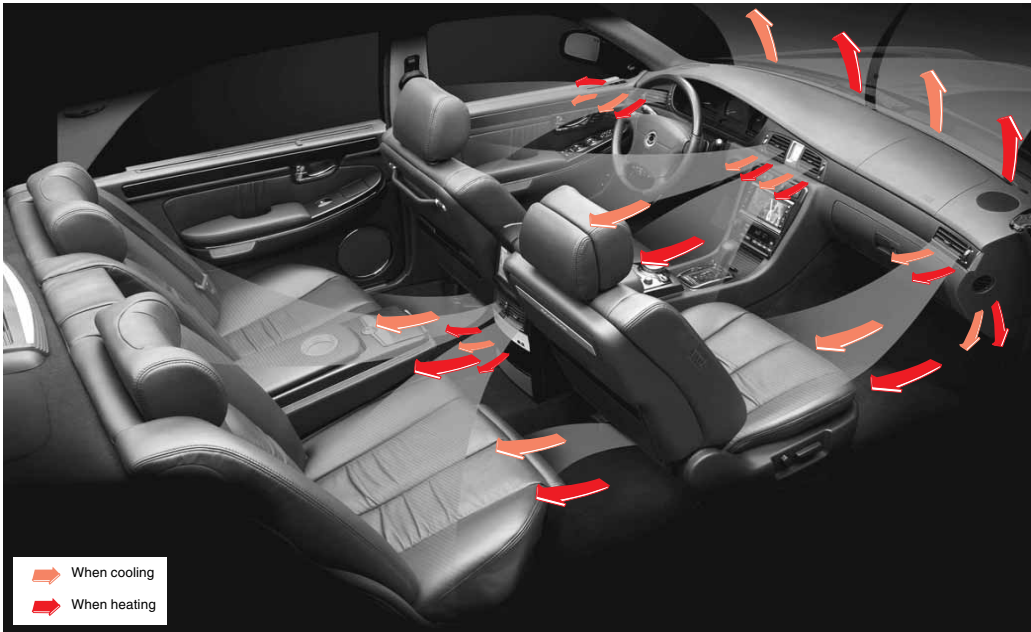

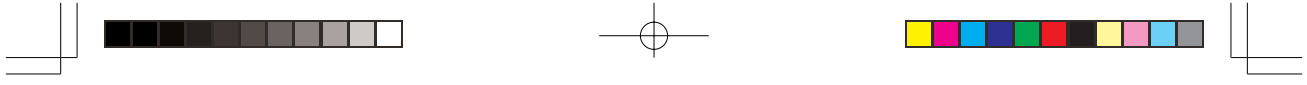

AQS & ambient sensor

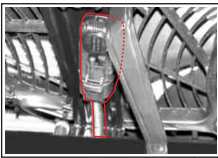

Front center air vent

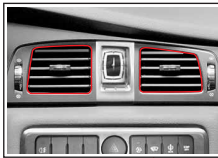

AUTO A/C control panel



Rear vent

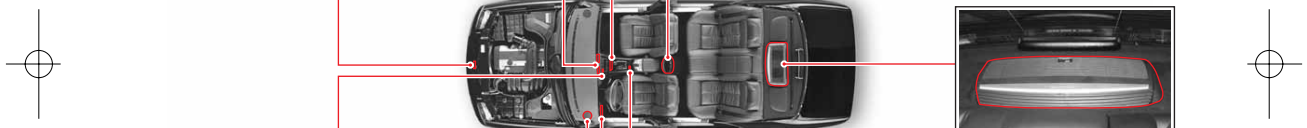
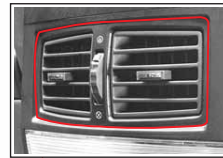

Air purifier



AQS switch



Sun sensor

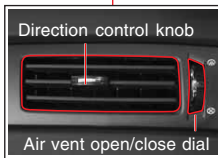

Side air vent (front)



VAPS switch

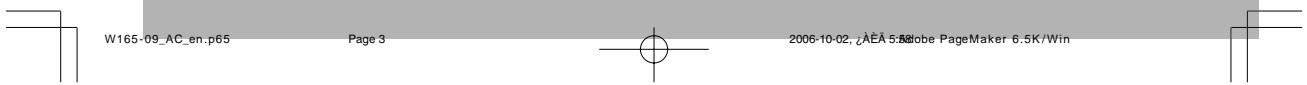

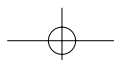

AIR VENT

Front

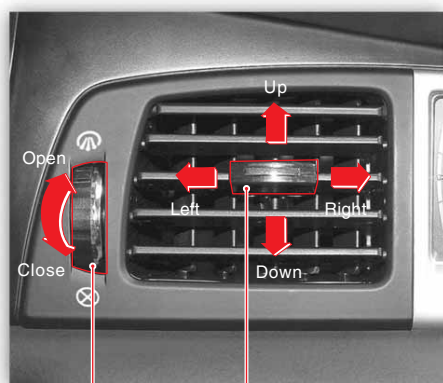

Direction control knob

Air vent open/close dial

Rear

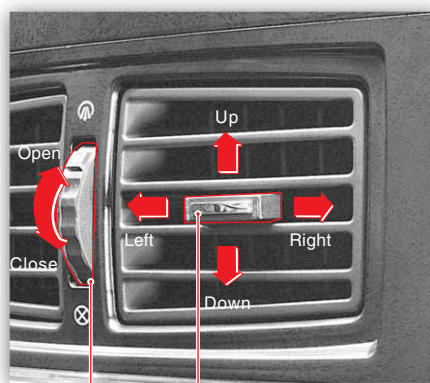

Direction control knob

Air vent open/close dial

CAUTION

Cautions for cleaning interior

- Never use acetone, lacquer, enamel or decolorant to clean the interior.
- Never place a liquid air freshener on the instrument panel or armrest near the air vents. Liquid air freshener may damage when spilled over instrument panel, armrest pad, and the air vents. When spilled, clean it with water immediately.

OPERATION TIPS FOR THE AIR CONDITIONER

Refrigerant Specification & Capacity

Item	
Specification	R134a
Capacity	700 ± 50g

⚠ WARNING

- If you sleep while air conditioner or heater on with all windows closed. You may be suffocated to death.
- Continued operation in recirculation mode may cause interior to become stuffy and windows to fog. Use recirculation mode for a short period of time, and when driving through an area of smoke or fume. Be sure to switch back to fresh air mode after passing through an area of smoke or fume.
- Never leave a child or the handicapped person alone in a vehicle with the air conditioner or heater on in hot or cold weather. Child or the handicapped person can be in serious danger by the heat and lack of oxygen.

⚠ CAUTION

- If your vehicle has been parked in direct sunlight, open all windows to extract heat before turning on the air conditioning (A/C).
- Operating the air conditioning (A/C) for a long time while the vehicle is parked which may cause the engine to overheat.
- During driving up long hills, turn on and off the air conditioning (A/C) every 3 ~ 5 minutes.

⚠ CAUTION

- To prevent battery from discharge, do not run the fan for an extended period of time when the engine is not running.
- To maintain the system to its optimum state and to keep the lubrication of the air conditioner compressor and related components, run the air conditioner in low speed once a week.
- It may produce an unpleasant odor trapped in the duct. Be sure to turn the fan off in fresh air mode for a few minutes prior to shutting the engine off.
- If you start the engine when the A/C is ON, the engine may not start easily and the engine idling can be unstable causing vehicle to vibrate. Be sure to turn off every electrical system such as fan and electrical accessories.
- When the air conditioner is not used in periods, odors will come out. Run the air conditioner for 20 ~ 30 minutes with the windows opened and you could remove the odors.
- During the winter time when the air conditioner is not used regularly, run the air conditioner once or twice every month for 5-10 minutes.
- If the air conditioner is not used regularly, the oil in the A/C compressor will not circulate causing the A/C to malfunction. Be sure to turn the air conditioner in low speed.
- When sharply accelerating the vehicle while the air conditioner is operating, you may hear a "click" sound from the magnetic clutch in compressor. This is a normal operation to protect the air conditioner system (by lowering the excessively high refrigerant pressure).

AIR CONDITIONER

AUTOMATIC AIR CONDITIONER CONTROL PANEL

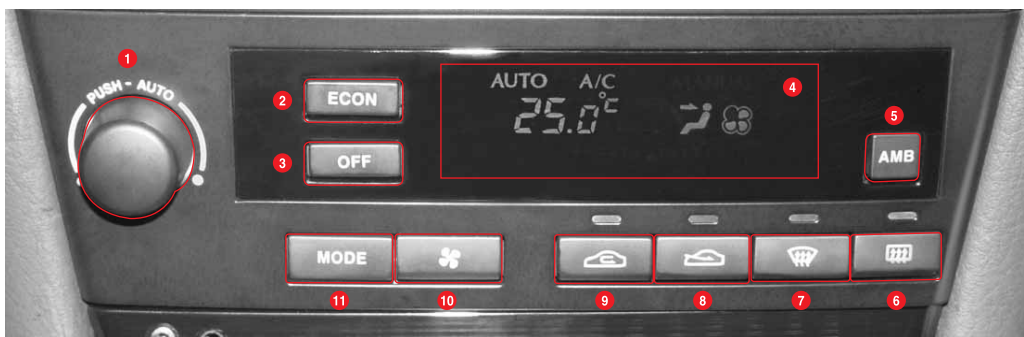

1. Temperature control dial and AUTO switch
2. ECON switch
3. OFF switch
4. Vacuum Fluorescent Display (VFD)

5. AMB(Ambient temperature) switch
6. Rear glass defogger switch
7. Defrost switch
8. Fresh air intake switch

9. Recirculation switch
10. Fan switch
11. Mode switch

AUTOMATIC OPERATION MODE

When pressing the AUTO button, **AUTO** indicator on the display comes on and the in-vehicle temperature is automatically maintained according to the set temperature.

Pressing the AUTO button in the manual operation mode shifts the system into the automatic operation mode.

MANUAL OPERATION MODE

Using the fan speed control switch, mode switch or the defrost switch during the automatic operation mode activates the **MANUAL** indicator on the display and the heater/air conditioner system can be controlled manually.

AIR CONDITIONER AUTO/OFF SWITCH/VFD

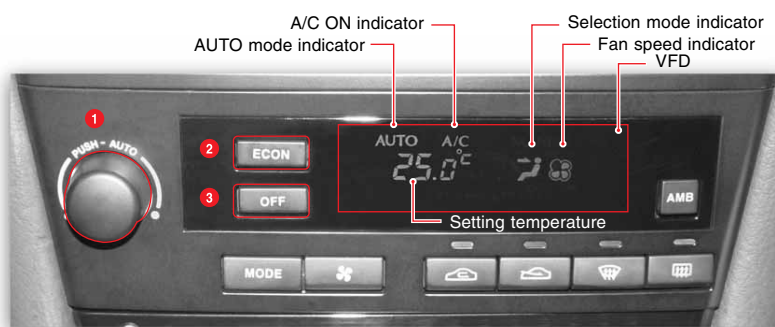

1. A/C Auto And Temperature Control Switch



Pressing this switch lights up the **AUTO** indicator on the display. The air flow and air vent will be automatically controlled according to the desired temperature.

To set the desired temperature, turn the dial toward left (low temperature) or right (high temperature).

⚠ CAUTION

- With "AUTO" mode, fan speed, air flow and air vent will be automatically controlled according to the desired temperature.
- Avoid turning temperature control dial unnecessarily if you already have set the temperature. It will take longer to reach temperature.

2. ECON Switch



Pressing this switch turns the air conditioner on, with the A/C indicator appearing on the display. To turn it off, press the switch again. The indicator on the display goes out.

3. OFF Switch



Pressing the OFF switch shuts off the air conditioning system including the display.

FAN SWITCH



When in AUTO mode, press the fan switch and the MANUAL indicator will lit.

If you press the switch when the system is turned OFF, the adjusted temperature, air flow mode, fan speed and MANUAL indicator will be displayed on the VFD.

Press the switch to select the desired fan speed of 1, 2, 3 and 4.

NOTE

- When the AUTO dial switch is pressed initially, the fan speed can be very high due to differences between set temperature and ambient temperature.

Fan Speed Selection



CAUTION

- If the air conditioner switch is turned off, the air conditioner does not work even when the fan switch is operated. However, the air will flow due to fan operation.
- To prevent battery discharge, do not run the fan for over extended period of time if engine is not running.
- The actual fan speed will be changed on the VFD by pressing the fan speed switch.

Fan Switch



Press the switch to select the desired fan speed of 1, 2, 3 and 4. The indicator on the display toggles as above.

Pressing this switch turns off the **AUTO** indicator on the display and the air source selection is switched to the manual operation.

MODE SWITCH

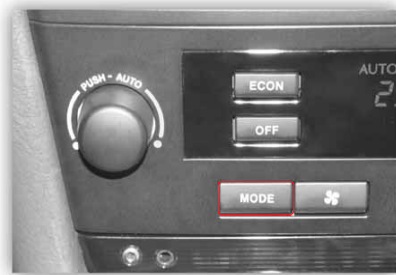

MODE Switch

MODE

Every instance of pressing this switch toggles the air flow mode. Pressing this switch during the auto air conditioner operation ("AUTO" indicator ON) converts the system into the manual air conditioner mode ("AUTO" indicator OFF).

* When in AUTO mode, Vent mode will be selected. For detailed air flow mode, see "air flow directions".

Selecting Air Flow Mode (By pressing **MODE** switch)

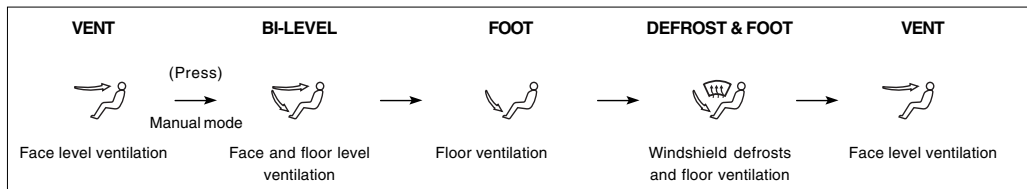

AIR SOURCE MODE



Automatic air source selection

1. When the VAPS is in operation, the air source selection is switched between the recirculation mode and fresh air mode depending on the air pollution level.
2. Pressing the defrost switch () shifts the air source selection to the fresh air mode. Pressing the switch again shifts you back to the previous mode.

Manual Selection of Air Source

Recirculation mode

Press the recirculation mode switch () (The indicator will lit).

Fresh air intake mode

Press the fresh air intake mode switch () (The indicator will lit).

CAUTION

Use the recirculation mode for a short time to prevent outside polluted air to enter cabin. Use fresh air mode during normal driving.



AMB switch

Pressing the **AMB** switch makes the display show the ambient temperature for 5 seconds.

⚠ CAUTION

The value shown on the display may differ from the actual temperature due to the heat from the engine or ground.

Defrost Switch

The  switch directs the main air flow to the windshield for faster defrosting. It also overrides any Mode selection you may have made.

When you select this switch, the A/C turns on automatically and the system selects Fresh Air mode. The adjusted temperature, A/C, Defrost indicator and fan speed will display, and the indicator above the switch will lit.

Defrost switch

Use this switch for quick defrosting. When you press this switch, the airflow direction will be changed to the windshield and door glasses, the air conditioner operates automatically, and air from the outside comes in. Pressing the switch again during its operation returns the operation back to normal.

Inside of the Windshield

1. Press the defroster switch.
2. Adjust the fan speed with the fan speed control.
3. To quickly remove the moisture on the glass, set the fan speed button at a high speed position.
4. To prevent fog from forming on the glass, setting the air source selection switch to the fresh air intake mode is recommended.

Outside of the Windshield

1. Press the defroster switch.
2. Adjust the fan speed with the fan speed control.
3. To quickly remove the frost on the glass, set the fan speed button at a high speed position.
4. Set the temperature control switch to a hot position.

⚠ WARNING

With rain or highly humid condition, windshield or other windows get fog even when the air conditioner is working. If windows are foggy, it is dangerous to drive because of poor frontal and side visibilities. In this case, select fresh air intake mode and air flow mode switch to vent ().

AMB SWITCH



If you press the AMB switch, it will show you the ambient temperature for 5 seconds. It will be returned to its original display after displaying the temperature.

If you press the AMB switch again during its ambient temperature display, it will be returned to its original display.

NOTE

If you press the AMB switch even when the air conditioner system is turned off, the ambient temperature shows up for 5 seconds on the display.

DEFOGGER SWITCH



If you press the defogger switch, the integrated heated wire in the rear glass, outside rear view mirror and windshield (RHD model only) operates for 12 minutes then shuts off automatically. When in use, the indicator above the switch comes on.

If you press the switch again during its operation, the heated wire stops heating and the indicator goes off.

When you turn on the switch again within 10 minutes after defogging for 12 minutes, the system will only operate for 6 minutes.

REPLACING A/C FILTER

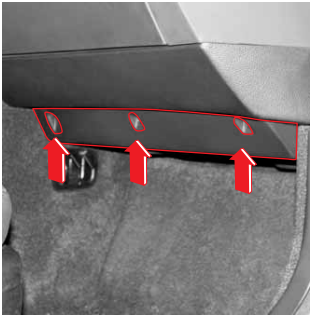

1. Remove the three screws at the bottom of the glove box and remove the cover.

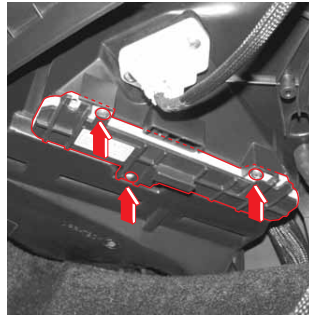

2. After removing the cover three mounting bolts of the A/C filter.

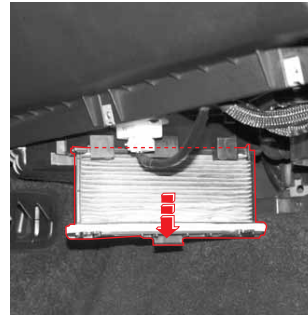

3. Remove the A/C filter and replace it with the Ssangyong genuine part.
4. Install the filter in the reverse order of removal paying attention to installation instructions (bolt locations).

⚠ CAUTION

- Replace the A/C filter every 10,000km.
Driving under dusty roads, off-roads or excessive air conditioner or heater operation may shorten the life span of A/C filter.
- When the filter is contaminated, it will decrease the cooling capacity of the system and creates unpleasant odors.

TABLE OF CONTENTS

Convenience Devices	10-2	Others	10-17
Storages	10-3	Power Outlet and AV Jack*	10-17
Front Door Map Pocket	10-4	Card Holder	10-17
Glove Box	10-4	TV Tuner and Navigation System*	10-18
Front Console & Armrest	10-5	Coat Hanger (Without Sunroof)	10-18
Seatback Pocket	10-5	Rear Vanity Mirror*	10-19
Analog Clock*	10-6	Power and Manual Inside Rearview Mirror	10-20
Front Cup Holder and Ashtray Holder	10-7	Rear Defogger and Antenna	10-21
Front Cigarette Lighter and Ashtray Holder	10-8	Ticket Holder	10-21
Sunglasses Box (Without Sun Roof)	10-9	Dual Sun Visor with Vanity Mirror*	10-22
Pen Storage (Without Sun Roof)	10-9	Coat Hanger (Without Sunroof)	10-22
Rear Center Console	10-10	AV/Navigation System*	10-23
Foot Rest*	10-10	Changer and Navigation Unit	10-24
Rear Console	10-11		
Rear Armrest	10-11		
Rear Armrest and Switch Panel	10-12		
Table for Rear Seat Occupants*	10-12		
Rear Cup Holder	10-13		
Rear Cup Holder/Ashtray Holder	10-14		
Rear Console Box	10-14		
Rear Cigarette Lighter	10-15		
Rear Door Roller Blind*	10-15		
Foot Rest	10-16		
Seatback Pocket	10-16		

Section 10 Storage and Convenience Devices

CONVENIENCE DEVICES

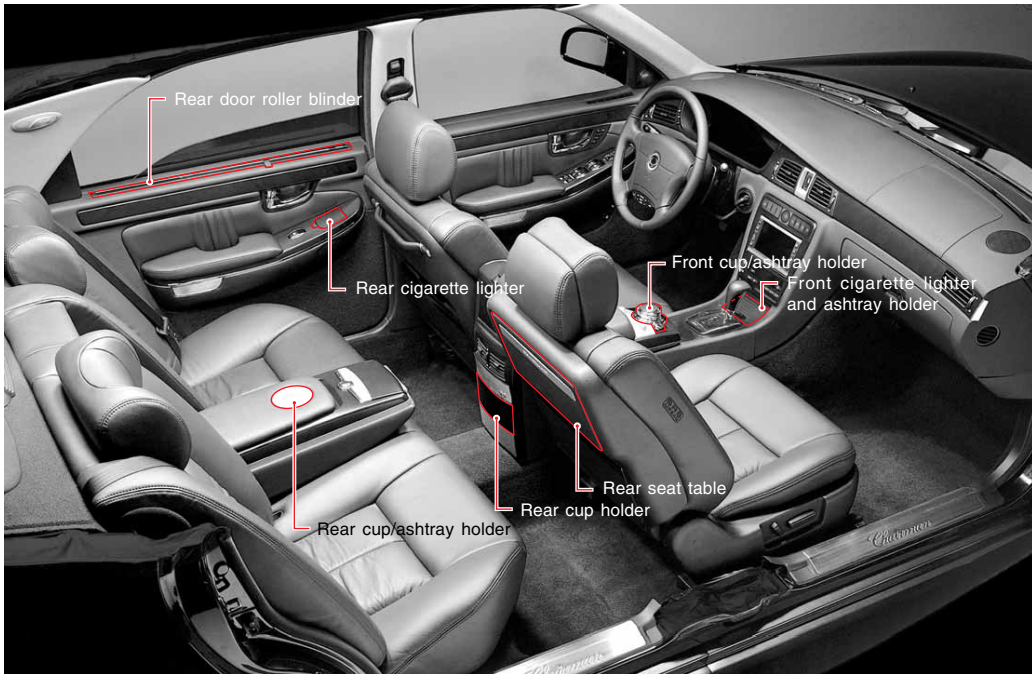

10-2 STORAGE AND CONVENIENCE DEVICES

NEW CHAIRMAN

STORAGES

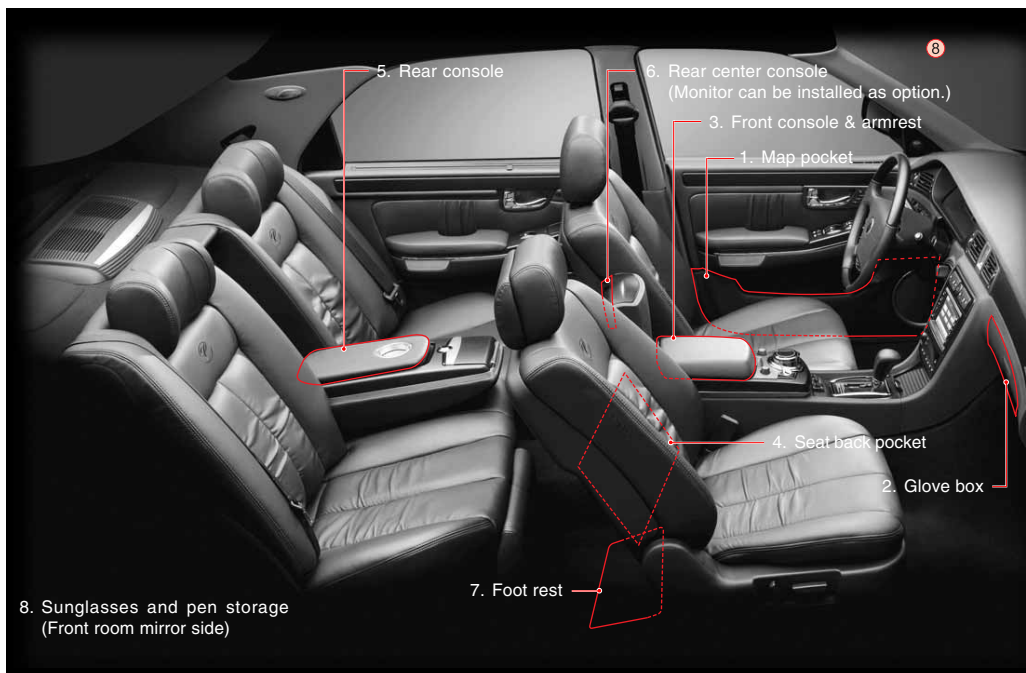

NEW CHAIRMAN

STORAGE AND CONVENIENCE DEVICES

10-3

FRONT DOOR MAP POCKET

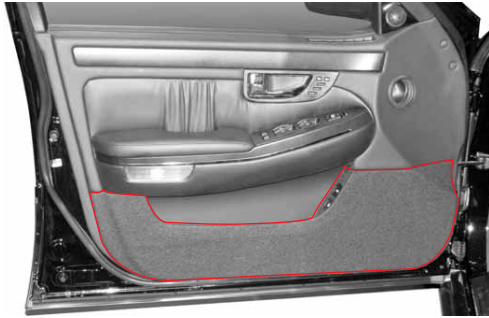

The map pocket is located on each front doors.
Map, magazine, newspaper and others can be stored.

GLOVE BOX

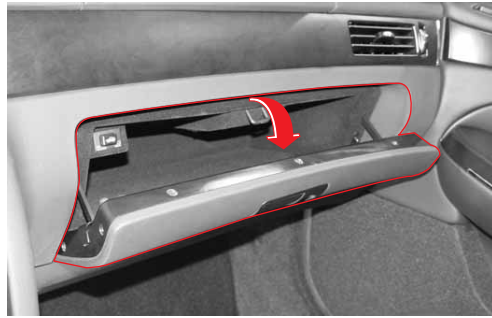

Pull on the lever to open the glove box. Camera and sunglasses can be stored.

To prevent the valuables from being stolen, set the trunk lid selection switch to **LOCK** position and lock the glove box with key.

CAUTION

- Driving with glove box lid open can cause injury in case of an accident or a sudden stop. Keep glove box lid closed while driving.
- Do not store any flammable items or disposable lighter in the console box or other space. In hot weather, they can explode and cause a fire.
- You can not open the glove box with the secondary key.

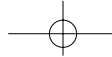

FRONT CONSOLE & ARMREST



- Lift the armrest cover to open. Small items can be stored.
- It can be used as armrest for both driver and passenger.

⚠ CAUTION

Do not store any flammables including disposable lighter in the console box or other space. In hot weather, they may explode and cause a fire.

SEATBACK POCKET



Seatback pocket is on the back of driver and passenger seats. Books and magazines can be stored.

⚠ CAUTION

Do not store any large items in it. The seatback pocket can be deformed.



ANALOG CLOCK*



“+” button: minute pointer turns clockwise

“-” button: minute pointer turns counterclockwise

NOTE

When pressing the button, the pointer moves slowly for first 2 seconds, then moves fast.

FRONT CUP HOLDER AND ASHTRAY HOLDER



The holder lifts up with the button (1) pressed.
This holder can be rotated for passenger.

⚠ CAUTION

- When vehicle is in sudden braking or starting, the liquid may spill.
- Danger of burn! Do not store a cup with hot beverage on the cup holder.
- Do not force to turn the front cup/ashtray holder toward right, or can be damaged due to interference with seat heating switch. Rotate properly not to make interference with surrounding parts.

⚠ WARNING

To avoid danger of fire, do not stock inflammable materials, such as garbage or cigarette butts, in your ashtray and make sure the cigarettes are completely extinguished.

⚠ CAUTION

Do not impact the ashtray LED or wash it with water to avoid any damage. It consists of electronic circuit without waterproof function.

FRONT CIGARETTE LIGHTER AND ASHTRAY HOLDER

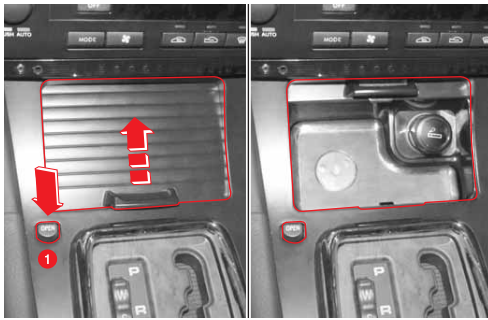

When you press the button(1) in front of shift lever, the cover opens and the ashtray & cigarette lighter appear.

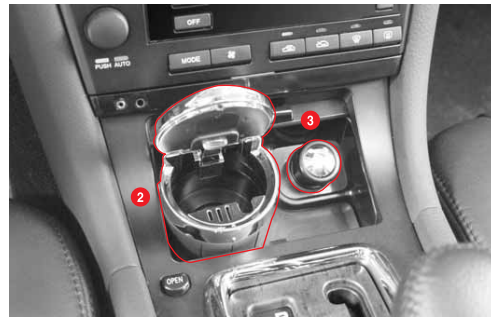

ASHTRAY HOLDER (2)

The area next to the cigarette lighter is for an ashtray attachment.

CIGARETTE LIGHTER (3)

If you press the cigarette lighter, it pops up when the coil is heated. Pull out the cigar lighter and insert back after use and cleaning ash on the coil.

CAUTION

- Do not tap the cigarette lighter strongly to clean it, or it may damage the coil.
- If the cigarette lighter does not pop back by itself when heated, check and replace the cigarette lighter.

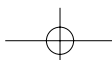

SUNGLASSES BOX (WITHOUT SUN ROOF)

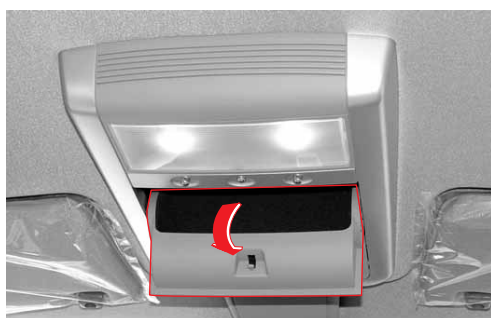

Sunglasses Box

The sunglasses storage is located in the overhead console. Press the top side of the cover to open it.

PEN STORAGE (WITHOUT SUN ROOF)



Pen Storage

The pen storage is located in the overhead console. Press the top side of the cover to open it.

CAUTION

Store oil-based pens only in the pen storage. Water-based pens pose the risk of messy leaks.

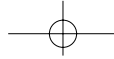

REAR CENTER CONSOLE



There is an extra console in the rear side of front center console. Small items can be stored.
To open, move the knob on the console box (1) toward right.

NOTE

LCD display can be installed instead of rear center console for rear occupants as option.

FOOT REST*

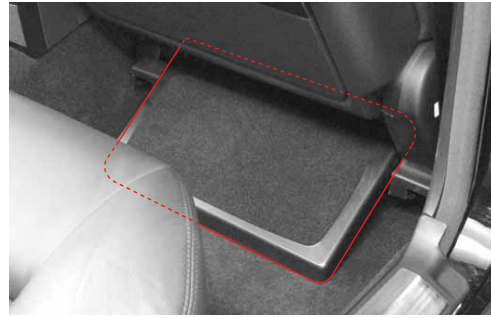

The foot rest for rear seat is installed for the occupant's convenience.

How to use:

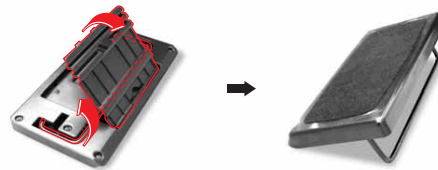

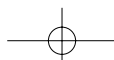

REAR CONSOLE

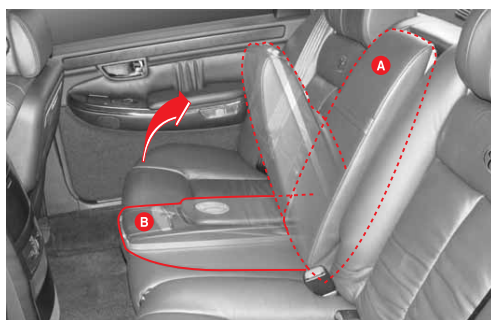

Rear Armrest (A)

Rear center armrest is located in the center of rear seat. Pull down the armrest to use.

Rear Armrest Switch Panel (B)

To open the switch panel cover, press the button on the top of rear center armrest. There are audio and video control switches. For more detailed operation of the switches, see relevant sections and separate audio/multi-vision manual.

REAR ARMREST

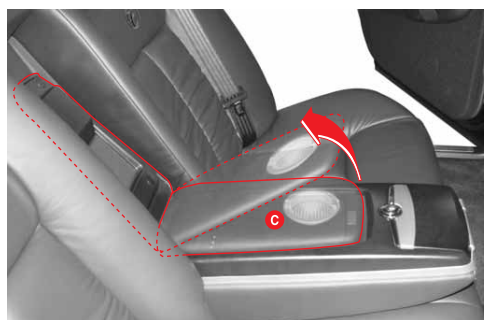

Rear Console Box (C)

Pull up the center armrest's cover to open and you may store the small items in it (Power outlet and AV jack is installed inside of the rear console).

REAR ARMREST AND SWITCH PANEL

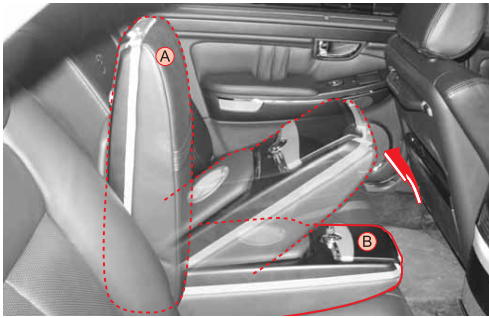

Rear Armrest (A)

The rear center armrest is located in the center of the rear seat. Pull down the armrest to use it.

Rear Armrest Switch Panel (B)

To open the switch panel cover, press the button on the top of the rear center armrest. There are audio and video control switches. For more information on the switches, refer to the relevant sections and the audio/multi-vision manual provided separately.

CAUTION

Folding up the rear center armrest with the switch cover open may damage the switches. To use the armrest as a seatback, close the cover first, and then fold the armrest up.

TABLE FOR REAR SEAT OCCUPANTS*



A table is on the rear of the passenger's seat for temporary jobs while the vehicle is stopping and putting on goods for rear seat occupants.

NOTE

It is installed on the rear of the passenger's seatback and hand grip is installed if equipped with manual seat.

How to Use the Table

1. Push the stabilizer lever inside the table and release it. Pull the bottom part of the table slightly and then lift it up.

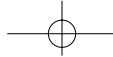

2. Unfold the table to use.

⚠ WARNING

- Do not place any heavy objects or attempt to lean on the table.
- Do not use the table when the vehicle is in motion.

REAR CUP HOLDER

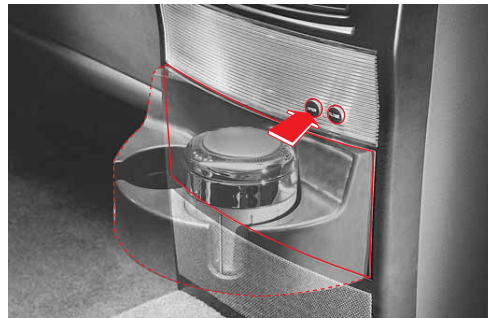

The cup holder inside the console appears by rotating when the **OPEN** button on the rear of the center console is pressed. Store beverage cup or can. Press the **CLOSE** button to return to original position.

⚠ CAUTION

- When vehicle is in sudden braking or starting, the liquid may spill out.
- Hot beverage can cause personal injury.
- Keep the cup holder closed if not use.

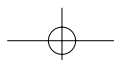

REAR CUP HOLDER/ASHTRAY HOLDER



A holder that can store cup or ashtray is on the upper of the rear center armrest.

Cup and ashtray holder appears when sliding the cover rearward.

CAUTION

- When vehicle is in sudden braking or starting, the liquid may spill out.
- Spilled liquid can cause any personal injury if it is hot.

REAR CONSOLE BOX

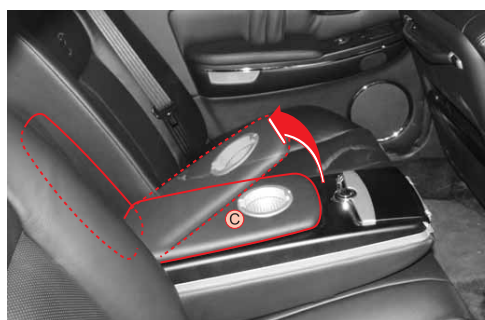

Pull up the center armrest's cover to open it. You can store small items in it (the power outlet and the AV jack are installed in the console box).

REAR CIGARETTE LIGHTER

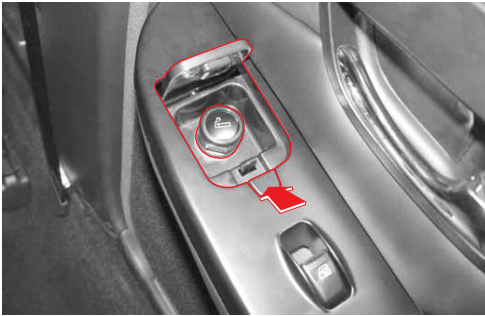

Press the button on the door armrest, then the cover opens and cigarette lighter appears.

If you press the cigarette lighter, it pops up when the coil is heated. Pull out the cigar lighter and insert back after use and cleaning ash on the coil.

CAUTION

- Do not tap the cigarette lighter strongly to clean it, or it may damage the coil.
- If the cigarette lighter does not pop back by itself when heated, check and replace the cigarette lighter.

REAR DOOR ROLLER BLIND*

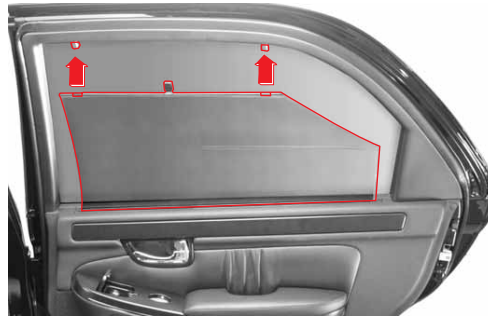

The rear door roller blinds will be operated manually. Hold the lever and then raise it up to the holding hook and fix on it.

When you do not want to use it, lift out the fixing hole from the holding hook and lower it to its end by holding it.

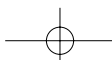

FOOT REST

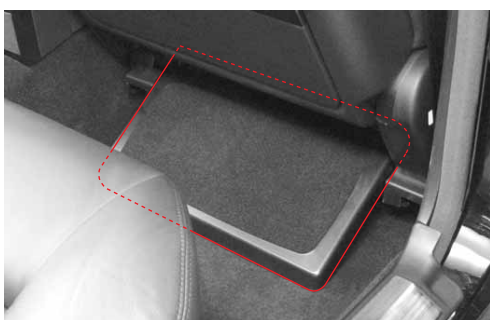

The foot rest for the rear seat is installed for the occupant's convenience.

How to use:

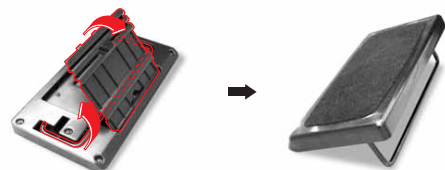

SEATBACK POCKET



The storage pockets are installed at the rear side of front seats. Use it for storing personal belongings.

CAUTION

Do not store any large items in the seatback pocket, which may deform it.

OTHERS

POWER OUTLET AND AV JACK*

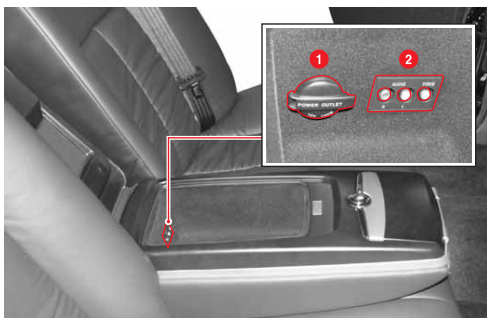

Power outlet (1) can supply power for automotive accessories in the rear console box. AV jack (audio and video terminals) (2) can connect with camcorder, digital camera and joy stick.

CAUTION

- Turn the ignition switch to "ACC" or "ON" to use the power outlet.
- Battery can be discharged if use power outlet excessively when the engine is not running.
- Keep the power outlet cover closed if not in use. There can be electrical defect if insert objects other than power outlet plug or water comes in.
- Keep the power outlet cover closed if not in use. It may cause an electric shock if any foreign material is entered into the power outlet.
- Use only the prescribed rating of 12V/120W.

CARD HOLDER

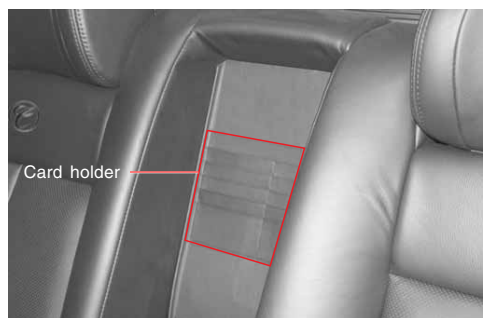

A card holder is located behind the rear armrest. To use it, pull down the armrest.

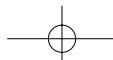

TV TUNER AND NAVIGATION SYSTEM*

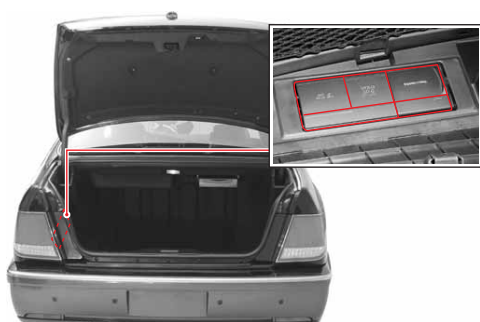

TV tuner and navigation system is installed on the upper part of the trunk. For more information, see separate multi-vision and navigation system manual.

CAUTION

To use the navigation system, insert only map CD. Audio CD, VCD or MP3 CD may damage the system.

COAT HANGER (WITHOUT SUNROOF)

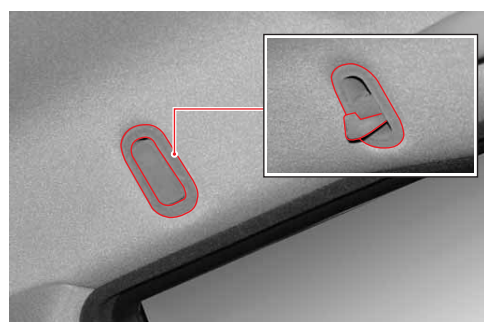

Coat hooks are locked on both left and right side of the rear seat.

To use coat hooks, push on the lid. Close it with a firm push. Make sure the coat hook is closed when you are not using it.

REAR VANITY MIRROR*

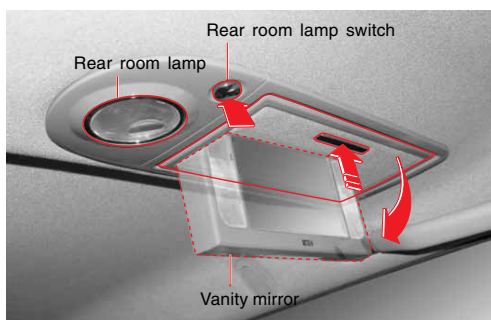

To use rear vanity mirror, push on the "PUSH" metal button. It will unlatch and swing down. The both lights come on.

Keep the mirror closed when not in use.

Pressing down the rear room lamp switch activates the rear room lamp. Pressing the switch again turns it off.

INSIDE REARVIEW MIRROR



Manual Operation

Hold and adjust the mirror to find the best rearview.

► Day time use

Push forward the lever on the mirror.

► Night time use

Push aft the lever on the mirror.

⚠ WARNING

For your safety, never adjust the inside rearview mirror while the vehicle is in motion.

Power Operation

For the adjustment of the interior rearview mirror, refer to the "Outside rearview mirror/Inside rearview mirror adjustment" in this manual.

► Memory setting

Refer to the "To store the memory settings" in this manual.

► Anti-glare auto adjustment function (ECM mirror)

The inside mirror can automatically darken to reduce glare. When it is on, the mirror darkens when it senses the headlamp of a vehicle behind you.

⚠ CAUTION

Under following conditions, automatic anti-glare function may not operate properly.

- When rear vehicle's headlamp light is not beamed directly to the inside rearview mirror's sensor.
- When rear window has dark tinted glass.
- When a trailer is connected.
- When the shift lever is positioned in **R**, automatic anti-glare function will be cancelled for a better rear viewing.

⚠ WARNING

- The electrolyte may come out when the mirror is broken. Do not allow it to contact your skin or eyes. If you accidentally get it in your eyes, flush with water and see your doctor.
- For your safety, never adjust the mirror while the vehicle is in motion.

REAR DEFOGGER AND ANTENNA

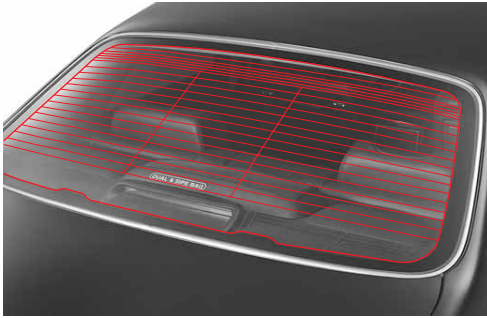

Glass antenna (for FM and AM) is on the upper and lower section of the rear window and the heating grids are on the center section of the rear window.

Be careful not to damage the heating grids and antenna while cleaning inside of the rear window.

CAUTION

Do not coat the rear window with commercial anti-glare film. When the metal anti-glare film and two-tone anti-glare film is used, the sensitivity of the heating grids and antenna can be deteriorated. Especially, the GPS antenna is locating on the lower of the rear window if equipped with navigation system and its receiving sensitivity can be damaged.

TICKET HOLDER

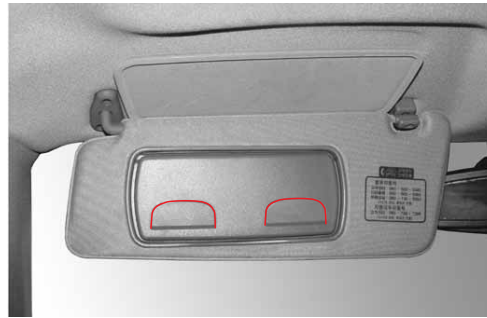

The ticket holder is located behind the main sun visor.

DUAL SUN VISOR WITH VANITY MIRROR*

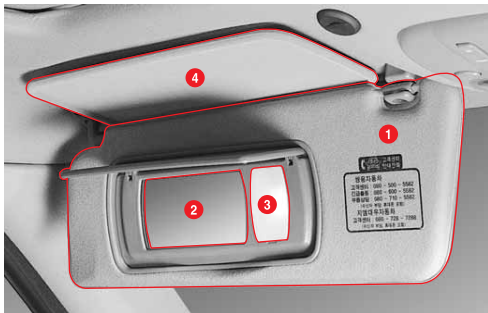

- 1. Main sun visor
- 2. Vanity mirror
- 3. Lamp
- 4. Secondary sun visor

Main Sun Visor

Pull the sun visor down or to the left (right), if necessary.

Secondary Sun Visor

Swing the main sun visor to the left (right) and pull the secondary sun visor down. It allows glare from the side and front to be blocked at same time.

Vanity Mirror and Lamp

Swing the sun visor down and open the cover to reveal the mirror and turn on the lamp.

COAT HANGER (WITHOUT SUNROOF)

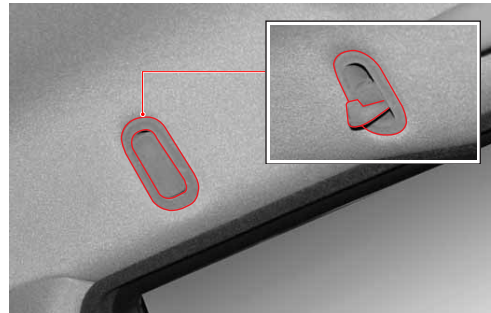

The coat hangers are located on both sides of the rear seat. To use the hangers, push on the lid. Make sure the coat hanger is closed when the hanger is not in use.

AV/NAVIGATION SYSTEM*

Audio/video head unit & front monitor



Rear monitor



Navigation unit

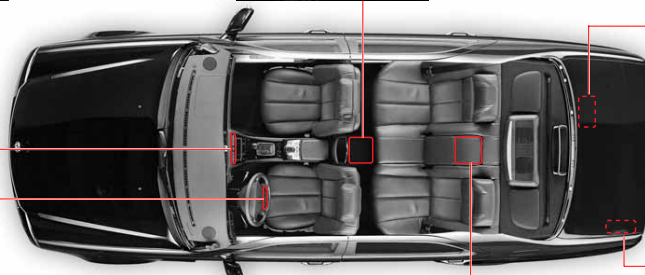

Audio remote control switch on steering wheel



Rear seat control switch panel



Changer

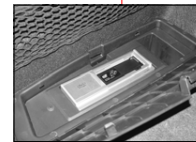

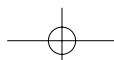

CHANGER AND NAVIGATION UNIT



The changer is installed in the left bottom in the trunk and the navigation unit is installed in the trunk's upper side. For more information, refer to the navigation operating manual.

CAUTION

Insert only the MAP DVD to the navigation system. Inserting other types of discs such as music CD, MP3 CD, or other DVD may damage the navigation unit.

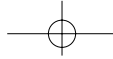

CAUTIONS WHEN USING AUDIO/VIDEO SYSTEM

- An illegal copy of a CD/DVD may cause a malfunction in the audio/video head unit and abnormal replay. Use only original CD/DVDs.
- Incompatible discs may cause a malfunction in the system. Use only compatible discs.
- The back of the front monitor is very hot. Do not touch the back when opening the monitor.
- Do not use the audio/video/navigation system for a long time when the engine is not running. The battery could discharge.
- Be careful not to spill water on the unit or to let any foreign objects into the system through the opened monitor.
- Do not apply excessive force to adjust, open, and close the monitor. Do not impede the automatic movement of the unit. It may cause a malfunction.
- Do not apply any impacts and pressure to the monitor screen. The LCD panel or touch screen panel can be damaged.
- When cleaning the touch screen, turn off the system and clean the surface with a dry and soft cloth. Never use a coarse cloth, hard cloth, chemical agent, or volatile cleaning solvent (alcohol, benzene, thinner) for cleaning the touch screen. The screen surface can be damaged and discolored.

Usable Discs

Navigation Unit*

- Navigation map DVD

Head Unit

- DVD player*: DVD/VCD/Audio CD/MP3 CD
- CD player: Audio CD

Changer

- DVD/VCD/Audio CD/ MP3 CD

Please refer to a separately provided operating manual to check disk compatibility.

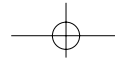

TABLE OF CONTENTS

Jump Start with Jumper Leads 11-2
 Jump Start with an Another Vehicle or Battery 11-2

Tire and OVM Tool..... 11-3
 Cautions when a Tire is Flat..... 11-4
 Spare Tire 11-5
 OVM Tool Box 11-6
 Wheel and Tire 11-6
 Changing a Spare Tire 11-7
 Removing Wheel Nuts..... 11-7

Changing Tires 11-8
 Changing a Flat Tire 11-8
 Jacking Point..... 11-8
 Changing a Tire and Wheel 11-9
 Inserting the Centering Pin..... 11-9
 Warning and Caution 11-12

Engine Overheating 11-13
 When the Vehicle Overheats 11-13
 Symptom and Remedy 11-14

**Shift Lever Lock Release and Safety Mode
 Reset 11-15**
 How to Release the Shift Lever Lock 11-15

Warning Triangle* 11-16
 Using a Professional Tow Vehicle Service 11-17

Towing the Vehicle 11-17
 Emergency Towing 11-18
 Towing Hook Location 11-19

Accident or Fire 11-20
 Accident 11-20
 Fire 11-20

**Section 11
In Case of
Emergency**

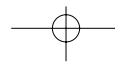
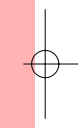

JUMP START WITH JUMPER LEADS

JUMP START WITH AN ANOTHER VEHICLE OR BATTERY

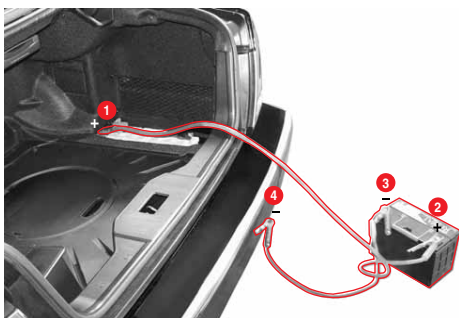

1. Prepare the jump cable.
2. Place an another vehicle that has 12 V of power near to discharged vehicle.
3. Switch off all electrical accessories for the discharged vehicle.
4. Place the shift lever to **P** in the discharged vehicle and apply the parking brake.
5. Connect the jumper cable as following order:
 - (1) + terminal of the discharged battery
 - (2) + terminal of the charged battery
 - (3) - terminal of the charged battery
 - (4) Rear towing hook in the discharged vehicle

6. Start the engine with the booster battery and slightly rev up the engine.
7. Attempt to start the engine of the vehicle with the discharged battery.
8. After starting the engine, carefully disconnect the jumper cables in the reverse order of connection.

CAUTION

- Be careful on the battery terminal polarity when you connect the cables. The negative and the positive should not be changed. Connect the '-' cable of discharged battery to the rear towing hook. If it is connected to the battery directly, it may cause an explosion due to the generated gas from battery. However, if the contact point of the hook is painted, it may not apply an electric current.
- Make sure that the battery providing the jump start has same voltage as the battery in your vehicle(12V).
- The polarity of battery, i.e. the connections for positive and negative cables, must not be interchanged. Make sure that the '+' terminal will not contact to the vehicle body.
- While connecting the jumper cables, make sure that the negative (-) and positive (+) cables never touch each other. Otherwise sparks might cause an explosion of the battery.
- Battery fluid contains acid that can burn you. Do not allow battery fluid to contact eyes, skin, or painted surfaces. If you accidentally get it in your eyes or on your skin, flush the place with water and contact your doctor.
- A battery generates the gas which is flammable and explosive. This gas could be exploded due to the spark when connecting the jump cables. Make sure that the booster battery has the same voltage rate with the discharged battery.
- When starting your vehicle with jumper cable, turn off the engine of the boost vehicle and connect the jumper cables
- Never try to start the engine with pushing the vehicle.

TIRE AND OVM TOOL

OVM Tool

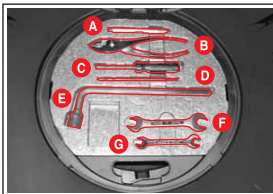

- A. Centering Pin
- B. Pliers
- C/D. + & - screwdriver
- E. Wheel bolt wrench
- F. Spanner (14 x 17)
- G. Spanner (10 x 12)

Screw Jack

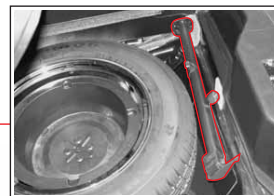

The jack is located in the front of the spare tire.

Jacking Point

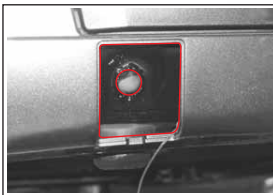

Wheel & Tire

Spare Tire

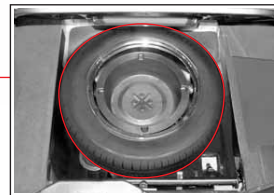

CAUTION

- Keep your tires at the recommended pressure. Incorrect inflation pressures will increase tire wear and will impair safety, vehicle handling, comfort and fuel economy.
- Maintaining the specified tire pressure is essential for driver comfort, driving safety and long tire life. Check the tire pressure regularly and prior to any long journey.

NEW CHAIRMAN

IN CASE OF EMERGENCY

11-3

CAUTIONS WHEN A TIRE IS FLAT

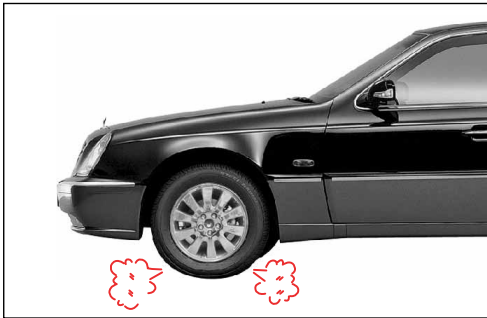

⚠ WARNING

- Don't panic! Improper operation of the steering wheel or abrupt braking may cause a consequential accident on the road. Stop your vehicle in a safe place and turn on the hazard flasher and then apply the parking brake.
- Do not drive with a flat tire for even a very short distance. In addition to damages to the rim of the tire, abnormal driving conditions can cause a very danger situation.

If one of the tires becomes flat while driving, grab the steering wheel firmly and remove your foot from the accelerator pedal. Gradually slow down and park your vehicle in a safe place. Replace the flat tire with a spare tire. For the process, refer to sections about the spare tire.

⚠ WARNING

- Stop the engine and set up the warning triangle behind your vehicle (daytime: 100 m, night time: 200 m - on express way).
- Check the front and rear of the wheel diagonally opposite to the wheel being changed.
- Have all passengers get out of vehicle and move in a safe place.

SPARE TIRE

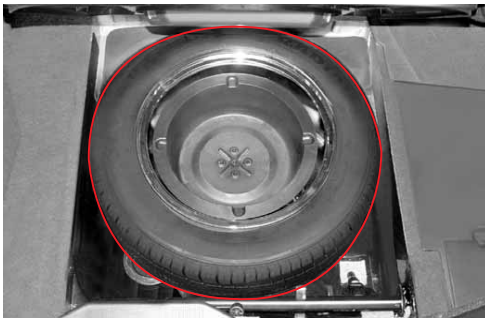

The spare tire is located on the trunk floor.

Check the tire conditions and pressure as needed and keep it always available.

CAUTION

- After replacing the tire, be sure to adjust the pressure to the specified pressure of the tire.

WINTER TIRES

If winter tires are used, they must be fitted to all 4 wheels. Do not exceed the maximum speed specified by the tire manufacturer. When using winter tires, the tire pressures supplied by the tire manufacturer must be adhered.

WARNING

- Drive very slow with extra caution on snow and icy condition when the snow tires are not mounted on your vehicle.
- The snow tire with arrow direction marking on its side wall should be fitted according to the arrow direction.
- The snow tires cannot guarantee your safety on the icy and slippery road. Drive with extra caution, avoiding sudden acceleration, braking or movements of the steering wheel.
- When the snow tires are not needed anymore, replace them with ordinary tires. Keep the removed snow tires at cool and shady place.

OVM TOOL BOX

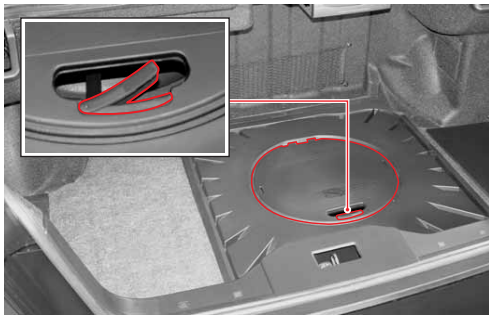

OVM tools are contained in the tool box in the trunk room.
Lift up the cover by pushing the lever forward and pulling it out to use OVM tool.

WHEEL AND TIRE



Tire Inflation Pressure

The following chart shows the recommended tire pressure for normal driving condition.

Tire	Pressure (PSI)
215/60R16 H (215/55R17 V)	28

CAUTION

- The tire inflation pressure should be followed by the specified pressure.
- Increase the tire pressure by 4-5 psi from the specified value prior to any long journey.

CHANGING A SPARE TIRE

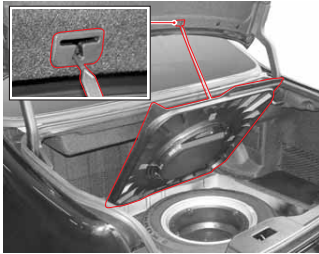

1. Open the trunk lid and pry off the mat. Take out the wheel nut wrench, wheel centering pin and driver from OVM tool box.
2. Lift up the cover by holding the cover handle and fix it to the trunk lid hook.



3. Rotate the bowl counter-clockwise and release it.
4. Pull out the spare tire.
5. Pull out the jack.

REMOVING WHEEL NUTS

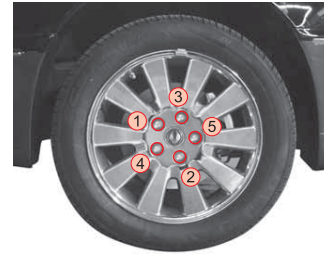

6. Place the spare tire in trunk next to the tire to be replaced.
7. Loosen the wheel nuts before lifting up the vehicle but do not take out the nuts. Make sure to loose the nuts diagonally as illustrated above.

⚠ WARNING

- Use the wheel wrench to loosen the wheel nuts, but don't remove them yet. If all the nuts are completely removed, the vehicle body can fall down on the ground, leading to personal injury.
- Loosen the wheel nuts by 2 or 3 steps.

CHANGING TIRES

CHANGING A FLAT TIRE

To change a flat tire on the road, drive your vehicle slowly to a level and safe place without any acceleration.

WARNING

- Don't be panic! Improper operation of the steering wheel or abrupt braking may cause a consequential accident on the road.
- Stop your vehicle to a safe place and turn on the hazard flasher and then apply the parking brake.
- Stop the engine and set up the warning triangle behind your vehicle (daytime: 100 m, night time: 200 m - in express way).
- Block the front and rear of the wheel diagonally opposite to the wheel being changed.
- Have all passengers get out of vehicle and stand in a safe place.

JACKING POINT

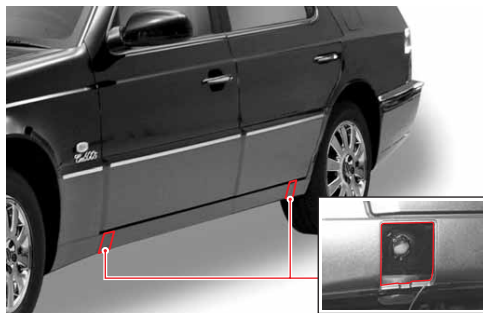

Front Jacking Points

Front jacking points are located at the rear of the front wheels (below the front door's front end).

Rear Jacking Points

Rear jacking points are located at the front of the rear wheels (below the rear door's rear end).

WARNING

Use the jack supplied at correct jack-up point. Do not take any other part of the vehicle for support.

CHANGING A TIRE AND WHEEL



1. Put the spare tire next to the tire to be changed.
2. Loosen the wheel nuts two or three turns by turning them counter-clockwise with the wheel nut wrench.
3. Remove the cap from jacking point by using a screwdriver.
4. Turn the jack handle to adjust the jack height.
5. Fully insert the supporting bar into the jacking point.
6. Set the base plate contact to the ground without any inclination.

WARNING

- Do not remove the nuts yet from the wheel. If they are removed, the wheel could slip off from the vehicle. Then, the body of the vehicle will fall down on you and you may get seriously injured.
- Loosen the wheel nuts two or three turns.

INSERTING THE CENTERING PIN

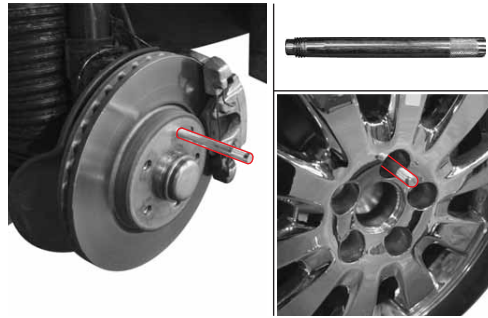

WARNING

While the jack is supporting your vehicle, do not use too much force to tighten the nuts. Otherwise, the vehicle may slip off and you may get injured.

NEW **CHAIRMAN**

IN CASE OF EMERGENCY

11-9

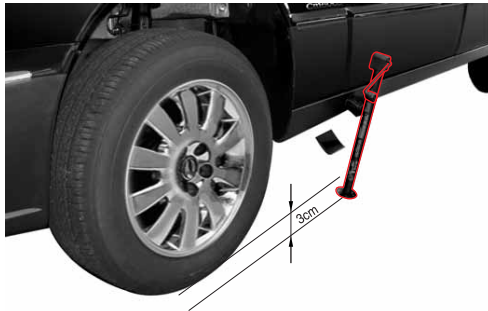

7. Raise the vehicle by rotating the jack connection rod clockwise until the tire is off ground about 3cm.
8. Remove all wheel nuts and wheel. For rear tire, release the parking brake carefully and remove the tire. Put the removed tire under the vehicle.
9. Install the wheel centering pin to one of the wheel nut hole.
10. Fit the spare tire to the wheel centering pin and tighten the nut temporarily.
11. Remove the wheel centering pin and tighten the other nuts temporarily.
12. Lower the vehicle by rotating the jack handle counter-clockwise (until the tire touches the ground. Remove the jack) and tighten the wheel nuts diagonally a couple of times.
13. Put the removed tire in the trunk and place tools in place.

If over tightened, the wheel nuts could be damaged. Do not overtighten the wheel nuts by pressing the wheel nut wrench by foot or using an assist pipe.

WARNING

- Improperly tightened wheel nuts can cause the wheel to become loose and even come off or any malfunctioning in the steering and braking system.
- Using different tires could cause you to lose control while driving. Be sure to use the same size and type tires from the same manufacturer on all wheels.
- After changing the tire and driving the vehicle about 1000 km, have your vehicle checked and repaired at the nearest Ssangyong Authorized Workshop or a tire specialized shop.

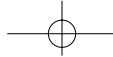

Tire Wear



The tire tread wear indicators will appear when your tires have only 1.6mm of tread remaining (on the tire wall ▲ indicator). When these indicators appear, replace your tires.

Before your driving, check the tires everyday for tire pressure, surface damages, crack and sharp objects imbedded in the tread and replace it, if necessary.

WARNING

Driving on worn, old or damaged tires is very dangerous and can cause accidents. Replace tires if the tread wear indicator appears, or tires have been damaged.

Tire Rotation

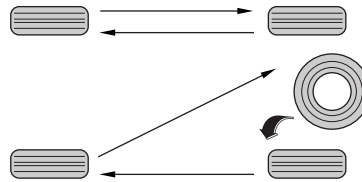

Tires should be rotated every 5,000 km. But interval of the rotation varies according to the driving habits or road conditions.

WARNING

- Using tires of different sizes may also cause damage to the vehicle.
- Be sure to use the same size and type tires on all wheels.

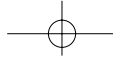

WARNING AND CAUTION

- Check the tire pressure regularly and prior to any long journey.
- If not emergency, have the tire replaced at the nearest Ssangyong Dealer or Ssangyong Authorized Workshop.
- Regularly check the conditions of the jack and OVM tools provided.
- Use the jack supplied at correct jacking point.
- Do not jack vehicle on an inclined or slippery surface.
- Use jack only for changing wheels.
- Use the jack only on vehicle with it is supplied.
- Do not lean the jack to the left or right.
- Do not remove the wheel nuts until the tire is off the ground. The tire can be dropped while jacking -up. Before loosen the nuts, make sure to apply the parking brake.
- Do not raise the vehicle over approx. 3 cm off the ground. This assure that the tire can be rotated.
- Never get under the vehicle while it is supported only by the jack.
- Do not start or run engine while the vehicle is on the jack.
- Do not apply excessive force to tighten the wheel nuts while the vehicle is on the jack. It may cause the vehicle to turn over.
- Do not completely tighten a wheel nuts at a time. Tighten the wheel nuts diagonally a couple of times.
- If over tightened, the wheel nuts could be damaged. Do not over tighten the wheel nuts by pressing the wheel nut wrench by foot or using an extension.
- Do not apply oil or grease on studs or nuts. It results in over-tighten.
- Check, repair, and retighten the replaced tire at the nearest Ssangyong Authorized Workshop or qualified tire shop after emergency change.
- Retighten the wheel nuts after driving of 1,000 km. Improperly or excessively tightened wheel nuts can cause the wheel to become loose or even come off.
- Check and adjust the tire pressure to specified value as soon as possible after replacing the tire. Incorrect inflation pressures will increase tire wear and will impair safety, vehicle handling, comfort and fuel economy. If you don't have a tire pressure gauge, visually check and adjust.

► **Before Changing the Tire**

- Turn on hazard flashers and move off the road to a safe place away from traffic. Park on a firm and level ground.
- Set up the jack at the specified position. Never get under the vehicle while it is supported by the jack. While the vehicle is on the jack, never start or run the engine or push the vehicle.
- Have all passengers get out of the vehicle and stay in a place away from traffic.

ENGINE OVERHEATING



If the engine coolant temperature gauge indicates overheating or you have another reason to suspect that the engine may be overheating, stop and park the vehicle.

Symptoms:

- The gauge indicates over the normal range (or in the red zone).
- Steam or spray from the engine compartment.
- Reduced engine output.

WHEN THE VEHICLE OVERHEATS

1. Move the vehicle safely off the road.
2. Move the shift lever to **P** and apply parking brake.
3. If you see steam under the hood, stop the engine immediately.
4. If there is no steam, open the hood and leave the engine running. However, if the gauge doesn't go down to normal range even in idling, stop the engine and cool it down.
5. Check the coolant level.
If it's low, check for leaks in the radiator hoses and connections.
6. When fully cooled down, loosen the surge tank cap to reduce the vapor pressure, then remove the cap.
7. If necessary, cover the tank cap with a cloth and turn the cap a little to release any pressure. After fully releasing the pressure, remove the cap and fill up the tank. Then, put the cap back on the tank.
8. Add coolant into the reservoir tank if necessary. If the coolant level is normal, have the cooling system checked at the nearest Ssangyong Dealer or Ssangyong Authorized Workshop.

SYMPTOM AND REMEDY

Symptom	Cause	Remedy
Gauge indicates over the normal range (or in the red zone),	Low coolant	Add
	Broken V-belt	Replace
	Defective water pump	Check and replace
Emit steam from engine compartment	Defective thermostat	Replace
	Low engine oil	Add

CAUTION

- Scalding hot coolant and steam could be blown out under pressure, which could cause serious injury. Never remove the coolant surge tank cap when the engine and radiator are hot.
- Engine and radiator may be damaged if you add cold water abruptly when the engine is still hot.
- Use only Ssangyong recommended anti-freeze.
- If the problem continues, have the cooling system checked at the nearest Ssangyong Dealer or Ssangyong Authorized Workshop.

SHIFT LEVER LOCK RELEASE AND SAFETY MODE RESET

HOW TO RELEASE THE SHIFT LEVER LOCK

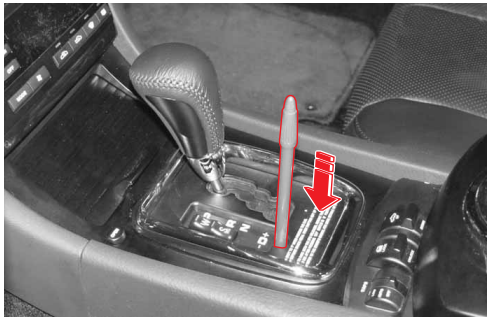

1. Apply the parking brake firmly and turn the ignition off.
2. Push the shift lock release lever by inserting the proper stick. Then, while stepping on the brake pedal, move the shift lever to "N".
3. Start the engine, release the parking brake, and place the shift lever to the "-D+" position.

⚠ WARNING

- If the automatic shift lever does not move out of "P", take the steps mentioned above and take the vehicle to a Ssangyong Dealer or Ssangyong Authorized Workshop. Have the vehicle checked and repaired.
- The brake pedal must be depressed when you try to move the shift lever.

Symptoms after Resetting of the Safety Mode

- Heavy shock when moving the shift lever
- Decreased driving force while driving at a high speed
- Decreased driving force while driving at high speed / Fixed gear position during driving
- Instrument cluster displays "D" other than "D," even when the shift lever is in "-D+" position.

If one of these symptoms happens, reset the automatic transmission safe mode.

How to Reset the Safety Mode

1. Park the vehicle and place the shift lever to the "P" position.
2. Stop the engine and wait for over 10 seconds.
3. Start the engine.

⚠ WARNING

If abnormal operation of the transmission (fixed at the 2nd forward gear in the "D" position or the 2nd reverse gear in the "R" position) still exists, have the system checked at the nearest Ssangyong Dealer or Ssangyong Authorized Workshop.

WARNING TRIANGLE*



When you pull over your broken down vehicle to a safe place, set up a warning triangle behind your vehicle.
(Daytime: 100 meters behind, Night: 200 meters behind)

When the vehicle has a serious problem during driving

1. Turn on the hazard flasher and move the vehicle out of traffic to a safe place. Set up the warning triangle behind your vehicle (day: 100 m, night: 200 m) to warn other vehicles.
2. Have all passengers get out of the vehicle and stay away from the traffic. When your safety is secured, contact your Ssangyong dealer for your emergency service.

CAUTION

- Set up a warning triangle on a place where it can be very visible while paying attention to traffic conditions.
- On a highway or vehicle-designated road, evacuate yourself to a safe place after pulling over your vehicle.
- At night time, set up a blinking emergency triangle behind your vehicle (over 200 meters) to warn others.
- On a curved road, provide an emergency hand signal with a warning light to others at the point over 200 meters behind your vehicle.
- If your vehicle is operational or the problem is fixed, resume driving paying extra attention to traffic conditions.

TOWING THE VEHICLE

USING A PROFESSIONAL TOW VEHICLE SERVICE

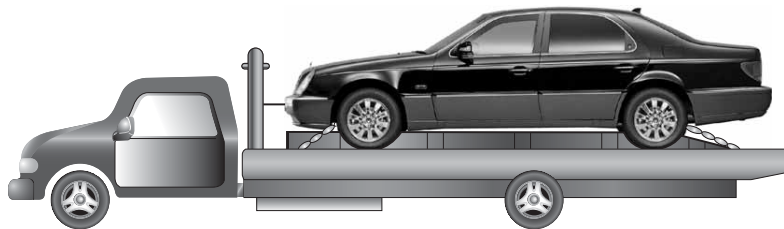

- Flat-bed equipment is the best method of moving a disabled vehicle to avoid any damages.

CAUTION

- When towing your vehicle, do not rely on only the towing hooks in vehicle for supporting.

EMERGENCY TOWING

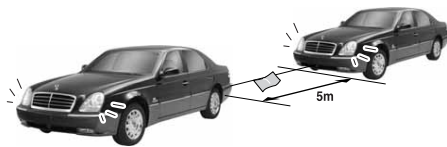

- When you cannot use a professional towing service (in case of emergency)
1. Securely tie up the towing rope to the towing hooks. Secure the rope to both of the towing hooks under the front of the vehicle as tight as possible.
 2. To make the rope conspicuously visible, bind a white colored cloth on the center of the rope.
 3. Place the shift lever in the neutral position and release the parking brake.
 4. Switch on the hazard warning flashers of both vehicles.
 5. Maintain the towing distance. Apply more force to depress the brake pedal of the vehicle that will be towed.
 6. Set the ignition in the ACC or the ON position.
 7. Total length of the towing and towed vehicle and the towing rope should be less than 25 meters. And tow the vehicle within 25 km at 5 km/h of the towing speed. The length of the rope should be less than 5 m.

CAUTION

- If you cannot use a professional towing service, get into the disabled vehicle during towing. But, never use this emergency towing when the electrical system, steering system, and brake system are not operative.
- You may allow horizontal direction force to apply. The vertical direction force may cause damage to the vehicle.
- Position the ignition switch to "ACC" or "ON" so that the steering wheel is not locked.
- More efforts are required to steer as the engine is not running.
- Depress the brake pedal stronger than normal condition as the engine is not running.
- Always position the shift lever to **N**.
- If there are steep hills or sharp turns in your towing, do not use this method.
- If the electrical systems operate properly, turn on the hazard warning lamps or turn signal lamps according to the towing vehicle's signals.
- Avoid overloaded towing and do not tow the heavier vehicle than yours.
- Never attempt to connect a rope other than towing hooks.
- Be careful not to damage your bumper or others while towing a vehicle.
- The towing distance should be less than 25km and towing speed should be less than 5km/h.

TOWING HOOK LOCATION

Front Towing Hook

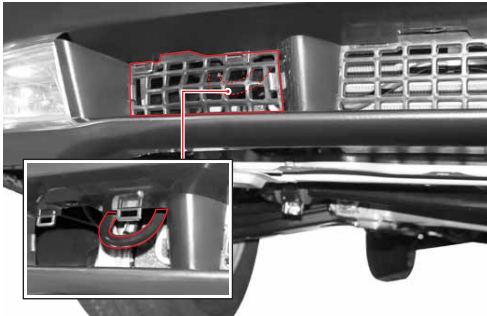

Rear Towing Hook



To use the towing hook, remove the front grille.

CAUTION

The towing hooks are designed to support the vehicle when loading it on the towing vehicle.

ACCIDENT OR FIRE



If your vehicle catches on fire, don't panic. Evacuate any occupants and use the extinguisher.

ACCIDENT

Turn on the emergency hazard warning switch. If possible, move your vehicle to a safe place to avoid any secondary accidents. If anyone is injured, call an ambulance and contact the nearest police station.

FIRE

Stop immediately in a safe place. Turn off the engine. Use fire extinguishers to put out the fire. If it is impossible to extinguish the fire, contact the nearest fire or police station.

WARNING

- In an accident, fuel can be released from the vehicle. Therefore, stop the engine and avoid any sparks or flames.
- If you have even a minor burn, see your doctor.
- Keep a portable fire extinguisher in your vehicle, just in case of unexpected fire.

TABLE OF CONTENTS

Engine Compartment	12-2	Tire Rotation	12-28
Warning and Caution	12-3	Spare Tire	12-29
Maintenance Schedule and Service Interval ..	12-4	Winter Tire	12-29
Engine Oil	12-7	Tire Chain	12-29
Daily Check List	12-8	Cautions when Checking the Wheel and Tire	12-31
Exterior	12-8	Spark Plugs	12-31
Interior	12-8	Exhaust Gas Regulation and Vehicle Maintenance	12-32
Engine Compartment	12-9	Exhaust Gas	12-32
Systems in Engine Compartment	12-10	What does the Control System do?	12-32
Air Cleaner Element	12-10	Inspection and Maintenance	12-33
Engine Oil	12-11	Inspection and Maintenance Schedule of the Exhaust Gas Control System	12-34
Coolant	12-13	Inspection and Maintenance Schedule	12-36
Brake Fluid	12-15		
Power Steering Fluid	12-16		
Fuel Filter	12-17		
Windshield Washer Fluid	12-18		
Wiper Blade	12-19		
Battery	12-20		
Fuse and Relay	12-22		
How to Check and Replace Fuse	12-23		
Engine Compartment Fuse and Relay Box	12-24		
Trunk Fuse & Relay Box	12-26		
Tire	12-27		
Tire Inflation Pressure	12-27		
Tire Wear Check	12-28		

Section 12 Service and Maintenance

ENGINE COMPARTMENT

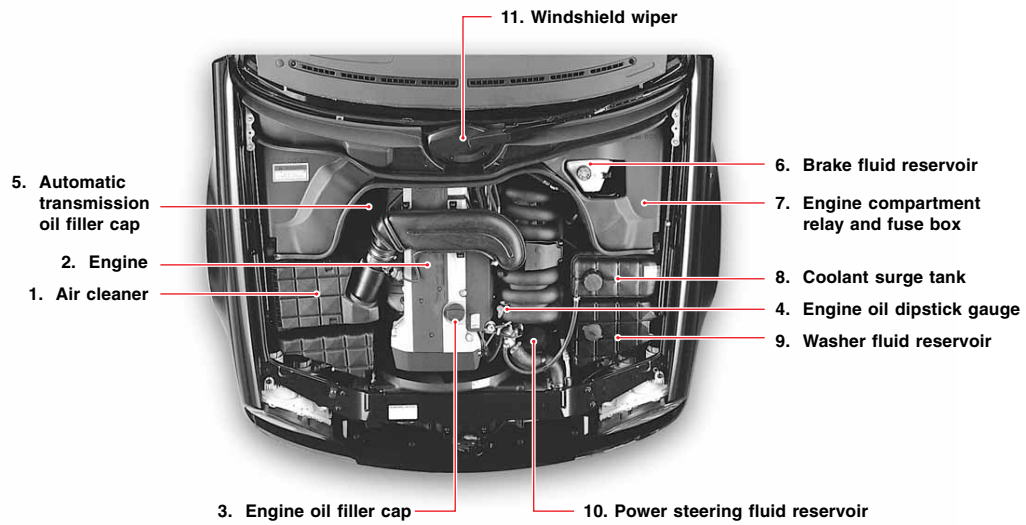

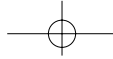

WARNING AND CAUTION

Here are some general warnings and precautions that should be closely observed during carrying out any service operation. But always exercise care to reduce the risk of personal injury or damage to the vehicle.

WARNING

- Do not work on the engine compartment while engine, radiator, muffler and catalytic converter are hot. Always turn the engine off and allow it to cool before starting the maintenance.
- Never get under the vehicle while it is supported by a jack. If it is necessary to work under the vehicle, use safety stands.
- Keep smoking materials, flames and sparks away from the battery and all fuel and fuel-related parts.
- Never connect or disconnect either the battery or any transistorized component while the ignition switch is ON.
- When connecting the battery cables, pay special attention to their polarities.
- Remember that the battery, ignition cables and vehicle wiring carry high currents and voltage. Be careful not to cause a short circuit.
- When performing any checks in an enclosed space with the engine running, such as in a garage, make sure there is proper ventilation.
- Keep used oil, coolant and other fluids out of reach of children and pets.
- For vehicle inspection, place the shift lever in P position and apply the parking brake.
- To avoid the possibility of injury from the cooling fan, disconnect the negative terminal of battery so that the fan is not operating.

CAUTION

- Check any oils and coolant level at regular intervals.
Operating with insufficient amount of oil or coolant can damage the engine and so it is not covered by warranty.
- Always use only Ssangyong genuine parts for replacement.
- Do not allow oil and coolant contact with skin, clothes, or painted surface of the vehicle during refilling. If skin contact happens, rinse the affected area immediately with plenty of water and consult a doctor.
- Do not overfill the oil and coolant. The system may be damaged.
- The performance of oil and coolant may be deteriorated when they exposed to dust and moisture. Be careful not to contact with dust while refilling.
- The oil and coolant could be spoiled after an extended period of time or with short travel distance. In such a case, consult the Ssangyong Dealer or Ssangyong Authorized Workshop.
- Empty or used oil and fluid containers must not be disposed of in the household waste. Use your local authorized waste disposal facilities when disposing of them.

MAINTENANCE SCHEDULE AND SERVICE INTERVAL

●: Replacement, ○: Inspection, Adjustment, Replenishment

Item	Daily inspection	Maintenance, Adjust, Replacement interval (km)			Remark
		1,000 ~ 1,500	Every 15,000 (or every 1 year)	Every 30,000 (or every 2 years)	
Weels and tires	Wheel bolts retighten(specified torque)		○		
	Tire pressure check and inflation	○			
	Spare tire pressure/conditions		○	○	
	Wheel balance		○	○	
	Tire conditions and damage	○			Replace, if necessary
	Tire waer(check tread depth)		○	○	Replace, if necessary
Underbody	Automatic transmission oil		Check oil at every 30,000km or 1 years		Replace, if necessary
	Power steering mounting bolts retighten		○		
	Exhaust pipe bolts retighten		○		
	Oil and/or water leakage, intervention(visual)			○	Hose/pipe lines and connections
	Axle oil		Check oil at every 10,000km		Replace, if necessary
	Front axle boot and ball joint conditions			○	
Engine compartment	Steering system operation			○	
	Fuel filter replacement		Replace every 100,000km (if using poor quality of fuel, replace every 30,000km)		
	Engien oil and filter replacement	○ (Oil)		● (Filter & oil)	After intial 10,000km, every 15,000km or 12 months
	Engine oil level check and replenishment	○			Check and replenish as necessary
	Coolant gravity check		○	○	Adjust gravity before winter
Coolant level check and replenishment	○			Check and replenish as necessary	

(1) Frequently check the oil level and add if required. Under severe conditions, the service interval should be shortened.

(2) Severe conditions:

- Frequent low-speed operation in stop-and-go traffic, excessive idling, short driving within 6km
- Mainly driving in hilly, sandy, dusty or salty road
- Heavy load driving

●: Replacement, ○: Inspection, Adjustment, Replenishment

Item	Daily inspection	Maintenance, Adjust, Replacement interval (km)			Remark
		1,000 ~ 1,500	Every 15,000 (or every 1 year)	Every 30,000 (or every 2 years)	
Coolant replacement			Every 3 years		Every 3 years or every 60,000 km
Brake fluid level check and replenishment	○				
Brake fluid replacement			Every 2 years		Every 2 years
Power steering fluid level check and replenishment	○				
Washer fluid level check and replenishment	○				
Tightness of connections and leakage		○	○	○	
Oil and/or water leakage, intervention(visual)	○				Hose/pipe lines and connections
V-belt check				○	
Spark plug replacement (CM400S)		CM500 (L/S), CM600 (L/S): Every 60,000 km			
Hood lock and hinge lubrication				○	
Air cleaner element			Clean : Every 15,000km Replacement : Every 60,000km		Off-roads/dusty roads, frequently check/replace
Headlamps, Turn signal lamp, Hazard warning lamp	○				
Horn	○				
Warning/Indicator lamps (meter cluster)	○				
Interior lamps	○				
Other front and tail lamps	○				
Wiper	○				
Wind shield washer system	○				
Repellent glass coating			After initial 3 years, every 1 year		

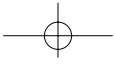

●: Replacement, ○: Inspection, Adjustment, Replenishment

Item	Daily inspection	Maintenance, Adjust, Replacement interval			Remark
		1,000 ~ 1,500	(km) Every 15,000 (or every 1 year)	Every 30,000 (or every 2 years)	
Brake	Brake operation test and pipe/hose check		After initial 1,000km, every 20,000km or every 1 year		Replace, if necessary
	Parking brake operation test		○		Adjust, if necessary
	Brake pad and disc inspection		Check every 10,000km		Replace, if necessary
	Parking brake check and adjustment			○	
Air conditioner	Air filter replacement		Replace every 10,000km Under severe driving conditions (Off-roads, dusty roads or excessive air conditioner or heater operation), shorten your maintenance intervals.		
	Air purifier filter		Replace every 10,000km However, regardless of the interval, replace the filter when the filter change indicator flashes.		
Others	Headlamps aiming angle check & adjustment			○	
	Wiper blade check and replacement			●	
	Engine idle check			○	
	Emission test			○	

• Refer to the separately provided "Maintenance Guide" for scheduled maintenance and replacement.

⚠ CAUTION
 Let only qualified technicians at the Ssangyong workshop work on maintenance check, adjustment and replacement. You are recommended to perform daily inspections and to check leakages of oil, fluid and water and check and service your vehicle at the Ssangyong Workshop, if necessary. You have to check, adjust and replace the relevant items within scheduled mileage at the Ssangyong Workshop.

ENGINE OIL

API Classifications of Engine Oil

The American Petroleum Institute (API) and International Lubricant Standardization and Approval Committee (ILSAC) classifies engine oils according to their performance (quality). Always use oil rated API-SH (ILSAC GF-1) or better.

* How to check engine oil specification

Example:

0W, 5W, 10W, 15W, 20W, 25W **20, 30, 40, 50, 60**

Summer oil viscosity

Winter oil viscosity
(W: Winter)

- The numerical, for example SAE 10W, relates to viscosity at particular temperature and the alphabet "W" indicates the oil's suitability for colder temperature.

For summer oil viscosity, higher numbers mean higher viscosities.

Quality Class *)

MB Sheet No. 229.1, 229.3

*) In only case not available MB 229.1 or 229.3 approved oil for service, API SJ (or better grade) and/or ACEA A2/A3 oil may be used, however it would be rather recommended to shorten the change interval around 30%.

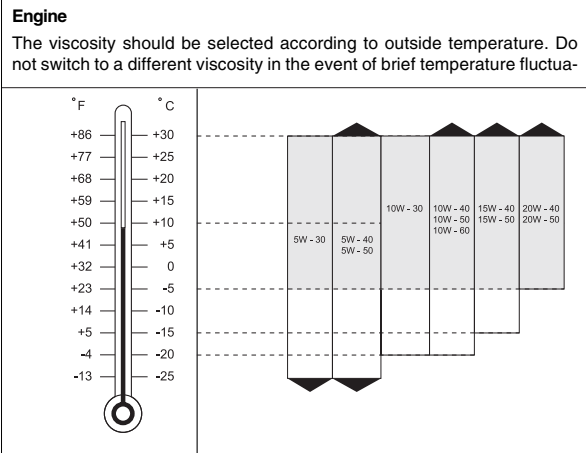

* RECOMMENDED OIL

DAILY CHECK LIST

EXTERIOR



The following checks are recommended before driving to maintain safe.

1. Tire inflation pressure and damage
2. Wheel bolts looseness
3. Operation of the lights
4. Any oil, water, fuel and fluid leaks

INTERIOR



1. Steering wheel play and looseness
2. Parking brake pedal travel
3. Operation of the horn, windshield wipers and turn signal lamps
4. Operation of instruments and indicator warning lights
5. Fuel level
6. Position of the outside and inside rearview mirrors
7. Operation of the door and window locking mechanism
8. Brake pedal free play, height and function
9. Seat belts

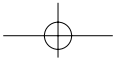

ENGINE COMPARTMENT

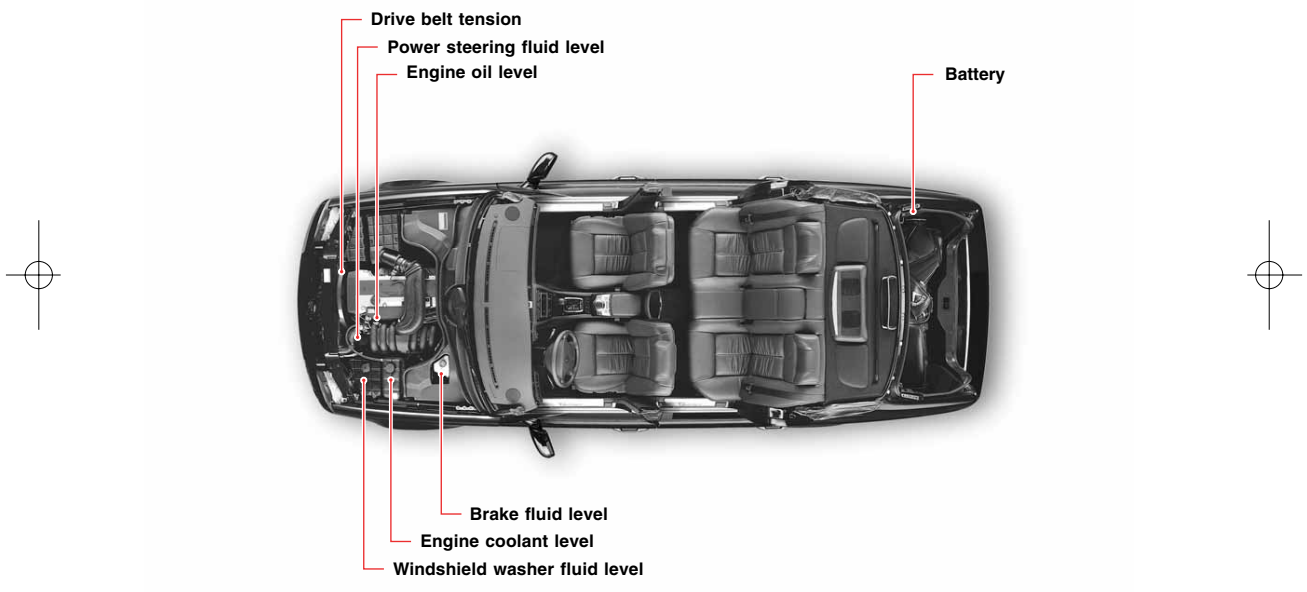

SYSTEMS IN ENGINE COMPARTMENT

AIR CLEANER ELEMENT

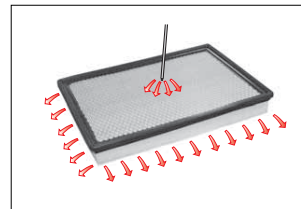
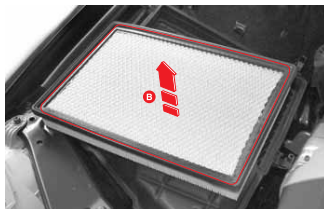
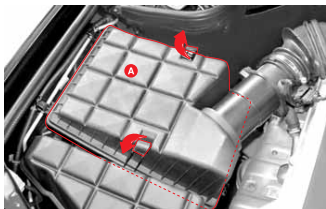

Replacement

1. Pry off the clips (arrow) from the cover (A) and remove the cover.
2. Take out the air cleaner element (B).
3. Install a new air cleaner element correctly.
4. Close the cover and fix the clips on it correctly.

WARNING

- If you drive with improperly installed air cleaner filter or without it, this may damage the engine or may cause a fire.
- Do not let any objects enter the housing when cleaning the air cleaner.

Replacement Interval

Item		Replacement
Paved roads	Cleaning	Every 15,000km
	Replacement	Every 60,000km
Unpaved roads		Check and clean frequently, Replace if necessary

CAUTION

- If you blow the compressed air to normal air flow, the engine will be damaged due to foreign materials entering.
- Be careful with the direction of the compressed air on the air cleaner.

WARNING

Engine can be damaged.
Do not operate the vehicle without air cleaner element.

ENGINE OIL

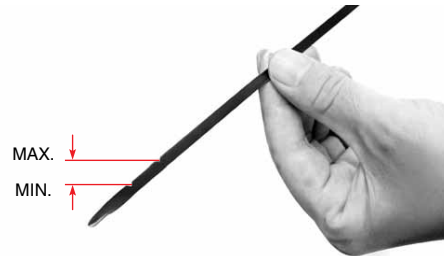
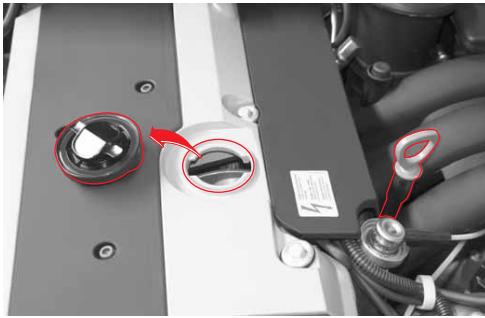

Level Check

1. Park the vehicle on level ground and apply the parking brake.
2. Stop the engine and wait for more than 5 minutes.
3. Pull out the dipstick, wipe it clean with cloth.
4. Reinsert it and pull it out again. Then check that the oil level is between the lower mark and the upper mark on the oil dipstick.
5. If the level gets to the lower point, open the filler cap on top of cylinder block and add enough oil not to exceed the level of the upper mark.

⚠ WARNING

- Regularly check the engine oil level and use only Ssangyong genuine engine oil.
- Clean the dipstick with clean cloth so that any foreign materials cannot get into the engine.
- Use only Ssangyong genuine engine oil.
- The oil should not go above the upper mark on the dipstick.
- Be carefule not to enter any foreign materials when adding the oil.
- Operating with insufficient or too much amount of oil can damage the engine.
- Check the engine oil level before driving off and add Ssangyong genuine engine oil if necessary.

Change Interval

Item	Service interval
Engine oil	After initial 10,000km, every 15,000km
Engine oil filter	Same interval as engine oil

CAUTION

- Shorten your maintenance intervals under following severe driving conditions:
 - Dusty roads (off-roads)
 - Repeated short distance driving
 - Extensive idling
 - Driving near shore
- Do not use over one year in severe conditions even the driving distance is not reached .

Specification and Capacity

Specification	Quality class: Ssangyong genuine engine oil (Approved by MB Sheet 229.1 or 229.3) Viscosity: MB sheet No. 224.1
Capacity (L)	CM600L/CM600S CM500L/CM500S
	≈ 7.0

WARNING

- Use only Ssangyong genuine parts.
- Use of non-recommended engine oil could cause damage to the engine.

COOLANT

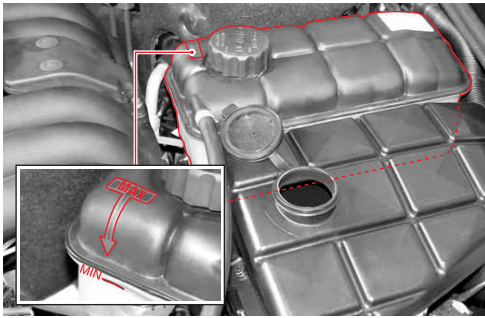

Level Check

Park the vehicle on level ground and apply the parking brake. Stop the engine and wait until it cools.

1. The coolant level should be between the MAX and MIN mark on the coolant surge tank.
2. Check the coolant level. If the level is below the "MIN" mark, immediately add coolant.

Capacity

Capacity (L)	CM600L/CM600S	11.5 ~ 12.0 ℓ
	CM500L/CM500S	

Level Check and Replacement

Check	Everyday, before driving off
Replacement	Every 3 years or every 60,000km
Replenishment	Replenish if necessary

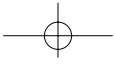

Replenishment

Use only the 50/50 mixture of soft water and antifreeze as specified.

1. Open the coolant surge tank cap slowly when the engine is cold. At this time, you can hear a "hissing" sound.
2. When there is no more "hissing" sound, remove the cap from the surge tank.
3. Add the 50:50 mixture of water and antifreeze to the coolant reservoir tank.
4. If no unusual things happen, tighten the coolant reservoir cap.

CAUTION

- Avoid any direct contact of the coolant to the painted body of the vehicle.

WARNING

When the coolant level is too low, the engine can overheat. If the coolant temperature gauge in the instrument cluster goes up abnormally, immediately check the coolant level. Use only the Ssangyong genuine coolant and anti-freeze. If different types of coolants or unapproved coolants are used to refill, chemical reactions can be caused and block the flow of the coolant. This may cause the engine to overheat or burning inside the engine.

WARNING

- Scalding hot coolant and steam could be blown out under pressure, which could cause serious injury. Never remove the coolant surge tank cap when the engine and radiator are hot.
- Use only the Ssangyong genuine coolant and anti-freeze.

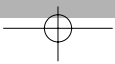

BRAKE FLUID

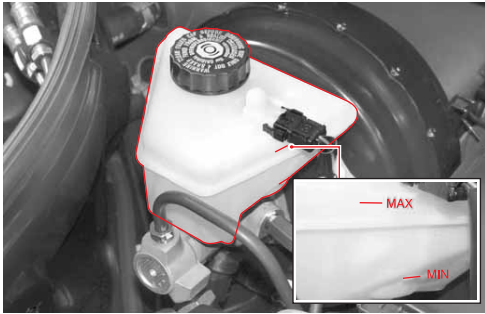

Level Check

The fluid level in the container must not be higher than the **MAX** mark or lower than the **MIN** mark.

⚠ WARNING

- If the fluid level is low, **BRAKE** indicator can indicate a leak in the brake system. Have the system checked for any leak.
- If any leaks are not found, it means that the brake pads are worn. In this case, have the brake system checked at the nearest Ssangyong Dealer or Ssangyong Authorized Workshop even though the indicator is not on.

Replenishment

Open the cap in the brake fluid tank and add the fluid to keep the fluid level between **MAX** and **MIN**.

Specification and Replacement

Specification	DOT 4
Service interval	Every 2 years

⚠ WARNING

- Use only Ssangyong recommended brake fluid. Use of non-recommended brake fluid could cause damage to the brake system.
- Do not allow brake fluid to make contact with eyes. If contact happens, it may cause any personal injury.

⚠ CAUTION

- Be careful not to enter any foreign materials when adding the fluid.
- Do not add the fluid more than the **MAX** line.
- Replace the damaged filter on the filler with specified product.
- Do not allow brake oil to make contact with body paintwork.
- After add the oil, tighten the cap securely.
- If frequent additions are required, contact the Ssangyong Dealer or Ssangyong Authorized Workshop.

FUEL FILTER

GASOLINE ENGINE

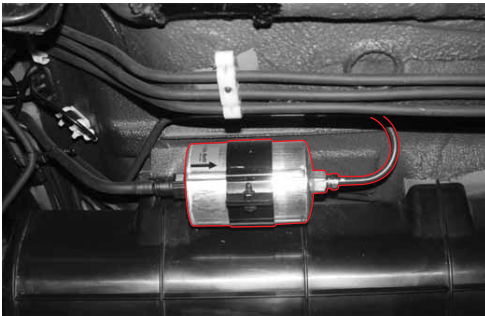

If the filter is contaminated, the supplied fuel will be reduced, main components will be damaged due to entering the contaminated materials and the performance of catalytic converter will be deteriorated.

Replace the fuel filter in accordance with the intervals specified.

Service Interval

Replacement	Every 100,000 km (if using poor quality of fuel, replace every 30,000 km)
-------------	---------------------------------------------------------------------------

CAUTION

Replace with a Ssangyong genuine part in accordance with the intervals specified.

BATTERY



The MF battery is located at the right hand floor in trunk room. If the warning lamp in the instrument panel comes on while driving, turn off all electrical devices and have the system checked at the nearest Ssangyong Dealer or Ssangyong Authorized Workshop.

Specification

Specification	DC 12V
Capacity	115AH

Battery Maintenance

- Check the battery for discharge, damage or corrosion. Replace it if necessary.
- Make sure the terminal connections are securely tightened.
- If the terminals are corroded, clean them with a wire brush or sand papers.
- Check the battery for crack, damage or leaks. Replace it if necessary. Remove the battery fluid on the battery surface with damp cloth.

⚠ WARNING

- The battery has acid that can burn you. And its gas can explode. You can get serious injuries if you are not careful. Keep naked flames, sparks and smoking items away from the battery.
- Loosely connected batter terminals can set up sparks. These sparks can cause a fire with flammable gas. Therefore, tightly connect the terminals.
- At night, if you need to check the engine room, do not use a lighter, but only use a battery-powered flashlight.
- Because the battery electrolyte is very strong acid, avoid any direct contact of the battery electrolyte on your skin or vehicle's body. If the acid contacts your skin, thoroughly wash your skin with fresh water and see your doctor. Do the same on your vehicle.
- Wear eye protection when working with a battery. If working in a closed area, keep good ventilation.

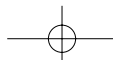

⚠ CAUTION

- If you disconnect the battery terminal when the engine is running, electrical systems could be damaged.
- To remove the battery cable, disconnect the negative cable first. And be careful on the battery terminal polarity when you connect the cables. The negative and the positive should not be confused.
- The polarity of the battery, i.e. the connections for positive and negative cables, must not be interchanged. Never short-circuit the battery.
- When the ambient temperature is too low, the battery capacity will drop and can be frozen.
- Keep the battery electrolyte at its specified level. If the electrolyte level is higher than the MAX level, it can overflow during battery charging and if the electrolyte is overcharged, the battery can explode.
- Only use a battery with the approved voltage and capacity. Otherwise, an incompatible battery can cause a fire.

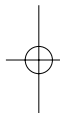

FUSE AND RELAY

If any of the electrical system does not operate, check the corresponding fuse. If the fuse is blown off, replace it with the same capacity.

Engine Compartment Fuse and Relay Box

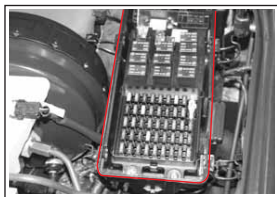

Trunk Fuse and Relay Box

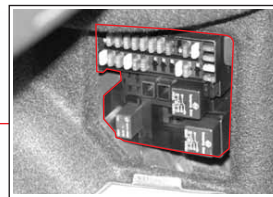

The trunk fuse and relay box is located on the right hand side of the trunk.



CAUTION

When the electric system operates abnormally, check the applicable fuse first. If a fuse is blown off, check its capacity and replace it with the same capacity.

CAUTION

- If you remove an electrical system's fuse while the system is operating, the electrical equipment could be damaged. Always remove the ignition key from the ignition switch and turn off all electrical devices.
- Always replace a specified fuse with the same rating.

ENGINE COMPARTMENT FUSE AND RELAY BOX

Engine Compartment Fuse Box

1 15A	Immobilizer E.C.S	2 10A	ABS	3 15A	Ignition	4 7.5A	STICS REKES	5 20A	Power seat, Driver's (cushion, seatback)
6 10A	Air bag	7 10A	Seat heater	8 15A	TCU Injector	9 15A	Sunroof	10 15A	Front fog lamp
11 10A	Cluster STICS	12 7.5A	A/C (Auto amp)	13 10A	Cluster H/LAMP LEV'G	14 20A	Windshield heated wire	15 7.5A	Auto light Shift lever
16 15A	Rear blinder Massage	17 20A	FR RH Power window	18 10A	FR Power window Bias power	19 10A	LH Headlamp (low-beam)	20 10A	Turn signal lamp Back up lamp
21 15A	Power seat, Driver's (cushion, seatback)	22 10A	Stop lamp	23 10A	Flasher unit Anti theft	24 10A	RH Headlamp (low-beam)	25 10A	RH Position lamp
26	N/A	27 7.5A	Rain Sensor	28 10A	Horn Siren	29 7.5A	Illumination Mood lamp	30 10A	LH Position lamp License plate lamp
31 10A	Self diagnosis E.C.U	32 10A	RH Headlamp (high-beam)	33 15A	Steering wheel Tilting	34 15A	TCU	35 20A	FR LH Power window
36 10A	Power room mirror STICS	37 10A	LH Headlamp (high-beam)	38 15A	Room lamp	39 15A	Injector	40 10A	Air conditioner
41 15A	Cup holder, AudioTuner	42 10A	Windshield washer Rain sensor	43 10A	Bias power	44 30A	Battery discharge protector		

Engine Compartment Relay Box

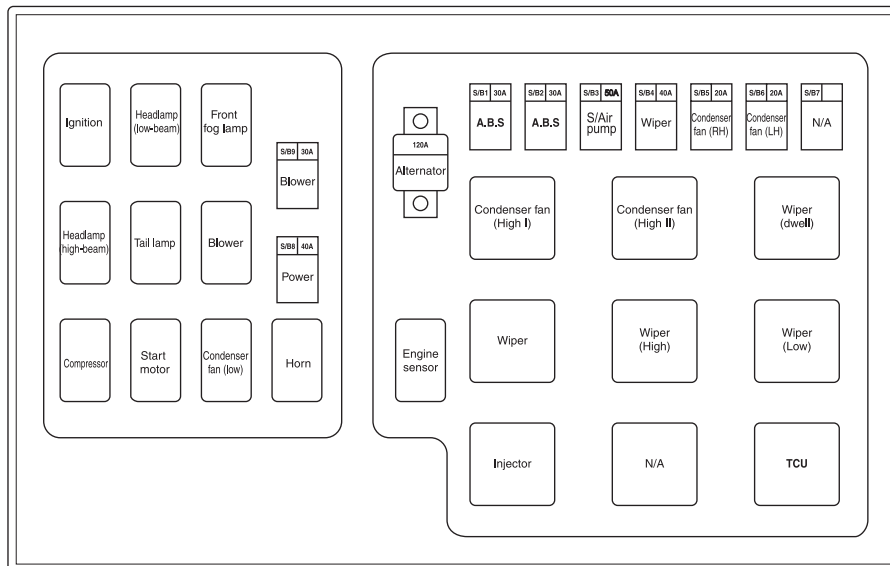

* Use only the specified fuses and relays.

TRUNK FUSE & RELAY BOX

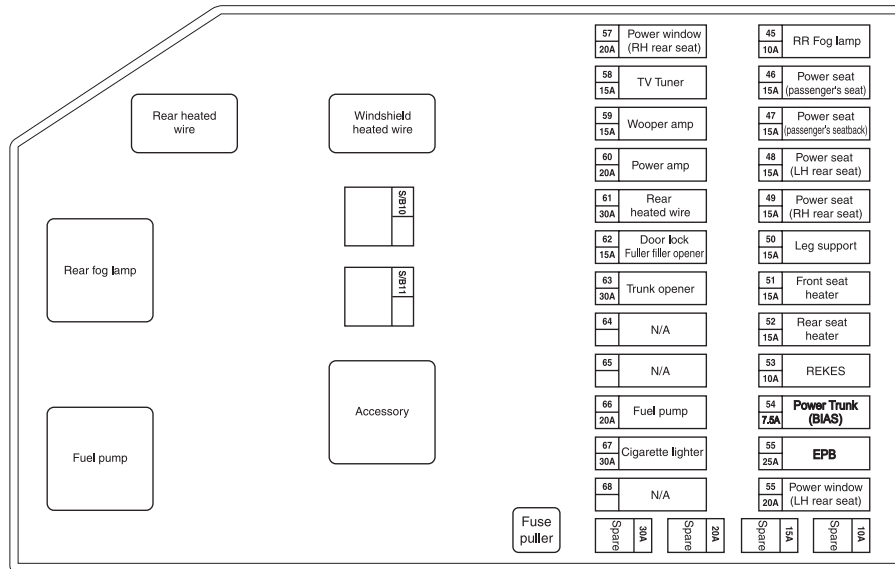

* Use only the specified fuses and relays.

TIRE

TIRE INFLATION PRESSURE



Under
inflation



Proper
inflation



Over
inflation

Tire Inflation Pressure

Value	Tire	Wheel
28 psi	215/60R16 H	7.0J X 16
28 psi	215/55R17 V	7.0J X 17

CAUTION

- Maintaining the specified tire pressure is essential for comfortable riding, driving safety, and long tire life. Incorrect inflation pressures will increase tire wear and will impair safety, vehicle handling, comfortable driving and fuel economy. Always make sure that the tire inflation pressure is correct.
- Check and adjust the tire inflation pressure, including the spare wheel, prior to any long journey (before the tire is heated up).
- Even the spare tire should be inflated properly.

NOTE

The tires should be checked before they are heated up using an tire pressure gauge.

TIRE WEAR CHECK

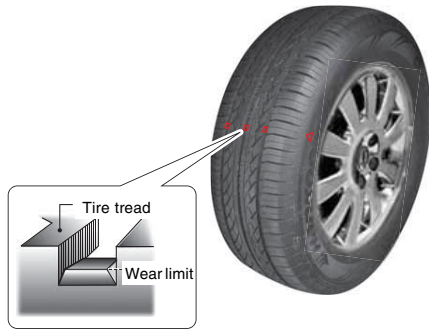

The tires on your vehicle have built-in tread wear indicators that appear between the tread grooves. The tire should be replaced when the wear indicators appear in two or more adjacent grooves.

⚠ WARNING

- Driving on worn or damaged tires is very dangerous and may cause an accident. Also, a damaged tire could be flat.
- Check tires regularly for any damage (foreign objects, punctures, cuts, cracks, bulges in side walls) and replace if necessary.

TIRE ROTATION

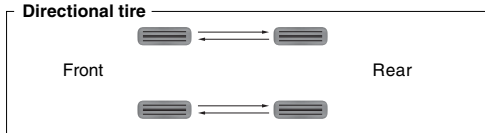
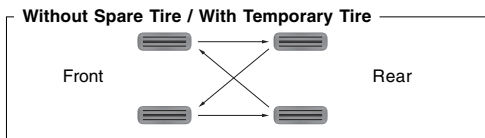
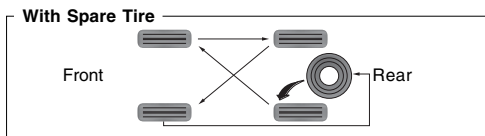

To avoid uneven wear of tires and to prolong tire life, inspect and rotate your tires every 5,000 km.

⚠ WARNING

- Be sure to replace and rotate the tires at the nearest Ssangyong Authorized Workshop or professional tire shops.
- Mixing tires could cause you to lose control while driving. Be sure to use the same size and type tires of the same manufacturer on all wheels.



CAUTIONS WHEN CHECKING THE WHEEL AND TIRE

- Mixing tires could cause you to lose control while driving. Be sure to use the same size and type of tires of the same manufacturer on all wheels.
- Check the inflation pressure, cracks and tearing of tires before driving.
- Improperly tightened wheel nuts can cause the wheel to become loose and even come off. This could lead to an accident. Be sure to check and tighten the wheel nuts as specified before any long journey.
- Do not use non-genuine wheel and tire. Non-genuine wheel and tire may have inferior performance and function and dangerous for safe driving. Also, any defects due to using them cannot be covered by warranty.
- Be sure to check the tires and wheels before driving. If a wheel is damaged, the tire inflation pressure can be decreased and the tire can be damaged.
- If a tire has been impacted by a stone or any other objects during driving, have it checked at the Ssangyong Dealer or Ssangyong Authorized Workshop.
- The use of tire sizes other than the specified sizes may cause abnormal operation of the steering wheel, increased fuel consumption, damage to the powertrain or the braking system, vibration, or uneven tire wear. Always use the specified tires from the same manufacturer.

SPARK PLUGS

GASOLINE ENGINE



Spark plugs should be periodically inspected for carbon deposits. When carbon accumulates on a spark plug, a strong spark may not be produced.

If necessary, clean the electrodes with a fine wire brush and carefully scrape the carbon off the insulator with a small file. The spark plugs should then be blown clean with compressed air and the upper insulator wiped clean. And adjust the spark plug gap.

Service Interval

Replacement	Change every 60,000 km
-------------	------------------------

* Maintenance interval: Frequently check and clean

⚠ CAUTION

- When replacing the spark plugs, disconnect the negative terminal of the battery and turn off all the switches.
- It is recommended that the engine be cool or cold when changing the spark plugs.
- Do not use non-recommended spark plugs.
- Do not allow contaminants to enter spark plug hole.

⚠ WARNING

Spark plugs may be very hot. Be careful not to burn yourself.

EXHAUST GAS REGULATION AND VEHICLE MAINTENANCE

EXHAUST GAS

For clean air and environment, the government is strengthening the exhaust gas regulations. In order to meet to and satisfy these regulations, the vehicle is equipped with the exhaust gas control system.

What is Meant by “Harmful Exhaust Gases”?

The harmful exhaust gases are the gases that are emitted from the exhaust system that are harmful to the human body such as Hydrocarbon (HC), Carbon Monoxide (CO), Nitrogen Oxide (NO_x) and Sulfur Oxide (SO_x).

Perform the following procedure in order to prevent from the harmful exhaust gases.

1. You must inspect and maintain the vehicle according to the “Exhaust Gas Related Inspection and Maintenance Record Schedule”. You must get an approval from the inspector.
2. Please use the Ssangyong Authorized Workshop that have skilled mechanics and the right tools so that they can perform the required regular inspection and troubleshooting.
3. Please warm up the engine before inspecting the engine inspection or measuring the exhaust gas.

Normal Engine Operation Temperature: 85°C ~ 95°C

WARNING

- Poor grade fuel or inappropriate additives can ruin the engine and the exhaust system. Use the designated fuel only.

WHAT DOES THE CONTROL SYSTEM DO?

The vehicle was designed to meet all exhaust gas regulations.

In order to maintain the exhaust gas control system optimized, you must perform regular inspections at the Ssangyong Authorized Workshop according to the Owner's Manual.

Crankcase Blow-by Gas Control System

The crankcase blow-by gas control system is a system that prevents air pollution by burning the blow-by gas surged from the crankcase by bringing into the combustion chamber using the positive crankcase ventilation system.

Vaporized Gas Control System

► Canister

The canister is a system that stores the evaporative fuel in the fuel tank during the engine off stage and then sends the stored fuel to the engine when it starts to run.

► Purge Control Solenoid Valve

The computer operated Purge control solenoid valve is located in between the canister and the surge tank. When coolant temperature is low or when the engine is idling, the valve closes to stop the evaporated fuel from going into the surge tank. During normal driving or after the warm-up, the valve opens and allows the evaporated fuel to go into the surge tank.

Exhaust Gas Control System

The exhaust gas control system eliminates the exhaust gases effectively while helping the vehicle to maintain its optimized conditions by using the 3-Way Catalytic Converter.

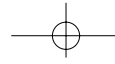

TABLE OF CONTENTS

Lamps 13-2
 Exterior Lamp Location 13-2
 Interior Lamp Location 13-3

Bulb Capacity and Type 13-4
 Functional Check 13-4

Replacement of Exterior Lamps 13-5
 Headlamp and Position Lamp 13-5
 Front Fog Lamp 13-6
 License Plate Lamp 13-6

Interior Lamps 13-7
 Front Foot Lamp 13-7
 Rear Foot Lamp 13-7
 Front Room Lamp 13-8
 Mood Lamp 13-9
 Glove Box Lamp 13-9
 Reading Lamp (With Sunroof) 13-10
 Reading Lamp (Without Sunroof) 13-10
 Trunk Room Lamp 13-11
 Door Courtesy Lamp 13-11
 Rear Vanity Mirror Lamp (Without Sunroof) 13-12
 Replacing the Sunvisor Lamp Bulb 13-12

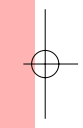

**Section 13
Lamps**

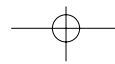

LAMPS

EXTERIOR LAMP LOCATION

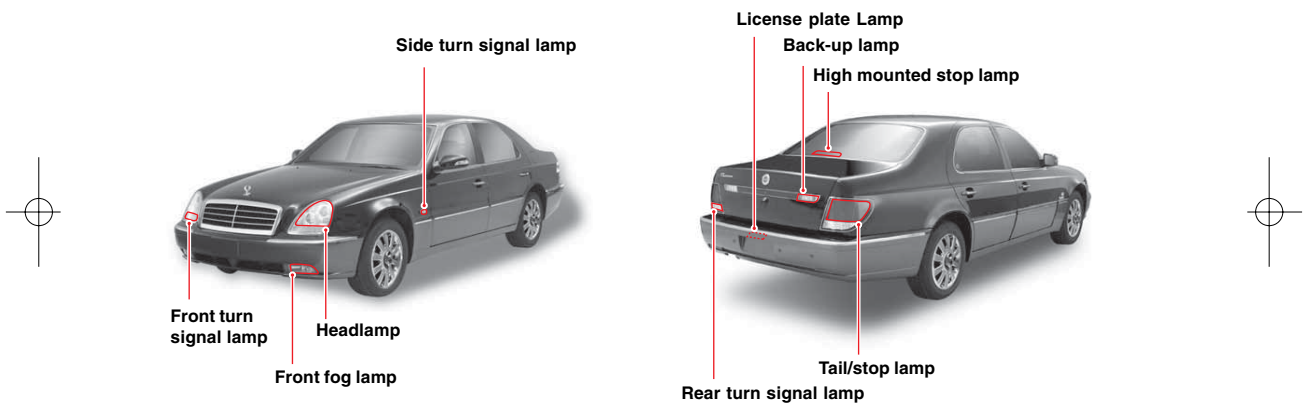

⚠ WARNING

Have the exterior lamps checked and replaced at the nearest Ssangyong Dealer or Ssangyong Authorized Workshop if needed.

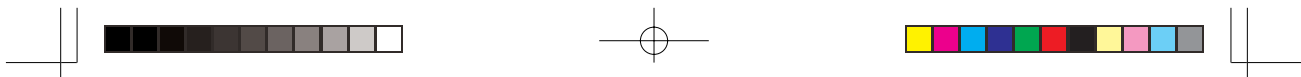

INTERIOR LAMP LOCATION

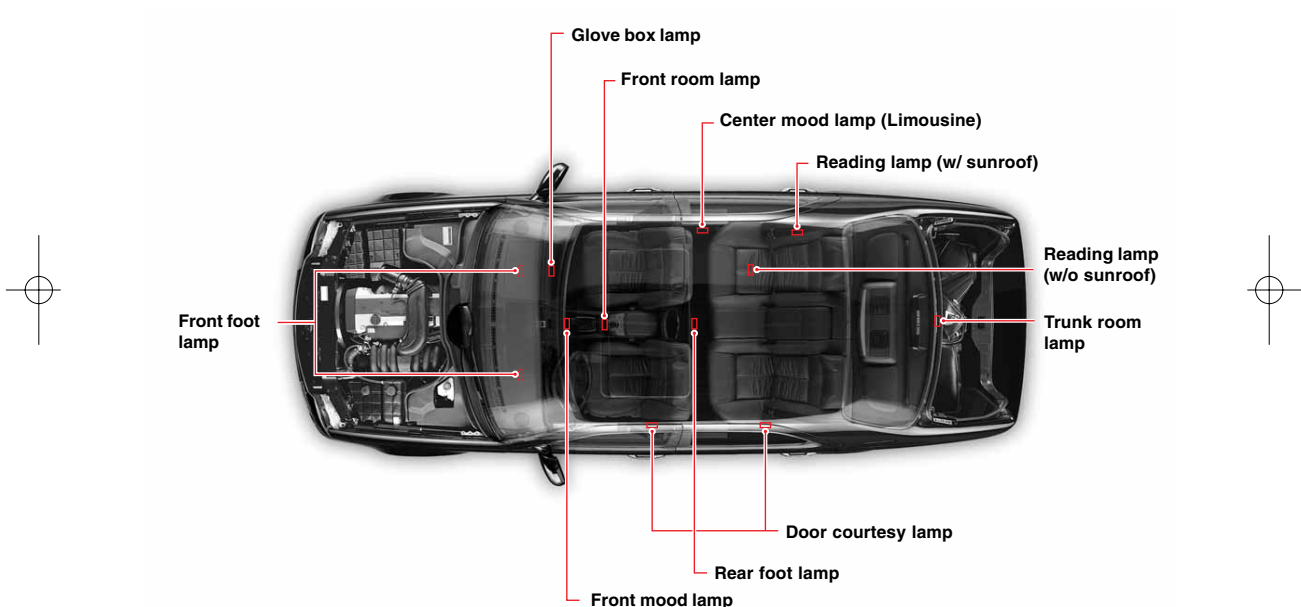

BULB CAPACITY AND TYPE

Item	Numbers	Watt
Headlamp	High-beam	2 55
	Low-beam	2 55
Turn signal lamp	Front	- LED TYPE
	Rear	- LED TYPE
Position lamp	2	16
Side repeater lamp	2	5
Tail lamp	-	LED TYPE
Rear fog lamp	-	LED TYPE
Stop lamp	-	LED TYPE
Back-up lamp	2/1	21
License plate lamp	2	5
Front fog lamp	2	55
High mounted stop lamp	-	LED TYPE
Interior lamps	Front foot lamp	2 5
	Rear foot lamp	2 5
	Door courtesy lamp	4 5
	Front room lamp	2 5
	Rear personal lamp	2 5
	Rear vanity lamp	2 3
	Mood lamp*	2 5
	Sunvisor lamp	2 5
	Glove box lamp	1 5
Trunk room lamp	1 5	

FUNCTIONAL CHECK

1. Check whether the lamp comes on or off by turning its switch.
2. Check the corresponding fuse when the lamp doesn't come on.
3. If the fuse is blown, replace it with a new one.
4. If the fuse is not blown, check the bulb and replace it with a new one if needed.
5. If the bulb is not defective, have the system checked at the nearest Ssangyong Dealer or Ssangyong Authorized Workshop.

CAUTION

- Use only a specified capacity bulb for replacement.
- Disconnect the negative cable on the battery before replacing the bulb. Remove the ignition key.
- Do not apply excessive force to remove the bulb cover.
- Make sure that the corresponding switch and the ignition switch are turned off before replacing a bulb.
- Do not touch a bulb with bare hands immediately after turning off the lamp.
- Do not touch a bulb with bare hands. Fingerprints, dust, or moisture stuck to the bulb may shorten its life or cause it to explode. If you accidentally touch the bulb, wipe the bulb glass with a soft cloth.
- Never try to adjust the headlamp aiming angle. It should be done by a qualified technician at the nearest Ssangyong Dealer or Ssangyong Authorized Workshop.

REPLACEMENT OF EXTERIOR LAMPS

HEADLAMP AND POSITION LAMP

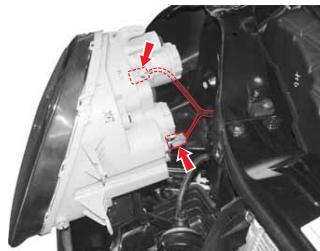
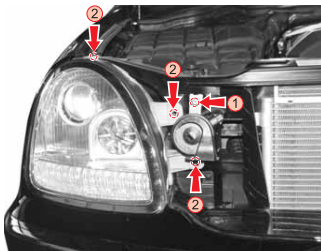

1. Turn off the lamp switch and remove the ignition key from the key switch.
2. Open the engine hood.
3. Remove the horn by unscrewing the horn mounting bolt (1) and separate the headlamp from the vehicle body by unscrewing the three headlamp mounting bolts (2).

4. Disconnect the two connectors and remove the headlamp.
5. Remove the headlamp cover from the detached headlamp.
6. Disconnect the headlamp connector and release the bulb fixing clip.
7. For the position lamp, remove its housing by turning it and remove the bulb from the housing.
8. Replace the bulb with a new one and install in the reverse order of removal.

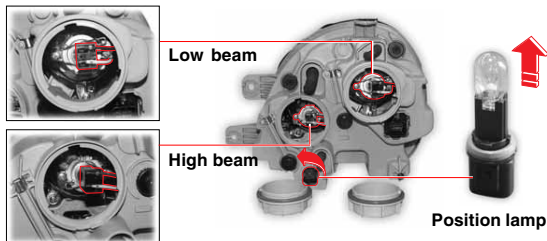

WARNING
Do not attempt to replace the headlamp by yourself.

CAUTION
The headlamp bulb should be replaced only at the nearest Ssangyong dealer or Ssangyong Authorized Workshop.

NEW CHAIRMAN

LAMPS 13-5

FRONT FOG LAMP

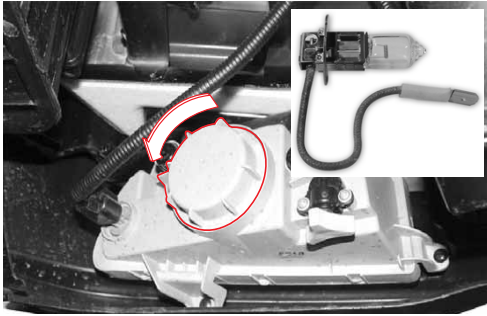

1. Turn off the lamp switch and remove the ignition key from the key switch.
2. Remove the cover by turning it.
3. Disconnect the connector by releasing the locks at both sides.
4. Replace the bulb with a new one.
5. Install in the reverse order of removal.

CAUTION

The fog lamp bulb should be replaced only at the Ssangyong dealer or an authorized service center.

LICENSE PLATE LAMP

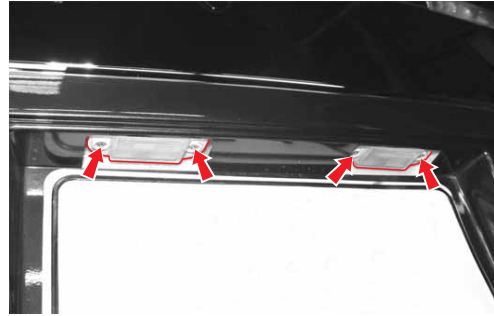

1. Turn off the lamp switch and remove the ignition key from the key switch.
2. Remove the two fastening screws on the license plate lamp.
3. Remove the lamp housing by turning the connector.

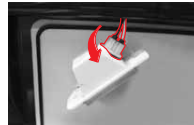

4. Remove the bulb by pulling it upward and replace it with a new one.
5. Install the new bulb in the reverse order of removal.

INTERIOR LAMPS

FRONT FOOT LAMP

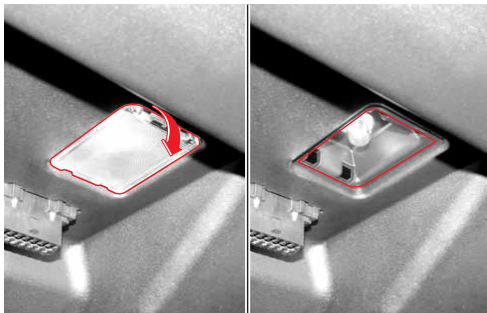

Operation

The front foot lamps come on when opening the door and go off when closing the door.

NOTE

- Driver's foot lamp: located at the dashboard under steering wheel.
- Passenger's foot lamp: located at the dashboard under the glove box.

Replacement

1. Remove the ignition key from the key cylinder.
2. Remove the lens by carefully prying on the slot of the lens with a small flat blade screwdriver. Do not pry on the edge of the lens.
3. Replace the bulb with new one in accordance with specified rating.
4. Snap the lens back in place.

REAR FOOT LAMP



Operation

The rear foot lamp is located on the rear of the center arm rest console. This lamp comes on when opening the rear door and go off when closing it.

Replacement

1. Remove the ignition key from the key cylinder.
2. Remove the lens by carefully prying on the outside of the lens with a small flat blade screwdriver. Do not pry on the edge of the lens.
3. Replace the bulb with new one in accordance with specified rating.
4. Snap the lens back in place.

MOOD LAMP

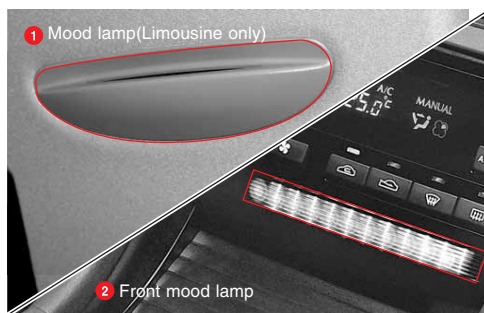

1. Mood Lamp (Limousine only)



The mood lamp is located at the center pillar.
Push the top of the switch to turn the mood lamp on.
Push the bottom of the switch to turn the mood lamp off.

2. Front Mood Lamp

When turning the light switch on or off using the combination lever, the front mood lamp located in front center switch panel comes on and goes off.

GLOVE BOX LAMP

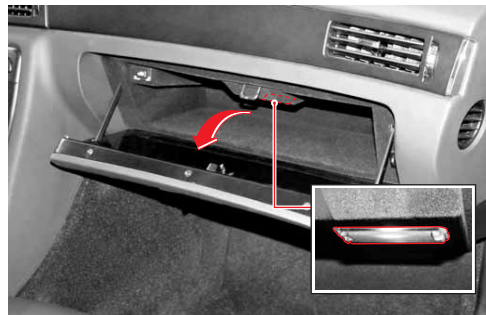

Operation

This lamp comes on when the glove box lid is open, and goes off when the glove box lid is closed.

Replacement

1. Remove the ignition key from the key cylinder.
2. Remove the lens by carefully prying off the slot of the lens with a small flat blade screwdriver. Do not pry on the edge of the lens.
3. Replace the bulb with new one in accordance with specified rating.
4. Snap the lens back in place.

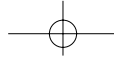

READING LAMP (WITH SUNROOF)

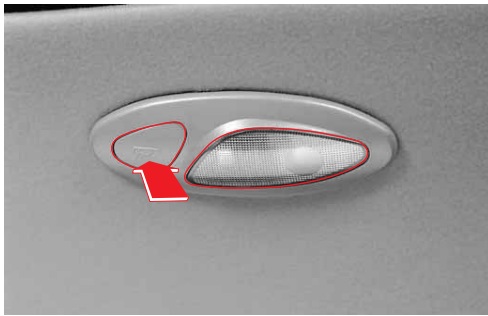

Operation

Press the switch once to turn on the lamp.

Replcement

1. Remove the ignition key from the key cylinder.
2. Remove the lens by carefully prying off the slot of the lens with a small flat blade screwdriver. Do not pry off the edge of the lens.
3. Replace the bulb with new one in accordance with specified rating.
4. Snap the lens back in place.

READING LAMP (WITHOUT SUNROOF)

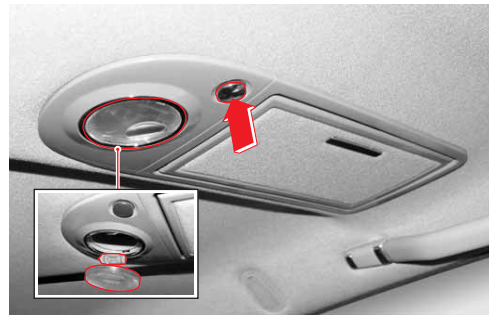

Operation

Press the switch once to turn on the lamp.

Replcement

1. Remove the ignition key from the key cylinder.
2. Remove the lens by carefully prying off the slot of the lens with a small flat blade screwdriver. Do not pry off the edge of the lens.
3. Replace the bulb with new one in accordance with specified rating.
4. Snap the lens back in place.

TRUNK ROOM LAMP

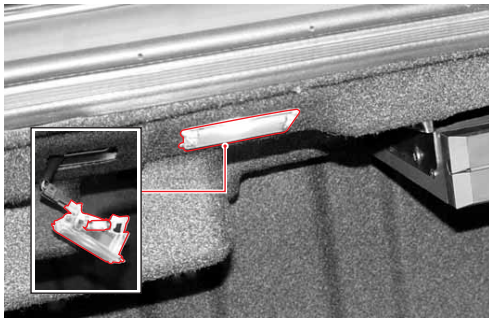

Operation

This lamp comes on when the trunk lid is open, and goes off when the trunk lid is closed.

Replcement

1. Remove the ignition key from the key cylinder.
2. Remove the lens by carefully prying off the slot of the lens with a small flat blade screwdriver. Do not pry off the edge of the lens.
3. Replace the bulb with new one in accordance with specified rating.
4. Snap the lens back in place.

DOOR COURTESY LAMP

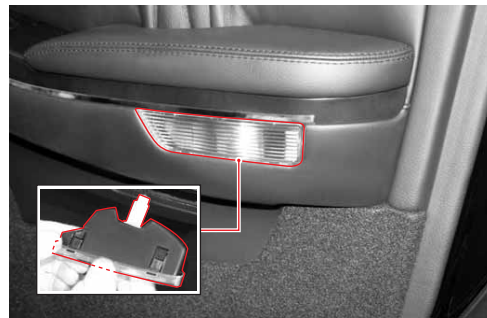

Operation

The courtesy lamp is installed on all the doors. This lamp comes on when the door is open, and goes off when the door is closed.

Replcement

1. Remove the ignition key from the key cylinder.
2. Remove the lens by carefully prying off the slot of the lens with a small flat blade screwdriver. Do not pry off the edge of the lens.
3. Replace the bulb with new one in accordance with specified rating.
4. Snap the lens back in place.

REAR VANITY MIRROR LAMP (without sunroof)



Operation

The lamps beside the rear vanity mirror come on as it swings down, and goes off when it is closed.

Replacement

1. Remove the ignition key from the key cylinder.
2. Remove the lens by carefully prying off the slot of the lens with a small flat blade screwdriver. Do not pry off the edge of the lens.
3. Replace the bulb with new one in accordance with specified rating.
4. Snap the lens back in place.

REPLACING THE SUNVISOR LAMP BULB



The lamp comes on when the sunvisor mirror cover is raised up.

1. Remove the ignition key.
2. Cover the tip of a flat blade screwdriver with a cloth and insert the tip into a lamp cover slot. Pry off the cover.
3. Remove the bulb with the lamps off and the cover slightly lowered.
4. Replace the old bulb with a new one.
5. Push the cover firmly into place.

VEHICLE CARE

RUNNING-IN PERIOD



There are no particular running-in rules for your new vehicle. However, following a few simple precautions for the first 1,000 km can add to the good future performance, economy and long life of your vehicle.

- Allow the engine to warm up after starting.
- Avoid harsh operations such as abrupt fast start sudden acceleration and prolonged high speed driving.
- Do not race the engine.
- Drive at varying speeds, trying not to "strain" the engine.
- Avoid overload when climbing.

CLEANING AGENTS

Follow the manufacturer's advice whenever cleaning agents or other chemicals are used, inside or outside the vehicle. Some cleaners may be poisonous or flammable, and improper use may cause personal injury or damage. When cleaning the inside or outside of the vehicle, do not use volatile cleaning solvents such as : acetone, lacquer thinners, enamel reducers, nail polish removers: or cleaning materials such as laundry soaps, bleaches or reducing agents, except as noted in the fabric cleaning advice on stain removal. Never use carbon tetrachloride, petrol, benzene, or naphtha for any cleaning purpose. Open all vehicle doors for ventilation when any cleaning agents or other chemical are used in the interior. Overexposure to some vapors may result in a health problem which is more likely to occur in small, unventilated spaces. To avoid possible permanent discoloration of light colored seats, do not let materials with non-fast colors come in contact with seat trim materials until these materials are totally dry. This includes certain types of casual clothing, such as colored denims, corduroys, leathers and suedes : also decorative paper, etc.

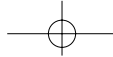

VEHICLE WASHING

To avoid corrosion, wash your vehicle as soon as possible after driving on a coastal road (salted road), on a road where the snow removal chemicals (calcium chloride etc.) has been spreaded, in the area where the atmospheric fallout/industrial pollutants are exist, or on a muddy or dusty road. Also, immediately wash your vehicle when things such as tree sap or bird droppings get on the painted surface.

Do not wash your vehicle under direct sunlight. Always wash your vehicle in the shade. If your vehicle has been parked under direct sunlight for a long period, let it cool sufficiently before washing.

How To Wash:

1. Rinse the vehicle thoroughly with cool water to remove dust and loose dirt.
2. Clean the vehicle thoroughly using a mild soap or detergent mixed with clean and lukewarm water. Start at the top and work your way down.
3. Check whether the vehicle is smeared with tree sap, coal tar or other foreign materials. Rinse them off while paying particular attention not to damage the painted surface.
4. Remove the moisture using a soft cloth. If you detect any stone chips or scratches in the painted surface, to prevent corrosion, touch them up immediately.

CARE AND CLEANING OF THE INTERIOR



With the use of modern trim materials, it is very important that you use proper cleaning techniques and cleaners. Failing to do this on the first cleaning may result in water spots, spot rings, or setting of stains or soils-all of which are more difficult to remove in a second cleaning.

Dust and loose dirt that collect on interior fabrics should be frequently removed with a vacuum cleaner or soft bristle brush. Wipe vinyl or leather trim regularly with a clean damp cloth. Normal trim soils, spots or stains can be cleaned with cleaners:

Safety Belt Care

- Keep belts clean and dry.
- Clean safety belts only with mild soap and lukewarm water.
- Do not bleach or dye belts since this may severely weaken them.

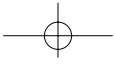

GLASS SURFACES

Glass surfaces should be cleaned on a regular basis. The use of glass cleaner or a liquid household glass cleaner will remove normal tobacco smoke and dust films sometimes caused by ingredients used in vinyl's and interior plastics.

Never use abrasive cleaners on any vehicle glass, as they may cause scratches. If abrasive cleaners are used on the inside of the rear window, any electric demister element may be damaged. Avoid placing decals on the inside rear window, since they may have to be scraped off later.

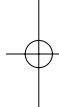

Cleaning the Outside of Windshield

If your windshield is not clear after using the windshield washer, or if the wiper blade chatters when running, wax or another material may be on the blade or windshield, clean the outside of the windshield with cleaning powder or an equivalent non abrasive cleaner. Your windshield is clean if beads do not form when rinsing with water.

CARE AND CLEANING OF THE EXTERIOR

Exterior Finish

The paint finish on your vehicle provides beauty, depth of color, gloss retention and durability.

Washing your Vehicle

The best way to preserve your vehicle's finish is to keep it clean by frequent washings.

Wash the vehicle in lukewarm or cold water.

Do not use hot water or wash your vehicle in the direct rays of the sun. Do not use strong soap or chemical detergent. All cleaning agents should be flushed promptly from the surface and not allowed to dry on the finish.

Ssangyong vehicles are designed to operate under normal environmental conditions and to withstand the natural elements. However, unusual conditions, such as high pressure car washes, may cause water to enter inside the vehicle.

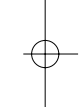

Polishing and Waxing

Periodic polishing and waxing is recommended to remove surface residue from your paint finish. Approved products are supplied through your Ssangyong Distributor.

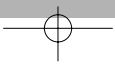

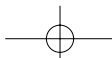

Protecting Exterior Bright Metal Parts

Bright metal parts should be cleaned regularly to keep their luster. Washing with water is all that is usually needed.

Use special care with aluminum trim. To avoid damaging protective trim, never use automotive or chrome polish, steam, or caustic soap to clean aluminum. A coating of wax, rubbed to a high polish, is recommended for all bright metal parts.

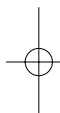

Cleaning Aluminum Wheels, Rally Wheels, and Wheel Covers

Preserve the original appearance of wheels or wheel covers by keeping them clean and free from build-up of road dirt and/or road salt. Regular cleaning is recommended. Do not use abrasive cleaners or cleaning brushes, as they could damage the finish.

CORROSION PROTECTION

Your car was designed to resist corrosion. Special materials and protective finishes were used on most parts of your car when it was built to help maintain a good appearance, strength and reliable operation. Some parts which normally are not visible (such as certain parts located in the engine compartment and the underbody of the vehicle) are such that surface rust will not affect their reliability. Therefore, corrosion protection is not needed or used on these parts.

Sheet Metal Damage

If your car is damaged and requires body panel repair or replacement, make sure the body repair shop applies proper anticorrosion material to the parts repaired or replaced so that corrosion protection is restored. (Also see "Finish damage" which follows).



Foreign Material Deposits

Calcium chloride and other salts, ice melting agents, road oil and tar, tree sap, bird droppings, chemicals from industrial chimneys and other foreign matter may damage vehicle finishes if left on painted surface. Prompt washing may not completely remove all of these deposits. Other cleaners may be needed. When using chemical cleaners, be sure they are safe for use on painted surfaces.



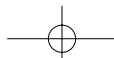

Finish Damage

Any stone chips, fractures or deep scratches in the finish should be repaired promptly. Bare metal will corrode quickly and may develop into a major repair expense. Minor chips and scratches can be repaired with touch-up materials. Larger areas of finish damage can be corrected in your Distributor's body and paint shop.

Underbody Maintenance

Corrosive materials used for ice and snow removal and dust control can collect on the underbody. If these materials are not removed, accelerated corrosion (rust) can occur on underbody parts such as fuel lines, frame, floor pan and the exhaust system even though they have been provided with corrosion protection. At least every spring, flush these materials from the underbody with plain water. Take care to clean any areas where mud and other debris can collect.

Sediment packed in closed areas of the frame should be loosened before being flushed. If desired, your Ssangyong Distributor can do this service for you.

CAUTION

- When an engine is washed, fuel, grease and oil residues are washed off. Therefore you should use only a filling station or a Ssangyong Distributor who has oil separator equipment in the car wash bay.
- Used engine oil, brake fluid, transmission fluid, antifreeze, batteries and tires should be disposed of by using the local authorized waste disposal facilities, or have them disposed of by the vendor who is under a statutory obligation to do so when you replace them.
- On no account must any of these items be placed in the household refuse bins or the fluids poured down the drains.
- Everyone should be concerned about environmental protection.
- Help by doing your share.

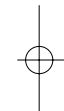
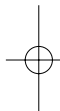

CARING FOR YOUR VEHICLE UNDER 0°C (32°F)

CARING FOR YOUR VEHICLE UNDER 0°C (32°F)

During the winter, undesirable road conditions frequently happen. Therefore, appropriate preparations for emergencies should occur.

Before driving in suburban or rural areas, or on a snowing day, have bags of sand, snow chains, a shovel, gloves, and old clothes in your vehicle.

Coolant

Before it gets cold, check the coolant level.

The conventional coolant is the 50:50 mixture of water and antifreeze.

If only water has been added into the coolant reservoir, the engine and the cooling system of your vehicle may seriously be damaged when the water freezes as it gets below the freezing point.

CAUTION

- When the vehicle is shipped, the cooling system is filled with a four-season coolant.
- Before adding or refilling coolant, ensure that the coolant is a 50:50 mixture of water and antifreeze.
- Use only Ssangyong genuine coolant.

Washer Fluid

Use a genuine coolant that does not freeze on a cold day.

When non-recommended washer liquid is used, the liquid may form an ice. This will damage the wiper motor and hinder your safe driving.

Engine Oil

When the vehicle is shipped, the engine is filled with four-season engine oil.

Tires

Snow tires are more desirable on an icy or snow-covered road. Have snow tires installed on your vehicle before driving on such a road.

CAUTION

- When snow tires are installed, drive your vehicle at a lower speed than normal.
- Install snow chains correctly. Otherwise, the chains may damage the wheelhouses or the body of your vehicle.

Air Conditioner

When the air conditioner has not been used for an extended period of time, internal packing systems may become hard because the lubricating system has not worked for a prolonged amount of time. As a result, the refrigerant may leak or rusting may happen to the system. Malfunction of the air conditioner may result.

To maintain its optimal operating condition, it is recommended that the air conditioner be turned on for approximately 5 to 10 minutes every week throughout all seasons.

CAUTION

- Do not remove the refrigerant in the winter, even though you do not use the air conditioner.

STARTING THE ENGINE AND DRIVING IN THE WINTER

Starting the Engine in the Winter

During the winter, the engine experiences increased resistance from the powertrain; the battery and the starter show decreased capacity. Therefore, start the engine in an appropriate way.

After starting the engine, allow time to warm it up before driving the vehicle. Warming up the engine will increase its life expectancy and help you drive safely.

CAUTION

The glow plugs of the diesel engine should sufficiently be warmed up before the engine starts.

Driving in the Winter

Maintain at least twice as long of a normal driving distance between your vehicle and the vehicle in front of you. When stopping, shift into a lower gear to use the engine brake.

Avoid speeding, abrupt acceleration, sudden braking, or drastic maneuvering of the steering wheel.

PARKING IN THE WINTER

When the parking brake is applied in cold weather, ice may form on the brake system and cause some difficulty moving the vehicle. When parking on a hill, first, apply the parking brake. Put the shift lever into the "1" or "R" position (Manual Transmission) or into the "P" position (Automatic Transmission). Put a chock behind a tire and release the parking brake.

WARNING

When ice forms on the parking brake system, an attempt to move the vehicle without removing the ice may damage your vehicle. Wait until the ice melts away and gently move your vehicle.

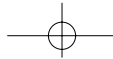

OTHER MAINTENANCE TIPS

After driving on a calcium chloride (salt) spayed road, wash the bottom of your vehicle as soon as possible to avoid any rust.

When parking on a snow-covered road, the brake system may begin to have some ice on it. The ice will decrease your vehicle's braking ability. If this happens, drive at a low speed and use the brake frequently to remove the ice. After regaining the braking ability, drive your vehicle at a normal speed.

WARNING

- When there is ice on the wiper blades, turning on the wiper switch may put an extra burden on the wiper motor and damage it. Avoid using the wipers when ice is on the blades.
- When driving on a snow-covered road, a large amount of snow may build up under each wheelhouse. This buildup prevents the steering wheel from moving freely. Therefore, remove the snow buildup frequently.

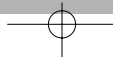

IMPORTANT SAFETY INSTRUCTIONS

BEFORE DRIVING

For safe and comfortable driving, check each part of the vehicle before driving your vehicle.

CAUTION

To inspect your vehicle effectively, park it on a level surface and check it in the following order.

Checking Problematic Parts

Check those parts that you felt they were problematic to see if they would be a hindrance on the road.

Checking the External Appearance of Your Vehicle

- Check for flat tires and check the air pressure.
- Check the side mirrors and the license plate for dirt or damage.
- Check all lights for damage or dirt.
- Check for oil stains under a parked car.

Checking the Driving Conditions:

- Adjustment of the rearview mirror
- Applying the brake and releasing the parking brake
- All warning lights and indicator lights
- All lighting devices
- The adjustment of driver's seat
- Make sure that headlights, tail lights, rear lights, license plate lights, backup lights, directional signals, and stop lights work properly.

CAUTION

When checking the lights, look for the reflections on walls and in the mirrors, or get someone to help you.

Checking Engine Compartment

Check the following:

- Engine oil
- Power steering fluid
- Brake fluid
- Cooling system
- Drive belt

Always Using Seat belt

Everyone in your vehicle needs to be buckled up at all times.

WARNING

- Children, pregnant or nursing women who fail to fasten their seat belts properly might suffer from an accident. Always use seat belts as directed.
- Please carefully read the seats, seat belts and air bags sections.

Do Not Leave a Child Alone in the Vehicle

When left alone in the car, a child might unintentionally start the engine, cause a fire, or cause another accident.

WARNING

- During the summer, the temperature in your vehicle rises due to direct sunlight, and a child who is unable to adjust vehicle devices is in danger of suffocation.
- Do not leave a child alone in the car.

Taking Care of Children

► Children should sit in the rear seat

To prevent children from interfering with your driving by accidental movements or misusing of devices, children should sit in the rear seat.

► Do not allow children to adjust comfort and safety devices

When a child gets in the vehicle, an adult should take care of doors, windows, seat belts, or seats making sure not to hurt the child's hands, feet or neck.

ON THE ROAD

If a Problem Occurs On the Road

- If a warning light comes on, immediately stop the vehicle in a safe place and take emergency measures.
- If your vehicle suffered a serious blow to the bottom, immediately stop the vehicle in a safe place and check for a fuel leak, brake fluid spill, or others and for damages to the underbody of your vehicle.
- If you have a sudden puncture or blowout on the road, keep your composure, grip the steering wheel firmly, brake gently to reduce your speed, and then stop in a safe place.

WARNING

If the front axle and tires were severely hit on the road and you notice steering problems (steering wheel shakes up and down / right and left / in circular motion), immediately visit the nearest Ssangyong Dealer or Ssangyong Authorized Workshop to check and repair steering and suspension parts.

Avoiding Unnecessary Movements While Driving

- While driving, do not turn off the ignition key under any circumstances. Brakes and power steering will not work.
- While driving, do not put your hands through the steering wheel to manipulate various switches. It might interfere with operating the steering wheel and cause an accident.

Parking in a Safe Place

Do not park in places where hay, foliage, paper, rags, oil, or other easily inflammable materials are kept.

CAUTION

While driving or after immediately driving, the muffler and exhaust pipe are hot; inflammable materials near the vehicle might cause a fire.

Turning The Engine Off When Taking A Nap

You might cause an accident by unconsciously shifting the transmission or stepping on the accelerator pedal, so turn the engine off.

CAUTION

Continuous application of the accelerator pedal overheats the engine and exhaust pipe and might cause a fire.

Turning The Engine Off When Leaving Your Car

- Turn the engine off and lock the doors.
- Do not leave valuables inside the car. Do not leave a child alone in the vehicle.

Moving Your Vehicle Only After Starting the Engine

Move your vehicle only after having started the engine.

WARNING

Driving the vehicle on a downhill using the downgrade slope without running the engine might cause an accident.

Parking Downhill

After firmly applying the park brake, set the shift lever in Reverse for vehicles with the manual transmission or set the shift lever in “P” for vehicles with the automatic transmission.

CAUTION

Place wheel chocks under the wheels.

Parking Uphill

After firmly applying the park brake, set the shift lever in first gear for vehicles with the manual transmission or set the shift lever in “P” for vehicles with the automatic transmission.

CAUTION

Place wheel chocks under the wheels.

When Parking or Stopping in An Enclosed Place

When parking or stopping in an enclosed place, turn off the engine.

WARNING

Leaving the engine running in an enclosed place, in a garage or indoors or in other areas with no air ventilation, might result in death from carbon monoxide poisoning.

Things To Watch For When Reversing

When reversing your vehicle, always make sure that there are no children or other obstacles behind the vehicle.

Driving in the Rain

When it is raining, the road surface becomes slippery and your tire-to-road traction is reduced, so you should drive more carefully than usual.

CAUTION

If you travel at a high speed on a wet road, your tires might not be in constant contact with the road; if your tires float, your vehicle starts hydroplaning. You might lose control of your steering and brakes.

After driving through a puddle of water, or after a car wash, apply your brake pedal lightly several times while moving slowly to confirm that your brakes work normally before getting on the road.

Putting Away Things That Interfere With Driving

WARNING

- Do not leave inflammable materials, such as disposable lighters or sprays, inside the vehicle. They might cause a fire or an explosion.
- Do not place objects under the driver's feet or cover the car bottom with a very thick carpet as it might interfere with applying your brake, clutch or accelerator pedals.

Using Engine Brakes On Long Downgrades

If you repeatedly apply the brake pedal, the brakes overheat and the braking effectiveness can deteriorate. When on a long downgrade, shift to a low gear and apply your brake pedal together with the engine brake.

NOTE

The engine brake slows down your vehicle while the accelerator pedal is not applied; down-shifting increases the effectiveness of this retarding force.

Always Putting Out Cigarettes

- Make sure you have put out all cigarettes and matches completely before throwing them into your ashtray.
- Do not put many cigarette butts or materials that easily catch fire into your ashtray.

CAUTION

For safer driving, refrain from smoking while on the road.

Being Careful With Accessories

Do not attach accessories or other unnecessary things to your car's windows as they might interfere with your driving.

Attached accessories can work as a convex lens and cause a fire or cause an accident.

Being Careful While Checking Your Coolant

When the engine is hot, never open the cap of the coolant tank. Hot steam or liquid might surge upwards and cause burns to your face or body.

Always Using Ssangyong Genuine Parts

- You can maintain the safety and performance of your car by using only specified parts or Ssangyong genuine parts.
- You can distinguish specified parts by their part numbers and seal.

CAUTION

- The warranty does not cover problems caused by using non-Ssangyong genuine parts.
- You can distinguish an authentic Ssangyong genuine part by its hologram.

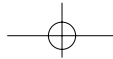

Driving on a Snowy or Icy Road

- Shift to the lowest possible gear and drive slowly.
- Since your braking distance is longer than usual, allow a longer following distance.
- If you accelerate or brake too fast, your vehicle will slide and you might get in an accident, so drive with caution. When braking, use the engine brake; apply your brakes only after you have slowed down considerably.
- When going down a slippery downhill, use the engine brake and drive slowly.

CAUTION

When traveling on a snowy or icy road, use snow tires for safer driving.

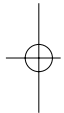

Driving on a Sandy or Muddy Road

- Keep your speed steady as low as possible.
- While driving, be careful not to accelerate or stop too quickly because you might get stuck in sand or mud.
- If your vehicle gets stuck in sand or mud, insert a rock or a piece of wood under the stuck wheel, lightly apply the accelerator pedal and gently shift back and forth between the reverse and forward gear to allow inertia to get your vehicle out.

CAUTION

If your vehicle is stuck in snow, sand or mud and you cannot get out, do not repeatedly depress the accelerator pedal. If possible, with the aid of other vehicle, rescue your vehicle.

Driving on Unpaved and Mountain Roads

- Before driving, check road conditions such as if the road suddenly ends, or if there is enough space for a U-turn in the middle of the road.
- It's easy to slide in a road covered with much sand or with much dry dirt. Keep your speed low and steady.
- There is a danger of collapse on the outside of a mountain road.
- When coasting downhill, do not change gears; go down slowly by applying the engine brake.

Going Through Water

- If water gets into the electric system or engine, it might cause irreparable damage to your vehicle. Please refrain from underwater driving.
- If going through water is unavoidable, choose a shallow spot where the exhaust outlet wouldn't get submerged in water and proceed slowly at a steady speed.
- Before going through water, get out of your vehicle and check the bottom of the river. Do not go through water if the bottom is sandy or covered with big rocks.
- If several vehicles are going through water together, the first vehicle might burrow into the bottom, so be careful and cross in a different place if possible.

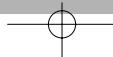

Freeway Driving

- Before getting on a freeway, listen to the weather forecast, prepare thoroughly and check the fuel level, brake system, cooling system, and tires.
- Always respect the speed limit and refrain from speeding.
- Allow for a safe following distance, avoid sudden steering movements.
- When it rains or snows and the weather conditions are adverse, double the distance between your vehicle and the vehicle running in front of you. And reduce your speed by half.

CAUTION

Do not idle the engine for a long time; it wastes fuel and causes environmental pollution.

- Drive at a slow speed for the first 2 km if possible.
- Do not load your vehicle with unnecessary stuff.
- Refrain from quick accelerating and abrupt braking, travel at a steady speed.
- When you park or stop for a long time, turn the engine off.
- Keep tires at the recommended pressure.
- Keep your vehicle in the best possible condition by periodically checking it and perform maintenance.

PROHIBITION OF UNAUTHORIZED MODIFICATIONS

This vehicle contains various advanced electronic and control devices. Do not modify them without authorization.

Modification of Fuses and Circuits

Always use the Ssangyong genuine fuses of the specified capacity and do not alter or modify your vehicle's circuits. It might cause a fire.

Prohibition of Window Tinting

Modification such as coloring windows might cause leaks. The dark tinted glass may obstruct the driver's field of vision. Thus, it may cause an accident.

Using Non-Specified Tires and Wheels

If using non-specified parts, the steering wheel feels heavier, fuel consumption increases, brake performance decreases and the steering wheel might shake, wearing out tires when you are traveling at a high speed.

Performing Regular Checks

Always check your vehicle as specified in the inspection schedule, replace parts when necessary and record in your vehicle diary which parts were replaced.

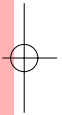
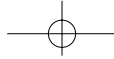

Section 15 Index

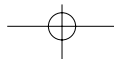

INDEX

4° aiming down of outside rearview mirror during reversing 6-16

A

ABS (Anti-lock Brake System) 6-18
Accident or fire 11-20
Accident 11-20
Air bag inspection 8-14
Air bag warning lamp 5-11
Air bag 8-13
Air cleaner element 12-10
Air conditioner AUTO/OFF switch/VFD 9-7
Air conditioner 9-6
Air flow directions 9-2
Air purifier filter replacement 4-20
Air purifier switch 4-19
Air source mode 9-10
Air source selection system (with AQS) 4-11
Air vent 9-4
AMB switch 9-12
Analog clock* 10-6
Auto cruise control* 4-28
Auto light, high beam, passing and battery saver 4-4
Automatic air conditioner control panel 9-6
Automatic door locking release 3-3
Automatic door locking system 3-3
Automatic operation mode 9-6
Automatic transmission safety mode 6-13
Av system control switch panel 4-26
AV/navigation system* 10-23

B

Battery replacement 2-5
Battery 12-20
Before driving 14-10
Brake fluid 12-15
Brake system and warning lamps 5-16
Bulb capacity and type 13-4

C

Card holder 10-17
Care and cleaning of the exterior 14-4
Care and cleaning of the interior 14-3
Caring for your vehicle under 0°C (32°F) 14-7
Cautions when a tire is flat 11-4
Cautions when checking the wheel and tire 12-31
Cautions with the air bag 8-14
Center switch panel 4-10
Central door locking system 3-3
Changer and navigation unit 10-24
Changing a flat tire 11-8
Changing a spare tire 11-7
Changing a tire and wheel 11-9
Changing tires 11-8
Characteristics of A/T vehicle 6-4
Charge warning lamp 5-12
Check engine indicator 1-9
Check the vehicle outside 1-2
Checking and adjustment 1-2
Checks before starting a journey 1-2
Child anchor (australia only) 8-8
Cleaning agents 14-2
Climate control system 9-2
Coat hanger (without sunroof) 10-18, 10-22
Convenience devices 10-2
Coolant 12-13
Cooling/heating switch for cup holder 4-25
Corrosion protection 14-5
Coupled operation (window, outside rearview mirror and sunroof) 2-9
Coupled operation with ignition key 3-7

D

Daily check list 12-8
Daily check 1-2
Defogger switch 9-12
Deluxe version (el display window) 5-10
Disp switch* 5-6

Door ajar warning lamp 5-13
Door courtesy lamp 13-11
Door lock button 2-4
Door unlock button 2-4
Doors 3-2
Driver's window switch 3-5
Driving impression when ESP is working 4-15
Driving vehicle with A/T 6-3
Dual sun visor with vanity mirror* 10-22

E

Easy access system (driver's seat) 7-6
ECS warning lamp and sport mode indicator 5-15
Emergency towing 11-18
Engine check warning lamp 5-12
Engine compartment fuse and relay box 12-24
Engine compartment 12-2, 12-9
Engine hood 3-9
Engine oil pressure warning lamp 5-13
Engine oil 12-7, 12-11
Engine overheating 11-13
Engine stop 1-3
ESP system 4-14
ESP* (Electronic Stability Program) 6-18
Exhaust gas regulation and vehicle maintenance 12-32
Exhaust gas 12-32
Exterior lamp location 13-2
Exterior 12-8

F

Fan switch 9-8
Fire 11-20
Foot brake 6-17
Foot rest* 10-10, 10-16
Front cigarette lighter and ashtray holder 10-8
Front console & armrest 10-5
Front cup holder and ashtray holder 10-7
Front door map pocket 10-4
Front fog lamp 13-6



INDEX

Front foot lamp 13-7
 Front room lamp 13-8
 Front seats 7-4
 Fuel filler 3-10, 12-17
 Fuel gauge/coolant temperature gauge 5-9
 Functional check 13-4
 Fuse and relay 12-22

G _____

Glass surfaces 14-4
 Glove box lamp 13-9
 Glove box 10-4

H _____

Head restraint 7-5
 Headlamp and position lamp 13-5
 Headlamp high/low beam indicator 5-12
 Headlamp leveling switch* 4-22
 How to check and replace fuse 12-23
 How to release the shift lever lock 11-15

I _____

Ignition key and remote control key 2-2
 Immobilizer system 2-10
 Important safety instructions 14-10
 Indications that the vehicle is in safety mode .. 6-13
 Infant and child safety 8-8
 Inserting the centering pin 11-9
 Inspection and maintenance schedule of the
 exhaust gas control system 12-34
 Inspection and maintenance schedule 12-36
 Inspection and maintenance 12-33
 Instrument cluster switches 4-17
 Instrument cluster 5-2
 Interior lamp location 13-3
 Interior lamp 4-23
 Interior lamps 13-7
 Interior switches 4-2
 Interior 12-8

J _____

Jacking point 11-8
 Jump start with an another vehicle or battery ... 11-2
 Jump start with jumper leads 11-2

K _____

Key functions 2-3

L _____

Lamps 13-2
 Left switch panel 4-8
 License plate lamp 13-6
 Light switch (with battery saving system) 4-3
 Light switch related devices 4-3
 Low coolant level warning lamp 5-11
 Low fuel level warning lamp 5-11
 Low washer fluid level warning lamp 5-14
 Lubricant specifications 0-2

M _____

Maintenance schedule and service interval 12-4
 Manual operation mode 9-6
 Manual shifting 6-8
 Massage switch* 7-15
 Meters and gauges 5-9
 Mode selection 6-12
 Mode switch* 5-5, 9-9
 Mood lamp 13-9

N _____

Noise and vibration that driver sense when ESP
 system is operating 4-15

O _____

Occupant safety 8-3
 On the road 14-12
 Opening and closing (door, glove box and trunk lid)
 2-8

Opening and closing (windows and others) 3-4
 Operation tips for the air conditioner 9-5
 Other maintenance tips 14-9
 Others 10-17
 Outside rearview mirror and inside rearview mirror
 4-7
 OVM tool box 11-6

P _____

Panic (emergency alarm) button 2-5
 Parking aid system displays 6-11
 Parking aid system* 6-10
 Parking in the winter 14-8
 Passenger's and rear window switch 3-6
 Passenger's seat control switch (on the left side of
 the seat) 7-8
 Passenger's seat control switch (rear armrest) ... 7-8
 Passenger's seat control switch and roller blind
 switch (rear glass) 7-11
 Pen storage (without sun roof) 10-9
 Position memory setting* 7-7
 Power and manual inside rearview mirror 10-20
 Power outlet and AV jack* 10-17
 Power steering fluid 12-16
 Power trunk* 3-13
 Power window 3-5
 Precautions regarding unauthorized modification &
 alteration 1-12
 Prohibition of unauthorized modifications 14-17

R _____

Rain sensing wiper 4-6
 Reading lamp (with sunroof) 4-24, 13-10
 Reading lamp (without sunroof) 4-24, 13-10
 Rear armrest and switch panel 10-12
 Rear armrest switch panel 4-26
 Rear armrest 10-11
 Rear center console 10-10
 Rear cigarette lighter 10-15
 Rear console box 10-14

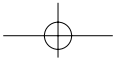

NEW CHAIRMAN OWNER'S MANUAL

ISSUED BY
OVERSEAS A/S TEAM
SSANGYONG MOTOR CO., LTD.

150-3, CHILGOI-DONG, PYUNGTAEK-SI
GYEONGGI-DO, 459-711 KOREA

TELEPHONE : 82-31-610-2740
FACSIMILE : 82-31-610-3762

NOTE: All rights reserved. Printed in SSANGYONG Motor Co., Ltd.
No part of this book may be used or reproduced without the
written permission of Overseas A/S Team.

