

HYUNDAI

OWNER'S MANUAL

Operation
Maintenance
Specifications

تلفن شماره روزی: ۰۲۱-۸۸۸۶۲۰۸۵

All information in this Owner's Manual is current at the time of publication. However, HYUNDAI reserves the right to make changes at any time so that our policy of continual product improvement may be carried out.

This manual applies to all models of this vehicle and includes descriptions and explanations of optional as well as standard equipment. As a result, you may find material in this manual that does not apply to your specific vehicle.

Please note that some models are equipped with Right-Hand Drive (RHD). The explanations and illustrations for some operations in RHD models are opposite of those written in this manual.

CAUTION: MODIFICATIONS TO YOUR HYUNDAI

Your HYUNDAI should not be modified in any way. Such modifications may adversely affect the performance, safety or durability of your HYUNDAI and may, in addition, violate conditions of the limited warranties covering the vehicle. Certain modifications may also be in violation of regulations established by the Department of Transportation and other government agencies in your country.

TWO-WAY RADIO OR CELLULAR TELEPHONE INSTALLATION

Your vehicle is equipped with electronic fuel injection and other electronic components. It is possible for an improperly installed/adjusted two-way radio or cellular telephone to adversely affect electronic systems. For this reason, we recommend that you carefully follow the radio manufacturer's instructions or consult your HYUNDAI dealer for precautionary measures or special instructions if you choose to install one of these devices.

WARNING! (IF EQUIPPED)

The car is equipped with a device of the system ERA-GLONASS which calls emergency services. Any self- or unauthorized interference in the system ERA-GLONASS, in vehicle systems and its components, installing of equipment which is not recommended by car manufacturer and / or in unauthorized Hyundai dealerships can cause incorrect operation (of the device of) the system ERA-GLONASS, making erroneous calls, causing failure of the device (in cars) in case of traffic accident or other accidents, when you need emergency care.

This may be dangerous and threaten your life!

SAFETY AND VEHICLE DAMAGE WARNING

This manual includes information titled as DANGER, WARNING, CAUTION and NOTICE. These titles indicate the following:

DANGER

DANGER indicates a hazardous situation which, if not avoided, will result in death or serious injury.

WARNING

WARNING indicates a hazardous situation which, if not avoided, could result in death or serious injury.

CAUTION

CAUTION indicates a hazardous situation which, if not avoided, could result in minor or moderate injury.

NOTICE

NOTICE indicates a situation which, if not avoided, could result in vehicle damage.

FOREWORD

Thank you for choosing HYUNDAI. We are pleased to welcome you to the growing number of distinguished people who drive HYUNDAI. The advanced engineering and high-quality construction of each HYUNDAI we build is something of which we're very proud.

Your Owner's Manual will introduce you to the features and operation of your new HYUNDAI. It is suggested that you read it carefully because the information it contains can contribute greatly to the satisfaction you receive from your new car.

The manufacturer also recommends that service and maintenance on your vehicle be performed by an authorized HYUNDAI dealer.

HYUNDAI MOTOR COMPANY

Note : Because future owners will also need the information included in this manual, if you sell this HYUNDAI, please leave the manual in the vehicle for their use. Thank you.

CAUTION

Severe engine and transaxle damage may result from the use of poor quality fuels and lubricants that do not meet HYUNDAI specifications. You must always use high quality fuels and lubricants that meet the specifications listed on Page 8-7 in the Vehicle Specifications section of the Owner's Manual.

Copyright 2016 HYUNDAI Motor Company. All rights reserved. No part of this publication may be reproduced, stored in any retrieval system or transmitted in any form or by any means without the prior written permission of HYUNDAI Motor Company.

HOW TO USE THIS MANUAL

We want to help you get the greatest possible driving pleasure from your vehicle. Your Owner's Manual can assist you in many ways. We strongly recommend that you read the entire manual. In order to minimize the chance of death or injury, you must read the WARNING and CAUTION sections in the manual.

Illustrations complement the words in this manual to best explain how to enjoy your vehicle. By reading your manual, you will learn about features, important safety information, and driving tips under various road conditions.

The general layout of the manual is provided in the Table of Contents. Use the index when looking for a specific area or subject; it has an alphabetical listing of all information in your manual.

Sections: This manual has eight chapters plus an index. Each section begins with a brief list of contents so you can tell at a glance if that section has the information you want.

Your safety, and the safety of others, is very important. This Owner's Manual provides you with many safety precautions and operating procedures. This information alerts you to potential hazards that may hurt you or others, as well as damage to your vehicle.

Safety messages found on vehicle labels and in this manual describe these hazards and what to do to avoid or reduce the risks.

Warnings and instructions contained in this manual are for your safety. Failure to follow safety warnings and instructions can lead to serious injury or death.

Throughout this manual DANGER, WARNING, CAUTION, NOTICE and the SAFETY ALERT SYMBOL will be used.



This is the safety alert symbol. It is used to alert you to potential physical injury hazards. Obey all safety messages that follow this symbol to avoid possible injury or death. The safety alert symbol precedes the signal words DANGER, WARNING and CAUTION.

DANGER

DANGER indicates a hazardous situation which, if not avoided, will result in death or serious injury.

WARNING

WARNING indicates a hazardous situation which, if not avoided, could result in death or serious injury.

FarmaSOS.com



CAUTION

CAUTION indicates a hazardous situation which, if not avoided, could result in minor or moderate injury.

NOTICE

NOTICE indicates a situation which, if not avoided, could result in vehicle damage.

FUEL REQUIREMENTS

Gasoline engine

Unleaded

For Europe

For the optimal vehicle performance, we recommend you use unleaded gasoline which has an octane rating of RON (Research Octane Number) 95 / AKI (Anti Knock Index) 91 or higher. (Do not use methanol blended fuels.)

You may use unleaded gasoline with an octane rating of RON 91-94 / AKI 87-90 but it may result in slight performance reduction of the vehicle.

Except Europe

Your new vehicle is designed to use only unleaded fuel having an Octane Rating of RON (Research Octane Number) 91 / AKI (Anti-Knock Index) 87 or higher. (Do not use methanol blended fuels.)

Your new vehicle is designed to obtain maximum performance with UNLEADED FUEL, as well as minimize exhaust emissions and spark plug fouling.



CAUTION

NEVER USE LEADED FUEL. The use of leaded fuel is detrimental to the catalytic converter and will damage the engine control system's oxygen sensor and affect emission control.

Never add any fuel system cleaning agents to the fuel tank other than what has been specified (We recommend that you consult an authorized HYUNDAI dealer for details.)



WARNING

- Do not "top off" after the nozzle automatically shuts off when refueling.
- Always check that the fuel cap is installed securely to prevent fuel spillage in the event of an accident.

Leaded (if equipped)

For some countries, your vehicle is designed to use leaded gasoline. When you are going to use leaded gasoline, we recommend that you ask an authorized HYUNDAI dealer whether leaded gasoline in your vehicle is available or not.

Octane Rating of leaded gasoline is same with unleaded one.

Gasoline containing alcohol and methanol

Gasohol, a mixture of gasoline and ethanol (also known as grain alcohol), and gasoline or gasohol containing methanol (also known as wood alcohol) are being marketed along with or instead of leaded or unleaded gasoline.

Do not use gasohol containing more than 10% ethanol, and do not use gasoline or gasohol containing any methanol. Either of these fuels may cause drivability problems and damage to the fuel system, engine control system and emission control system.

Discontinue using gasohol of any kind if drivability problems occur.

Vehicle damage or driveability problems may not be covered by the manufacturer's warranty if they result from the use of:

1. Gasohol containing more than 10% ethanol.
2. Gasoline or gasohol containing methanol.
3. Leaded fuel or leaded gasohol.

 **CAUTION**

Never use gasohol which contains methanol. Discontinue use of any gasohol product which impairs drivability.

Other fuels

Using fuels such as;

- Silicone (Si) contained fuel,
- MMT (Manganese, Mn) contained fuel,
- Ferrocene (Fe) contained fuel, and
- Other metallic additives contained fuels,

may cause vehicle and engine damage or cause plugging, misfiring, poor acceleration, engine stalling, catalyst melting, abnormal corrosion, life cycle reduction, etc.

Also, the Malfunction Indicator Lamp (MIL) may illuminate.

NOTICE

Damage to the fuel system or performance problem caused by the use of these fuels may not be covered by your New Vehicle Limited Warranty.

Use of MTBE

HYUNDAI recommends avoiding fuels containing MTBE (Methyl Tertiary Butyl Ether) over 15.0% vol. (Oxygen Content 2.7% weight) in your vehicle.

Fuel containing MTBE over 15.0% vol. (Oxygen Content 2.7% weight) may reduce vehicle performance and produce vapor lock or hard starting.



CAUTION

Your New Vehicle Limited Warranty may not cover damage to the fuel system and any performance problems that are caused by the use of fuels containing methanol or fuels containing MTBE (Methyl Tertiary Butyl Ether) over 15.0% vol. (Oxygen Content 2.7% weight.)

Do not use methanol

Fuels containing methanol (wood alcohol) should not be used in your vehicle. This type of fuel can reduce vehicle performance and damage components of the fuel system, engine control system and emission control system.

امداد خودرو فارما

تلفن شبانه روزی: ۰۲۱-۸۸۸۶۲۰۸۵

FarmaSOS.com

Fuel Additives

HYUNDAI recommends that you use unleaded gasoline which has an octane rating of RON (Research Octane Number) 95 / AKI (Anti Knock Index) 91 or higher (for Europe) or Octane Rating of RON (Research Octane Number) 91 / AKI (Anti-Knock Index) 87 or higher (except Europe).

For customers who do not use good quality gasolines including fuel additives regularly, and have problems starting or the engine does not run smoothly, one bottle of additives added to the fuel tank at every 15,000km (for Europe)/ 5,000km (except Europe). Additives are available from your authorized HYUNDAI dealer along with information on how to use them. Do not mix other additives.

Operation in foreign countries

If you are going to drive your vehicle in another country, be sure to:

- Observe all regulations regarding registration and insurance.
- Determine that acceptable fuel is available.

Diesel engine

Diesel fuel

Diesel engine must be operated only on commercially available diesel fuel that complies with EN 590 or comparable standard. (EN stands for "European Norm"). Do not use marine diesel fuel, heating oils, or non-approved fuel additives, as this will increase wear and cause damage to the engine and fuel system. The use of non-approved fuels and / or fuel additives will result in a limitation of your warranty rights.

Diesel fuel of above cetane 51 is used in your vehicle. If two types of diesel fuel are available, use summer or winter fuel properly according to the following temperature conditions.

- Above -5°C (23°F) ... Summer type diesel fuel.
- Below -5°C (23°F) ... Winter type diesel fuel.

Watch the fuel level in the tank very carefully : If the engine stops through fuel failure, the circuits must be completely purged to permit restarting.



CAUTION

Do not let any gasoline or water enter the tank. This would make it necessary to drain it out and to bleed the lines to avoid jamming the injection pump and damaging the engine.



CAUTION

It is recommended to use the regulated automotive diesel fuel for diesel vehicle equipped with the DPF system.

If you use diesel fuel including high sulfur (more than 50 ppm sulfur) and unspecified additives, it can cause the DPF system to be damaged and white smoke can be emitted.

Biodiesel

Commercially supplied Diesel blends of no more than 7% biodiesel, commonly known as "B7 Diesel" may be used in your vehicle if Biodiesel meets EN 14214 or equivalent specifications. (EN stands for "European Norm"). The use of biofuels exceeding 7% made from rapeseed methyl ester (RME), fatty acid methyl ester (FAME), vegetable oil methyl ester (VME) etc. or mixing diesel exceeding 7% with biodiesel will cause increased wear or damage to the engine and fuel system. Repair or replacement of worn or damaged components due to the use of non approved fuels will not be covered by the manufactures warranty.

CAUTION

- **Never use any fuel, whether diesel, B7 biodiesel or otherwise, that fails to meet the latest petroleum industry specification.**
- **Never use any fuel additives or treatments that are not recommended or approved by the vehicle manufacturer.**

تلفن شبانه روزی: ۰۲۱-۸۸۶۲۰۸۵

FarmaSOS.com

VEHICLE HANDLING INSTRUCTIONS

As with other vehicles of this type, failure to operate this vehicle correctly may result in loss of control, an accident or vehicle rollover.

Specific design characteristics (higher ground clearance, track, etc.) give this vehicle a higher center of gravity than other types of vehicles. In other words they are not designed for cornering at the same speeds as conventional 2-wheel drive vehicles. Avoid sharp turns or abrupt maneuvers. Again, failure to operate this vehicle correctly may result in loss of control, an accident or vehicle rollover. **Be sure to read the "Reducing the risk of a rollover" driving guidelines, in chapter 5 of this manual.**

VEHICLE BREAK-IN PROCESS

No special break-in period is needed. By following a few simple precautions for the first 1,000 km (600 miles) you may add to the performance, economy and life of your vehicle.

- Do not race the engine.
- While driving, keep your engine speed (rpm, or revolutions per minute) between 2,000 rpm and 4,000 rpm.
- Do not maintain a single speed for long periods of time, either fast or slow. Varying engine speed is needed to properly break-in the engine.
- Avoid hard stops, except in emergencies, to allow the brakes to seat properly.
- Don't tow a trailer during the first 2,000 km (1,200 miles) of operation.

RETURNING USED VEHICLES (FOR EUROPE)

HYUNDAI promotes an environmentally sound treatment for end of life vehicles and offers to take back your Hyundai end of life vehicles in accordance with the European Union (EU) End of Life Vehicles Directive.

You can get detailed information from your national HYUNDAI homepage.

تلفن شبانه روزی: ۰۲۱-۸۸۸۶۲۰۸۵

FarmaSOS.com

امداد خودرو فارما

تلفن شبانه روزی: ۰۲۱-۸۸۸۶۲۰۸۵

FarmaSOS.com

TABLE OF CONTENTS

Your vehicle at a glance	1
Safety system of your vehicle	2
Convenient features of your vehicle	3
Multimedia System	4
Driving your vehicle	5
What to do in an emergency	6
Maintenance	7
Specifications & Consumer information	8
Appendix / Index	A/I

ایراد خودرو فارما

تلفن شبانه روزی: ۰۸۵-۸۸۶۲-۰۲۱

FarmasOS.com

Your vehicle at a glance

Exterior overview (I)	1-2
Exterior overview (II)	1-3
Interior overview.....	1-4
Instrument panel overview (I).....	1-5
Instrument panel overview (II).....	1-6
Engine compartment	1-7

1

امداد خودرو فارما

تلفن شبانه روزی: ۰۲۱-۸۸۸۶۲۰۸۵

FarmaSOS.com

EXTERIOR OVERVIEW (I)

■ Front view



- 1. Panorama sunroof3-37
- 2. Front windshield wiper blades7-42
- 3. Outside rearview mirror3-29
- 4. Door locks.....3-14
- 5. Head lamp.....3-110, 7-76
- 6. DRL (Daytime Running Light)3-114
- 7. Front fog lamp.....3-112
- 8. Hood3-42
- 9. Tires and wheels7-48
- 10. Driver assist system3-126

The actual shape may differ from the illustration.

OTLE015006

EXTERIOR OVERVIEW (II)

■ Rear view

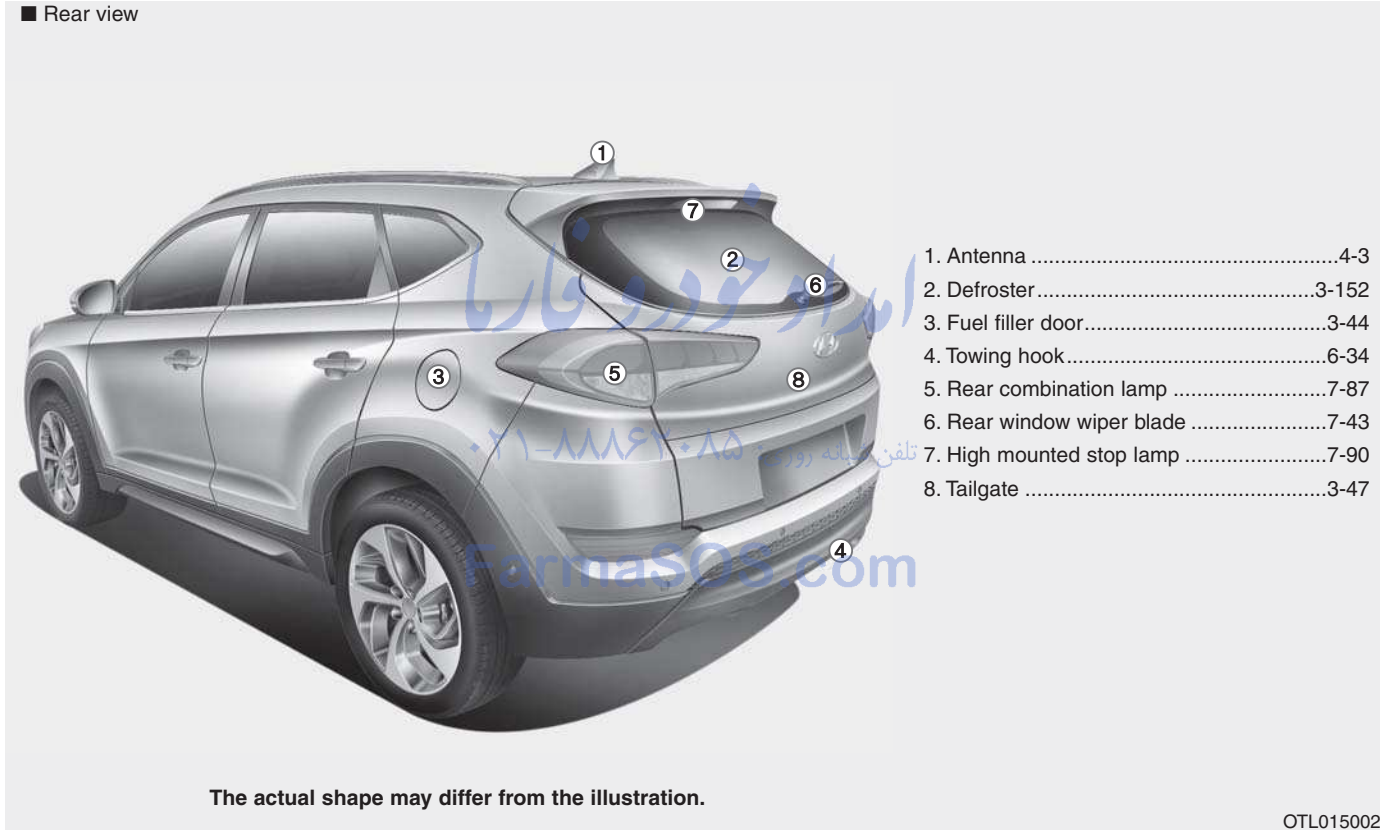

INTERIOR OVERVIEW

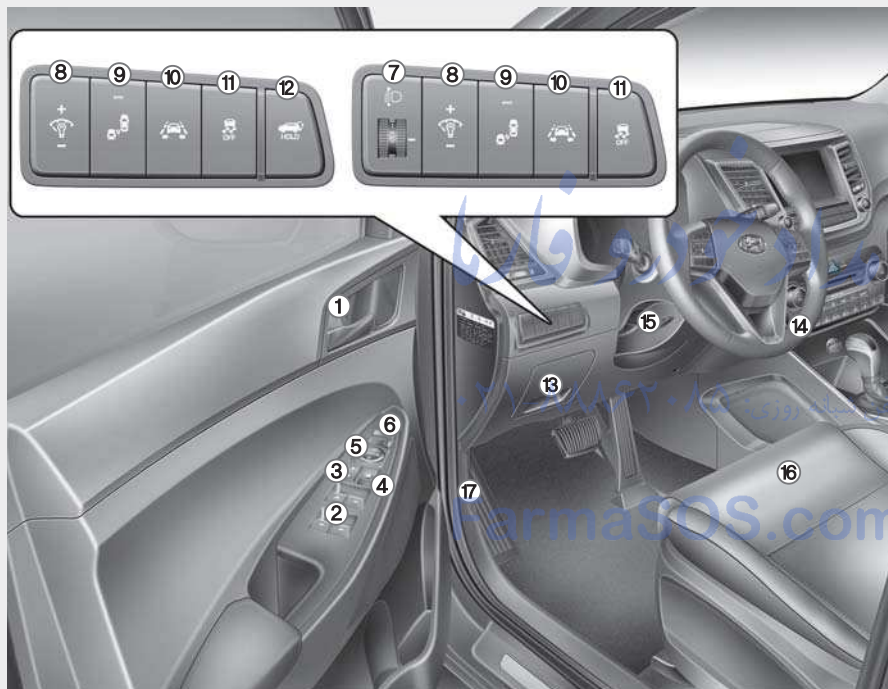

- 1. Door lock/unlock button3-16
- 2. Power window switches3-32
- 3. Central door lock switch3-17
- 4. Power window lock switch3-35
- 5. Outside rearview mirror control switch3-30
- 6. Outside rearview mirror folding button3-31
- 7. Headlight leveling device3-114
- 8. Instrument panel illumination control switch3-62
- 9. Blind spot detection (BSD) button5-82
- 10. Lane keeping assist system (LKAS)5-106
- 11. ESC OFF button5-55
- 12. Power tailgate button3-49
- 13. Fuse box.....7-60
- 14. Steering wheel3-22
- 15. Steering wheel tilt control3-23
- 16. Seat2-4
- 17. Hood release lever3-42

The actual shape may differ from the illustration.

OTLE015003

INSTRUMENT PANEL OVERVIEW (I)



1. Light control/Turn signals3-109
2. Steering wheel audio controls/
Bluetooth phone controls4-4
3. Instrument cluster3-60
4. Wiper/Washer.....3-122
5. Speed limit control/
Cruise control5-115/5-117
6. Horn3-24
7. Driver's front air bag.....2-52
8. Ignition switch5-6
9. Audio/AVN4-6/Separate manual
10. Hazard warning flasher switch.....6-2
11. Climate control system3-154, 3-165
12. Passenger's front air bag2-52
13. Glove box3-184
14. Cup holder3-186
15. Shift lever.....5-20, 5-24, 5-31
16. Console box3-183

The actual shape may differ from the illustration.

OTL015004

INSTRUMENT PANEL OVERVIEW (II)



1. Power outlet3-188
2. Aux, USB and iPod®4-2
3. Cigarette lighter3-190
4. Electronic parking brake (EPB) switch5-43
5. Drive mode button5-80
6. AUTO HOLD button5-49
7. Rear parking assist button / Parking assist system3-131/3-127
8. Downhill brake control (DBC) button..5-61
9. 4WD LOCK button/ Idle stop and go (ISG)5-65/5-72
10. Smart parking assist system (SPAS) button3-134
11. Flex steering wheel button.....5-78

The actual shape may differ from the illustration.

OTLE015005

ENGINE COMPARTMENT

■ Gasoline Engine (Gamma 1.6L GDI)

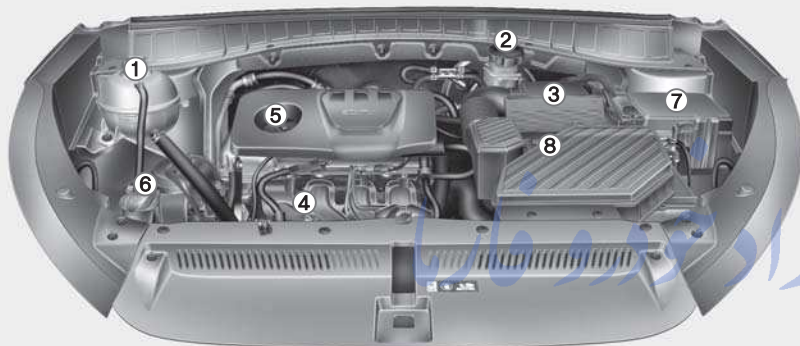

- 1. Engine coolant reservoir/
Radiator cap.....7-31
- 2. Brake/clutch fluid reservoir7-35
- 3. Air cleaner.....7-38
- 4. Engine oil dipstick7-28
- 5. Engine oil filler cap7-28
- 6. Windshield washer fluid reservoir.....7-36
- 7. Fuse box7-60
- 8. Battery.....7-44

■ Gasoline Engine (Gamma 1.6L T-GDI)

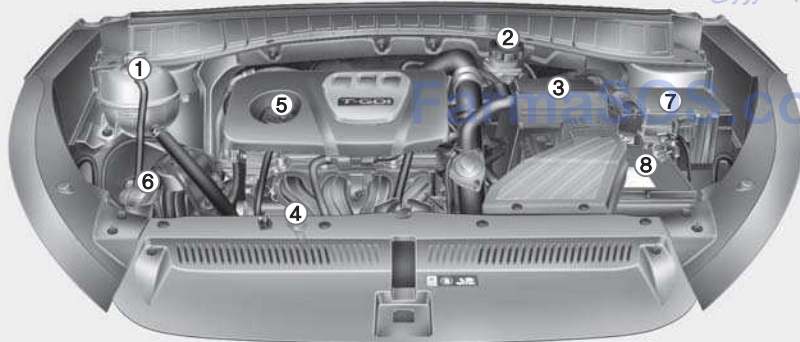

The actual engine room in the vehicle may differ from the illustration.

OTLE075001/OTLE075002

تلفن شبانه روزی: ۰۲۱-۸۸۶۲۰۸۵

Forma3.com

■ Gasoline Engine (Nu 2.0 MPI)

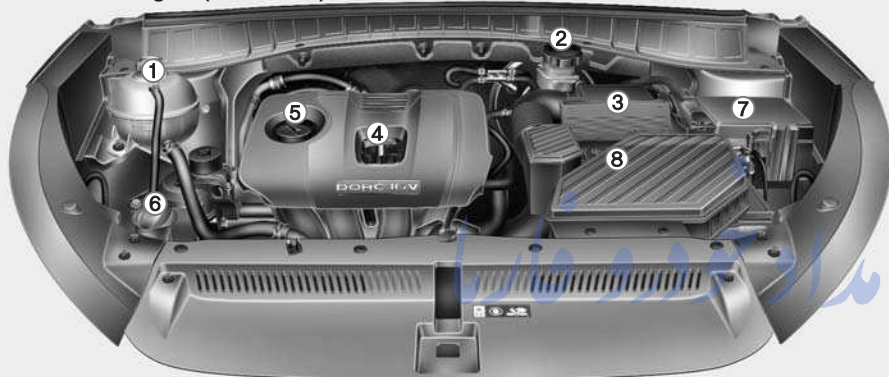

1. Engine coolant reservoir/
Radiator cap.....7-31
2. Brake/clutch fluid reservoir7-35
3. Air cleaner.....7-38
4. Engine oil dipstick7-28
5. Engine oil filler cap7-28
6. Windshield washer fluid reservoir.....7-36
7. Fuse box7-60
8. Battery.....7-44

■ Gasoline Engine (Theta II 2.4 GDI)

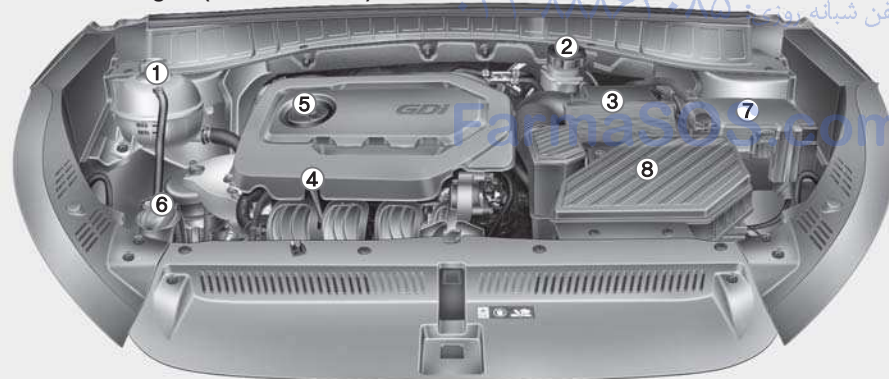

The actual engine room in the vehicle may differ from the illustration.

OTLE075003/OTLE075104

■ Diesel Engine (U2 1.7 TCI)

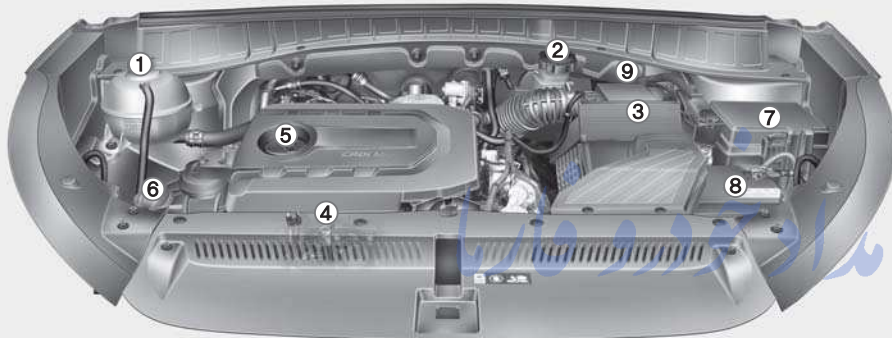

- 1. Engine coolant reservoir/
Radiator cap.....7-31
- 2. Brake/clutch fluid reservoir7-35
- 3. Air cleaner.....7-38
- 4. Engine oil dipstick7-29
- 5. Engine oil filler cap7-30
- 6. Windshield washer fluid reservoir.....7-36
- 7. Fuse box7-60
- 8. Battery.....7-44
- 9. Fuel filter7-37

■ Diesel Engine (R 2.0 TCI)

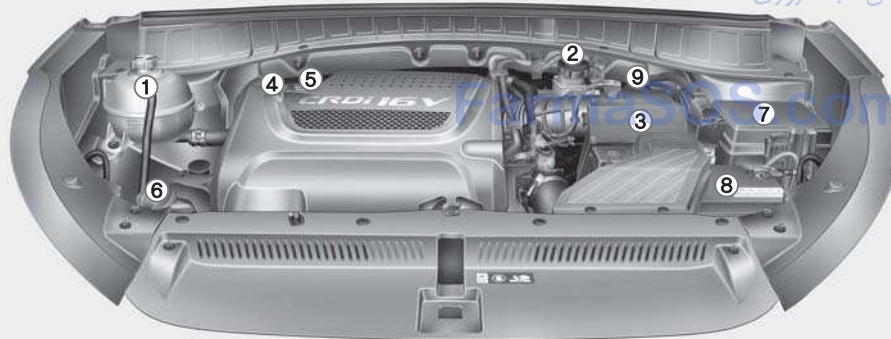

The actual engine room in the vehicle may differ from the illustration.

OTL075002/OTL075001

Safety system of your vehicle

This chapter provides you with important information about how to protect yourself and your passengers. It explains how to properly use your seats and seat belts, and how your air bags work. Additionally, this chapter explains how to properly restrain infants and children in your vehicle.

Important safety precautions	2-2	Child Restraint System (CRS)	2-38
Always wear your seat belt.....	2-2	Our Recommendation: Children always in the rear ...	2-38
Restrain all children.....	2-2	Selecting a Child Restraint System (CRS)	2-39
Air bag hazards.....	2-2	Installing a Child Restraint System (CRS).....	2-41
Driver distraction.....	2-2	Air bag	
Control your speed.....	2-3	- supplemental restraint system.....	2-50
Keep your vehicle in safe condition.....	2-3	Where are the air bags?	2-52
Seats	2-4	How does the air bags system operate?	2-57
Safety precautions.....	2-5	What to expect after an air bag inflates.....	2-61
Front seats.....	2-6	Do not install a Child Restraint System on the front	
Rear seats.....	2-13	passenger seat unless the air bag is deactivated ...	2-62
Headrest	2-16	Why didn't my air bag go off in a collision?	2-63
Seat warmers and air ventilation seats.....	2-20	SRS care	2-68
Seat belts	2-24	Additional safety precautions	2-69
Seat belt safety precautions.....	2-24	Air bag warning labels.....	2-69
Seat belt warning light	2-25	Active hood lift system	2-70
Seat belt restraint system	2-28	Possible activation situations.....	2-70
Additional seat belt safety precautions	2-34	Non-activation situations.....	2-71
Care of seat belts	2-37	System malfunction.....	2-72

IMPORTANT SAFETY PRECAUTIONS

You will find many safety precautions and recommendations throughout this section, and throughout this manual. The safety precautions in this section are among the most important.

Always wear your seat belt

A seat belt is your best protection in all types of accidents. Air bags are designed to supplement seat belts, not replace them. So even though your vehicle is equipped with air bags, **ALWAYS** make sure you and your passengers wear your seat belts, and wear them properly.

Restrain all children

All children under age 13 should ride in your vehicle properly restrained in a rear seat, not the front seat. Infants and small children should be restrained in an appropriate Child Restraint System. Larger children should use a booster seat with the lap/shoulder belt until they can use the seat belt properly without a booster seat.

Air bag hazards

While air bags can save lives, they can also cause serious or fatal injuries to occupants who sit too close to them, or who are not properly restrained. Infants, young children, and short adults are at the greatest risk of being injured by an inflating air bag. Follow all instructions and warnings in this manual.

Driver distraction

Driver distraction presents a serious and potentially deadly danger, especially for inexperienced drivers. Safety should be the first concern when behind the wheel and drivers need to be aware of the wide array of potential distractions, such as drowsiness, reaching for objects, eating, personal grooming, other passengers, and using cellular phones.

Drivers can become distracted when they take their eyes and attention off the road or their hands off the wheel to focus on activities other than driving. To reduce your risk of distraction and an accident:

- **ALWAYS** set up your mobile devices (i.e., MP3 players, phones, navigation units, etc.) when your vehicle is parked or safely stopped.
- **ONLY** use your mobile device when allowed by laws and conditions permit safe use. **NEVER** text or email while driving. Most countries have laws prohibiting drivers from texting. Some countries and cities also prohibit drivers from using handheld phones.

- NEVER let the use of a mobile device distract you from driving. You have a responsibility to your passengers and others on the road to always drive safely, with your hands on the wheel as well as your eyes and attention on the road.

Control your speed

Excessive speed is a major factor in crash injuries and deaths. Generally, the higher the speed, the greater the risk, but serious injuries can also occur at lower speeds. Never drive faster than is safe for current conditions, regardless of the maximum speed posted.

Keep your vehicle in safe condition

Having a tire blowout or a mechanical failure can be extremely hazardous. To reduce the possibility of such problems, check your tire pressures and condition frequently, and perform all regularly scheduled maintenance.

امداد خودرو فارما

تلفن شبانه روزی: ۰۲۱-۸۸۸۶۲۰۸۵

FarmaSOS.com

SEATS

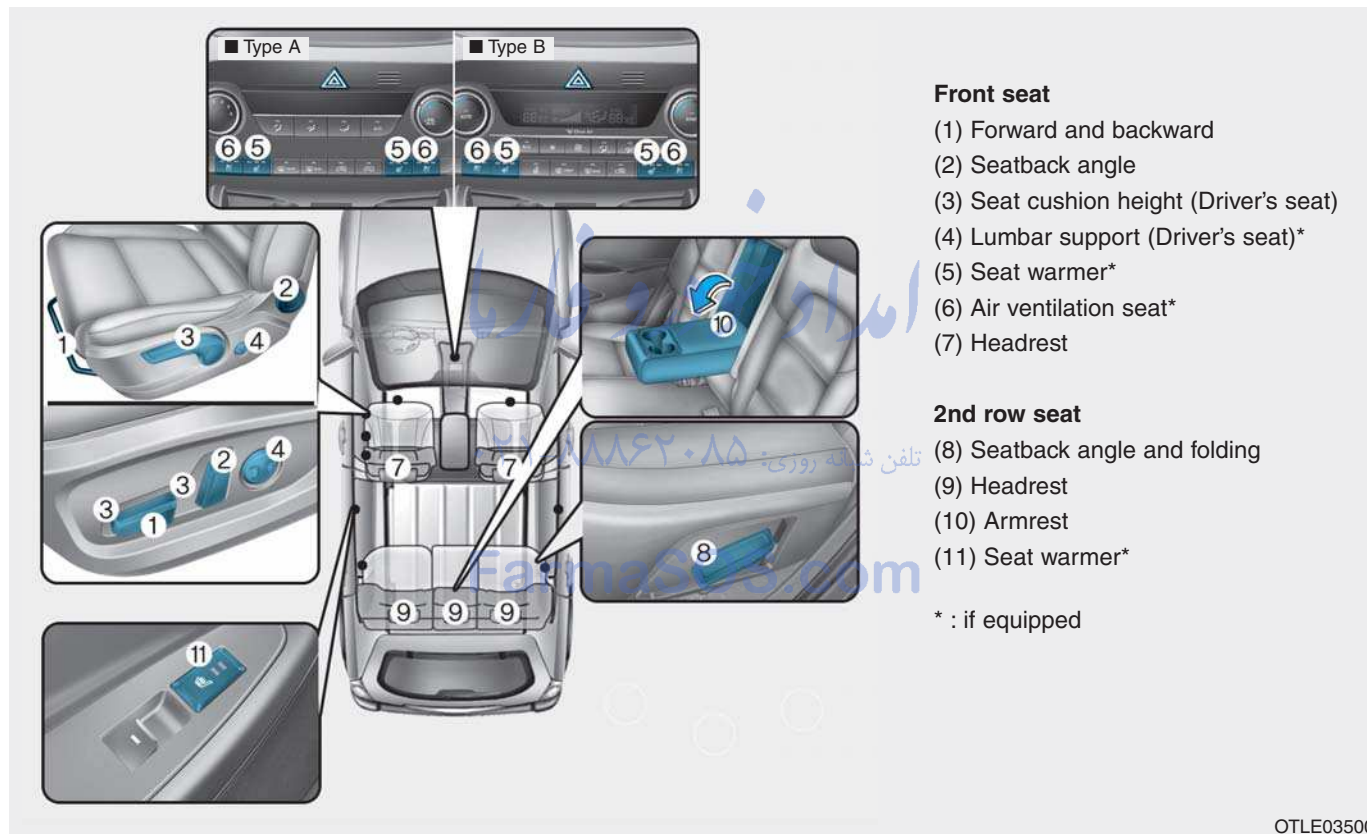

Safety precautions

Adjusting the seats so that you are sitting in a safe, comfortable position plays an important role in driver and passenger safety together with the seat belts and air bags in an accident.

WARNING

Do not use a cushion that reduces friction between the seat and the passenger. The passenger's hips may slide under the lap portion of the seat belt during an accident or a sudden stop.

Serious or fatal internal injuries could result because the seat belt cannot operate properly.

Air bags

You can take steps to reduce the risk of being injured by an inflating air bag. Sitting too close to an air bag greatly increases the risk of injury in the event the air bag inflates. Move your seat as far back as possible from front air bags, while still maintaining control of the vehicle.

WARNING

To reduce the risk of serious injury or death from an inflating air bag, take the following precautions:

- Adjust the driver's seat as far to the rear as possible maintaining the ability to control of the vehicle.
- Adjust the front passenger seat as far to the rear as possible.

(Continued)

(Continued)

- **Hold the steering wheel by the rim with hands at the 9 o'clock and 3 o'clock positions to minimize the risk of injuries to your hands and arms.**
- **NEVER place anything or anyone between the air bag.**
- **Do not allow the front passenger to place feet or legs on the dashboard to minimize the risk of leg injuries.**

Seat belts

Always fasten your seat belt before starting any trip.

At all times, passengers should sit upright and be properly restrained. Infants and small children must be restrained in appropriate Child Restraint Systems. Children who have outgrown a booster seat and adults must be restrained using the seat belts.

WARNING

Take the following precautions when adjusting your seat belt:

- NEVER use one seat belt for more than one occupant.
- Always position the seatback upright with the lap portion of the seat belt snug and low across the hips.
- NEVER allow children or small infants to ride in a passenger's lap.

(Continued)

(Continued)

- Do not route the seat belt across your neck, across sharp edges, or reroute the shoulder strap away from your body.
- Do not allow the seat belt to become caught or jammed.

امداد خودرو فارما

تلفن شبانه روزی: ۰۲۱-۸۸۸۶۲۰۸۵

FarmaSOS.com

Front seats

The front seat can be adjusted by using the control switches located on the outside of the seat cushion. Before driving, adjust the seat to the proper position so that you can easily control the steering wheel, foot pedals and controls on the instrument panel.

WARNING

Take the following precautions when adjusting your seat:

- NEVER attempt to adjust the seat while the vehicle is moving. The seat could respond with unexpected movement and may cause loss of vehicle control resulting in an accident.
- Do not place anything under the front seats. Loose objects in the driver's foot area could interfere with the operation of the foot pedals, causing an accident.

(Continued)

(Continued)

- Do not allow anything to interfere with the normal position and proper locking of the seat-back.
- Do not place a cigarette lighter on the floor or seat. When you operate the seat, gas may exit out of the lighter causing a fire.
- Use extreme caution when picking small objects trapped under the seats or between the seat and the center console. Your hands might be cut or injured by the sharp edges of the seat mechanism.
- If there are occupants in the rear seats, be careful while adjusting the front seat position.

⚠ CAUTION

To prevent injury:

- Do not adjust your seat while wearing your seat belt. Moving the seat cushion forward may cause strong pressure on your abdomen.
- Do not allow your hands or fingers to get caught in the seat mechanisms while the seat is moving.

تلفن شبانه روزی: ۰۲۱-۸۸۶۲۰۸۵

FarmaSOS.com

Manual adjustment

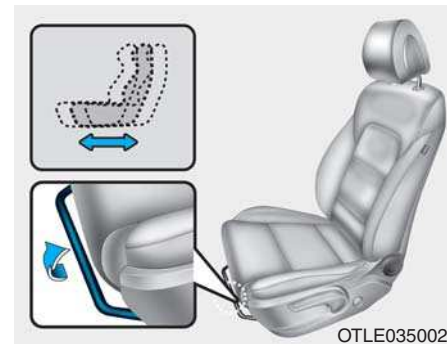

Forward and rearward adjustment

To move the seat forward or rearward:

1. Pull up the seat slide adjustment lever and hold it.
2. Slide the seat to the position you desire.
3. Release the lever and make sure the seat is locked in place. Move forward and rearward without using the lever. If the seat moves, it is not locked properly.

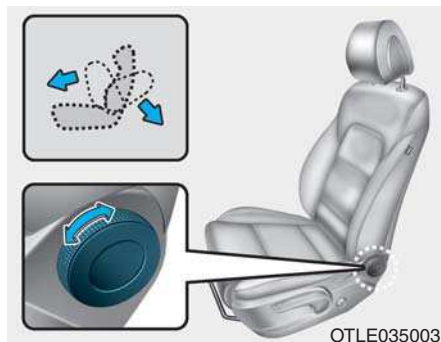

Seatback angle

To recline the seatback:

1. Roll the seatback knob rearward.
2. Carefully lean back on the seat and adjust the seatback to the position you desire.
3. Release the knob and make sure the seatback is locked in place.

Reclining seatback

Sitting in a reclined position when the vehicle is in motion can be dangerous. Even when buckled up, the protections of your restraint system (seat belts and/or air bags) is greatly reduced by reclining your seatback.

! WARNING

NEVER ride with a reclined seatback when the vehicle is moving.

Riding with a reclined seatback increases your chance of serious or fatal injuries in the event of a collision or sudden stop.

Drivers and passengers should ALWAYS sit well back in their seats, properly belted, and with the seatbacks upright.

Seat belts must be snug against your hips and chest to work properly. When the seatback is reclined, the shoulder belt cannot do its job because it will not be snug against your chest. Instead, it will be in front of you. During an accident, you could be thrown into the seat belt, causing neck or other injuries.

The more the seatback is reclined, the greater chance the passenger's hips will slide under the lap belt or the passenger's neck will strike the shoulder belt.

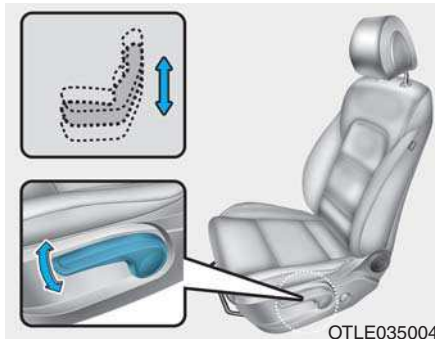

Seat cushion height (for driver's seat)
To change the height of the seat cushion:

- Push down the lever several times, to lower the seat cushion.
- Pull up the lever several times, to raise the seat cushion.

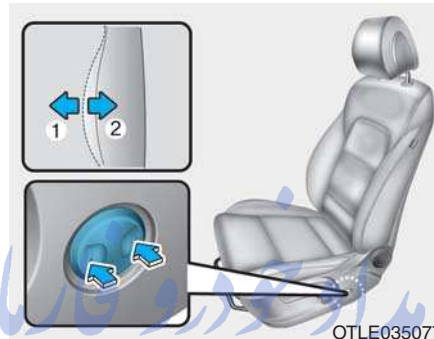

Lumbar support (for driver's seat, if equipped)

The lumbar support can be adjusted by pressing the lumbar support switch on the side of the seat.

1. Press the front portion of the switch to increase support, or the rear portion of the switch, to decrease support.
2. Release the switch once it reaches the desired position.

Power adjustment

The front seat can be adjusted by using the control switches located on the outside of the seat cushion. Before driving, adjust the seat to the proper position so that you can easily control the steering wheel, foot pedals and controls on the instrument panel.

⚠ WARNING

NEVER allow children in the vehicle unattended. The power seats are operable when the engine is turned off.

NOTICE

To prevent damage to the seats:

- Always stop adjusting the seats when the seat has been adjusted as far forward or rearward as possible.
- Do not adjust the seats longer than necessary when the engine is turned off. This may result in unnecessary battery drain.
- Do not operate two or more seats at the same time. This may result in an electrical malfunction.

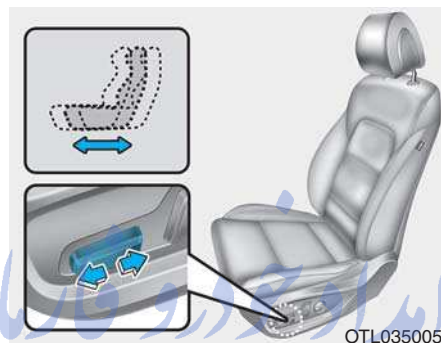

Forward and rearward adjustment

To move the seat forward or rearward:

1. Push the control switch forward or rearward.
2. Release the switch once the seat reaches the desired position.

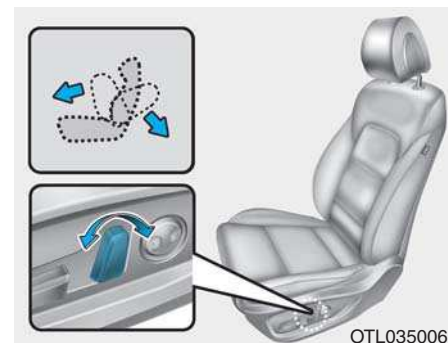

Seatback angle

To recline the seatback:

1. Push the control switch forward or rearward.
2. Release the switch once the seatback reaches the desired position.

FarmaSOS.com

Reclining seatback

Sitting in a reclined position when the vehicle is in motion can be dangerous. Even when buckled up, the protections of your restraint system (seat belts and air bags) is greatly reduced by reclining your seatback.

⚠ WARNING

NEVER ride with a reclined seatback when the vehicle is moving. Riding with a reclined seatback increases your chance of serious or fatal injuries in the event of a collision or sudden stop.

Driver and passengers should **ALWAYS** sit well back in their seats, properly belted, and with the seatbacks upright.

Seat belts must be snug against your hips and chest to work properly. When the seatback is reclined, the shoulder belt cannot do its job because it will not be snug against your chest. Instead, it will be in front of you. During an accident, you could be thrown into the seat belt, causing neck or other injuries.

The more the seatback is reclined, the greater chance the passenger's hips will slide under the lap belt or the passenger's neck will strike the shoulder belt.

تلفن شبانه روزی: ۰۲۱-۸۸۶۲۰۸۵

FarmaSOS.com

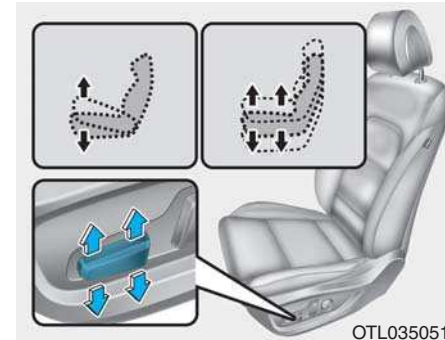

Seat cushion height (if equipped)

To change the height of the seat cushion:

1. • Push the front portion of the control switch up to raise or down to lower the front part of the seat cushion.
 - Push the rear portion of the control switch up to raise or down to lower the height of the seat cushion.
2. Release the switch once the seat reaches the desired position.

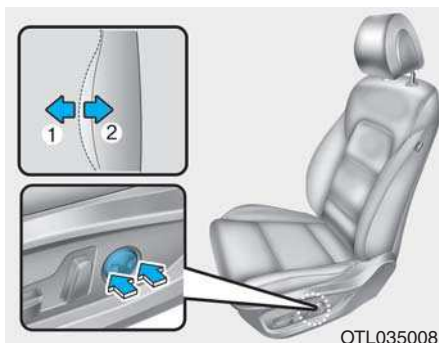

Lumbar support (for driver's seat, if equipped)

- The lumbar support can be adjusted by pressing the lumbar support switch.
- Press the front portion of the switch (1) to increase support or the rear portion of the switch (2) to decrease support.

Seatback pocket

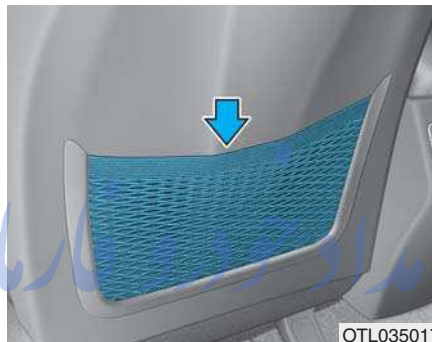

The seatback pocket is provided on the back of the front seatbacks.

CAUTION

Do not put heavy or sharp objects in the seatback pockets. In an accident they could come loose from the pocket and injure occupants.

FarmaSOS.com

Rear seats

Folding the rear seat

The rear seatbacks can be folded to facilitate carrying long items or to increase the luggage capacity of the vehicle.

WARNING

- **Never allow passengers to sit on top of the folded down seatback while the vehicle is moving. This is not a proper seating position and no seat belts are available for use. This could result in serious injury or death in case of an accident or sudden stop.**
- **Objects carried on the folded down seatback should not extend higher than the top of the front seatbacks. This could allow cargo to slide forward and cause injury or damage during sudden stops.**

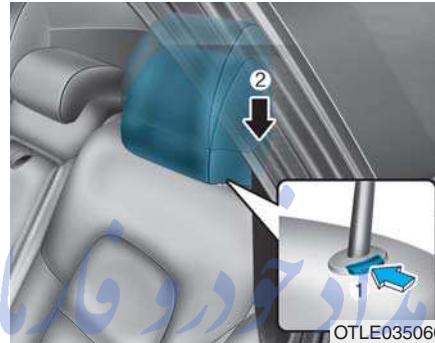

To fold down the rear seatback:

1. Set the front seatback to the upright position and if necessary, slide the front seat forward. تلفن شبانه روزی: ۰۲۱-۸۸۸۸۸۸۸۸
2. Lower the rear head restraints to the lowest position.

FarmaSOS.com

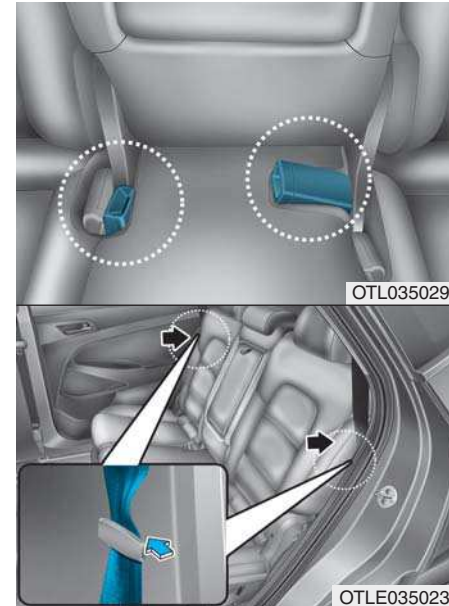

3. Insert the rear seat belt buckle in the pocket between the rear seatback and cushion, and insert the rear seat belt webbing in the guide to prevent the seat belt from being damaged.

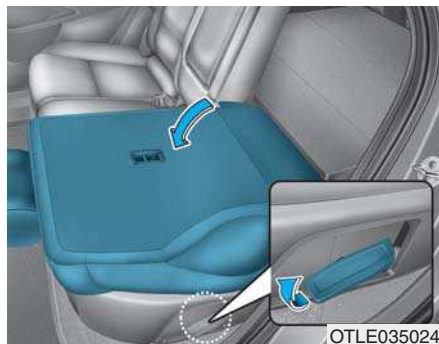

4. Lift up the front portion of the seatback folding lever, then fold the seat toward the front of the vehicle. When you return the seatback to its upright position, always be sure it has locked into position by pushing on the top of the seatback.

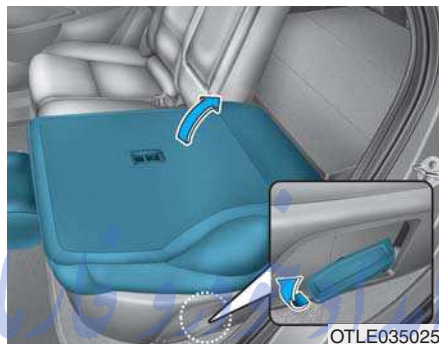

5. To use the rear seat, lift and push the seatback rearward by lifting up the front portion of the folding lever. Push the seatback firmly until it clicks into place. Make sure the seatback is locked in place.

WARNING

When returning the rear seatback from a folded to an upright position, hold the seatback and return it slowly. Ensure that the seatback is completely locked into its upright position by pushing on the top of the seatback. In an accident or sudden stop, the unlocked seatback could allow cargo to move forward with great force and enter the passenger compartment, which could result in serious injury or death.

WARNING

Do not place objects in the rear seats, since they cannot be properly secured and may hit vehicle occupants in a collision causing serious injury or death.

FarmaSOS.com

⚠ WARNING

Make sure the engine is off, the shift lever is in P (Park), and the parking brake is securely applied whenever loading or unloading cargo. Failure to take these steps may allow the vehicle to move if the shift lever is inadvertently moved to another position.

Armrest

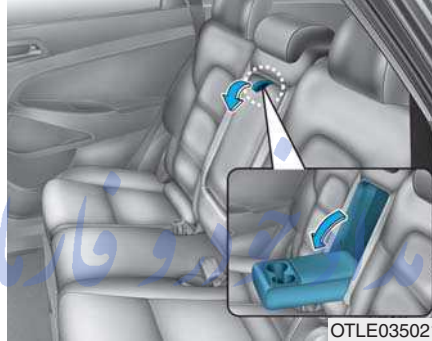

The armrest is located in the center of the rear seat. Pull the armrest down from the seatback to use it.



Cup holder

To use the center cup holder, pull down the armrest.

FarmaSOS.com

Headrest

The vehicle's front and rear seats have adjustable headrests. The headrests provide comfort for passengers, but more importantly they are designed to help protect passengers from whiplash and other neck and spinal injuries during an accident, especially in a rear impact collision.

WARNING

To reduce the risk of serious injury or death in an accident, take the following precautions when adjusting your headrests:

- Always properly adjust the headrests for all passengers **BEFORE** starting the vehicle.
- **NEVER** let anyone ride in a seat with the headrest removed.

(Continued)

(Continued)

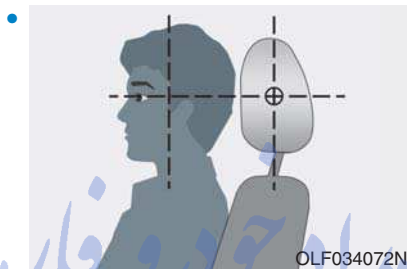

- Adjust the headrests so the middle of the headrests is at the same height as the height of the top of the eyes.
- **NEVER** adjust the headrest position of the driver's seat when the vehicle is in motion.
- Adjust the headrest as close to the passenger's head as possible. Do not use a seat cushion that holds the body away from the seatback.
- Make sure the headrest locks into position after adjusting it.

NOTICE

To prevent damage, **NEVER** hit or pull on the headrests.

CAUTION

When there is no occupant in the rear seats, adjust the height of the headrest to the lowest position. The rear seat headrest can reduce the visibility of the rear area.

Front seat headrests

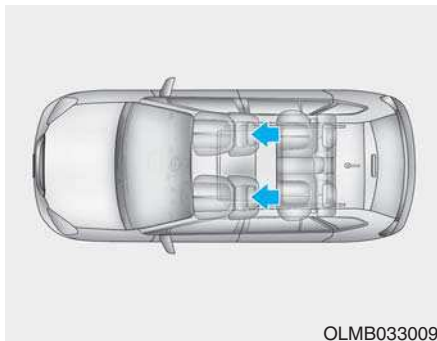

The driver's and front passenger's seats are equipped with adjustable headrests for the passengers safety and comfort.



Forward and rearward adjustment

The headrest may be adjusted forward to 3 different positions by pulling the headrest forward to the desired detent. To adjust the headrest to its furthest rearwards position, pull it fully forward to the farthest position and release it.

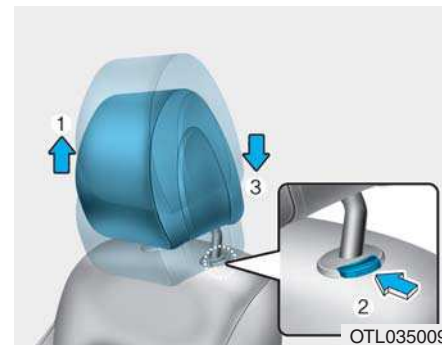

Adjusting the height up and down

To raise the headrest:

1. Pull it up to the desired position (1).

To lower the headrest:

1. Push and hold the release button (2) on the headrest support.
2. Lower the headrest to the desired position (3).

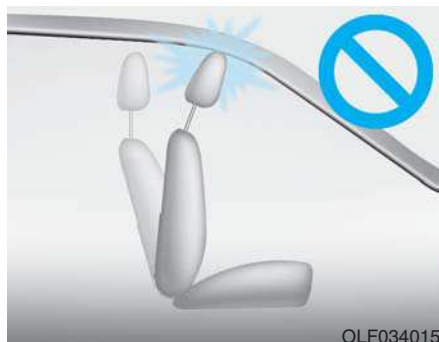

NOTICE

If you recline the seatback towards the front with the headrest and seat cushion raised, the headrest may come in contact with the sunvisor or other parts of the vehicle.

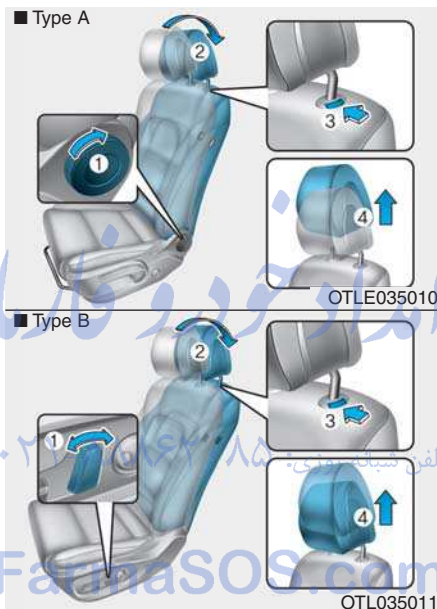

Removal/Reinstall

To remove the headrest:

1. Recline the seatback (2) with using the seatback angle knob or switch (1).
2. Raise headrest as far as it can go.

3. Press the headrest release button (3) while pulling the headrest up (4).

⚠ WARNING

NEVER allow anyone to travel in a seat with the headrest removed.

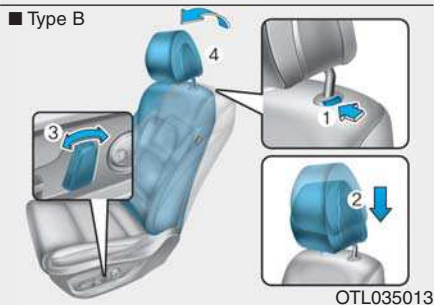
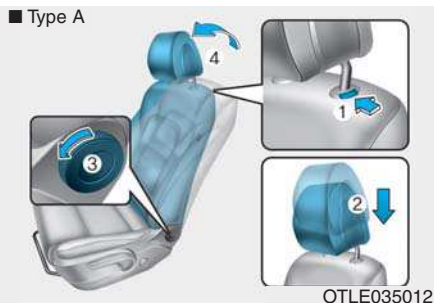

4. Recline the seatback (4) with the seatback angle knob or switch (3).

⚠ WARNING

Always make sure the headrest locks into position after reinstalling and adjusting it properly.

امداد خودرو فارما

تلفن شبانه روزی: ۰۲۱-۸۸۸۶۲۰۸۵

FarmaSOS.com

Rear seat headrests

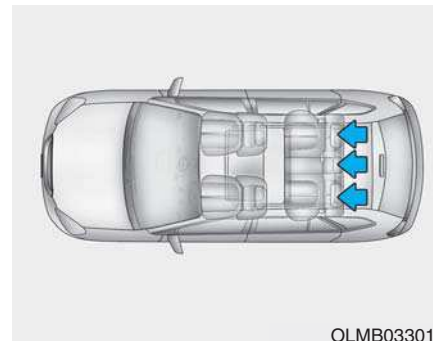

OLMB033016

The rear seats are equipped with headrests in all the seating positions for the passenger's safety and comfort.

To reinstall the headrest :

1. Recline the seatback.
2. Put the headrest poles (2) into the holes while pressing the release button (1).
3. Adjust the headrest to the appropriate height.

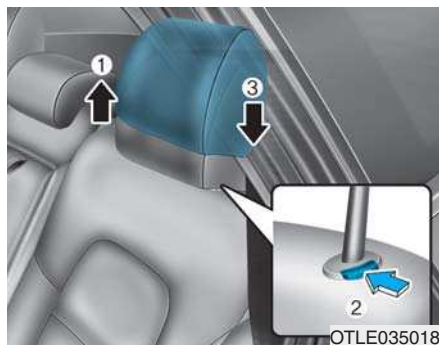

Adjusting the height up and down

To raise the headrest:

1. Pull it up to the desired position (1).

To lower the headrest:

1. Push and hold the release button (2) on the headrest support.
2. Lower the headrest to the desired position (3).

Seat warmers and air ventilation seats

Front seat warmers (if equipped)

Seat warmers are provided to warm the seats during cold weather.

⚠ WARNING

The seat warmers can cause a **SERIOUS BURN**, even at low temperatures and especially if used for long periods of time.

Passengers must be able to feel if the seat is becoming too warm so they can turn it off, if needed.

People who cannot detect temperature change or pain to the skin should use extreme caution, especially the following types of passengers:

- Infants, children, elderly or disabled persons, or hospital outpatients.
- People with sensitive skin or who burn easily.

(Continued)

(Continued)

- Fatigued individuals.
- Intoxicated individuals.
- People taking medication that can cause drowsiness or sleepiness.

⚠ WARNING

NEVER place anything on the seat that insulates against heat when the seat warmer is in operation, such as a blanket or seat cushion. This may cause the seat warmer to overheat, causing a burn or damage to the seat.

NOTICE

To prevent damage to the seat warmers and seats:

- Never use a solvent such as paint thinner, benzene, alcohol or gasoline to clean the seats.
- Do not place heavy or sharp objects on seats equipped with seat warmers.
- Do not change the seat cover. It may damage the seat warmer.

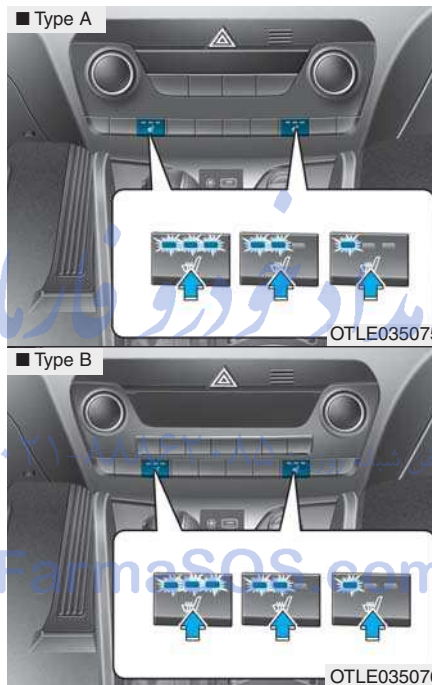

While the engine is running, push either of the switches to warm the driver's seat or front passenger's seat.

During mild weather or under conditions where the operation of the seat warmer is not needed, keep the switches in the OFF position.

- Each time you push the switch, the temperature setting of the seat is changed as follows :

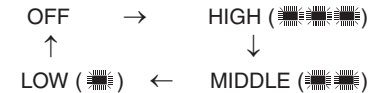

- When pressing the switch for more than 1.5 seconds with the seat warmer operating, the seat warmer will turn OFF.
- The seat warmer defaults to the OFF position whenever the ignition switch is placed to the ON position.

i Information

With the seat warmer switch in the ON position, the heating system in the seat turns off or on automatically depending on the seat temperature.

Front air ventilation seat (if equipped)

■ Type A

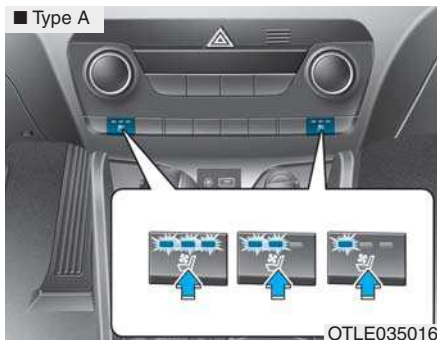

■ Type B

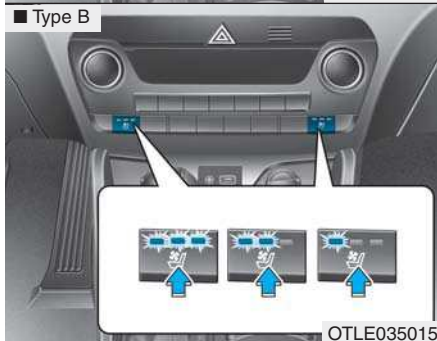

The air ventilation seats are provided to cool the front seats by blowing air through small vent holes on the surface of the seat cushions and seatbacks.

When the operation of the air ventilation seat is not needed, keep the switches in the OFF position.

While the engine is running, push the switch to cool the driver's seat or the front passenger's seat (if equipped).

- Each time you push the switch, the airflow changes as follows:

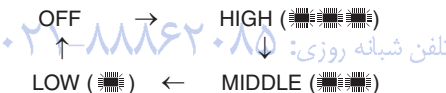

- When pressing the switch for more than 1.5 seconds with the air ventilation seat operating, the operation will turn OFF.
- The air ventilation seats default to the OFF position whenever the ignition switch is placed to the ON position.

NOTICE

To prevent damage to the air ventilation seat:

- Use the air ventilation seat **ONLY** when the climate control system is on. Using the air ventilation seat for prolonged periods of time with the climate control system off could cause the air ventilation seat to malfunction.
- Never use a solvent such as paint thinner, benzene, alcohol or gasoline to clean the seats.
- Avoid spilling liquids on the surface of the front seats and seatbacks; this may cause the air vent holes to become blocked and not work properly.
- Do not place materials such as plastic bags or newspapers under the seats. They may block the air intake causing the air vents to not work properly.

(Continued)

(Continued)

- Do not change the seat covers. It may damage the air ventilation seat.
- If the air vents do not operate, restart the vehicle. If there is no change, we recommend that you have your vehicle inspected by an authorized HYUNDAI dealer.

Rear seat warmers (if equipped)



While the engine is running, push either of the switches to warm the rear seat.

During mild weather or under conditions where the operation of the seat warmer is not needed, keep the switches in the OFF position.

Each time you push the switch, the temperature setting of the seat is changed as follows :

OFF → HIGH (☀️) → LOW (☀️)

The seat warmer defaults to the OFF position whenever the ignition switch is placed to the ON position.

i Information

With the seat warmer switch in the ON position, the heating system in the seat turns off or on automatically depending on the seat temperature.

SEAT BELTS

This section describes how to use the seat belts properly. It also describes some of the things not to do when using seat belts.

Seat belt safety precautions

Always fasten your seat belt and make sure all passengers have fastened their seat belts before starting any trip. Air bags (if equipped) are designed to supplement the seat belt as an additional safety device, but they are not a substitute. Most countries require all occupants of a vehicle to wear seat belts.

WARNING

Seat belts must be used by ALL passengers whenever the vehicle is moving. Take the following precautions when adjusting and wearing seat belts:

- Children under the age of 13 should be properly restrained in the rear seats.
- Never allow children to ride in the front passenger seat, unless the air bag is deactivated. If a child is seated in the front passenger seat, move the seat as far back as possible and properly restrain them in the seat.
- NEVER allow an infant or child to be carried on an occupant's lap.
- NEVER ride with the seatback reclined when the vehicle is moving.
- Do not allow children to share a seat or seat belt.

(Continued)

(Continued)

- Do not wear the shoulder belt under your arm or behind your back.
- Never wear a seat belt over fragile objects. If there is a sudden stop or impact, the seat belt can damage it.
- Do not use the seat belt if it is twisted. A twisted seat belt will not protect you properly in an accident.
- Do not use a seat belt if the webbing or hardware is damaged.
- Do not latch the seat belt into the buckles of other seats.
- NEVER unfasten the seat belt while driving. This may cause loss of vehicle control resulting in an accident.
- Make sure there is nothing in the buckle interfering with the seat belt latch mechanism. This may prevent the seat belt from fastening securely.

(Continued)

(Continued)

- No modifications or additions should be made by the user which will either prevent the seat belt adjusting devices from operating to remove slack, or prevent the seat belt assembly from being adjusted to remove slack.

WARNING

Damaged seat belts and seat belt assemblies will not operate properly. Always replace:

- Frayed, contaminated, or damaged webbing.
- Damaged hardware.
- The entire seat belt assembly after it has been worn in an accident, even if damage to webbing or assembly is not apparent.

تلفن شبانه روزی: ۰۸۵-۸۸۶۲۰۲۱

FarmaSOS.com

Seat belt warning light

Seat belt warning

- For driver in instrument cluster

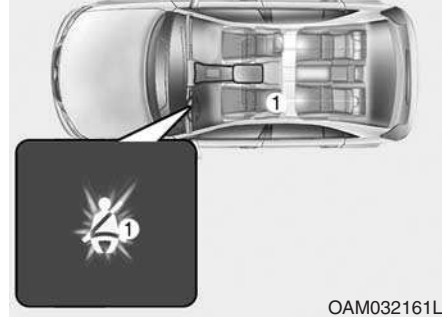

OAM032161L

Driver's seat belt warning

As a reminder to the driver, the seat belt warning light will illuminate for approximately 6 seconds each time you turn the ignition switch ON regardless of belt fastening.

If the driver's seat belt is unfastened after the ignition switch is ON, the seat belt warning light illuminates until the belt is fastened.

If you continue not to fasten the seat belt and you drive over 9km/h, the illuminated warning light will start to blink until you drive under 6km/h. (if equipped)

If you continue not to fasten the seat belt and you drive over 20km/h the seat belt warning chime will sound for approximately 100 seconds and the corresponding warning light will blink. (if equipped)



Front passenger's seat belt warning

As a reminder to the front passenger, the front passenger's seat belt warning lights will illuminate for approximately 6 seconds each time you turn the ignition switch ON regardless of belt fastening.

If the front passenger's seat belt is not fastened when the ignition switch is turned ON or if it is disconnected after the ignition switch is turned ON, the corresponding seat belt warning light will illuminate until the belt is fastened.

If you continue not to fasten the seat belt and you drive over 9km/h, the illuminated warning light will start to blink until you drive under 6km/h.

If you continue not to fasten the seat belt and you drive over 20km/h the seat belt warning chime will sound for approximately 100 seconds and the corresponding warning light will blink.

WARNING

Riding in an improper position adversely affects the front passenger's seat belt warning system. It is important for the driver to instruct the passenger to properly be seated as instructed in this manual.

i Information

- You can find the front passenger's seat belt warning light on the center fascia panel.
- Although the front passenger seat is not occupied, the seat belt warning light will blink or illuminate for 6 seconds.
- The front passenger's seat belt warning may operate when luggage is placed on the front passenger seat.



Rear passenger's seat belt warning

If the ignition switch is turned ON (engine is not running) when the rear passenger's lap/shoulder belt is not fastened, the corresponding seat belt warning light will illuminate until the belt is fastened.

And then, the rear corresponding seat belt warning light will illuminate for approximately 35 seconds, if any of following occurs;

- You start the engine when the rear belt is not fastened.
- You drive over 9km/h when the rear belt is not fastened.
- The rear belt is disconnected when driving under 20km/h.

If the rear seat belt is fastened, the warning light will turn off immediately. If the rear seat belt is disconnected when you drive over the 20km/h, the corresponding seat belt warning light will blink and warning chime will sound for 35 seconds.

But, if the rear passenger's lap/shoulder belt is/are connected and disconnected twice within 9 seconds after the belt is fastened, the corresponding seat belt warning light will not operate.

Seat belt restraint system

Lap/shoulder belt

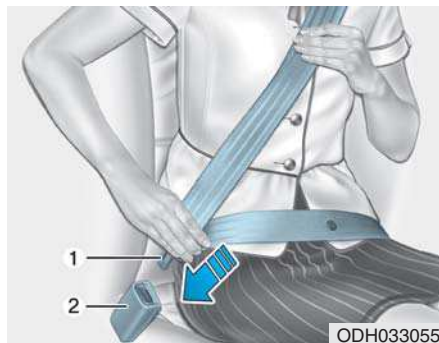

To fasten your seat belt:

Pull it out of the retractor and insert the metal tab (1) into the buckle (2). There will be an audible "click" when the tab locks into the buckle.

The seat belt automatically adjusts to the proper length after the lap belt portion is adjusted manually so that it fits snugly around your hips. If you lean forward in a slow, easy motion, the belt will extend and move with you. If there is a sudden stop or impact, the belt will lock into position. It will also lock if you try to lean forward too quickly.

NOTICE

If you are not able to smoothly pull enough of the seat belt out from the retractor, firmly pull the seat belt out and release it. After release, you will be able to pull the belt out smoothly.

امداد خودرو فارما

تلفن شبانه روزی: ۰۲۱-۸۸۸۶۲۰۸۵

FarmaSOS.com



⚠ WARNING

Improperly positioned seat belts may increase the risk of serious injury in an accident. Take the following precautions when adjusting the seat belt:

- Position the lap portion of the seat belt as low as possible across your hips, not on your waist, so that it fits snugly. This allows your strong pelvic bones to absorb the force of the crash, reducing the chance of internal injuries.

(Continued)

(Continued)

- Position one arm under the shoulder belt and the other over the belt, as shown in the illustration.
- Always position the shoulder belt anchor into locked position at the appropriate height.
- Never position the shoulder belt across your neck or face.

Height adjustment

You can adjust the height of the shoulder belt anchor to one of the four different positions for maximum comfort and safety.

The shoulder portion should be adjusted so it lies across your chest and midway over your shoulder nearest the door, not over your neck.

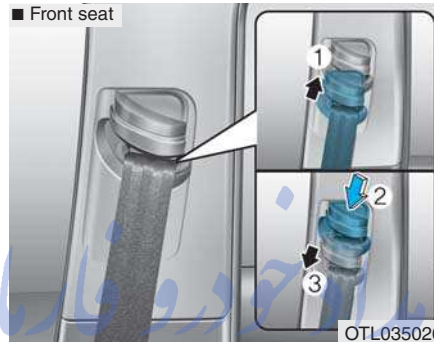

To adjust the height of the seat belt anchor, lower or raise the height adjuster into an appropriate position.

To raise the height adjuster, pull it up (1). To lower it, push it down (3) while pressing the height adjuster button (2).

Release the button to lock the anchor into position. Try sliding the height adjuster to make sure that it has locked into position.

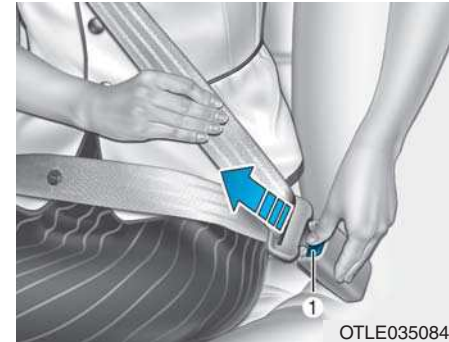
**To release your seat belt:**

Press the release button (1) in the locking buckle.

When it is released, the belt should automatically draw back into the retractor. If this does not happen, check the belt to be sure it is not twisted, then try again.

Rear center seatbelt (3-point rear center seat belt)



To fasten your seatbelt

1. Extract the tongue plate (A) from the hole on the belt assembly cover.



2. Insert the tongue plate (A) into the buckle (A') until an audible "click" is heard, indicating the latch is locked. Make sure the belt is not twisted.

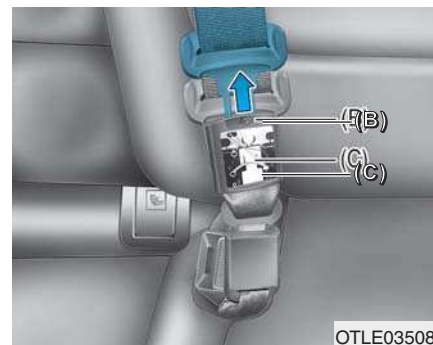

3. Pull out the tongue plate (B) from the pocket (C).

FarmaSOS.com

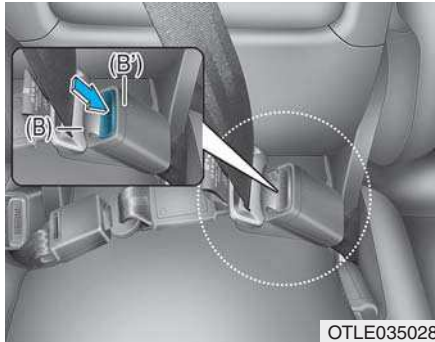

OTLE035028

4. Pull the tongue plate (B) and insert it into the buckle (B') until an audible "click" is heard, indicating the latch is locked. Make sure the belt is not twisted.

When using the rear center seat belt, the buckle with the "CENTER" mark must be used.

i Information

If you are not able to pull out the safety belt from the retractor, firmly pull the belt out and release it. After release, you will be able to pull the belt out smoothly.

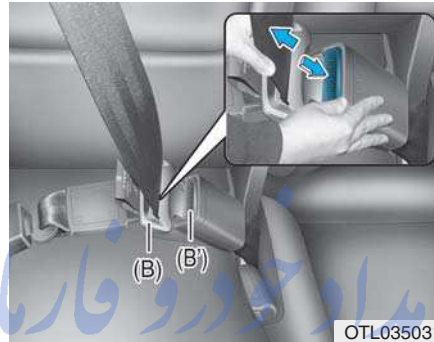

OTL035031

To release your seatbelt

1. Press the release button on the buckle (B') and remove the tongue plate (B).

FarmaSOS.com

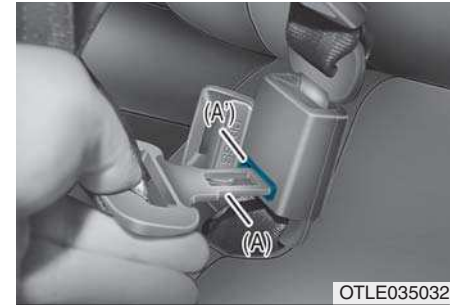

OTLE035032

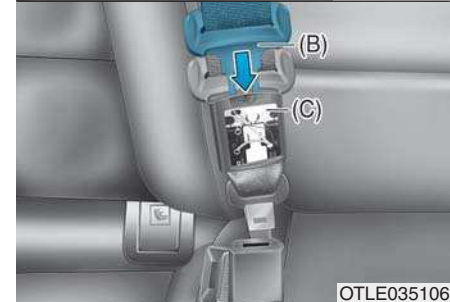

OTLE035106

2. To retract the rear center seatbelt, insert the tongue plate (A) into the web release hole (A'). Pull up on the seat belt web and allow the webbing to retract automatically.
3. Insert the tongue plate (B) into the pocket (C).

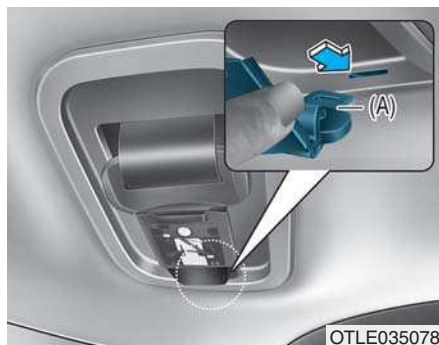

4. Insert the tongue plate (A) into the hole on the belt assembly cover.

Pre-tensioner seat belt



Your vehicle is equipped with driver's and front passenger's Pre-tensioner Seat Belts (Retractor Pretensioner and Emergency Fastening Device (EFD)). The purpose of the pre-tensioner is to make sure the seat belts fit tightly against the occupant's body in certain frontal collisions. The pre-tensioner seat belts may be activated in crashes where the frontal collision is severe enough, together with the air bags.

When the vehicle stops suddenly, or if the occupant tries to lean forward too quickly, the seat belt retractor will lock into position. In certain frontal collisions, the pre-tensioner will activate and pull the seat belt into tighter contact against the occupant's body.

(1) Retractor Pretensioner

The purpose of the retractor pre-tensioner is to make sure that the shoulder belts fit in tightly against the occupant's upper body in certain frontal collisions.

(2) Emergency Fastening Device (EFD) (for the driver's seat, if equipped)

The purpose of the EFD is to make sure that the pelvic belts fit in tightly against the occupant's lower body in certain frontal collisions.

If the system senses excessive tension on the driver or passenger's seat belt when the pre-tensioner system activates, the load limiter inside the retractor pre-tensioner will release some of the pressure on the affected seat belt.

WARNING

- Always wear your seat belt and sit properly in your seat.
- Do not use the seat belt if it is loose or twisted. A loose or twisted seat belt will not protect you properly in an accident.
- Do not place anything near the buckle. This may adversely affect the buckle and cause it to function improperly.
- Always replace your pre-tensioners after activation or an accident.
- NEVER inspect, service, repair or replace the pre-tensioners yourself. This must be done by an authorized HYUNDAI dealer.
- Do not hit the seat belt assemblies.

WARNING

Do not touch the pre-tensioner seat belt assemblies for several minutes after they have been activated. When the pre-tensioner seat belt mechanism deploys during a collision, the pre-tensioner can become hot and can burn you.

CAUTION

Body work on the front area of the vehicle may damage the pre-tensioner seat belt system. Therefore, we recommend the system to be serviced by an authorized HYUNDAI dealer.

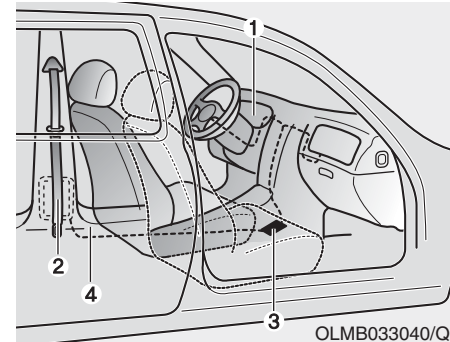

The Pre-Tensioner Seat Belt System consists mainly of the following components. Their locations are shown in the illustration above:

- (1) SRS air bag warning light
- (2) Retractor pre-tensioner
- (3) SRS control module
- (4) Emergency Fastening Device (EFD) (if equipped)

NOTICE

The sensor that activates the SRS air bag is connected with the pre-tensioner seat belts. The SRS air bag warning light on the instrument panel will illuminate for approximately 6 seconds after the ignition switch is placed to the ON position, and then it should turn off.

If the pre-tensioner is not working properly, the warning light will illuminate even if the SRS air bag is not malfunctioning. If the warning light does not illuminate, stays illuminated or illuminates when the vehicle is being driven, we recommend the pre-tensioner seat belts and/or SRS air bags be inspected by an authorized HYUNDAI dealer as soon as possible.

Information

- Both the driver's and front passenger's pre-tensioner seat belts may be activated in certain frontal or side collisions.
- The pre-tensioners will be activated even if the seat belts are not worn at the time of the collision.
- When the pre-tensioner seat belts are activated, a loud noise may be heard and fine dust, which may appear to be smoke, may be visible in the passenger compartment. These are normal operating conditions and are not hazardous.
- Although it is non-toxic, the fine dust may cause skin irritation and should not be breathed for prolonged periods. Wash all exposed skin areas thoroughly after an accident in which the pre-tensioner seat belts were activated.

Additional seat belt safety precautions

Seat belt use during pregnancy

The seat belt should always be used during pregnancy. The best way to protect your unborn child is to protect yourself by always wearing the seat belt.

Pregnant women should always wear a lap-shoulder seat belt. Place the shoulder belt across your chest, routed between your breasts and away from your neck. Place the lap belt below your belly so that it fits SNUGLY across your hips and pelvic bone, under the rounded part of the belly.

WARNING

To reduce the risk of serious injury or death to an unborn child during an accident, pregnant women should NEVER place the lap portion of the seat belt above or over the area of the abdomen where the unborn child is located.

Seat belt use and children

Infant and small children

Most countries have Child Restraint System laws which require children to travel in approved Child Restraint System devices, including booster seats. The age at which seat belts can be used instead of Child Restraint System differs among countries, so you should be aware of the specific requirements in your country, and where you are travelling. Infant and Child Restraint System must be properly placed and installed in a rear seat.

For more information refer to the “Child Restraint Systems” in this chapter.

WARNING

ALWAYS properly restrain infants and small children in a Child Restraint System appropriate for the child's height and weight.

To reduce the risk of serious injury or death to a child and other passengers, NEVER hold a child in your lap or arms when the vehicle is moving. The violent forces created during an accident will tear the child from your arms and throw the child against the interior of the vehicle.

Small children are best protected from injury in an accident when properly restrained in the rear seat by a Child Restraint System that meets the requirements of the Safety Standards of your country. Before buying any Child Restraint System, make sure that it has a label certifying that it meets Safety Standard of your country. The Child Restraint System must be appropriate for your child's height and weight. Check the label on the Child Restraint System for this information. Refer to “Child Restraint Systems” in this chapter.

FarmaSOS.com

Larger children

Children under age 13 and who are too large for a booster seat should always occupy the rear seat and use the available lap/shoulder belts. A seat belt should lie across the upper thighs and be snug across the shoulder and chest to restrain the child safely. Check belt fit periodically. A child's squirming could put the belt out of position. In the event of an accident, children are afforded the best safety restrained by a proper Child Restraint System in the rear seats.

If a larger child over age 13 must be seated in the front seat, the child must be securely restrained by the available lap/shoulder belt and the seat should be placed in the rear-most position.

If the shoulder belt portion slightly touches the child's neck or face, try placing the child closer to the center of the vehicle. If the shoulder belt still touches their face or neck, they need to be returned to an appropriate booster seat in the rear seat.

WARNING

- **Always make sure larger children's seat belts are worn and properly adjusted.**
- **NEVER allow the shoulder belt to contact the child's neck or face.**
- **Do not allow more than one child to use a single seat belt.**

تلفن شبانه روزی: ۰۲۱-۸۸۶۲۰۸۵

FarmaSOS.com

Seat belt use and injured people

A seat belt should be used when an injured person is being transported. Consult a physician for specific recommendations.

One person per belt

Two people (including children) should never attempt to use a single seat belt. This could increase the severity of injuries in case of an accident.

Do not lie down

Sitting in a reclined position when the vehicle is in motion can be dangerous. Even when buckled up, the protections of your restraint system (seat belts and/or air bags) is greatly reduced by reclining your seatback.

Seat belts must be snug against your hips and chest to work properly.

During an accident, you could be thrown into the seat belt, causing neck or other injuries.

The more the seat back is reclined, the greater the chance for the passenger's hips to slide under the lap belt or the passenger's neck to strike the shoulder belt.

 **WARNING**

- **NEVER ride with a reclined seatback when the vehicle is moving.**
- **Riding with a reclined seatback increases your chance of serious or fatal injuries in the event of a collision or sudden stop.**
- **Driver and passengers should always sit well back in their seats, properly belted, and with the seatbacks upright.**

Care of seat belts

Seat belt systems should never be disassembled or modified. In addition, care should be taken to assure that seat belts and belt hardware are not damaged by seat hinges, doors or other abuse.

Periodic inspection

All seat belts should be inspected periodically for wear or damage of any kind. Any damaged parts should be replaced as soon as possible.

Keep belts clean and dry تلفن شیانہ

Seat belts should be kept clean and dry. If belts become dirty, they can be cleaned by using a mild soap solution and warm water. Bleach, dye, strong detergents or abrasives should not be used because they may damage and weaken the fabric.

When to replace seat belts

The entire seat belt assembly or assemblies should be replaced if the vehicle has been involved in an accident. This should be done even if no damage is visible. We recommend that you consult an authorized HYUNDAI dealer.

CHILD RESTRAINT SYSTEM (CRS)

**Our recommendation:
Children always in the rear**

WARNING

Always properly restrain children in the vehicle. Children of all ages are safer when riding in the rear seats. Never place a rearward-facing Child Restraint System on the front passenger seat, unless the air bag is deactivated.

Children under age 13 should always ride in the rear seats and must always be properly restrained to minimize the risk of injury in an accident, sudden stop or sudden maneuver.

According to accident statistics, children are safer when properly restrained in the rear seats than in the front seat. Children too large for a Child Restraint System must use the seat belts provided.

Most countries have regulations which require children to travel in approved Child Restraint Systems.

The laws governing the age or height/weight restrictions at which seat belts can be used instead of Child Restraint System differs among countries, so you should be aware of the specific requirements in your country, and where you are travelling.

Child Restraint Systems must be properly installed in the vehicle seat. Always use a commercially available Child Restraint System that meets the requirements of your country.

تلفن شبانه روزی: ۰۲۱-۸۸۶۲۰۸۵

FarmaSOS.com

Child Restraint System (CRS)

Infants and younger children must be restrained in an appropriate rearward-facing or forward-facing CRS that has first been properly secured to the seat of the vehicle. Read and comply with the instructions for installation and use provided by the manufacturer of the Child Restraint System.

WARNING

- **Always follow the Child Restraint System manufacturer's instructions for installation and use.**
- **Always properly restrain your child in the Child Restraint System.**
- **Do not use an infant carrier or a child safety seat that "hooks" over a seatback, it may not provide adequate protection in an accident.**
- **After an accident, we recommend a HYUNDAI dealer to check the Child Restraint System, seat belts, ISOFIX anchorages and top-tether anchorages.**

Selecting a Child Restraint System (CRS)

When selecting a Child Restraint System for your child, always:

- Make sure the Child Restraint System has a label certifying that it meets applicable Safety Standards of your country.

A Child Restraint System may only be installed if it was approved in accordance with the requirements of ECE-R44 or ECE-R129.

- Select a Child Restraint System based on your child's height and weight. The required label or the instructions for use typically provide this information.
- Select a Child Restraint System that fits the vehicle seating position where it will be used.

For the suitability of Child Restraint Systems on the vehicle's seating positions, please refer to the installation tables on pages 2-45, 48 and 49.

- Read and comply with the warnings and instructions for installation and use provided with the Child Restraint System.

Child Restraint System types

There are three main types of Child Restraint Systems: rearward-facing, forward-facing and booster Child Restraint Systems.

They are classified according to the child's age, height and weight.

امداد خودرو فارما

تلفن شبانه روزی: ۰۲۱-۸۸۸۶۲۰۸۵

FarmaSOS.com

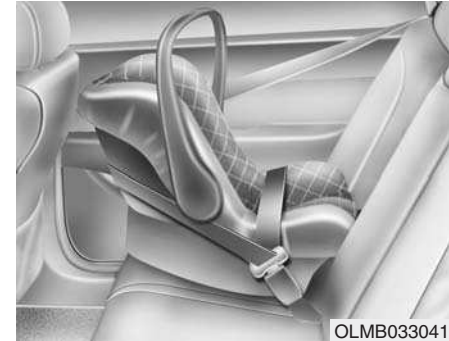

Rearward-facing Child Restraint System

A rearward-facing Child Restraint System provides restraint with the seating surface against the back of the child. The harness system holds the child in place, and in an accident, acts to keep the child positioned in the Child Restraint Systems and reduce the stress to the fragile neck and spinal cord.

All children under the age of one year must always ride in a rearward-facing Child Restraint System. There are different types of rearward-facing Child Restraint Systems: infant-only Child Restraint Systems can only be used rearward-facing. Convertible and 3-in-1 Child Restraint Systems typically have higher height and weight limits for the rearward-facing position, allowing you to keep your child rearward-facing for a longer period of time.

Keep using Child Restraint Systems in the rearward-facing position as long as children fit within the height and weight limits allowed by the Child Restraint System's manufacturer.



Forward-facing Child Restraint System

A forward-facing Child Restraint System provides restraint for the child's body with a harness. Keep children in a forward-facing Child Restraint System with a harness until they reach the top height or weight limit allowed by your Child Restraint System's manufacturer.

Once your child outgrows the forward-facing Child Restraint System, your child is ready for a booster seat.

Booster seats

A booster seat is a Child Restraint System designed to improve the fit of the vehicle's seat belt system. A booster seat positions the seat belt so that it fits properly over the stronger parts of your child's body. Keep your children in booster seats until they are big enough to fit in a seat belt properly.

For a seat belt to fit properly, the lap belt must lie comfortable across the upper thighs, not the stomach. The shoulder belt should lie comfortable across the shoulder and chest and not across the neck or face. Children under age 13 must always be properly restrained to minimize the risk of injury in an accident, sudden stop or sudden maneuver.

Installing a Child Restraint System (CRS)

WARNING

Before installing your Child Restraint System always:

Read and follow the instructions provided by the manufacturer of the Child Restraint System.

Failure to follow all warnings and instructions could increase the risk of the SERIOUS INJURY or DEATH if an accident occurs.

WARNING

If the vehicle headrest prevents proper installation of a Child Restraint System, the headrest of the respective seating position shall be readjusted or entirely removed.

After selecting a proper Child Restraint System for your child and checking that the Child Restraint System fits properly on the seating position, there are three general steps for a proper installation:

- **Properly secure the Child Restraint System to the vehicle.** All Child Restraint Systems must be secured to the vehicle with the lap belt or lap part of a lap/shoulder belt or with the ISOFIX top-tether and/or ISOFIX anchorage and/or with the support leg.
- **Make sure the Child Restraint System is firmly secured.** After installing a Child Restraint System to the vehicle, push and pull the seat forward and from side-to-side to verify that it is securely attached to the seat. A Child Restraint System secured with a seat belt should be installed as firmly as possible. However, some side-to-side movement can be expected.

When installing a Child Restraint System, adjust the vehicle seat and seatback (up and down, forward and rearward) so that your child fits in the Child Restraint System in a comfortable manner.

- **Secure the child in the Child Restraint System.** Make sure the child is properly strapped in the Child Restraint System according to the Child Restraint System manufacturer's instructions.

CAUTION

A Child Restraint System in a closed vehicle can become very hot. To prevent burns, check the seating surface and buckles before placing your child in the Child Restraint System.

ISOFIX anchorage and top-tether anchorage (ISOFIX anchorage system) for children

The ISOFIX system holds a Child Restraint System during driving and in an accident. This system is designed to make installation of the Child Restraint System easier and reduce the possibility of improperly installing your Child Restraint System. The ISOFIX system uses anchors in the vehicle and attachments on the Child Restraint System. The ISOFIX system eliminates the need to use seat belts to secure the Child Restraint System to the rear seats.

ISOFIX anchorages are metal bars built into the vehicle. There are two lower anchors for each ISOFIX seating position that will accommodate a Child Restraint System with lower attachments.

To use the ISOFIX system in your vehicle, you must have a Child Restraint System with ISOFIX attachments.

The Child Restraint System manufacturer will provide you with instructions on how to use the Child Restraint System with its attachments for the ISOFIX anchorages.





ISOFIX anchorages have been provided in the left and right outboard rear seating positions. Their locations are shown in the illustration.

⚠ WARNING

Do not attempt to install a Child Restraint System using ISOFIX anchorages in the rear center seating position. There are no ISOFIX anchorages provided for this seat. Using the outboard seat anchorages, for the CRS installation on the rear center seating position, can damage the anchorages.

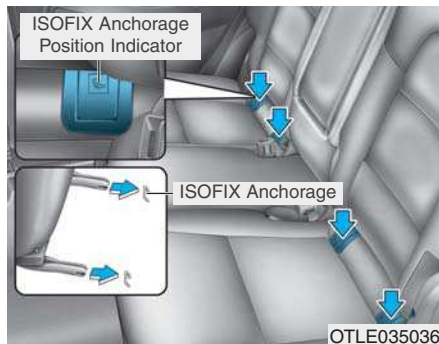
FarmaSOS.com



ISOFIX anchorages are located between the seatback and the seat cushion of the rear seat left and right outboard seating positions, indicated by the symbols .

To use the ISOFIX anchorages, push the upper portion of the ISOFIX anchorage cover.

Securing a Child Restraint System with the “ISOFIX Anchorage System”

To install an i-Size or ISOFIX-compatible Child Restraint System in either of the rear outboard seating positions:

1. Move the seat belt buckle away from the ISOFIX anchorages.
2. Move any other objects away from the anchorages that could prevent a secure connection between the Child Restraint System and the ISOFIX anchorages.
3. Place the Child Restraint System on the vehicle seat, then attach the seat to the ISOFIX anchorages according to the instructions provided by the Child Restraint System manufacturer.
4. Follow the instructions of the Child Restraint System's manufacturer for proper installation and connection of the ISOFIX attachments on the Child Restraint System to the ISOFIX anchorages.

⚠ WARNING

Take the following precautions when using the ISOFIX system:

- Read and follow all installation instructions provided with your Child Restraint System.
- To prevent the child from reaching and taking hold of unretracted seat belts, buckle all unused rear seat belts and retract the seat belt webbing behind the child. Children can be strangled if a shoulder belt becomes wrapped around their neck and the seat belt tightens.
- **NEVER** attach more than one Child Restraint System to a single anchorage. This could cause the anchor or attachment to come loose or break.
- Always have the ISOFIX system inspected by your dealer after an accident. An accident can damage the ISOFIX system and may not properly secure the Child Restraint System.

Securing a Child Restraint System seat with “Top-tether Anchorage” system

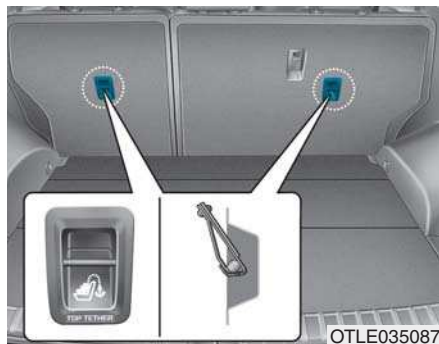

Top-tether anchorages for Child Restraint Systems are located on the rear of the seatbacks.

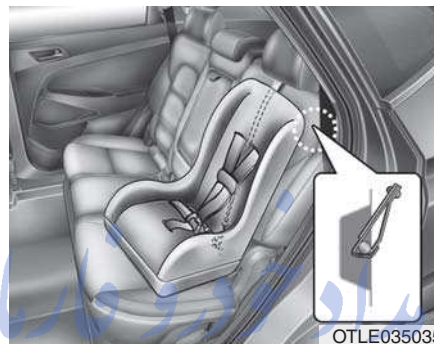

1. Route the Child Restraint System top-tether strap over the seatback. Placing the top tether strap, please follow the instructions of the Child Restraint System manufacturer.
2. Connect the top-tether strap to the top-tether anchorage, then tighten the top-tether strap according to the instructions of your Child Restraint System's manufacturer to firmly attach the Child Restraint System to the seat.

WARNING

Take the following precautions when installing the top-tether:

- Read and follow all installation instructions provided with your Child Restraint System.
- NEVER attach more than one Child Restraint System to a single ISOFIX top-tether anchorage. This could cause the anchorage or attachment to come loose or break.
- Do not attach the top-tether to anything other than the correct top-tether anchorage. It may not work properly if attached to something else.
- Child Restraint System anchorages are designed to withstand only those loads imposed by correctly fitted Child Restraint System.

Under no circumstances are they to be used for adult seat belts or harnesses or for attaching other items or equipment to the vehicle.

Suitability of each seating position for ISOFIX Child Restraint Systems according to ECE regulations

Mass Group	Size Class	Fixture	Vehicle ISOFIX Positions			
			Front Passenger	Rear Outboard (Driver side)	Rear Outboard (Passenger side)	Rear Center
Carrycot	F	ISO/L1	-	X	X	-
	G	ISO/L2	-	X	X	-
0 : UP to 10kg	E	ISO/R1	-	IL	IL	-
0+ : UP to 13kg	E	ISO/R1	-	IL	IL	-
	D	ISO/R2	-	IL	IL	-
	C	ISO/R3	-	IL	IL	-
I : 9 to 18kg	D	ISO/R2	-	IL	IL	-
	C	ISO/R3	-	IL	IL	-
	B	ISO/F2	-	IUF + IL	IUF + IL	-
	B1	ISO/F2X	-	IUF + IL	IUF + IL	-
	A	ISO/F3	-	IUF + IL	IUF + IL	-

IUF = Suitable for ISOFIX Forward-Facing Child Restraint Systems of universal category approved for use in the mass group.

IL = Suitable for particular ISOFIX Child Restraint Systems given in the attached list. These ISOFIX CRS are those of the "specific vehicle", "restricted" or "semi-universal" categories.

X = ISOFIX position not suitable for ISOFIX Child Restraint System in this mass group and/or this size class.

* Both ISO/R2 and ISO/R3 are able to be set up only at the foremost position of the passenger seat.

* ISOFIX Child Restraint System size classes and fixtures

A - ISO/F3: Full-Height Forward-Facing toddler Child Restraint System (height 720mm)

B - ISO/F2: Reduced-Height Forward-Facing toddler Child Restraint System (height 650mm)

B1 - ISO/F2X: Reduced-Height Second Version Back Surface Shape Forward-Facing toddler Child Restraint System (height 650mm)

C - ISO/R3: Full-Size Rearward-Facing toddler Child Restraint System

D - ISO/R2: Reduced-Size Rearward-Facing toddler Child Restraint System

E - ISO/R1: Infant-Size Rearward-Facing Child Restraint System

F - ISO/L1: Left Lateral Facing position Child Restraint System (carry-cot)

G - ISO/L2: Right Lateral Facing position Child Restraint System (carry-cot)

Securing a Child Restraint System with a lap/shoulder belt

When not using the ISOFIX system, all Child Restraint Systems must be secured to a rear seat with the lap part of a lap/shoulder belt.

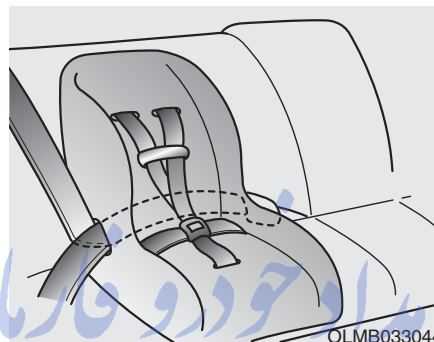

Installing a Child Restraint System with a lap/shoulder belt

To install a Child Restraint System on the rear seats, do the following: تلفن

1. Place the Child Restraint System on a rear seat and route the lap/shoulder belt around or through the Child Restraint System, following the Child Restraint System manufacturer's instructions.

Make sure the seat belt webbing is not twisted.

***i* Information**

When using the rear center seat belt, you should also refer to the “3-point Rear Center Seat Belt” in this chapter.



2. Fasten the lap/shoulder belt latch into the buckle. Listen for the distinct “click” sound.

i Information

Position the release button so that it is easy to access in case of an emergency.



3. Remove as much slack from the belt as possible by pushing down on the Child Restraint System while feeding the shoulder belt back into the retractor.
4. Push and pull on the Child Restraint System to confirm that the seat belt is holding it firmly in place.

To remove the Child Restraint System, press the release button on the buckle and then pull the lap/shoulder belt out of the Child Restraint System and allow the seat belt to retract fully.

Suitability of each seating position for "universal" category belted Child Restraint Systems according to ECE regulations

Mass Group		Seating Position			
		Front passenger Outboard	Second Row		
			Outboard Left	Center (3 POINT BELT)	Outboard Right
Group 0 (0-9months)	up to 10kg	U*	U	U	U
Group 0 + (0-2years)	up to 13kg	U*	U	U	U
Group I (9months-4years)	9 to 18kg	U*	U	U	U
Group II (15 to 25kg)	15 to 25kg	U*	U	U	U
Group III (22 to 36kg)	22 to 36kg	U*	U	U	U

U : Suitable for "universal" category Child Restraint Systems approved for use in this mass group

U* : Suitable for "universal" category Child Restraint Systems with seat back adjusted to the most upright position

i-Size Child Restraint Systems according to ECE regulations

Mass Group	Seating Position			
	Front passenger Outboard	Second Row		
		Outboard Left	Center	Outboard Right
i-size Child Restraint Systems	X	i-U	X	i-U

i-U : Suitable for i-Size "universal" Child Restraint Systems forward and rearward-facing

i-UF : Suitable for forward-facing i-Size "universal" Child Restraint Systems only

X : Seat position not suitable for i-size Child Restraint Systems

تلفن شبانه روزی: ۰۲۱-۸۸۸۶۲۰۸۵

FarmaSOS.com

AIR BAG – SUPPLEMENTAL RESTRAINT SYSTEM

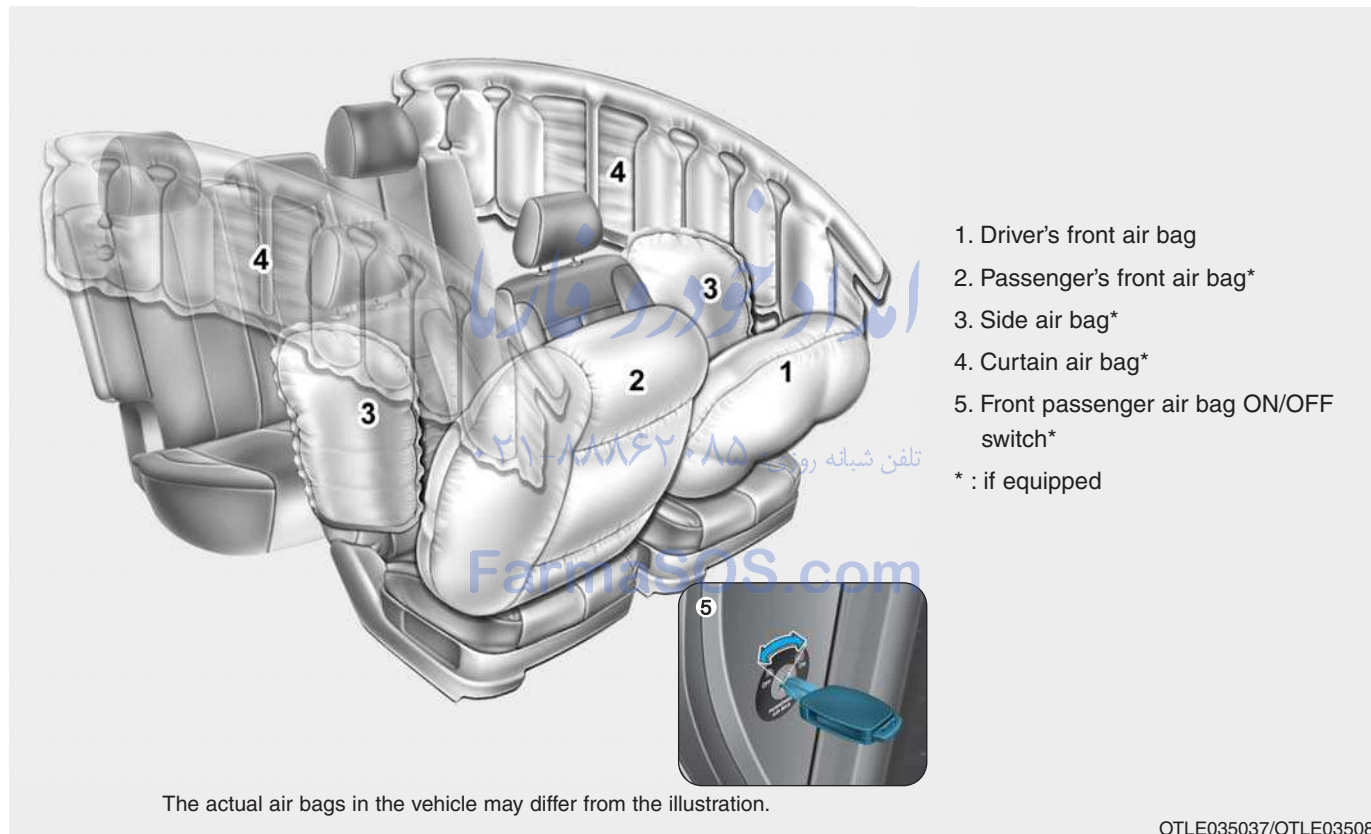

The vehicles are equipped with a Supplemental Air Bag System for the driver's seat and front passenger's seats.

The front air bags are designed to supplement the three-point seat belts. For these air bags to provide protection, the seat belts must be worn at all times when driving.

You can be severely injured or killed in an accident if you are not wearing a seat belt. Air bags are designed to supplement seat belts, but do not replace them. Also, air bags are not designed to deploy in every collision. In some accidents, the seat belts are the only restraint protecting you.

WARNING

AIR BAG SAFETY PRECAUTIONS

ALWAYS use seat belts Child Restraint Systems - every trip, every time, everyone! Even with air bags, you can be seriously injured or killed in a collision if you are improperly belted or not wearing your seat belt when the air bag inflates.

NEVER place a child in any Child Restraint System or booster seat in the front passenger seat, unless the air bag is deactivated.

An inflating air bag could forcefully strike the infant or child causing serious or fatal injuries.

ABC - Always Buckle Children under age 13 in the back seat. It is the safest place for children of any age to ride. If a child age 13 or older must be seated in the front seat, he or she must be properly belted and the seat should be moved as far back as possible.

All occupants should sit upright with the seatback in an upright position, centered on the seat cushion with their seat belt on, legs comfortably extended and their feet on the floor until the vehicle is parked and the engine is turned off. If an occupant is out of position during an accident, the rapidly deploying air bag may forcefully contact the occupant causing serious or fatal injuries.

You and your passengers should never sit or lean unnecessarily close to the air bags or lean against the door or center console.

Move your seat as far back as possible from front air bags, while still maintaining control of the vehicle.

Where are the air bags?

Driver's and passenger's front air bags (if equipped)



Your vehicle is equipped with a Supplemental Restraint System (SRS) and lap/shoulder belts at both the driver and passenger seating positions.

The SRS consists of air bags which are located in the center of the steering wheel and the passenger's side front panel pad above the glove box.

The air bags are labeled with the letters "AIR BAG" embossed on the pad covers.

The purpose of the SRS is to provide the vehicle's driver and front passengers with additional protection than that offered by the seat belt system alone in case of a frontal impact of sufficient severity.

⚠ WARNING

To reduce the risk of serious injury or death from inflating front air bags, take the following precautions:

- **Seat belts must be worn at all times to help keep occupants positioned properly.**

(Continued)

(Continued)

- **Move your seat as far back as possible from front air bags, while still maintaining control of the vehicle.**
- **Never lean against the door or center console.**
- **Do not allow the front passenger to place their feet or legs on the dashboard.**
- **No objects (such as crash pad cover, cellular phone holder, cup holder, perfume or stickers) should be placed over or near the air bag modules on the steering wheel, instrument panel, windshield glass, and the front passenger's panel above the glove box. Such objects could cause harm if the vehicle is in a crash severe enough to cause the air bags to deploy.**



OTLE035081

Passenger's front air bag ON/OFF switch (if equipped)

The purpose of the switch is to disable the passenger's front air bag in order to transport occupants who are at increased risk for air bag-related injury due to age, size, or medical condition.



OTLE035086

To deactivate the passenger's front air bag:

Insert the key or a similar rigid device into the passenger's front air bag ON/OFF switch and turn it to the OFF position. The passenger air bag OFF indicator (⊗) will illuminate and stay on until the passenger's front air bag is reactivated.

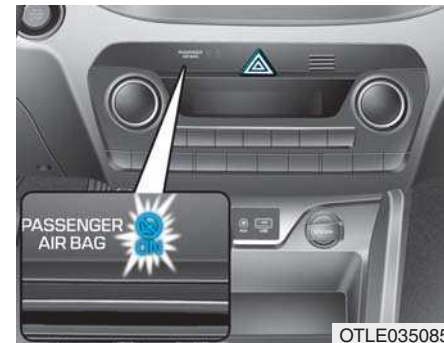

OTLE035085

To reactivate the passenger's front air bag:

Insert the key or a similar rigid device into the passenger's front air bag ON/OFF switch and turn it to the ON position. The passenger air bag ON indicator (⊗) will illuminate and stay on for 60 seconds.

i Information



The passenger's front air bag ON/OFF indicator illuminates for about 4 seconds after the ignition switch is placed in the ON position.

⚠ WARNING

Never allow an adult passenger to ride in the front passenger seat when the passenger air bag OFF indicator is illuminated. During a collision, the air bag will not inflate if the indicator is illuminated. Turn on the passenger's front air bag or have your passenger move to the rear seat.

⚠ WARNING

If the passenger's front air bag ON/OFF switch malfunctions, the following conditions may occur:

- The air bag warning light () on the instrument panel will illuminate.
- The passenger air bag OFF indicator () will not illuminate and the ON indicator () will come on and go off after approximately 60 seconds. The passenger's front air bag will inflate in a frontal impact even though the passenger's front air bag ON/OFF switch is set to the OFF position.
- We recommend that an authorized HYUNDAI dealer inspect the passenger's front air bag ON/OFF switch and the SRS air bag system as soon as possible.

Side air bags (if equipped)

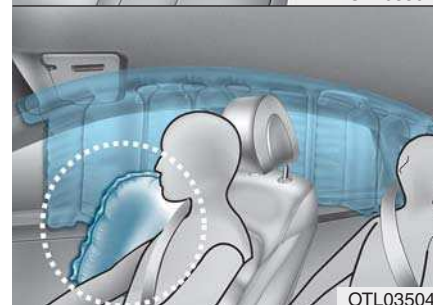

Your vehicle is equipped with a side air bag in each front seat. The purpose of the air bag is to provide the vehicle's driver and the front passenger with additional protection than that offered by the seat belt alone.

The side air bags are designed to deploy during certain side impact collisions, depending on the crash severity, angle, speed and point of impact.

The side air bags on both sides of the vehicle are designed to deploy when a rollover is detected by a rollover sensor. (if equipped with rollover sensor)

The side air bags are not designed to deploy in all side impact or rollover situations.

⚠ WARNING

To reduce the risk of serious injury or death from an inflating side air bag, take the following precautions:

- Seat belts must be worn at all times to help keep occupants positioned properly.

(Continued)

(Continued)

- Do not allow passengers to lean their heads or bodies onto doors, put their arms on the doors, stretch their arms out of the window, or place objects between the doors and seats.
- Hold the steering wheel at the 9 o'clock and 3 o'clock positions, to minimize the risk of injuries to your hands and arms.
- Do not use any accessory seat covers. This could reduce or prevent the effectiveness of the system.
- Do not place any objects over the air bag or between the air bag and yourself. Also, do not attach any objects around the area the air bag inflates such as the door, side door glass, front and rear pillar.

(Continued)

(Continued)

- Do not place any objects between the door and the seat. They may become dangerous projectiles if the side air bag inflates.
- Do not install any accessories on the side or near the side air bags.
- Do not put any objects between the side air bag label and seat cushion. It could cause harm if the vehicle is in a crash severe enough to cause the air bags to deploy.
- Do not cause impact to the doors when the ignition switch is in the ON position or this may cause the side air bags to inflate.
- If the seat or seat cover is damaged, we recommend that the system be serviced by an authorized HYUNDAI dealer.

Curtain air bags (if equipped)

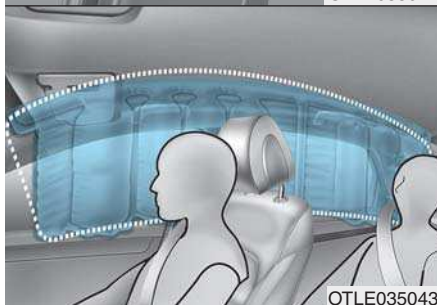

Curtain air bags are located along both sides of the roof rails above the front and rear doors.

They are designed to help protect the heads of the front seat occupants and the rear outboard seat occupants in certain side impact collisions.

The curtain air bags are designed to deploy during certain side impact collisions, depending on the crash severity, angle, speed and impact.

The curtain air bags on both sides of the vehicle are designed to deploy when a rollover is detected by a rollover sensor. (if equipped with rollover sensor)

The curtain air bags are not designed to deploy in all side impact or rollover situations.

⚠ WARNING

To reduce the risk of serious injury or death from an inflating curtain air bags, take the following precautions:

- **All seat occupants must wear seat belts at all times to help keep occupants positioned properly.**

(Continued)

(Continued)

- **Properly secure Child Restraint System as far away from the door as possible.**
- **Do not place any objects over the air bag. Also, do not attach any objects around the area the air bag inflates such as the door, side door glass, front and rear pillar, roof side rail.**
- **Do not hang hard or breakable objects on the clothes hanger.**
- **Do not allow passengers to lean their heads or bodies onto doors, put their arms on the doors, stretch their arms out of the window, or place objects between the doors and seats.**
- **Do not open or repair the side curtain air bags.**

How does the air bags system operate?

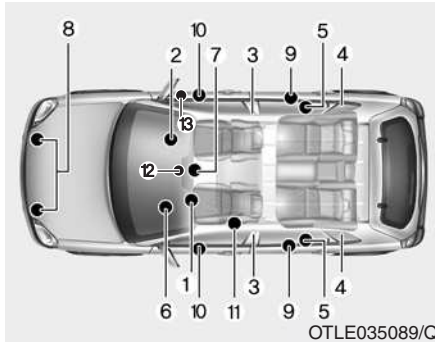

The SRS consists of the following components:

- (1) Driver's front air bag module
- (2) Passenger's front air bag module
- (3) Side air bag modules
- (4) Curtain air bag modules
- (5) Retractor pre-tensioner assemblies
- (6) Air bag warning light
- (7) SRS control module (SRSCM)/ Rollover sensor
- (8) Front impact sensors

- (9) Side impact sensors
- (10) Side pressure sensors
- (11) Emergency Fastening Device (EFD)
- (12) Passenger's front air bag OFF indicator (front passenger's seat only)
- (13) Passenger's front air bag ON/OFF switch

The SRSCM continually monitors all SRS components while the ignition switch is ON to determine if a crash impact is severe enough to require air bag deployment or pre-tensioner seat belt deployment.

FarmaSOS.com



SRS warning light

The SRS (Supplement Restraint System) air bag warning light on the instrument panel displays the air bag symbol depicted in the illustration. The system checks the air bag electrical system for malfunctions. The light indicates that there is a potential problem with your air bag system, which could include your side and/or curtain air bags used for rollover protection (if equipped with rollover sensor).

WARNING

If your SRS malfunctions, the air bag may not inflate properly during an accident increasing the risk of serious injury or death.

If any of the following conditions occur, your SRS is malfunctioning:

- **The light does not turn on for approximately six seconds when the ignition switch is in the ON position.**
- **The light stays on after illuminating for approximately six seconds.**
- **The light comes on while the vehicle is in motion.**
- **The light blinks when the engine is running.**

We recommend that an authorized HYUNDAI dealer inspect the SRS as soon as possible if any of these conditions occur.

During a moderate to severe frontal collision, sensors will detect the vehicle's rapid deceleration. If the rate of deceleration is high enough, the control unit will inflate the front air bags, at the time and with the force needed.

The front air bags help protect the driver and front passenger by responding to frontal impacts in which seat belts alone cannot provide adequate restraint. When needed, the side air bags help provide protection in the event of a side impact or rollover by supporting the side upper body area.

- Air bags are activated (able to inflate if necessary) only when the ignition switch is in the ON position.
- Air bags inflate in the event of certain frontal or side collisions to help protect the occupants from serious physical injury.
- There is no single speed at which the air bags will inflate. Generally, air bags are designed to inflate based upon the severity of a collision and its direction. These two factors determine whether the sensors produce an electronic deployment/inflation signal.

- Air bag deployment depends on a number of factors including vehicle speed, angles of impact and the density and stiffness of the vehicles or objects which your vehicle impacts during a collision. The determining factors are not limited to those mentioned above.

- The front air bags will completely inflate and deflate in an instant. It is virtually impossible for you to see the air bags inflate during an accident. It is much more likely that you will simply see the deflated air bags hanging out of their storage compartments after the collision.

- In addition to inflating in serious side collisions, vehicles equipped with a rollover sensor, side and/or curtain air bags will inflate if the sensing system detects a rollover.

When a rollover is detected, curtain air bags will remain inflated longer to help provide protection from ejection, especially when used in conjunction with the seat belts. (if equipped with a rollover sensor)

- To help provide protection, the air bags must inflate rapidly. The speed of air bag inflation is a consequence of extremely short time in which to inflate the air bag between the occupant and the vehicle structures before the occupant impacts those structures. This speed of inflation reduces the risk of serious or life-threatening injuries and is thus a necessary part of air bag design.

However, the rapid air bag inflation can also cause injuries which can include facial abrasions, bruises and broken bones because the inflation speed also causes the air bags to expand with a great deal of force.

- There are even circumstances under which contact with the air bag can cause fatal injuries, especially if the occupant is positioned excessively close to the air bag.

You can take steps to reduce the risk of being injured by an inflating air bag. The greatest risk is sitting too close to the air bag. An air bag needs space to inflate. It is recommended that drivers sit as far as possible between the center of the steering wheel and the chest while still maintaining control of the vehicle.

امداد خودرو فارما

تلفن شبانه روزی: ۰۲۱-۸۸۸۶۲۰۸۵

FarmaSOS.com



When the SRSCM detects a sufficiently severe impact to the front of the vehicle, it will automatically deploy the front air bags.

■ Driver's front air bag (2)



Upon deployment, tear seams molded directly into the pad covers will separate under pressure from the expansion of the air bags. Further opening of the covers allows full inflation of the air bags.

A fully inflated air bag, in combination with a properly worn seat belt, slows the driver's or the front passenger's forward motion, reducing the risk of head and chest injury.

■ Driver's front air bag (3)



■ Passenger's front air bag



After complete inflation, the air bag immediately starts deflating, enabling the driver to maintain forward visibility and the ability to steer or operate other controls.

WARNING

To prevent objects from becoming dangerous projectiles when the passenger's air bag inflates:

- Do not install or place any objects (drink holder, CD holder, stickers, etc.) on the front passenger's panel above the glove box where the passenger's air bag is located.
- Do not install a container of liquid air freshener near the instrument cluster or on the instrument panel surface.

What to expect after an air bag inflates

After a frontal or side air bag inflates, it will deflate very quickly. Air bag inflation will not prevent the driver from seeing out of the windshield or being able to steer. Curtain air bags may remain partially inflated for some time after they deploy.

WARNING

After an air bag inflates, take the following precautions:

- **Open your windows and doors as soon as possible after impact to reduce prolonged exposure to the smoke and powder released by the inflating air bag.**
- **Do not touch the air bag storage area's internal components immediately after an air bag has inflated. The parts that come into contact with an inflating air bag may be very hot.**

(Continued)

(Continued)

- **Always wash exposed skin areas thoroughly with cold water and mild soap.**
- **We recommend that an authorized HYUNDAI dealer replace the air bag immediately after deployment. Air bags are designed to be used only once.**

Noise and smoke from inflating air bag

When the air bags inflate, they make a loud noise and may produce smoke and powder in the air inside of the vehicle. This is normal and is a result of the ignition of the air bag inflator. After the air bag inflates, you may feel substantial discomfort in breathing because of the contact of your chest with both the seat belt and the air bag, as well as from breathing the smoke and powder. The powder may aggravate asthma for some people. If you experience breathing problems after an air bag deployment, seek medical attention immediately.

Though the smoke and powder are nontoxic, they may cause irritation to the skin, eyes, nose, throat, etc. If this is the case, wash and rinse with cold water immediately and seek medical attention if the symptoms persist.

Do not install a Child Restraint System on the front passenger seat

■ Type A



OYDESA2042

■ Type B

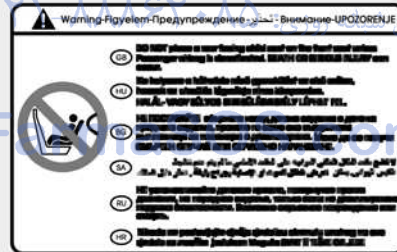

OLM034310

Never install a Child Restraint System in the front passenger seat, unless the air bag is deactivated

⚠ WARNING

NEVER use a rearward facing Child Restraint System on a seat protected by an **ACTIVE AIRBAG** in front of it, **DEATH** or **SERIOUS INJURY** to the **CHILD** can occur.

Why didn't my air bag go off in a collision?

There are certain types of accidents in which the air bag would not be expected to provide additional protection. These include rear impacts, second or third collisions in multiple impact accidents, as well as low speed impacts. Damage to the vehicle indicates a collision energy absorption, and is not an indicator of whether or not an air bag should have inflated.

Air bag collision sensors

WARNING

To reduce the risk of an air bag deploying unexpectedly and causing serious injury or death:

- Do not hit or allow any objects to impact the locations where air bags or sensors are installed.
- Do not perform maintenance on or around the air bag sensors. If the location or angle of the sensors is altered, the air bags may deploy when they should not or may not deploy when they should.
- Do not install bumper guards or replace the bumper with a non-genuine part. This may adversely affect the collision and air bag deployment performance.

(Continued)

(Continued)

- Place the ignition switch to the LOCK/OFF or ACC position, when the vehicle is being towed to prevent inadvertent air bag deployment.
- We recommend that all air bag repairs are conducted by an authorized HYUNDAI dealer.

Safety system of your vehicle

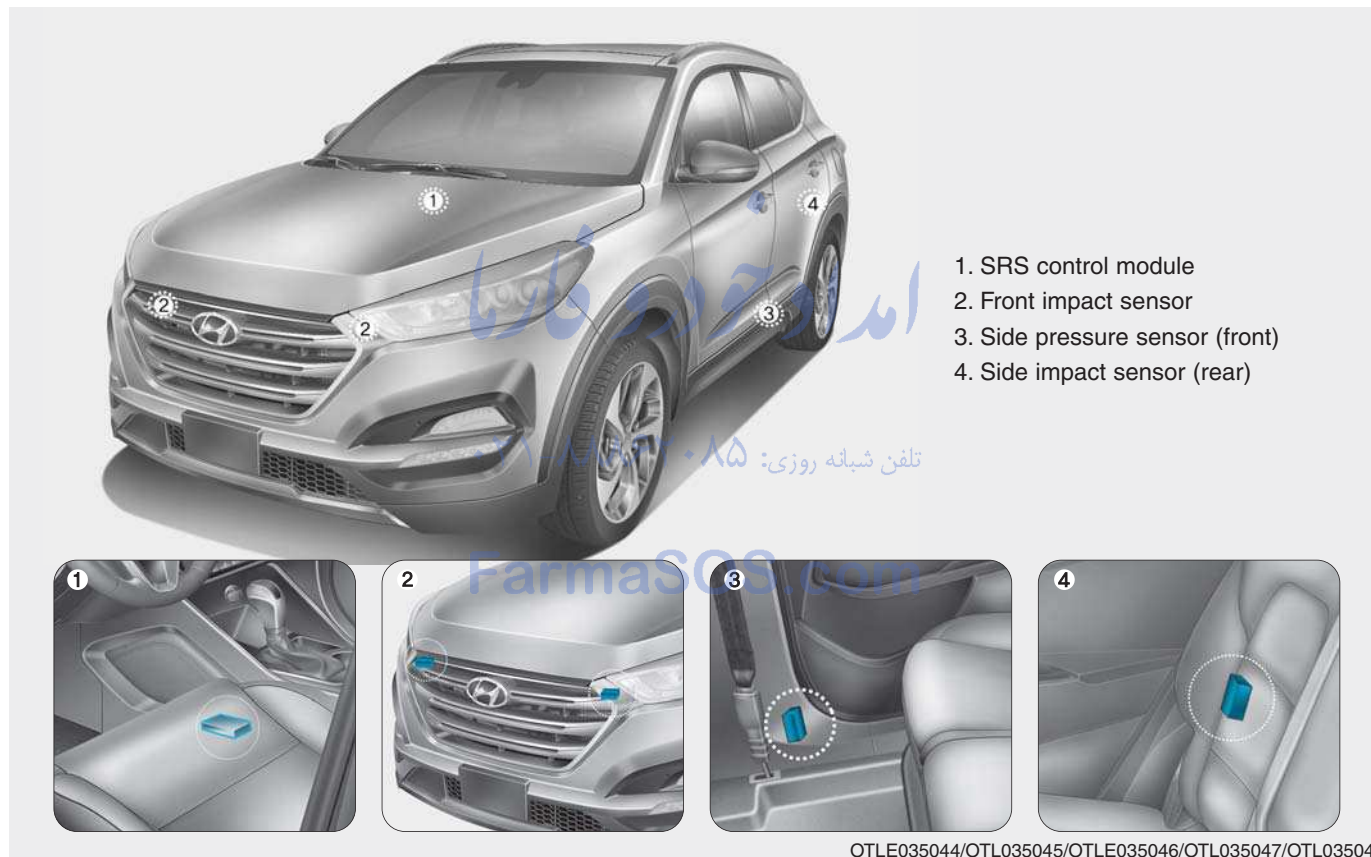

Air bag inflation conditions



Front air bags

Front air bags are designed to inflate in a frontal collision depending on the severity, speed or angles of impact of the front collision.



Side and curtain air bags

Side and curtain air bags are designed to inflate when an impact is detected by side collision sensors depending on the severity, speed or angles of impact resulting from a side impact collision.

Although the driver's and front passenger's air bags are designed to inflate in frontal collisions, they also may inflate in other types of collisions if the front impact sensors detect a sufficient impact. Side and curtain air bags are designed to inflate in side impact collisions, but they may inflate in other collisions if the side impact sensors detect a sufficient impact.

Also, the side and curtain air bags are designed to inflate when a rollover is detected by a rollover sensor. (if equipped with rollover sensor)

If the vehicle chassis is impacted by bumps or objects on unimproved roads, the air bags may deploy. Drive carefully on unimproved roads or on surfaces not designed for vehicle traffic to prevent unintended air bag deployment.

Air bag non-inflation conditions



In certain low-speed collisions the air bags may not deploy. The air bags are designed not to deploy in such cases because they may not provide benefits beyond the protection of the seat belts.



Front air bags are not designed to inflate in rear collisions, because occupants are moved backward by the force of the impact. In this case, inflated air bags would not provide any additional benefit.

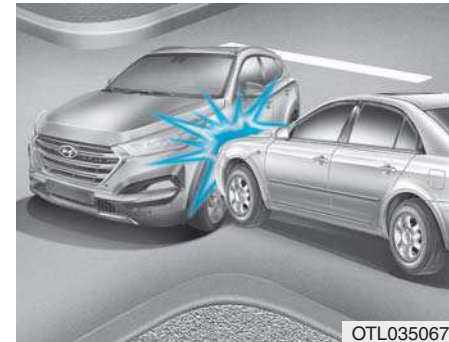

Front air bags may not inflate in side impact collisions, because occupants move in the direction of the collision, and thus in side impacts, front air bag deployment would not provide additional occupant protection.

However, side and curtain air bags may inflate depending on the severity, vehicle speed and angles of impact.

FarmaSOS.com

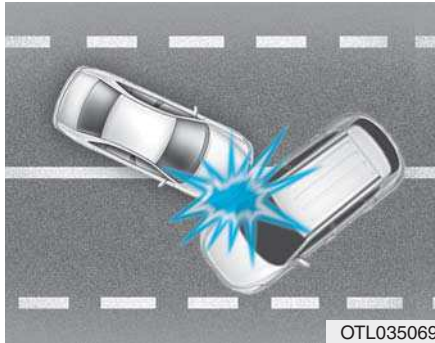

OTL035069

In an angled collision, the force of impact may direct the occupants in a direction where the air bags would not be able to provide any additional benefit, and thus the sensors may not deploy any air bags.



OTL035064

Just before impact, drivers often brake heavily. Such heavy braking lowers the front portion of the vehicle causing it to “ride” under a vehicle with a higher ground clearance. Air bags may not inflate in this “under-ride” situation because deceleration forces that are detected by sensors may be significantly reduced by such “underride” collisions.

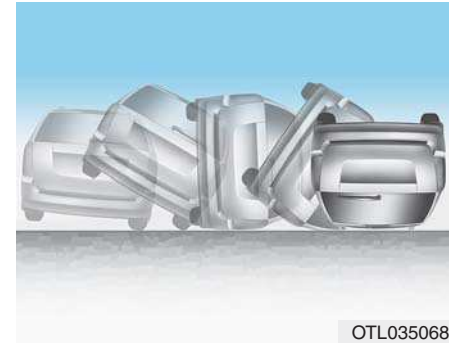

OTL035068

Front air bags may not inflate in rollover accidents because front air bag deployment would not provide additional occupant protection.

i Information

- **Vehicles equipped with rollover sensor**
The side and curtain air bags may inflate in a rollover situation, when it is detected by the rollover sensor.
- **Vehicles not equipped with rollover sensor**
The side and/or curtain air bags may inflate when the vehicle is rolled over by a side impact collision, if the vehicle is equipped with side and/or curtain air bags.



Air bags may not inflate if the vehicle collides with objects such as utility poles or trees, where the point of impact is concentrated and the collision energy is absorbed by the vehicle structure.

SRS care

The SRS is virtually maintenance-free and there are no parts you can safely service by yourself. If the SRS air bag warning light does not illuminate when the ignition switch is in the ON position, or continuously remains on, we recommend that the system be immediately inspected by an authorized HYUNDAI dealer.

We recommend any work on the SRS system, such as removing, installing, repairing, or any work on the steering wheel, the front passenger's panel, front seats and roof rails be performed by an authorized HYUNDAI dealer. Improper handling of the SRS system may result in serious personal injury.

WARNING

To reduce the risk of serious injury or death take the following precautions:

- Do not attempt to modify or disconnect the SRS components or wiring, including the addition of any kind of badges to the pad covers or modifications to the body structure.

(Continued)

(Continued)

- Do not place objects over or near the air bag modules on the steering wheel, instrument panel, and the front passenger's panel above the glove box.
- Clean the air bag pad covers with a soft cloth moistened with plain water. Solvents or cleaners could adversely affect the air bag covers and proper deployment of the system.
- We recommend that inflated air bags be replaced by an authorized HYUNDAI dealer.
- If components of the air bag system must be discarded, or if the vehicle must be scrapped, certain safety precautions must be observed. Consult an authorized HYUNDAI dealer for the necessary information. Failure to follow these precautions could increase the risk of personal injury.

Additional safety precautions

Passengers should not move out of or change seats while the vehicle is moving. A passenger who is not wearing a seat belt during a crash or emergency stop can be thrown against the inside of the vehicle, against other occupants, or be ejected from the vehicle.

Do not use any accessories on seat belts. Devices claiming to improve occupant comfort or reposition the seat belt can reduce the protection provided by the seat belt and increase the chance of serious injury in a crash

Do not modify the front seats.

Modification of the front seats could interfere with the operation of the supplemental restraint system sensing components or side air bags.

Do not place items under the front seats. Placing items under the front seats could interfere with the operation of the supplemental restraint system sensing components and wiring harnesses.

Do not cause impact to the doors. Impact to the doors when the ignition switch is in the ON position may cause the air bags to inflate.

Adding equipment to or modifying your air bag equipped vehicle

If you modify your vehicle by changing your vehicle's frame, bumper system, front end or side sheet metal or ride height, this may affect the operation of your vehicle's air bag system.

امداد خودرو فارما

تلفن شبانه روزی: ۰۲۱-۸۸۸۶۲۰۸۵

FarmaSOS.com

Air bag warning labels



Air bag warning labels are attached to alert the passengers of potential risks of the air bag system.

Be sure to read all of the information about the air bags that are installed on your vehicle in this Owner's Manual.

ACTIVE HOOD LIFT SYSTEM (IF EQUIPPED)

The active hood lift system can reduce a risk of injury to pedestrians by raising the hood in certain accident situations. The active hood lift system has the additional deformation space under the hood, which is made available for subsequent head impact.

The active hood lift system is activated in the following situations:

- The ignition switch is in the on position and the vehicle speed is approximately between 25 km/h (15.5 mph) and 50 km/h (31 mph).
- The active hood lift system is designed to work in a frontal collision depending on the intensity, speed or angles of impact of the front collision.

i Information

- **Do not arbitrarily repair the active hood lift system after its activation. We recommend you to have the system repaired by an authorized HYUNDAI dealer.**
- **If you change or repair the front bumper, we recommend that the system be checked by an authorized HYUNDAI dealer.**

Possible activation situations



- The vehicle falls from a high location, such as falling into the gutter.
- The vehicle is involved in a certain high-speed frontal/angled collision, striking other vehicles or barriers.

i Information

An impact may be detected in a frontal collision with animals, trash cans or others, not with pedestrians.

Non-activation situations



- The vehicle is involved in a side/rear collision or a rollover. The active hood lift system activates only in a frontal collision.

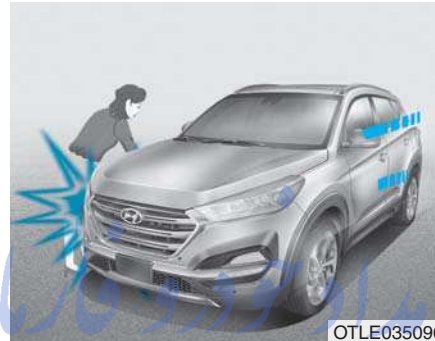

- The vehicle is involved in an angled frontal collision, striking the pedestrian.
- تلفن شبانه روزی: ۰۲۱-۸۸۸۶۲۰۸۵

FarmaSOS.com



- The pedestrian lies on the road.
- The front bumper is damaged or modified.
- The pedestrian has an object to absorb shocks, such as a suit case, a cart, or a stroller.

System malfunction



The warning message appears on the LCD display, when there is a malfunction with the active hood lift system.

The warning message indicates that the active hood lift system may not properly operate to protect the pedestrians.

In this case, we recommend you to immediately have the system checked by an authorized HYUNDAI dealer.

NOTICE

The below situations may cause a malfunction with the active hood lift system.

- Do not remove or change the components and the wiring of the active hood system.
- Do not change the front bumper or the body structure.
- Do not install or assemble any aftermarket accessory on the front bumper or cover.
- When replacing tires, make sure they are the same size as your original tires. If you drive with different tire or wheel sizes, the active hood lift system may not work normally.

Convenient features of your vehicle

Accessing your vehicle	3-4	Panorama sunroof	3-37
Remote key	3-4	Sunshade	3-38
Smart key	3-8	Sliding the sunroof	3-38
Battery replacement	3-12	Tilting the sunroof	3-39
Immobilizer system	3-13	Closing the sunroof	3-39
Door locks	3-14	Resetting the sunroof	3-41
From outside the vehicle	3-14	Sunroof open warning	3-41
From inside the vehicle	3-16	Exterior features	3-42
Deadlocks	3-18	Hood	3-42
Auto door lock/unlock features	3-18	Fuel filler door	3-44
Child-protector rear door locks	3-19	Tailgate	3-47
Theft-alarm system	3-20	Non-power tailgate	3-47
Steering wheel	3-22	Power tailgate	3-49
Electric power steering (EPS)	3-22	Smart tailgate	3-56
Tilt steering / Telescope steering	3-23	Instrument cluster	3-60
Heated steering wheel	3-24	Instrument cluster control	3-62
Horn	3-24	Gauges	3-63
Mirrors	3-25	LCD display	3-69
Inside rearview mirror	3-25	LCD display control	3-69
Outside rearview mirror	3-29	LCD modes	3-69
Windows	3-32	User settings mode	3-74
Power windows	3-32	Warning messages	3-78
		Trip computer	3-87
		Trip modes	3-87

Warning and indicator lights	3-92	Automatic climate control system	3-165
Warning lights.....	3-92	Automatic heating and air conditioning.....	3-166
Indicator lights.....	3-102	Manual heating and air conditioning.....	3-167
Light	3-109	System operation.....	3-173
Exterior lights.....	3-109	System maintenance.....	3-175
Welcome system.....	3-116	Windshield defrosting and defogging	3-178
Interior lights.....	3-117	Manual climate control system.....	3-178
Wipers and washers	3-122	Automatic climate control system.....	3-179
Windshield wipers.....	3-123	Defogging logic.....	3-180
Windshield washers.....	3-124	Climate control additional features	3-182
Rear window wiper and washer switch.....	3-125	Cluster ionizer.....	3-182
Driver assist system	3-126	Automatic ventilation.....	3-182
Rear view camera.....	3-126	Sunroof inside air recirculation.....	3-182
Rear parking assist system.....	3-127	Storage compartment	3-183
Rear parking assist system precautions.....	3-130	Center console storage.....	3-183
Parking Assist System.....	3-131	Sliding armrest.....	3-183
Parking assist system precautions.....	3-133	Glove box.....	3-184
Smart Parking Assist System (SPAS).....	3-134	Cool box.....	3-184
Defroster	3-152	Sunglass holder.....	3-184
Rear window defroster.....	3-152		
Manual climate control system	3-154		
Heating and air conditioning.....	3-155		
System operation.....	3-159		
System maintenance.....	3-162		

Interior features.....3-186
Ashtray3-186
Cup holder.....3-186
Sunvisor3-188
Power outlet.....3-188
Cigarette lighter3-190
Clock.....3-190
Clothes hanger3-192
Floor mat anchor(s).....3-193
Luggage net (holder)3-193
Cargo security screen3-194
Luggage tray.....3-197
Exterior features3-198
Roof rack3-198

امداد خودرو فارما

تلفن شبانه روزی: ۰۲۱-۸۸۶۲۰۸۵

FarmaSOS.com

ACCESSING YOUR VEHICLE

Remote key (if equipped)



OTLE045001

Your HYUNDAI uses a remote key, which you can use to lock or unlock a door (and tailgate) and even start the engine.

1. Door Lock
2. Door Unlock
3. Tailgate Unlock

Locking

To lock :

1. Close all doors, engine hood and tailgate.
2. Press the Door Lock button (1) on the remote key.
3. The doors will lock. The hazard warning lights will blink. Also, the outside rearview mirror will fold, if the outside rearview mirror folding switch is in the AUTO position (if equipped).
4. Make sure the doors are locked by checking the position of the door lock button inside the vehicle.

WARNING

Do not leave the keys in your vehicle with unsupervised children. Unattended children could place the key in the ignition switch and may operate power windows or other controls, or even make the vehicle move, which could result in serious injury or death.

Unlocking

To unlock:

1. Press the Door Unlock button (2) on the remote key.
2. The doors will unlock. The hazard warning lights will blink two times. Also, the outside rearview mirror will unfold, if the outside rearview mirror folding switch is in the AUTO position (if equipped).

Information

After unlocking the doors, the doors will lock automatically after 30 seconds unless a door is opened.

Tailgate unlocking

To unlock:

1. Press the Tailgate Unlock button (3) on the remote key for more than one second.
2. The hazard warning lights will blink two times. The tailgate will unlock. The power tailgate will unlock and then open (if equipped).

For more details, refer to “Power tailgate” in this chapter.

i Information

The word "HOLD" is written on the button to inform you that you must press and hold the button for more than one second.

Start-up

For detailed information refer to “Key Ignition Switch” in chapter 5.

NOTICE

To prevent damaging the remote key:

- Keep the remote key away from water or any liquid and fire. If the inside of the remote key gets damp (due to drinks or moisture), or is heated, internal circuit may malfunction, excluding the car from the warranty.
- Avoid dropping or throwing the remote key.
- Protect the remote key from extreme temperatures.

Mechanical key

■ Type A



OED036001A

■ Type B



OTLE045002

If the remote key does not operate normally, you can lock or unlock the door by using the mechanical key.

Type B

To unfold the key, press the release button then the key will unfold automatically.

To fold the key, fold the key manually while pressing the release button.

NOTICE

Do not fold the key without pressing the release button. This may damage the key.

Remote key precautions

The remote key will not work if any of the following occur:

- The key is in the ignition switch.
- You exceed the operating distance limit (about 30 m [90 feet]).
- The remote key battery is weak.
- Other vehicles or objects may be blocking the signal.
- The weather is extremely cold.
- The remote key is close to a radio transmitter such as a radio station or an airport which can interfere with normal operation of the remote key.

When the remote key does not work correctly, open and close the door with the mechanical key. If you have a problem with the remote key, it is recommended that you contact an authorized HYUNDAI dealer.

(Continue)

(Continue)

If the remote key is in close proximity to your mobile phone, the signal could be blocked by your mobile phones normal operational signals. This is especially important when the phone is active such as making and receiving calls, text messaging, and/or sending/receiving emails. Avoid placing the remote key and your mobile phone in the same pants or jacket pocket and always try to maintain an adequate distance between the two devices.

i Information

Changes or modifications not expressly approved by the party responsible for compliance could void the user's authority to operate the equipment. If the keyless entry system is inoperative due to changes or modifications not expressly approved by the party responsible for compliance, it will not be covered by your manufacturer's vehicle warranty.

NOTICE

Keep the remote key away from electromagnetic materials that blocks electromagnetic waves to the key surface.

Battery replacement

If the remote key is not working properly, try replacing the battery with a new one.



Battery Type: CR2032

To replace the battery:

1. Insert a slim tool into the slot and gently pry open the cover.
2. Remove the old battery and insert the new battery. Make sure the battery position is correct.
3. Reinstall the rear cover of the remote key.

If you suspect your remote key might have sustained some damage, or you feel your remote key is not working correctly, it is recommended that you contact an authorized HYUNDAI dealer.

i Information



An inappropriately disposed battery can be harmful to the environment and human health. Dispose the battery according to your local law(s) and regulation.

Smart key (if equipped)



Your HYUNDAI uses a Smart Key, which you can use to lock or unlock a door (and tailgate) and even start the engine.

1. Door Lock
2. Door Unlock
3. Tailgate Unlock

Locking

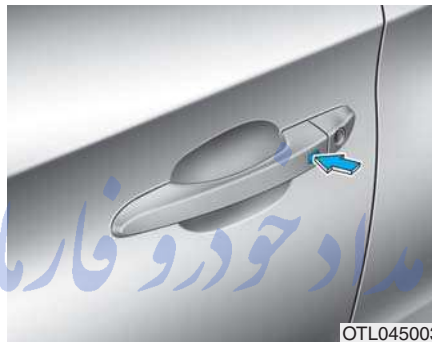

To lock :

1. Close all doors, engine hood and tailgate.
2. Either press the door handle button or press the Door Lock button (1) on the smart key.
3. The hazard warning lights will blink. Also, the outside rearview mirror will fold, if the outside rearview mirror folding switch is in the AUTO position (if equipped).
4. Make sure the doors are locked by checking the position of the door lock button inside the vehicle.

i Information

The door handle button will only operate when the smart key is within 0.7~1 m (28~40 in.) from the outside door handle.

Even though you press the outside door handle button, the doors will not lock and the chime will sound for three seconds if any of the following occur:

- The Smart Key is in the vehicle.
- The Engine Start/Stop button is in ACC or ON position.
- Any door except the tailgate is open.

WARNING

Do not leave the Smart Key in your vehicle with unsupervised children. Unattended children could press the Engine Start/Stop button and may operate power windows or other controls, or even make the vehicle move, which could result in serious injury or death.

Unlocking

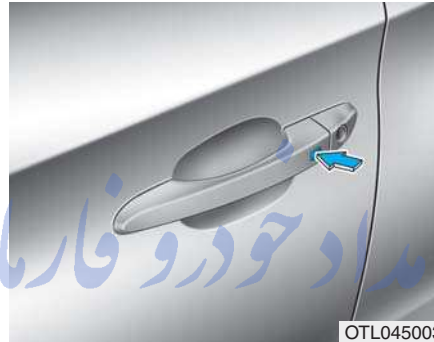

To unlock:

1. Carry the Smart Key. *تلفن شبانه روزی: ۰۲۱-۸۸۸۸۸۸۸۸*
2. Either press the door handle button or press the Door Unlock button (2) on the smart key.
3. The doors will unlock. The hazard warning lights will blink two times. Also, the outside rearview mirror will unfold, if the outside rearview mirror folding switch is in the AUTO position. (if equipped)

Information

- The door handle button will only operate when the smart key is within 0.7~1 m (28~40 in.) from the outside door handle. Other people can also open the doors without the smart key in possession.
- After unlocking the doors, the doors will lock automatically after 30 seconds unless a door is opened.

Tailgate unlocking

To unlock:

1. Carry the smart key.
2. Either press the tailgate handle button or press the Tailgate Unlock button (3) on the smart key for more than one second.
3. The hazard warning lights will blink two times. The tailgate will unlock. The power tailgate will unlock and then open (if equipped).

For more details, refer to “Power tailgate” in this chapter.

i Information

After unlocking the tailgate, the tailgate will lock automatically after 30 seconds unless the tailgate is opened.

Start-up

You can start the engine without inserting the key. **For detailed information refer to the Engine Start/Stop button in chapter 5.**

NOTICE

To prevent damaging the smart key:

- **Keep the smart key away from water or any liquid and fire. If the inside of the smart key gets damp (due to drinks or moisture), or is heated, internal circuit may malfunction, excluding the car from the warranty.**
- **Avoid dropping or throwing the smart key.**
- **Protect the smart key from extreme temperatures.**

Mechanical key

If the Smart Key does not operate normally, you can lock or unlock the door by using the mechanical key.



Press and hold the release button (1) and remove the mechanical key (2). Insert the mechanical key into the key hole on the door.

To reinstall the mechanical key, put the key into the hole and push it until a click sound is heard.

Loss of a smart key

A maximum of two smart keys can be registered to a single vehicle. If you happen to lose your smart key, it is recommended that you should immediately take the vehicle and remaining key to your authorized HYUNDAI dealer or tow the vehicle, if necessary.

Smart key precautions

The smart key will not work if any of the following occur:

- The smart key is close to a radio transmitter such as a radio station or an airport which can interfere with normal operation of the transmitter.
- The smart key is near a mobile two way radio system or a cellular phone.
- Another vehicle's smart key is being operated close to your vehicle.

When the smart key does not work correctly, open and close the door with the mechanical key. If you have a problem with the smart key, it is recommended that you contact an authorized HYUNDAI dealer.

If the smart key is in close proximity to your mobile phone, the signal could be blocked by your mobile phones normal operational signals. This is especially important when the phone is active such as making and receiving calls, text messaging, and/or sending/receiving emails. Avoid placing the smart key and your mobile phone in the same pants or jacket pocket and always try to maintain an adequate distance between the two devices.

i Information

Changes or modifications not expressly approved by the party responsible for compliance could void the user's authority to operate the equipment. If the keyless entry system is inoperative due to changes or modifications not expressly approved by the party responsible for compliance, it will not be covered by your manufacturer's vehicle warranty.

NOTICE

Keep the smart key away from electromagnetic materials that blocks electromagnetic waves to the key surface.

Battery replacement



If the Smart Key is not working properly, try replacing the battery with a new one.

Battery Type: CR2032

To replace the battery:

1. Pry open the rear cover of the smart key.
2. Remove the old battery and insert the new battery. Make sure the battery position is correct.
3. Reinstall the rear cover of the smart key.

If you suspect your smart key might have sustained some damage, or you feel your smart key is not working correctly, it is recommended that you contact an authorized HYUNDAI dealer.

i Information



An inappropriately disposed battery can be harmful to the environment and human health. Dispose the battery according to your local law(s) and regulation.

Immobilizer system (if equipped)

The immobilizer system protects your vehicle from theft. If an improperly coded key (or other device) is used, the engine's fuel system is disabled.

When the ignition switch is placed in the ON position, the immobilizer system indicator should come on briefly, then go off. If the indicator starts to blink, the system does not recognize the coding of the key.

Place the ignition switch to the LOCK/OFF position, then place the ignition switch to the ON position again.

The system may not recognize your key's coding if another immobilizer key or other metal object (i.e., key chain) is near the key. The engine may not start because the metal may interrupt the transponder signal from transmitting normally.

If the system repeatedly does not recognize the coding of the key, it is recommended that you contact your HYUNDAI dealer.

Do not attempt to alter this system or add other devices to it. Electrical problems could result that may make your vehicle inoperable.

WARNING

In order to prevent theft of your vehicle, do not leave spare keys anywhere in your vehicle. Your immobilizer password is a customer unique password and should be kept confidential.

NOTICE

The transponder in your key is an important part of the immobilizer system. It is designed to give years of trouble-free service, however you should avoid exposure to moisture, static electricity and rough handling. Immobilizer system malfunction could occur.

FarmaSOS.com

DOOR LOCKS

Operating door locks from outside the vehicle

Mechanical key

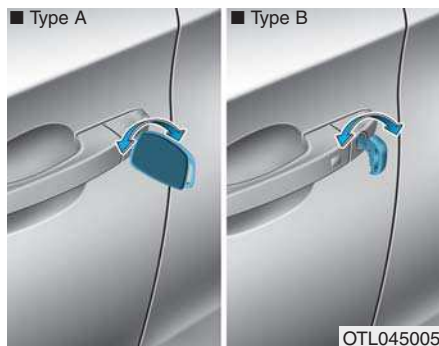

Turn the key toward the rear of the vehicle to unlock and toward the front of the vehicle to lock.

If you lock/unlock the driver's door with a key, all vehicle doors will lock/unlock automatically.

Once the doors are unlocked, they may be opened by pulling the door handle.

When closing the door, push the door by hand. Make sure that doors are closed securely.

Remote key



To lock the doors, press the Door Lock button (1) on the remote key.

To unlock the doors, press the Door Unlock button (2) on the remote key.

Once the doors are unlocked, they may be opened by pulling the door handle.

When closing the door, push the door by hand. Make sure that doors are closed securely.

i Information

- In cold and wet climates, door lock and door mechanisms may not work properly due to freezing conditions.
- If the door is locked/unlocked multiple times in rapid succession with either the vehicle key or door lock switch, the system may stop operating temporarily in order to protect the circuit and prevent damage to system components.

Smart key



1. Door lock
2. Door unlock
3. Tailgate open

To lock the doors, press the button on the outside door handle while carrying the smart key with you or press the door lock button on the smart key.

To unlock the doors, press the button on the outside door handle while carrying the smart key with you or press the door unlock button on the smart key.

Once the doors are unlocked, they may be opened by pulling the door handle.

When closing the door, push the door by hand. Make sure that doors are closed securely.

تلفن شبانه روزی: ۰۲۱-۸۸۸۲۰۸۵

FarmaSOS.com

i Information

- In cold and wet climates, door lock and door mechanisms may not work properly due to freezing conditions.
- If the door is locked/unlocked multiple times in rapid succession with either the vehicle key or door lock switch, the system may stop operating temporarily in order to protect the circuit and prevent damage to system components.

Operating door locks from inside the vehicle

With the door lock button



- To unlock a door, push the door lock button (1) to the “Unlock” position. The red mark (2) on the door lock button will be visible.
- To lock a door, push the door lock button (1) to the “Lock” position. If the door is locked properly, the red mark (2) on the door lock button will not be visible.
- To open a door, pull the door handle (3) outward.

- Front doors cannot be locked if the key is in the ignition switch and any front door is open.
- Doors cannot be locked if the smart key is in the vehicle and any door is open.

i Information

If a power door lock ever fails to function while you are in the vehicle try one or more of the following techniques to exit:

Operate the door unlock feature repeatedly (both electronic and manual) while simultaneously pulling on the door handle.

Operate the other door locks and handles, front and rear.

Lower a front window and use the mechanical key to unlock the door from outside.

With the door handle

Front door

If the inner door handle is pulled when the door is locked, the door will unlock and open.

Rear door

If the inner door handle is pulled once when the door is locked, the door will unlock.

If the inner door handle is pulled once more, the door will open.

With the central door lock switch



When pressing the (🔒) portion (1) of the switch, all vehicle doors will lock.

- If any door is opened, the doors will not lock even though the lock button (1) of the central door lock switch is pressed.
- If the smart key is in the vehicle and any door is opened, the doors will not lock even though the lock button (1) of the central door lock switch is pressed.

When pressing the (🔓) portion (2) of the switch, all vehicle doors will unlock.

⚠️ WARNING

The doors should always be fully closed and locked while the vehicle is in motion. If the doors are unlocked, the risk of being thrown from the vehicle in a crash is increased.

⚠️ WARNING

Do not leave children or animals unattended in your vehicle. An enclosed vehicle can become extremely hot, causing death or serious injury to unattended children or animals who cannot escape the vehicle. Children might operate features of the vehicle that could injure them, or they could encounter other harm, possibly from someone gaining entry to the vehicle.

⚠️ WARNING

Leaving your vehicle unlocked increases the potential risk to you or others from someone hiding in your vehicle.

To secure your vehicle, while depressing the brake, move the shift lever to the P (Park) position (for automatic transaxle/dual clutch transmission) or first gear or R (Reverse, for manual transaxle), engage the parking brake, and place the ignition switch in the LOCK/OFF position, close all windows, lock all doors, and always take the key with you.

⚠️ WARNING

Opening a door when something is approaching may cause damage or injury. Be careful when opening doors and watch for vehicles, motorcycles, bicycles or pedestrians approaching the vehicle in the path of the door.

Deadlocks (if equipped)

Some vehicles are equipped with a deadlock system. Deadlocks prevent opening of a door from either inside or outside the vehicle once the deadlocks have been activated providing an additional measure of vehicle security.

To lock the vehicle using the deadlock function, the doors must be locked by using the remote key or smart key. To unlock the vehicle, the transmitter or smart key must be used again.

WARNING

Do not lock the doors with the remote key or the smart key with anybody left in the vehicle. The passenger in the vehicle cannot unlock the doors with the door lock button. For example, if the door is locked with the remote key, the passenger in the vehicle cannot unlock the door without the transmitter.

Auto door lock/unlock features

Impact sensing door unlock system (if equipped)

All doors will be automatically unlocked when an impact causes the air bags to deploy.

Speed sensing door lock system (if equipped)

All doors will be automatically locked when vehicle speed exceeds 15 km/h (9 mph).

You can activate or deactivate the Auto Door Lock/Unlock features from the User Settings Mode on the LCD display. **For more details, refer to "LCD Display" in this chapter.**

تلفن شبانه روزی: ۰۲۱-۸۸۸۶۲۰۸۵

FarmaSOS.com

Child-protector rear door locks

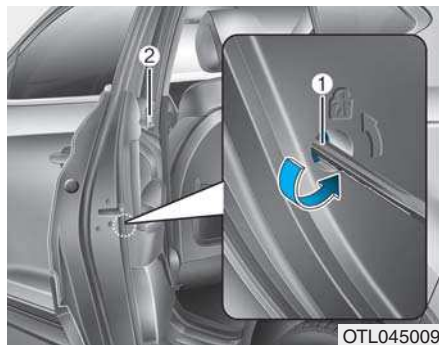

The child safety lock is provided to help prevent children seated in the rear from accidentally opening the rear doors. The rear door safety locks should be used whenever children are in the vehicle.

The child safety lock is located on the edge of each rear door. When the child safety lock is in the lock position (1), the rear door will not open if the inner door handle (2) is pulled.

To lock the child safety lock, insert a key (or screwdriver) into the hole and turn it to the lock position.

To allow a rear door to be opened from inside the vehicle, unlock the child safety lock.

WARNING

If children accidentally open the rear doors while the vehicle is in motion, they could fall out of the vehicle. The rear door safety locks should always be used whenever children are in the vehicle.

تلفن شبانه روزی: ۰۸۵+۸۸۶۰۳۰۰

FarmaSOS.com

THEFT-ALARM SYSTEM (IF EQUIPPED)

This system helps to protect your vehicle and valuables. The horn will sound and the hazard warning lights will blink continuously if any of the following occurs:

- A door is opened without using the remote key or smart key.
- The tailgate is opened without using the remote key or smart key.
- The engine hood is opened.

The alarm continues for 30 seconds, then the system resets. To turn off the alarm, unlock the doors with the remote key or smart key.

The Theft Alarm System automatically sets 30 seconds after you lock the doors and the tailgate. For the system to activate, you must lock the doors and the tailgate from outside the vehicle with the remote key or smart key or by pressing the button on the outside of the door handles with the smart key in your possession.

The hazard warning lights will blink and the chime will sound once to indicate the system is armed.

Once the security system is set, opening any door, the tailgate, or the hood without using the remote key or smart key will cause the alarm to activate.

The Theft Alarm System will not set if the hood, the tailgate, or any door is not fully closed. If the system will not set, check the hood, the tailgate, or the doors are fully closed.

Do not attempt to alter this system or add other devices to it.

Information

- **Do not lock the doors until all passengers have left the vehicle. If the remaining passenger leaves the vehicle when the system is armed, the alarm will be activated.**
- **If the vehicle is not disarmed with the remote key or smart key, open the doors by using the mechanical key and place the ignition switch in the ON position (for remote key) or start the engine (for smart key) and wait for 30 seconds.**
- **When the system is disarmed but a door or tailgate is not opened within 30 seconds, the system will be rearmed.**

تلفن شبانه روزی: ۰۲۱-۸۸۸۶۲۰۸۵

FarmaSOS.com



i Information

Vehicles equipped with a theft alarm system will have a label attached to the vehicle with the following words:

1. WARNING
2. SECURITY SYSTEM

امداد خودرو فارما

تلفن شبانه روزی: ۰۲۱-۸۸۸۶۲۰۸۵

FarmaSOS.com

STEERING WHEEL

Electric power steering (EPS)

The system assists you with steering the vehicle. If the engine is off or if the power steering system becomes inoperative, the vehicle may still be steered, but it will require increased steering effort.

Also, the steering effort becomes heavier as the vehicle's speed increases and becomes lighter as the vehicle's speed decreases for better control of the steering wheel.

Should you notice any change in the effort required to steer during normal vehicle operation, we recommend that the system be checked by an authorized HYUNDAI dealer.

NOTICE

If the Electric Power Steering System does not operate normally, the warning light (⊖!) will illuminate on the instrument cluster. The steering wheel may become difficult to control or operate. We recommend to take your vehicle to an authorized HYUNDAI dealer and have the system checked as soon as possible.

i Information

The following symptoms may occur during normal vehicle operation:

- The steering effort may be high immediately after placing the ignition switch in the ON position.

This happens as the system performs the EPS system diagnostics. When the diagnostics is completed, the steering wheel will return to its normal condition.

(Continued)

(Continued)

- A click noise may be heard from the EPS relay after the ignition switch is placed to the ON or LOCK/OFF position.

A click noise may be heard from the EPS relay after the Engine Start/Stop button is in the ON or OFF position. (With Smart key system)

- Motor noise may be heard when the vehicle is at a stop or at a low driving speed.
- When you operate the steering wheel in low temperature, the steering effort may be high and abnormal noise may occur. If temperature rises, the noise will disappear. This is a normal condition.
- When the vehicle is stationary, if you turn the steering wheel all the way to the left or right continuously, the steering wheel effort increases. This is not a system malfunction. As time passes, the steering wheel effort will return to its normal condition.

Tilt steering / Telescope steering

WARNING

Never adjust the steering wheel while driving. You may lose steering control and cause severe personal injury, death or accidents.

Information

After adjustment, sometimes the lock-release lever may not lock the steering wheel.

It is not a malfunction. This occurs when two gears are not engaged correctly. In this case, adjust the steering wheel again and then lock the steering wheel.



Pull down the lock-release lever (1) on the steering wheel column and adjust the steering wheel angle (2) and position (3). Move the steering wheel, so it points toward your chest, not toward your face. Make sure you can see the instrument cluster warning lights and gauges.

After adjusting, pull up the lock-release lever (1) to lock the steering wheel in place. Push the steering wheel both up and down to be certain it is locked in position. Always adjust the position of the steering wheel before driving.

Heated steering wheel (if equipped)

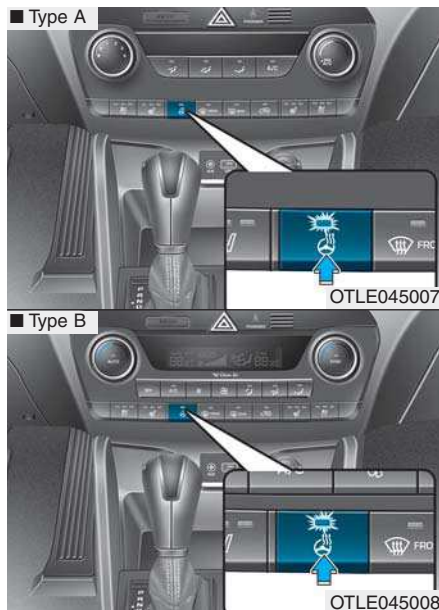

When the ignition switch is in the ON position or when the engine is running, press the heated steering wheel button to warm the steering wheel. The indicator on the button will illuminate.

To turn the heated steering wheel off, press the button again. The indicator on the button will turn off.

i Information

The heated steering wheel will turn off automatically approximately 30 minutes after the heated steering wheel is turned on.

NOTICE

Do not install any cover or accessory on the steering wheel. This cover or accessory could cause damage to the heated steering wheel system.

FarmaSOS.com

Horn



To sound the horn, press the area indicated by the horn symbol on your steering wheel (see illustration). The horn will operate only when this area is pressed.

NOTICE

Do not strike the horn severely to operate it, or hit it with your fist. Do not press on the horn with a sharp-pointed object.

MIRRORS

Inside rearview mirror

Before you start driving, adjust the rearview mirror to the center on the view through the rear window.

WARNING

Make sure your line of sight is not obstructed. Do not place objects in the rear seat, cargo area, or behind the rear headrests which could interfere with your vision through the rear window.

WARNING

To prevent serious injury during an accident or deployment of the air bag, do not modify the rearview mirror and do not install a wide mirror.

WARNING

NEVER adjust the mirror while driving. This may cause loss of vehicle control resulting in an accident.

NOTICE

When cleaning the mirror, use a paper towel or similar material dampened with glass cleaner. Do not spray glass cleaner directly on the mirror as that may cause the liquid cleaner to enter the mirror housing.

Day/night rearview mirror (if equipped)

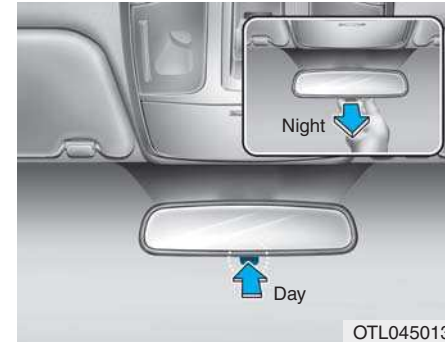

Make this adjustment before you start driving and while the day/night lever is in the day position.

Pull the day/night lever toward you to reduce glare from the headlights of the vehicles behind you during night driving.

Remember that you lose some rearview clarity in the night position.

FarmaSOS.com

Electric Chromic Mirror (ECM) (if equipped)

The electric rearview mirror automatically controls the glare from the headlamp of the car behind you in night-time or low light driving conditions.

When the engine is running, the glare is automatically controlled by the sensor mounted in the rearview mirror. The sensor detects the light level around the vehicle, and automatically adjusts to control the headlamp glare from vehicles behind you.

Whenever the shift lever is placed in R (Reverse), the mirror will automatically go to the brightest setting in order to improve the drivers view behind the vehicle.



To operate the electric rearview mirror:

- Press the ON/OFF button (1) to turn the automatic dimming function off. The mirror indicator light will turn off.

Press the ON/OFF button (1) to turn the automatic dimming function on. The mirror indicator light will illuminate.

- The mirror defaults to the ON position whenever the ignition switch or the Engine Start/Stop button is in the ON position.

Electric chromic mirror (ECM) with compass (if equipped)



1. Feature Control Button
2. Status Indicator LED
3. Rear Light Sensor
4. Display Window

Automatic dimming rear view mirror automatically controls the glare of the headlights of the vehicle behind you when it is turned on by pressing and holding the button (1) for more than 3 but less than 6 seconds. It is turned off by pressing and holding the button (1) once more for more than 3 seconds but less than 6 seconds.

1. To operate Compass feature

Press and release the compass button, then the vehicle's directional heading will be displayed. Pressing and releasing the button again will turn off the display.

Heading display

- E : East
- W : West
- S : South
- N : North
- ex) NE : North East

2. Calibration procedure

Press and hold the button for more than 6 but less than 9 seconds. When the compass memory is cleared a "C" will appear in the display.

- Driving the vehicle in a circle at less than 8km/h 2 times or until the compass heading appears.
- Driving in a circle in right-handed direction and opposite direction are possible, and if the calibration is completed, the compass heading will appear.
- Keep driving in a circle until a compass heading appears.

3. Setting the compass zone

1. Find your current location and variance zone number on the zone map.

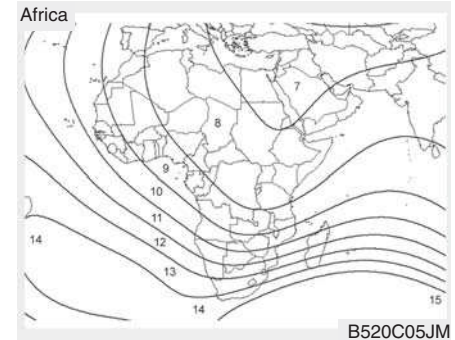
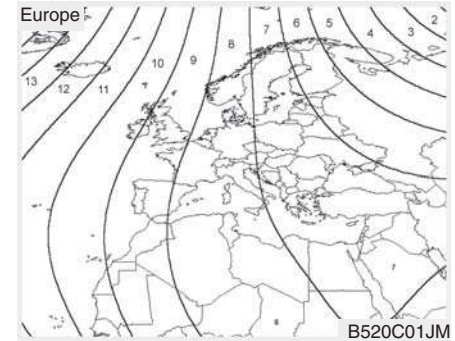

FarmaSOS.com

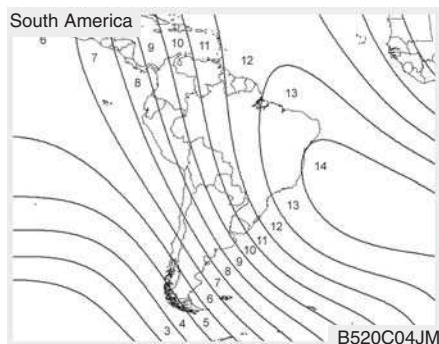
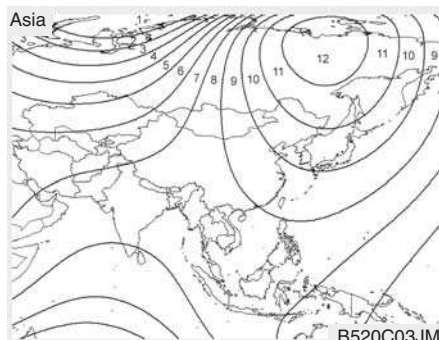

2. Press and hold the button for more than 3 but less than 6 seconds. The current zone number will appear in the display.

3. Press the button until the new zone number appears in the display. After you stop pressing the button in, the display will show a compass direction within a few seconds.

CAUTION

1. Do not install the ski rack, antenna, etc. which are attached to the vehicle by means of a magnet. They affect the operation of the compass.
2. If the compass deviates from the correct indication soon after repeated adjustment, we recommend that you have the compass checked at an authorized HYUNDAI dealer.
3. The compass may not indicate the correct compass point in tunnels or while driving up or down a steep hill.
(The compass returns to the correct compass point when the vehicle moves to an area where the geomagnetism is stabilized.)

(Continued)

(Continued)

4. When cleaning the mirror, use a paper towel or similar material dampened with glass cleaner. Do not spray glass cleaner directly on the mirror as that may cause the liquid cleaner to enter the mirror housing.

Outside rearview mirror

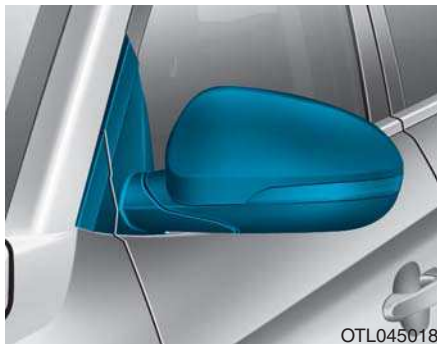

Be sure to adjust mirror angles before driving.

Your vehicle is equipped with both left-hand and right-hand outside rearview mirrors.

The mirror can be adjusted remotely with the remote switch.

The mirror heads can be folded to prevent damage during an automatic car wash or when passing through a narrow street.

WARNING

- The right outside rearview mirror is convex. In some countries, the left outside rearview mirror is also convex. Objects seen in the mirror are closer than they appear.
- Use your interior rearview mirror or turn your head and look to determine the actual distance of following vehicles when changing lanes.

WARNING

Do not adjust or fold the outside rearview mirrors while driving. This may cause loss of vehicle control resulting in an accident.

CAUTION

- Do not scrape ice off the mirror face; this may damage the surface of the glass.
- If the mirror is jammed with ice, do not adjust the mirror by force. Use an approved spray de-icer (not radiator antifreeze) spray, or a sponge or soft cloth with very warm water, or move the vehicle to a warm place and allow the ice to melt.



Adjusting the rearview mirrors:

1. Press either the L (left side) or R (right side) button (1) to select the rearview mirror you would like to adjust.
2. Use the mirror adjustment control (2) to position the selected mirror up, down, left or right.
3. After adjustment, put the button into neutral (center) position to prevent inadvertent adjustment.

NOTICE

- The mirrors stop moving when they reach the maximum adjusting angles, but the motor continues to operate while the switch is pressed. Do not press the switch longer than necessary, the motor may be damaged.
- Do not attempt to adjust the outside rearview mirror by hand or the motor may be damaged.

تلفن شبانه روزی: ۰۲۱-۸۸۸۶۲۰۸۵

FarmaSOS.com

Folding the outside rearview mirror

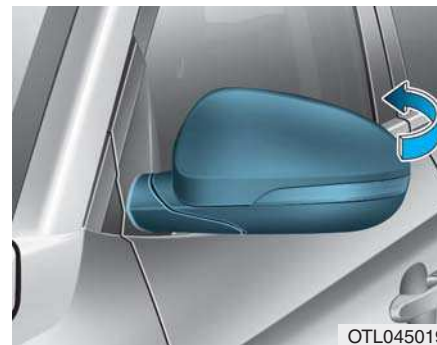

Manual type

To fold the outside rearview mirror, grasp the housing of the mirror and then fold it toward the rear of the vehicle.



Electric type (if equipped)

Left : The mirror will unfold.

Right : The mirror will fold.

Center (AUTO) :

The mirror will fold or unfold automatically as follows:

- Without smart key system
 - The mirror will fold or unfold when the door is locked or unlocked by the remote key. (if equipped)
- With smart key system
 - The mirror will fold or unfold when the door is locked or unlocked by the smart key.

- The mirror will fold or unfold when the door is locked or unlocked by the button on the outside door handle.

- The mirror will unfold when you approach the vehicle (all doors closed and locked) with a smart key in possession. (if equipped)

NOTICE

The electric type outside rearview mirror operates even though the ignition switch is in the LOCK/OFF position. However, to prevent unnecessary battery discharge, do not adjust the mirrors longer than necessary while the engine is not running.

NOTICE

Do not fold the electric type outside rearview mirror by hand. It could cause motor failure.

WINDOWS

Power windows

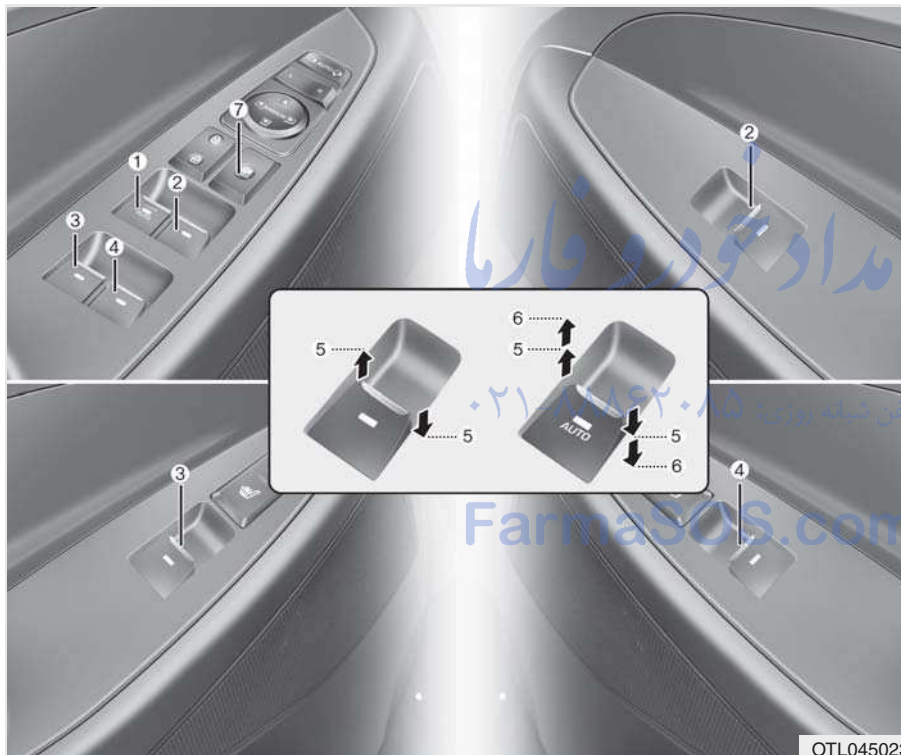

- (1) Driver's door power window switch
- (2) Front passenger's door power window switch
- (3) Rear door (left) power window switch
- (4) Rear door (right) power window switch
- (5) Window opening and closing
- (6) Automatic power window*
- (7) Power window lock switch

* : if equipped

OTL045023

The ignition switch must be in the ON position to be able to raise or lower the windows. Each door has a Power Window switch to control that door's window. The driver has a Power Window Lock switch which can block the operation of passenger windows. The power windows will operate for approximately 30 seconds after the ignition switch is placed in the ACC or OFF position. However, if the front doors are opened, the Power Windows cannot be operated even within the 30 second period.

⚠ WARNING

To avoid serious injury or death, do not extend your head, arms or body outside the windows while driving.

i Information

- **In cold and wet climates, power windows may not work properly due to freezing conditions.**
- **While driving with the rear windows down or with the sunroof (if equipped) opened (or partially opened), your vehicle may demonstrate a wind buffeting or pulsation noise. This noise is normal and can be reduced or eliminated by taking the following actions. If the noise occurs with one or both of the rear windows down, partially lower both front windows approximately 2.5 cm (1 inch). If you experience the noise with the sunroof open, slightly close the sunroof.**

FarmaSOS.com

Window opening and closing



To open:

Press the window switch down to the first detent position (5). Release the switch when you want the window to stop.

To close:

Pull the window switch up to the first detent position (5). Release the window switch when you want the window to stop.

Auto up/down window (if equipped)

Pressing or pulling up the power window switch momentarily to the second detent position (6) completely lowers or lifts the window even when the switch is released. To stop the window at the desired position while the window is in operation, pull up or press down and release the switch.

To reset the power windows

If the power windows do not operate normally, the automatic power window system must be reset as follows:

1. Place the ignition switch to the ON position.
2. Close the window and continue pulling up on the power window switch for at least one second.

If the power windows do not operate properly after resetting, it is recommended that the system be checked by an authorized HYUNDAI dealer.

تلفن شبانه روزی: ۰۲۱-۸۸۸۶۲۰۸۵

FarmaSOS.com

Automatic reversal (if equipped)

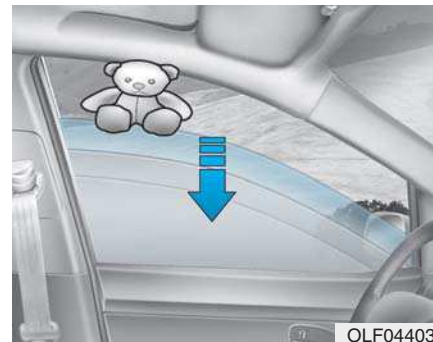

If a window senses any obstacle while it is closing automatically, it will stop and lower approximately 30 cm (12 inches) to allow the object to be cleared.

If the window detects the resistance while the power window switch is pulled up continuously, the window will stop upward movement then lower approximately 2.5 cm (1 inch).

If the power window switch is pulled up continuously again within 5 seconds after the window is lowered by the automatic window reversal feature, the automatic window reversal will not operate.

i Information

The automatic reverse feature is only active when the “Auto Up” feature is used by fully pulling up the switch to the second detent.

⚠ WARNING

Make sure body parts or other objects are safely out of the way before closing the windows to avoid injuries or vehicle damage.

Objects less than 4 mm (0.16 inch) in diameter caught between the window glass and the upper window channel may not be detected by the automatic reverse window and the window will not stop and reverse direction.

Power window lock switch



OTL045025

The driver can disable the power window switches on the rear passengers' doors by pressing the power window lock switch.

When the power window lock switch is pressed:

- The driver's master control can operate all the power windows.
- The front passenger's control can operate the front passenger's power window.
- The rear passenger's control cannot operate the rear passengers' power window.

⚠ WARNING

Do not allow children to play with the power windows. Keep the driver's door power window lock switch in the LOCK position. Serious injury or death can result from unintentional window operation by a child.

FarmaSOS.com

NOTICE

- To prevent possible damage to the power window system, do not open or close two windows or more at the same time. This will also ensure the longevity of the fuse.
- Never try to operate the main switch on the driver's door and the individual door window switch in opposite directions at the same time. If this is done, the window will stop and cannot be opened or closed.

⚠ WARNING

- NEVER leave the keys in your vehicle with unsupervised children, when the engine is running.
- NEVER leave any child unattended in the vehicle. Even very young children may inadvertently cause the vehicle to move, entangle themselves in the windows, or otherwise injure themselves or others.
- Always double check to make sure all arms, hands, head and other obstructions are safely out of the way before closing a window.

(Continued)

(Continued)

- Do not allow children to play with the power windows. Keep the driver's door power window lock switch in the LOCK position (pressed). Serious injury can result from unintentional window operation by the child.
- Do not extend your head, arms or body outside the windows while driving.

PANORAMA SUNROOF (IF EQUIPPED)



If your vehicle is equipped with a sunroof, you can slide or tilt your sunroof with the sunroof control lever located on the overhead console.

The ignition switch must be in the ON position before you can open or close the sunroof.

The sunroof can be operated for approximately 30 seconds after the ignition key is removed or turned to the ACC or LOCK(or OFF) position. However, if the front door is opened, the sunroof cannot be operated even within 30 seconds.

i Information

- In cold and wet climates, the sunroof may not work properly due to freezing conditions.
- After washing the car or after there is rain, be sure to wipe off any water that is on the sunroof before operating it.

NOTICE

- Do not continue to move the sunroof control lever after the sunroof is fully opened, closed, or tilted. Damage to the motor or system components could occur.
 - Make sure the sunroof is closed fully when leaving your vehicle.
- If the sunroof is open, rain or snow may leak through the sunroof and wet the interior as well as cause theft.

⚠ WARNING

- Make sure heads, other body parts or objects are out of the way before using the sunroof.
- Do not leave the engine running and the key in your vehicle with unsupervised children. Unattended children could operate the sunroof, which could result in serious injury.

⚠ WARNING

Never adjust the sunroof or sunshade while driving. This could result in loss of control and an accident that may cause death, serious injury, or property damage.

Sunshade



- To open the sunshade, pull the sunroof control lever backward (1) to the first detent position.
- To close the sunshade when the sunroof glass is closed, push the sunroof control lever forward (2).

To stop the sliding at any point, pull or push the sunroof control lever momentarily.

Sliding the sunroof

When the sunshade is closed



If you pull the sunroof control lever backward to the second detent, the sunshade will slide all the way open then the sunroof glass will slide all the way open. To stop the sunroof movement at any point, pull or push the sunroof control lever momentarily.

When the sunshade is opened

If you pull the sunroof control lever backward, the sunroof glass will slide all the way open. To stop the sunroof movement at any point, pull or push the sunroof control lever momentarily.

i Information

Only the front glass of the panorama sunroof opens and closes.

Tilting the sunroof

When the sunshade is closed



If you push the sunroof control lever upward, the sunshade will slide open then the sunroof glass will tilt.

To stop the sunroof movement at any point, pull or push the sunroof control lever momentarily.

When the sunshade is opened

If you push the sunroof control lever upward, the sunroof glass will tilt.

To stop the sunroof movement at any point, pull or push the sunroof control lever momentarily.

امداد خودرو فارما

تلفن شبانه روزی: ۰۲۱-۸۸۸۶۲۰۸۵

FarmaSOS.com

Closing the sunroof



To close the sunroof glass only

Push the sunroof control lever forward to the first detent position or pull the lever downward.

To close the sunroof glass with the sunshade

Push the sunroof control lever forward to the second detent position. The sunroof glass will close then the sunshade will close automatically.

To stop the sunroof movement at any point, pull or push the sunroof control lever momentarily.

Automatic reversal

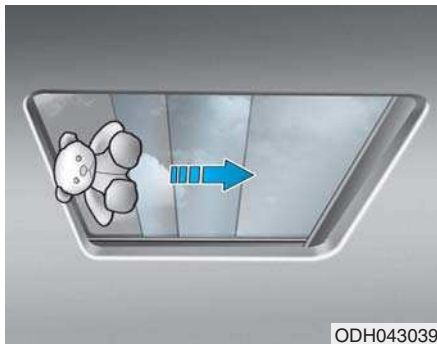

If an object or part of the body is detected while the sunroof glass or sunshade is closing automatically, it will reverse the direction, and then stop.

The auto reverse function does not work if a tiny obstacle is between the sliding glass or sunshade and the sunroof sash. You should always check that all passengers and objects are away from the sunroof before closing it.

⚠ WARNING

- Make sure heads, other body parts or other objects are safely out of the way before closing the sunroof to avoid injuries or vehicle damage.
- To avoid serious injury or death, do not extend your head, arms or body outside the sunroof while driving.
- A panorama sunroof is made of glass, therefore it may break in an accident. If you do not have your seat belt on, you may stick out of the broken glass and get injured or killed. For all passengers safety, have an appropriate protection on (ex. seat belt, child restraint system, etc.).

NOTICE

- Periodically remove any dirt that may accumulate on the sunroof guide rail or between the sunroof and roof panel, which can make a noise.
- Do not try to open the sunroof when the temperature is below freezing or when the sunroof is covered with snow or ice, the motor could be damaged. In cold and wet climates, the sunroof may not work properly.

i Information

After the vehicle is washed or in a rainstorm, be sure to wipe off any water that is on the sunroof before operating it.

Resetting the sunroof



Sunroof needs to be reset if (in the followings)

- Battery is discharged or disconnected or the related fuse has been replaced or disconnected
- The one-touch sliding function of the sunroof does not normally operate

1. Turn the engine on and close the sunroof glass and sunshade completely.
2. Release the control lever.

3. Push the sunroof control lever forward in the direction of close (about 10 seconds) until the sunroof slightly moves. Then, release the lever.
4. Push the sunroof control lever forward in the direction of close until the sunroof operates as follows:

Sunshade Open → Glass Tilt Open
→ Glass Slide Open → Glass Slide
Close → Sunshade Close

Then, release the control lever.

When this is complete, the sunroof system is reset.

For more details, contact an authorized HYUNDAI dealer.

i Information

If you do not reset the sunroof, it may not work properly.

Sunroof open warning (if equipped)

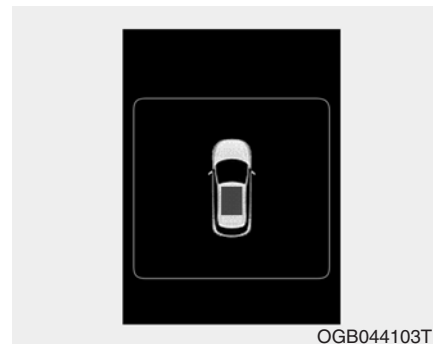

- If the driver turns off the engine when the sunroof is not fully closed, the warning chime will sound for approximately 3 seconds and sunroof open warning will appear on the LCD display.
- If the driver turns off the engine and opens the door when the sunroof is not fully closed, the open sunroof warning will appear on the LCD display until the door is closed or the sunroof is fully closed.

Close the sunroof securely when leaving your vehicle.

EXTERIOR FEATURES

Hood

Opening the hood



1. Park the vehicle and set the parking brake.
2. Pull the release lever to unlatch the hood. The hood should pop open slightly.



3. Go to the front of the vehicle, raise the hood slightly, push up the secondary latch (1) inside of the hood center and lift the hood (2).
تلفن شبانه: ۰۲۱-۸۸۸۸۸۸۸۸

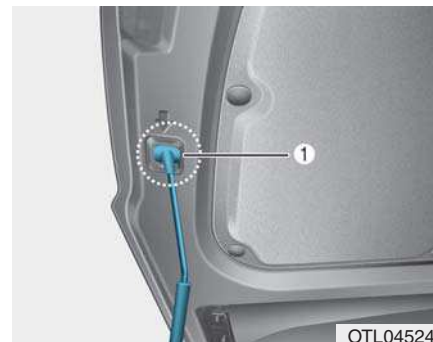

4. Pull out the stay rod.
5. Hold the hood opened with the stay rod (1).

⚠ WARNING

- Grasp the stay rod in the area wrapped in rubber. The rubber will help prevent you from being burned by hot metal when the engine is hot.
- The stay rod must be inserted completely into the hole provided whenever you inspect the engine compartment. This will prevent the hood from falling and possibly injuring you.

FarmaSOS.com

Closing the hood

1. Before closing the hood, check the following:
 - All filler caps in engine compartment must be correctly installed.
 - Gloves, rags or any other combustible material must be removed from the engine compartment.
2. Return the stay rod to its clip to prevent it from rattling.
3. Lower the hood halfway (lifted approximately 30cm from the closed position) and push down to securely lock in place. Then double check to be sure the hood is secure.

⚠ WARNING

Always double check to be sure that the hood is firmly latched before driving away. Check there is no hood open warning light or message displayed on the instrument cluster. If the hood is not latched while the vehicle is moving, the chime will sound to warn the driver the hood is not fully latched. Driving with the hood opened may cause a total loss of visibility, which might result in an accident.

⚠ WARNING

- Before closing the hood, ensure that all obstructions are removed from the hood opening. Closing the hood with an obstruction present in the hood opening may result in property damage or severe personal injury.
- Do not leave gloves, rags or any other combustible material in the engine compartment. Doing so may cause a heat-induced fire.
- Do not move the vehicle with the hood raised. The view will be blocked and the hood could fall or be damaged.

FarmaSOS.com

Fuel filler door

Opening the fuel filler door

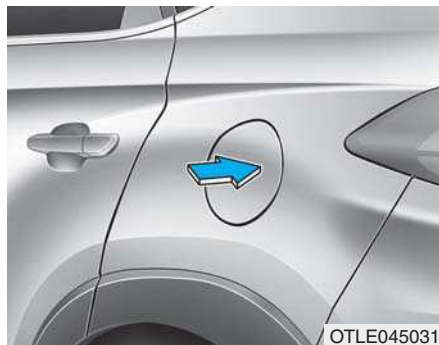

1. To open the fuel filler door, press the center edge of the fuel filler door.

i Information

The fuel filler door will open and close only when all doors are unlocked.

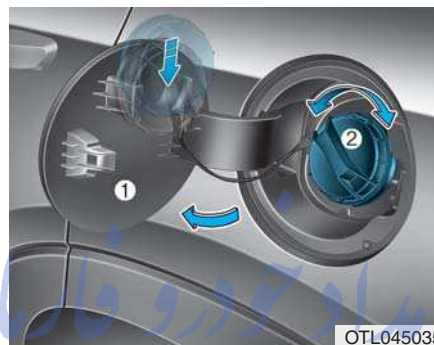

2. Pull the fuel filler door (1) out to fully open.
3. To remove the fuel tank cap (2), turn it counterclockwise. You may hear a hissing noise as the pressure inside the tank equalizes.
4. Place the cap on the fuel filler door.

i Information

If the fuel filler door does not open because ice has formed around it, tap lightly or push on the door to break the ice and release the door. Do not pry on the door. If necessary, spray around the door with an approved de-icer fluid (do not use radiator anti-freeze) or move the vehicle to a warm place and allow the ice to melt.

Closing the fuel filler door

1. To install the fuel tank cap, turn it clockwise until it “clicks” one time.
2. To close the fuel filler door, press the edge of the fuel filler door. Make sure it is securely closed.

⚠ WARNING

Gasoline is highly flammable and explosive. Failure to follow these guidelines may result in SERIOUS INJURY or DEATH:

- Read and follow all warnings posted at the gas station.
- Before refueling, note the location of the Emergency Gasoline Shut-Off, if available, at the gas station.
- Before touching the fuel nozzle, you should eliminate the potential build-up of static electricity by touching a metal part of the vehicle, a safe distance away from the fuel filler neck, nozzle, or other gas source, with your bare hand.

(Continued)

(Continued)

- Do not use cellular phones while refueling. Electric current and/or electronic interference from cellular phones can potentially ignite fuel vapors and cause a fire.
- Do not get back into a vehicle once you have begun refueling. You can generate a build-up of static electricity by touching, rubbing or sliding against any item or fabric capable of producing static electricity. Static electricity discharge can ignite fuel vapors causing a fire. If you must re-enter the vehicle, you should once again eliminate potentially dangerous static electricity discharge by touching a metal part of the vehicle, away from the fuel filler neck, nozzle or other gasoline source, with your bare hand.

(Continued)

(Continued)

- When refueling, always move the shift lever to the P (Park) position (for automatic transaxle/dual clutch transmission) or first gear or R (Reverse, for manual transaxle), set the parking brake, and place the ignition switch to the LOCK/OFF position. Sparks produced by electrical components related to the engine can ignite fuel vapors causing a fire.
- When using an approved portable fuel container, be sure to place the container on the ground prior to refueling. Static electricity discharge from the container can ignite fuel vapors causing a fire. Once refueling has begun, contact between your bare hand and the vehicle should be maintained until the filling is complete.

(Continued)

(Continued)

- Use only approved portable plastic fuel containers designed to carry and store gasoline.
- Do not use matches or a lighter and do not smoke or leave a lit cigarette in your vehicle while at a gas station, especially during refueling.
- Do not over-fill or top-off your vehicle tank, which can cause gasoline spillage.
- If a fire breaks out during refueling, leave the vicinity of the vehicle, and immediately contact the manager of the gas station and then contact the local fire department. Follow any safety instructions they provide.

(Continued)

(Continued)

- If pressurized fuel sprays out, it can cover your clothes or skin and thus subject you to the risk of fire and burns. Always remove the fuel cap carefully and slowly. If the cap is venting fuel or if you hear a hissing sound, wait until the condition stops before completely removing the cap.
- Always check that the fuel cap is installed securely to prevent fuel spillage in the event of an accident.

FarmaSOS.com

i Information

Make sure to refuel your vehicle according to the "Fuel Requirements" suggested in the Introduction chapter.

NOTICE

- Do not spill fuel on the exterior surfaces of the vehicle. Any type of fuel spilled on painted surfaces may damage the paint.
- If the fuel filler cap requires replacement, use only a genuine HYUNDAI cap or the equivalent specified for your vehicle. An incorrect fuel filler cap can result in a serious malfunction of the fuel system or emission control system.

TAILGATE

Non-power tailgate (if equipped)

Opening the tailgate

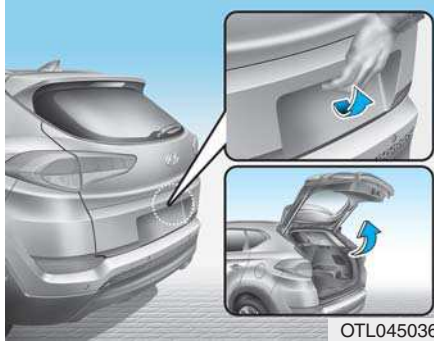

- The tailgate is locked or unlocked when all doors are locked or unlocked with the key, transmitter, smart key or central door lock/unlock switch.
- Only the tailgate is unlocked if the tailgate unlock button on the remote key or smart key is pressed for approximately 1 second.
- If unlocked, the tailgate can be opened by pressing the handle and pulling it up.

- Once the tailgate is opened and then closed, the tailgate locks automatically. (All doors must be locked.)

i Information

In cold and wet climates, door lock and door mechanisms may not work properly due to freezing conditions.

امداد خودرو فارما

تلفن شبانه روزی: ۰۲۱-۸۸۸۶۲۰۸۵

FarmaSOS.com

⚠ WARNING

The tailgate swings upward. Make sure no objects or people are near the rear of the vehicle when opening the tailgate.

⚠ CAUTION

Make certain that you close the tailgate before driving your vehicle. Possible damage may occur to the tailgate lift cylinders and attaching hardware if the tailgate is not closed prior to driving.

Closing the tailgate



Lower and push down the tailgate firmly. Make sure that the tailgate is securely latched.

⚠ WARNING

Make sure your hands, feet and other parts of your body are safely out of the way before closing the tailgate.

In case of any malfunction we recommend to visit authorized HYUNDAI dealer for inspection.

⚠ CAUTION

Make sure nothing is near the tailgate latch and striker while closing the tailgate. It may damage the tailgate's latch.

⚠ WARNING

If you drive with the tailgate opened, you will draw dangerous exhaust fumes into your vehicle which can cause serious injury or death to vehicle occupants.

If you must drive with the tailgate opened, keep the air vents and all windows open so that additional outside air comes into the vehicle.

Do not lean on tailgate lift cylinders, nor tie any rope or twine to them to avoid bending and consequent malfunction, vehicle damage or injury in case bent lift cylinder breaks the rear glass.

⚠ WARNING

Occupants should never ride in the rear cargo area where no restraints are available. To avoid injury in the event of an accident or sudden stops, occupants should always be properly restrained.

Emergency tailgate safety release

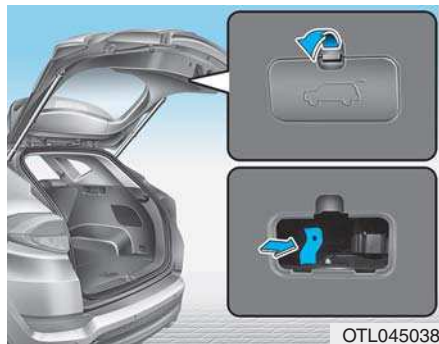

Your vehicle is equipped with the emergency tailgate safety release lever located on the bottom of the tailgate. When someone is inadvertently locked in the luggage compartment. The tailgate can be opened by doing as follows:

1. Remove the cover.
2. Push the release lever to the right.
3. Push up the tailgate.

⚠ WARNING

- For emergencies, be fully aware of the location of the emergency tailgate safety release lever in the vehicle and how to open the tailgate if you are accidentally locked in the luggage compartment.
- No one should be allowed to occupy the luggage compartment of the vehicle at any time. The luggage compartment is a very dangerous location in the event of a crash.
- Use the release lever for emergencies only. Use with extreme caution, especially while the vehicle is in motion.

Power tailgate (if equipped)

Power tailgate button



The power tailgate operates when:

- The power tailgate button is pressed with the engine off.
- The power tailgate button is pressed when the ignition switch is in the ON position with the shift lever in P (Park, for automatic transaxle/dual clutch transmission vehicle) or the shift lever in neutral (for manual transaxle vehicle).

To activate or de-activate the power tailgate, go to User Settings mode and select the Power Tailgate on the LCD display.

For more details, refer to “LCD Display” in this chapter.

⚠ WARNING

Never leave children or animals unattended in your vehicle.

Children or animals might operate the power tailgate that could result in injury to themselves or others, or damage the vehicle.

⚠ WARNING

Make sure there are no people or objects around the tailgate before operating the power tailgate. Wait until the tailgate is opened fully and stopped before loading or unloading cargo or passengers from the vehicle.

⚠ CAUTION

Do not close or open the power tailgate manually. This may cause damage to the power tailgate. If it is necessary to close or open the power tailgate manually when the battery is discharged or disconnected, do not apply excessive force.

Opening the tailgate



OTLE045030

The power tailgate will open automatically by doing one of the following:

- Press the tailgate unlock button on the remote key or smart key for approximately one second.

تلفن شبانه روزی: ۰۲۱-۸۸۸۶۲۰۸۵

FarmaSOS.com

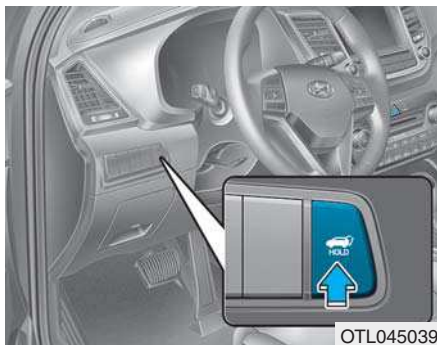

- Press the power tailgate button for approximately one second.
For emergency stop while operating, press the power tailgate button shortly.



- Press the tailgate handle switch carrying the smart key with you.

تلفن شبانه روزی: ۰۲۱-۸۸۶۲۰۸۵

FarmaSOS.com

Closing the tailgate

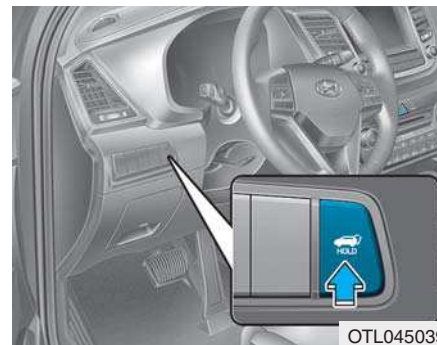

- Press the power tailgate button for approximately one second when the tailgate is opened.
The tailgate will close and lock automatically.
For emergency stop while operating, press the power tailgate button shortly.



- Press the power tailgate inner switch for approximately one second when the tailgate is opened. The tailgate will close and lock automatically.

Power tailgate non-opening conditions

The tailgate does not open when the vehicle is in motion.

! WARNING

The chime will sound if you drive with the tailgate opened. Stop your vehicle immediately at a safe place and check if your tailgate is opened.

! CAUTION

Operating the power tailgate more than 5 times continuously could cause damages to the operating motor. In this case, the system enters into a thermal protection mode. In thermal protection mode, the power tailgate can not operate and the chime will sound for 3 times by any switch inputs. Leave your power tailgate system for rest about 1 minute and then operate.

تلفن شبانه روزی: ۰۲۱-۸۸۸۶۲۰۸۵

FarmaSOS.com

i Information

- The power tailgate can be operated when the engine is not running. However the power tailgate operation consumes large amounts of vehicle electric power. To prevent the battery from being discharged, do not operate it excessively. (e.g.: more than approximately 10 times repeatedly.)
- To prevent the battery from being discharged, do not leave the power tailgate in the open position for a long time.
- Do not modify or repair any part of the power tailgate by yourself. We recommend that you contact an authorized HYUNDAI dealer.
- When jacking up the vehicle to change a tire or repair the vehicle, do not operate the power tailgate. This could cause the power tailgate to operate improperly.
- In cold and wet climates, the power tailgate may not work properly due to freezing conditions.

Automatic reversal



During power opening and closing if the power tailgate is blocked by an object or part of the body, the power tailgate will detect the resistance.

- If the resistance is detected while opening the tailgate, it will stop and move in the opposite direction.
- If the resistance is detected while closing the tailgate, it will stop and move in the opposite direction.

However, if the resistance is weak such as from an object that is thin or soft, or the tailgate is near the latched position, the automatic stop and reversal may not detect the resistance.

If the automatic reversal feature operates continuously more than twice during opening or closing operation, the power tailgate may stop at that position. At this time, close the tailgate manually and operate the tailgate automatically again.

 **WARNING**

Never intentionally place any object or part of your body in the path of the power tailgate to make sure the automatic reversal operates.

 **CAUTION**

Do not put heavy stuffs on the power tailgate before you operate the power tailgate.

Additional weight on tailgate could cause damages to the system.

How to reset the power tailgate

If the battery has been discharged or disconnected, or if the related fuse has been replaced or disconnected, for the power tailgate to operate normally, reset the power tailgate as follow:

1. Automatic transaxle/Dual clutch transmission:
Put the shift lever in P (Park).
Manual transaxle:
Put the shift lever in neutral.
2. While Pressing the power tailgate inner switch, press the tailgate handle switch for more than 3 seconds. (the chime will sound) تلفن شبانه (۰۲۱) ۸۸۸۸۸۸۸۸
3. Close the tailgate manually.

If the power tailgate does not work properly after the above procedure, we recommend that the system be checked by an authorized HYUNDAI dealer.

 **Information**

If the power tailgate does not operate normally, check again if the gear position is in right position.

Power tailgate opening height user setting

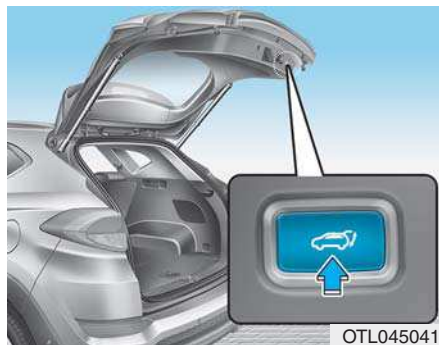

The driver may set the height of a fully opened tailgate by following the below instruction.

1. Position the tailgate manually to the height you prefer.
2. Press the power tailgate inner switch for more than 3 seconds.
3. Close the tailgate manually after hearing the buzzer sound.

The tailgate will open to the height the driver has set up.

⚠ WARNING

If you drive with the tailgate opened, you will draw dangerous exhaust fumes into your vehicle which can cause serious injury or death to vehicle occupants.

If you must drive with the tailgate opened, keep the air vents and all windows open so that additional outside air comes into the vehicle.

⚠ WARNING

Occupants should never ride in the rear cargo area where no restraints are available. To avoid injury in the event of an accident or sudden stops, occupants should always be properly restrained.

Emergency tailgate safety release

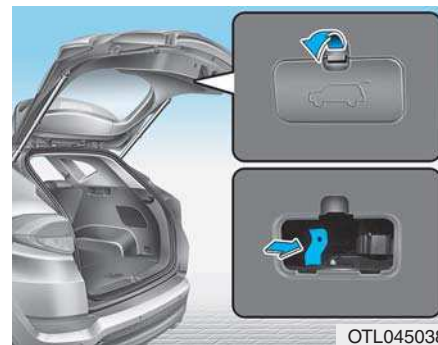

Your vehicle is equipped with the emergency tailgate safety release lever located on the bottom of the tailgate. When someone is inadvertently locked in the luggage compartment, the tailgate can be opened by doing as follows:

1. Remove the cover.
2. Push the release lever to the right.
3. Push up the tailgate.

⚠ WARNING

- For emergencies, be fully aware of the location of the emergency tailgate safety release lever in the vehicle and how to open the tailgate if you are accidentally locked in the luggage compartment.
- No one should be allowed to occupy the luggage compartment of the vehicle at any time. The luggage compartment is a very dangerous location in the event of a crash.
- Use the release lever for emergencies only. Use with extreme caution, especially while the vehicle is in motion.

Smart tailgate (if equipped)



On the vehicle equipped with a smart key, the tailgate can be opened with no-touch activation using the Smart tailgate system.

FarmaSOS.com

How to use the Smart Tailgate

The tailgate can be opened with no-touch activation satisfying all the conditions below.

- After 15 seconds when all doors are closed and locked
- Positioned in the detecting area for more than 3 seconds.

i Information

- The Smart Tailgate does not operate when:
 - The smart key is detected within 15 seconds after the doors are closed and locked, and is continuously detected.
 - The smart key is detected within 15 seconds after the doors are closed and locked, and 1.5 m (60 in.) from the front door handles. (for vehicles equipped with Welcome Light)
 - A door is not locked or closed.
 - The smart key is in the vehicle.

1. Setting

To activate the Smart Tailgate, go to User Settings Mode and select Smart Tailgate on the LCD display.

* For more details, refer to "LCD Display" in this chapter.



2. Detect and Alert

If you are positioned in the detecting area (50 ~ 100 cm (20 ~ 40 in.) behind the vehicle) carrying a smart key, the hazard warning lights will blink and chime will sound for about 3 seconds to alert you the smart key has been detected and the tailgate will open.

i Information

Do not approach the detecting area if you do not want the tailgate to open. If you have unintentionally entered the detecting area and the hazard warning lights and chime starts to operate, leave the detecting area with the smart key. The tailgate will stay closed.



3. Automatic opening

The hazard warning lights will blink and chime will sound 2 times and then the tailgate will slowly open.

WARNING

- Make certain that you close the tailgate before driving your vehicle.
- Make sure there are no people or objects around the tailgate before opening or closing the tailgate.
- Make sure objects in the rear cargo area do not come out when opening the tailgate on the slope way. It may cause serious injury.
- Make sure to deactivate the Smart tailgate function when washing your vehicle. Otherwise, the tailgate may open inadvertently.
- The key should be kept out of reach of children. Children may inadvertently open the Smart Tailgate while playing around the rear area of the vehicle.

How to deactivate the Smart Tailgate function using the smart key

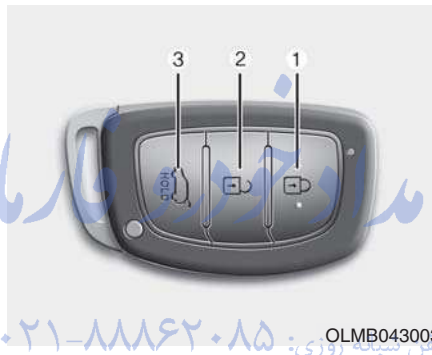

1. Door lock
2. Door unlock
3. Tailgate open

If you press any button of the smart key during the Detect and Alert stage, the Smart Tailgate function will be deactivated.

Make sure to be aware of how to deactivate the Smart Tailgate function for emergency situations.

Information

- If you press the door unlock button (2), the Smart Tailgate function will be deactivated temporarily. But, if you do not open any door for 30 seconds, the Smart Tailgate function will be activated again.
- If you press the tailgate open button (3) for more than 1 second, the tailgate opens.
- If you press the door lock button (1) or tailgate open button (3) when the Smart Tailgate function is not in the Detect and Alert stage, the Smart Tailgate function will not be deactivated.
- In case you have deactivated the Smart Tailgate function by pressing the smart key button and opened a door, the Smart Tailgate function can be activated again by closing and locking all doors.

Detecting area



- The Smart Tailgate operates with a welcome alert if the smart key is detected within 50 ~ 100 cm (20 ~ 40 in.) from the tailgate.
- The alert stops at once if the smart key is positioned outside the detecting area during the Detect and Alert stage.

i Information

- The Smart Tailgate function will not work if any of the following occurs:
 - The smart key is close to a radio transmitter such as a radio station or an airport which can interfere with normal operation of the transmitter.
 - The smart key is near a mobile two way radio system or a cellular phone.
 - Another vehicle's smart key is being operated close to your vehicle.
- The detecting range may decrease or increase when :
 - One side of the tire is raised to replace a tire or to inspect the vehicle.
 - The vehicle is slantingly parked on a slope or unpaved road, etc.

INSTRUMENT CLUSTER

■ Type A

- Gasoline engine

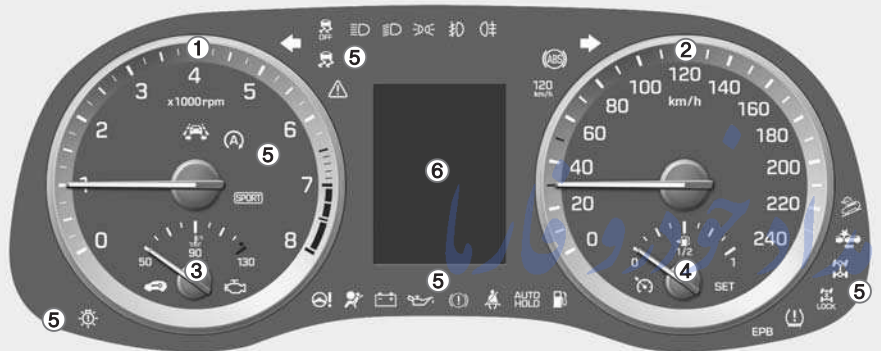

1. Tachometer
2. Speedometer
3. Engine coolant temperature gauge
4. Fuel gauge
5. Warning and indicator lights
6. LCD display (including Trip computer)

■ Type B

- Gasoline engine



The actual cluster in the vehicle may differ from the illustration.
For more details, refer to the "Gauges" in this chapter.

OTLE047340/OTLE047101

■ Type A
• Diesel engine

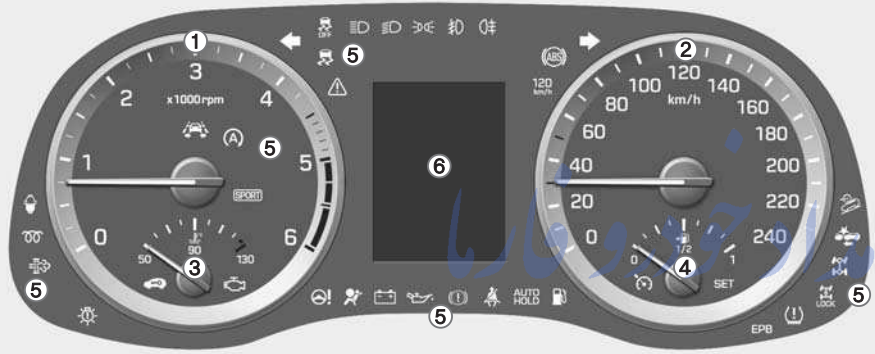

1. Tachometer
2. Speedometer
3. Engine coolant temperature gauge
4. Fuel gauge
5. Warning and indicator lights
6. LCD display (including Trip computer)

■ Type B
• Diesel engine

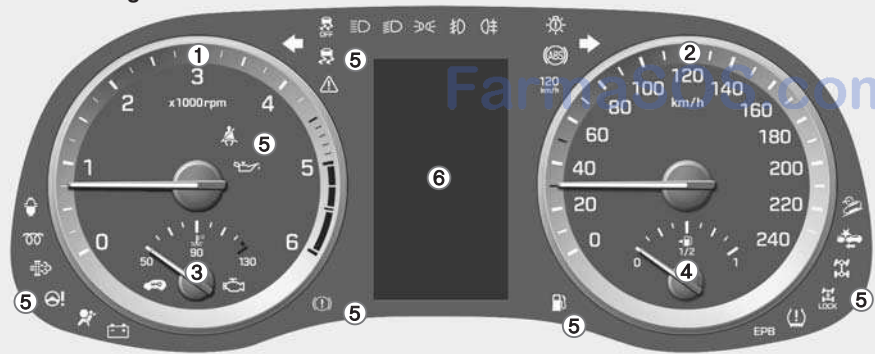

The actual cluster in the vehicle may differ from the illustration.
For more details, refer to the "Gauges" in this chapter.

OTLE047341/OTLE047101L

Instrument cluster control

Instrument panel illumination

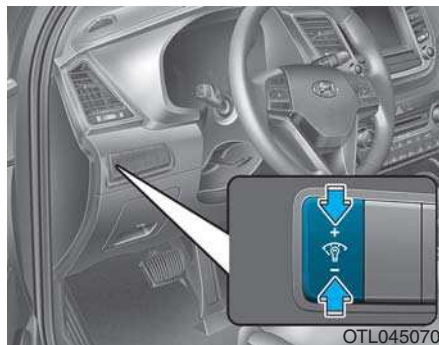

When the vehicle's parking lights or headlights are on, press the illumination control button to adjust the brightness of the instrument panel illumination.

When pressing the illumination control button, the interior switch illumination intensity is also adjusted.

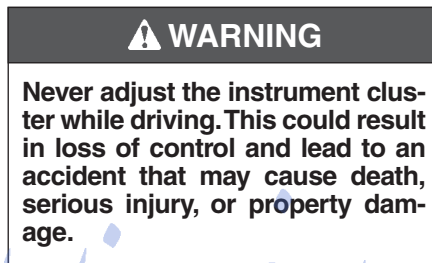

امداد خودرو فارما

تلفن شبانه روزی: ۰۲۱-۸۸۸۶۲۰۸۵

FarmaSOS.com

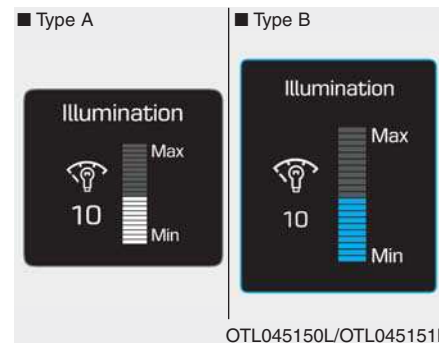

- The brightness of the instrument panel illumination is displayed.
- If the brightness reaches to the maximum or minimum level, an alarm will sound.

Gauges

Speedometer

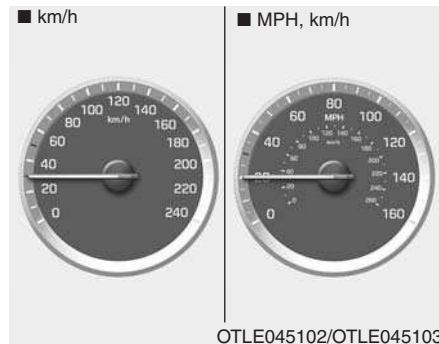

The speedometer indicates the speed of the vehicle and is calibrated in kilometers per hour (km/h) and/or miles per hour (MPH).

Tachometer

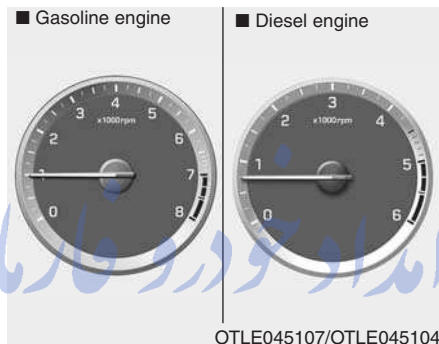

The tachometer indicates the approximate number of engine revolutions per minute (rpm).

Use the tachometer to select the correct shift points and to prevent lugging and/or over-revving the engine.

NOTICE

Do not operate the engine within the tachometer's RED ZONE. This may cause severe engine damage.

Engine Coolant Temperature gauge



This gauge indicates the temperature of the engine coolant when the ignition switch is in the ON position.

NOTICE

If the gauge pointer moves beyond the normal range area toward the "130 or H" position, it indicates overheating that may damage the engine.

Do not continue driving with an overheated engine. If your vehicle overheats, refer to "If the Engine Overheats" in chapter 6.

⚠ WARNING

Never remove the radiator cap when the engine is hot. The engine coolant is under pressure and could cause severe burns. Wait until the engine is cool before adding coolant to the reservoir.

Fuel Gauge

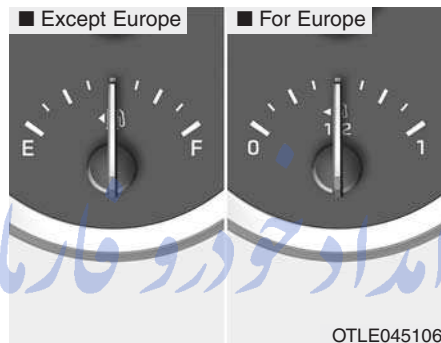

This gauge indicates the approximate amount of fuel remaining in the fuel tank.

i Information

- The fuel tank capacity is given in chapter 8.
- The fuel gauge is supplemented by a low fuel warning light, which will illuminate when the fuel tank is nearly empty.
- On inclines or curves, the fuel gauge pointer may fluctuate or the low fuel warning light may come on earlier than usual due to the movement of fuel in the tank.

⚠ WARNING

Running out of fuel can expose vehicle occupants to danger. You must stop and obtain additional fuel as soon as possible after the warning light comes on or when the gauge indicator comes close to the "0 or E (Empty)" level.

NOTICE

Avoid driving with an extremely low fuel level. Running out of fuel could cause the engine to misfire, damaging the catalytic converter.

Outside Temperature Gauge



This gauge indicates the current outside air temperatures either in Celsius (°C) or Fahrenheit.

- Temperature range : -40°C ~ 60°C (-104°F ~ 140°F)

The outside temperature on the display may not immediately change like a general thermometer not to distract the driver.

The temperature unit (from °C to °F or from °F to °C) can be changed by:

- User Settings mode in the Cluster : You can change the temperature unit in the “Other Features - Temperature unit” .

- Automatic climate control system : While pressing the OFF button, press the AUTO button for 3 seconds or more.

The temperature unit of the instrument cluster and climate control system will change at once.

تلفن شبانه روزی: ۰۲۱-۸۸۶۲۰۸۵

FarmaSOS.com

Icy Road Warning Light (if equipped)

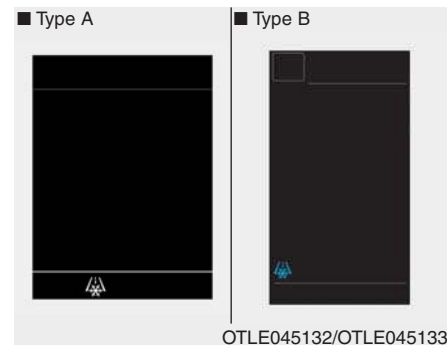

This warning light is to warn the driver the road may be icy.

When the temperature on the outside temperature gauge is approximately below 4°C (40°F), the Icy Road Warning Light and Outside Temperature Gauge blinks 10 times, and then illuminates. Also, the warning chime sounds 3 times.

i Information

If the icy road warning light appears while driving, you should drive more attentively and safely refraining from over-speeding, rapid acceleration, sudden braking or sharp turning, etc.

Transaxle Shift Indicator

Automatic Transaxle Shift Indicator (if equipped)



This indicator displays which automatic transaxle shift lever is selected.

- Park : P
- Reverse : R
- Neutral : N
- Drive : D
- Sports Mode : 1, 2, 3, 4, 5, 6

Dual Clutch Transmission Shift Indicator (if equipped)

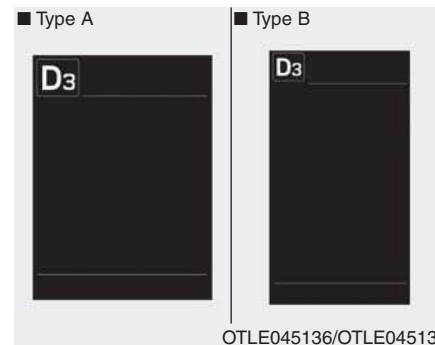

This indicator displays which shift lever is selected.

- Park : P
- Reverse : R
- Neutral : N
- Drive : D
- Sports Mode : D1, D2, D3, D4, D5, D6, D7

Automatic Transaxle Shift Indicator / Dual Clutch Transmission Shift Indicator (for Europe, if equipped)

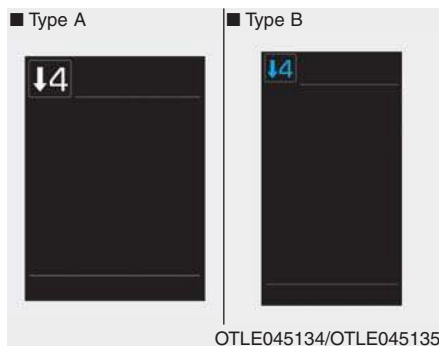

In the Sports Mode, this indicator informs which gear is desired while driving to save fuel.

- Automatic transaxle shift indicator
 - Shifting up : ▲2, ▲3, ▲4, ▲5, ▲6
 - Shifting down : ▼1, ▼2, ▼3, ▼4, ▼5
- Dual clutch transmission shift indicator
 - Shifting up : ▲2, ▲3, ▲4, ▲5, ▲6, ▲7
 - Shifting down : ▼1, ▼2, ▼3, ▼4, ▼5, ▼6

For example

- ▲3 : Indicates that shifting up to the 3rd gear is desired (currently the shift lever is in the 2nd or 1st gear).
- ▼3 : Indicates that shifting down to the 3rd gear is desired (currently the shift lever is in the 4th, 5th, or 6th gear).

When the system is not working properly, the indicator is not displayed.

تلفن شبانه روزی: ۰۲۱-۸۸۶۲۰۸۵

FarmaSOS.com

Manual Transaxle Shift Indicator (if equipped)

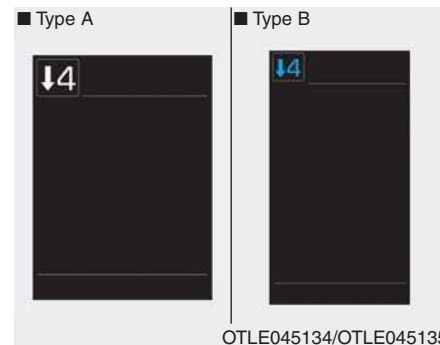

This indicator informs which gear is desired while driving to save fuel.

- Shifting up : ▲2, ▲3, ▲4, ▲5, ▲6
- Shifting down : ▼1, ▼2, ▼3, ▼4, ▼5

For example

- ▲3 : Indicates that shifting up to the 3rd gear is desired (currently the shift lever is in the 2nd or 1st gear).
- ▼3 : Indicates that shifting down to the 3rd gear is desired (currently the shift lever is in the 4th, 5th, or 6th gear).

When the system is not working properly, the indicator is not displayed.

3-67

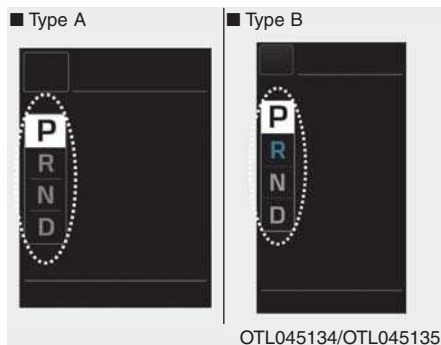

Shift Indicator Pop-up (if equipped)

The pop-up that indicates the current gear position is displayed in the cluster for about 2 seconds when shifting into other positions (P/R/N/D).

Odometer

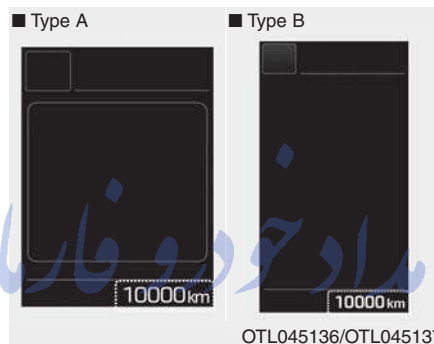

The odometer indicates the total distance that the vehicle has been driven and should be used to determine when periodic maintenance should be performed.

FarmaSOS.com

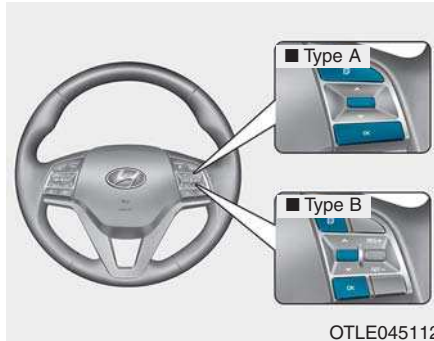

LCD DISPLAY

LCD display control











OTLE045112

The LCD display modes can be changed by using the control buttons.

- (1)  : MODE button for changing modes
- (2)  ,  : MOVE switch for changing items
- (3) OK : SELECT/RESET button for setting or resetting the selected item

LCD modes

Modes	Symbol	Explanation
Trip Computer		This mode displays driving information like the tripmeter, fuel economy, etc. For more details, refer to "Trip Computer" in this chapter.
Turn By Turn (TBT) (if equipped)		This mode displays the state of the navigation.
LKAS (if equipped)		This mode displays the state of the Lane Keeping Assist System(LKAS). For more details, refer to Lane Keeping Assist System (LKAS) in chapter 5.
A/V (If equipped)		This mode displays the state of the A/V system.
Information	 or  or 	This mode displays the service interval (mileage or days) and warning messages related to the Blind Spot Detection system, etc.
User Settings		In this mode, you can change settings of the doors, lamps, etc.

Edit settings after engaging parking brake / Edit settings after shifting to P

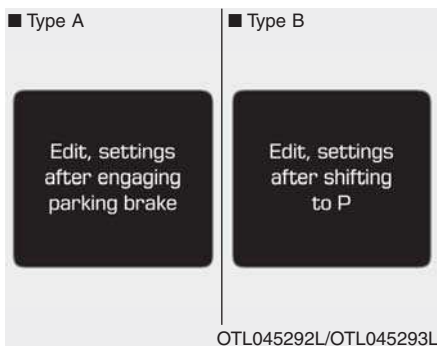

This warning message illuminates if you try to select an item from the User Settings mode while driving.

- Automatic transaxle / dual clutch transmission

For your safety, change the User Settings after parking the vehicle, applying the parking brake and moving the shift lever to P (Park).

- Manual transaxle

For your safety, change the User Settings after engaging the parking brake.

Quick guide (Help, if equipped)

This mode provides quick guides for the systems in the User Settings mode.

Select an item, press and hold the OK button.

For more details about each system, refer to this Owner's Manual.

تلفن شبانه روزی: ۰۲۱-۸۸۸۶۲۰۸۵

FarmaSOS.com

Trip computer mode

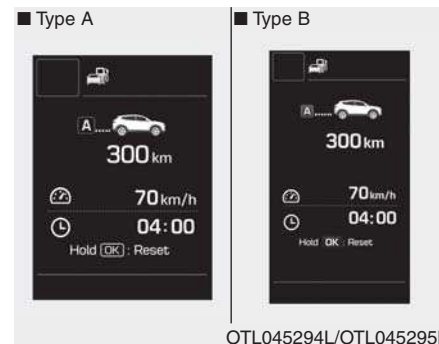

This mode displays driving information like the tripmeter, fuel economy, etc.

For more details, refer to “Trip Computer” in this chapter.

Turn By Turn (TBT) mode (if equipped)

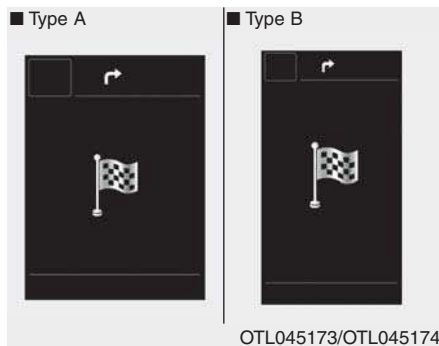

This mode displays the state of the navigation.

LKAS Mode (if equipped)

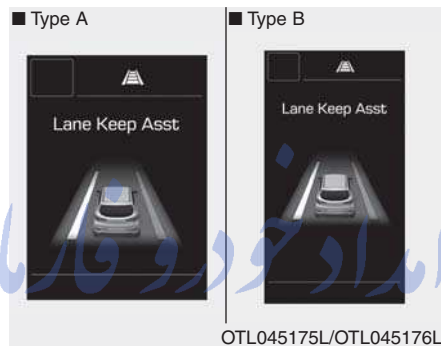

This mode displays the state of the Lane Keeping Assist System (LKAS).

For more details, refer to “Lane Keeping Assist System(LKAS)” in chapter 5.

A/V mode (if equipped)

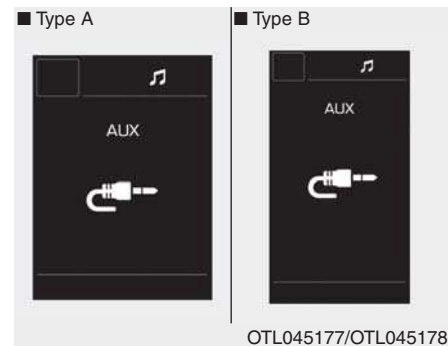

This mode displays the state of the A/V system.

Information mode

This mode displays the service interval (mileage and days).

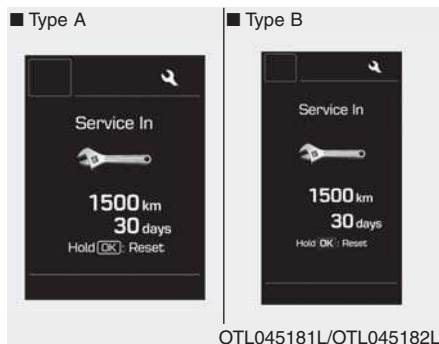

Service interval

Service in

It calculates and displays the maintenance schedule (mileage or days), as set in the system.

When the set mileages or days passed, "Service in" message is displayed for several seconds each time ignition switch is turned ON.

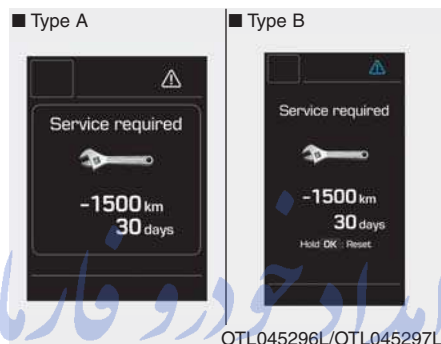

Service required

When you fail to have your vehicle serviced according to the already inputted service interval, "Service required" message is displayed for several seconds each time you turn ON the ignition switch.

To reset the service interval in mileages or days that you initially set:

- Activate the reset mode by pressing the OK button for more than 5 second, then press the OK button again for more than 1 second (for Europe).
- Press the OK button for more than 1 second (except Europe).

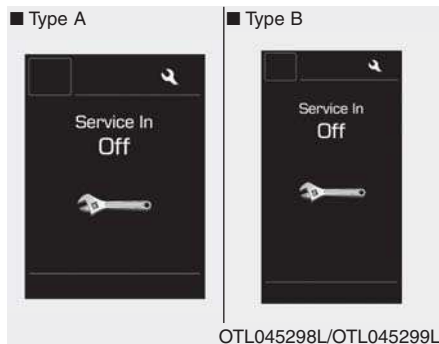

Service in OFF

When the service interval is not set, "Service in OFF" message is displayed on the LCD display.

i Information

If any of the following conditions occurs, the mileage and days may be incorrect.

- The battery cable is disconnected.
- The fuse switch is turned off.
- The battery is discharged.

Warning message

If one of followings occurs, warning messages will be displayed in the information mode for several seconds.

- Low washer fluid (if equipped)
- Blind Spot Detection (BSD) malfunction (if equipped)
- Lane Keeping Assist System (LKAS) malfunction (if equipped)
- Tire Pressure Monitoring System (TPMS, if equipped)
- Service reminder and etc.

تلفن شبانه روزی: ۰۲۱-۸۸۶۲۰۸۵

FarmaSOS.com

User settings mode

In this mode, you can change setting of the instrument cluster, doors, lamps, and so on.

Driving Assist (if equipped)

Items	Explanation
Lane Keeping Assist System (if equipped)	<ul style="list-style-type: none">• Lane Departure Warning : To activate the lane departure warning function.• Standard LKA : To activate the standard LKA mode of LKAS function.• Active LKA : To activate the active LKA mode of LKAS function For more details, refer to "LKAS (Lane Keeping Assist System)" in chapter 5.
Autonomous Emergency Braking (if equipped)	To activate or deactivate the AEB system. For more details, refer to "Autonomous Emergency Braking (AEB)" in chapter 5.
Forward Collision Warning (if equipped)	Choose the sensitivity of the forward collision warning. - Late / Normal / Early For more details, refer to "Autonomous Emergency Braking (AEB)" in chapter 5.
Rear Cross Traffic Alert (if equipped)	If this item is checked, the rear cross traffic alert function will be activated. For more details, refer to "Blind Spot Detection System" in chapter 5.
Speed Limit Information Function (if equipped)	If this item is checked, the speed limit information function will be activated. For more details, refer to "Speed Limit Information Function" in chapter 5.

Door

Items	Explanation
Automatic Lock	<ul style="list-style-type: none"> • Disable : The automatic door lock operation will be deactivated. • Enable on Speed: All doors will be automatically locked when the vehicle speed exceeds 15km/h (9.3mph). • Enable on Shift: All doors will be automatically locked if the automatic transaxle shift lever is shifted from the P (Park) position to the R (Reverse), N (Neutral), or D (Drive) position.
Automatic Unlock	<ul style="list-style-type: none"> • Disable : The automatic door unlock operation will be canceled. • On key out : All doors will be automatically unlocked when the ignition key is removed from the ignition switch or the Engine Start/Stop button is set to the OFF position. • Driver Door Unlock: All doors will be automatically unlocked if the driver's door is unlocked. • On Shift to P: All doors will be automatically unlocked if the automatic transaxle shift lever is shifted to the P (Park) position.
Horn Feedback	<p>If this item is checked, the horn feedback operation will be activated.</p> <p>After locking the door by pressing the lock button on the remote key, if you press the lock button again within 4 seconds, the warning sound will operate once to indicate that all doors are locked.</p>
Power tailgate (if equipped)	<p>If this item is checked, the power tailgate function will be activated.</p> <p>For more details, refer to "Tailgate" in this chapter.</p>
Smart Tailgate (if equipped)	<p>If this item is checked, the smart tailgate function will be activated.</p> <p>If the power tailgate function is not activated, you cannot activate this function.</p> <p>For more details, refer to "Tailgate" in this chapter.</p>

Light

Items	Explanation
One Touch Turn Signal	<ul style="list-style-type: none">• Off: The one touch turn signal function will be deactivated.• 3, 5, 7 Flashes : The lane change signals will blink 3, 5, or 7 times when the turn signal lever is moved slightly. For more details, refer to "Light" in this chapter.
Head Lamp Delay	<ul style="list-style-type: none">• If this item is checked, the head lamp delay function will be activated.
Welcome light (if equipped)	<ul style="list-style-type: none">• If this item is checked, the welcome light function will be activated.

Sound

Items	Explanation
Park Assist System Vol. (if equipped)	<ul style="list-style-type: none">• Adjust the Park Assist System volume. (Level 1~3) For more details, refer to "Parking Assist System" in this chapter.
Blind Spot Detection Sound (if equipped)	<ul style="list-style-type: none">• If this item is checked, the blind spot detection sound will be activated. For more details, refer to "Blind Spot Detection System" in chapter 5.
Welcome sound (if equipped)	<ul style="list-style-type: none">• If this item is checked, the welcome sound function will be activated.

Service interval

Items	Explanation
Service Interval (Except Europe)	<ul style="list-style-type: none"> • Off : The service interval function will be deactivated. • On : You can set the service interval (mileage and days). <p>For more details, refer to "Information mode" in this chapter.</p>

Other features

Items	Explanation
Fuel Economy Auto Reset	<ul style="list-style-type: none"> • Off : The average fuel economy will not reset automatically whenever refueling. • After Ignition : The average fuel economy will reset automatically whenever it has passed 4 hours after turning off the engine. • After Refueling : The average fuel economy will reset automatically when refueling. <p>For more details, refer to "Trip Computer" in this chapter.</p>
Steering position	If this item is checked, the steering position will be displayed.
Auto Rear Wiper	<ul style="list-style-type: none"> • Off : The Auto Rear Wiper function will be deactivated. • ON : If you move the shift lever from D to R when the front wiper operates, the rear wiper will operate automatically. Then, if you move the shift lever from R to D, the rear wiper will stop.
Fuel Economy Unit	Choose the fuel economy unit. (Km/L, L/100)
Temperature Unit	Choose the temperature unit. (°C, °F)
Tire Pressure Unit (if equipped)	Choose the tire pressure unit. (psi, kPa, bar)
Gear Position Pop-up	If this item is checked, the gear position will be displayed when you move the shift lever.
Language	Choose the language.

Warning messages

**Shift to "P" position
(for smart key system and auto-
matic transaxle/dual clutch
transmission)**

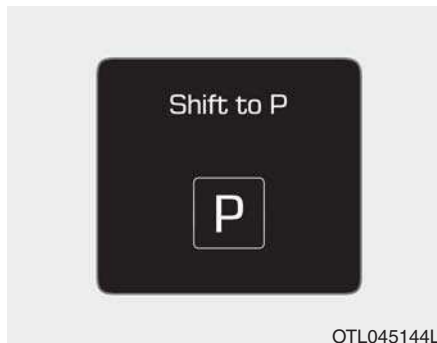

OTL045144L

This warning message illuminates if you try to turn off the engine without the shift lever in P (Park) position.

At this time, the Engine Start/Stop button turns to the ACC position (If you press the Engine Start/Stop button once more, it will turn to the ON position).

**Low Key Battery
(for smart key system)**

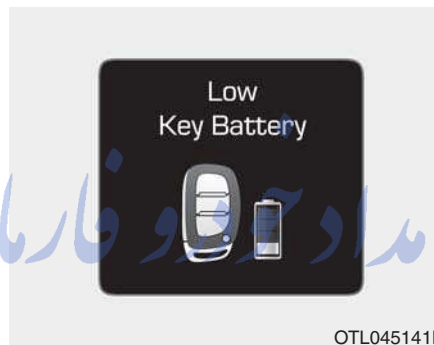

OTL045141L

This warning message illuminates if the battery of the smart key is discharged while changing the Engine Start/Stop button while changing to the OFF position.

**Press start button while turning
wheel (for smart key system)**



OTL045300L

This warning message illuminates if the steering wheel does not unlock normally when the Engine Start/Stop button is pressed.

You should press you should press the Engine Start/Stop button while turning the steering wheel right and left.

**Steering wheel unlocked
(for smart key system)**



This warning message illuminates if the steering wheel does not lock while the Engine Start/Stop button changes to the OFF position.

**Check steering wheel lock
system (for smart key system)**

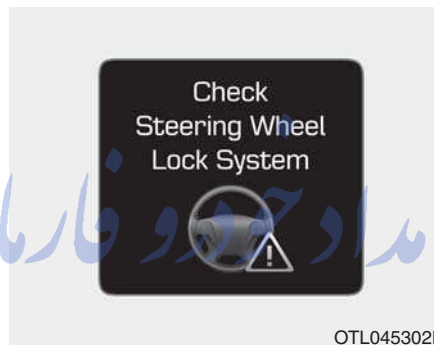

This warning message illuminates if the steering wheel does not lock normally while the Engine Start/Stop button changes to the OFF position.

**Press brake pedal to start engine
(for smart key system and auto-
matic transaxle)**

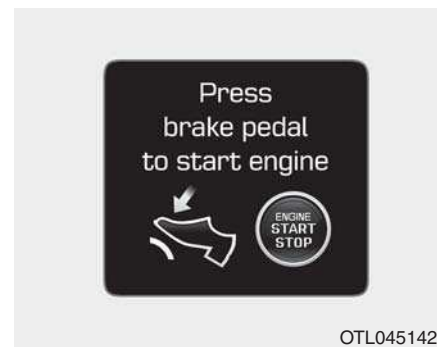

This warning message illuminates if the Engine Start/Stop button changes to the ACC position twice by pressing the button repeatedly without depressing the brake pedal.

You can start the vehicle by depressing the brake pedal.

Press clutch pedal to start engine (for smart key system and manual transaxle)



This warning message illuminates if the Engine Start/Stop button is in the ACC position twice by pressing the button repeatedly without depressing the clutch pedal.

Depress the clutch pedal to start the engine.

Key not in vehicle (for smart key system)



This warning message illuminates if the smart key is not in the vehicle when you press the Engine Start/Stop button.

It means that you always have the smart key with you.

Key not detected (for smart key system)

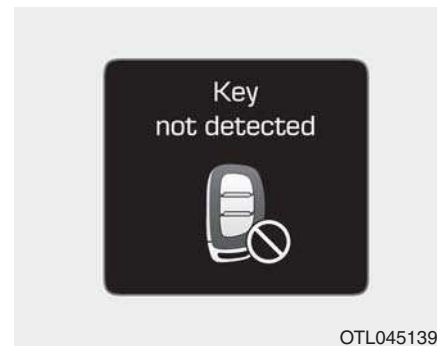

This warning message illuminates if the smart key is not detected when you press the Engine Start/Stop button.

**Press start button again
(for smart key system)**



This warning message illuminates if you can not operate the Engine Start/Stop button when there is a problem with the Engine Start/Stop button system.

You could start the engine by pressing the Engine Start/Stop button once more.

If the warning illuminates each time you press the Engine Start/Stop button, we recommend that you have the vehicle inspected by an authorized HYUNDAI dealer.

**Press "START" button with key
(for smart key system)**



This warning message illuminates if you press the Engine Start/Stop button while the warning message "Key not detected" is displayed.

At this time, the immobilizer indicator light blinks.

**Check "BRAKE SWITCH" fuse
(for smart key system and automatic transaxle/dual clutch transmission)**



This warning message illuminates if the brake switch fuse is disconnected. You need to replace the fuse with a new one. If that is not possible, you can start the engine by pressing the Engine Start/Stop button for 10 seconds in the ACC position.

**Shift to "P" or "N" to start engine
(for smart key system and auto-
matic transaxle/dual clutch trans-
mission)**



This warning message illuminates if you try to start the engine with the shift lever not in the P (Park) or N (Neutral) position.

i Information

You can start the engine with the shift lever in the N (Neutral) position. But, for your safety, we recommend that you start the engine with the shift lever in the P (Park) position.

Door, Hood, Tailgate Open

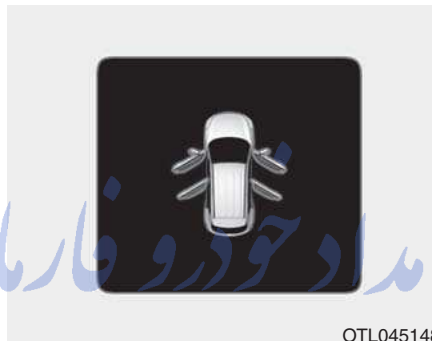

This warning illuminates, when any door, hood, or trunk is open.

! CAUTION

Before driving the vehicle, you should confirm that the door/hood/tailgate is fully closed. Also, check there is no door/hood/tailgate open warning light or message displayed on the instrument cluster.

Sunroof Open (if equipped)

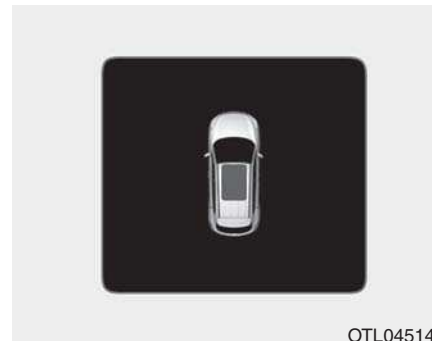

This warning illuminates if you turn off the engine when the sunroof is open.

Heated Steering Wheel On (if equipped)



This warning message illuminates if you turn on the heated steering wheel.

For more details, refer to “Heated Steering Wheel” in this chapter.

Heated Steering Wheel Off (if equipped)

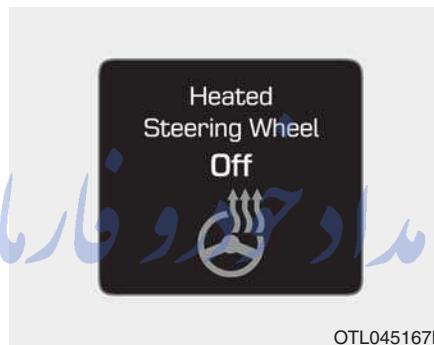

This warning message illuminates if you turn off the heated steering wheel.

For more details, refer to “Heated Steering Wheel” in this chapter.

Low Tire Pressure (if equipped)



This warning message illuminates if the tire pressure is low with the ignitions switch in ON position.

For more details, refer to “Tire Pressure Monitoring System (TPMS)” in chapter 6.

Turn on "FUSE SWITCH"

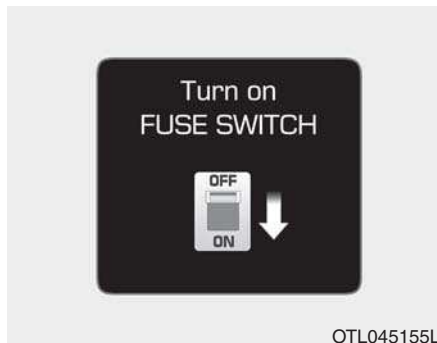

This warning message illuminates if the fuse switch located on the fuse box under the steering wheel is OFF. You should turn the fuse switch on.

For more details, refer to "Fuses" in chapter 7.

Align steering wheel (if equipped)



This warning message illuminates if you start the engine when the steering wheel is turned to more than 90 degrees to the left or right.

You should align the steering wheel and narrow the steering wheel angle to be less than 30 degrees.

Steering wheel aligning is completed (if equipped)

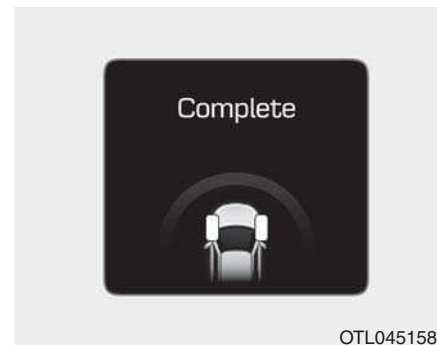

If the steering wheel aligning is completed after "Align steering wheel" warning message is displayed, this message is displayed for 2 seconds.

Low Washer Fluid (if equipped)



This warning message illuminates in the service reminder mode if the washer fluid level in the reservoir is nearly empty.

Refill the washer fluid.

Low Fuel

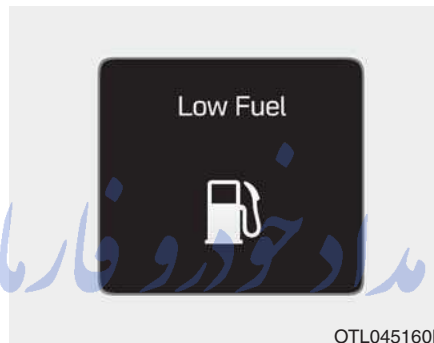

This warning message illuminates if the fuel tank is nearly empty.

- When the low fuel level warning light is illuminates.
- When the trip computer displays “--- km(or mile)” as distance to empty.

Add fuel as soon as possible.

Engine has overheated

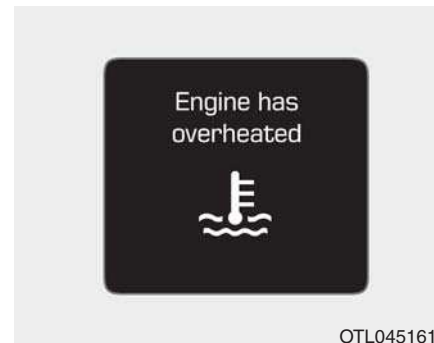

This warning message illuminates when the engine coolant temperature is above 120°C (248°F). This means that the engine is overheated and may be damaged.

If your vehicle is overheated, refer to “Overheating” in chapter 6.

Check headlight (if equipped)

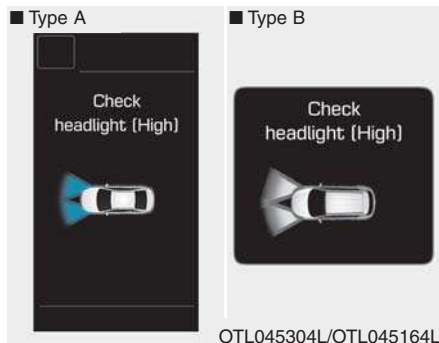

This warning message illuminates if there is a malfunction (burned-out bulb except LED lamp or circuit malfunction) with the headlamp. In this case, have your vehicle inspected by an authorized HYUNDAI dealer.

i Information

Make sure to replace the burned out bulb with a new one of the same wattage rating.

If not, this warning message will not be displayed.

Check AEB system (if equipped)

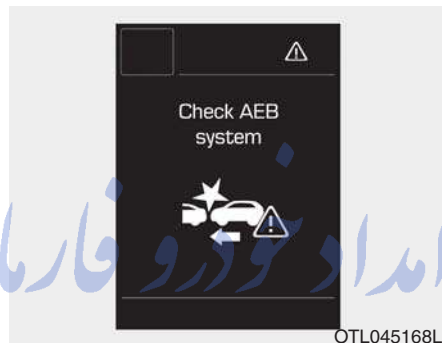

This warning message illuminates if there is a malfunction with the Autonomous Emergency Braking (AEB) system. We recommend that the vehicle be inspected by an authorized HYUNDAI dealer.

For more details, refer to "Autonomous Emergency Braking (AEB) system" in chapter 5.

Diesel Particulate Filter (DPF) warning (for Diesel engine)

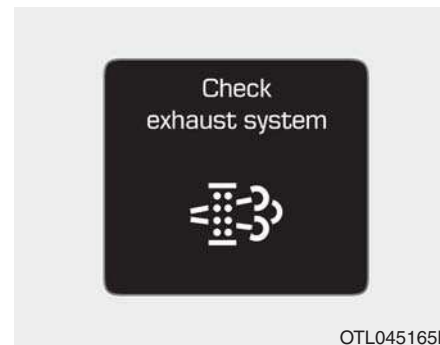

This warning message illuminates if the DPF system has a malfunction. At this time, DPF warning light also blinks.

In this case, we recommend that you have the DPF system checked by an authorized HYUNDAI dealer.

For more details, refer to "Warning Lights" in this chapter.

TRIP COMPUTER

The trip computer is a microcomputer-controlled driver information system that displays information related to driving.

i Information

Some driving information stored in the trip computer (for example Average Vehicle Speed) resets if the battery is disconnected.

Trip modes

To change the trip mode, rotate the “▲, ▼” switch on the steering wheel.

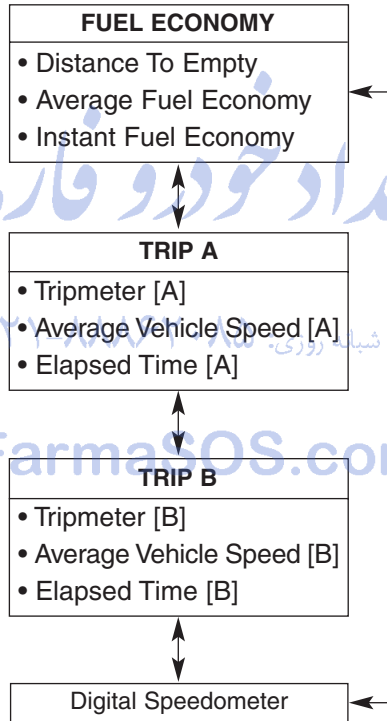

Trip A/B

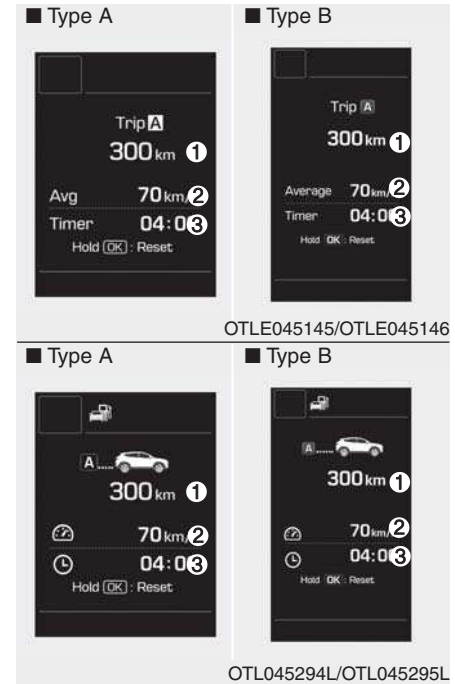

Convenient features of your vehicle

Tripmeter (1)

- The tripmeter is the total driving distance since the last tripmeter reset.
 - Distance range: 0.0 ~ 9999.9 km or mi.
- To reset the tripmeter, press the [OK] button on the steering wheel for more than 1 second when the tripmeter is displayed.

Average Vehicle Speed (2)

- The average vehicle speed is calculated by the total driving distance and driving time since the last average vehicle speed reset.
 - Speed range: 0~240 km/h or 0~160 MPH
- To reset the average vehicle speed, press the [OK] button on the steering wheel for more than 1 second when the average vehicle speed is displayed.

i Information

- The average vehicle speed is not displayed if the driving distance is less than 300 meters (0.19 miles) or the driving time is less than 10 seconds since the ignition switch or the Engine Start/Stop button is turned to ON.
- Even if the vehicle is not in motion, the average vehicle speed keeps calculating while the engine is running.

Elapsed Time (3)

- The elapsed time is the total driving time since the last elapsed time reset.
 - Time range (hh:mm): 00:00 ~ 99:59
- To reset the elapsed time, press the [OK] button on the steering wheel for more than 1 second when the elapsed time is displayed.

i Information

Even if the vehicle is not in motion, the elapsed time keeps calculating while the engine is running.

Fuel economy

■ Type A



■ Type B

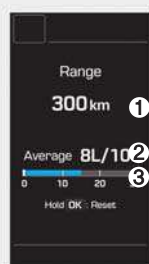

OTLE045262/OTLE045263

■ Type A



■ Type B



OTL045171L/OTL045172L

Distance To Empty (1)

- The distance to empty is the estimated distance the vehicle can be driven with the remaining fuel.
 - Distance range: 1 ~ 9999 km or 1 ~ 9999 mi.
- If the estimated distance is below 1 km (1 mi.), the trip computer will display “---” as distance to empty.

i Information

- If the vehicle is not on level ground or the battery power has been interrupted, the distance to empty function may not operate correctly.
- The distance to empty may differ from the actual driving distance as it is an estimate of the available driving distance.
- The trip computer may not register additional fuel if less than 6 liters (1.6 gallons) of fuel are added to the vehicle.
- The fuel economy and distance to empty may vary significantly based on driving conditions, driving habits, and condition of the vehicle.

Average Fuel Economy (2)

- The average fuel economy is calculated by the total driving distance and fuel consumption since the last average fuel economy reset.
 - Fuel economy range: 0.0 ~ 99.9 L/100km, km/L or MPG
- The average fuel economy can be reset both manually and automatically.

Manual reset

To clear the average fuel economy manually, press the [OK] button on the steering wheel for more than 1 second when the average fuel economy is displayed.

Automatic reset

To automatically reset the average fuel economy after refueling, select the "Auto Reset" mode in User Settings menu on the LCD display (**Refer to "LCD Display" in this chapter**).

In "Auto Reset" mode, the average fuel economy will be reset to zero (---), when driving speed exceeds 1 km/h, after adding 6 liters (1.6 gallons) of fuels or more.

i Information

The average fuel economy may be inaccurate, when the vehicle drives shorter than 300 meters (0.19 miles) after turning ON the Engine Start/Stop button.

Instant Fuel Economy (3)

- This mode displays the instant fuel economy during the last few seconds when the vehicle speed is more than 10 km/h (6.2 MPH).
 - Fuel economy range: 0 ~ 30 L/100km, km/L or 0 ~ 50 MPG

امداد خودرو فارما

تلفن شبانه روزی: ۰۲۱-۸۸۸۶۲۰۸۵

FarmaSOS.com

Auto stop time (if equipped)

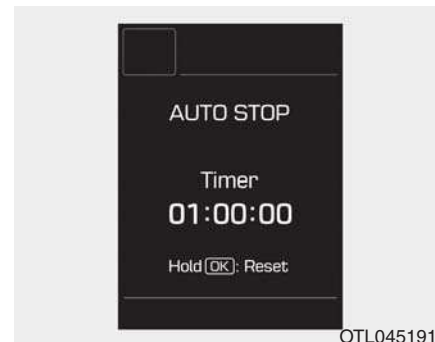

This mode displays the elapsed time of Auto stop by "Idle stop and go system".

For more details, refer to the "Idle stop and go system" in chapter 5.

Digital Speedometer

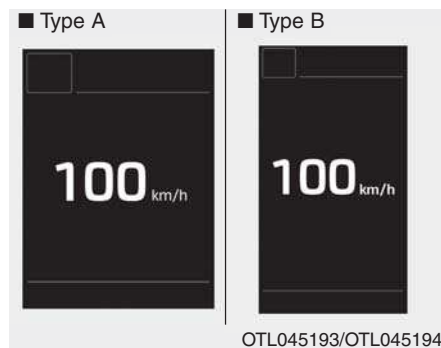

This message shows the speed of the vehicle (km/h, MPH).

One time driving information mode



The driving information mode displays tripmeter (1), average fuel economy (2), and distance to empty (3).

The information is displayed for a few seconds when the vehicle is turned OFF. The information is calculated after each trip.

When the estimated distance to empty is shorter than 1 km (1 mi.), the driving information mode displays “---” and “Low fuel” (4) message will appear.

i Information

If sunroof open warning is displayed in the cluster, this display may not be displayed in the cluster.

WARNING AND INDICATOR LIGHTS

Warning lights

i Information

Make sure that all warning lights are **OFF** after starting the engine. If any light is still **ON**, this indicates a situation that needs attention.

Air bag Warning Light



This warning light illuminates:

- Once you set the ignition switch or the Engine Start/Stop button to the ON position.
 - It illuminates for approximately 6 seconds and then goes off.
- When there is a malfunction with the SRS.

In this case, we recommend that you have the vehicle inspected by an authorized HYUNDAI dealer. تلفن

Seat Belt Warning Light



This warning light informs the driver that the seat belt is not fastened.

For more details, refer to the “Seat Belts” in chapter 2.

FarmaSOS.com

Parking Brake & Brake Fluid Warning Light



This warning light illuminates:

- Once you set the ignition switch or the Engine Start/Stop button to the ON position.
 - It illuminates for approximately 3 seconds
 - It remains on if the parking brake is applied.
- When the parking brake is applied.
- When the brake fluid level in the reservoir is low.
 - If the warning light illuminates with the parking brake released, it indicates the brake fluid level in reservoir is low.

If the brake fluid level in the reservoir is low:

1. Drive carefully to the nearest safe location and stop your vehicle.
2. With the engine stopped, check the brake fluid level immediately and add fluid as required (**For more details, refer to “Brake Fluid” in chapter 7**). Then check all brake components for fluid leaks. If any leak on brake system is still found, the warning light remains on, or the brakes do not operate properly, do not drive the vehicle.

In this case, we recommend that you have the vehicle towed to an authorized HYUNDAI dealer and inspected.

FarmaSOS.com

Dual-diagonal braking system

Your vehicle is equipped with dual-diagonal braking systems. This means you still have braking on two wheels even if one of the dual systems should fail.

With only one of the dual systems working, more than normal pedal travel and greater pedal pressure are required to stop the vehicle.

Also, the vehicle will not stop in as short a distance with only a portion of the brake system working.

If the brakes fail while you are driving, shift to a lower gear for additional engine braking and stop the vehicle as soon as it is safe to do so.

WARNING

Parking Brake & Brake Fluid Warning Light

Driving the vehicle with a warning light ON is dangerous. If the Parking Brake & Brake Fluid Warning Light illuminates with the parking brake released, it indicates that the brake fluid level is low.

In this case, we recommend that you have the vehicle inspected by an authorized HYUNDAI dealer.

Anti-lock Brake System (ABS) Warning Light



This warning light illuminates:

- Once you set the ignition switch or the Engine Start/Stop button to the ON position.
 - It illuminates for approximately 3 seconds and then goes off.
- When there is a malfunction with the ABS (The normal braking system will still be operational without the assistance of the anti-lock brake system).

In this case, we recommend that you have the vehicle inspected by an authorized HYUNDAI dealer.

Electronic Brake force Distribution (EBD) System Warning Light



These two warning lights illuminate at the same time while driving:

- When the ABS and regular brake system may not work normally.

In this case, we recommend that you have the vehicle inspected by an authorized HYUNDAI dealer.

WARNING

Electronic Brake force Distribution (EBD) System Warning Light

When both ABS and Parking Brake & Brake Fluid Warning Lights are on, the brake system will not work normally and you may experience an unexpected and dangerous situation during sudden braking.

In this case, avoid high speed driving and abrupt braking.

We recommend you have the vehicle inspected by an authorized HYUNDAI dealer as soon as possible.

Information - Electronic Brake force Distribution (EBD) System Warning Light

When the ABS Warning Light is on or both ABS and Parking Brake & Brake Fluid Warning Lights are on, the speedometer, odometer, or tripmeter may not work. Also, the EPS Warning Light may illuminate and the steering effort may increase or decrease.

In this case, we recommend you have the vehicle inspected by an authorized HYUNDAI dealer as soon as possible.

تلفن شبانه روزی: ۰۲۱-۸۸۶۲۰۸۵

FarmaSOS.com

Electronic Parking Brake (EPB) Warning Light (if equipped)

EPB

This warning light illuminates:

- Once you set the ignition switch or the Engine Start/Stop button to the ON position.
 - It illuminates for approximately 3 seconds and then goes off.
- When there is a malfunction with the EPB.

In this case, we recommend that you have the vehicle inspected by an authorized HYUNDAI dealer.

Information

The Electronic Parking Brake (EPB) Warning Light may illuminate when the Electronic Stability control (ESC) Indicator Light comes on to indicate that the ESC is not working properly (This does not indicate malfunction of the EPB).

Electric Power Steering (EPS) Warning Light



This warning light illuminates:

- Once you set the ignition switch or the Engine Start/Stop button to the ON position.
 - This indicator light comes on after the ignition key is turned to the ON position and then goes out after approximately 3 seconds.
- When there is a malfunction with the EPS.

In this case, we recommend that you have the vehicle inspected by an authorized HYUNDAI dealer.

Malfunction Indicator Lamp (MIL)



This warning light illuminates:

- Once you set the ignition switch or the Engine Start/Stop button to the ON position.
 - It remains on until the engine is started.
- When there is a malfunction with the emission control system.

In this case, we recommend that you have the vehicle inspected by an authorized HYUNDAI dealer. تلفن

NOTICE

Driving with the Malfunction Indicator Lamp (MIL) on may cause damage to the emission control systems which could affect drivability and/or fuel economy.

NOTICE - Gasoline Engine

If the Malfunction Indicator Lamp (MIL) illuminates, potential catalytic converter damage is possible which could result in loss of engine power.

In this case, we recommend that you have the vehicle inspected by an authorized HYUNDAI dealer as soon as possible.

NOTICE - Diesel Engine

If the Malfunction Indicator Lamp (MIL) blinks, some error related to the injection quantity adjustment occurs which could result in loss of engine power, combustion noise and poor emission.

In this case, we recommend that you have the engine control system inspected by an authorized HYUNDAI dealer.

Charging System Warning Light



This warning light illuminates:

- Once you set the ignition switch or the Engine Start/Stop button to the ON position.
 - It remains on until the engine is started.
- When there is a malfunction with either the alternator or electrical charging system.

If there is a malfunction with either the alternator or electrical charging system:

1. Drive carefully to the nearest safe location and stop your vehicle.
2. Turn the engine off and check the alternator drive belt for looseness or breakage.

If the belt is adjusted properly, there may be a problem in the electrical charging system.

In this case, we recommend that you have the vehicle inspected by an authorized HYUNDAI dealer as soon as possible.

Engine Oil Pressure Warning Light



This warning light illuminates:

- Once you set the ignition switch or the Engine Start/Stop button to the ON position.
 - It remains on until the engine is started.
- When the engine oil pressure is low.

If the engine oil pressure is low:

1. Drive carefully to the nearest safe location and stop your vehicle.
2. Turn the engine off and check the engine oil level (**For more details, refer to “Engine Oil” in chapter 7**). If the level is low, add oil as required.

If the warning light remains on after adding oil or if oil is not available, we recommend that you have the vehicle inspected by an authorized HYUNDAI dealer as soon as possible.

NOTICE

- If the engine does not stop immediately after the Engine Oil Pressure Warning Light is illuminated, severe damage could result.
- If the warning light stays on while the engine is running, it indicates that there may be serious engine damage or malfunction. In this case,
 1. Stop the vehicle as soon as it is safe to do so.
 2. Turn off the engine and check the oil level. If the oil level is low, fill the engine oil to the proper level.
 3. Start the engine again. If the warning light stays on after the engine is started, turn the engine off immediately. In this case, we recommend that you have the vehicle inspected by an authorized HYUNDAI dealer.

Engine Oil Level Warning Light



The engine oil level warning light illuminates when the engine oil level should be checked.

If the warning light comes on, check the engine oil level as soon as possible and add engine oil as required.

Slowly pour the recommended oil little by little into a funnel. (Oil refill capacity : approximately 0.6 ~ 1.0 l)

Use only the specified engine oil. (Refer to "Recommended lubricants and capacities" in chapter 8.)

Do not overfill the engine oil. Make sure the oil level is not above F (Full) mark on the dipstick.

i Information

- If you travel approximately 50 km ~100 km after the engine warms up, after adding the engine oil, the warning light will go off.

(Continued)

(Continued)

- Cycle the ignition from OFF to ON 3 times within 10 seconds, the warning light will go off immediately. However, when you turn off the warning light without adding the engine oil, the light will come on again after traveling approximately 50 ~ 100 km after the engine warms up.

NOTICE

If the light comes on continuously after adding the engine oil and travelling approximately 50~100 km after the engine warms up, we recommend that the system be checked by an authorized HYUNDAI dealer.

Even if this light doesn't come on after the engine has started, the engine oil should be checked and supplied periodically.

Low Fuel Level Warning Light



This warning light illuminates:

When the fuel tank is nearly empty. Add fuel as soon as possible.

NOTICE

Driving with the Low Fuel Level warning light on or with the fuel level below "0 or E" can cause the engine to misfire and damage the catalytic converter (if equipped).

Overspeed Warning Light (if equipped)

**120
km/h**

This warning light blinks:

- When you drive the vehicle more than 120 km/h.
 - This is to prevent you from driving your vehicle with overspeed.
 - The overspeed warning chime also sound for approximately 5 seconds.

Master Warning Light



This indicator light illuminates:

- When there is a malfunction in the below systems.
 - Low washer fluid (if equipped)
 - Blind Spot Detection (BSD) malfunction (if equipped)
 - Lane Keeping Assist System (LKAS) malfunction (if equipped)
 - Tire Pressure Monitoring System (TPMS, if equipped)
 - Service reminder and so on.

To identify the details of the warning, look at the LCD display.

FarmaSOS.com

Low Tire Pressure Warning Light (if equipped)



This warning light illuminates:

- Once you set the ignition switch or Engine Start/Stop button to the ON position.
 - It illuminates for approximately 3 seconds and then goes off.
- When one or more of your tires are significantly underinflated (The location of the underinflated tires are displayed on the LCD display).

For more details, refer to “Tire Pressure Monitoring System (TPMS)” in chapter 6.

This warning light remains on after blinking for approximately 60 seconds or repeats blinking and off at the intervals of approximately 3 seconds:

- When there is a malfunction with the TPMS.

In this case, we recommend that you have the vehicle inspected by an authorized HYUNDAI dealer as soon as possible.

For more details, refer to “Tire Pressure Monitoring System (TPMS)” in chapter 6.

⚠ WARNING

Safe Stopping

- The TPMS cannot alert you to severe and sudden tire damage caused by external factors.
- If you notice any vehicle instability, immediately take your foot off the accelerator pedal, apply the brakes gradually with light force, and slowly move to a safe position off the road.

Autonomous Emergency Braking (AEB) Warning light (if equipped)



This indicator light illuminates:

- When there is a malfunction with the AEB.

In this case, we recommend that you have the vehicle inspected by an authorized HYUNDAI dealer.

For more information, refer to “Autonomous Emergency Braking (AEB) in chapter 5.

FarmaSOS.com

Fuel Filter Warning Light (Diesel Engine)



This warning light illuminates:

- Once you set the ignition switch or Engine Start/Stop Button to the ON position.
 - It illuminates for approximately 3 seconds and then goes off.
- When water has accumulated inside the fuel filter.

In this case, remove the water from the fuel filter.

For more details, refer to “Fuel Filter” in chapter 7.

NOTICE

- When the Fuel Filter Warning Light illuminates, engine power (vehicle speed & idle speed) may decrease.
- **If you keep driving with the warning light on, engine parts (injector, common rail, high pressure fuel pump) may be damaged. If this occurs, we recommend that you have the vehicle inspected by an authorized HYUNDAI dealer as soon as possible.**

تلفن شبانه روزی: ۰۲۱-۸۸۸۶۲۰۸۵

FarmaSOS.com

4 Wheel Drive (4WD) Warning Light (if equipped)



This warning light illuminates:

- Once you set the ignition switch or Engine Start/Stop Button to the ON position.
 - It illuminates for approximately 3 seconds and then goes off.
- When there is a malfunction with the 4WD system.

In this case, we recommend that you have the vehicle inspected by an authorized HYUNDAI dealer.

Headlight Warning Light (if equipped)



This warning light illuminates:

- When there is a malfunction (burned-out bulb except LED light or circuit malfunction) with the exterior lights (headlight, brake light, fog light, etc.). In this case, we recommend that you have your vehicle inspected by an authorized HYUNDAI dealer.

i Information

Make sure to replace the burned out bulb with a new one of the same wattage rating.

If not, this warning message will not be displayed.

Exhaust System (DPF) Warning Light (Diesel Engine)



This warning light illuminates:

- When there is a malfunction with Diesel Particulate Filter (DPF) system.
- When this warning light illuminates, it may turn off after driving the vehicle:
 - at more than 60 km/h (37 mph), or
 - at more than 2nd gear with 1500 ~ 2000 engine rpm for a certain time (for about 25 minutes).

If this warning light blinks in spite of the procedure (at this time LCD warning message will be displayed), we recommend that you have the DPF system checked by an authorized HYUNDAI dealer.

NOTICE

If you continue to drive with the DPF warning light blinking for a long time, the DPF system can be damaged and fuel consumption can worsen.

Indicator lights

Electronic Stability Control (ESC) Indicator Light (if equipped)



This indicator light illuminates:

- Once you set the ignition switch or the Engine Start/Stop button to the ON position.
 - It illuminates for approximately 3 seconds and then goes off.
- When there is a malfunction with the ESC system.

In this case, we recommend that you have the vehicle inspected by an authorized HYUNDAI dealer.

This indicator light blinks:

- While the ESC is operating.

For more details, refer to “Electronic Stability Control (ESC)” in chapter 5.

Electronic Stability Control (ESC) OFF Indicator Light (if equipped)



This indicator light illuminates:

- Once you set the ignition switch or the Engine Start/Stop button to the ON position.
 - It illuminates for approximately 3 seconds and then goes off.
- When you deactivate the ESC system by pressing the ESC OFF button.

For more details, refer to “Electronic Stability Control (ESC)” in chapter 5.

AUTO STOP Indicator Light (if equipped)



This indicator light illuminates:

- When the engine enters the Idle Stop mode of the ISG (Idle Stop and Go) system.
- When the automatic starting occurs, the AUTO STOP indicator on the cluster will blink for 5 seconds.

For more details, refer to the “ISG (Idle Stop and Go) system” in chapter 5.

تلفن شبانه روزی: +۹۰-۲۱-۸۸۶۲۰۸۵

i Information

When the engine automatically starts by the ISG system, some warning lights (ABS, ESC, ESC OFF, EPS or Parking brake warning light) may turn on for a few seconds.

This happens because of low battery voltage. It does not mean the system has malfunctioned.

Immobilizer Indicator Light (without smart key) (if equipped)



This indicator light illuminates:

- When the vehicle detects the immobilizer in your key properly while the ignition switch is ON.
 - At this time, you can start the engine.
 - The indicator light goes off after starting the engine.

This indicator light blinks:

- When there is a malfunction with the immobilizer system.

In this case, we recommend that you have the vehicle inspected by an authorized HYUNDAI dealer.

Immobilizer Indicator Light (With Smart Key) (if equipped)



This indicator light illuminates for up to 30 seconds:

- When the vehicle detects the smart key in the vehicle properly while the Engine Start/Stop button is ACC or ON.
 - At this time, you can start the engine.
 - The indicator light goes off after starting the engine.

This indicator light blinks for a few seconds:

- When the smart key is not in the vehicle.
 - At this time, you cannot start the engine.

This indicator light illuminates for 2 seconds and goes off:

- When the vehicle cannot detect the smart key which is in the vehicle while the Engine Start/Stop button is ON.

In this case, we recommend that you have the vehicle inspected by an authorized HYUNDAI dealer.

This indicator light blinks:

- When the battery of the smart key is weak.
 - At this time, you can not start the engine. However, you can start the engine if you press the Engine Start/Stop button with the smart key. **(For more details, refer to “Starting the Engine” in chapter 5).**
- When there is a malfunction with the immobilizer system.

In this case, we recommend that you have the vehicle inspected by an authorized HYUNDAI dealer.

Turn Signal Indicator Light

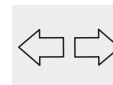

This indicator light blinks:

- When you turn the turn signal light on.

If any of the following occurs, there may be a malfunction with the turn signal system. In this case, we recommend that you have the vehicle inspected by an authorized HYUNDAI dealer.

- The indicator light does not blink but illuminates.
- The indicator light blinks more rapidly.
- The indicator light does not illuminate at all.

Low Beam Indicator Light (if equipped)



This indicator light illuminates:

- When the headlights are on.

High Beam Indicator Light



This indicator light illuminates:

- When the headlights are on and in the high beam position
- When the turn signal lever is pulled into the Flash-to-Pass position.

Light ON Indicator Light



This indicator light illuminates:

- When the tail lights or headlights are on.

Front Fog Indicator Light (if equipped)



This indicator light illuminates:

- When the front fog lights are on.

Rear Fog Indicator Light (if equipped)



This indicator light illuminates:

- When the rear fog lights are on.

Glow Indicator Light (Diesel Engine)



This indicator light illuminates:

- When the engine is being preheated with the ignition switch or Engine Start/Stop Button in the ON position.
 - The engine can be started after the glow indicator light goes off.
 - The illumination time varies with the engine coolant temperature, air temperature, and battery condition.

If the indicator light remains on or blinks after the engine has warmed up or while driving, there may be a malfunction with the engine preheating system.

In this case, we recommend that you have the vehicle inspected by an authorized HYUNDAI dealer.

i Information

If the engine does not start within 10 seconds after the preheating is completed, set the ignition switch or Engine Start/Stop Button to the **LOCK** or **OFF** position for 10 seconds and then to the **ON** position in order to preheat the engine again.

4 Wheel Drive (4WD) LOCK Indicator Light (if equipped)



This indicator light illuminates:

- Once you set the ignition switch or Engine Start/Stop Button to the ON position.
 - It illuminates for approximately 3 seconds and then goes off.
- When you select 4WD Lock mode by pressing the 4WD LOCK button.
 - The 4WD LOCK mode is to increase the drive power when driving on wet pavement, snow covered roads and/or off-road.

NOTICE

Do not use 4WD LOCK mode on dry paved roads or highway, it can cause noise, vibration or damage of 4WD related parts.

Cruise Indicator Light (if equipped)

■ Type A

■ Type B

CRUISE



This indicator light illuminates:

- When the cruise control system is enabled.

For more details, refer to “Cruise Control System” in chapter 5.

Cruise SET Indicator Light (if equipped)

SET

This indicator light illuminates:

- When the cruise control speed is set.

For more details, refer to “Cruise Control System” in chapter 5.

AUTO HOLD Indicator Light (if equipped)

AUTO HOLD

This indicator light illuminates:

- [White] When you activate the auto hold system by pressing the AUTO HOLD button.
- [Green] When you stop the vehicle completely by depressing the brake pedal with the auto hold system activated.
- [Yellow] When there is a malfunction with the auto hold system.

In this case, we recommend that you have the vehicle inspected by an authorized HYUNDAI dealer.

For more details, refer to “Auto Hold” in chapter 5.

SPORT Mode Indicator Light (if equipped)

SPORT

This indicator light illuminates

- When you select "SPORT" mode as drive mode.

For more details, refer to "Drive Mode Integrated Control System" in chapter 5.

تلفن شبانه روزی: ۰۲۱-۸۸۶۲۰۸۵

FarmaSOS.com

Downhill Brake Control (DBC) Indicator Light (if equipped)



This warning light illuminates:

- Once you set the ignition switch or Engine Start/Stop Button to the ON position.
 - It illuminates for approximately 3 seconds and then goes off.
- When you activate the DBC system by pressing the DBC button.

This warning light blinks:

- When the DBC is operating.

This warning light illuminates yellow:

- When there is a malfunction with the DBC system.

In this case, we recommend that you have the vehicle inspected by an authorized HYUNDAI dealer.

For more details, refer to “Downhill Brake Control (DBC) System” in chapter 5.

Lane Departure Warning System (LDWS) Indicator Light (if equipped)



This indicator light illuminates:

- [Green] When you activate the lane departure warning system.
- [White] When system operating conditions are not satisfied or when the sensor does not detect the lane line.
- [Yellow] When there is a malfunction with the lane departure warning system.

In this case, we recommend that you have the vehicle inspected by an authorized HYUNDAI dealer.

For more details, refer to "Lane Keeping Assist System (LKAS)" in chapter 5.

Lane Keeping Assist System (LKAS) Indicator (if equipped)



This indicator illuminates:

- [Green] When the system operating conditions are satisfied.
- [White] The system operating conditions are not satisfied.
- [Yellow] There is a malfunction with the LKAS.

In this case, we recommend you to have your vehicle inspected by an authorized HYUNDAI dealer.

For more details, refer to "Lane Keeping Assist System (LKAS)" in chapter 5.

FarmaSOS.com

تلفن شبانه روزی: ۰۸۵-۸۸۸۸۸۸۸۸-۰۲۱

Multimedia System

Multimedia system	4-2
AUX, USB and iPod® port	4-2
Antenna	4-3
Steering wheel audio control	4-4
Audio / Video / Navigation system (AVN)	4-5
<i>Bluetooth</i> ® Wireless Technology hands-free	4-5
How vehicle audio works	4-6
System controllers and functions	4-15
Audio Head Unit	
-RDS, Bluetooth equipped model	4-15
-RDS, No Bluetooth equipped model	4-17
Setup	4-19
Radio : FM, AM	4-28
DAB Radio (For DAB Model)	4-30
Basic Method of Use : USB / iPod® / My Music	
-RDS, Bluetooth equipped model	4-32
-RDS, No Bluetooth equipped model	4-32
<i>Bluetooth</i> ® Wireless Technology Audio	4-37
Voice Recognition	4-41

Multimedia System

MULTIMEDIA SYSTEM

i Information

- If you install an aftermarket HID headlamp, your vehicle's audio and electronic device may malfunction.
- Prevent chemicals such as perfume, cosmetic oil, sun cream, hand cleaner, and air freshener from contacting the interior parts because they may cause damage or discoloration.

AUX, USB and iPod® port



You can use an AUX port to connect audio devices and a USB port to plug in a USB and also in an iPod® port.

i Information

When using a portable audio device connected to the power outlet, noise may occur during playback. If this happens, use the power source of the portable audio device.

* iPod® is a trademark of Apple Inc.

FarmaSOS.com

Antenna

Roof antenna

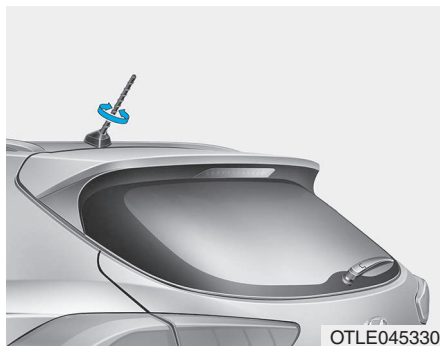

The roof antenna receives both AM and FM broadcast signals. Rotate the roof antenna in a counterclockwise direction to remove it. Rotate it in a clockwise direction to reinstall it.

Shark fin antenna

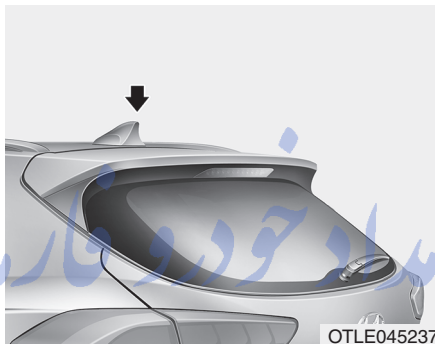

The shark fin antenna receives transmitted data. (for example: GPS and DAB signals)

NOTICE

- To prevent damage to the rear glass antenna, never use sharp instruments or window cleaner containing abrasives to clean the window. Clean the inside surface of the rear glass window with a piece of soft cloth.
- When putting a sticker on the inside surface of the rear window, be careful not to damage to the rear glass antenna.
- Do not put sharp instruments nearby the rear glass antenna.
- Tinted rear window may affect the proper functioning of the antenna.

Multimedia System

Steering wheel audio control (if equipped)

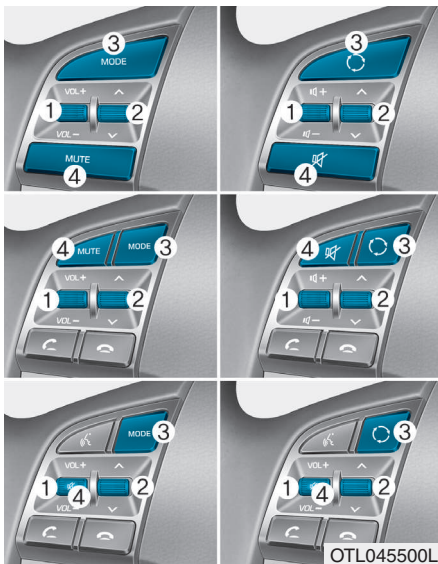

The steering wheel audio control button is installed for your convenience.

NOTICE

Do not operate audio remote control buttons simultaneously.

4-4

VOLUME (VOL + / -) (1)

- Move the VOLUME lever up to increase volume.
- Move the VOLUME lever down to decrease volume.

SEEK/PRESET (^ / v) (2)

If the SEEK/PRESET lever is moved up or down and held for 0.8 second or more, it will function in the following modes.

RADIO mode

It will function as the AUTO SEEK select button. It will SEEK until you release the button.

MEDIA mode

It will function as the FF/REW button.

If the SEEK/PRESET lever is moved up or down, it will function in the following modes.

RADIO mode

It will function as the PRESET STATION UP/DOWN button.

MEDIA mode

It will function as the TRACK UP/DOWN button.

MODE () (3)

Press the MODE button to select Radio, Disc, or AUX.

MUTE () (4, if equipped)

- Press the button to mute the sound.
- Press the button again to activate the sound.

i Information

Detailed information for audio control buttons are described in the following pages in this chapter.

Audio / Video / Navigation system (AVN) (if equipped)

Detailed information for the AVN system is described in a separately supplied manual.

Bluetooth® Wireless Technology hands-free (if equipped)

You can use the phone wirelessly by using the *Bluetooth*® Wireless Technology.

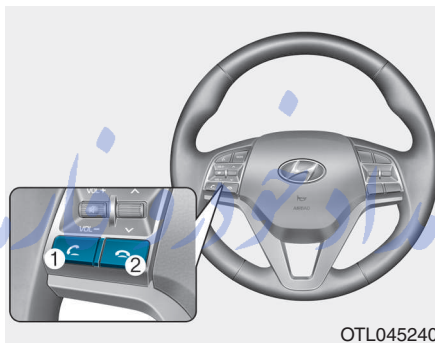

- (1) Call / Answer button
- (2) Call end button



- (3) Microphone

- Audio : For detailed information, refer to “AUDIO” in this chapter.
- AVN : Detailed information for the *Bluetooth*® Wireless Technology hands-free is described in the manual supplied separately.

i Information

Make sure that your mobile phone system is up to date to assure proper function of bluetooth connection.

Multimedia System

How Vehicle Audio Works

FM reception

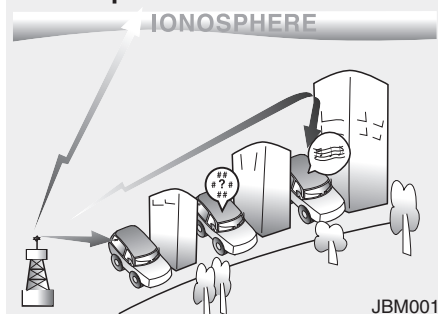

AM and FM radio signals are broadcast from transmitter towers located around your city. They are intercepted by the radio antenna on your vehicle. This signal is then processed by the radio and sent to your vehicle speakers.

When a strong radio signal has reached your vehicle, the precise engineering of your audio system ensures the best possible quality reproduction. However, in some cases the signal coming to your vehicle may not be strong and clear.

This can be due to factors, such as the distance from the radio station, closeness of other strong radio stations or the presence of buildings, bridges or other large obstructions in the area.

امداد خودرو فارما

تلفن شبانه روزی: ۰۲۱-۸۸۸۶۲۰۸۵

FarmaSOS.com

AM reception

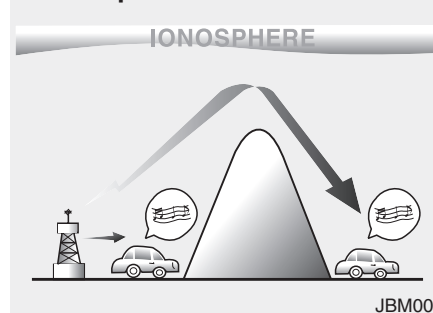

AM broadcasts can be received at greater distances than FM broadcasts. This is because AM radio waves are transmitted at low frequencies. These long distance, low frequency radio waves can follow the curvature of the earth rather than travelling straight. In addition, they curve around obstructions resulting in better signal coverage.

FM radio station

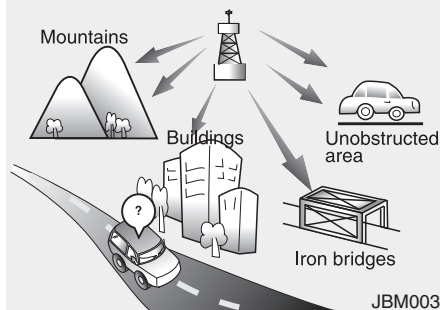

FM broadcasts are transmitted at high frequencies and do not bend to follow the earth's surface. Because of this, FM broadcasts generally begin to fade within short distances from the station. Also, FM signals are easily affected by buildings, mountains, and obstructions. This can lead to undesirable or unpleasant listening conditions which might lead you to believe a problem exists with your radio. The following conditions are normal and do not indicate radio trouble:

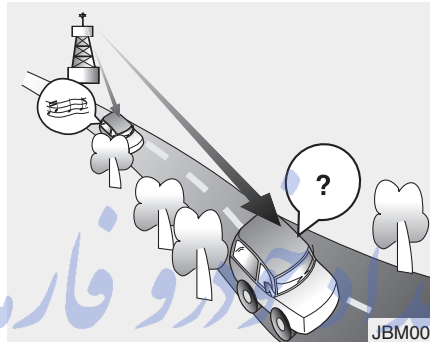

- **Fading** - As your vehicle moves away from the radio station, the signal will weaken and sound will begin to fade. When this occurs, we suggest that you select another stronger station.
- **Flutter/Static** - Weak FM signals or large obstructions between the transmitter and your radio can disturb the signal causing static or fluttering noises to occur. Reducing the treble level may lessen this effect until the disturbance clears.

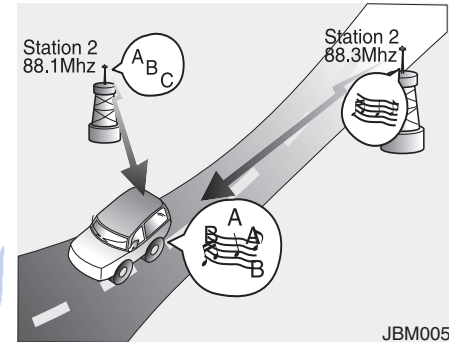

- **Station Swapping** - As an FM signal weakens, another more powerful signal near the same frequency may begin to play. This is because your radio is designed to lock onto the clearest signal. If this occurs, select another station with a stronger signal.
- **Multi-Path Cancellation** - Radio signals being received from several directions can cause distortion or fluttering. This can be caused by a direct and reflected signal from the same station, or by signals from two stations with close frequencies. If this occurs, select another station until the condition has passed.

Multimedia System

Using a cellular phone or a two-way radio

When a cellular phone is used inside the vehicle, noise may be produced from the audio system. This does not mean that something is wrong with the audio equipment. In such a case, try to operate mobile devices as far from the audio equipment as possible.

CAUTION

When using a communication system such as a cellular phone or a radio set inside the vehicle, a separate external antenna must be fitted. When a cellular phone or a radio set is used with an internal antenna alone, it may interfere with the vehicle's electrical system and adversely affect safe operation of the vehicle.

WARNING

Do not use a cellular phone while driving. Stop at a safe location to use a cellular phone.

NOTE:

Order of playing files (folders) :

1. Song playing order : ① to ⑭

2. Folder playing order :

* If no song file is contained in the folder, that folder is not displayed.

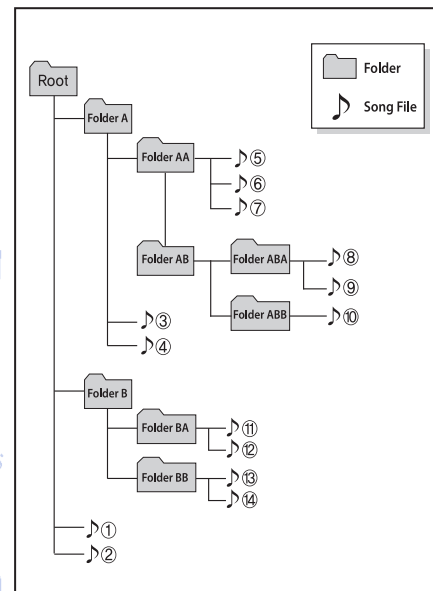
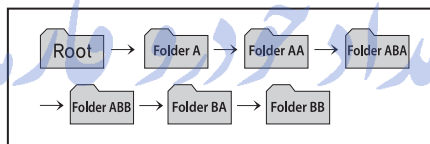

تلفن شبانه روزی: ۰۸۵-۸۸۶۲-۲۱

FarmaSOS.com

⚠ WARNING

- Do not stare at the screen while driving. Staring at the screen for prolonged periods of time could lead to traffic accidents.
- Do not disassemble, assemble, or modify the audio system. Such acts could result in accidents, fire, or electric shock.
- Using the phone while driving may lead to a lack of attention of traffic conditions and increase the likelihood of accidents. Use the phone feature after parking the vehicle.
- Heed caution not to spill water or introduce foreign objects into the device. Such acts could lead to smoke, fire, or product malfunction.

⚠ CAUTION

- Operating the device while driving could lead to accidents due to a lack of attention to external surroundings. First park the vehicle before operating the device.
- Adjust the volume to levels that allow the driver to hear sounds from outside of the vehicle. Driving in a state where external sounds cannot be heard may lead to accidents.
- Pay attention to the volume setting when turning the device on. A sudden output of extreme volume upon turning the device on could lead to hearing impairment. (Adjust the volume to a suitable level before turning off the device.)

NOTICE

- Do not place beverages close to the audio system. Spilling beverages may lead to system malfunction.
- In case of product malfunction, please contact your place of purchase or After Service center.
- Placing the audio system within an electromagnetic environment may result in noise interference.
- Prevent caustic solutions such as perfume and cosmetic oil from contacting the dashboard because they may cause damage or discoloration.

Multimedia System

i Information - Using the USB device

- Connect the USB device after turning on the engine. The USB device may become damaged if it is already connected when the ignition is turned on. The USB device may not operate properly if the car ignition is turned on or off with the USB device connected.
- Heed caution to static electricity when connecting/disconnecting USB devices.
- Encoded MP3 Players will not be recognized when connected as an external device.
- When connecting an external USB device, the device may not properly recognize the USB is in some states.
- Only products formatted with byte/sectors under 64Kbyte will be recognized.
- This device recognizes USB devices formatted in FAT 12/16/32 file formats. This device does not recognize files in NTFS file format.
- Some USB devices may not be supported due to compatibility issues.

(Continued)

4-10

(Continued)

- Avoid contact between the USB connector with bodily parts or foreign objects.
- Repeated connecting/disconnecting of USB devices within short periods of time may result in product malfunction.
- A strange noise may occur when disconnecting the USB.
- Make sure to connect/disconnect external USB devices with the audio power turned off.
- The amount of time required to recognize the USB device may differ depending on the type, size or file formats stored in the USB. Such differences in time are not indications of malfunctions.
- The device only supports USB devices used to play music files.
- USB images and videos are not supported.
- Do not use the USB I/F to charge batteries or USB accessories that generate heat. Such acts may lead to worsened performance or damage to the device.

(Continued)

(Continued)

- The device may not recognize the USB device if separately purchased USB hubs and extension cables are being used. Connect the USB directly with the multimedia terminal of the vehicle.
- When using mass storage USB devices with separate logical drives, only files saved to the root drive can be played.
- Files may not properly operate if application programs are installed to the USBs.
- The device may not operate normally if MP3 Players, cellular phones, digital cameras, or other electronic devices (USB devices not recognized as portable disk drives) are connected with the device.
- Charging through the USB may not work for some mobile devices.
- The device may not support normal operation when using a USB memory type besides (Metal Cover Type) USB Memory.

(Continued)

(Continued)

- The device may not support normal operation when using formats such as HDD Type, CF, or SD Memory.
- The device will not support files locked by DRM (Digital Rights Management.)
- USB memory sticks used by connecting an Adaptor (SD Type or CF Type) may not be properly recognized.
- The device may not operate properly when using USB HDDs or USBs subject to connection failures caused by vehicle vibrations. (e.g. i-stick type)
- Avoid use of USB memory products that can also be used as key chains or mobile phone accessories. Use of such products may cause damage to the USB jack.
- Connecting an MP3 device or phone through various channels, such as AUX/BT or Audio/ USB mode may result in pop noises or abnormal operation.



i Information - Using the iPod® device

- iPod® is a registered trademark of Apple Inc.
- In order to use the iPod® while operating the keys, you must use a dedicated iPod® cable. (the cable that is supplied when purchasing iPod® /iPhone® products)
- If the iPod® is connected to the vehicle while it is playing, a high pitch sound could occur for approximately 1-2 seconds immediately after connecting. If possible, connect the iPod to the vehicle with the iPod® stopped/ paused.
- During ACC ON state, connecting the iPod® through the iPod® cable will charge the iPod® through the car audio system.
- When connecting with the iPod® cable, make sure to fully insert the jack to prevent communication interference.

(Continued)

(Continued)

- When the EQ features of an external device, such as the iPod®, and the audio system are both active, EQ effects could overlap and cause sound deterioration and distortion. Whenever possible, turn off the EQ feature within the external device upon use by connecting with the audio system.
- Noise may occur when an iPod® or AUX device is connected. When such devices are not being used, disconnect the device for storage.
- When the iPod® or AUX device power is connected to the power jack, playing the external device may result in noise. In such cases, disconnect the power connection before use.
- Skipping or improper operation may occur depending on the characteristics of your iPod® /Phone® device.

(Continued)

Multimedia System

(Continued)

- If your iPhone® is connected to both the *Bluetooth*® Wireless Technology and USB, the sound may not be properly played. In your iPhone®, select the Dock connector or *Bluetooth*® Wireless Technology to change the sound output (source).
- iPod mode cannot be operated when the iPod® cannot be recognized due to versions that do not support communication protocols.
- For fifth generation iPod® Nano devices, the iPod® may not be recognized when the battery level is low. Please charge the iPod® for use.
- Search/play orders shown within the iPod® device may differ with the orders shown within the audio system.
- If the iPod® malfunctions due to an iPod® device defect, reset the iPod® and try again. (To learn more, refer to your iPod® manual)

(Continued)

(Continued)

- Some iPod®s may not sync with the System depending on its version. If the Media is removed before the Media is recognized, then the system may not properly restore the previously operated mode. (iPod® charging is not supported.)

امداد خودرو فارما

تلفن شبانه روزی: ۰۲۱-۸۸۸۶۲۰۸۵

FarmaSOS.com

i Information - Using the AUX device

- If an external device connector is connected with the AUX terminal, then AUX mode will automatically operate. Once the connector is disconnected, the previous mode will be restored.
- AUX mode can be used only when an external audio player (camcorder, car VCR, etc.) has been connected.
- The AUX volume can be controlled separately from other audio modes.
- Connecting a connector jack to the AUX terminal without an external device will convert the system to AUX mode, but only output noise. When an external device is not being used, also remove the connector jack.
- When the external device power is connected to the power jack, playing the external device may output noise. In such cases, disconnect the power connection before use.
- Fully insert the AUX cable to the AUX jack upon use.

i Information - Before using the Bluetooth® handsfree

What is Bluetooth® ?

- Bluetooth® refers to a short-distance wireless networking technology which uses a 2.4GHz ~ 2.48GHz frequency to connect various devices within a certain distance.
- Supported within PCs, external devices, Bluetooth® phones, PDAs, various electronic devices, and automotive environments, Bluetooth® allows data to be transmitted at high speeds without having to use a connector cable.
- Bluetooth® Handsfree refers to a device which allows the user to conveniently make phone calls with Bluetooth® mobile phones through the audio system.
- Bluetooth® Handsfree may not be supported in some mobile phones. To learn more about mobile device compatibility, visit www.hyundaiusa.com.

i Information - Precautions for safe driving

- Bluetooth® Handsfree is a feature that enables drivers to practice safe driving. Connecting the head unit with a Bluetooth® phone allows the user to conveniently make and receive calls and use contacts. Before using Bluetooth®, carefully read the contents of this user's manual.
- Excessive use or operations while driving may lead to negligent driving practices and result in accidents. Refrain from excessive operations while driving.
- Viewing the screen for prolonged periods of time is dangerous and may lead to accidents. When driving, view the screen only for short periods of time.

i Information - When connecting a Bluetooth® phone

- Before connecting the head unit with the mobile phone, check to see that the mobile phone supports Bluetooth® features.
- Even if the phone supports Bluetooth®, the phone will not be found during device searches if the phone has been set to hidden state or the Bluetooth® power is turned off. Disable the hidden state or turn on the Bluetooth® power prior to searching/connecting with the Head unit.
- Bluetooth phone is automatically connected when the ignition on.
- If you do not want automatic connection with your Bluetooth® device, turn off the Bluetooth® feature within your mobile phone.
- The Handsfree call volume and quality may differ depending on the mobile phone.

(Continued)

Multimedia System

(Continued)

- Park the vehicle when connecting the head unit with the mobile phone.
- Bluetooth® connection may become intermittently disconnected in some mobile phones. Follow these steps to try again.
 1. Within the mobile phone, turn the Bluetooth® function off/on and try again.
 2. Turn the mobile phone power Off/On and try again.
 3. Completely remove the mobile phone battery, reboot, and then again.
 4. Reboot the Audio System and try again.
 5. Delete all paired devices, pair and try again.
- Handsfree call quality and volume may differ depending on the model of your mobile phone.

i Information - Using the voice recognition

- When using the voice recognition feature, only commands listed with in the user's manual are supported.
- Be aware that during the operation of the voice recognition system, pressing any key other than the  key terminate voice recognition mode.
- For superior voice recognition performance, position the microphone used for voice recognition above the head of the driver's seat and maintain a proper position when saying commands.
- Within the following situations, voice recognition may not function properly due to external sound.
 - When the windows and sunroof are open
 - When the wind of the cooling / heating device is strong
 - When entering and passing through tunnels

(Continued)

(Continued)

- When driving on rugged and uneven roads
- During severe rain (heavy rains, windstorms)
- Phone related voice commands can be used only when a Bluetooth® Wireless Technology device is connected.
- When making calls by stating a name, the corresponding contact must be downloaded and stored within the audio system.
- After downloading the Bluetooth® Wireless Technology phone book, it takes some times to convert the phone book data into voice information. During this time, voice recognition may not properly operate.
- Pronounce the voice commands naturally and clearly as if in a normal conversation.

System Controllers and Functions

Audio Head Unit

-RDS, Bluetooth equipped model



Name	Description
① RADIO	<p>Each time the key is pressed, the mode is changed in order of FM1 → FM2 → FMA → AM → AMA.</p> <p>(for DAB model) FM1 → FM2 → FMA → DAB1 → DAB2 → AM.</p> <p>* In Setup>Display, the radio pop up screen will be displayed when [Mode Pop up] is turned On.</p> <p>* When the pop up screen is displayed, use the TUNE knob or keys 1 ~ 6 to select the desired mode.</p>

Name	Description
② MEDIA	<p>Each time the key is pressed, the mode is changed in order of USB, iPod, AUX, My Music, BT Audio modes.</p> <p>* In Setup>Display, the media pop up screen will be displayed when [Mode Pop up] is turned On.</p> <p>* When the pop up screen is displayed, use the TUNE knob or keys 1 ~ 4 to select the desired mode.</p>
③	Operates Phone Screen.
④	<ul style="list-style-type: none"> • Shortly press the key : Moves to the Display, Sound, Clock, Phone, System setting modes • Press and hold the key : Moves to clock settings
⑤ SEEK TRACK	<ul style="list-style-type: none"> • Radio mode : Automatically searches for broadcast frequencies. • USB, iPod, My Music modes : <ul style="list-style-type: none"> - Shortly press the key : Moves to next or previous song(file). - Press and hold the key : Rewinds or fast forwards the current song(file).
⑥ POWER/VOL knob	<ul style="list-style-type: none"> • Power Knob : Turns power On/Off by pressing the knob. • Volume Knob : Sets volume by turning the knob left/right.
⑦ 1 ~ 6 (Preset)	<ul style="list-style-type: none"> • Radio mode : Saves frequencies (channels) or receives saved frequencies (channels). • USB, iPod, My Music modes <ul style="list-style-type: none"> - 1 RPT : Repeat - 2 RDM : Random

Multimedia System



Name	Description
⑧	Each time the button is shortly pressed, it sets the screen Off → Screen On → Screen Off. * Audio operation is maintained and only the screen will be turned Off. In the screen Off state, press any key to turn the screen On again.

Name	Description
⑨	<ul style="list-style-type: none"> Radio mode <ul style="list-style-type: none"> Shortly press the key : Previews each broadcast for 5 seconds each. Press and hold the key : Previews the broadcasts saved in Preset 1 ~ 6 for 5 seconds each. * Press the key again to continue listening to the current frequency. USB, iPod modes <ul style="list-style-type: none"> Shortly press the key : Previews each song (file) for 10 seconds each. * Press the key again to continue listening to the current song (file).
⑩	Displays menus for the current mode.
⑪	Moves to previous screen.
⑫	USB mode : Folder Search * May differ depending on the selected audio.
⑬	<ul style="list-style-type: none"> Radio mode : Changes frequency by turning the knob left/right. USB, iPod modes : Searches songs (files) by turning the knob left/right. * When the desired song is displayed, press the knob to play the song.

-RDS, No Bluetooth equipped model



Name	Description
① FM	<ul style="list-style-type: none"> Changes to FM mode. Each time the key is pressed, the mode changed in order of FM1 → FM2.
② AM	Changes to AM mode.

Name	Description
③ MEDIA	<p>Each time the key is pressed, the mode is changed in order of USB, iPod, AUX modes.</p> <p>※ In Setup>Display, the media pop up screen will be displayed when [Mode Pop up] is turned On.</p> <p>※ When the pop up screen is displayed, use the TUNE knob or keys 1 ~ 4 to select the desired mode.</p>
④ Settings	<ul style="list-style-type: none"> Shortly press the key : Moves to the Display, Sound, Clock, Phone, System setting modes. Press and hold the key : Moves to clock settings.
⑤ SEEK/TRACK	<ul style="list-style-type: none"> Radio mode : Automatically searches for broadcast frequencies. USB, iPod modes : <ul style="list-style-type: none"> Shortly press the key : Moves to next or previous song(file). Press and hold the key : Rewinds or fast forwards the current song(file).
⑥ POWER/VOL knob	<ul style="list-style-type: none"> Power Knob : Turns power On/Off by pressing the knob. Volume Knob : Sets volume by turning the knob left/right.
⑦ 1 ~ 6 (Preset)	<ul style="list-style-type: none"> Radio mode : Saves frequencies (channels or receives saved frequencies (channels). USB, iPod® modes <ul style="list-style-type: none"> 1 RPT : Repeat 2 RDM : Random

Multimedia System



Name	Description
⑧	Each time the button is shortly pressed, it sets the screen Off → Screen On → Screen Off. * Audio operation is maintained and only the screen will be turned Off. In the screen Off state, press any key to turn the screen On again.

Name	Description
⑨	<ul style="list-style-type: none"> • Radio mode <ul style="list-style-type: none"> - Shortly press the key : Previews each broadcast for 5 seconds each. - Press and hold the key : Previews the broadcasts saved in Preset 1 - 6 for 5 seconds each. * Press the key again to continue listening to the current frequency. • USB, iPod modes <ul style="list-style-type: none"> - Shortly press the key : Previews each song (file) for 10 seconds each. * Press the key again to continue listening to the current song (file).
⑩	Displays menus for the current mode.
⑪	Moves to previous screen.
⑫	USB mode : Folder Search. * May differ depending on the selected audio.
⑬	<ul style="list-style-type: none"> • Radio mode : Changes frequency by turning the knob left/right. • USB, iPod modes: Searches songs (files) by turning the knob left/right. * When the desired song is displayed, press the knob to play the song.

Setup

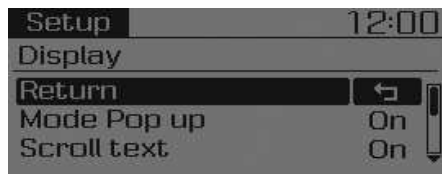

Display Settings

Press the  key ▶ Select [Display] through  TUNE knob or  key ▶ Select menu through  TUNE knob





Mode Pop up

[Mode Pop up] ▶ Changes  selection mode

- During On state, press the  or  key to display the mode change pop up screen.

Scroll text

[Scroll text] ▶ Set  / 

-  : Maintains scroll
-  : Scrolls only one (1) time.

Song Info

When playing an MP3 file, select the desired display info from 'Folder/File' or 'Album/Artist/Song'.

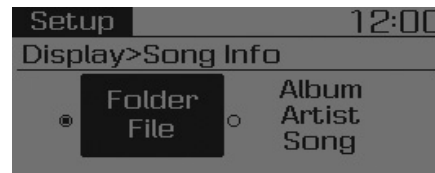

Multimedia System

Sound Settings

Press the  key ▶ Select [Sound] through  TUNE knob or  key ▶ Select menu through  TUNE knob

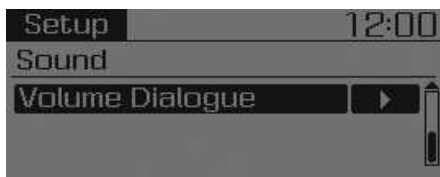
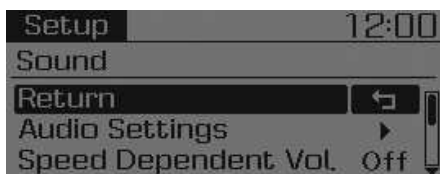

Audio Settings

This menu allows you to set the 'Bass, Middle, Treble' and the Sound Fader and Balance.

Select [Audio Settings] ▶ Select menu through  TUNE knob ▶

Turn  TUNE knob left/right to set

- Bass, Middle, Treble : Selects the sound tone.
- Fader, Balance : Moves the sound fader and balance.
- Default : Restores default settings.
- * Return : While adjusting values, re-pressing the  TUNE knob will restore the parent menu.

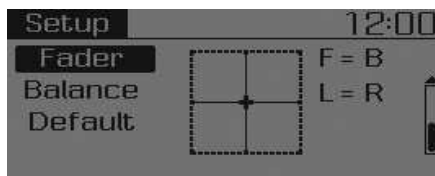

Speed Dependent Volume Control

This feature is used to automatically control the volume level according to the speed of the vehicle.

Select [Speed Dependent Vol.] ▶ Turn SDVC On/Off by pressing the  TUNE knob

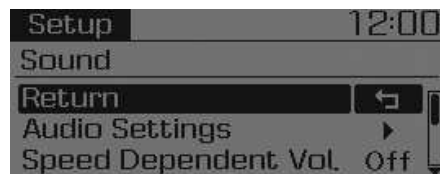

Volume Dialogue

Adjusts voice recognition volume.

Select [Volume Dialogue] ▶ Set volume of  TUNE knob



Clock Settings

Press the  key ▶ Select [Clock] through  TUNE knob or  key ▶ Select menu through  TUNE knob

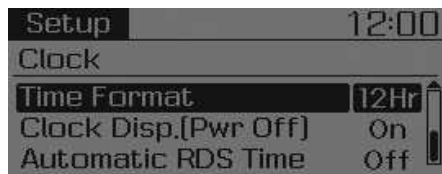
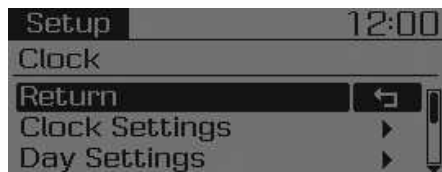

Clock Settings

This menu is used to set the time.

Select [Clock Settings] Set through  TUNE knob ▶ Press  TUNE knob



* Adjust the number currently in focus to set the [hour] and press the tune knob to set the [minute].

تلفن شبانه روزی: ۰۸۵-۸۸۶۲-۰۲۱

FarmaSOS.com

Day Settings

This menu is used to set the date(DD/MM/YYYY).

Select [Day Settings] Set through  TUNE knob ▶ Press  TUNE knob

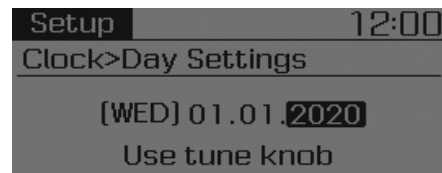

* Adjust the number currently in focus to make the settings and press the tune knob to move to the next setting. (Set in order of Day/Month/Year)



Multimedia System

Time Format

This function is used to set the 12/24 hour time format of the audio system. Select [Time Format] Set 12Hr / 24Hr through 

Clock Display when Power is OFF



Select [Clock Disp.(Pwr Off)]▶ Set  through 

-  : Displays time/date on screen
-  : Turn off.

Automatic RDS Time

This option is used to automatically set the time by synchronizing with RDS.

Select [Automatic RDS Time]▶ Set  through 

-  : Turn on Automatic Time
-  : Turn off.

NOTICE

Because some local radio stations do not support an automatic RDS time function, some RDS Transmitters may not provide correct time. If incorrect time is displayed, set it manually following the Step "Clock Setting" in previous page.

تلفن شبانه روزی: ۰۲۱-۸۸۸۶۲۰۸۵

FarmaSOS.com

Phone Settings (For *Bluetooth®* Wireless Technology equipped model)

Press the key ▶ Select [Phone] through TUNE knob or 4 key ▶ Select menu through TUNE knob

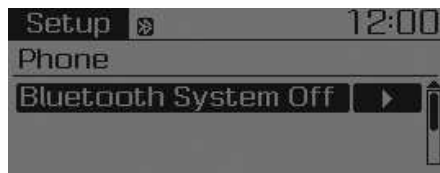
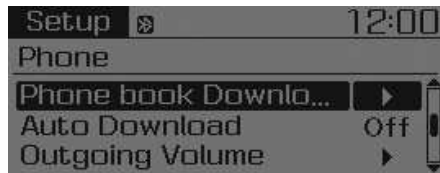
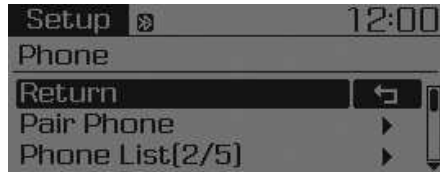

Pair Phone

NOTICE

To pair a *Bluetooth®* Wireless Technology enabled mobile phone, authentication and connection processes are first required. As a result, you cannot pair your mobile phone while driving the vehicle. First park your vehicle before use.

Select [Pair Phone] ▶ Set through TUNE knob

- ① Search for device names, as displayed on your mobile phone and connect.
 - ② Input the passkey displayed on the screen. (Passkey : 0000)
- * The device name and passkey will be displayed on the screen for up to 3 minutes. If pairing is not completed within the 3 minutes, the mobile phone pairing process will automatically be canceled.

- ③ Pairing completion is displayed.
- * In some mobile phones, pairing will automatically be followed by connection.
- * It is possible to pair up to five *Bluetooth®* Wireless Technology enabled mobile phones.

Multimedia System

Phone List

The names of up to 5 paired phones will be displayed.

A [▶] is displayed in front of the currently connected phone.

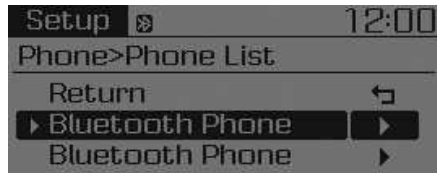

Select the desired name to setup the selected phone.

• Connecting a phone

Select [Phone List]▶Select mobile phone through TUNE knob▶Select [Connect Phone]

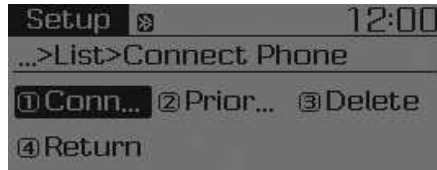

- ① Select a mobile phone that is not currently connected.

- ② Connect the selected mobile phone.

- ③ Connection completion is displayed.

* If a phone is already connected, disconnect the currently connected phone and select a new phone to connect.

• Disconnecting a connected phone
Select [Phone List]▶Select mobile phone through TUNE knob▶Select [Disconnect Phone]

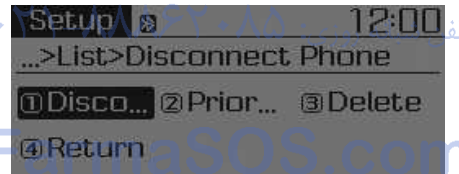

- ① Select the currently connected mobile phone.

- ② Disconnect the selected mobile phone.

- ③ Disconnection completion is displayed.

• Changing connection sequence (Priority)

This is used to change the order (priority) of automatic connection for the paired mobile phones.

Select [Phone List]▶Select [Priority] through TUNE knob▶Select No. 1 Priority mobile phone

- ① Select [Priority].

- ② From the paired phones, select the phone desired for No.1 priority.

- ③ The changed priority sequence is displayed.

* Once the connection sequence (priority) is changed, the new no. 1 priority mobile phone will be connected.

- When the no. 1 priority cannot be connected : Automatically attempts to connect the most recently connected phone.

- Cases when the most recently connected phone cannot be connected : Attempts to connect in the order in which paired phones are listed.

- The connected phone will automatically be changed to No. 1 priority.

- Delete

Select [Phone List]▶Select mobile phone through  TUNE knob▶ Select [Delete]

- ① Select the desired mobile phone.
- ② Delete the selected mobile phone.
- ③ Deletion completion is displayed.

* When attempting to delete a currently connected phone, the phone is first disconnected.

NOTICE

- When you delete a mobile phone, the mobile phone phone book will also be erased.
- For stable *Bluetooth*® Wireless Technology communication, delete the mobile phone from the audio and also delete the audio from your mobile phone.

Phone book Download

This feature is used to download phone book and call histories into the audio system.

Select [Phone book Download]▶ Select through 

NOTICE

- The download feature may not be supported in some mobile phones.
- If a different operation is performed while phone book is being downloaded, downloading will be discontinued. Phone book already downloaded will be saved.
- When downloading new phone book, delete all previously saved phone book before starting download.

Auto Download

When connecting a mobile phone, it is possible to automatically download new phone book and Call Histories.



Select [Auto Download]▶Set  /  through 

Multimedia System

Outgoing Volume

This is used to set the volume of your voice as heard by the other party while on a *Bluetooth*® Wireless Technology enabled handsfree call.

Select [Outgoing Volume] ▶ Set volume through  TUNE knob

✱ Even while on a call, the volume can be changed by using the ,  key.

Bluetooth® Wireless Technology System Off

This feature is used when you do not wish to use the *Bluetooth*® Wireless Technology system.

Select [Bluetooth System Off] ▶ Set through  TUNE knob

✱ If a phone is already connected, disconnect the currently connected phone and turn the *Bluetooth*® Wireless Technology system off.

Using the Bluetooth® Wireless Technology System

To use *Bluetooth*® Wireless Technology when the system is currently off, follow these next steps.

- Turning On *Bluetooth*® Wireless Technology through the  Key
Press the  key ▶ Screen Guidance

✱ Moves to the screen where *Bluetooth*® Wireless Technology functions can be used and displays guidance.

- Turning On *Bluetooth*® Wireless Technology through the  Key

Press the  key ▶ Select [Phone] through  TUNE knob or  key

① A screen asking whether to turn on *Bluetooth*® Wireless Technology will be displayed.

② On the screen, select  to turn on *Bluetooth*® Wireless Technology and display guidance.

✱ If the *Bluetooth*® Wireless Technology system is turned on, the system will automatically try to connect the most recently connected *Bluetooth*® Wireless Technology mobile phone.

NOTICE

- *Bluetooth*® Wireless Technology connection may become intermittently disconnected in some mobile phones. Follow these next steps to try again.

- 1) Turn the *Bluetooth*® Wireless Technology function within the mobile phone ON/OFF and try to connect again.
- 2) Turn the mobile phone power ON/OFF and try to connect again.
- 3) Completely remove the mobile phone battery, reboot, and then try to connect again.
- 4) Reboot the audio system and try to connect again
- 5) Delete all paired devices in your mobile phone and the audio system and pair again for use.

System Settings

Press the  key ▶ Select [System]

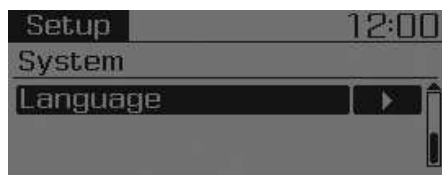
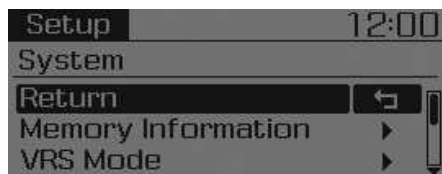

Memory Information (If equipped)

Displays currently used memory and total system memory.

Select [Memory Information] ▶ OK

The currently used memory is displayed on the left side while the total system memory is displayed on the right side.

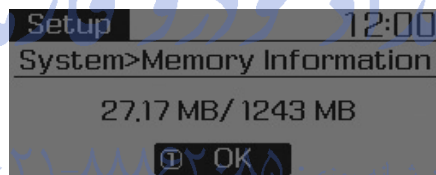

VRS Mode

This feature is used to change voice command feedback between Normal and Expert modes.

Select [VRS Mode] ▶ Set through 

- Normal : This mode is for beginner users and provides detailed instructions during voice command operation.

- Expert : This mode is for expert users and omits some information during voice command operation. (When using Expert mode, guidance instructions can be heard through the [Help] or [Menu] commands.)

* May differ depending on the selected audio.

Language

This menu is used to set the display and voice recognition language.

Select [Language] ▶ Set through 

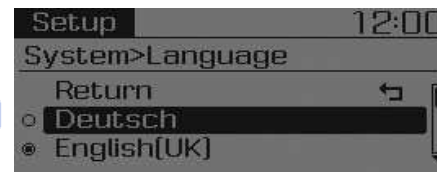

* The system will reboot after the language is changed.

- * Language support by region
 - Deutsch, English(UK), Français, Italiano, Español, Nederlands, Svenska, Dansk, Русский, Polski, Türkçe

Multimedia System

Radio : FM, AM

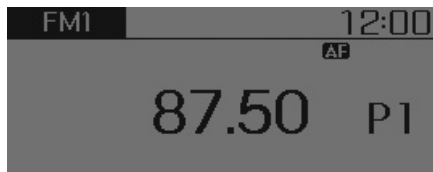

SEEK

Press the **SEEK** (up arrow) or **TRACK** (down arrow) key

- Shortly pressing the key : Changes the frequency.
- Pressing and holding the key : Automatically searches for the next frequency.

Preset SEEK

Press the **1** ~ **6** key

- Shortly pressing the key : Plays the frequency saved in the corresponding key.
- Pressing and holding the key : Pressing and holding the desired key from **1** ~ **6** will save the currently playing broadcast to the selected key and sound a BEEP.

Press the **TA SCAN** key

- Pressing and holding the key : The broadcast frequency increases and previews each broadcast for 5 seconds each. After scanning all frequencies, returns and plays the current broadcast frequency.

Selecting through manual search

Turn the **TUNE** knob left/right to adjust the frequency.

Traffic Announcement (TA)

Shortly pressing the **TA SCAN** key (under 0.8 seconds) : Set **On** / **Off** TA Traffic Announcement) mode.

MENU

Within **MENU** key are the A.Store (Auto Store) and Info functions.

AST (Auto Store)

Press the **MENU** key ▶ Set [**1** AST] through **TUNE** knob or **1 RPT** key.



Select AST (Auto Store) to save frequencies with superior reception to presets **1** ~ **6**. If no frequencies are received, then the most recently received frequency will be broadcast.

* Saves only to the Preset memory **1** ~ **6** of FMA or AMA mode.

AF (Alternative Frequency)

Press the **MENU** key ▶ Set [**2** AF] through **TUNE** knob or **2 RDM** key.

The Alternative Frequency option can be turned On/Off.

Region

Press the **MENU** key ▶ Set [**3** Region] through **TUNE** knob or **3** key.

The Region option can be turned On/Off.

News

Press the **MENU** key ▶ Set [**4** News] through **TUNE** knob or **4** key.

The News option can be turned On/Off.

Info Volume

Info Volume refers to the sound volume upon receiving News or Traffic information.

The info volume can be controlled by turning the **VOL** knob left/right while a news or traffic broadcast is playing.

* AF, Region, and News are RDS Radio menus.

Multimedia System

DAB Radio (For DAB Model)

* RADIO may differ depending on the selected audio.

Changing RADIO mode

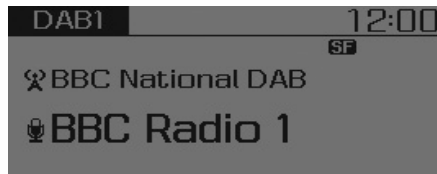

Press the **RADIO** Key to change the mode in order of FM1 → FM2 → FMA → DAB1 → DAB2 → AM.

SEEK

Press the **SEEK**, **TRACK** key

- Shortly pressing the key (under 0.8 seconds): Changes the station.
- Press and hold the key (over 0.8 seconds): Change the Ensemble.

Ensemble

Press the **FOLDER**, **FOLDER** key

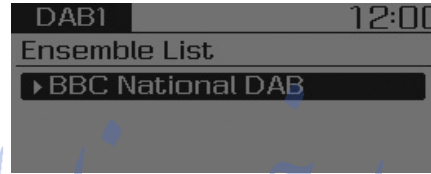

- Search the Ensemble. Use the Tune knob to select the desired Ensemble and select stations within the Ensemble.

تلفن شبانه روزی: ۰۲۱-۸۸۸۶۲۰۸۵

FarmaSOS.com

Preset SEEK

Press the **1** ~ **6** key

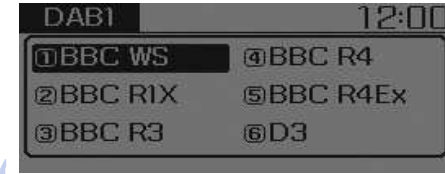

- Shortly pressing the key (under 0.8 seconds): Plays the station saved in the corresponding key.
- Pressing and holding the key (over 0.8 seconds): Pressing and holding the desired key from **1** ~ **6** will save the currently playing station to the selected key and sound a BEEP.

SCAN

Press the **TA SCAN** key

- Shortly pressing the key (under 0.8 seconds): TA On/Off
- Pressing and holding the key (over 0.8 seconds): The broadcast station increases and previews each broadcasts for 5 seconds each. After scanning all stations, returns and plays the current broadcast station.

Selecting through manual search

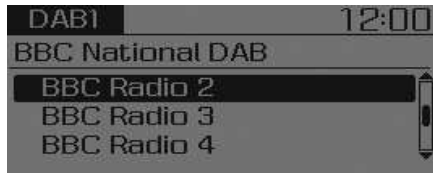

Turn the **TUNE** knob left/right to select the station.

MENU

Within **MENU** key are the Service.F (Service Following) And L-Band functions.



Service Following

Press the **MENU** key ▶ Set [1 Service.F] through **TUNE** knob or **1 RPT** key.

When the DAB signal is weak, the Service Following feature will automatically convert to the identical FM broadcast when such a broadcast is available.

L-Band

Press the **MENU** key ▶ Set [2 L-Band] through **TUNE** knob or **2 RDM** key.

DAB Broadcasts include BAND III and L-BAND according to the Range. BAND III is always set as the default while the L-BAND feature can be turned on to search for L-BAND broadcasts when in regions where L-BAND broadcasts are available.

Multimedia System

Basic Method of Use : USB / iPod® / My Music

- RDS, Bluetooth equipped model



- RDS, No Bluetooth equipped model



Name	Description
① Repeat	<p>While song (file) is playing ▶ 1 RPT key</p> <p>USB, iPod®, My Music mode :</p> <ul style="list-style-type: none"> • Repeats the current song <p>USB mode :</p> <ul style="list-style-type: none"> • Repeats songs within the current folder. (Pressing the key twice). <p>* Press the 1 RPT key again to turn off repeat.</p>
② Random	<p>While song (file) is playing ▶ 2 RDM key</p> <p>iPod®, My Music mode :</p> <ul style="list-style-type: none"> • Plays all songs randomly <p>USB mode :</p> <ul style="list-style-type: none"> • Folder Random : Plays all files within the current folder in random order. • All Random : Plays all files in random order(Pressing the key twice). <p>* Press the 2 RDM key again to turn off repeat.</p>
③ Changing Song/File	<p>While song (file) is playing ▶ SEEK TRACK key</p> <ul style="list-style-type: none"> • Shortly pressing the key : plays the current song from the beginning / plays the next song. • Pressing and holding the key : Rewinds the song / fast forwards the song. <p>* If the TRACK key is pressed again within 1 second, the previous song is played.</p>

- RDS, Bluetooth equipped model



Name	Description
④ Scan	<p>While song (file) is playing ► TA SCAN key Scans all songs for 10 seconds starting from the next song.</p> <ul style="list-style-type: none"> * Press the TA SCAN key again to turn off. * The SCAN function is not supported in iPod® mode.
⑤ Folder Search : USB Mode	<p>While file is playing ► FOLDER, FOLDER key</p> <ul style="list-style-type: none"> • Searches the previous / next folder * If a folder is selected by pressing the TUNE knob, the first file within the selected folder will be played.

- RDS, No Bluetooth equipped model



Multimedia System

MENU : USB

In USB mode, press **MENU** key.



Repeat

Set [**1**RPT] through the **TUNE** knob or **1 RPT** key to repeat the current song.

* Press RPT again to turn off.

Folder Random

Set [**2**F.RDM] through the **TUNE** knob or **2 RDM** key to randomly play songs within the current folder.

* Press F.RDM again to turn off.

Folder Repeat

Set [**3**F.RPT] through the **TUNE** knob or **3** key to repeat songs within the current folder.

* Press F.RPT again to turn off.

All Random

Set [**4**A.RDM] through the **TUNE** knob or **4** key to randomly play all songs within the USB.

* Press A.RDM again to turn off.

Information

Set [**5**Info] through the **TUNE** knob or **5** key to display information of the current song.

* Press the **MENU** key to turn off info display.

Copy (if equipped)

Set [**6**Copy] through the **TUNE** knob or **6** key.

* This is used to copy the current song into My Music. You can play the copied Music in My Music mode.

* If another key is pressed while copying is in progress, a pop up asking you whether to cancel copying is displayed.

* If another media is connected or inserted (USB, iPod®, AUX) while copying is in progress, copying is canceled.

* Music will not be played while copying is in progress.

MENU : iPod®

In iPod mode, press **MENU** key.



Repeat

Set [**1 RPT**] through the **TUNE** knob or **1 RPT** key to repeat the current song.

* Press RPT again to turn repeat off.

Random

Set [**2 RDM**] through the **TUNE** knob or **2 RDM** key.

Plays all songs within the currently playing category in random order.

* Press RDM again to turn off.

Information

Set [**3 Info**] through the **TUNE** knob or **3** key.

Displays information of the current song.

* Press the **MENU** key to turn off info display.

Search

Set [**4 Search**] through the **TUNE** knob or **4** key.

Displays iPod® category list.

* Searching iPod® category is **MENU** key pressed, move to parent category.

MENU : My Music Mode (If equipped)

In My Music mode, press **MENU** key.



Repeat

Set [**1 RPT**] through the **TUNE** knob or **1 RPT** key.

Repeats the currently playing song.

* Press RPT again to turn repeat off.

Random

Set [**2 RDM**] through the **TUNE** knob or **2 RDM** key.

Plays all songs within the currently playing folder in random order.

* Press RDM again to turn random off.

Multimedia System

Information

Set [Info] through the TUNE knob or **3** key.

Displays information of the current song.

* Press the **MENU** key to turn off info display.

Delete

Set [Delete] through the TUNE knob or **4** key.

- Deletes currently playing file

In the play screen, pressing delete will delete the currently playing song.

- Deletes file from list

① Select the file you wish to delete by using the TUNE knob.

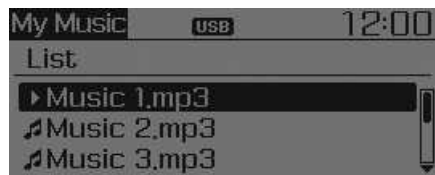

② Press the **MENU** key and select the delete menu to delete the selected file.

Delete All

Set [Del.All] through the TUNE knob or **5** key.

Deletes all songs of My Music.

Delete Selection

Press the **MENU** key ▶ Set [Del.Sel] through the TUNE knob or **6** key.

Songs within My Music are selected and deleted.

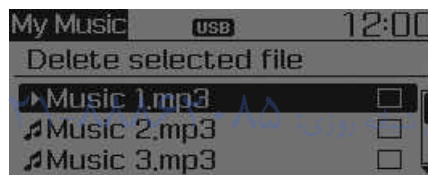

① Select the songs you wish to delete from the list.



② After selecting, press the **MENU** key and select the delete menu.

AUX

AUX is used to play external MEDIA currently connected with the AUX terminal.

AUX mode will automatically start when an external device is connected to the AUX terminal.

If an external device is connected, you can also press the **MEDIA** key to change to AUX mode.



* AUX mode cannot be started unless there is an external device connected to the AUX terminal.

Bluetooth® Wireless Technology Audio (If equipped)





What is Bluetooth® Wireless Technology?

Bluetooth® Wireless Technology allows devices to be connected in a short distance, including hands-free devices, stereo headsets, wireless remote controllers, etc. For more information, visit the *Bluetooth®* Wireless Technology website at www.Bluetooth.com

Before using *Bluetooth®* Wireless Technology audio features

- *Bluetooth®* Wireless Technology audio may not be supported depending on the compatibility of your *Bluetooth®* Wireless Technology mobile phone.
- In order to use *Bluetooth®* Wireless Technology audio, you must first pair and connect the *Bluetooth®* Wireless Technology mobile phone.

- *Bluetooth®* Wireless Technology audio can be used only when the [Audio Streaming] of Phone is turned .

- * Setting *Bluetooth®* Wireless Technology Audio Streaming : Press the  key ▶ Select [Phone] through the tune knob or  key ▶ Select [Audio Streaming] through the  ▶ Set  

Starting Bluetooth® Wireless Technology Audio

- Press the  key to change the mode in order of USB → AUX → My Music → BT Audio.
- If BT Audio is selected, *Bluetooth®* Wireless Technology audio will start playing.
- * Audio may not automatically start playing in some mobile phones.

Using the Bluetooth® Wireless Technology audio features

- Play / Stop

Press the  TUNE knob to play and pause the current song.





- * The play / pause functions may not be supported in some mobile phones.

Multimedia System

Making a call using the Steering wheel remote controller



Name	Description
① 	<ul style="list-style-type: none"> Each time this key is pressed, the mode is changed in order of FM1 → FM2 → FMA → AM → AMA → USB(iPod) → AUX (for DAB model) FM1 → FM2 → FMA → DAB1 → DAB2 → AM → USB(iPod) → AUX If the media is not connected or a disc is not inserted, corresponding modes will be disabled.
② 	Raises or lowers speaker volume.
③  key	Mutes audio volume.

* The actual feature in the vehicle may differ from the illustration.

Making a call using the Steering wheel remote controller (For Bluetooth equipped Model)



* The actual feature in the vehicle may differ from the illustration.

Name	Description
①	Mutes the microphone during a call.
②	<ul style="list-style-type: none"> Each time this key is pressed, the mode is changed in order of FM1 → FM2 → FMA → AM → AMA → USB(iPod) → AUX → My Music → BT Audio (for DAB model) FM1 → FM2 → FMA → DAB1 → DAB2 → AM → USB(iPod) → AUX → My Music → BT Audio If the media is not connected or a disc is not inserted, corresponding modes will be disabled.
③	Raises or lowers speaker volume.
④	<p>Places and transfers calls.</p> <ul style="list-style-type: none"> Check call history and making call <ol style="list-style-type: none"> Shortly press (under 0.8 seconds) the key on the steering remote controller. The call history list will be displayed on the screen. Press the key again to connect a call to the selected number. Redialing the most recently called number <ol style="list-style-type: none"> Press and hold (over 0.8 seconds) the key on the steering remote controller. The most recently called number is redialed.
⑤	Ends calls or cancels functions.

Multimedia System

Phone MENU

Press the  key to display three menus (Call History, Phone Book, Phone Setup).

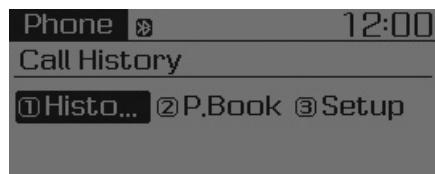

Call History

Press the  key ▶ Set [(1) History] through the  TUNE knob or  key.

The call history is displayed and can be used to select a number and make a call.

If call history does not exist, a screen asking whether to download call history is displayed. (The download feature may not be supported in some mobile phones)

Phone Book

Press the  key ▶ Set [(2) P. Book] through the  TUNE knob or  key.

The phone book is displayed and can be used to select a number and make a call.

* If more than one number is saved to one contact, then a screen showing the mobile phone number, Home and office number is displayed. Select the desired number to make the call.

* If phone book do not exist, a screen asking whether to download phone book is displayed. (The download feature may not be supported in some mobile phones)

Phone Setup

Press the  key ▶ Set [(3) Setup] through the  TUNE knob or  key.

The *Bluetooth*® Wireless Technology mobile phone setup screen is displayed. For more information, refer to “Phone Setup”.

Voice Recognition (If equipped)

Using Voice Recognition

Starting Voice Recognition

Shortly press the  key on the steering wheel. Say a command.



If prompt feedback is in [ON], then the system will say “Please say a command after the beep (BEEP)”

- If prompt feedback is in [OFF] mode, then the system will only say “(BEEP)”
- To change Prompt Feedback [On]/[Off], go to  [System] ▶ [Prompt Feedback]

Information

For proper recognition, say the command after the voice instruction and beep tone.

Contact List Best Practices

- 1) Do not store single-name entries (e.g., “Bob”, “Mom”, “Kim”, etc.). Instead, always use full names (including first and last names) for all contacts (e.g., use “Jacob Stevenson” instead of “Dad”).
- 2) Do not use abbreviations (i.e., use “Lieutenant” instead of “Lt.” or “Sergeant” instead of “Sgt.”).
- 3) Do not use acronyms (i.e., use “County Finance Department” instead of “CFD”).
- 4) Do not use special characters (e.g., “@”, “hyphen -”, “asterisk *”, “ampersand &”).
- 5) If a name is not recognized from the contact list, change it to a more descriptive name (e.g., use “Grandpa Joseph” instead of “Pa Joe”).

Skipping Prompt Messages

While prompt message is being stated ▶ Shortly press the  key on the steering remote controller

The prompt message is immediately ended and the beep tone will sound. After the “beep”, say the voice command.

Re-starting Voice Recognition

While system waits for a command ▶ Shortly press the  key on the steering remote controller

The command wait state is immediately ended and the beep tone will sound. After the “beep”, say the voice command.

Multimedia System

Ending Voice Recognition

While Voice Recognition is operating
 ▶ Press and hold the  key on the steering remote controller

Information

- While using voice command, pressing any steering wheel control or a different key will end voice command.
- When the system is waiting for a voice command, say “cancel” or “end” to end voice command.
- When the system is waiting for a voice command, press and hold the  key on the steering wheel to end voice command.

Voice Recognition and Phone Contact Tips :

The Hyundai Voice Recognition System may have difficulty understanding some accents or uncommon names.

When using Voice Recognition to place a call, speak in a moderate tone, with clear pronunciation To maximize the use of Voice Recognition, consider these guidelines when storing contacts:

- Do not store single-name entries (e.g., “Bob”, “Mom”, etc.). Instead, always use full names (including first and last names) for these contacts ^{تلفن}
- Do not use special characters (e.g., '@', '-', '*', '&', etc.)
- Do not use abbreviations (i.e., use “Lieutenant” instead of “Lt.”) or acronyms (i.e., use “County Finance Department” instead of “C. F. D.”; Be sure to say the name exactly as it is entered in the contacts list

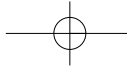
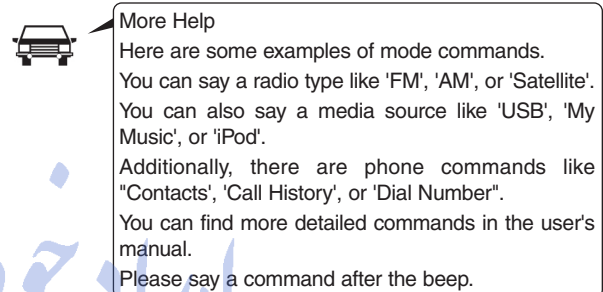
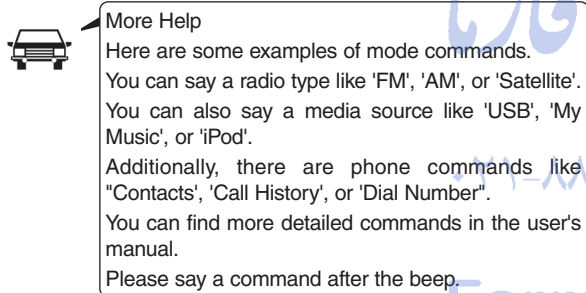
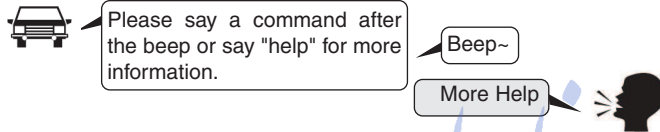

Illustration on using voice commands

- Starting voice command.

Shortly pressing the  key (under 0.8 seconds) :



- End voice command.

Shortly pressing the  key (under 0.8 seconds) :

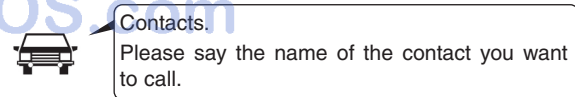
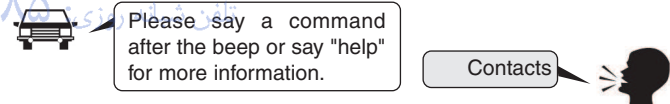

- Skipping Voice Recognition

Shortly pressing the  key (under 0.8 seconds) :

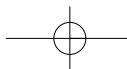
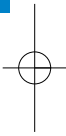
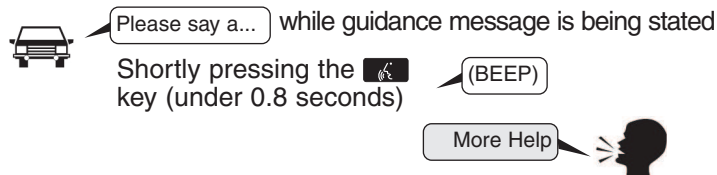

Multimedia System

Voice Command List

- Common Commands : These commands can be used in most operations. (However a few commands may not be available during certain operations)

Command	Function
More Help	Provides guidance on commands that can be used anywhere in the system.
Help	Provides guidance on commands that can be used within the current mode.
Call<Name>	Calls <Name> saved in Contacts Ex) Call "John Smith"
Call<Name> on Mobile	Calls <Name> to the number that is saved as "Mobile" in Contacts Ex) Call "John Smith" on Mobile
Call<Name> in Office	Calls <Name> to the number that is saved as "Office" in Contacts Ex) Call "John Smith" in Office
Call<Name> at Home	Calls <Name> to the number that is saved as "Home" in Contacts Ex) Call "John Smith" at Home
Call<Name> on Other	Calls <Name> to the number that is saved as "Other" in Contacts Ex) Call "John Smith" on Other
Phone	Provides guidance on Phone related commands. After saying this command, say "Favorites", "Call History", "Contacts" or "Dial Number" execute corresponding functions.
Favorites	Displays the Favorite screen.
Call History	Displays the Call History screen.

Command	Function
Contacts (Call by Name)	Displays the Contacts screen. After saying this command, say the name of a contact saved in the Contacts to automatically connect the call.
Dial Number	Displays the Dial number screen. After saying this command, you can say the number that you want to call.
Redial	Connects the most recently called number.
Tutorial	Provides guidance on how to use voice recognition and Bluetooth® connections.
Radio	<ul style="list-style-type: none"> • When listening to the radio, displays the next radio screen. (FM1 → FM2 → AM → XM1 → XM2 → XM3 → FM1) • When listening to a different mode, displays the most recently played radio screen. • When currently listening to the FM radio, maintains the current state. • When listening to a different mode, displays the most recently played FM screen.
FM1(FM One)	Displays the FM1 screen.
FM2(FM Two)	Displays the FM2 screen.
AM	Displays the AM screen.

Command	Function
FM Preset 1~6	Plays the most recently played broadcast saved in FM Preset 1~6
AM Preset 1~6	Plays the broadcast saved in AM Preset 1~6
FM 87.5~107.9	Plays the FM broadcast of the corresponding frequency.
AM 530~1701	Plays the AM broadcast of the corresponding frequency.
Media	Moves to the most recently played media screen.
USB	Plays USB music.
iPod	Plays iPod music.
My Music	Plays the music saved in the My Music.
AUX (Auxiliary)	Plays the connected external device.
Bluetooth® Audio	Plays the music saved in connected Bluetooth® device.
Mute	Mutes the sound

Command	Function
Please repeat	Repeats the most recent comment.
Mute	Mutes the sound.
Cancel (Exit)	Ends voice command.

FarmaSOS.com

Multimedia System

- **FM/AM radio Commands :** Commands available during FM, AM radio operation

Command	Function
Preset 1~6	Plays the broadcast station saved in Preset 1~6.
Scan	Scans receivable frequencies from the current broadcast and plays for 10 seconds each.
Preset Scan	Moves to the next preset from the current present and plays for 10 seconds each.
Information	Displays the information of the current broadcast.(This feature can be used when receiving RBDS broadcasts.)

- **Satellite radio Commands :** Commands that can be used while listening to Satellite Radio.

Command	Function
Channel 0~225	Plays the selected Satellite Radio channel.
Scan	Scans receivable channels from the current broadcast and plays for 10 seconds each.
Preset 1~6	Plays the broadcast saved in Preset 1~6.
Information	Displays the information of the current broadcast.

- **USB Commands :** Commands available during USB operation

Command	Function
Random	Randomly plays the files within the current folder.
Random Off	Cancel random play to play files in sequential order.
Repeat	Repeats the current file.
Repeat Off	Cancel repeat play to play files in sequential order.
Information	Displays the information screen of the current file.
Next Folder	Plays the first file in the next folder.
Previous Folder	Plays the first file in the previous folder.

- **iPod® Commands** : Commands available during iPod® operation

Command	Function
Random	Randomly plays the songs within the current category.
Random Off	Cancels random play to play songs in sequential order.
Repeat	Repeats the current song.
Repeat Off	Cancels repeat play to play songs in sequential order.

- **My Music Commands** : Commands available during My Music operation

Command	Function
Random	Randomly plays all saved files.
Random Off	Cancels random play to play files in sequential order.
Repeat	Repeats the current file.
Repeat Off	Cancels repeat play to play files in sequential order.
Delete	Deletes the current file. You will bypass an additional confirmation process.

- **Bluetooth® Wireless Technology Audio Commands** : Commands available during Bluetooth® Wireless Technology audio streaming from mobile phone operation Command Operation

Command	Function
Play	Plays the currently paused song.
Pause	Pauses the current song.

Driving your vehicle

Before driving	5-4	Electronic Stability Control (ESC)	5-55
Before entering the vehicle	5-4	Vehicle Stability Management	5-59
Before starting.....	5-4	Hill-Start Assist Control (HAC)	5-60
Ignition switch	5-6	Downhill Brake Control (DBC)	5-61
Key ignition switch.....	5-6	Emergency Stop Signal (ESS)	5-63
Engine Start/Stop button.....	5-11	Good braking practices	5-64
Manual transaxle	5-20	Four wheel drive (4WD)	5-65
Manual transaxle operation	5-20	4WD operation.....	5-66
Good driving practices.....	5-22	Emergency precautions.....	5-70
Automatic transaxle	5-24	ISG (Idle Stop and Go) system	5-72
Automatic transaxle operation	5-24	To activate the ISG system.....	5-72
Parking.....	5-29	To deactivate the ISG system	5-75
Good driving practices.....	5-29	ISG system malfunction.....	5-76
Dual clutch transmission	5-31	The battery sensor deactivation.....	5-77
Dual clutch transmission operation	5-31	Flex steering wheel	5-78
Parking.....	5-38	Drive mode integrated control system	5-80
Good driving practices.....	5-38	Blind spot detection system (BSD)	5-82
Braking system	5-40	BSD (Blind Spot Detection) /	
Power brakes	5-40	LCA (Lane Change Assist).....	5-83
Disc brakes wear indicator	5-41	RCTA (Rear Cross Traffic Alert)	5-86
Parking brake (hand type).....	5-41		
Electronic Parking Brake (EPB).....	5-43		
AUTO HOLD	5-49		
Anti-lock Brake System (ABS)	5-53		

Autonomous emergency braking (AEB)	5-90
System setting and activation.....	5-90
AEB warning message and system control.....	5-92
Sensor to detect the distance from the vehicle in front (front radar)	5-95
System malfunction.....	5-96
Limitation of the system	5-97
Speed limit information function (SLIF)	5-101
System setting and activation	5-102
Operation	5-102
Display	5-103
DRIVER'S ATTENTION	5-105
Lane keeping assist system (LKAS)	5-106
LKAS operation.....	5-107
DRIVER'S ATTENTION	5-111
LKAS malfunction	5-112
LKAS function change.....	5-113
Speed limit control system	5-115
Speed limit control operation	5-115
Cruise control (with speed limit control)	5-117
Cruise control operation	5-117
Cruise control	5-122
Cruise control operation	5-122
Special driving conditions	5-129
Hazardous driving conditions	5-129
Rocking the vehicle.....	5-129
Smooth cornering	5-130
Driving at night.....	5-130
Driving in the rain.....	5-130
Driving in flooded areas.....	5-131
Highway driving.....	5-131
Reducing the risk of a rollover	5-132
Winter driving	5-133
Snow or icy conditions.....	5-133
Winter Precautions.....	5-135
Trailer towing	5-138
If you decide to pull a trailer?.....	5-139
Trailer towing equipment	5-142
Driving with a trailer	5-143
Maintenance when towing a trailer	5-147
Vehicle weight	5-148
Overloading	5-148

WARNING

Carbon monoxide (CO) gas is toxic. Breathing CO can cause unconsciousness and death.

Engine exhaust contains carbon monoxide which cannot be seen or smelled.

Do not inhale engine exhaust.

If at any time you smell engine exhaust inside the vehicle, open the windows immediately. Exposure to CO can cause unconsciousness and death by asphyxiation.

Be sure the exhaust system does not leak.

The exhaust system should be checked whenever the vehicle is raised to change the oil or for any other purpose. If you hear a change in the sound of the exhaust or if you drive over something that strikes the underneath side of the vehicle, we recommend that the exhaust system be checked as soon as possible by an authorized HYUNDAI dealer.

Do not run the engine in an enclosed area.

Letting the engine idle in your garage, even with the garage door open, is a hazardous practice. Run the engine only long enough to start the engine and to move the vehicle out of the garage.

Avoid idling the engine for prolonged periods with people inside the vehicle.

If it is necessary to idle the engine for a prolonged period with people inside the vehicle, be sure to do so only in an open area with the air intake set at "Fresh" and fan control set to high so fresh air is drawn into the interior.

Keep the air intakes clear.

To assure proper operation of the ventilation system, keep the ventilation air intakes located in front of the windshield clear of snow, ice, leaves, or other obstructions.

If you must drive with the tailgate open:

Close all windows.

Open instrument panel air vents.

Set the air intake control at "Fresh", the air flow control at "Floor" or "Face", and the fan control set to high.

BEFORE DRIVING

Before entering the vehicle

- Be sure all windows, outside mirror(s), and outside lights are clean and unobstructed.
- Remove frost, snow, or ice.
- Visually check the tires for uneven wear and damage.
- Check under the vehicle for any sign of leaks.
- Be sure there are no obstacles behind you if you intend to back up.

Before starting

- Make sure the hood, the trunk, and the doors are securely closed and locked.
- Adjust the position of the seat and steering wheel.
- Adjust the inside and outside rearview mirrors.
- Verify all the lights work.
- Fasten your seatbelt. Check that all passengers have fastened their seatbelts.
- Check the gauges and indicators in the instrument panel and the messages on the instrument display when the ignition switch is in the ON position.
- Check that any items you are carrying are stored properly or fastened down securely.

WARNING

To reduce the risk of SERIOUS INJURY or DEATH, take the following precautions:

- **ALWAYS wear your seat belt. All passengers must be properly belted whenever the vehicle is moving. For more information, refer to “Seat Belts” in chapter 2.**
- **Always drive defensively. Assume other drivers or pedestrians may be careless and make mistakes.**
- **Stay focused on the task of driving. Driver distraction can cause accidents.**
- **Leave plenty of space between you and the vehicle in front of you.**

⚠ WARNING

NEVER drink or take drugs and drive.

Drinking or taking drugs and driving is dangerous and may result in an accident and **SERIOUS INJURY** or **DEATH**.

Drunk driving is the number one contributor to the highway death toll each year. Even a small amount of alcohol will affect your reflexes, perceptions and judgment. Just one drink can reduce your ability to respond to changing conditions and emergencies and your reaction time gets worse with each additional drink.

Driving while under the influence of drugs is as dangerous or more dangerous than driving under the influence of alcohol.

(Continued)

(Continued)

You are much more likely to have a serious accident if you drink or take drugs and drive. If you are drinking or taking drugs, don't drive. Do not ride with a driver who has been drinking or taking drugs. Choose a designated driver or call a taxi.

تلفن شبانه روزی: ۰۲۱-۸۸۸۶۲۰۸۵

FarmaSOS.com

IGNITION SWITCH

WARNING

To reduce the risk of **SERIOUS INJURY** or **DEATH**, take the following precautions:

- **NEVER** allow children or any person who is unfamiliar with the vehicle to touch the ignition switch or related parts. Unexpected and sudden vehicle movement can occur.
- **NEVER** reach through the steering wheel for the ignition switch, or any other control, while the vehicle is in motion. The presence of your hand or arm in this area may cause a loss of vehicle control resulting in an accident.

Key ignition switch

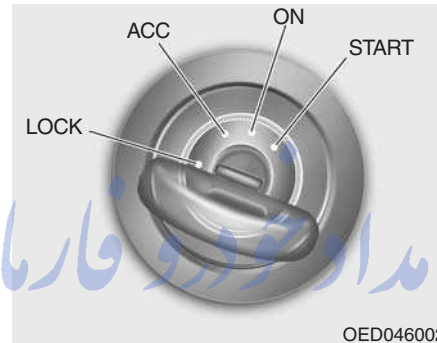

WARNING

- **NEVER** turn the ignition switch to the **LOCK** or **ACC** position while the vehicle is in motion except in an emergency. This will result in the engine turning off and loss of power assist for the steering and brake systems. This may lead to loss of directional control and braking function, which could cause an accident.

(Continued)

(Continued)

- Before leaving the driver's seat, always make sure the shift lever is in 1st gear (for manual transaxle vehicle) or P (Park, for automatic transaxle /dual clutch transmission vehicle) position, apply the parking brake, and turn ignition switch to the **LOCK** position.

Unexpected vehicle movement may occur if these precautions are not followed.

Key ignition switch positions

Switch Position	Action	Notes
LOCK	<p>To turn the ignition switch to the LOCK position, push the key in slightly at the ACC position and turn the key towards the LOCK position.</p> <p>The ignition key can be removed in the LOCK position.</p> <p>The steering wheel locks to protect the vehicle from theft. (if equipped)</p>	
ACC	<p>Electrical accessories are usable.</p> <p>The steering wheel unlocks.</p>	<p>If difficulty is experienced turning the ignition switch to the ACC position, turn the key while turning the steering wheel right and left to release tension.</p>
ON	<p>This is the normal key position when the engine has started.</p> <p>All features and accessories are usable.</p> <p>The warning lights can be checked when you turn the ignition switch from ACC to ON.</p>	<p>Do not leave the ignition switch in the ON position when the engine is not running to prevent the battery from discharging.</p>
START	<p>To start the engine, turn the ignition switch to the START position.</p> <p>The switch returns to the ON position when you let go of the key.</p>	<p>The engine will crank until you release the key.</p>

Starting the engine

WARNING

- **Always wear appropriate shoes when operating your vehicle. Unsuitable shoes, such as high heels, ski boots, sandals, flip-flops, etc., may interfere with your ability to use the brake, accelerator and clutch pedals.**
- **Do not start the vehicle with the accelerator pedal depressed. The vehicle can move and lead to an accident.**
- **Wait until the engine rpm is normal. The vehicle may suddenly move if the brake pedal is released when the rpm is high.**

Starting the gasoline engine

Vehicle with manual transaxle:

1. Make sure the parking brake is applied.
2. Make sure the shift lever is in neutral.
3. Depress the clutch and brake pedals.
4. Turn the ignition switch to the START position. Hold the key (maximum of 10 seconds) until the engine starts and release it.

Vehicle with automatic transaxle/dual clutch transmission:

1. Make sure the parking brake is applied.
2. Make sure the shift lever is in P (Park).
3. Depress the brake pedal.
4. Turn the ignition switch to the START position. Hold the key (maximum of 10 seconds) until the engine starts and release it.

تلفن شبانه روزی: ۰۲۱-۸۸۸۶۲۰۸۵

FarmaSOS.com

i Information

- **Do not wait for the engine to warm up while the vehicle remains stationary.**



Start driving at moderate engine speeds. (Steep accelerating and decelerating should be avoided.)

- **Always start the vehicle with your foot on the brake pedal. Do not depress the accelerator while starting the vehicle. Do not race the engine while warming it up.**



Starting the diesel engine

To start the diesel engine when the engine is cold, it has to be pre-heated before starting the engine and then have to be warmed up before starting to drive.

Vehicle with manual transaxle:

1. Make sure the parking brake is applied.
2. Make sure the shift lever is in neutral.
3. Depress the clutch and brake pedals.
4. Turn the ignition switch to the ON position to pre-heat the engine. The glow indicator light () will illuminate.
5. When the glow indicator light () goes out, turn the key ignition switch to the START position. Hold the key (maximum of 10 seconds) until the engine starts and release it.

Vehicle with automatic transaxle:

1. Make sure the parking brake is applied.
2. Make sure the shift lever is in P (Park).
3. Depress the brake pedal.
4. Turn the ignition switch to the ON position to pre-heat the engine. The glow indicator light () will illuminate.
5. When the glow indicator light () goes out, turn the key ignition switch to the START position. Hold the key (maximum of 10 seconds) until the engine starts and release it.

NOTICE

If the engine does not start within 10 seconds after preheating is completed, turn the ignition switch once more to the LOCK position and wait for 10 seconds. Then turn the ignition switch to the ON position in order to pre-heat the engine again.

Starting and stopping the engine for turbocharger intercooler

1. Do not race or accelerate the engine immediately after starting the engine.

If the engine is cold, idle for several seconds before sufficient lubrication is ensured in the turbo charger unit.

2. After high speed or extended driving that requires heavy engine load, idle the engine about 1 minute before turning the engine off.

This idle time will allow the turbocharger to cool prior to shutting the engine off.

NOTICE

Do not turn off the engine immediately after it has been subjected to a heavy load. Doing so may cause severe damage to the engine or turbo charger unit.

امداد خودرو فارما

تلفن شبانه روزی: ۰۲۱-۸۸۸۶۲۰۸۵

FarmaSOS.com

NOTICE

To prevent damage to the vehicle:

- Do not hold the ignition key in the START position for more than 10 seconds. Wait 5 to 10 seconds before trying again.
- Do not turn the ignition switch to the START position with the engine running. It may damage the starter.
- If traffic and road conditions permit, you may put the shift lever in the N (Neutral) position while the vehicle is still moving and turn the ignition switch to the START position in an attempt to restart the engine.
- Do not push or tow your vehicle to start the engine.

Engine Start/Stop button



Whenever the front door is opened, the Engine Start/Stop button will illuminate and will go off 30 seconds after the door is closed.

⚠ WARNING

To turn the engine off in an emergency:

Press and hold the Engine Start/Stop button for more than two seconds OR Rapidly press and release the Engine Start/Stop button three times (within three seconds).

If the vehicle is still moving, you can restart the engine without depressing the brake pedal by pressing the Engine Start/Stop button with the shift lever in the N (Neutral) position.



⚠ WARNING

- NEVER press the Engine Start/Stop button while the vehicle is in motion except in an emergency. This will result in the engine turning off and loss of power assist for the steering and brake systems. This may lead to loss of directional control and braking function, which could cause an accident.
- Before leaving the driver's seat, always make sure the shift lever is in the P (Park) position, set the parking brake, press the Engine Start/Stop button to the OFF position, and take the Smart Key with you. Unexpected vehicle movement may occur if these precautions are not followed.



FarmaSOS.com

Engine Stop/Start button positions

- Vehicle with manual transaxle



Button Position	Action	Notes
<p>OFF</p>  <p>The image shows a circular button with 'OFF', 'ACC', and 'ON' markings around the perimeter. The center of the button has 'ENGINE START STOP' written on it. The 'OFF' position is highlighted.</p>	<p>To turn off the engine, stop the vehicle and then press the Engine Start/Stop button. The steering wheel locks to protect the vehicle from theft. (if equipped)</p>	<p>If the steering wheel is not locked properly when you open the driver's door, the warning chime will sound.</p>
<p>ACC</p>  <p>The image shows the same circular button as above, but the 'ACC' position is highlighted.</p>	<p>Press the Engine Start/Stop button when the button is in the OFF position without depressing the clutch pedal. Electrical accessories are usable. The steering wheel unlocks.</p>	<p>If you leave the Engine Start/Stop button in the ACC position for more than one hour, the battery power will turn off automatically to prevent the battery from discharging. If the steering wheel doesn't unlock properly, the Engine Start/Stop button will not work. Press the Engine Start/Stop button while turning the steering wheel right and left to release tension.</p>

- Vehicle with manual transaxle



Button Position	Action	Notes
<p data-bbox="254 296 299 320">ON</p>  <p>The image shows a circular engine start/stop button with three positions: OFF, ACC, and ON. The ON position is highlighted in blue. The text 'ENGINE START STOP' is visible in the center.</p>	<p data-bbox="414 302 925 386">Press the Engine Start/Stop button while it is in the ACC position without depressing the clutch pedal.</p> <p data-bbox="414 392 913 450">The warning lights can be checked before the engine is started.</p>	<p data-bbox="956 302 1483 386">Do not leave the Engine Start/Stop button in the ON position when the engine is not running to prevent the battery from discharging.</p>
<p data-bbox="232 603 320 627">START</p>  <p>The image shows the same engine start/stop button. The text 'ENGINE START STOP' is visible in the center.</p>	<p data-bbox="414 609 925 693">To start the engine, depress the clutch and brake pedals and press the Engine Start/Stop button with the shift lever in neutral.</p>	<p data-bbox="956 609 1443 717">If you press the Engine Start/Stop button without depressing the clutch pedal, the engine does not start and the Engine Start/Stop button changes as follows:</p> <p data-bbox="956 723 1389 753">OFF → ACC → ON → OFF or ACC</p>

Engine Stop/Start button positions

- Vehicle with automatic transaxle / dual clutch transmission

Button Position	Action	Notes
<p style="text-align: center;">OFF</p>  <p>The image shows a circular button with 'ENGINE START STOP' in the center. The outer ring has 'OFF', 'ACC', and 'ON' markings. The 'OFF' position is highlighted.</p>	<p>To turn off the engine, press the Engine Start/Stop button with shift lever in P (Park). When you press the Engine Start/Stop button without the shift lever in P (Park), the Engine Start/Stop button does not turn to the OFF position, but turns to the ACC position.</p> <p>The steering wheel locks to protect the vehicle from theft. (if equipped)</p>	<p>If the steering wheel is not locked properly when you open the driver's door, the warning chime will sound.</p>
<p style="text-align: center;">ACC</p>  <p>The image shows the same circular button. The 'ACC' position is highlighted.</p>	<p>Press the Engine Start/Stop button when the button is in the OFF position without depressing the brake pedal.</p> <p>Electrical accessories are usable.</p> <p>The steering wheel unlocks.</p>	<p>If you leave the Engine Start/Stop button in the ACC position for more than one hour, the battery power will turn off automatically to prevent the battery from discharging.</p> <p>If the steering wheel doesn't unlock properly, the Engine Start/Stop button will not work. Press the Engine Start/Stop button while turning the steering wheel right and left to release tension.</p>

- Vehicle with automatic transaxle / dual clutch transmission

Button Position	Action	Notes
<p data-bbox="254 296 299 317">ON</p>  <p>The image shows a circular engine start/stop button with a silver ring. The ring has three positions: OFF (top), ACC (left), and ON (right). The ON position is highlighted in blue. The center of the button has the text 'ENGINE START STOP'.</p>	<p data-bbox="417 302 926 386">Press the Engine Start/Stop button while it is in the ACC position without depressing the brake pedal.</p> <p data-bbox="417 394 910 450">The warning lights can be checked before the engine is started.</p>	<p data-bbox="959 302 1485 386">Do not leave the Engine Start/Stop button in the ON position when the engine is not running to prevent the battery from discharging.</p>
<p data-bbox="232 606 320 628">START</p>  <p>The image shows the same circular engine start/stop button. The ring is in the START position, which is between OFF and ACC. The center of the button has the text 'ENGINE START STOP'.</p>	<p data-bbox="417 606 939 719">To start the engine, depress the brake pedal and press the Engine Start/Stop button with the shift lever in the P (Park) or in the N (Neutral) position.</p> <p data-bbox="417 728 893 783">For your safety, start the engine with the shift lever in the P (Park) position.</p>	<p data-bbox="959 606 1443 719">If you press the Engine Start/Stop button without depressing the brake pedal, the engine does not start and the Engine Start/Stop button changes as follows:</p> <p data-bbox="959 728 1389 756">OFF → ACC → ON → OFF or ACC</p>

Starting the engine

WARNING

- Always wear appropriate shoes when operating your vehicle. Unsuitable shoes, such as high heels, ski boots, sandals, flip-flops, etc., may interfere with your ability to use the brake, accelerator and clutch pedals.
- Do not start the vehicle with the accelerator pedal depressed. The vehicle can move and lead to an accident.
- Wait until the engine rpm is normal. The vehicle may suddenly move if the brake pedal is released when the rpm is high.

Information

- The engine will start by pressing the Engine Start/Stop button, only when the smart key is in the vehicle.
- Even if the smart key is in the vehicle, if it is far away from the driver, the engine may not start.
- When the Engine Start/Stop button is in the ACC or ON position, if any door is open, the system checks for the smart key. If the smart key is not in the vehicle, the " " indicator will blink and the warning "Key not in vehicle" will come on, and if all doors are closed, the chime will also sound for about 5 seconds. Keep the smart key in the vehicle when using the ACC position or if the vehicle engine is ON.

Starting the gasoline engine

Vehicle with manual transaxle:

1. Always carry the smart key with you.
2. Make sure the parking brake is applied.
3. Make sure the shift lever is in neutral.
4. Depress the clutch and brake pedals.
5. Press the Engine Start/Stop button.

Vehicle with automatic transaxle/dual clutch transmission:

1. Always carry the smart key with you.
2. Make sure the parking brake is applied.
3. Make sure the shift lever is in P (Park).
4. Depress the brake pedal.
5. Press the Engine Start/Stop button.

i Information

- **Do not wait for the engine to warm up while the vehicle remains stationary.**

Start driving at moderate engine speeds. (Steep accelerating and decelerating should be avoided.)

- **Always start the vehicle with your foot on the brake pedal. Do not depress the accelerator while starting the vehicle. Do not race the engine while warming it up.**

Starting the diesel engine

To start the diesel engine when the engine is cold, it has to be pre-heated before starting the engine and then have to be warmed up before starting to drive.

Vehicle with manual transaxle:

1. Always carry the smart key with you.
2. Make sure the parking brake is applied.
3. Make sure the shift lever is in neutral.
4. Depress the clutch and brake pedal.
5. Press the Engine Start/Stop button.
6. Continue depressing the brake pedal until the glow indicator light (⏻) goes out.
7. When the glow indicator light (⏻) goes out, the engine will start.

Vehicle with automatic transaxle:

1. Always carry the smart key with you.
2. Make sure the parking brake is applied.
3. Make sure the shift lever is in P (Park).
4. Depress the brake pedal.
5. Press the Engine Start/Stop button.
6. Continue depressing the brake pedal until the glow indicator light (⏻) goes out.
7. When the glow indicator light (⏻) goes out, the engine will start.

NOTICE

If the Engine Start/Stop button is pressed while the engine is pre-heating, the engine may start.

Starting and stopping the engine for turbocharger intercooler

1. Do not race or accelerate the engine immediately after starting the engine.

If the engine is cold, idle for several seconds before sufficient lubrication is ensured in the turbo charger unit.

2. After high speed or extended driving that requires heavy engine load, idle the engine about 1 minute before turning the engine off. This idle time will allow the turbocharger to cool prior to shutting the engine off.

NOTICE

Do not turn off the engine immediately after it has been subjected to a heavy load. Doing so may cause severe damage to the engine or turbo charger unit.

NOTICE

To prevent damage to the vehicle:

- **If the engine stalls while you are in motion, do not attempt to move the shift lever to the P (Park) position.**

If traffic and road conditions permit, you may put the shift lever in the N (Neutral) position while the vehicle is still moving and press the Engine Start/Stop button in an attempt to restart the engine.

- **Do not push or tow your vehicle to start the engine.** تلفن شبانه روزی: ۰۲۱۰۰۰۰۰۰۰۰۰۰

NOTICE

To prevent damage to the vehicle:

Do not press the Engine Start/Stop button for more than 10 seconds except when the stop lamp fuse is blown.

When the stop lamp fuse is blown, you can't start the engine normally. Replace the fuse with a new one. If you are not able to replace the fuse, you can start the engine by pressing and holding the Engine Start/Stop button for 10 seconds with the Engine Start/Stop button in the ACC position.

For your safety always depress the brake and/or clutch pedal before starting the engine.

FarmaSOS.com

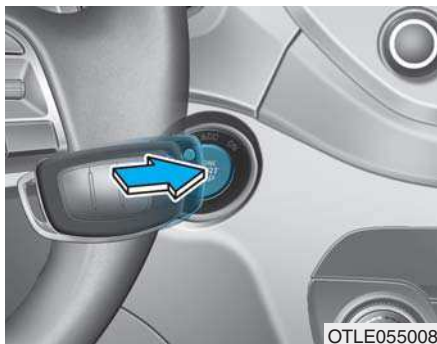

i Information

If the smart key battery is weak or the smart key does not work correctly, you can start the engine by pressing the Engine Start/Stop button with the smart key in the direction of the picture above.

امداد خودرو فارما

تلفن شبانه روزی: ۰۲۱-۸۸۸۶۲۰۸۵

FarmaSOS.com

MANUAL TRANSAXLE (IF EQUIPPED)

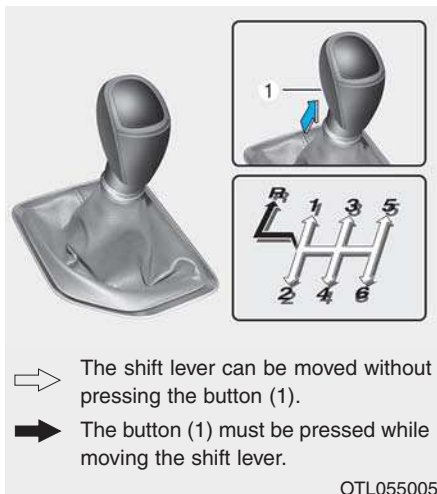

OTL055005

Manual transaxle operation

The manual transaxle has 6 forward gears. The transaxle is fully synchronized in all forward gears so shifting to either a higher or a lower gear is easily accomplished.

WARNING

Before leaving the driver's seat, always make sure the shift lever is in 1st gear when the vehicle is parked on a uphill and in R (Reverse) on a downhill, set the parking brake, and place the ignition switch in the LOCK/OFF position. Unexpected vehicle movement may occur if these precautions are not followed.

To shift to R (Reverse), make sure the vehicle has completely stopped, and then move the shift lever to neutral before moving into R (Reverse).

When you've come to a complete stop and it's hard to shift into 1st gear or R (Reverse):

1. Put the shift lever in neutral and release the clutch pedal.
2. Depress the clutch pedal, and then shift into first or R (Reverse) gear.

Information

During cold weather, shifting may be difficult until the transaxle lubricant has warmed up.

Using the clutch

The clutch pedal should be depressed all the way to the floor before:

- Starting the engine
The engine will not start without depressing the clutch pedal.
- Shifting

When releasing the clutch pedal, release it slowly. The clutch pedal should always be released while driving.

NOTICE

To prevent unnecessary wear or damage to the clutch:

- **Do not rest your foot on the clutch pedal while driving.**
- **Do not hold the vehicle with the clutch on an incline, while waiting for the traffic light, etc.**
- **Always depress the clutch pedal down fully to prevent noise or damage.**
- **Do not start with the 2nd (second) gear engaged except when you start on a slippery road.**

تلفن شبانه روزی: ۰۲۱-۸۸۸۸۸۸۸۸

FarmaSOS.com

Downshifting

Downshift when you must slow down in heavy traffic or drive up a steep hill to prevent engine load.

Also, downshifting reduces the chance of stalling and can accelerate when you need to increase your speed again.

When the vehicle is going downhill, downshifting helps maintain safe speed by providing brake power from the engine and enables less wear on the brakes.

NOTICE

To prevent damage to the engine, clutch and transaxle:

- **When downshifting from 5th gear to 4th gear, be careful not to inadvertently push the shift lever sideways engaging the 2nd gear. A drastic downshift may cause the engine speed to increase to the point the tachometer will enter the red-zone.**
- **Do not downshift more than two gear at a time or downshift the gear when the engine is running at high speed (5,000 RPM or higher). Such a downshifting may damage the engine, clutch and the transaxle.**

Good driving practices

- Never take the vehicle out of gear and coast down a hill. This is extremely dangerous.
- Don't "ride" the brakes. This can cause the brakes and related parts to overheat and malfunction.

When you are driving down a long hill, slow down and shift to a lower gear. Engine braking will help slow down the vehicle.

- Slow down before shifting to a lower gear. This will help avoid over-revving the engine, which can cause damage.
- Slow down when you encounter cross winds. This gives you much better control of your vehicle.
- Be sure the vehicle is completely stopped before you shift into R (Reverse) to prevent damage to the transaxle.

- Exercise extreme caution when driving on a slippery surface. Be especially careful when braking, accelerating or shifting gears. On a slippery surface, an abrupt change in vehicle speed can cause the drive wheels to lose traction and may cause loss of vehicle control resulting in an accident

WARNING

Do not use the engine brake (shifting from a higher gear to lower gear) rapidly on slippery roads. The vehicle may slip causing an accident.

⚠ WARNING

To reduce the risk of **SERIOUS INJURY** or **DEATH**:

- **ALWAYS** wear your seatbelt. In a collision, an unbelted occupant is significantly more likely to be seriously injured or killed than a properly belted occupant.
- Avoid high speeds when cornering or turning.
- Do not make quick steering wheel movements, such as sharp lane changes or fast, sharp turns.
- The risk of rollover is greatly increased if you lose control of your vehicle at highway speeds.
- Loss of control often occurs if two or more wheels drop off the roadway and the driver over steers to reenter the roadway.

(Continued)

(Continued)

- In the event your vehicle leaves the roadway, do not steer sharply. Instead, slow down before pulling back into the travel lanes.
- **HYUNDAI** recommends you follow all posted speed limits.



امداد خودرو فارما

تلفن شبانه روزی: ۰۲۱-۸۸۸۶۲۰۸۵

FarmaSOS.com

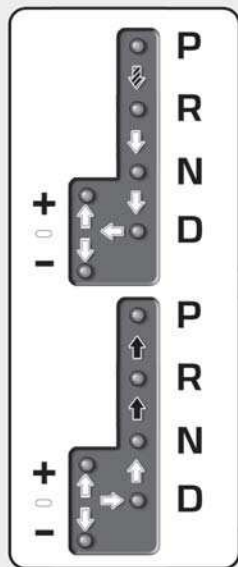
AUTOMATIC TRANSAXLE (IF EQUIPPED)



-  Depress the brake pedal and press the shift button while moving the shift lever.
-  Press the shift button while moving the shift lever.
-  The shift lever can freely operate.

Automatic transaxle operation

The automatic transaxle has six forward speeds and one reverse speed. The individual speeds are selected automatically in the D (Drive) position.

OTL055006

WARNING

To reduce the risk of serious injury or death:

- **ALWAYS** check the surrounding areas near your vehicle for people, especially children, before shifting a vehicle into D (Drive) or R (Reverse).
- Before leaving the driver's seat, always make sure the shift lever is in the P (Park) position, then set the parking brake, and place the ignition switch in the LOCK/OFF position. Unexpected and sudden vehicle movement can occur if these precautions are not followed.
- Do not use the engine brake (shifting from a high gear to lower gear) rapidly on slippery roads. The vehicle may slip causing an accident.

Transaxle ranges

The indicator in the instrument cluster displays the shift lever position when the ignition switch is in the ON position.

امداد خودرو فارما

تلفن شبانه روزی: ۰۲۱-۸۸۸۶۲۰۸۵

FarmaSOS.com

P (Park)

Always come to a complete stop before shifting into P (Park).

To shift from P (Park), you must depress firmly on the brake pedal and make sure your foot is off the accelerator pedal.

If you have done all of the above and still cannot shift the lever out of P (Park), see "Shift-Lock Release" in this chapter.

The shift lever must be in P (Park) before turning the engine off.

WARNING

- Shifting into P (Park) while the vehicle is in motion may cause you to lose control of the vehicle.
- After the vehicle has stopped, always make sure the shift lever is in P (Park), apply the parking brake, and turn the engine off.
- Do not use the P (Park) position in place of the parking brake.

R (Reverse)

Use this position to drive the vehicle backward.

NOTICE

Always come to a complete stop before shifting into or out of R (Reverse); you may damage the transaxle if you shift into R (Reverse) while the vehicle is in motion.

N (Neutral)

The wheels and transaxle are not engaged.

Use N (Neutral) if you need to restart a stalled engine, or if it is necessary to stop with the engine ON. Shift into P (Park) if you need to leave your vehicle for any reason.

Always depress the brake pedal when you are shifting from N (Neutral) to another gear.

! WARNING

Do not shift into gear unless your foot is firmly on the brake pedal. Shifting into gear when the engine is running at high speed can cause the vehicle to move very rapidly. You could lose control of the vehicle and hit people or objects.

D (Drive)

This is the normal driving position. The transaxle will automatically shift through a 6-gear sequence, providing the best fuel economy and power.

For extra power when passing another vehicle or driving uphill, depress the accelerator fully. The transaxle will automatically downshift to the next lower gear (or gears, as appropriate).

The DRIVE MODE switch, located on the shift lever console, allows the driver to switch from NORMAL mode to SPORT mode. (if equipped)

For more information, refer to "Drive Mode Integrated Control System" later in this chapter.

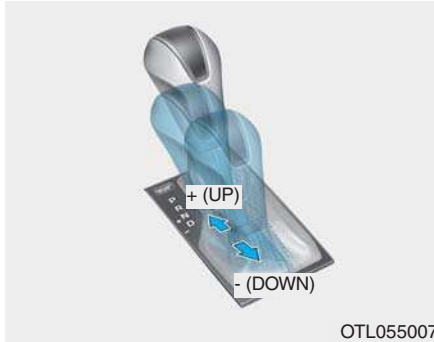

Sports mode

Whether the vehicle is stationary or in motion, sports mode is selected by pushing the shift lever from the D (Drive) position into the manual gate. To return to D (Drive) range operation, push the shift lever back into the main gate.

In Sports Mode, moving the shift lever backwards and forwards will allow you to select the desired range of gears for the current driving conditions.

+ (Up) : Push the lever forward once to shift up one gear.

- (Down) : Pull the lever backwards once to shift down one gear.

i Information

- Only the six forward gears can be selected. To reverse or park the vehicle, move the shift lever to the R (Reverse) or P (Park) position as required.
- Downshifts are made automatically when the vehicle slows down. When the vehicle stops, 1st gear is automatically selected.
- When the engine rpm approaches the red zone the transaxle will upshift automatically.

(Continued)

(Continued)

- If the driver presses the lever to + (Up) or - (Down) position, the transaxle may not make the requested gear change if the next gear is outside of the allowable engine rpm range. The driver must execute upshifts in accordance with road conditions, taking care to keep the engine rpms below the red zone.
- When driving on a slippery road, push the shift lever forward into the + (Up) position. This causes the transaxle to shift into the 2nd gear which is better for smooth driving on a slippery road. Push the shift lever to the - (Down) side to shift back to the 1st gear.

Shift-lock system

For your safety, the automatic transaxle has a shift-lock system which prevents shifting the transaxle from P (Park) into R (Reverse) unless the brake pedal is depressed.

To shift the transaxle from P (Park) into R (Reverse):

1. Depress and hold the brake pedal.
2. Start the engine or place the ignition switch in the ON position.
3. Move the shift lever.

Shift-lock release

If the shift lever cannot be moved from the P (Park) position into R (Reverse) position with the brake pedal depressed, continue depressing the brake, and then do the following:



1. Place the ignition switch in the LOCK/OFF position.
2. Apply the parking brake.
3. Carefully remove the cap (1) covering the shift-lock access hole.
4. Insert a tool (e.g. flathead screwdriver) into the access hole and press down on the tool.
5. Move the shift lever while holding down the screwdriver.
6. Remove the tool from the shiftlock release access hole then install the cap.
7. Depress the brake pedal, and then restart the engine.

If you need to use the shift-lock release, we recommend that the system be inspected by an authorized HYUNDAI dealer immediately.

Ignition key interlock system (if equipped)

The ignition key cannot be removed unless the shift lever is in the P (Park) position.

Parking

Always come to a complete stop and continue to depress the brake pedal. Move the shift lever into the P (Park) position, apply the parking brake, and place the ignition switch in the LOCK/OFF position. Take the Key with you when exiting the vehicle.

⚠ WARNING

When you stay in the vehicle with the engine running, be careful not to depress the accelerator pedal for a long period of time. The engine or exhaust system may overheat and start a fire.

The exhaust gas and the exhaust system are very hot. Keep away from the exhaust system components.

Do not stop or park over flammable materials, such as dry grass, paper or leaves. They may ignite and cause a fire.

Good driving practices

- Never move the shift lever from P (Park) or N (Neutral) to any other position with the accelerator pedal depressed.
- Never move the shift lever into P (Park) when the vehicle is in motion.

Be sure the vehicle is completely stopped before you attempt to shift into R (Reverse) or D (Drive).

- Do not move the shift lever to N (Neutral) when driving. Doing so may result in an accident because of a loss of engine braking and the transaxle could be damaged.
- Do not drive with your foot resting on the brake pedal. Even light, but consistent pedal pressure can result in the brakes overheating, brake wear and possibly even brake failure.
- When driving in sports mode, slow down before shifting to a lower gear. Otherwise, the lower gear may not be engaged if the engine rpms are outside of the allowable range.

- Always apply the parking brake when leaving the vehicle. Do not depend on placing the transaxle in P (Park) to keep the vehicle from moving.
- Exercise extreme caution when driving on a slippery surface. Be especially careful when braking, accelerating or shifting gears. On a slippery surface, an abrupt change in vehicle speed can cause the drive wheels to lose traction and may cause loss of vehicle control resulting in an accident
- Optimum vehicle performance and economy is obtained by smoothly depressing and releasing the accelerator.

WARNING

To reduce the risk of **SERIOUS INJURY** or **DEATH**:

- **ALWAYS** wear your seatbelt. In a collision, an unbelted occupant is significantly more likely to be seriously injured or killed than a properly belted occupant.
- Avoid high speeds when cornering or turning.
- Do not make quick steering wheel movements, such as sharp lane changes or fast, sharp turns.
- The risk of rollover is greatly increased if you lose control of your vehicle at highway speeds.
- Loss of control often occurs if two or more wheels drop off the roadway and the driver over steers to reenter the roadway.



(Continued)

(Continued)

- In the event your vehicle leaves the roadway, do not steer sharply. Instead, slow down before pulling back into the travel lanes.
- HYUNDAI recommends you follow all posted speed limits.

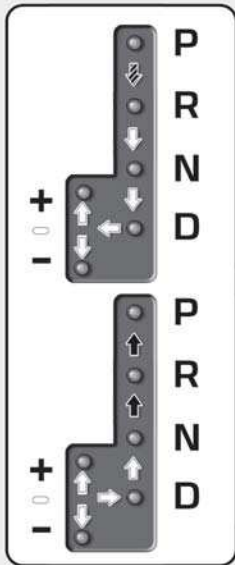
DUAL CLUTCH TRANSMISSION (IF EQUIPPED)



-  Depress the brake pedal and press the shift button while moving the shift lever.
-  Press the shift button while moving the shift lever.
-  The shift lever can freely operate.

OTL055006

Dual clutch transmission operation

The dual clutch transmission has seven forward speeds and one reverse speed.

The individual speeds are selected automatically in the D (Drive) position.

⚠ WARNING

To reduce the risk of serious injury or death:

- **ALWAYS** check the surrounding areas near your vehicle for people, especially children, before shifting a vehicle into D (Drive) or R (Reverse).
- **Before leaving the driver's seat, always make sure the shift lever is in the P (Park) position, then set the parking brake, and place the ignition switch in the LOCK/OFF position. Unexpected and sudden vehicle movement can occur if these precautions are not followed.**

(Continued)

(Continued)

- **Do not use the engine brake (shifting from a high gear to lower gear) rapidly on slippery roads. The vehicle may slip causing an accident.**

- The dual clutch transmission gives the driving feel of a manual transaxle, yet provides the ease of a fully automatic transaxle. Unlike a traditional automatic transaxle, the gear shifting can be felt (and heard) on the dual clutch transmission.
 - Think of it as an automatically shifting manual transaxle.
 - Shift into Drive range and get fully automatic shifting, similar to a conventional automatic transaxle.

- Dual clutch transmission adopts dry-type dual clutch, which is different from torque converter of automatic transaxle, and shows better acceleration performance during driving. But, initial launch might be little bit slower than Automatic Transaxle.
- The dry-type clutch transfers torque and provides a direct driving feeling which may feel different from a conventional automatic transaxle with a torque converter. This may be more noticeable when starting from a stop or low vehicle speed.
- When rapidly accelerating at low vehicle speed, engine could rev at high rpm depending on vehicle drive condition.
- For smooth launch uphill, press down the accelerator pedal smoothly depending on the current conditions.
- If you release your foot from the accelerator pedal at low vehicle speed, you may feel strong engine brake, which is similar to manual transaxle.

- When driving downhill, you may use Sports Mode to downshift to a lower gear in order to control your speed without using the brake pedal excessively.
- When you turn the engine on and off, you may hear clicking sounds as the system goes through a self test. This is a normal sound for the Dual clutch transmission.

NOTICE

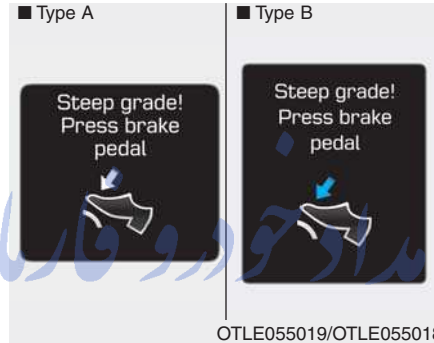

- To hold the vehicle on a hill use the foot brake or the parking brake. If the vehicle is held by applying the accelerator pedal on a hill the clutch and transmission will be overheated resulting in damage.

At this time, a warning message will appear on the LCD display and you may feel a vibration.

(Continued)

(Continued)

- If the clutch becomes overheated by excessive use of the clutch to hold on a hill, you may notice a shudder feeling and a blinking display on the instrument cluster. When this occurs, the clutch is disabled until the clutch cools to normal temperatures. If this occurs, pull over to a safe location, shift into P (Park) and apply the foot brake for a few minutes.
- If the LCD warning is active, the foot brake must be applied.
- Ignoring the warnings can lead to damage to the transmission.
- If the display continues to blink, for your safety, we recommend that you contact an authorized HYUNDAI dealer and have the system checked.

(Continued)

(Continued)

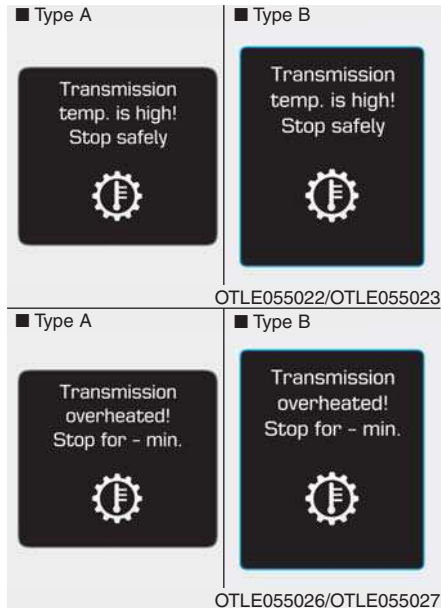

- Under certain conditions such as repeated launch on steep grades, the clutch in the transmission could overheat. When the clutch is overheated, the safe protection mode engages.

(Continued)

(Continued)

If the safe protection mode engages, the gear position indicator on the cluster blinks with a chime sound. At this time, a warning message will appear on the LCD display and driving may not be smooth.

If you ignore this warning, the driving condition may become worse. To return the normal driving condition, stop the vehicle and apply the foot brake for a few minutes before driving off.

- If the dual clutch transmission starts to become overheated, the gear shift characteristics may change. Gear shifts may become more abrupt. If continued operation includes frequent and continuous upshifts and downshifts, the overheat warning message on the cluster LCD display may illuminate. If this occurs, stop the vehicle, apply the brakes or shift the vehicle to (P) Park, and allow the transmission to cool.

(Continued)

(Continued)

When possible, continue to drive the vehicle smoothly while trying to avoid frequent upshifting and downshifting.

- Gear shifts may be more noticeable than a conventional automatic transaxle. This is a normal characteristic of this type of dual clutch transmission.
- During the first 1,500 km (1,000 miles), you may feel that the vehicle may not be smooth when accelerating at low speed. During this break-in period, the shift quality and performance of your new vehicle is continuously optimized.
- Always come to a complete stop before shifting into D (Drive) or R (Reverse).
- Do not put the shift lever in N (Neutral) while driving.

Transmission ranges

The indicator in the instrument cluster displays the shift lever position when the ignition switch is in the ON position.

P (Park)

Always come to a complete stop before shifting into P (Park).

To shift from P (Park), you must depress firmly on the brake pedal and make sure your foot is off the accelerator pedal.

If you have done all of the above and still cannot shift the lever out of P (Park), see "Shift-Lock Release" in this chapter.

The shift lever must be in P (Park) before turning the engine off.

⚠ WARNING

- **Shifting into P (Park) while the vehicle is in motion may cause you to lose control of the vehicle.**
- **After the vehicle has stopped, always make sure the shift lever is in P (Park), apply the parking brake, and turn the engine off.**
- **Do not use the P (Park) position in place of the parking brake.**

FarmaSOS.com

R (Reverse)

Use this position to drive the vehicle backward.

NOTICE

Always come to a complete stop before shifting into or out of R (Reverse); you may damage the transaxle if you shift into R (Reverse) while the vehicle is in motion.

N (Neutral)

The wheels and transaxle are not engaged.

Use N (Neutral) if you need to restart a stalled engine, or if it is necessary to stop with the engine ON. Shift into P (Park) if you need to leave your vehicle for any reason.

Always depress the brake pedal when you are shifting from N (Neutral) to another gear.

D (Drive)

This is the normal driving position. The transmission will automatically shift through a 7-gear sequence, providing the best fuel economy and power.

For extra power when passing another vehicle or driving uphill, depress the accelerator fully. The transmission will automatically downshift to the next lower gear (or gears, as appropriate).

The DRIVE MODE switch, located on the shift lever console, allows the driver to switch from NORMAL mode to SPORT mode. (if equipped)

For more information, refer to "Drive Mode Integrated Control System" later in this chapter.



Sports mode

Whether the vehicle is stationary or in motion, sports mode is selected by pushing the shift lever from the D (Drive) position into the manual gate. To return to D (Drive) range operation, push the shift lever back into the main gate.

In sports mode, moving the shift lever backwards and forwards will allow you to make gearshifts rapidly.

Up (+) : Push the lever forward once to shift up one gear.

Down (-) : Pull the lever backwards once to shift down one gear.

i Information

- Only the seven forward gears can be selected. To reverse or park the vehicle, move the shift lever to the R (Reverse) or P (Park) position as required.
- Downshifts are made automatically when the vehicle slows down. When the vehicle stops, 1st gear is automatically selected.
- When the engine rpm approaches the red zone the transmission will upshift automatically.
- If the driver presses the lever to + (Up) or - (Down) position, the transmission may not make the requested gear change if the next gear is outside of the allowable engine rpm range. The driver must execute upshifts in accordance with road conditions, taking care to keep the engine rpms below the red zone.

Shift-lock system

For your safety, the dual clutch transmission has a shift-lock system which prevents shifting the transmission from P (Park) into R (Reverse) unless the brake pedal is depressed.

To shift the transmission from P (Park) into R (Reverse):

1. Depress and hold the brake pedal.
2. Start the engine or place the ignition switch in the ON position.
3. Move the shift lever.

Shift-lock release

If the shift lever cannot be moved from the P (Park) position into R (Reverse) position with the brake pedal depressed, continue depressing the brake, and then do the following:

امداد خودرو فارما

تلفن شبانه روزی: ۰۲۱-۸۸۸۶۲۰۸۵

FarmaSOS.com



1. Place the ignition switch in the LOCK/OFF position.
2. Apply the parking brake.
3. Carefully remove the cap (1) covering the shift-lock access hole.
4. Insert a tool (e.g. flathead screwdriver) into the access hole and press down on the tool.
5. Move the shift lever while holding down the screwdriver.
6. Remove the tool from the shiftlock release access hole then install the cap.
7. Depress the brake pedal, and then restart the engine.

If you need to use the shift-lock release, we recommend that the system be inspected by an authorized HYUNDAI dealer immediately.

Ignition key interlock system (if equipped)

The ignition key cannot be removed unless the shift lever is in the P (Park) position.

Parking

Always come to a complete stop and continue to depress the brake pedal. Move the shift lever into the P (Park) position, apply the parking brake, and place the ignition switch in the LOCK/OFF position. Take the Key with you when exiting the vehicle.

⚠ WARNING

When you stay in the vehicle with the engine running, be careful not to depress the accelerator pedal for a long period of time. The engine or exhaust system may overheat and start a fire.

The exhaust gas and the exhaust system are very hot. Keep away from the exhaust system components.

Do not stop or park over flammable materials, such as dry grass, paper or leaves. They may ignite and cause a fire.

Good driving practices

- Never move the shift lever from P (Park) or N (Neutral) to any other position with the accelerator pedal depressed.
- Never move the shift lever into P (Park) when the vehicle is in motion.

Be sure the vehicle is completely stopped before you attempt to shift into R (Reverse) or D (Drive).

- Do not move the shift lever to N (Neutral) when driving. Doing so may result in an accident because of a loss of engine braking and the transmission could be damaged.
- Do not drive with your foot resting on the brake pedal. Even light, but consistent pedal pressure can result in the brakes overheating, brake wear and possibly even brake failure.
- When driving in sports mode, slow down before shifting to a lower gear. Otherwise, the lower gear may not be engaged if the engine rpms are outside of the allowable range.

- Always apply the parking brake when leaving the vehicle. Do not depend on placing the transmission in P (Park) to keep the vehicle from moving.
- Exercise extreme caution when driving on a slippery surface. Be especially careful when braking, accelerating or shifting gears. On a slippery surface, an abrupt change in vehicle speed can cause the drive wheels to lose traction and may cause loss of vehicle control resulting in an accident
- Optimum vehicle performance and economy is obtained by smoothly depressing and releasing the accelerator.

WARNING

To reduce the risk of **SERIOUS INJURY or DEATH:**

- **ALWAYS** wear your seatbelt. In a collision, an unbelted occupant is significantly more likely to be seriously injured or killed than a properly belted occupant.
- Avoid high speeds when cornering or turning.
- Do not make quick steering wheel movements, such as sharp lane changes or fast, sharp turns.
- The risk of rollover is greatly increased if you lose control of your vehicle at highway speeds.
- Loss of control often occurs if two or more wheels drop off the roadway and the driver over steers to reenter the roadway.

(Continued)

(Continued)

- In the event your vehicle leaves the roadway, do not steer sharply. Instead, slow down before pulling back into the travel lanes.
- HYUNDAI recommends you follow all posted speed limits.

Information - Kickdown Mechanism (if equipped)

Use the kickdown mechanism for maximum acceleration. Depress the accelerator pedal beyond the pressure point. The automatic transaxle will shift to a lower gear depending on the engine speed.

BRAKING SYSTEM

Power brakes

Your vehicle has power-assisted brakes that adjust automatically through normal usage.

If the engine is not running or is turned off while driving, the power assist for the brakes will not work. You can still stop your vehicle by applying greater force to the brake pedal than typical. The stopping distance, however, will be longer than with power brakes.

When the engine is not running, the reserve brake power is partially depleted each time the brake pedal is applied. Do not pump the brake pedal when the power assist has been interrupted.

Pump the brake pedal only when necessary to maintain steering control on slippery surfaces.

WARNING

Take the following precautions:

- **Do not drive with your foot resting on the brake pedal. This will create abnormal high brake temperatures, excessive brake lining and pad wear, and increased stopping distances.**
- **When descending a long or steep hill, shift to a lower gear and avoid continuous application of the brakes. Applying the brakes continuously will cause the brakes to overheat and could result in a temporary loss of braking performance.**

(Continued)

(Continued)

- **Wet brakes may impair the vehicle's ability to safely slow down; the vehicle may also pull to one side when the brakes are applied. Applying the brakes lightly will indicate whether they have been affected in this way. Always test your brakes in this fashion after driving through deep water. To dry the brakes, lightly tap the brake pedal to heat up the brakes while maintaining a safe forward speed until brake performance returns to normal. Avoid driving at high speeds until the brakes function correctly.**

Disc brakes wear indicator

When your brake pads are worn and new pads are required, you will hear a high pitched warning sound from your front or rear brakes. You may hear this sound come and go or it may occur whenever you depress the brake pedal.

Please remember some driving conditions or climates may cause a brake squeal when you first apply (or lightly apply) the brakes. This is normal and does not indicate a problem with your brakes.

NOTICE

To avoid costly brake repairs, do not continue to drive with worn brake pads.

i Information

Always replace brake pads as complete front or rear axle sets.

Parking brake (hand type, if equipped)

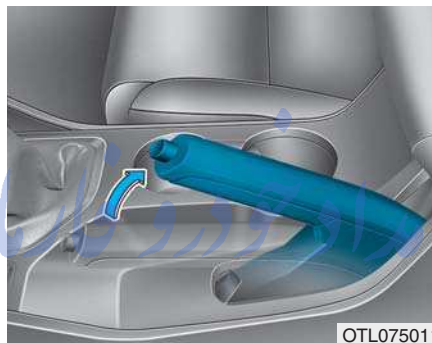

Always set the parking brake before leaving the vehicle, to apply:

Firmly depress the brake pedal.

Pull up the parking brake lever as far as possible.

⚠ WARNING

To reduce the risk of SERIOUS INJURY or DEATH, do not operate the parking brake while the vehicle is moving except in an emergency situation. It could damage the brake system and lead to an accident.

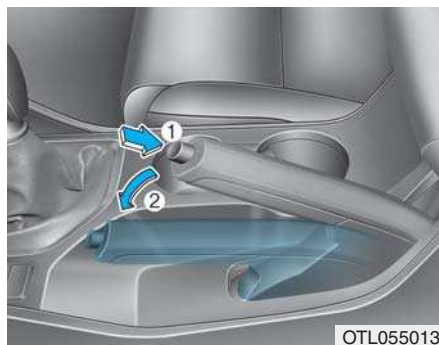

To release:

Firmly depress the brake pedal.

Slightly pull up the parking brake lever.

While pressing the release button (1), lower the parking brake (2).

If the parking brake does not release or does not release all the way, we recommend that the system be checked by an authorized HYUNDAI dealer.

! WARNING

- Whenever leaving the vehicle or parking, always come to a complete stop and continue to depress the brake pedal. Move the shift lever into the 1st gear (for manual transaxle vehicle) or P (Park, for automatic transaxle/dual clutch transmission vehicle) position, then apply the parking brake, and place the ignition switch in the LOCK/OFF position.

Vehicles with the parking brake not fully engaged are at risk for moving inadvertently and causing injury to yourself or others.

- NEVER allow anyone who is unfamiliar with the vehicle to touch the parking brake. If the parking brake is released unintentionally, serious injury may occur.
- Only release the parking brake when you are seated inside the vehicle with your foot firmly on the brake pedal.

NOTICE

- Do not apply the accelerator pedal while the parking brake is engaged. If you depress the accelerator pedal with the parking brake engaged, warning will sound. Damage to the parking brake may occur.
- Driving with the parking brake on can overheat the braking system and cause premature wear or damage to brake parts. Make sure the parking brake is released and the Brake Warning Light is off before driving.



Check the Parking Brake Warning Light by placing the ignition switch to the ON position (do not start the engine).

This light will be illuminated when the parking brake is applied with the ignition switch in the START or ON position.

Before driving, be sure the parking brake is released and the Brake Warning Light is OFF.

If the Parking Brake Warning Light remains on after the parking brake is released while engine is running, there may be a malfunction in the brake system. Immediate attention is necessary.

If at all possible, cease driving the vehicle immediately. If that is not possible, use extreme caution while operating the vehicle and only continue to drive the vehicle until you can reach a safe location.

تلفن شبانه روزی: ۰۲۱-۸۸۸۶۲۰۸۵

FarmaSOS.com

Electronic Parking Brake (EPB) (if equipped)

Applying the parking brake

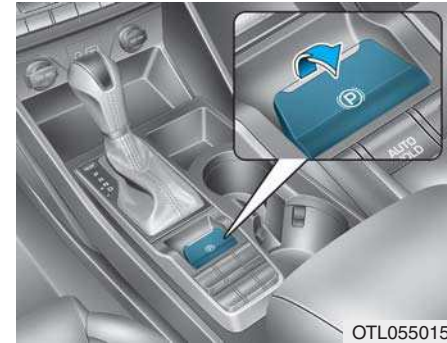

OTL055015

To apply the EPB (Electronic Parking Brake):

1. Depress the brake pedal.
2. Pull up the EPB switch.

Make sure the Parking Brake Warning Light comes on.

Also, the EPB is applied automatically if the [AUTO HOLD] switch is on when the engine is turned off. However, if you press the EPB switch within one second after the engine is turned off, the EPB will not be applied.

WARNING

To reduce the risk of **SERIOUS INJURY** or **DEATH**, do not operate the EPB while the vehicle is moving except in an emergency situation. It could damage the brake system and lead to an accident.

Releasing the parking brake



To release the EPB (Electronic Parking Brake), press the EPB switch in the following condition:

- Place the Engine Start/Stop button in the ON position.
- Depress the brake pedal.

Make sure the Parking Brake Warning Light goes off.

To release EPB (Electronic Parking Brake) automatically:

- Shift lever in P (Park)
With the engine running depress the brake pedal and shift out of P (Park) to R (Rear) or D (Drive).
- Shift lever in N (Neutral)
With the engine running depress the brake pedal and shift out of N (Neutral) to R (Rear) or D (Drive).
- Automatic transaxle/Dual clutch transmission vehicle
 1. Start the engine.
 2. Fasten the driver's seat belt.
 3. Close the driver's door, engine hood and tailgate.
 4. Depress the accelerator pedal while the shift lever is in R (Rear), D (Drive) or Sports mode.

Make sure the Parking Brake Warning light goes off.

i Information

- For your safety, you can engage the EPB even though the Engine Stop/Start button is in the OFF position, but you cannot release it.
- For your safety, depress the brake pedal and release the parking brake manually with the EPB switch when you drive downhill or when backing up the vehicle.

NOTICE

- **If the parking brake warning light is still on even though the EPB has been released, we recommend that the system be checked by an authorized HYUNDAI dealer.**
- **Do not drive your vehicle with the EPB applied. It may cause excessive brake pad and brake rotor wear.**

تلفن شبانه روزی: ۰۲۱-۸۸۸۶۲۰۸۵

FarmaSOS.com

When the EPB (Electronic Parking Brake) does not release:

We recommend that you contact an authorized HYUNDAI dealer by loading the vehicle on a flatbed tow truck and have the system checked.

EPB (Electronic Parking Brake) may be automatically applied when:

- The EPB is overheated
- It is requested by other systems
- The engine is turned off with the EPB applied

i Information

If the driver turns the engine off while Auto Hold is operating, EPB will be automatically applied. However, if you press the EPB switch within one second after the engine is turned off, the EPB will not be applied.

Warning messages

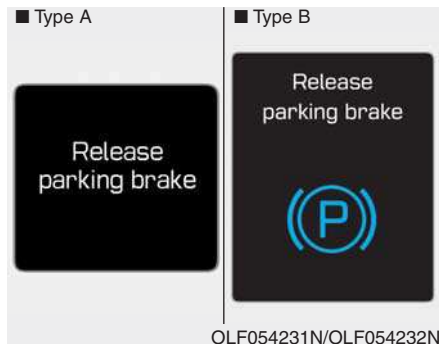

Release parking brake

- When you try to drive with the EPB applied, a warning will sound and a message will appear.
- If the driver's seat belt is unfastened and the engine hood or tailgate is opened, a warning will sound and a message will appear.
- When there is a problem with the vehicle, a warning may sound and a message may appear.

If the situation occurs, depress the brake pedal and release EPB by pressing the EPB switch.

WARNING

- Whenever leaving the vehicle or parking, always come to a complete stop and continue to depress the brake pedal.

Move the shift lever into the P (Park) position, press the EPB switch, and press the Engine Start/Stop button to the OFF position. Take the Smart Key with you when exiting the vehicle.

Vehicles not fully engaged in P (Park) with the parking brake set are at risk for moving inadvertently and causing injury to yourself or others.

- NEVER allow anyone who is unfamiliar with the vehicle to touch the EPB switch. If the EPB is released unintentionally, serious injury may occur.
- Only release the EPB when you are seated inside the vehicle with your foot firmly on the brake pedal.

NOTICE

- Do not apply the accelerator pedal while the parking brake is engaged. If you depress the accelerator pedal with the EPB engaged, a warning will sound and a message will appear. Damage to the parking brake may occur.
- Driving with the parking brake on can overheat the braking system and cause premature wear or damage to brake parts. Make sure the EPB is released and the Parking Brake Warning Light is off before driving.

i Information

- A clicking sound may be heard while operating or releasing the EPB. These conditions are normal and indicate that the EPB is functioning properly.
- When leaving your keys with a parking attendant or assistant, make sure to inform him/her how to operate the EPB.

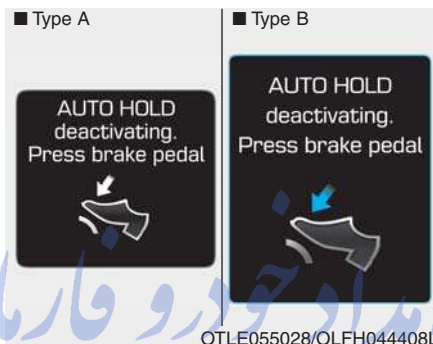

AUTO HOLD deactivating. Press brake pedal

When the conversion from Auto Hold to EPB is not working properly, a warning will sound and a message will appear.

FarmaSOS.com

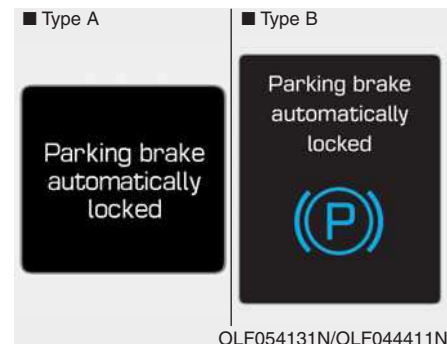

Parking brake automatically locked

If the EPB is applied while Auto Hold is activated, a warning will sound and a message will appear.

EPB malfunction indicator (if equipped)



If the EPB malfunction indicator remains on, comes on while driving, or does not come on when the Engine Start/Stop button is changed to the ON position, this indicates that the EPB may have malfunctioned.

If this occurs, we recommend that the system be checked by an authorized HYUNDAI dealer.

The EPB malfunction indicator may illuminate when the ESC indicator comes on to indicate that the ESC is not working properly, but it does not indicate a malfunction of the EPB.

NOTICE

- If the EPB warning light is still on, we recommend that the system be checked by an authorized HYUNDAI dealer.
- If the parking brake warning light does not illuminate or blinks even though the EPB switch was pulled up, the EPB may not be applied.
- If the parking brake warning light blinks when the EPB warning light is on, press the switch, and then pull it up. Repeat this one more time. If the EPB warning does not go off, we recommend that the system be checked by an authorized HYUNDAI dealer.

Emergency braking

If there is a problem with the brake pedal while driving, emergency braking is possible by pulling up and holding the EPB switch. Braking is possible only while you are holding the EPB switch.

⚠ WARNING

Do not operate the parking brake while the vehicle is moving except in an emergency situation. It could damage the brake system and lead to a severe accident.

i Information

During emergency braking, the parking brake warning light will illuminate to indicate that the system is operating.

NOTICE

If you continuously notice a noise or burning smell when the EPB is used for emergency braking, we recommend that the system be checked by an authorized HYUNDAI dealer.

When the EPB (Electronic Parking Brake) does not release

If the EPB does not release normally, we recommend that you contact an authorized HYUNDAI dealer by loading the vehicle on a flatbed tow truck and have the system checked.

AUTO HOLD (if equipped)

This feature keeps the brake applied when the shift lever is in D (Drive), R (Reverse), N (Neutral) or Sports Mode with the feature enabled and when the brake pedal has been depressed to stop the vehicle.

امداد خودرو فارما

تلفن شبانه روزی: ۰۲۱-۸۸۸۶۲۰۸۵

FarmaSOS.com

To apply :

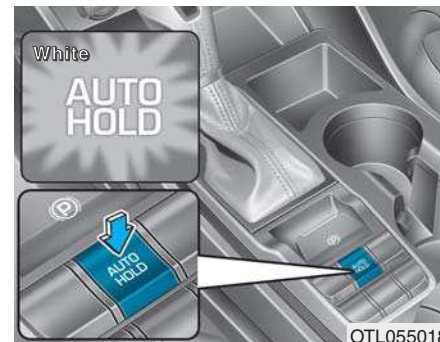

1. With the driver's door, engine hood and tailgate closed, fasten the driver's seat belt or depress the brake pedal and then press the [AUTO HOLD] switch. The white [AUTO HOLD] indicator will come on and the system will be in the standby position.

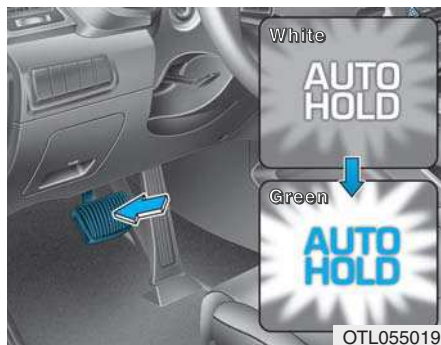

2. When you stop the vehicle completely by depressing the brake pedal, the AUTO HOLD indicator changes from white to green.
3. The vehicle will remain stationary even if you release the brake pedal.
4. If EPB is applied, Auto Hold will be released.

To release :

If you press the accelerator pedal with the shift lever in R (Reverse), D (Drive) or sports mode, the Auto Hold will be released automatically and the vehicle will start to move. The indicator changes from green to white.

⚠ WARNING

When the AUTO HOLD is automatically released by depressing the accelerator pedal, always take a look around your vehicle. Slowly depress the accelerator pedal for a smooth start.

FarmaSOS.com

To cancel :



1. Depress the brake pedal.
 2. Press the [AUTO HOLD] switch.
- The AUTO HOLD indicator will turn off.

WARNING

To prevent, unexpected and sudden vehicle movement, **ALWAYS** press your foot on the brake pedal to cancel the Auto Hold before you:

- Drive downhill.
- Drive the vehicle in R (Reverse).
- Park the vehicle.

Information

- The Auto Hold does not operate when:
 - The driver's seat belt is unfastened and driver's door is opened
 - The engine hood is opened
 - The tailgate is opened
 - The shift lever is in P (Park)
 - The EPB is applied
- For your safety, the Auto Hold automatically switches to EPB when:
 - The driver's seat belt is unfastened and driver's door is opened
 - The engine hood is opened with the shift lever is in D (Drive)
 - The tailgate is opened with the shift lever is in R (Reverse)
 - The vehicle stops for more than 10 minutes
 - The vehicle stands on a steep slope
 - The vehicle moves several times

(Continued)

(Continued)

In these cases, the brake warning light comes on, the AUTO HOLD indicator changes from green to white, and a warning sound and a message will appear to inform you that EPB has been automatically engaged. Before driving off again, press foot brake pedal, check the surrounding area near your vehicle and release parking brake manually with the EPB switch.

- If the AUTO HOLD indicator changes to yellow, the Auto Hold is not working properly. We recommend that you contact an authorized HYUNDAI dealer.
- While operating Auto Hold, you may hear mechanical noise. However, it is normal operating noise.

⚠ WARNING

- Press the accelerator pedal slowly when you start the vehicle.
- For your safety, cancel the Auto Hold when you drive downhill, back up the vehicle or park the vehicle.

NOTICE

If there is a malfunction with the driver's door, engine hood or trunk open detection system, the Auto Hold may not work properly. We recommend that you contact an authorized HYUNDAI dealer.

Warning messages

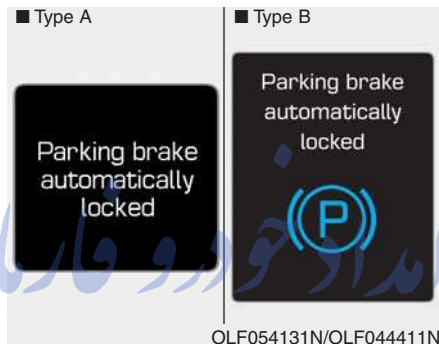

Parking brake automatically locked
When the EPB is applied from Auto Hold, a warning will sound and a message will appear.

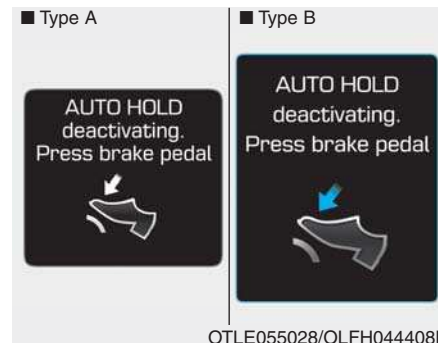

AUTO HOLD deactivating. Press brake pedal

When the conversion from Auto Hold to EPB is not working properly a warning will sound and a message will appear.

NOTICE

When this message is displayed, the Auto Hold and EPB may not operate. For your safety, depress the brake pedal.

FarmaSOS.com

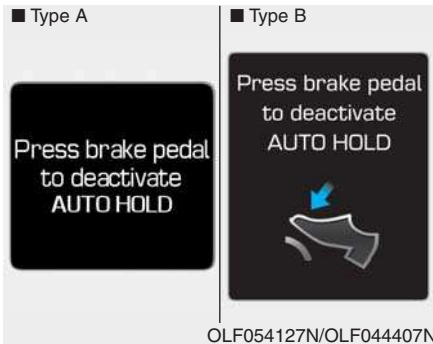

Press brake pedal to deactivate AUTO HOLD

If you did not apply the brake pedal when you release the Auto Hold by pressing the [AUTO HOLD] switch, a warning will sound and a message will appear.



AUTO HOLD conditions not met. Close door, hood, trunk, and fasten seatbelt

When you press the [AUTO HOLD] switch, if the driver's door, engine hood and tailgate are not closed or the driver's seat belt is unfastened, a warning will sound and a message will appear on the LCD display. At this moment, press the [AUTO HOLD] button after closing the driver's door, engine hood and tailgate and fastening the seat belt.

Anti-lock Brake System (ABS)

⚠ WARNING

An Anti-Lock Braking System (ABS) or an Electronic Stability Control (ESC) system will not prevent accidents due to improper or dangerous driving maneuvers. Even though vehicle control is improved during emergency braking, always maintain a safe distance between you and objects ahead of you. Vehicle speeds should always be reduced during extreme road conditions. The braking distance for cars equipped with ABS or ESC may be longer than for those without these systems in the following road conditions.

- Drive your vehicle at reduced speeds during the following conditions:
- Rough, gravel or snow-covered roads.

(Continued)

(Continued)

- **On roads where the road surface is pitted or has different surface height.**
- **Tire chains are installed on your vehicle.**

The safety features of an ABS or ESC equipped vehicle should not be tested by high speed driving or cornering. This could endanger the safety of yourself or others.

ABS is an electronic braking system that helps prevent a braking skid. ABS allows the driver to steer and brake at the same time.

Using ABS

To obtain the maximum benefit from your ABS in an emergency situation, do not attempt to modulate your brake pressure and do not try to pump your brakes. Depress your brake pedal as hard as possible.

When you apply your brakes under conditions which may lock the wheels, you may hear sounds from the brakes, or feel a corresponding sensation in the brake pedal. This is normal and it means your ABS is active.

ABS does not reduce the time or distance it takes to stop the vehicle. تلفن

Always maintain a safe distance from the vehicle in front of you.

ABS will not prevent a skid that results from sudden changes in direction, such as trying to take a corner too fast or making a sudden lane change. Always drive at a safe speed for the road and weather conditions.

ABS cannot prevent a loss of stability. Always steer moderately when braking hard. Severe or sharp steering wheel movement can still cause your vehicle to veer into oncoming traffic or off the road.

On loose or uneven road surfaces, operation of the anti-lock brake system may result in a longer stopping distance than for vehicles equipped with a conventional brake system.

The ABS warning light ((ABS)) will stay on for several seconds after the Engine Start/Stop button is in the ON position. During that time, the ABS will go through self-diagnosis and the light will go off if everything is normal. If the light stays on, you may have a problem with your ABS. We recommend that you contact an authorized HYUNDAI dealer as soon as possible.

WARNING

If the ABS warning light () is on and stays on, you may have a problem with the ABS. Your power brakes will work normally. To reduce the risk of serious injury or death, we recommend that you contact your HYUNDAI dealer as soon as possible.

NOTICE

When you drive on a road having poor traction, such as an icy road, and apply your brakes continuously, the ABS will be active continuously and the ABS warning light () may illuminate. Pull your car over to a safe place and turn the engine off.

Restart the engine. If the ABS warning light is off, then your ABS system is normal.

Otherwise, you may have a problem with your ABS system. We recommend that you contact an authorized HYUNDAI dealer as soon as possible.

Information

When you jump start your vehicle because of a drained battery, the ABS warning light () may turn on at the same time. This happens because of the low battery voltage. It does not mean your ABS is malfunctioning. Have the battery recharged before driving the vehicle.

امداد خودرو فارما

تلفن شبانه روزی: ۰۲۱-۸۸۸۶۲۰۸۵

FarmaSOS.com

Electronic Stability Control (ESC) (if equipped)



The Electronic Stability Control (ESC) system helps to stabilize the vehicle during cornering maneuvers. ESC checks where you are steering and where the vehicle is actually going. ESC applies braking pressure to any one of the vehicle's brakes and intervenes in the engine management system to assist the driver with keeping the vehicle on the intended path. It is not a substitute for safe driving practices. Always adjust your speed and driving to the road conditions.

 **WARNING**

Never drive too fast for the road conditions or too quickly when cornering. The ESC system will not prevent accidents.

Excessive speed in turns, abrupt maneuvers, and hydroplaning on wet surfaces can result in severe accidents.

ESC operation

ESC ON condition

When the ignition switch is in the ON position, the ESC and the ESC OFF indicator lights illuminate for approximately three seconds and goes off, then the ESC is turned on.

امداد خودرو فارما

تلفن شبانه روزی: ۰۸۵-۸۸۸۶۲۰۲۱

FarmaSOS.com

When operating



When the ESC is in operation, the ESC indicator light blinks:

- When you apply your brakes under conditions which may lock the wheels, you may hear sounds from the brakes, or feel a corresponding sensation in the brake pedal. This is normal and it means your ESC is active.
- When the ESC activates, the engine may not respond to the accelerator as it does under routine conditions.
- If the Cruise Control was in use when the ESC activates, the Cruise Control automatically disengages. The Cruise Control can be reengaged when the road conditions allow. **See “Cruise Control System” later in this chapter.** (if equipped)

- When moving out of the mud or driving on a slippery road, the engine rpm (revolutions per minute) may not increase even if you press the accelerator pedal deeply. This is to maintain the stability and traction of the vehicle and does not indicate a problem.

ESC OFF condition



To cancel ESC operation :

- State 1

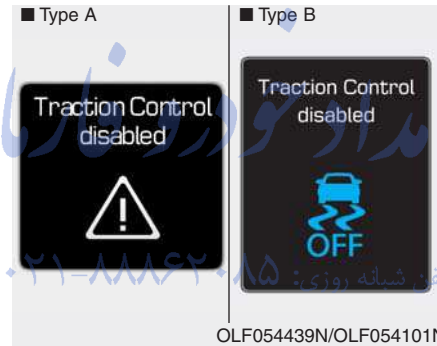

Press the ESC OFF button shortly (ESC OFF indicator light and message illuminates). At this state, the engine control function does not operate. The traction control function does not operate but only the brake control function operates.

- State 2

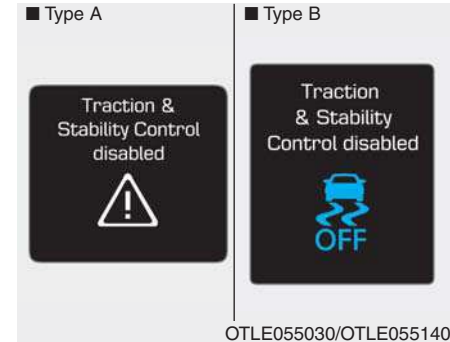

Press the ESC OFF button for more than 3 seconds. ESC OFF indicator light and message illuminates and ESC OFF warning chime will sound. At this state, the engine control function and brake control function does not operate. The vehicle stability control function does not operate any more.

If the ignition switch is placed to the LOCK/OFF position when ESC is off, ESC remains off. Upon restarting the engine, the ESC will automatically turn on again.

Indicator lights

- ESC indicator light (blinks)



- ESC OFF indicator light (comes on)



When the ignition switch is pressed to the ON position, the ESC indicator light illuminates, then goes off if the ESC system is operating normally.

The ESC indicator light blinks whenever the ESC is operating.

If ESC indicator light stays on, your vehicle may have a malfunction with the ESC system. When this warning light illuminates we recommend that the vehicle be checked by an authorized HYUNDAI dealer as soon as possible.

The ESC OFF indicator light comes on when the ESC is turned off with the button.

WARNING

When the ESC is blinking, this indicates the ESC is active:

Drive slowly and NEVER attempt to accelerate. NEVER turn the ESC off while the ESC indicator light is blinking or you may lose control of the vehicle resulting in an accident.

NOTICE

Driving with tires or wheels in various sizes may fail the normal operation of the ESC system. Before replacing tires, make sure they are in the same size as others. Never drive the vehicle, which is installed with the tires of different diameters.

ESC OFF usage

When Driving

The ESC OFF mode should only be used briefly to help free the vehicle if stuck in snow or mud by temporarily stopping operation of the ESC to maintain wheel torque.

To turn ESC off while driving, press the ESC OFF button while driving on a flat road surface.

NOTICE

To prevent damage to the transaxle:

- Do not allow wheel(s) of one axle to spin excessively while the ESC, ABS, and parking brake warning lights are displayed. The repairs would not be covered by the vehicle warranty. Reduce engine power and do not spin the wheel(s) excessively while these lights are displayed.
- When operating the vehicle on a dynamometer, make sure the ESC is turned off (ESC OFF light illuminated).

i Information

Turning the ESC off does not affect ABS or standard brake system operation.

Vehicle Stability Management (if equipped)

Vehicle Stability Management (VSM) helps ensure the vehicle stays stable when accelerating or braking suddenly on wet, slippery and rough roads where traction over the four tires can suddenly become uneven.

⚠ WARNING

Take the following precautions when using the Vehicle Stability Management (VSM):

- ALWAYS check the speed and the distance to the vehicle ahead. The VSM is not a substitute for safe driving practices.
- Never drive too fast for the road conditions. The VSM system will not prevent accidents. Excessive speed in bad weather, slippery and uneven roads can result in severe accidents.

VSM operation

VSM ON condition

The VSM operates when:

- The Electronic Stability Control (ESC) is on.
- Vehicle speed is approximately above 15 km/h (9mph) on curve roads.
- Vehicle speed is approximately above 20 km/h (12mph) when the vehicle is braking on rough roads.

When operating

When you apply your brakes under conditions which may activate the ESC, you may hear sounds from the brakes, or feel a corresponding sensation in the brake pedal. This is normal and it means your VSM is active.

i Information

The VSM does not operate when:

- Driving on bank road such as gradient or incline
- Driving rearward.
- ESC OFF indicator light is on.
- EPS (Electric Power Steering) warning light (⊕!) is on.

VSM OFF condition

To cancel VSM operation, press the ESC OFF button. ESC OFF indicator light (⊕) will illuminate.

To turn on VSM, press the ESC OFF button again. The ESC OFF indicator light will go out.

⚠ WARNING

If ESC indicator light (⊕) or EPS warning light (⊕!) stays on, your vehicle may have a malfunction with the VSM system. When the warning light illuminates we recommend that the vehicle be checked by an authorized HYUNDAI dealer as soon as possible.

NOTICE

Driving with varying tire or wheel sizes may cause the ESC system to malfunction. When replacing tires, make sure they are the same size as your original tires for this vehicle.

Hill-Start Assist Control (HAC) (if equipped)

A vehicle has the tendency to slide backwards on a steep slope, before depressing the accelerator after a stop. The HAC prevents the vehicle from sliding backwards by automatically operating the brake systems for about 2 seconds. The brake systems are automatically released, when the accelerator pedal is depressed

⚠ WARNING

The HAC is activated only for about 2 seconds, so always depress the accelerator pedal to begin driving upwards after a stop.

i Information

- The HAC does not operate when the shift lever is in P (Park) or N (Neutral)
- The HAC activates even when the ESC (Electronic Stability Control) is off. However, it does not activate, when the ESC does not normally operate.

Downhill Brake Control (DBC) (if equipped)

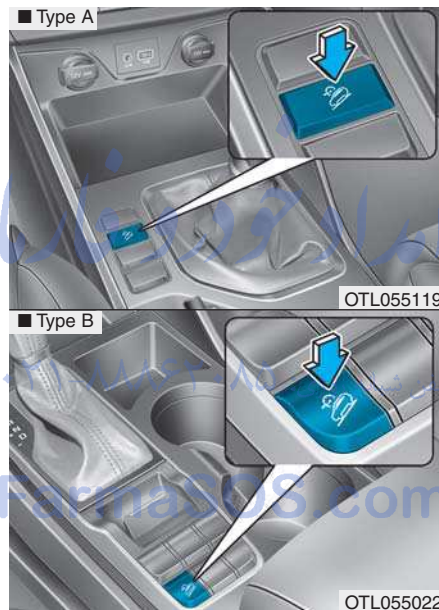

The Downhill Brake Control (DBC) supports the driver come down a steep hill without depressing the brake pedal.

It slows down the vehicle under 8 km/h (5mph) (for automatic transaxle /dual clutch transmission vehicles) or 8 km/h (5 mph) (for manual transaxle vehicles) and lets the driver concentrate on steering the vehicle.





⚠ WARNING

Always turn off the DBC on normal roads. The DBC might activate inadvertently from the standby mode when driving through speed bumps or making sharp curves.

NOTICE

- The DBC defaults to the OFF position whenever the ignition switch is placed in the ON position.
- Noise or vibration may occur from the brakes when the DBC is activated.
- The rear stop light comes on when DBC is activated.

DBC operation

Mode	Indicator light	Description
Standby	 illuminated	Press the DBC button when vehicle speed is under 40km/h (25mph). The DBC system will turn ON and enter the standby mode. The system does not turn ON if vehicle speed is over 40km/h (25mph).
Activated	 blinks	In the standby mode, if vehicle speed is under 35km/h (22mph) while driving down a steep hill, the DBC will activate automatically.
Temporarily deactivated	 illuminated	In the activated mode, the DBC will temporarily deactivate under the following conditions: <ul style="list-style-type: none"> • The hill is not steep enough. • The brake pedal or accelerator pedal is depressed. If the above conditions are gone, the DBC will automatically activate again.
OFF	 not illuminated	The DBC will turn OFF under the following conditions: <ul style="list-style-type: none"> • The DBC button is pressed again. • Vehicle speed is over 60km/h (38mph).

WARNING

If the DBC red indicator light illuminates, the system may have overheated or have malfunctioned. When the warning light illuminates even though the DBC system has cooled off, we recommend that the vehicle be checked by an authorized HYUNDAI dealer as soon as possible.

NOTICE

- The DBC may not deactivate on steep inclines even though the brake or accelerator pedal is depressed.
- Do not turn on the DBC when driving with shift lever in 3rd gear (and above) for vehicles with manual transaxle. The engine may stop if the DBC system is activated.
- The DBC does not operate when:
 - The shift lever is in P (Park).
 - The ESC is activated.

Emergency Stop Signal (ESS) (if equipped)

The Emergency Stop Signal system alerts the driver behind by blinking the stop lights, while sharply and severely braking.

The system is activated when:

- The vehicle suddenly stops. (The deceleration power exceeds 7 m/s^2 , and the driving speed exceeds 55 km/h (34 mph .)
- The ABS is activated.

The hazard warning flasher automatically turns ON after blinking the stop lights, when the driving speeds is decelerated under 40 km/h (25 mph), when the ABS is deactivated, and when the sudden braking situation is over.

The hazard warning flasher turns OFF, when the driving speed exceeds 10 km/h (6 mph) after a complete stop. The hazard warning flasher turns OFF, when the vehicle drives at a low speed for a certain period of time. The driver can manually turn OFF the hazard warning flasher by pressing the button.

i Information

The Emergency Stop Signal (ESS) system will not activate, when the hazard warning flasher already blinks.

Good braking practices

WARNING

Whenever leaving the vehicle or parking, always come to a complete stop and continue to depress the brake pedal. Move the shift lever into the P (Park) position, then apply the parking brake, and place the Engine Start/Stop button in the OFF position.

Vehicles with the parking brake not fully engaged are at risk for moving inadvertently and causing injury to yourself or others.

Wet brakes can be dangerous! The brakes may get wet if the vehicle is driven through standing water or if it is washed. Your vehicle will not stop as quickly if the brakes are wet. Wet brakes may cause the vehicle to pull to one side.

To dry the brakes, apply the brakes lightly until the braking action returns to normal, taking care to keep the vehicle under control at all times. If the braking action does not return to normal, stop as soon as it is safe to do so and we recommend that you call an authorized HYUNDAI dealer for assistance.

DO NOT drive with your foot resting on the brake pedal. Even light, but constant pedal pressure can result in the brakes overheating, brake wear, and possibly even brake failure.

If a tire goes flat while you are driving, apply the brakes gently and keep the vehicle pointed straight ahead while you slow down. When you are moving slowly enough for it to be safe to do so, pull off the road and stop in a safe location.

Keep your foot firmly on the brake pedal when the vehicle is stopped to prevent the vehicle from rolling forward.

FOUR WHEEL DRIVE (4WD) (IF EQUIPPED)

The Four Wheel Drive (4WD) System delivers engine power to all front and rear wheels for maximum traction. 4WD is useful when extra traction is required on roads such as slippery, muddy, wet, or snow-covered roads.

Occasional off-road use such as established unpaved roads and trails are OK. It is always important that the driver carefully reduces the speed to a level that does not exceed the safe operating speed for those conditions.

WARNING

To reduce the risk of **SERIOUS INJURY or DEATH**:



- Do not drive in conditions that exceed the vehicles intended design such as challenging off-road conditions.
- Avoid high speeds when cornering or turning.
- Do not make quick steering wheel movements, such as sharp lane changes or fast, sharp turns.
- The risk of a rollover is greatly increased if you lose control of your vehicle at highway speeds.
- Loss of control often occurs if two or more wheels drop off the roadway and the driver over steers to reenter the roadway.
- In the event your vehicle leaves the roadway, do not steer sharply. Instead, slow down before pulling back into the travel lanes.

NOTICE



- Do not drive in water if the level is higher than the bottom of the vehicle.
- Check your brake condition once you are out of mud or water. Depress the brake pedal several times as you move slowly until you feel normal braking return.
- Shorten your scheduled maintenance interval if you drive in off-road conditions such as sand, mud or water (see "Maintenance Under Severe Usage Conditions" in chapter 7).
- Always wash your vehicle thoroughly after off road use, especially the bottom of the vehicle.
- Be sure to equip the vehicle with four tires of the same size and type.
- Make sure that a full time 4WD vehicle is towed by a flat bed tow truck.

4WD operation

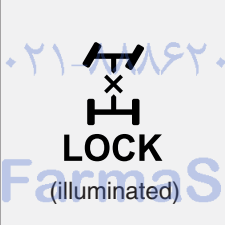
Four Wheel Drive (4WD) mode selection

Transfer mode	Selection button	Indicator light	Description
4WD AUTO (4WD LOCK is deactivated)		 (not illuminated)	In the 4WD AUTO mode, under normal operating conditions, the vehicle operates similar to conventional 2WD vehicles. If the system determines there is a need for four wheel drive, the engine's driving power is distributed to all four wheels automatically. Use this mode when driving on normal roads.
4WD LOCK		 (illuminated)	In the 4WD LOCK mode, the system is deactivated when vehicle speed is over 30 km/h (19mph) and the mode is shifted to 4WD AUTO mode. If the vehicle speed slows down to 30 km/h (19mph), the mode shifts back to the 4WD LOCK mode. Use this mode when driving up or down steep inclines, driving off-road, driving on sandy and muddy roads, etc. to maximize traction

WARNING

If 4WD warning light () stays on the instrument cluster, your vehicle may have a malfunction with the 4WD system. When the 4WD warning light () illuminates we recommend that the vehicle be checked by an authorized HYUNDAI dealer as soon as possible.

 **CAUTION**

When driving on normal roads, deactivate the 4WD LOCK mode by pushing the 4WD LOCK button (4WD LOCK indicator light goes off). Driving on normal roads with the 4WD LOCK mode, especially, when cornering may cause mechanical noise or vibration. The noise and vibration will disappear when the 4WD LOCK mode is deactivated. Prolong driving with the noise and vibration may damage some parts of the power train.

NOTICE

When the 4WD LOCK mode is deactivated, a sensation may be felt as the driving power is delivered entirely to the front wheels.

For safe 4WD operation

Before driving

- Make sure all passengers are wearing seat belts.
- Sit upright and closer to the steering wheel than usual. Adjust the steering wheel to a position comfortable for you to drive.

امداد خودرو فارما

تلفن شبانه روزی: ۰۲۱-۸۸۸۶۲۰۸۵

FarmaSOS.com

Driving on snow-covered or icy roads

- Start off slowly by applying the accelerator pedal gently.
- Use snow tires or tire chains.
- Keep sufficient distance between your vehicle and the vehicle in front of you.
- Use engine braking during deceleration.
- Avoid speeding, rapid acceleration, sudden brake applications, and sharp turns to prevent skids.

Driving in sand or mud

- Maintain slow and constant speed.
- Use tire chains driving in mud if necessary.
- Keep sufficient distance between your vehicle and the vehicle in front of you.
- Reduce vehicle speed and always check the road condition.
- Avoid speeding, rapid acceleration, sudden brake applications, and sharp turns to prevent getting stuck.

CAUTION

When the vehicle is stuck in snow, sand or mud, place a non-slip material under the drive wheels to provide traction OR Slowly spin the wheels in forward and reverse directions which causes a rocking motion that may free the vehicle. However, avoid running the engine continuously at high rpm, doing so may damage the 4WD system.



Driving up or down hills

- Driving uphill
 - Before starting off, check if it is possible to drive uphill.
 - Drive as straight as possible.
- Driving downhill
 - Do not change gear while driving downhill. Select gear before driving downhill.
 - Drive as slowly using engine braking while driving downhill.
 - Drive straight as possible.

WARNING

Exercise extreme caution driving up or down steep hills. The vehicle may flip depending on the grade, terrain and water/mud conditions.



OLMB053018

WARNING

Do not drive across the contour of steep hills. A slight change in the wheel angle can destabilize the vehicle, or a stable vehicle may lose stability if the vehicle stops its forward motion. Your vehicle may roll over and lead to a serious injury or death.

Driving through water

- Try to avoid driving in deep standing water. It may stall your engine and clog your exhaust pipes.
- If you need to drive in water, stop your vehicle, set the vehicle in 4WD LOCK mode and drive under 8 km/h (5mph).
- Do not change gear while driving in water.

CAUTION

Always drive slowly in water. If you drive too fast, water may get into the engine compartment and wet the ignition system causing your vehicle to suddenly stop.

Additional driving conditions

- Become familiar with the off-road conditions before driving.
- Always pay attention when driving off-road and avoid dangerous areas.
- Drive slowly when driving in heavy wind.
- Reduce vehicle speed when cornering. The center of gravity of 4WD vehicles is higher than conventional 2WD vehicles, making them more likely to roll over when you rapidly turn corners.



OTLE055003

- Always hold the steering wheel firmly when you are driving off-road.

⚠ WARNING

Do not grab the inside of the steering wheel when you are driving off-road. You may hurt your arm by a sudden steering maneuver or from steering wheel rebound due to an impact with objects on the ground. You could lose control of the steering wheel which may lead to serious injury or death.

Emergency precautions

Tires

Do not use tire and wheel with different size and type from the one originally installed on your vehicle. It can affect the safety and performance of your vehicle, which could lead to steering failure or rollover causing serious injury.

When replacing the tires, be sure to equip all four tires with the tire and wheel of the same size, type, tread, brand and load-carrying capacity. If you equip your vehicle with any tire/wheel combination not recommended by HYUNDAI for off-road driving, you should not use these tires for highway driving.

⚠ WARNING

Never start or run the engine while a full-time 4WD vehicle is raised on a jack. The vehicle can slip or roll off of a jack causing serious injury or death to you or those nearby.

Towing

4WD vehicles must be towed with a wheel lift and dollies or flatbed equipment with all the wheels off the ground. For more information, refer to "Towing" in chapter 6.

Dynamometer testing

A full-time 4WD vehicle must be tested on a special four wheel chassis dynamometer.

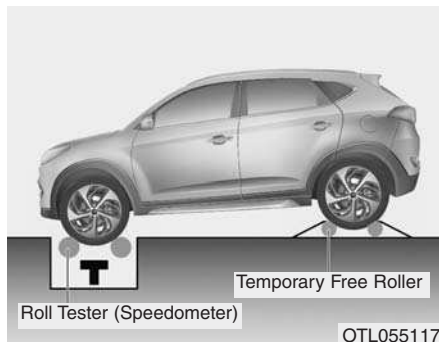

A full-time 4WD vehicle should not be tested on a 2WD roll tester. If a 2WD roll tester must be used, perform the following procedure:

1. Check the tire pressures recommended for your vehicle.
2. Place the front wheels on the roll tester for a speedometer test as shown in the illustration.
3. Release the parking brake.
4. Place the rear wheels on the temporary free roller as shown in the illustration.

⚠ CAUTION

- Never engage the parking brake while performing the test.
- When the vehicle is lifted up, do not operate the front and rear wheel separately. All four wheels should be operated.

⚠ WARNING

Keep away from the front of the vehicle while the vehicle is in gear on the dynamometer. The vehicle can jump forward and cause serious injury or death.

ISG (IDLE STOP AND GO) SYSTEM (IF EQUIPPED)

The ISG system is to reduce the fuel consumption by automatically shutting down the engine, when the vehicle is at a standstill (i.e. red stop light, stop sign, and traffic jam).

The engine is automatically started upon satisfying the starting conditions.

The ISG system is always active, when the engine is running.

i Information

When the engine is automatically started by the ISG system, some warning lights (i.e. ABS, ESC, ESC OFF, EPS, and parking brake warning light) may illuminate for a few seconds due to the low battery voltage. However, it does not indicate a malfunction with the ISG system.

To activate the ISG system

Auto stop

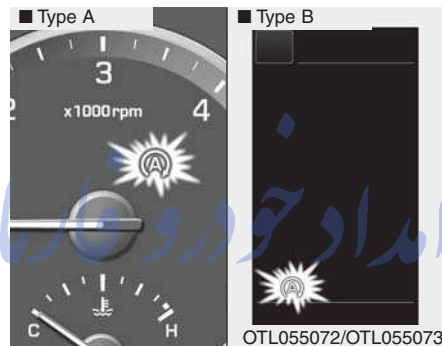

To stop the engine in idle stop mode

1. Lower the driving speed under 5 km/h (3 mph).
2. Set the gear in N (Neutral).
3. Release the clutch pedal.

The auto stop indicator ((A)) illuminates in green on the instrument cluster, when the engine stops.

i Information

The driving speed must reach at least 10 km/h (6 mph) after an idle stop.



OTLE055007

When the driver unfastens the seat-belt or open the driver's door (or the hood) in the auto stop mode, you will experience the followings.

- The ISG system is deactivated. (The ISG OFF button indicator illuminates.)

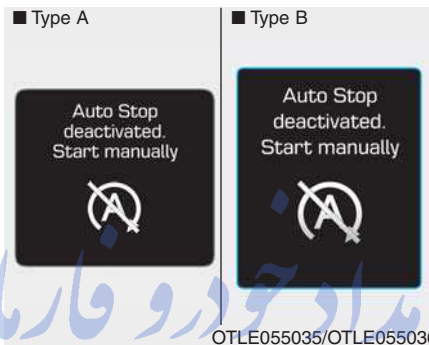

OTLE055035/OTLE055036

- The message, 'Auto Stop deactivated. Start manually', appears on the LCD display.

تلفن شبانه روزی: ۰۲۱-۸۸۸۶۲۰۸۵

FarmaSOS.com

Auto start

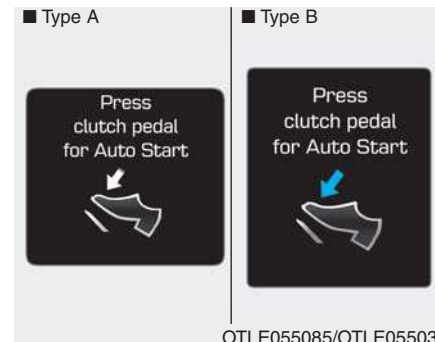

OTLE055085/OTLE055037

To restart the engine in the auto stop mode

- Depress the clutch pedal with the gear in N (Neutral).
- The message, "Press clutch pedal for Auto Start", appears on the LCD display.
- The auto stop indicator ((A)) goes OFF on the instrument cluster, when the engine is restarted.

The engine is automatically restarted in the following situations.

- The fan speed of the manual climate control system is set above the 3rd position, with the air condition ON.
- The fan speed of the automatic climate control system is set above the 6th position, with the air condition ON.
- A certain period of time has been elapsed with the air condition ON.
- The defroster is activated.
- The brake vacuum pressure is low.
- The battery is weak.
- The driving speed exceeds 5 km/h (3 mph).

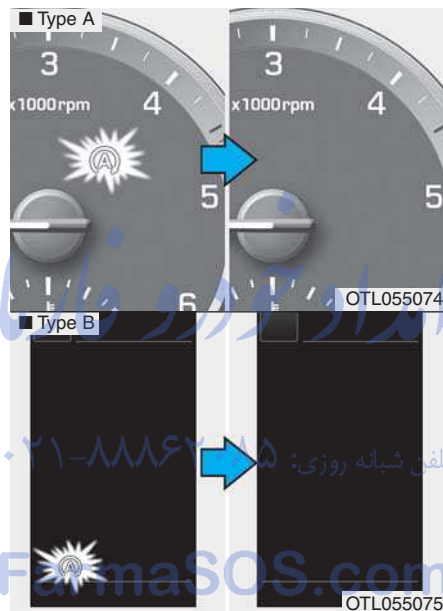

The auto stop indicator ((A)) blinks in green for 5 seconds on the instrument cluster,

Prerequisite for activation

The ISG system operates in the following situations.

- The driver's seatbelt is fastened.
- The driver's door and the hood are closed.
- The brake vacuum pressure is adequate.
- The battery is sufficiently charged.
- The outside temperature is between -2 °C and 35 °C (28.4 °F and 95 °F).
- The engine coolant temperature is not too low.



OTLE055007

■ Type A

■ Type B

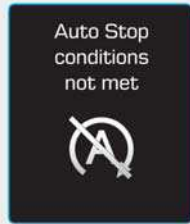

OTLE055039/OTLE055038

i Information

- The ISG system is not activated, when the prerequisites to activate the ISG system are unsatisfied. In this case, the ISG OFF button indicator illuminates, and the message, "Auto Stop conditions not met", appears on the LCD display.

(Continued)

(Continued)

- When the above indicator remains ON, and when the above message remains displayed, we recommend you to have the IGS system checked by an authorized HYUNDAI dealer.

امداد خودرو فارما

تلفن شبانه روزی: ۰۲۱-۸۸۸۶۲۰۸۵

FarmaSOS.com

To deactivate the ISG system



OTLE055004

- Press the ISG OFF button to deactivate the ISG system. Then, the ISG OFF button indicator illuminates, and the message, "Auto Stop Off", appears on the LCD display.
- Press the ISG OFF button again to reactivate the ISG system. Then, the ISG OFF button indicator turns OFF.

ISG system malfunction

The ISG system may not operate:

When there is a malfunction with the ISG sensors or the ISG system.

The followings occur, when there is a malfunction with the ISG system:

The auto stop indicator (A) remains ON in yellow after blinking for 5 seconds.



- The light on the ISG OFF button will illuminate.

i Information

- When you cannot turn OFF the ISG OFF button indicator by pressing the ISG OFF button, or when the malfunction with the ISG system persists, we recommend you to contact an authorized HYUNDAI dealer.

(Continued)

(Continued)

- You can turn off the ISG OFF button indicator by driving over 80 km/h (50 mph) for up to 2 hours with the fan speed below the 2nd position. If the ISG OFF button indicator remains ON, we recommend you to contact an authorized HYUNDAI dealer.

⚠ WARNING

When the engine is in auto stop mode, the engine may restart. Before leaving the vehicle or checking the engine compartment, stop the engine by placing the ignition switch to the LOCK/OFF position or removing the ignition key.

The battery sensor deactivation

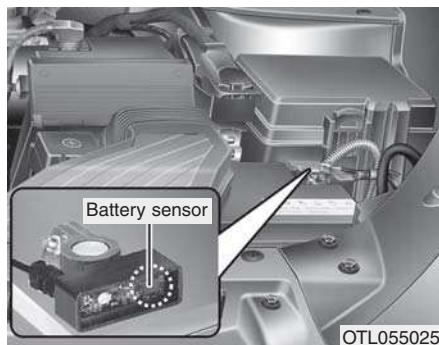

The battery sensor is deactivated, when the battery is disconnected from the negative pole for maintenance purpose.

In this case, the ISG system is limitedly operated due to the battery sensor deactivation. Thus, the driver needs to take the following procedures to reactivate the battery sensor after disconnecting the battery.

Prerequisites to reactivate the battery sensor

Keep the engine in the OFF status for 4 hours, and attempt to restart the engine 3 to 4 times for the battery-sensor reactivation.

Pay extreme caution not to connect any accessories (i.e. navigation and black box) to the vehicle with the engine in the OFF status. If not, the battery sensor may not be reactivated.

i Information

The ISG system may not operate in the following situations.

- There is a malfunction with the IGS system.
- The battery is weak.
- The brake vacuum pressure is low.

In those cases, we recommend you to have the ISG system checked by an authorized HYUNDAI dealer.

NOTICE

- Use only the genuine HYUNDAI ISG battery for replacement. If not, the ISG system may not normally operate.
- Do not recharge the ISG battery with a general battery charger. If not, it may damage or explode the ISG battery.
- Do not remove the battery cap. If not, the battery electrolyte, which is harmful to the human body, may leak out.

FLEX STEERING WHEEL (IF EQUIPPED)



The flex steering wheel controls the steering effort in accordance with the driver's preference and road conditions.

The driver can select a desired steering effort by pressing the steering mode button.

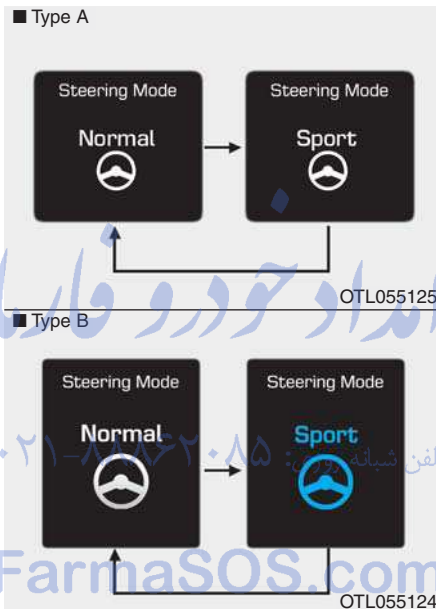

The steering mode options appear on the LCD display, when the driver presses the steering mode button.

Press the steering mode button within 4 seconds to scroll through the steering mode options.

If the steering mode button is not pressed within 4 seconds, the LCD display will change to the previous screen.

Normal mode

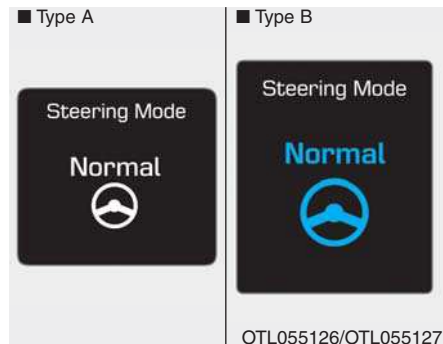

The normal steering mode offers normal steering effort.

Sport mode

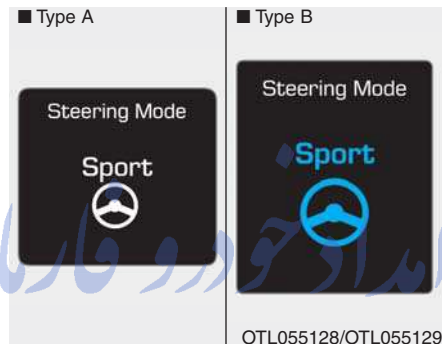

The sport steering mode offers high steering effort, making the wheel steering heavier. The sport steering mode is often used for driving on a highway.

FarmaSOS.com

⚠ CAUTION

- When the driver presses the steering mode button while driving, it changes the steering mode option on the LCD display. However, it does not immediately change the steering effort for your safety. Upon completing the wheel steering, the steering tension is automatically set to the selected mode.
- Pay great caution while changing through modes, when the vehicle is in motion.
- The flex steering wheel does not operate, when the Electric Power Steering (EPS) does not properly operate.

DRIVE MODE INTEGRATED CONTROL SYSTEM (IF EQUIPPED)

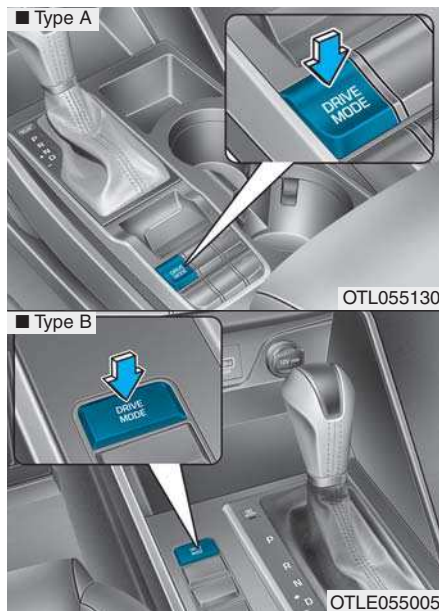

i Information

If there is a problem with the instrument cluster, the drive mode will be in **NORMAL** mode and may not change to **SPORT** mode.

The mode changes, as below, whenever the **DRIVE MODE** button is pressed.

SPORT ← → **NORMAL**

When **NORMAL** mode is selected, it is not displayed on the instrument cluster.

امداد خودرو فارما

تلفن شبانه روزی: ۰۲۱-۸۸۸۶۲۰۸۵

FarmaSOS.com

The drive mode may be selected according to the driver's preference or road condition.

The system resets to be in the **NORMAL** mode, when the engine is restarted.

SPORT mode

SPORT

SPORT mode manages the driving dynamics by automatically adjusting the steering wheel, engine and transaxle system.

- When the SPORT mode is selected by pressing the DRIVE MODE button, the SPORT indicator (yellow color) will illuminate.
- Restarting of the engine in the SPORT mode resets the DRIVE mode to the NORMAL mode. Thus, when necessary, reselect the SPORT mode.
- When the SPORT mode is activated:
 - The RPM (revolutions per minutes) level is maintained over a certain length of time, even after releasing the accelerator.
 - Up-shifting timing is delayed, while accelerating.

i Information

In the SPORT mode, the fuel efficiency may decrease.

امداد خودرو فارما

تلفن شبانه روزی: ۰۲۱-۸۸۸۶۲۰۸۵

FarmaSOS.com

BLIND SPOT DETECTION SYSTEM (BSD) (IF EQUIPPED)

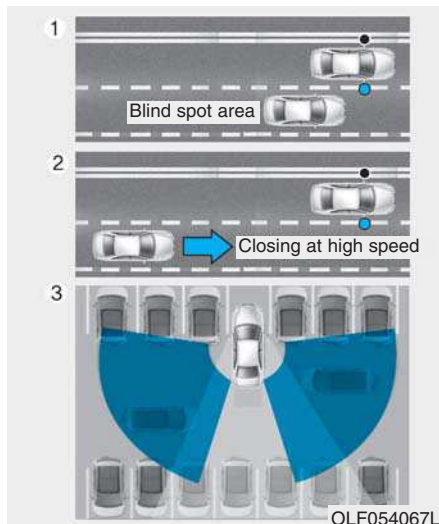

The Blind Spot Detection System (BSD) uses a radar sensor to alert the driver.

It monitors the rear area of the vehicle and provides information to the driver.

(1) BSD (Blind Spot Detection)

The detection range varies in accordance with a driving speed. When your vehicle faster than the other vehicles, the system will not warn you.

(2) LCA (Lane Change Assist)

When a vehicle approaches you at a high speed, the system will warn you.

(3) RCTA (Rear Cross Traffic Alert)

When your vehicle moves backwards, and when the sensor detects the approaching vehicle in the left and right side, the system will warn you.

⚠ WARNING

- Always check the road condition while driving for unexpected situations even though the Blind Spot Detection System (BSD) is operating.
- The Blind Spot Detection System (BSD) is a supplemental system to assist you. Do not entirely rely on the system. Always pay attention, while driving, for your safety.
- The Blind Spot Detection System (BSD) is not a substitute for proper and safe driving. Always drive safely and use caution when changing lanes or backing the vehicle up. The Blind Spot Detection System (BSD) may not detect every object alongside the vehicle.

FarmaSOS.com

BSD (Blind Spot Detection) / LCA (Lane Change Assist) (if equipped)

Operating conditions



To operate:

Press the BSD switch with the ignition switch in the ON position.

The indicator illuminates on the switch. If vehicle speed exceeds 30km/h (20 mph) the system will activate.

To cancel:

Press the BSD switch again. The indicator on the switch will go off.

When the system is not used, turn the system off by turning off the switch.

i Information

- If the engine is turned off then on again, the BSD system returns to the previous state.
- When the system is turned on, the warning light will illuminate for 3 seconds on the outside rearview mirror.

تلفن شبانه روزی: ۰۲۱-۸۸۸۶۲۰۸۵

FarmaSOS.com

Warning type

The system will activate when:

1. The system is on.
2. The vehicle speed is above about 30 km/h (20 mph).
3. Vehicles behind are detected.

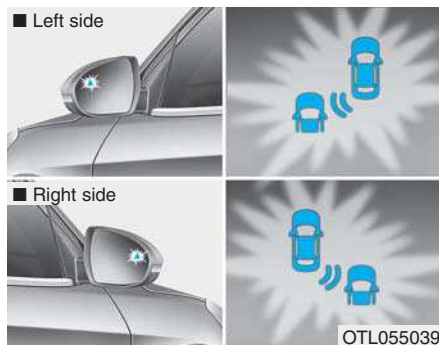

First stage alert

If a vehicle is detected within the boundary of the system, a warning light will illuminate on the outside rearview mirror.

If the detected vehicle is not in warning range, the warning will turn off according to driving conditions.



Second stage alert

The second stage alarm will activate when:

1. The first stage alert is on.
2. The turn signal light is on to change a lane.

When the second stage alert is activated, a warning light will blink on the outside rearview mirror and the alarm will sound.

If you turn off the turn signal light, the second stage alert will be deactivated.

Detecting sensor



The sensors are located inside the rear bumper.

Always keep the rear bumper clean for proper operation of the system.

Warning message



- This warning message may appear when :
 - There are foreign substances on the rear bumper
 - Driving in rural areas with little traffic or open terrains such as wide expanse of desert
 - There is heavy snow or rain

The light on the switch and the system will turn off automatically.

When the message is displayed due to a foreign substance, remove the foreign substance on the rear bumper. After the foreign substance is removed, if you drive for approximately 10 minutes, the system will work normally.

If the system does not operate normally after removing the substance or is not in a situation mentioned above, we recommend that you take your vehicle to an authorized HYUNDAI dealer and have the system checked.

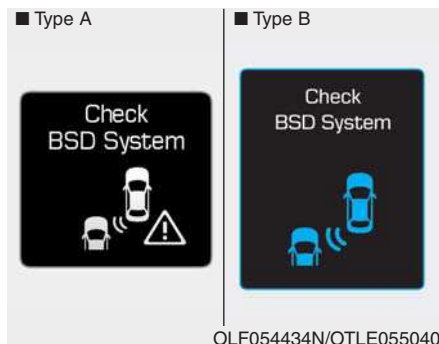

If there is a problem with the BSD system, a warning message will appear and the light on the switch will turn off. The system will turn off automatically. We recommend that you have your vehicle inspected by an authorized HYUNDAI dealer.

RCTA (Rear Cross Traffic Alert)

When your vehicle starts to move backwards after parking, the sensor detects any approaching vehicles from the left and right sides and warns the driver.

امداد خودرو فارما

تلفن شبانه روزی: ۰۲۱-۸۸۸۶۲۰۸۵

FarmaSOS.com

Operating conditions

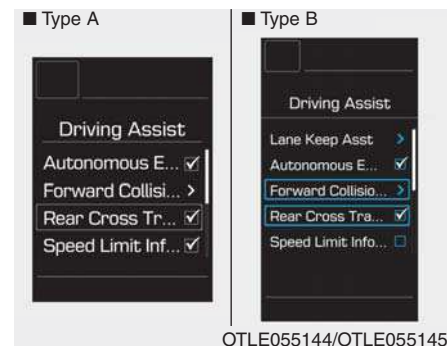

To operate:

Go to the User Settings mode (Driving Assist) and select Rear Cross Traffic Alert on the LCD display (**For more details, refer to "LCD Display" in chapter 3.**). The system will turn on and standby to activate. The system will activate when vehicle speed is below 10km/h (6.2mph) with the shift lever in R (Reverse).

i Information

The RCTA (Rear Cross Traffic Alert) detecting range is about 0.5m ~ 20m. A vehicle will be detected if the vehicle speed is 4km/h ~ 36km/h within the detecting range. However, the detecting range may change under different conditions. Always pay attention to the surroundings.

Warning type



If the vehicle detected by the sensors approaches your vehicle, the warning chime will sound, the warning light on the outside rearview mirror will blink and a message will appear on the LCD display.

i Information

- If the detected vehicle is out of the sensing range of your vehicle, move the vehicle away from the detected object slowly; the warning will be cancelled.
- The system may not operate properly due to other factors or circumstances. Always pay attention to your surrounding.
- If your vehicle's left or right side bumper is blinded by barrier or vehicles, the system sensing ability may be reduced.

⚠ WARNING

- The warning light on the outside rearview mirror will illuminate whenever a vehicle is detected at the rear side by the system.

To avoid accidents, do not focus only on the warning light and neglect to see the surrounding of the vehicle.

- Drive safely even though the vehicle is equipped with a Blind Spot Detection System (BSD) and Rear Cross Traffic Alert (RCTA). Do not solely rely on the system but check your surrounding before changing lanes or backing the vehicle up.

The system may not alert the driver in some conditions so always check the surroundings while driving.

(Continued)

(Continued)

- The Blind Spot Detection System (BSD) and Rear Cross Traffic Alert (RCTA) are not a substitute for proper and safe driving practices. Always drive safely and use caution when changing lanes or backing the vehicles up. The Blind Spot Detection System (BSD) may not detect every object alongside the vehicle.

NOTICE

- The system may not properly operate, when the bumper is replaced, or when a repair work is done near the sensor.
- The sensing range differs according to the roads width. When the road is narrow, the system may detect other vehicles in the next lane.
- The system may turn off due to strong electromagnetic waves.

Non-operating condition

Outside rearview mirror may not alert the driver when:

- The outside rearview mirror housing is damaged or covered with debris.
- The window is covered with debris.
- The windows are severely tinted.

DRIVER'S ATTENTION

The driver must be cautious in the below situations, because the system may not detect other vehicles or objects in certain circumstances.

- The vehicle drives on a curved road or through a tollgate.
- The sensor is polluted with rain, snow, mud, etc.
- The rear bumper, in which the sensor is located, is covered or blocked with a foreign matter such as a sticker, a bumper guard, a bicycle stand, etc.
- The rear bumper is damaged, or the sensor is out of the original default position.
- The vehicle height gets lower or higher due to heavy loading in a trunk, abnormal tire pressure, etc.
- The vehicle drives in a bad weather such as heavy rain or snow.

(Continued)

(Continued)

- There is a fixed object near the vehicle, such as a guardrail.
- A big vehicle is near such as a bus or truck.
- A motorcycle or bicycle is near.
- A flat trailer is near.
- If the vehicle has started at the same time as the vehicle next to you and has accelerated.
- When the other vehicle passes at a very fast speed.
- While changing lanes.
- While going down or up a steep road where the height of the lane is different.
- When the other vehicle approaches very close.
- When a trailer or carrier is installed.
- When the temperature near the rear bumper area is high or low.

(Continued)

(Continued)

- When the sensors are blocked by other vehicles, walls or parking-lot pillars.
- When the detected vehicle also moves back, as your vehicle drives back.
- If there are small things like shopping cart and baby carriage.
- If there is low height vehicle like sport vehicle.
- When other vehicles are close to your vehicle.
- When the vehicle in the next lane moves two lanes away from you OR when the vehicle two lanes away moves to the next lane from you.
- When driving on wet surface.

AUTONOMOUS EMERGENCY BRAKING (AEB) (IF EQUIPPED)

The AEB system is to reduce or to avoid accident risk. It recognizes the distance from the vehicle ahead or the pedestrian through the sensors (i.e. radar and camera), and, if necessary, warns the driver of accident risk with the warning message or the warning alarms.

WARNING

Take the following precautions when using the Autonomous Emergency Braking (AEB):

- **This system is only a supplemental system and it is not intended to, nor does it replace the need for extreme care and attention of the driver. The sensing range and objects detectable by the sensors are limited. Pay attention to the road conditions at all times.**
- **NEVER drive too fast in accordance with the road conditions or while cornering.**
- **Always drive cautiously to prevent unexpected and sudden situations from occurring. AEB does not stop the vehicle completely and does not avoid collisions.**

System setting and activation

System setting

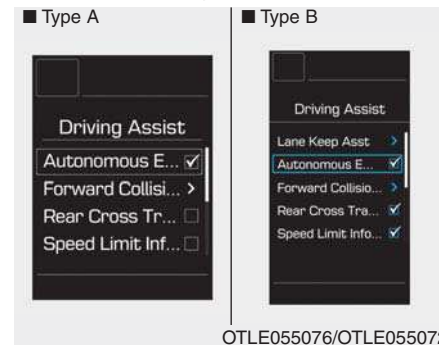

The driver can activate the AEB by placing the ignition switch to the ON position and by selecting 'User Settings', 'Driving Assist', and 'Autonomous Braking System'. The AEB deactivates, when the driver cancels the system setting.



The warning light illuminates on the LCD display, when you cancel the AEB system. The driver can monitor the AEB ON/OFF status on the LCD display. When the warning light remains ON with the AEB activated, we recommend you to have the system checked by an authorized HYUNDAI dealer.

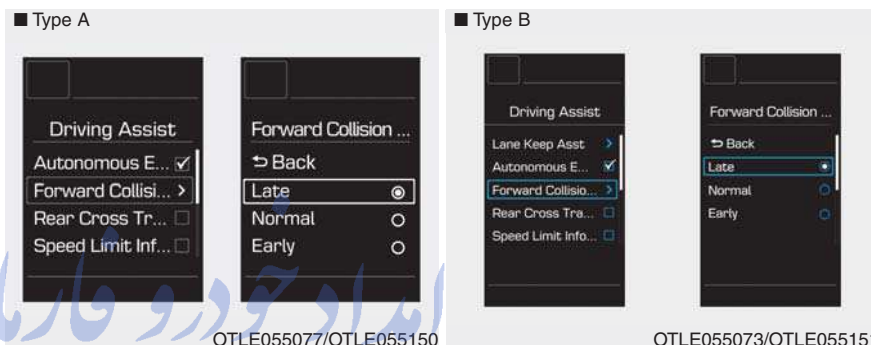

The driver can select the initial warning activation time in the User Settings in the instrument cluster LCD display. The options for the initial Forward Collision Warning include the following:

- **EARLY** - When this condition is selected, the initial Forward Collision Warning is activated earlier than normal. This setting maximizes the amount of distance between the vehicle or pedestrian ahead before the initial warning occurs.
- **NORMAL** - When this condition is selected, the initial Forward Collision Warning is activated normally. This setting allows for a nominal amount of distance between the vehicle or pedestrian ahead before the initial warning occurs.
- **LATE** - When this condition is selected, the initial Forward Collision Warning is activated later than normal. This setting reduces the amount of distance between the vehicle or pedestrian ahead before the initial warning occurs.

Prerequisite for activation

The AEB gets ready to be activated, when the AEB is selected on the LCD display, and when the following prerequisites are satisfied.

- The ESC is activated.
- To recognize the pedestrian: The driving speed is between 8 km/h and 70 km/h.
- To recognize the vehicle in front: The driving speed is between 8 km/h and 180 km/h. (However, for the occupants safety, if the driving speed exceeds 80 km/h, it does not induce any sharp braking, even though it controls the brakes.)

! WARNING

- **The AEB automatically activates upon placing the ignition switch to the ON position. The driver can deactivate the AEB by canceling the system setting on the LCD display.**
- **The AEB automatically deactivates upon canceling the ESC. When the ESC is canceled, the AEB cannot be activated on the LCD display.**

AEB warning message and system control

The AEB produces warning messages and warning alarms in accordance with the collision risk levels. Also, it controls the brakes in accordance with the collision risk levels.

تلفن شبانه روزی: ۰۲۱-۸۸۸۶۲۰۸۵

FarmaSOS.com

Forward Warning (1st warning)

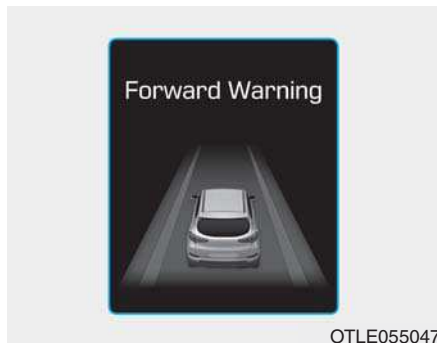

The warning message appears on the LCD display with the warning alarms.

Collision Warning (2nd warning)



- The warning message appears on the LCD display with the warning alarms.
 - Your driving speed decreases to a certain level.
- When the vehicle in front drives slower than 80 km/h, your driving speed may sharply decrease. When the vehicle in front drives faster than 80 km/h, your driving speed may gently decrease.

- When your vehicle drives slower than 70 km/h with a pedestrian in front, the driving speed may abruptly decrease. When your vehicle drives faster than 70 km/h with a pedestrian in front, the AEB does not operate.

Emergency braking (3rd warning)

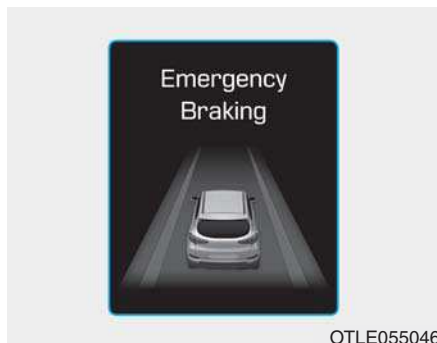

OTLE055046

- The warning message appears on the LCD display with the warning alarms.
- Your driving speed decreases to a certain level.
 - When the vehicle in front drives slower than 80 km/h, your driving speed may sharply decrease. When the vehicle in front drives faster than 80 km/h, your driving speed may gently decrease.

- When your vehicle drives slower than 70 km/h with a passer-by in front, the driving speed may abruptly decrease. When your vehicle drives faster than 70 km/h with a pedestrian in front, the AEB does not operate.

Brake operation

- In an urgent situation, the braking system enters into the ready status for prompt reaction against the driver's depressing the brake pedal.
- The AEB provides additional braking power for optimum braking performance, when the driver depresses the brake pedal.
- The braking control is automatically deactivated, when the driver sharply depresses the brake pedal, or when the driver abruptly operates the steering wheel.
- The braking control is automatically canceled, when risk factors disappear.

⚠ CAUTION

The driver should always pay great caution to vehicle operation, even though there is no warning message or warning alarm.

⚠ WARNING

The braking control cannot completely stop the vehicle nor avoid all collisions. The driver should hold the responsibility to safely drive and control the vehicle.

⚠ WARNING

The AEB operates in accordance with the risk levels, such as the distance from the vehicle/passer-by in front, the speed of the vehicle/passer-by in front, and the driver's vehicle operation.

Sensor to detect the distance from the vehicle in front (front radar)



OTLE055088

The sensor is to maintain a certain distance from the vehicle in front. However, the smudged sensor lens with foreign substances, such as snow and rain, adversely affects the sensing performance. It may even temporarily cancel the AEB. Always keep the sensor lens clean.

Warning message and warning light

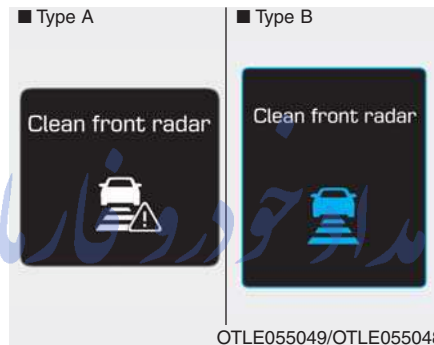

When the sensor cover or the sensor lens is smudged with the foreign substances, such as snow or rain, the AEB operation may temporarily stop. In this case, the warning message appears to warn the driver. This is not a malfunction with the AEB. To operate the AEB again, remove the foreign substances.

NOTICE

- Do not install any accessories, such as license plate molding or sticker, on the sensor area. Nor arbitrarily replace the bumper. Those may adversely affect the sensing performance.
- Always keep the sensor/bumper area clean.
- Use only soft clothes to wash the vehicle. Also, do not spray highly-pressurized water on the sensor installed on the bumper.
- Be careful not to apply unnecessary force on the frontal sensor area. When the sensor moves out of the correct position due to external force, the system may not normally operate even without the warning light or message. In this case, we recommend you to have the vehicle inspected by an authorized HYUNDAI dealer.
- Use only the genuine HYUNDAI sensor cover. Do not arbitrarily apply paint on the sensor cover.

System malfunction

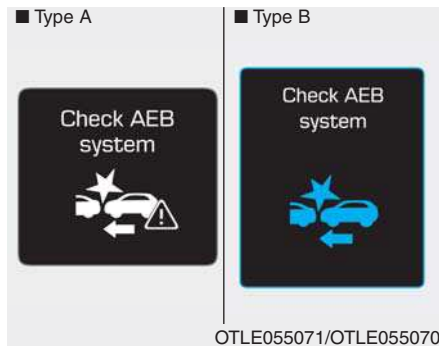

- When the AEB is not working properly, the AEB warning light (🚗) will illuminate and the warning message will appear for a few seconds. After the message disappears, the master warning light (⚠️) will illuminate. In this case, we recommend you to have the vehicle inspected by an authorized HYUNDAI dealer.
- The AEB warning message may appear along with the illumination of the ESC warning light.

⚠️ WARNING

- The AEB is only a supplemental system for the driver's convenience. The driver should hold the responsibility to control the vehicle operation. Do not solely depend on the AEB system. Rather, maintain a safe braking distance, and, if necessary, depress the brake pedal to lower the driving speed.
- The AEB may unnecessarily produce the warning message and the warning alarms. Also, due to the sensing limitation, the AEB may not produce the warning message and the warning alarm at all.
- When there is a malfunction with the AEB, the braking control does not operate upon detecting a collision risk even with other braking systems normally operating.

(Continued)

(Continued)

- The AEB operates only for the vehicle / pedestrian in front, while driving forward. It does not operate for any animals or vehicles in the opposite direction.
- The AEB does not recognize the vehicle, which horizontally drives across the crossroad, or the vehicle, which is parked in the horizontal direction.

Limitation of the system

The AEB monitors the driving situations through the radar and the camera sensor. Thus, for a situation out of the sensing range, the AEB may not normally operate. The driver should pay great caution in the following situations. The AEB operation may be limited.

Recognizing vehicles

- The radar or the camera is contaminated with foreign substances.
- It heavily rains or snows.
- There is interruption by electric waves.
- There is severe irregular reflection from the radar.
- The vehicle in front has a narrow body. (i.e. motor cycle and bicycle)
- The driver's view is unclear due to the backlight, the reflected light, or darkness.
- The camera cannot contain the full image of the vehicle in front.

- The vehicle in front is a special vehicle, such as a heavily-loaded truck or a trailer.
- The vehicle in front does not turn ON the rear lights, does not have rear lights, has asymmetric rear lights, or has rear lights out of angle.
- The outside brightness is greatly changed, such as entering/exiting the tunnel.
- The vehicle driving is unstable.
- The radar/camera sensor recognition is limited.

تلفن شبانه روزی: ۰۲۱-۸۸۸۶۲۰۸۵

FarmaSOS.com

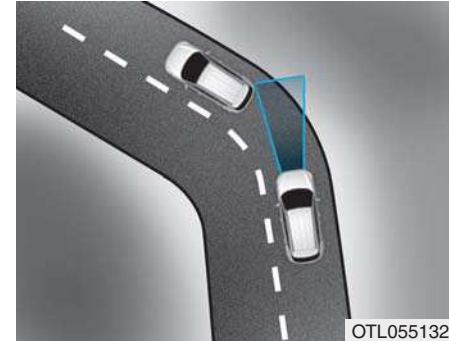

- Driving on a curve

The AEB performance decreases while driving on a curve. The AEB may not recognize the vehicle in front even in the same lane. It may unnecessarily produce the warning message and the warning alarm, or it may not produce the warning message and the warning alarm at all.

While driving on a curve, pay great caution, and, if necessary, depress the brake pedal.



While driving on a curve, the AEB may recognize the vehicle in front in the next lane. Pay great caution, and, if necessary, depress the brake pedal.

Or, depress the accelerator pedal to maintain the driving speed. Always, take a look around the vehicle for your safety.



- Driving on a slope

The AEB performance decreases while driving upward or downward on a slope, not recognizing the vehicle in front in the same lane. It may unnecessarily produce the warning message and the warning alarm, or it may not produce the warning message and the warning alarm at all.

When the AEB suddenly recognizes the vehicle in front while passing over a slope, you may experience sharp deceleration.

Always keep your eyes forward while driving upward or downward on a slope, and, if necessary, depress the brake pedal.

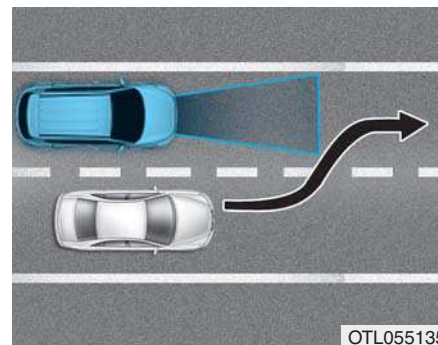

- Changing lanes

Even though the vehicle in the next lane enters into your lane, it may not be recognized by the AEB, until it enters the AEB sensing range.

Especially when the vehicle in the next lane abruptly enters into your lane, it is more likely not be recognized. Always pay great attention.

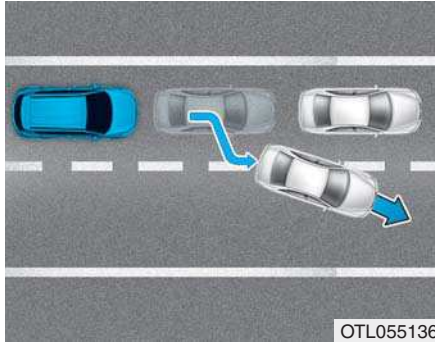

OTL055136

When the stopped vehicle in front gets out of the lane, it may not be recognized by your AEB. Always pay great attention.



OTL055137

- Recognizing the vehicle

When the vehicle in front has heavy loading extended rearward, or when the vehicle in front has higher ground clearance, it may induce a hazardous situation.

FarmaSOS.com

Recognizing pedestrians

- The pedestrian is not fully captured by the camera sensor, or the pedestrian does not walk in the upright position.
- The pedestrian moves very fast.
- The pedestrian abruptly appears in front.
- The pedestrian wears clothes in the color similar to the background.
- The outside is too bright or too dark.
- The vehicle drives at night or in the darkness.
- There is an item similar to a person's body structure.
- The pedestrian is small.
- The pedestrian has impaired mobility.
- It is difficult to distinguish the pedestrian from the surroundings.
- The sensor recognition is limited.
- There is a group of pedestrians.

WARNING

- Cancel the AEB in the User Settings on the LCD display, before towing another vehicle. While towing, the brake application may adversely affect your vehicle safety.
- Pay great caution to the vehicle in front, when it has heavy loading extended rearward, or when it has higher ground clearance.
- The sensor only detects pedestrian, not carts, bicycles, motorcycles, luggage bags, or strollers.
- The AEB does not operate in a certain situation. Thus, never test-operate the AEB against a person or an object. It may cause a severe injury or even death.

Information

The system may temporarily cancel due to the strong electric waves.

امداد خودرو فارما

تلفن شبانه روزی: ۰۲۱-۸۸۸۶۲۰۸۵

FarmaSOS.com

SPEED LIMIT INFORMATION FUNCTION (SLIF) (IF EQUIPPED)



The SLIF displays the speed limit information and no-overtaking restriction through the instrument cluster and the navigation. The SLIF reads the traffic signs through the camera, which is attached on the upper part of the inner front windshield.

The SLIF also utilizes the navigation information to display the speed limit information.

WARNING

- Speed Limit Information Function (SLIF) is only a supplemental system and is not always able to correctly display speed limits and overtaking restrictions.
- The driver still holds the responsibility not to exceed the designated speed limit.
- Do not install any accessories and stickers. Do not tint the front windshield, especially near the rearview mirror.

(Continued)

(Continued)

- The SLIF reads the traffic signs through the camera to display the speed limit information.

Therefore, the SLIF may not properly operate, when it is hard to detect the traffic signs. For further details, please refer to the 'Driver's Attention' in the same chapter.

- Do not arbitrarily modify or manipulate the camera components. Do not apply strong impact.
- Do not place objects on the dashboard that reflects light such as mirrors, white paper, etc. The system may malfunction if the sunlight is reflected.

System setting and activation

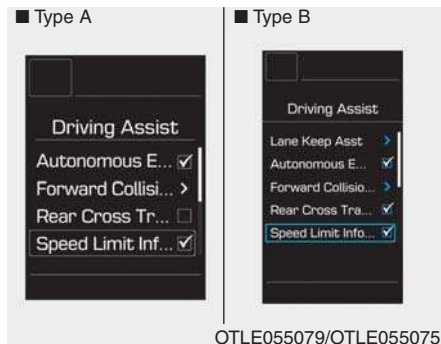

- System setting:

The driver can activate the SLIF by selecting 'User Settings', 'Driving Assist', and 'Speed Limit Information Function'.
 - When the SLIF is activated, the symbols appear on the instrument cluster to display the speed limit information and no-overtaking restriction.
 - When the SLIF is activated in the navigation setting, the above information and the restriction are also displayed on the navigation.
- The SLIF displays the speed limit information and alerts the no-overtaking restriction, when your vehicle passes by the relevant traffic signs.
 - The SLIF restores the previous speed limit information, right after the ignition switch is placed to the ON position.
 - You may find different speed limit information for the same road. The information is displayed depending on the driving situations. Because, traffic signs with additional sign (e.g. rainy, arrow, etc.) are also detected and compared with vehicle interior data (e.g. wiper operation, turn signal, etc.).
 - The SLIF automatically updates the speed limit information in the following situations.
 - The vehicle changes driving direction, or makes a U-turn.
 - The vehicle enters or exits from a highway, country road, etc.
 - The vehicle enters or exits from a town, village, etc.

Information

The speed limit information on the instrument cluster may differ from the one on the navigation. In this case, check the speed unit setting on the navigation.

Display

■ No reliable speed limit information

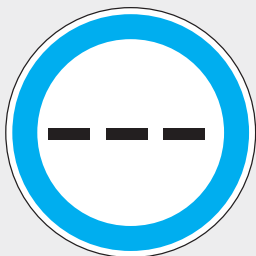

WTL-220

- The symbol is displayed on the instrument cluster and the navigation, when the SLIF does not detect any reliable speed limit information.

■ No passing information



WTL-222/WTL-221

- The symbol is displayed on the instrument cluster and the navigation, when the SLIF detects a no-overtaking sign.

■ Unlimited speed (only in Germany)



WUM-205

- The symbol, 'end of limitation', is displayed on the instrument cluster for the roads in Germany, which have no speed limit applicable. It is displayed, until the vehicle passes by another speed limit sign.

FarmaSOS.com

Warning message

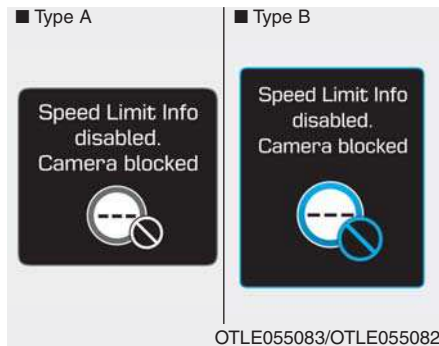

The warning message appears, when the camera lens is blocked by some objects. The SLIF does not operate, until the objects are removed. If the problem persists after removing the objects, we recommend you to have the system checked by an authorized HYUNDAI dealer.

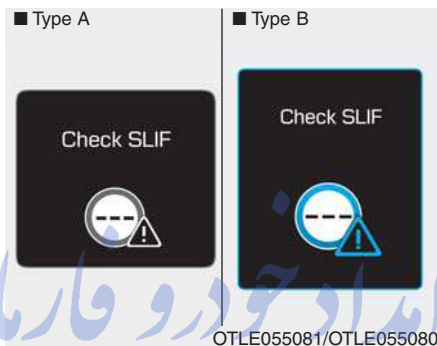

The warning message appears for a few seconds, when the SLIF does not properly operate. Then, the master warning light (⚠) will illuminate. We recommend you to have the system checked by an authorized HYUNDAI dealer.

The SLIF may not operate or may not provide correct information in the following situations.

- The traffic sign is located on a sharp curve.
- The traffic sign is improperly positioned (i.e. being turned over, blocked by an object, and damaged).
- Another vehicle blocks the traffic sign.
- The LED light of the traffic sign is broken.
- The weather is bad, such as raining, snowing, and fogging.
- There is sunlight glare around the traffic sign due to low solar altitude.
- It is dark at night.
- There is bright light around the traffic sign.
- There is dirt, ice or frost on the front windshield, where the camera is installed.
- The camera lens is blocked by an object, such as sticker, paper, or fallen leaf.

- Your vehicle drives right after another vehicle.
- There is a malfunction with the navigation.
- The bus or truck, on which the speed sticker is attached, passes by your vehicle.
- Your vehicle drives in an area, which is uncovered by the navigation system.
- Your navigation has not been updated.

DRIVER'S ATTENTION

The driver must be cautious in the following situations. The SLIF may not assist the driver and may not properly operate.

- Do not attach anything, such as sticker, on the front windshield, where the camera is installed. It may adversely affect the SLIF and cause a malfunction with the SLIF.
- Keep the front windshield clean, especially behind the interior rearview mirror.
- Do not place any objects, which have reflective surface, such as a mirror and white paper, on the instrument cluster.
- Do not arbitrarily modify or manipulate the camera, such as touching the lens and unscrewing the camera unit.
- The SLIF is merely a supplemental system. It may not operate in a certain situation.

- The SLIF is only to assist the driver. The driver should pay great caution to the vehicle operation.
- The driver always holds the responsibility of safe driving by following the applicable road traffic rule(s) and regulation(s).

LANE KEEPING ASSIST SYSTEM (LKAS) (IF EQUIPPED)

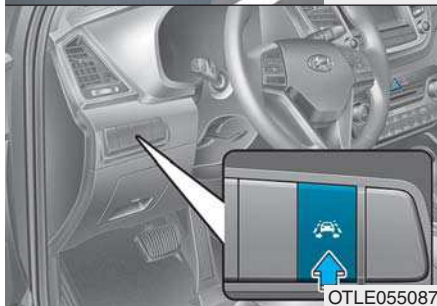

The Lane Keeping Assist System detects lane lines on the road, and assists the driver's steering to help keep the vehicle between lanes.

When the system detects the vehicle straying from its lane, it alerts the driver with a visual and audible warning, while applying a slight counter-steering torque, trying to prevent the vehicle from moving out of its lane.

WARNING

The Lane Keeping Assist System is not a substitute for safe driving practices, but a convenience function. It is the responsibility of the driver to always be aware of the surrounding and steer the vehicle.

FarmaSOS.com

WARNING

Take the following precautions when using the Lane Keeping Assist System (LKAS):

- The steering wheel is not continuously controlled so if the vehicle speed is at a higher rate when leaving a lane the vehicle may not be controlled by the system.
- Do not steer the steering wheel suddenly when the steering wheel is being assisted by the system.
- LKAS prevents the driver from moving out of the lane unintentionally by assisting the driver's steering. However, the driver should not solely rely on the system but always pay attention on the steering wheel to stay in the lane.

(Continued)

(Continued)

- Always check the road condition and surroundings and be cautious when the system cancels, does not operate or malfunctions.
 - Do not install any accessories and stickers. Do not tint the front windshield, especially near the rearview mirror.
 - The system detects lane lines and controls the steering wheel by a camera, therefore, if the lane lines are hard to detect, the system may not work properly.
- Please refer to "Driver's Attention".
- Do not arbitrarily modify or manipulate the LKAS components. Do not apply strong impact.
 - Do not place objects on the dashboard that reflects light such as mirrors, white paper, etc. The system may malfunction if the sunlight is reflected.

(Continued)

(Continued)

- The operation of the LKAS can be affected by several factors (including environmental conditions). It is the responsibility of the driver to pay attention to the roadway and to maintain the vehicle in its lane at all times.
- Always have your hands on the steering wheel while the LKAS system is activated. If you continue to drive with your hands off the steering wheel after the "Keep hands on steering wheel" warning message appears, the system will turn off automatically.
- Always be cautious when using the system.

LKAS operation



To turn ON the LKAS, press the switch, after turning ON the ignition switch. The indicator illuminates on the instrument cluster. To turn OFF the LKAS, press the switch again.

LKAS indicator illuminate in 3 colors as follows:

- [Green]
 - When the system operating conditions are satisfied.
- [White]
 - The system operating conditions are not satisfied.
- [Yellow]
 - There is a malfunction with the LKAS. In this case, we recommend you to have your vehicle inspected by an authorized HYUNDAI dealer.

LKAS activation

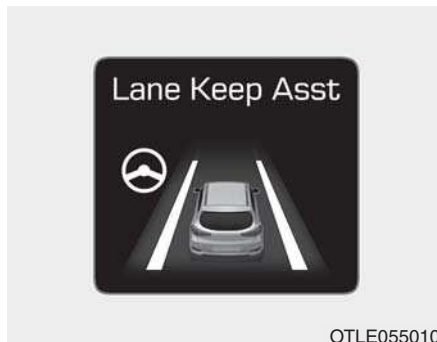

- The LKAS screen will appear on the LCD display if the system is activated.
- When both lane lines are detected and all the conditions to activate the LKAS are satisfied (steering wheel indicator will illuminate and the LKAS indicator light will change from white to green), the steering wheel will be controlled.

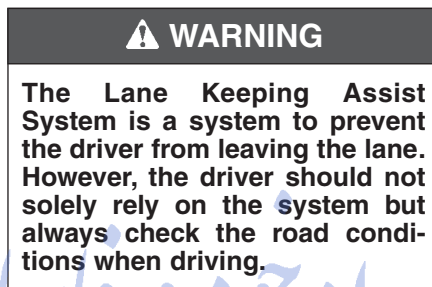

تلفن شبانه روزی: ۰۲۱-۸۸۸۶۲۰۸۵

FarmaSOS.com



When the system detects a lane line, the color changes from gray to white.



- When the system detects the left lane line, the left lane line color will change from gray to white.
- When the system detects the right lane line, the right lane line color will change from gray to white.
- Both lane lines must be detected for the system to fully activate.

Warning



- When the steering wheel appears, the system will control the vehicle's steering to prevent the vehicle from crossing the lane line.
- When you cross a lane line while the steering wheel is being controlled, the lane line you cross will blink on the LCD display and a warning alarm will sound.
- When all the conditions to activate LKAS is not satisfied, the system will convert to LDWS and warn the driver only when the driver crosses the lane lines.



When the driver takes one's hands off the steering wheel while the LKAS is activated, the system will warn the driver after several seconds with a visual and acoustic warning.

⚠ WARNING

The warning message may appear late according to road conditions. Therefore, always have your hands on the steering wheel while driving.

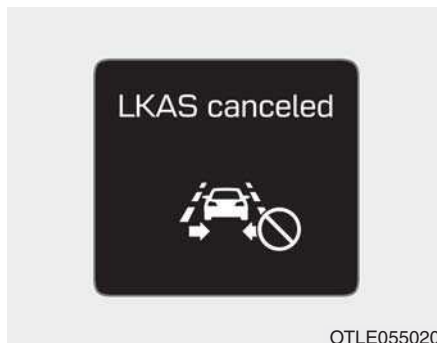

When the driver still does not have one's hand on the steering wheel after several seconds, the system will be automatically turned off.

WARNING

- **The driver is responsible for accurate steering.**
- **Turn off the system and drive the vehicle in below situations.**
 - In bad weather
 - In bad road condition
 - When the steering wheel needs to be controlled by the driver frequently.

Information تلفن شبانه روزی: ۸۵ ۱۱۱۶۳۰۰۰

- Even though the steering is assisted by the system, the driver may control the steering wheel.
- The steering wheel may feel heavier when the steering wheel is assisted by the system than when it is not.

The steering wheel will not be assisted when:

- Vehicle speed is below 60 km/h (37.3 mph) and over 180 km/h (111.8 mph).
- Only one lane line is detected.
- The turn signal is turned on before changing a lane. If you change lanes without the turn signal on, the steering wheel might be controlled.
- The hazard warning flasher is on.
- The width of the lane is below 2.8 m (9.2 ft) and over 4.5 m (18 ft).
- ESC (Electronic Stability Control) is activated.
- The vehicle is driven on a sharp curve.
- The vehicle brakes suddenly.
- The vehicle makes sharp lane changes.

Information

When the system is turned on or right after changing a lane, drive in the middle of the lane. If not, the system will not provide steering assist function.

DRIVER'S ATTENTION

The driver must be cautious in the below situations, because the system may fail to properly warn the driver.

- The lane is invisible due to snow, rain, stain, puddles or others.
- The outside brightness level suddenly changes, such as driving through a tunnel.
- The headlamp is turned OFF or weak in the night time or inside a tunnel.
- It is difficult to discern the lane colors from the road.
- The vehicle driven is on a steep slope or a curve.
- Lights, such as sunlight, street light or lights from other vehicles, reflect from the water on the road.
- The lens or windshield is stained with foreign substances.
- The sensor cannot detect the lanes because of fog, heavy rain or heavy snow.
- The temperature surrounding the inside rearview mirror is extremely high due to direct sunlight.
- The lane is very wide or narrow.
- The lane line is damaged or indistinct.
- The shadow of median strips cast on the lane lines.
- There are similar marks to lane lines.
- There is a boundary structure.
- The distance from a vehicle in front is very short. So, its shadow casts on the lane lines in front.
- The vehicle is violently shaken.
- The number of lane lines increases or decreases, or the lane lines cross each other in a complicated manner.
- Something is placed above the front panel.
- There are more than two lane lines.
- The lane lines are indiscernible due to dust or grease inside a tunnel.
- The lane lines are indiscernible after raining at night.
- The lane lines are indiscernible due to dust.
- The vehicle drives against sunlight.
- The vehicle drives in a construction area.
- The vehicle drives through a toll plaza or tollgate.
- There is a boundary structure in the roadway such as a concrete barrier, guardrail and reflector post that is inadvertently being detected by the camera.

LKAS malfunction



When there is a problem with the system a message will appear for a few seconds. If the problem continues the LKAS failure indicator will illuminate.

LKAS failure indicator

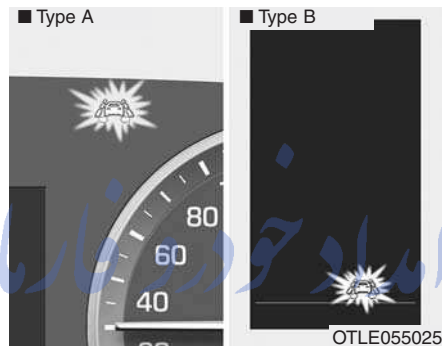

The LKAS failure indicator (yellow) will illuminate if the LKAS is not working properly. We recommend that the system be checked by an authorized HYUNDAI dealer.

When there is a problem with the system do one of the following:

- Turn the system on after turning the engine off and on again.
- Check if the ignition switch is in the ON position.
- Check if the system is affected by the weather. (ex: fog, heavy rain, etc.)
- Check if there is foreign matter on the camera lens.

If the problem is not solved, we recommend that the system be checked by an authorized HYUNDAI dealer.

FarmaSOS.com

LKAS function change

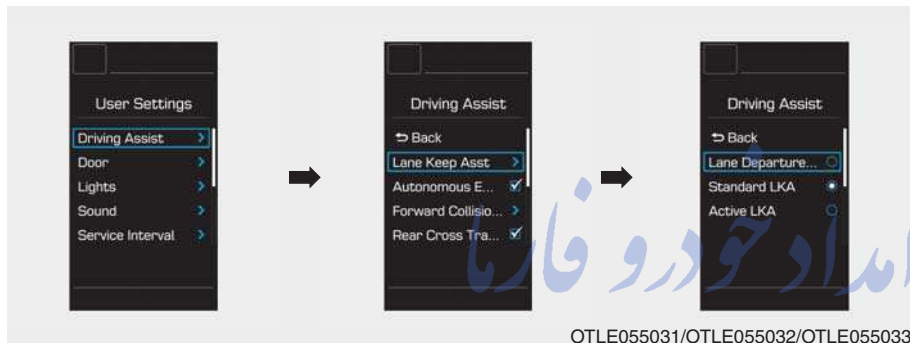

The driver can change LKAS to Lane Departure Warning System (LDWS) or change the LKAS mode between Standard LKA and Active LKA from the User Settings mode on the LCD display. The system is automatically set to Standard LKA if a function is not selected.

Lane Departure Warning System (LDWS)

LDWS alerts the driver with a visual warning and a warning alarm when the system detects the vehicle departing the lane. The steering wheel will not be controlled.

FarmaSOS.com

Standard LKA

The Standard LKA mode guides the driver to keep the vehicle within the lanes. It rarely controls the steering wheel, when the vehicle drives well inside the lanes. However, it starts to control the steering wheel, when the vehicle is about to deviate out of the lanes.

Active LKA

The Active LKA mode provides further intensified steering wheel control to relieve the driver's fatigue in a long-distance driving, in comparison with the Standard LKA mode. The driver may feel that its lane-keeping assistance is weaker than the Standard LKA mode (the driver may not nearly feel the onset of the wheel-steering control, because it has kept actively controlling the steering wheel even within the lanes). However, it reduces the driver's fatigue level in a long-distance driving by actively controlling the steering wheel even within the lanes.

FarmaSOS.com

SPEED LIMIT CONTROL SYSTEM (IF EQUIPPED)

Speed Limit Control Operation

You can set the speed limit when you do not want to drive over a specific speed.



If you drive over the preset speed limit, the warning system operates (set speed limit will blink and chime will sound) until the vehicle speed returns within the speed limit.

i Information

While speed limit control is in operation, the cruise control system cannot be activated.



Speed limit control switch



-  : Turns speed limit control system on or off.
-  : Changes mode between cruise control system and speed limit control system.
- RES+: Resumes or increases speed limit control speed.
- SET-: Sets or decreases speed limit control speed.

To set speed limit



1. Press the  button on the steering wheel, and then press the  button to turn the system on. The speed limit indicator in the instrument cluster will illuminate.

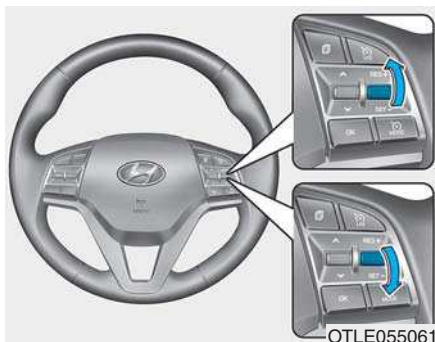

2. Push the lever down (SET-).
3. • Push the lever up (RES+) or down (SET-), and release it at the desired speed.
 - Push the lever up (RES+) or down (SET-) and hold it. The speed will increase or decrease by 5 km/h.

The set speed limit will display on the instrument cluster.

If you would like to drive over the pre-set speed limit when you depress the accelerator pedal less than approximately 50%, the vehicle speed will maintain within speed limit.



However if you depress the accelerator pedal more than approximately 70%, you can drive over the speed limit. Then the set speed limit will blink and chime will sound until you return the vehicle speed within the speed limit.

تلفن شبانه روزی: ۰۲۱-۸۸۸۶۲۰۸۵

FarmaSOS.com

To turn off the speed limit control, do one of the following:



- Press the  button.
- Press the  button. The Cruise Control System will turn on.

CRUISE CONTROL (WITH SPEED LIMIT CONTROL) (IF EQUIPPED)

Cruise Control Operation



1. CRUISE indicator
2. SET indicator

The Cruise Control system allows you to drive at speeds above 30 km/h (20 mph) without depressing the accelerator pedal.

! WARNING

Take the following precautions:

- If the Cruise Control is left on, (CRUISE indicator light in the instrument cluster illuminated) the Cruise Control can be activated unintentionally. Keep the Cruise Control system off (CRUISE indicator light OFF) when the Cruise Control is not in use, to avoid inadvertently setting a speed.
- Use the Cruise Control system only when traveling on open highways in good weather.
- Do not use the Cruise Control when it may be unsafe to keep the vehicle at a constant speed:
 - Driving in heavy or varying speed traffic.
 - On slippery (rainy, icy or snow covered) roads.
 - Hilly or winding roads.
 - Very windy areas.
- Do not use cruise control when towing a trailer.

NOTICE



During cruise-speed driving of a manual transaxle vehicle, do not shift into neutral without depressing the clutch pedal, since the engine will be overrevved. If this happens, depress the clutch pedal or press the cruise control ON / OFF button.

i Information

- During normal cruise control operation, when the SET switch is activated or reactivated after applying the brakes, the cruise control will energize after approximately 3 seconds. This delay is normal.
- To activate cruise control, depress the brake pedal at least once after turning the ignition switch to the ON position or starting the engine. This is to check if the brake switch which is important part to cancel cruise control is in normal condition.



Cruise control switch



-  : Turns cruise control system on or off.
-  : Changes mode between cruise control system and speed limit control system.
- RES+ : Resumes or increases cruise control speed.
- SET- : Sets or decreases cruise control speed.

To set Cruise Control speed



1. Press the  button on the steering wheel to turn the system on. The  indicator will illuminate.
2. Accelerate to the desired speed, which must be more than 30 km/h (20 mph).

Information

For manual transaxle vehicles, you should depress the brake pedal at least once to set the cruise control after starting the engine.



3. Push the lever (1) down (SET-), and release it. The SET indicator light will illuminate.
4. Release the accelerator pedal.

Information

On a steep slope, the vehicle may slightly slow down or speed up, while driving uphill or downhill.

To increase Cruise Control speed



OTLE055059

- Push the lever (1) up (RES+) and hold it, while monitoring the SET speed on the instrument cluster. Release the lever when the desired speed is shown and the vehicle will accelerate to that speed.
- Push the lever (1) up (RES+) and release it immediately. The cruising speed will increase 2.0 km/h (1.2 mph) each time the lever is operated in this manner.

- Depress the accelerator pedal. When the vehicle attains the desired speed, push the lever (1) down (SET-).

امداد خودرو فارما

تلفن شبانه روزی: ۰۲۱-۸۸۸۶۲۰۸۵

FarmaSOS.com

To decrease Cruise Control speed



OTLE055058

- Push the lever (1) down (SET-) and hold it. Your vehicle will gradually slow down. Release the lever at the speed you want to maintain.
- Push the lever (1) down (SET-) and release it immediately. The cruising speed will decrease 2.0 km/h (1.2 mph) each time the lever is operated in this manner.
- Lightly tap the brake pedal. When the vehicle attains the desired speed, push the lever (1) down (SET-).



To temporarily accelerate with the Cruise Control ON

Depress the accelerator pedal. When you take your foot off the accelerator, the vehicle will return to the previously set speed.

If you push the lever down (SET-) at the increased speed, the Cruise Control will maintain the increased speed.



Cruise Control will be canceled when:



- Depressing the brake pedal.
- Depressing the clutch pedal. (for manual transaxle vehicle)
- Pressing the  button located on the steering wheel.
- Pressing the  button. The Speed Limit Control System will turn on.
- Moving the shift lever into N (Neutral). (for automatic transaxle / dual clutch transmission vehicle)

- Decreasing the vehicle speed lower than the memory speed by 20 km/h (12 mph).
- Decreasing the vehicle speed to less than approximately 30 km/h (20 mph).
- The ESC (Electronic Stability Control) is operating.
- Downshifting to the 2nd gear in Sports Mode.

Information

Each of the above actions will cancel Cruise Control operation (the SET indicator light in the instrument cluster will go off), but only pressing the  button will turn the system off. If you wish to resume Cruise Control operation, push the lever up (RES+) located on your steering wheel. You will return to your previously preset speed, unless the system was turned off using the  button.

To resume preset Cruising speed

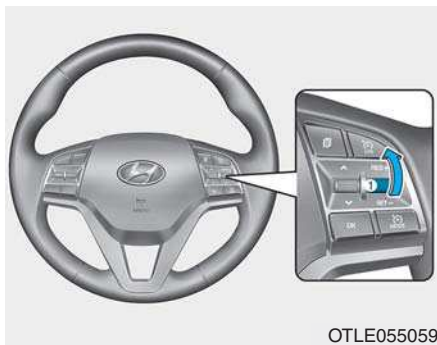



OTLE055059

Push the lever (1) up (RES+). If the vehicle speed is over 30 km/h (20 mph), the vehicle will resume the preset speed.

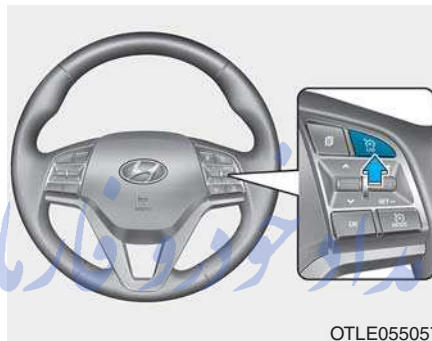
To turn Cruise Control off



OTLE055057

- Press the  button (the  indicator will go off).
- Turn the engine OFF.

FarmaSOS.com

CRUISE CONTROL (IF EQUIPPED)

Cruise Control operation

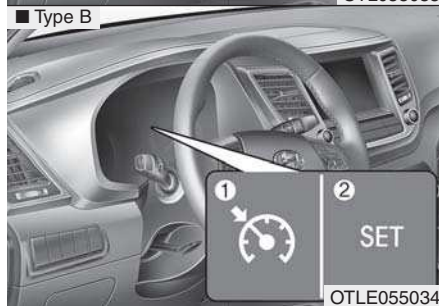
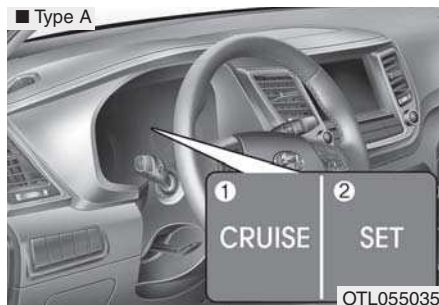

1. CRUISE indicator
2. SET indicator

The Cruise Control system allows you to drive at speeds above 30 km/h (20 mph) without depressing the accelerator pedal.

⚠ WARNING

Take the following precautions:

- If the Cruise Control is left on, (CRUISE indicator light in the instrument cluster is illuminated) the Cruise Control can be activated unintentionally. Keep the Cruise Control system off (CRUISE indicator light OFF) when the Cruise Control is not in use, to avoid inadvertently setting a speed.
- Use the Cruise Control system only when traveling on open highways in good weather.

(Continued)

(Continued)

- Do not use the Cruise Control when it may be unsafe to keep the vehicle at a constant speed:
 - Driving in heavy or varying speed traffic.
 - On slippery (rainy, icy or snow covered) roads.
 - Hilly or winding roads.
 - Very windy areas.
- Do not use cruise control when towing a trailer.

NOTICE

During cruise-speed driving of a manual transaxle vehicle, do not shift into neutral without depressing the clutch pedal, since the engine will be overrevved. If this happens, depress the clutch pedal or press the cruise control ON / OFF button.

i Information

- During normal cruise control operation, when the SET switch is activated or reactivated after applying the brakes, the cruise control will energize after approximately 3 seconds. This delay is normal.
- To activate cruise control, depress the brake pedal at least once after turning the ignition switch to the ON position or starting the engine. This is to check if the brake switch which is important part to cancel cruise control is in normal condition.



Cruise control switch

CANCEL/O : Cancels cruise control operation.

CRUISE /  : Turns cruise control system on or off.

RES+ : Resumes or increases cruise control speed.

SET- : Sets or decreases cruise control speed.

To set Cruise Control speed



1. Press the CRUISE /  button on the steering wheel to turn the system on. The CRUISE indicator will illuminate.

- Accelerate to the desired speed, which must be more than 30 km/h (20 mph).

i Information - Manual transaxle

For manual transaxle vehicles, you should depress the brake pedal at least once to set the cruise control after starting the engine.



- Push the lever (1) down (SET -), and release it. The SET indicator light will illuminate.
- Release the accelerator pedal.

i Information

On a steep slope, the vehicle may slightly slow down or speed up, while driving uphill or downhill.

To increase Cruise Control speed

■ Type A

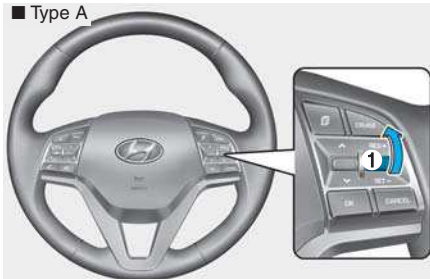

OTL055102

■ Type B

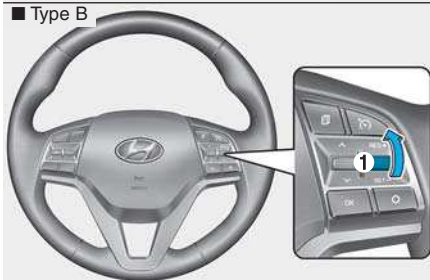

OTLE055052

- Push the lever (1) up (RES+) and hold it, while monitoring the SET speed on the instrument cluster.

Release the lever when the desired speed is shown and the vehicle will accelerate to that speed.

- Push the lever (1) up (RES+) and release it immediately. The cruising speed will increase 2.0 km/h (1.2 mph) each time the lever is operated in this manner.
- Depress the accelerator pedal. When the vehicle attains the desired speed, push the lever (1) down (SET-).

تلفن شبانه روزی: ۰۲۱-۸۸۸۶۲۰۸۵

FarmaSOS.com

To decrease Cruise Control speed

■ Type A



OTL055101

■ Type B

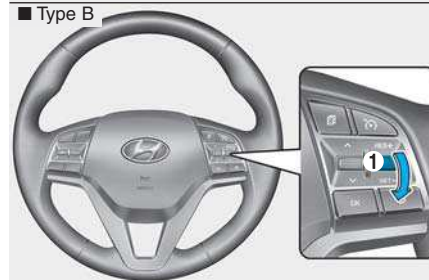

OTLE055051

- Push the lever (1) down (SET-) and hold it. Your vehicle will gradually slow down. Release the lever at the speed you want to maintain.

- Push the lever (1) down (SET-) and release it immediately. The cruising speed will decrease 2.0 km/h (1.2 mph) each time the lever is operated in this manner.
- Lightly tap the brake pedal. When the vehicle attains the desired speed, push the lever (1) down (SET-).

To temporarily accelerate with the Cruise Control ON

Depress the accelerator pedal. When you take your foot off the accelerator, the vehicle will return to the previously set speed.

If you push the lever down (SET-) at the increased speed, the Cruise Control will maintain the increased speed.

امداد خودرو فارما

تلفن شبانه روزی: ۰۲۱-۸۸۸۶۲۰۸۵

FarmaSOS.com

Cruise Control will be canceled when:

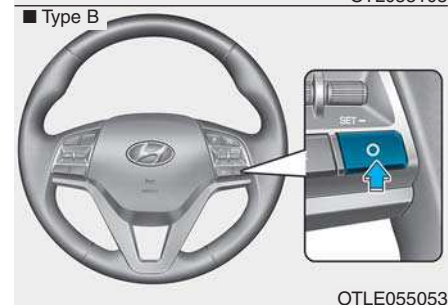
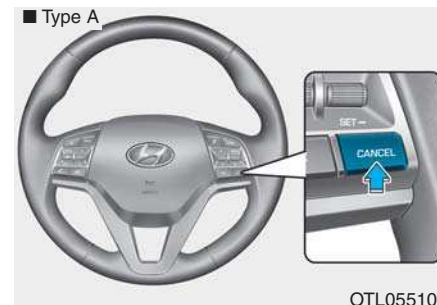

- Depressing the brake pedal.
- Depressing the clutch pedal. (for manual transaxle vehicle)

- Pressing the CANCEL / O button located on the steering wheel.
- Pressing the CRUISE /  button. Both the CRUISE indicator and the SET indicator will turn OFF.
- Moving the shift lever into N (Neutral). (for automatic transaxle / dual clutch transmission vehicle)
- Decreasing the vehicle speed lower than the speed by 20 km/h (12 mph).
- Decreasing the vehicle speed to less than approximately 30 km/h (20 mph).
- The ESC (Electronic Stability Control) is operating.
- Downshifting to the 2nd gear in Sports Mode.

Information

Each of the above actions will cancel Cruise Control operation (the SET indicator light in the instrument cluster will go off), but only pressing the CRUISE button will turn the system off. If you wish to resume Cruise Control operation, push the lever up (RES+) located on your steering wheel. You will return to your previously preset speed, unless the system was turned off using the CRUISE button.

تلفن شبانه روزی: ۰۲۱-۸۸۶۲۰۸۵

FarmaSOS.com

To resume preset Cruising speed

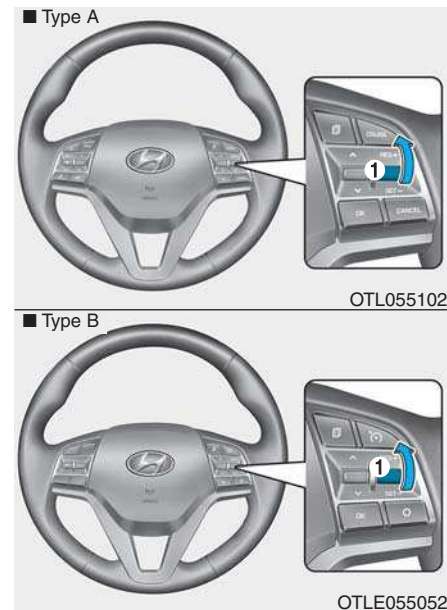

Push the lever (1) up (RES+). If the vehicle speed is over 30 km/h (20 mph), the vehicle will resume the preset speed.

To turn Cruise Control off

■ Type A



OTL055100

■ Type B



OTLE055050

- Press the CRUISE /  button (the CRUISE indicator light will go off).
- Turn the engine OFF.

امداد خودرو فارما

تلفن شبانه روزی: ۰۲۱-۸۸۸۶۲۰۸۵

FarmaSOS.com

SPECIAL DRIVING CONDITIONS

Hazardous driving conditions

When hazardous driving elements are encountered such as water, snow, ice, mud and sand, take the bellow suggestions:

- Drive cautiously and keep a longer braking distance.
- Avoid abrupt braking or steering.
- When your vehicle is stuck in snow, mud, or sand, use the second gear. Accelerate slowly to avoid unnecessary wheel spinning.
- Put sand, rock salt, tire chains or other non-slip materials under the wheels to provide additional traction while being stuck in ice, snow, or mud.

WARNING

Downshifting with an automatic transaxle while driving on slippery surfaces can cause an accident. The sudden change in tire speed could cause the tires to skid. Be careful when downshifting on slippery surfaces.

Rocking the vehicle

If it is necessary to rock the vehicle to free it from snow, sand, or mud, first turn the steering wheel right and left to clear the area around your front wheels. Then, shift back and forth between R (Reverse) and a forward gear.

Try to avoid spinning the wheels, and do not race the engine.

To prevent transaxle wear, wait until the wheels stop spinning before shifting gears. Release the accelerator pedal while shifting, and press lightly on the accelerator pedal while the transaxle is in gear. Slowly spinning the wheels in forward and reverse directions causes a rocking motion that may free the vehicle.

WARNING

If the tires spin at high speed the tires can explode, and you or others may be injured. Do not attempt this procedure if people or objects are anywhere near the vehicle.

The vehicle can overheat causing an engine compartment fire or other damage. Spin the wheels as little as possible and avoid spinning the wheels at speeds over 56 km/h (35 mph) as indicated on the speedometer.

i Information

The ESC system (if equipped) must be turned OFF before rocking the vehicle.

NOTICE

If you are still stuck after rocking the vehicle a few times, have the vehicle pulled out by a tow vehicle to avoid engine overheating, possible damage to the transaxle, and tire damage. See "Towing" in chapter 6.

Smooth cornering

Avoid braking or gear changing in corners, especially when roads are wet. Ideally, corners should always be taken under gentle acceleration.

Driving at night

Night driving presents more hazards than driving in the daylight. Here are some important tips to remember:

- Slow down and keep more distance between you and other vehicles, as it may be more difficult to see at night, especially in areas where there may not be any street lights.
- Adjust your mirrors to reduce the glare from other driver's headlamps.
- Keep your headlamps clean and properly aimed. Dirty or improperly aimed headlamps will make it much more difficult to see at night.
- Avoid staring directly at the headlamps of oncoming vehicles. You could be temporarily blinded, and it will take several seconds for your eyes to readjust to the darkness.

Driving in the rain

Rain and wet roads can make driving dangerous. Here are a few things to consider when driving in the rain or on slick pavement:

- Slow down and allow extra following distance. A heavy rainfall makes it harder to see and increases the distance needed to stop your vehicle.
- Turn OFF your Cruise Control. (if equipped)
- Replace your windshield wiper blades when they show signs of streaking or missing areas on the windshield.
- Be sure your tires have enough tread. If your tires do not have enough tread, making a quick stop on wet pavement can cause a skid and possibly lead to an accident. **See "Tire Tread" in chapter 7.**
- Turn on your headlamps to make it easier for others to see you.
- Driving too fast through large puddles can affect your brakes. If you must go through puddles, try to drive through them slowly.

- If you believe your brakes may be wet, apply them lightly while driving until normal braking operation returns.

Hydroplaning

If the road is wet enough and you are going fast enough, your vehicle may have little or no contact with the road surface and actually ride on the water. The best advice is SLOW DOWN when the road is wet.

The risk of hydroplaning increases as the depth of tire tread decreases, refer to "Tire Tread" in chapter 7.

Driving in flooded areas

Avoid driving through flooded areas unless you are sure the water is no higher than the bottom of the wheel hub. Drive through any water slowly. Allow adequate stopping distance because brake performance may be reduced.

After driving through water, dry the brakes by gently applying them several times while the vehicle is moving slowly.

تلفن شبانه روزی: ۰۲۱-۸۸۸۶۲۰۸۵

FarmaSOS.com

Highway driving

Tires

Adjust the tire inflation, as specified. Under-inflation may overheat or damage the tires.

Do not install worn-out or damaged tires, which may reduce traction or fail the braking operation.

i Information

Never over-inflate your tires above the maximum inflation pressure, as specified on your tires.

Fuel, engine coolant and engine oil

Driving at a high speed consumes more fuel than driving at a slow speed, such as in an urban area. Do not forget to check both the engine coolant and engine oil.

Drive belt

A loose or damaged drive belt may overheat the engine.

Reducing the risk of a rollover

Your multi-purpose passenger vehicle is defined as a Sports Utility Vehicle (SUV). SUV's have higher ground clearance and a narrower track to make them capable of performing in a wide variety of off-road applications. The specific design characteristics give them a higher center of gravity than ordinary vehicles making them more likely to roll over if you make abrupt turns. Utility vehicles have a significantly higher rollover rate than other types of vehicles. Due to this risk, driver and passengers are strongly recommended to buckle their seat belts. In a rollover crash, an unbelted person is significantly more likely to die than a person wearing a seat belt.

There are steps that a driver can make to reduce the risk of a rollover. If at all possible, avoid sharp turns or abrupt maneuvers, do not load your vehicle with heavy cargo on the roof, and never modify your vehicle in any way.

WARNING

Utility vehicles have a significantly higher rollover rate than other types of vehicles. To prevent rollovers or loss of control:

- **Take corners at slower speeds than you would with a passenger vehicle.**
- **Avoid sharp turns and abrupt maneuvers.**
- **Do not modify your vehicle in any way that you would raise the center of gravity.**
- **Keep tires properly inflated.**
- **Do not carry heavy cargo on the roof.**

WARNING

In a rollover crash, an unbelted person is significantly more likely to die than a person wearing a seat belt. Make sure all passengers are wearing their seat belts.

WINTER DRIVING

The severe weather conditions of winter quickly wear out tires and cause other problems. To minimize winter driving problems, you should take the following suggestions:

i Information

Snow tires and tire chains for the national language (Bulgarian, Hungarian, Icelandic, Polish) see the Appendix, chapter I.

Snow or icy conditions

You need to keep sufficient distance between your vehicle and the vehicle in front of you.

Apply the brakes gently. Speeding, rapid acceleration, sudden brake applications, and sharp turns are potentially very hazardous practices. During deceleration, use engine braking to the fullest extent. Sudden brake applications on snowy or icy roads may cause skids to occur.

To drive your vehicle in deep snow, it may be necessary to use snow tires or to install tire chains on your tires.

Always carry emergency equipment. Some of the items you may want to carry include tire chains, tow straps or chains, a flashlight, emergency flares, sand, a shovel, jumper cables, a window scraper, gloves, ground cloth, coveralls, a blanket, etc.

Snow tires

! WARNING

Snow tires should be equivalent in size and type to the vehicle's standard tires. Otherwise, the safety and handling of your vehicle may be adversely affected.

If you mount snow tires on your vehicle, make sure to use radial tires of the same size and load range as the original tires. Mount snow tires on all four wheels to balance your vehicle's handling in all weather conditions. The traction provided by snow tires on dry roads may not be as high as your vehicle's original equipment tires. Check with the tire dealer for maximum speed recommendations.

i Information

Do not install studded tires without first checking local and municipal regulations for possible restrictions against their use.

Tire chains



Since the sidewalls of radial tires are thinner than other types of tires, they may be damaged by mounting some types of tire chains on them. Therefore, the use of snow tires is recommended instead of tire chains. Do not mount tire chains on vehicles equipped with aluminum wheels; if unavoidable use a wire type chain. If tire chains must be used, use genuine HYUNDAI parts and install the tire chain after reviewing the instructions provided with the tire chains. Damage to your vehicle caused by improper tire chain use is not covered by your vehicle manufacturer's warranty.

5-134

WARNING

The use of tire chains may adversely affect vehicle handling:

- Drive less than 30 km/h (20 mph) or the chain manufacturer's recommended speed limit, whichever is lower.
- Drive carefully and avoid bumps, holes, sharp turns, and other road hazards, which may cause the vehicle to bounce.
- Avoid sharp turns or locked wheel braking.

Information

- Install tire chains on the front tires. It should be noted that installing tire chains on the tires will provide a greater driving force, but will not prevent side skids.
- Do not install studded tires without first checking local and municipal regulations for possible restrictions against their use.

FarmaSOS.com

Chain Installation

When installing tire chains, follow the manufacturer's instructions and mount them as tightly possible. Drive slowly (less than 30 km/h (20 mph)) with chains installed. If you hear the chains contacting the body or chassis, stop and tighten them. If they still make contact, slow down until the noise stops. Remove the tire chains as soon as you begin driving on cleared roads.

When mounting snow chains, park the vehicle on level ground away from traffic. Turn on the vehicle Hazard Warning Flasher and place a triangular emergency warning device behind the vehicle (if available). Always place the vehicle in P (Park), apply the parking brake and turn off the engine before installing snow chains.

NOTICE

When using tire chains:

- **Wrong size chains or improperly installed chains can damage your vehicle's brake lines, suspension, body and wheels.**
- **Use SAE "S" class or wire chains.**
- **If you hear noise caused by chains contacting the body, retighten the chain to prevent contact with the vehicle body.**
- **To prevent body damage, retighten the chains after driving 0.5~1.0 km (0.3~0.6 miles).**
- **Do not use tire chains on vehicles equipped with aluminum wheels. If unavoidable, use a wire type chain.**
- **Use wire chains less than 15 mm (0.59 in) wide to prevent damage to the chain's connection.**

Winter Precautions

Use high quality ethylene glycol coolant

Your vehicle is delivered with high quality ethylene glycol coolant in the cooling system. It is the only type of coolant that should be used because it helps prevent corrosion in the cooling system, lubricates the water pump and prevents freezing. Be sure to replace or replenish your coolant in accordance with the maintenance schedule in section 7. Before winter, have your coolant tested to assure that its freezing point is sufficient for the temperatures anticipated during the winter.

Check battery and cables

The winter temperature increases the battery consumption. **Inspect the battery and cables, as specified in the chapter 7.** The battery charging level can be checked by an authorized HYUNDAI dealer or in a service station.

Change to "winter weight" oil if necessary

In some regions during winter, it is recommended to use the "winter weight" oil with lower viscosity. For further information, refer to the chapter 8. When you are not sure about a type of winter weight oil, consult an authorized HYUNDAI dealer.

Check spark plugs and ignition system

Inspect the spark plugs, as specified in the chapter 7. If necessary, replace them. Also check all ignition wirings and components for any cracks, wear-out, and damage.

To prevent locks from freezing

To prevent the locks from being frozen, spray approved de-icing fluid or glycerin into key holes. When a lock opening is already covered with ice, spray approved de-icing fluid over the ice to remove it. When an internal part of a lock freezes, try to thaw it with a heated key. Carefully use the heated key to avoid an injury.

Use approved window washer anti-freeze solution in system

To prevent the window washer from being frozen, add authorized window washer anti-freeze solution, as specified on the window washer container. Window washer anti-freeze solution is available from an authorized HYUNDAI dealer, and so are the most vehicle accessory outlets. Do not use engine coolant or other types of anti-freeze solution to prevent any damage to the vehicle paint.

FarmaSOS.com

Do not let your parking brake freeze

Under some conditions your parking brake can freeze in the engaged position. This is most likely to happen when there is an accumulation of snow or ice around or near the rear brakes or if the brakes are wet. When there is the risk that your parking brake may freeze, temporarily apply it with the shift lever in P (Park). Also, block the rear wheels in advance, so the vehicle may not roll. Then, release the parking brake.

Do not let ice and snow accumulate underneath

Under some conditions, snow and ice can build up under the fenders and interfere with the steering. When driving in such conditions during the severe winter, you should check underneath the vehicle on a regular basis, so that moving the front wheels and the steering components is unblocked.

Carry emergency equipment

In accordance with weather conditions, you should carry appropriate emergency equipment, while driving. Some of the items you may want to carry include tire chains, tow straps or chains, flashlight, emergency flares, sand, shovel, jumper cables, window scraper, gloves, ground cloth, coveralls, blanket, etc.

Do not place objects or materials in the engine compartment

Putting objects or materials in the engine compartment may cause an engine failure or combustion, because those may block the engine cooling. Such damage will not be covered by the manufacturer's warranty.

TRAILER TOWING (FOR EUROPE)

If you are considering to tow with your vehicle, you should first check with your country's Department of Motor Vehicles to determine legal requirements. Since laws vary the requirements for towing trailers, cars, or other types of vehicles or apparatus may differ. Ask an authorized HYUNDAI dealer for further details before towing.

Remember that trailering is different than just driving your vehicle by itself. Trailering means changes in handling, durability, and fuel economy. Successful, safe trailering requires correct equipment, and it has to be used properly. Damage to your vehicle caused by improper trailer towing is not covered by your vehicle manufacturer's warranty.

This section contains many time-tested, important trailering tips and safety rules. Many of these are important for your safety and that of your passengers. Please read this section carefully before you pull a trailer.

امداد خودرو فارما

تلفن شبانه روزی: ۰۲۱-۸۸۸۶۲۰۸۵

FarmaSOS.com

WARNING

Take the following precautions:

- If you don't use the correct equipment and/or drive improperly, you can lose control of the vehicle when you are pulling a trailer. For example, if the trailer is too heavy, the braking performance may be reduced. You and your passengers could be seriously or fatally injured. Pull a trailer only if you have followed all the steps in this section.
- Before towing, make sure the total trailer weight, GCW (Gross Combination Weight), GVW (Gross Vehicle Weight), GAW (Gross Axle Weight) and trailer tongue load are all within the limits.
- When you tow a trailer, make sure to turn off the ISG system.

i Information - For Europe

- **The technically permissible maximum load on the rear axle(s) may be exceeded by not more than 15 % and the technically permissible maximum laden mass of the vehicle may be exceeded by not more than 10% or 100 kg (220.4 lbs), whichever value is lower. In this case, do not exceed 100 km/h (62.1 mph) for vehicle of category M1 or 80 km/h (49.7 mph) for vehicle of category N1.**
- **When a vehicle of category M1 is towing a trailer, the additional load imposed at the trailer coupling device may cause the tire maximum load ratings to be exceeded, but not by more than 15%. In this case, do not exceed 100 km/h (62.1 mph) and increase the tire inflation pressure by at least 0.2 bar.**

If you decide to pull a trailer?

Here are some important points if you decide to pull a trailer:

- Consider using a sway control. You can ask a trailer hitch dealer about sway control.
- Do not do any towing with your vehicle during its first 2,000 km (1,200 miles) in order to allow the engine to properly break in. Failure to heed this caution may result in serious engine or transaxle damage.
- When towing a trailer, be sure to consult an authorized HYUNDAI dealer for further information on additional requirements such as a towing kit, etc.
- Always drive your vehicle at a moderate speed (less than 100 km/h (60 mph)) or posted towing speed limit.
- On a long uphill grade, do not exceed 70 km/h (45 mph) or the posted towing speed limit, whichever is lower.
- Carefully observe the weight and load limits provided in the following pages.

Trailer weight

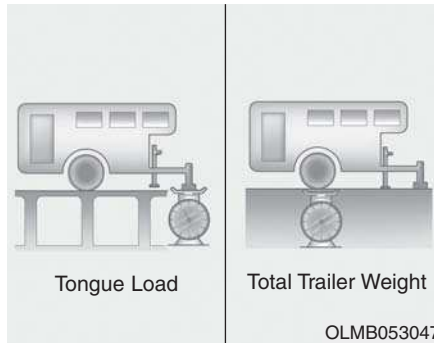

What is the maximum safe weight of a trailer? It should never weigh more than the maximum trailer weight with trailer brakes. But even that can be too heavy. It depends on how you plan to use your trailer. For example, speed, altitude, road grades, outside temperature and how often your vehicle is used to pull a trailer are all important. The ideal trailer weight can also depend on any special equipment that you have on your vehicle.

Tongue load

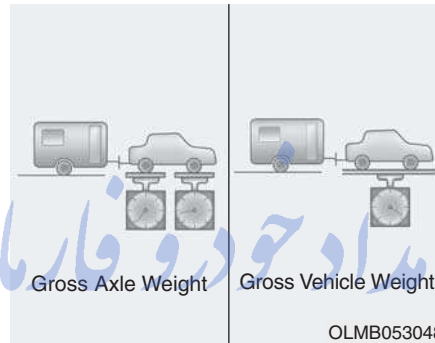

The tongue load is an important weight to measure because it affects the total Gross Vehicle Weight (GVW) of your vehicle. The trailer tongue should weigh a maximum of 10% of the total loaded trailer weight, within the limits of the maximum trailer tongue load permissible.

After you've loaded your trailer, weigh the trailer and then the tongue, separately, to see if the weights are proper. If they aren't, you may be able to correct them simply by moving some items around in the trailer.

⚠ WARNING

Take the following precautions:

- Never load a trailer with more weight in the rear than in the front. The front should be loaded with approximately 60% of the total trailer load; the rear should be loaded with approximately 40% of the total trailer load.
- Never exceed the maximum weight limits of the trailer or trailer towing equipment. Improper loading can result in damage to your vehicle and/or personal injury. Check weights and loading at a commercial scale or highway patrol office equipped with scales.

Reference weight and distance when towing a trailer

Item		Gasoline Engine									
		1.6 GDI	1.6 T-GDI				2.0 MPI				2.4 GDI
		2WD	2WD		4WD		2WD		4WD		4WD
		M/T	M/T	DCT	M/T	DCT	M/T	A/T	M/T	A/T	A/T
Maximum trailer weight kg (lbs.)	Without brake System	650 (1,433)	750 (1,653)	750 (1,653)	750 (1,653)	750 (1,653)	740 (1,631)	750 (1,653)	750 (1,653)	750 (1,653)	750 (1,653)
	With brake System	1,400 (3,086)	1,900 (4,189)	1,600 (3,527)	1,900 (4,189)	1,600 (3,527)	1,900 (4,189)	1,600 (3,527)	1,900 (4,189)	1,600 (3,527)	1,500 (3,307)
Maximum permissible static vertical load on the coupling device kg (lbs.)		100 (220)									
Recommended distance from rear wheel center to coupling point mm (inch)		995 (39.2)									

Item		Diesel Engine				
		1.7 TCI		2.0 TCI		
		2WD		2WD	4WD	
		M/T	DCT	M/T	M/T	A/T
Maximum trailer weight kg (lbs.)	Without brake System	750 (1,653)	750 (1,653)	750 (1,653)	750 (1,653)	750 (1,653)
	With brake System	1,400 (3,086)	1,600 (3,527)	2,200 (4,850)	2,200 (4,850)	1,900 (4,189)
Maximum permissible static vertical load on the coupling device kg (lbs.)		100 (220)				
Recommended distance from rear wheel center to coupling point mm (inch)		995 (39.2)				

M/T : Manual transaxle
A/T : Automatic transaxle
DCT : Dual clutch transmission

Trailer towing equipment

Hitches



i Information

The mounting hole for hitches are located on both sides of the underbody behind the rear tires.

It's important to have the correct hitch equipment. Crosswinds, large trucks going by, and rough roads are a few reasons why you'll need the right hitch. Here are some rules to follow:

- Do you have to make any holes in the body of your vehicle when you install a trailer hitch? If you do, then be sure to seal the holes later when you remove the hitch. If you don't seal them, carbon monoxide (CO) from your exhaust can get into your vehicle, as well as dirt and water.
- The bumpers on your vehicle are not intended for hitches. Do not attach rental hitches or other bumper-type hitches to them. Use only a frame-mounted hitch that does not attach to the bumper.
- A HYUNDAI trailer hitch accessory is available at an authorized HYUNDAI dealer.

Safety chains

You should always attach chains between your vehicle and your trailer. Cross the safety chains under the tongue of the trailer so that the tongue will not drop to the road if it becomes separated from the hitch. Instructions about safety chains may be provided by the hitch manufacturer or trailer manufacturer. Follow the manufacturer's recommendation for attaching safety chains. Always leave just enough slack so you can turn with your trailer. And, never allow safety chains to drag on the ground.

Trailer brakes

If your trailer is equipped with a braking system, make sure it conforms to your country's regulations and that it is properly installed and operating correctly.

If your trailer weighs more than the maximum trailer weight without trailer brakes loaded, then it needs its own brakes and they must be adequate. Be sure to read and follow the instructions for the trailer brakes so you'll be able to install, adjust and maintain them properly. Be sure not to tap into your vehicle's brake system.

WARNING

Do not use a trailer with its own brakes unless you are absolutely certain that you have properly set up the brake system. This is not a task for amateurs. Use an experienced, competent trailer shop for this work.

Driving with a trailer

Towing a trailer requires a certain amount of experience. Before setting out for the open road, you must get to know your trailer. Acquaint yourself with the feel of handling and braking with the added weight of the trailer. And always keep in mind that the vehicle you are driving is now longer and not nearly as responsive as your vehicle is by itself.

Before you start, check the trailer hitch and platform, safety chains, electrical connector(s), lights, tires and brakes.

During your trip, occasionally check to be sure that the load is secure, and that the lights and trailer brakes are still working.

Distance

Stay at least twice as far behind the vehicle ahead as you would when driving your vehicle without a trailer. This can help you avoid situations that require heavy braking and sudden turns.

Passing

You will need more passing distance up ahead when you're towing a trailer. And, because of the increased vehicle length, you'll need to go much farther beyond the passed vehicle before you can return to your lane.

Backing up

Hold the bottom of the steering wheel with one hand. Then, to move the trailer to the left, move your hand to the left. To move the trailer to the right, move your hand to the right. Always back up slowly and, if possible, have someone guide you.

Making turns

When you're turning with a trailer, make wider turns than normal. Do this so your trailer won't strike soft shoulders, curbs, road signs, trees, or other objects. Avoid jerky or sudden maneuvers. Signal well in advance.

Turn signals

When you tow a trailer, your vehicle has to have a different turn signal flasher and extra wiring. The green arrows on your instrument panel will flash whenever you signal a turn or lane change. Properly connected, the trailer lights will also flash to alert other drivers you're about to turn, change lanes, or stop.

When towing a trailer, the green arrows on your instrument panel will flash for turns even if the bulbs on the trailer are burned out. Thus, you may think drivers behind you are seeing your signals when, in fact, they are not. It's important to check occasionally to be sure the trailer bulbs are still working. You must also check the lights every time you disconnect and then reconnect the wires.

⚠ WARNING

Do not connect a trailer lighting system directly to your vehicle's lighting system. Use an approved trailer wiring harness. Failure to do so could result in damage to the vehicle electrical system and/or personal injury. Consult an authorized HYUNDAI dealer for assistance.

Driving on hills

Reduce speed and shift to a lower gear before you start down a long or steep downgrade. If you don't shift down, you might have to use your brakes so much that they would get overheated and may not operate efficiently.

On a long uphill grade, shift down and reduce your speed to around 70 km/h (45 mph) to reduce the possibility of engine and transaxle overheating.

If your trailer weighs more than the maximum trailer weight without trailer brakes and you have an automatic transaxle/dual clutch transmission, you should drive in D (Drive) when towing a trailer.

Operating your vehicle in D (Drive) when towing a trailer will minimize heat build-up and extend the life of your transaxle.

NOTICE

To prevent engine and/or transaxle overheating:

- **When towing a trailer on steep grades (in excess of 6%) pay close attention to the engine coolant temperature gauge to ensure the engine does not overheat. If the needle of the coolant temperature gauge moves towards "H" (HOT), pull over and stop as soon as it is safe to do so, and allow the engine to idle until it cools down. You may proceed once the engine has cooled sufficiently.**
- **You must decide your vehicle speed according to trailer weight and uphill grade.**
- **Vehicles equipped with a dual clutch transmission when towing a trailer on steep grades, the clutch in the transmission could overheat.**

(Continued)

(Continued)

When the clutch is overheated, the safe protection mode engages. If the safe protection mode engages, the gear position indicator on the cluster blinks with a chime sound.

At this time, a warning message will appear on the LCD display and driving may not be smooth.

If you ignore this warning, the driving condition may become worse.

To return to normal driving condition, stop the vehicle on a flat road and apply the foot brake for a few minutes before driving off.

Parking on hills

Generally, if you have a trailer attached to your vehicle, you should not park your vehicle on a hill.

However, if you ever have to park your trailer on a hill, here's how to do it:

1. Pull the vehicle into the parking space.

Turn the steering wheel in the direction of the curb (right if headed down hill, left if headed up hill).

2. Shift the vehicle to P (Park, for automatic transaxle/dual clutch transmission vehicle) or neutral (for manual transaxle vehicle).
3. Set the parking brake and shut off the vehicle.
4. Place wheel chocks under the trailer wheels on the down hill side of the wheels.
5. Start the vehicle, hold the brakes, shift to neutral, release the parking brake and slowly release the brakes until the trailer chocks absorb the load.

6. Reapply the brakes and parking brakes.
7. Move the shift lever to P (Park, for automatic transaxle/dual clutch transmission vehicle) or 1st gear when the vehicle is parked on a uphill grade and in R (Reverse) on a downhill (for manual transaxle vehicle).
8. Shut off the vehicle and release the vehicle brakes but leave the parking brake set.

WARNING

To prevent serious or fatal injury:

- **Do not get out of the vehicle without the parking brake firmly set. If you have left the engine running, the vehicle can move suddenly. You and others could be seriously or fatally injured.**
- **Do not apply the accelerator pedal to hold the vehicle on an uphill.**

Ready to leave after parking on a hill

1. With the shift lever to P (Park, for automatic transaxle/dual clutch transmission vehicle) or neutral (for manual transaxle vehicle), apply your brakes and hold the brake pedal down while you:
 - Start your engine;
 - Shift into gear; and
 - Release the parking brake.
2. Slowly remove your foot from the brake pedal.
3. Drive slowly until the trailer is clear of the chocks.
4. Stop and have someone pick up and store the chocks.

Maintenance when towing a trailer

Your vehicle will need service more often when you regularly pull a trailer. Important items to pay particular attention to include engine oil, automatic transaxle fluid, axle lubricant and cooling system fluid. Brake condition is another important item to frequently check. If you're trailering, it's a good idea to review these items before you start your trip. Don't forget to also maintain your trailer and hitch. Follow the maintenance schedule that accompanied your trailer and check it periodically. Preferably, conduct the check at the start of each day's driving. Most importantly, all hitch nuts and bolts should be tight.

NOTICE

To prevent vehicle damage:

- **Due to higher load during trailer usage, overheating might occur on hot days or during uphill driving. If the coolant gauge indicates over-heating, switch off the air conditioner and stop the vehicle in a safe area to cool down the engine.**
- **When towing check automatic transaxle fluid more frequently.**
- **If your vehicle is not equipped with an air conditioner, you should install a condenser fan to improve engine performance when towing a trailer.**

FarmaSOS.com

VEHICLE WEIGHT

Two labels on your driver's door sill show how much weight your vehicle was designed to carry: the Tire and Loading Information Label and the Certification Label.

Before loading your vehicle, familiarize yourself with the following terms for determining your vehicle's weight ratings, from the vehicle's specifications and the Certification Label:

Base Curb Weight

This is the weight of the vehicle including a full tank of fuel and all standard equipment. It does not include passengers, cargo, or optional equipment.

Vehicle Curb Weight

This is the weight of your new vehicle when you picked it up from your dealer plus any aftermarket equipment.

Cargo Weight

This figure includes all weight added to the Base Curb Weight, including cargo and optional equipment.

GAW (Gross Axle Weight)

This is the total weight placed on each axle (front and rear) - including vehicle curb weight and all payload.

GAWR (Gross Axle Weight Rating)

This is the maximum allowable weight that can be carried by a single axle (front or rear). These numbers are shown on the Certification Label. The total load on each axle must never exceed its GAWR.

GVW (Gross Vehicle Weight)

This is the Base Curb Weight plus actual Cargo Weight plus passengers.

GVWR (Gross Vehicle Weight Rating)

This is the maximum allowable weight of the fully loaded vehicle (including all options, equipment, passengers and cargo). The GVWR is shown on the Certification Label located on the driver's door sill.

Overloading

WARNING

The Gross Axle Weight Rating (GAWR) and the Gross Vehicle Weight Rating (GVWR) for your vehicle are on the Certification Label attached to the driver's (or front passenger's) door. Exceeding these ratings can cause an accident or vehicle damage. You can calculate the weight of your load by weighing the items (and people) before putting them in the vehicle. Be careful not to overload your vehicle.

What to do in an emergency

Hazard warning flasher	6-2	If you have a flat tire (with spare tire).....	6-17
In case of an emergency while driving	6-2	Jack and tools	6-17
If the engine stalls while driving	6-2	Changing tires	6-18
If the engine stalls at a crossroad or crossing	6-3	Jack label.....	6-23
If you have a flat tire while driving	6-3	EC Declaration of conformity for Jack.....	6-24
If the engine will not start	6-4	If you have a flat tire (with Tire Mobility Kit) ..	6-25
If the engine doesn't turn over or turns over		Introduction	6-25
slowly	6-4	Notes on the safe use of the Tire Mobility Kit.....	6-26
If the engine turns over normally but doesn't		Components of the Tire Mobility Kit	6-27
start	6-4	Using the Tire Mobility Kit.....	6-28
Jump starting	6-4	Distributing the sealant	6-30
If the engine overheats	6-8	Checking the tire inflation pressure	6-30
Tire pressure monitoring system (TPMS).....	6-10	Towing	6-33
Check tire pressure	6-10	Towing service.....	6-33
Tire pressure monitoring system.....	6-10	Removable towing hook	6-34
Low tire pressure telltale.....	6-12	Emergency towing	6-35
Low tire pressure position telltale and		Emergency commodity.....	6-37
tire pressure telltale	6-12	Fire extinguisher	6-37
TPMS (Tire Pressure Monitoring System)		First aid kit	6-37
malfunction indicator	6-13	Triangle reflector	6-37
Changing a tire with TPMS.....	6-14	Tire pressure gauge	6-37
		ERA-GLOPASS emergency call	6-38
		ERA-GLOPASS system	6-39

HAZARD WARNING FLASHER

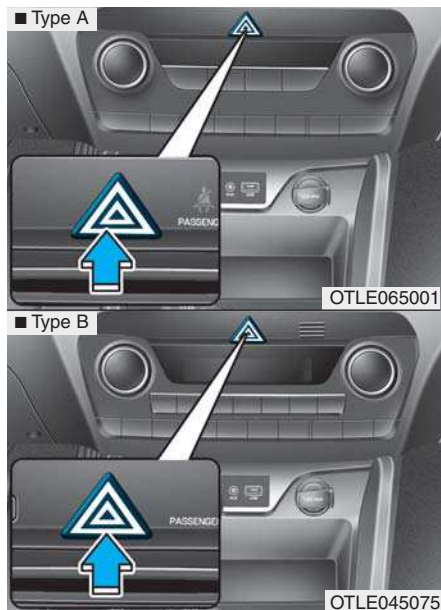

The hazard warning flasher serves as a warning to other drivers to exercise extreme caution when approaching, overtaking, or passing your vehicle.

It should be used whenever emergency repairs are being made or when the vehicle is stopped near the edge of a roadway.

To turn the hazard warning flasher on or off, press the hazard warning flasher button with the Engine Start/Stop button in any position. The button is located in the center fascia panel. All turn signal lights will flash simultaneously.

- The hazard warning flasher operates whether your vehicle is running or not.
- The turn signals do not work when the hazard flasher is on.

IN CASE OF AN EMERGENCY WHILE DRIVING

If the engine stalls while driving

- Reduce your speed gradually, keeping a straight line. Move cautiously off the road to a safe place.
- Turn on your hazard warning flasher.
- Try to start the engine again. If your vehicle will not start, we recommend that you contact an authorized HYUNDAI dealer.

تلفن شبانه روزی: ۰۲۱-۸۸۶۲۰۸۵

FarmaSOS.com

If the engine stalls at a crossroad or crossing

If the engine stalls at a crossroad or crossing, if safe to do so, move the shift lever to the N (Neutral) position and then push the vehicle to a safe location.

If you have a flat tire while driving

If a tire goes flat while you are driving:

- Take your foot off the accelerator pedal and let the vehicle slow down while driving straight ahead. Do not apply the brakes immediately or attempt to pull off the road as this may cause loss of vehicle control resulting in an accident. When the vehicle has slowed to such a speed that it is safe to do so, brake carefully and pull off the road. Drive off the road as far as possible and park on firm, level ground. If you are on a divided highway, do not park in the median area between the two traffic lanes.

- When the vehicle is stopped, press the hazard warning flasher button, move the shift lever into P (Park, for automatic transaxle/dual clutch transmission vehicle) or neutral (for manual transaxle vehicle), apply the parking brake, and place the ignition switch in the LOCK/OFF position.
- Have all passengers get out of the vehicle. Be sure they all get out on the side of the vehicle that is away from traffic.
- When changing a flat tire, follow the instructions provided later in this chapter.

FarmaSOS.com

IF THE ENGINE WILL NOT START

If the engine doesn't turn over or turns over slowly

- Be sure the shift lever is in N (Neutral) or P (Park) if it is an automatic transaxle/dual clutch transmission vehicle. The engine starts only when the shift lever is in N (Neutral) or P (Park).
- Check the battery connections to be sure they are clean and tight.
- Turn on the interior light. If the light dims or goes out when you operate the starter, the battery is drained.

Do not push or pull the vehicle to start it. This could cause damage to your vehicle. **See instructions for "Jump Starting" provided in this chapter.**



CAUTION

Push or pull starting the vehicle may cause the catalytic converter to overload which can lead to damage to the emission control system.

If the engine turns over normally but doesn't start

- Check the fuel level and add fuel if necessary.

If the engine still does not start, we recommend that you call an authorized HYUNDAI dealer for assistance.

امداد خودرو فارما

تلفن شبانه روزی: ۰۲۱-۸۸۸۶۲۰۸۵

FarmaSOS.com

JUMP STARTING

Jump starting can be dangerous if done incorrectly. Follow the jump starting procedure in this section to avoid serious injury or damage to your vehicle. If in doubt about how to properly jump start your vehicle, we strongly recommend that you have a service technician or towing service do it for you.

WARNING

To prevent **SERIOUS INJURY** or **DEATH** to you or bystanders, always follow these precautions when working near or handling the battery:



Always read and follow instructions carefully when handling a battery.



Wear eye protection designed to protect the eyes from acid splashes.



Keep all flames, sparks, or smoking materials away from the battery.



Hydrogen is always present in battery cells, is highly combustible, and may explode if ignited.



Keep batteries out of reach of children.

(Continued)

(Continued)



Batteries contain sulfuric acid which is highly corrosive. Do not allow acid to contact your eyes, skin or clothing.

If acid gets into your eyes, flush your eyes with clean water for at least 15 minutes and get immediate medical attention. If acid gets on your skin, thoroughly wash the area. If you feel pain or a burning sensation, get medical attention immediately.

- When lifting a plastic-cased battery, excessive pressure on the case may cause battery acid to leak. Lift with a battery carrier or with your hands on opposite corners.

- Do not attempt to jump start your vehicle if your battery is frozen.

(Continued)

(Continued)

- **NEVER** attempt to recharge the battery when the vehicle's battery cables are connected to the battery.
- The electrical ignition system works with high voltage. **NEVER** touch these components with the engine running or when the Engine Start/Stop button is in the ON position.
- Do not allow the (+) and (-) jumper cables to touch. It may cause sparks.
- The battery may rupture or explode when you jump start with a low or frozen battery.

NOTICE

To prevent damage to your vehicle:

- Only use a 12-volt power supply (battery or jumper system) to jump start your vehicle.
- Do not attempt to jump start your vehicle by push-starting.

Information



An inappropriately disposed battery can be harmful to the environment and human health. Dispose the battery according to your local law(s) or regulations.

امداد خودرو فارما

تلفن شبانه روزی: ۰۲۱-۸۸۸۶۲۰۸۵

FarmaSOS.com

Jump starting procedure

1. Position the vehicles close enough that the jumper cables will reach, but do not allow the vehicles to touch.
2. Avoid fans or any moving parts in the engine compartment at all times, even when the vehicles are turned off.
3. Turn off all electrical devices such as radios, lights, air conditioning, etc. Put the vehicles in P (Park, for automatic transaxle/dual clutch transmission vehicle) or neutral (for manual transaxle vehicle), and set the parking brakes. Turn both vehicles OFF.

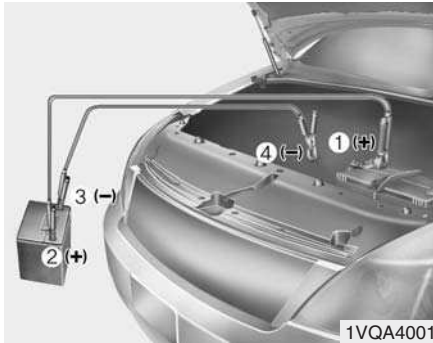

4. Connect the jumper cables in the exact sequence shown in the illustration. First connect one jumper cable to the red, positive (+) jumper terminal of your vehicle (1).
5. Connect the other end of the jumper cable to the red, positive (+) battery/jumper terminal of the assisting vehicle (2).
6. Connect the second jumper cable to the black, negative (-) battery/chassis ground of the assisting vehicle (3).

7. Connect the other end of the second jumper cable to the black, negative (-) chassis ground of your vehicle (4).

Do not allow the jumper cables to contact anything except the correct battery or jumper terminals or the correct ground. Do not lean over the battery when making connections.

8. Start the engine of the assisting vehicle and let it run at approximately 2,000 rpm for a few minutes. Then start your vehicle.

If your vehicle will not start after a few attempts, it probably requires servicing. In this event please seek qualified assistance. If the cause of your battery discharging is not apparent, have your vehicle checked by an authorized HYUNDAI dealer.

Disconnect the jumper cables in the exact reverse order you connected them:

1. Disconnect the jumper cable from the black, negative (-) chassis ground of your vehicle (4).
2. Disconnect the other end of the jumper cable from the black, negative (-) battery/chassis ground of the assisting vehicle (3).
3. Disconnect the second jumper cable from the red, positive (+) battery/jumper terminal of the assisting vehicle (2).
4. Disconnect the other end of the jumper cable from the red, positive (+) jumper terminal of your vehicle (1).

IF THE ENGINE OVERHEATS



If your temperature gauge indicates overheating, you experience a loss of power, or hear loud pinging or knocking, the engine may be overheating. If this happens, you should:

1. Pull off the road and stop as soon as it is safe to do so.
2. Place the shift lever in P (Park, for automatic transaxle/dual clutch transmission vehicle) or neutral (for manual transaxle/dual clutch transmission vehicle) and set the parking brake. If the air conditioning is ON, turn it OFF.

3. If engine coolant is running out under the vehicle or steam is coming out from the hood, stop the engine. Do not open the hood until the coolant has stopped running or the steaming has stopped. If there is no visible loss of engine coolant and no steam, leave the engine running and check to be sure the engine cooling fan is operating. If the fan is not running, turn the engine off.

تلفن شبانه روزی: ۰۲۱-۸۸۸۶۲۰۸۵

FarmaSOS.com

⚠ WARNING

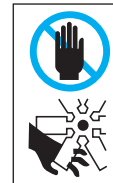

While the engine is running, keep hands, clothing and tools away from the moving parts such as the cooling fan and drive belt to prevent serious injury.

4. Check for coolant leaking from the radiator, hoses or under the vehicle. (If the air conditioning had been in use, it is normal for cold water to be draining from it when you stop.)
5. If engine coolant is leaking out, stop the engine immediately and we recommend that you call an authorized HYUNDAI dealer for assistance.

WARNING



NEVER remove the radiator cap or the drain plug while the engine and radiator are hot. Hot coolant and steam may blow out under pressure, causing serious injury. Turn the engine off and wait until the engine cools down. Use extreme care when removing the radiator cap. Wrap a thick towel around it, and turn it counterclockwise slowly to the first stop. Step back while the pressure is released from the cooling system. When you are sure all the pressure has been released, press down on the cap, using a thick towel, and continue turning counterclockwise to remove it.

6. If you cannot find the cause of the overheating, wait until the engine temperature has returned to normal. Then, if coolant has been lost, carefully add coolant to the reservoir to bring the fluid level in the reservoir up to the halfway mark.
7. Proceed with caution, keeping alert for further signs of overheating. If overheating happens again, we recommend that you call an authorized HYUNDAI dealer for assistance.

تلفن شبانه روزی: ۰۲۱-۸۸۶۲۰۸۵

FarmaSOS.com

CAUTION

- Serious loss of coolant indicates a leak in the cooling system and we recommend the system be checked by an authorized HYUNDAI dealer.
- When the engine overheats from low engine coolant, suddenly adding engine coolant may cause cracks in the engine. To prevent damage, add engine coolant slowly in small quantities.

TIRE PRESSURE MONITORING SYSTEM (TPMS) (IF EQUIPPED)



- (1) Low Tire Pressure Telltale/ TPMS Malfunction Indicator
- (2) Low tire pressure position telltale and tire pressure telltale (Shown on the LCD display)

Check tire pressure

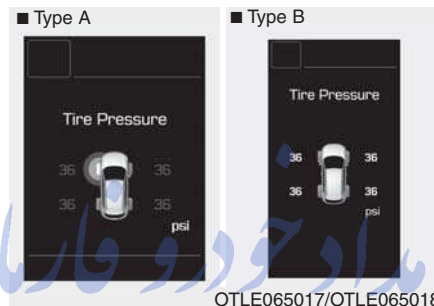

- You can check the tire pressure in the information mode on the instrument cluster.
Refer to "User Settings mode" in chapter 3.
- Tire pressure is displayed few minutes later after driving.
- If tire pressure is not displayed when the vehicle is stopped, "Drive to display" message will appear. After driving, check the tire pressure.

- You can change the tire pressure unit in the User Settings mode on the instrument cluster.
- **psi, kpa, bar (Refer to "User Settings mode" in chapter 3).**

Tire pressure monitoring system

WARNING

Over-inflation or under-inflation can reduce tire life, adversely affect vehicle handling, and lead to sudden tire failure that may cause loss of vehicle control resulting in an accident.

Each tire, including the spare (if provided), should be checked monthly when cold and inflated to the inflation pressure recommended by the vehicle manufacturer on the vehicle placard or tire inflation pressure label. (If your vehicle has tires of a different size than the size indicated on the vehicle placard or tire inflation pressure label, you should determine the proper tire inflation pressure for those tires.)

As an added safety feature, your vehicle has been equipped with a tire pressure monitoring system (TPMS) that illuminates a low tire pressure telltale when one or more of your tires is significantly under-inflated. Accordingly, when the low tire pressure telltale illuminates, you should stop and check your tires as soon as possible, and inflate them to the proper pressure. Driving on a significantly under-inflated tire causes the tire to overheat and can lead to tire failure. Under-inflation also reduces fuel efficiency and tire tread life, and may affect the vehicle's handling and stopping ability.

Please note that the TPMS is not a substitute for proper tire maintenance, and it is the driver's responsibility to maintain correct tire pressure, even if under-inflation has not reached the level to trigger illumination of the TPMS low tire pressure telltale.

Your vehicle has also been equipped with a TPMS malfunction indicator to indicate when the system is not operating properly. The TPMS malfunction indicator is combined with the low tire pressure telltale. When the system detects a malfunction, the telltale will flash for approximately one minute and then remain continuously illuminated. This sequence will continue upon subsequent vehicle start-ups as long as the malfunction exists. When the malfunction indicator is illuminated, the system may not be able to detect or signal low tire pressure as intended.

TPMS malfunctions may occur for a variety of reasons, including the installation of replacement or alternate tires or wheels on the vehicle that prevent the TPMS from functioning properly. Always check the TPMS malfunction telltale after replacing one or more tires or wheels on your vehicle to ensure that the replacement or alternate tires and wheels allow the TPMS to continue to function properly.

NOTICE

If any of the below happens, we recommend that the system be checked by an authorized HYUNDAI dealer.

1. The low tire pressure telltale/ TPMS malfunction indicator does not illuminate for 3 seconds when Engine Start/Stop button is turned to the ON or engine is running.
2. The TPMS malfunction indicator remains illuminated after blinking for approximately 1 minute.
3. The Low tire pressure position telltale remains illuminated.



Low tire pressure telltale

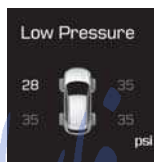

Low tire pressure position telltale and tire pressure telltale

OTL045504L

When the tire pressure monitoring system warning indicators are illuminated and warning message displayed on the cluster LCD display, one or more of your tires is significantly under-inflated. The low tire pressure position telltale light will indicate which tire is significantly under-inflated by illuminating the corresponding position light.

If either telltale illuminates, immediately reduce your speed, avoid hard cornering and anticipate increased stopping distances. You should stop and check your tires as soon as possible. Inflate the tires to the proper pressure as indicated on the vehicle's placard or tire inflation pressure label located on the driver's side center pillar outer panel. If you cannot reach a service station or if the tire cannot hold the newly added air, replace the low pressure tire with a spare tire.

If you drive the vehicle for about 10 minutes at speeds above 25 km/h after replacing the low pressure tire with the spare tire, the below will happen:

- The TPMS malfunction indicator may blink for approximately 1 minute and then remain continuously illuminated because the TPMS sensor is not mounted on the spare wheel.

NOTICE

The spare tire is not equipped with a tire pressure sensor.

CAUTION

In winter or cold weather, the low tire pressure telltale may illuminate if the tire pressure was adjusted to the recommended tire inflation pressure in warm weather. It does not mean your TPMS is malfunctioning because the decreased temperature leads to a lowering of tire pressure.

When you drive your vehicle from a warm area to a cold area or from a cold area to a warm area, or the outside temperature is higher or lower, you should check the tire inflation pressure and adjust the tires to the recommended tire inflation pressure.

WARNING**Low pressure damage**

Significantly low tire pressure makes the vehicle unstable and can contribute to loss of vehicle control and increased braking distances.

Continued driving on low pressure tires can cause the tires to overheat and fail.

تلفن شبانه روزی: ۰۲۱-۸۸۶۲۰۸۵

FarmaSOS.com

TPMS (Tire Pressure Monitoring System) malfunction indicator

The TPMS malfunction indicator will illuminate after it blinks for approximately one minute when there is a problem with the Tire Pressure Monitoring System.

We recommend that the system be checked by an authorized HYUNDAI dealer.

NOTICE

If there is a malfunction with the TPMS, the low tire pressure position telltale will not be displayed even though the vehicle has an under-inflated tire.

CAUTION

- The TPMS malfunction indicator may blink for approximately 1 minute and then remain continuously illuminated if the vehicle is moving around electric power supply cables or radios transmitter such as at police stations, government and public offices, broadcasting stations, military installations, airports, or transmitting towers, etc. This can interfere with normal operation of the Tire Pressure Monitoring System (TPMS).
- The TPMS malfunction indicator may blink for approximately 1 minute and then remain continuously illuminated if snow chains are used or some separate electronic devices such as notebook computer, mobile charger, remote starter or navigation etc., are used in the vehicle.

This can interfere with normal operation of the Tire Pressure Monitoring System (TPMS).

Changing a tire with TPMS

If you have a flat tire, the low Tire Pressure and Position telltales will come on. We recommend that the system be checked by an authorized HYUNDAI dealer.

CAUTION

NEVER use a puncture-repairing agent to repair and/or inflate a low pressure tire. The tire sealant can damage the tire pressure sensor. If used, you will have to replace the tire pressure sensor.

Each wheel is equipped with a tire pressure sensor mounted inside the tire behind the valve stem. You must use TPMS specific wheels. It is recommended that you have your tires serviced by an authorized HYUNDAI dealer.

If you drive the vehicle for about 10 minutes at speeds above 25 km/h after replacing the low pressure tire with the spare tire, the below will happen:

- The TPMS malfunction indicator may blink for approximately 1 minute and then remain continuously illuminated because the TPMS sensor is not mounted on the spare wheel.

You may not be able identify a low tire by simply looking at it. Always use a good quality tire pressure gauge to measure the tire's inflation pressure. Please note that a tire that is hot (from being driven) will have a higher pressure measurement than a tire that is cold (from sitting stationary for at least 3 hour and driven less than 1.6 km (1 mile) during that 3 hour period).

Allow the tire to cool before measuring the inflation pressure. Always be sure the tire is cold before inflating to the recommended pressure.

A cold tire means the vehicle has been sitting for 3 hours and driven for less than 1.6 km (1 mile) in that 3 hour period.

WARNING

- **The TPMS cannot alert you to severe and sudden tire damage caused by external factors such as nails or road debris.**
- **If you feel any vehicle instability, immediately take your foot off the accelerator, apply the brakes gradually and with light force, and slowly move to a safe position off the road.**

WARNING

Tampering with, modifying, or disabling the Tire Pressure Monitoring System (TPMS) components may interfere with the system's ability to warn the driver of low tire pressure conditions and/or TPMS malfunctions. Tampering with, modifying, or disabling the Tire Pressure Monitoring System (TPMS) components may void the warranty for that portion of the vehicle.

تلفن شبانه روزی: ۰۲۱-۸۸۶۲۰۸۵

FarmaSOS.com

 **WARNING**

For EUROPE

- Do not modify the vehicle; it may interfere with the TPMS function.
- The wheels on the market do not have a TPMS sensor.

For your safety, we recommend that you use parts for replacement from an authorized HYUNDAI dealer.

- If you use the wheels on the market, use a TPMS sensor approved by a HYUNDAI dealer. If your vehicle is not equipped with a TPMS sensor or TPMS does not work properly, you may fail the periodic vehicle inspection conducted in your country.

(Continued)

(Continued)

*All vehicles sold in the EUROPE market during below period must be equipped with TPMS.

- New model vehicle :
Nov. 1, 2012 ~

- Current model vehicle :
Nov. 1, 2014~ (Based on
vehicle registrations)

تلفن شبانه روزی: ۰۲۱-۸۸۸۶۲۰۸۵

FarmaSOS.com

IF YOU HAVE A FLAT TIRE (WITH SPARE TIRE, IF EQUIPPED)

WARNING

Changing a tire can be dangerous. Follow the instructions in this section when changing a tire to reduce the risk of serious injury or death.

CAUTION

Be careful as you use the jack handle to stay clear of the flat end. The flat end has sharp edges that could cause cuts.

Jack and tools



- (1) Jack handle
- (2) Jack
- (3) Wheel nut wrench

The jack, jack handle, and wheel nut wrench are stored in the luggage compartment under the luggage box cover.

The jack is provided for emergency tire changing only.



Turn the winged hold down bolt counterclockwise to remove the spare tire.

Store the spare tire in the same compartment by turning the winged hold down bolt clockwise.

To prevent the spare tire and tools from "rattling", store them in their proper location.



OTLE065040

If it is hard to loosen the tire hold-down wing bolt by hand, you can loosen it easily using the jack handle.

1. Put the jack handle (1) inside of the tire hold-down wing bolt.
2. Turn the tire hold-down wing bolt counterclockwise with the jack handle.

Changing tires

⚠ WARNING

A vehicle can slip or roll off of a jack causing serious injury or death to you or those nearby. Take the following safety precautions:

- Do not get under a vehicle that is supported by a jack.
- NEVER attempt to change a tire in the lane of traffic. ALWAYS move the vehicle completely off the road on level, firm ground away from traffic before trying to change a tire. If you cannot find a level, firm place off the road, call a towing service for assistance.
- Be sure to use the jack provided with the vehicle.

(Continued)

(Continued)

- ALWAYS place the jack on the designated jacking positions on the vehicle and NEVER on the bumpers or any other part of the vehicle for jacking support.
- Do not start or run the engine while the vehicle is on the jack.
- Do not allow anyone to remain in the vehicle while it is on the jack.
- Keep children away from the road and the vehicle.

Follow these steps to change your vehicle's tire:

1. Park on a level, firm surface.
2. Move the shift lever into P (Park, for automatic transaxle/dual clutch transmission vehicle) or neutral (for manual transaxle vehicle), apply the parking brake, and place the ignition switch in the LOCK/OFF position.
3. Press the hazard warning flasher button.
4. Remove the wheel lug nut wrench, jack, jack handle, and spare tire from the vehicle.



5. Block both the front and rear of the tire diagonally opposite of the tire you are changing.

تلفن شبانه روزی: ۰۲۱-۸۸۸۶۲۰۸۵

FarmaSOS.com



6. Loosen the wheel lug nuts counterclockwise one turn each in the order shown above, but do not remove any lug nuts until the tire has been raised off of the ground.

What to do in an emergency

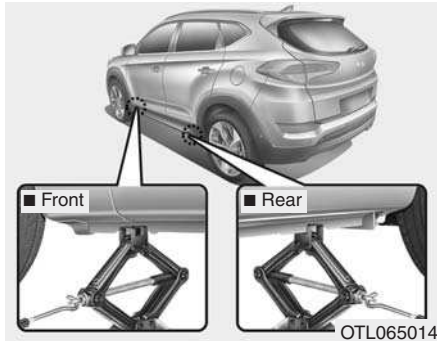

7. Place the jack at the designated jacking position under the frame closest to the tire you are changing. The jacking positions are plates welded to the frame with two notches and two dimples. Never jack any other position or part of the vehicle. It may damage to the side seal molding.



8. Insert the jack handle into the jack and turn it clockwise, raising the vehicle until the tire clears the ground. Make sure the vehicle is stable on the jack.

9. Loosen the lug nuts with the wheel lug nut wrench and remove them with your fingers. Remove the wheel from the studs and lay it flat on the ground out of the way. Remove any dirt or debris from the studs, mounting surfaces, and wheel.

10. Install the spare tire onto the studs of the hub.

11. Tighten the lug nuts with your fingers onto the studs with the smaller end of the lug nuts closest to the wheel.

12. Lower the vehicle to the ground by turning the jack handle counterclockwise.

FarmaSOS.com

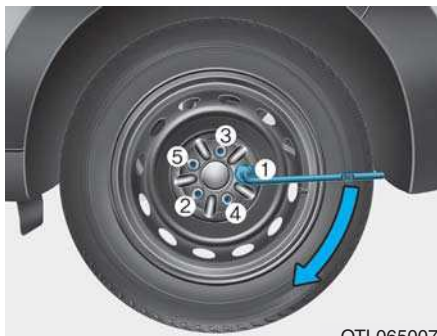

OTL065007

13. Use the wheel lug nut wrench to tighten the lug nuts in the order shown. Double-check each lug nut until they are tight. After changing tires, we recommend that an authorized HYUNDAI dealer tighten the lug nuts to their proper torque as soon as possible. **The wheel lug nut should be tightened to 9~11 kgf-m (65~79 lbf-ft).**

If you have a tire gauge, check the tire pressure (see “Tires and Wheels” in chapter 8 for tire pressure instructions.). If the pressure is lower or higher than recommended, drive slowly to the nearest service station and adjust it to the recommended pressure. Always reinstall the valve cap after checking or adjusting tire pressure. If the cap is not replaced, air may leak from the tire. If you lose a valve cap, buy another and install it as soon as possible. After changing tires, secure the flat tire and return the jack and tools to their proper storage locations.

NOTICE

Check the tire pressure as soon as possible after installing a spare tire. Adjust it to the recommended pressure.

⚠ CAUTION

Your vehicle has metric threads on the studs and lug nuts. Make certain during tire changing that the same nuts that were removed are reinstalled. If you have to replace your lug nuts make sure they have metric threads to avoid damaging the studs and ensure the wheel is properly secured to the hub. We recommend that you consult an authorized HYUNDAI dealer for assistance.

If any of the equipment such as the jack, lug nuts, studs, or other equipment is damaged or in poor condition, do not attempt to change the tire and call for assistance.

Use of compact spare tires (if equipped)

Compact spare tires are designed for emergency use only. Drive carefully on the compact spare tire and always follow the safety precautions.

⚠ WARNING

To prevent compact spare tire failure and loss of control possibly resulting in an accident:

- **Use the compact spare tire only in an emergency.**
- **NEVER operate your vehicle over 80 km/h (50 mph).**
- **Do not exceed the vehicle's maximum load rating or the load carrying capacity shown on the sidewall of the compact spare tire.**
- **Do not use the compact spare tire continuously. Repair or replace the original tire as soon as possible to avoid failure of the compact spare tire.**

When driving with the compact spare tire mounted to your vehicle:

- Check the tire pressure after installing the compact spare tire. The compact spare tire should be inflated to 420 kPa (60 psi).
- Do not take this vehicle through an automatic car wash while the compact spare tire is installed.
- Do not use the compact spare tire on any other vehicle because this tire has been designed especially for your vehicle.
- The compact spare tire's tread life is shorter than a regular tire. Inspect your compact spare tire regularly and replace worn compact spare tires with the same size and design, mounted on the same wheel.
- Do not use more than one compact spare tire at a time.
- Do not tow a trailer while the compact spare tire is installed.

NOTICE

When the original tire and wheel are repaired and reinstalled on the vehicle, the lug nut torque must be set correctly. The correct lug nut tightening torque is 9-11 kgf-m (65-79 lbf-ft).

⚠ CAUTION

To prevent damaging the compact spare tire and your vehicle:

- Drive slowly enough for the road conditions to avoid all hazards, such as a potholes or debris.
- Avoid driving over obstacles. The compact spare tire diameter is smaller than the diameter of a conventional tire and reduces the ground clearance approximately 25 mm (1 inch).
- Do not use tire chains on the compact spare tire. Because of the smaller size, a tire chain will not fit properly.
- Do not use the compact spare tire on any other wheels, nor should standard tires, snow tires, wheel covers or trim rings be used with the compact spare wheel.

Jack label

■ Example

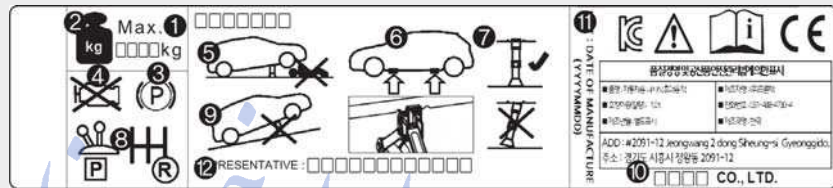

OHYK065011

The actual Jack label in the vehicle may differ from the illustration.
For more detailed specifications, refer to the label attached to the jack.

1. Model Name
2. Maximum allowable load
3. When using the jack, set your parking brake.
4. When using the jack, stop the engine.
5. Do not get under a vehicle that is supported by a jack.
6. The designated locations under the frame
7. When supporting the vehicle, the base plate of jack must be vertical under the lifting point.
8. Shift into Reverse gear on vehicles with manual transaxle or move the shift lever to the P position on vehicles with automatic transaxle/dual clutch transmission.
9. The jack should be used on firm level ground.
10. Jack manufacture
11. Production date
12. Representative company and address

EC Declaration of conformity for Jack

CE

EC Declaration of Conformity
according to EC Machinery Directive 2006/42/EC

We, **FRONTEC CO., LTD.**
2091-12 Jeongwang 2(i)-dong Siheung-si Gyeonggi-d ,Korea
declare under our sole responsibility that the product

Product : JACK-ASSY
Type Designation(s) : 1200KG, 1000KG, 800KG, 700KG, 500KG
Serial No. : N/A (prototype)
Year of Manufacture : 2013

to which this declaration relates is in conformity with the following standard(s) or other normative document(s):

EN ISO12100 (2010)	Safety of machinery - General principles for design – Risk assessment and risk reduction
EN 1494/A1 (2008)	Mobile or movable jacks and associated lifting equipment

following the provisions of Directive(s):

2006/42/EC	Directive on the approximation of the laws of Member States relating to machinery (OJ L157 Jun, 9, 2006)
------------	----------------------------------------------------------------------------------------------------------

Siheung-si Gyeonggi-d ,Korea / 15.07.2013 SOO HONG, MIN President 
(Place and date of issue)(Name and signature or equivalent making of authorized person)

* T.C.F Compiling Location:
- Address: PRIBORSKA 280, 739 42 PRYDEK MISTEK, CHLEBOVICE, CZECH REPUBLIC
- Team: Purchase team
- Company name: HANWHA L&C CZECH s.r.o.

JACKDOC14F

IF YOU HAVE A FLAT TIRE (WITH TIRE MOBILITY KIT, IF EQUIPPED)



For safe operation, carefully read and follow the instructions in this manual before use.

- (1) Compressor
- (2) Sealant bottle

The Tire Mobility Kit is a temporary fix to the tire and we recommend that the system be inspected by an authorized HYUNDAI dealer.

⚠ CAUTION

When two or more tires are flat, do not use the tire mobility kit because the supported one sealant of Tire Mobility Kit is only used for one flat tire.

⚠ WARNING

Do not use the Tire Mobility Kit to repair punctures in the tire walls. This can result in an accident due to tire failure.

⚠ WARNING

Have your tire repaired as soon as possible. The tire may lose air pressure at any time after inflating with the Tire Mobility Kit.

Introduction



With the Tire Mobility Kit you stay mobile even after experiencing a tire puncture.

The system of compressor and sealing compound effectively and comfortably seals most punctures in a passenger car tire caused by nails or similar objects and reinflates the tire.

After you ensured that the tire is properly sealed you can drive cautiously on the tire (distance up to 200 km (120 miles)) at a max. speed of 80 km/h (50 mph) in order to reach a service station or tire dealer to have the tire replaced.

It is possible that some tires, especially with larger punctures or damage to the sidewall, cannot be sealed completely.

Air pressure loss in the tire may adversely affect tire performance. For this reason, you should avoid abrupt steering or other driving maneuvers, especially if the vehicle is heavily loaded or if a trailer is in use.

The Tire Mobility Kit is not designed or intended as a permanent tire repair method and is to be used for one tire only. This instruction shows you step by step how to temporarily seal the puncture simply and reliably. Read the section "Notes on the safe use of the Tire Mobility Kit".

WARNING

Do not use the TMK if a tire is severely damaged by driving run flat or with insufficient air pressure.

Only punctured areas located within the tread region of the tire can be sealed using the TMK.

Notes on the safe use of the Tire Mobility Kit

- Park your car at the side of the road so that you can work with the Tire Mobility Kit away from moving traffic.
 - To be sure your vehicle will not move, even when you're on fairly level ground, always set your parking brake.
 - Only use the Tire Mobility Kit for sealing/inflation passenger car tires. Only punctured areas located within the tread region of the tire can be sealed using the tire mobility kit.
 - Do not use on motorcycles, bicycles or any other type of tires.
 - When the tire and wheel are damaged, do not use Tire Mobility Kit for your safety.
 - Use of the Tire Mobility Kit may not be effective for tire damage larger than approximately 6 mm (0.24 in).
If the tire cannot be made roadworthy with the Tire Mobility Kit, we recommend that you contact an authorized HYUNDAI dealer.
- Do not use the Tire Mobility Kit if a tire is severely damaged by driving run flat or with insufficient air pressure.
 - Do not remove any foreign objects such as nails or screws that have penetrated the tire.
 - Provided the car is outdoors, leave the engine running. Otherwise operating the compressor may eventually drain the car battery.
 - Never leave the Tire Mobility Kit unattended while it is being used.
 - Do not leave the compressor running for more than 10 min. at a time or it may overheat.
 - Do not use the Tire Mobility Kit if the ambient temperature is below -30°C (-22°F).

Components of the Tire Mobility Kit

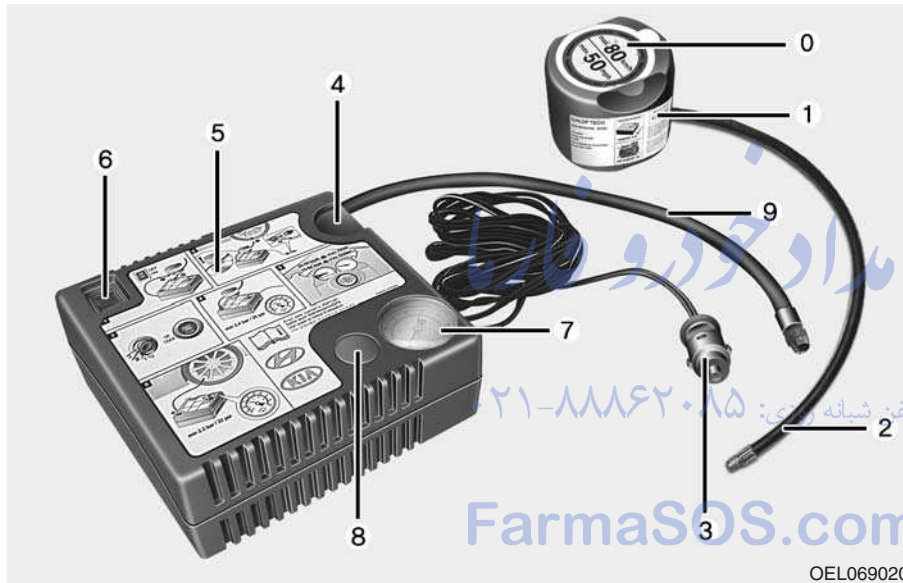

0. Speed- restriction label
1. Sealant bottle and label with speed restriction
2. Filling hose from sealant bottle to wheel
3. Connectors and cable for the power outlet direct connection
4. Holder for the sealant bottle
5. Compressor
6. On/off switch
7. Pressure gauge for displaying the tire inflation pressure
8. Button for reducing tire inflation pressure

9. Hose to connect compressor and sealant bottle or compressor and wheel

Connectors, cable and connection hose are stored in the compressor housing.

⚠ WARNING

Expired sealant

Do not use the Tire sealant after the sealant has expired (i.e. pasted the expiration date on the sealant container). This can increase the risk of tire failure.

⚠ WARNING

Sealant

- Keep out of reach of children.
- Avoid contact with eyes.
- Do not swallow.

Strictly follow the specified sequence, otherwise the sealant may escape under high pressure.

Using the Tire Mobility Kit

1. Detach the speed restriction label (0) from the sealant bottle (1), and place it in a highly visible place inside the vehicle such as on the steering wheel to remind the driver not to drive too fast.
2. Screw connection hose (9) onto the connector of the sealant bottle.
3. Ensure that button (8) on the compressor is not pressed.
4. Unscrew the valve cap from the valve of the defective wheel and screw filling hose (2) of the sealant bottle onto the valve.
5. Insert the sealant bottle into the housing of the compressor (4) so that the bottle is upright.



6. Ensure that the compressor is switched off, position 0.



CAUTION

Securely install the sealant filling hose to the valve. If not, sealant may flow backward, possibly clogging the filling hose.



OTL065037

7. Connect between compressor and the vehicle power outlet using the cable and connectors.

⚠ WARNING

Only use the front passenger side power outlet when connecting the power cord.

8. With the engine start/stop button position on or ignition switch position on, switch on the compressor and let it run for approximately 5~7 minutes to fill the sealant up to proper pressure. (refer to the Tire and Wheels, chapter 8). The inflation pressure of the tire after filling is unimportant and will be checked/corrected later.

Be careful not to overinflate the tire and stay away from the tire when filling it.

⚠ CAUTION

Tire pressure

Do not attempt to drive your vehicle if the tire pressure is below 29 PSI (200kpa). This could result in an accident due to sudden tire failure.

9. Switch off the compressor.
10. Detach the hoses from the sealant bottle connector and from the tire valve.

Return the Tire Mobility Kit to its storage location in the vehicle.

⚠ WARNING

Carbon monoxide

Do not leave your vehicle running in a poorly ventilated area for extended periods of time. Carbon monoxide poisoning and suffocation can occur.

Distributing the sealant

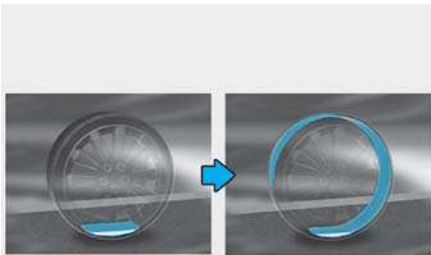

OLMF064106

11. Immediately drive approximately 7~10 km (4~6 miles or, about 10min) to evenly distribute the sealant in the tire.

CAUTION

Do not exceed a speed of 80 km/h (50 mph). If possible, do not fall below a speed of 20 km/h (12 mph).

While driving, if you experience any unusual vibration, ride disturbance or noise, reduce your speed and drive with caution until you can safely pull off of the side of the road.

Call for road side service or towing. When you use the Tire Mobility Kit, the tire pressure sensors and wheel may be damaged by sealant, remove the sealant stained with tire pressure sensors and wheel and inspect in authorized dealer.

Checking the tire inflation pressure



1. After driving approximately 7~10 km (4~6 miles or about 10 min), stop at a safety location.
 2. Connect connection hose (9) of the compressor directly to the tire valve.
 3. Plug the compressor power cord into the vehicle power outlet.
 4. Adjust the tire inflation pressure to the recommended tire inflation.
- With the ignition switched on, proceed as follows.

- **To increase the inflation pressure** : Switch on the compressor, position I. To check the current inflation pressure setting, briefly switch off the compressor.

WARNING

Do not let the compressor run for more than 10 minutes, otherwise the device will overheat and may be damaged.

NOTICE

The pressure gauge may show higher than actual reading when the compressor is running. To get an accurate tire reading, the compressor needs to be turned off.

- **To reduce the inflation pressure**: Press the button 8 on the compressor.

CAUTION

If the inflation pressure is not maintained, drive the vehicle a second time, refer to Distributing the sealant. Then repeat steps 1 to 4.

Use of the TMK may be ineffectual for tire damage larger than approximately 4 mm (0.16 in).

We recommend that you contact an authorized HYUNDAI dealer if the tire cannot be made road-worthy with the Tire Mobility Kit.

WARNING

The tire inflation pressure must be at least 220 kPa (32 psi). If it is not, do not continue driving.

Call for road side service or towing.

CAUTION

Tire pressure sensor

The sealant on the tire pressure sensor and wheel should be removed when you replace the tire with a new one and inspect the tire pressure sensors in authorized dealer.

What to do in an emergency

- * Sealant and spare parts can be obtained and replaced at an authorized vehicle or tire dealer. Empty sealant bottles may be disposed of at home. Liquid residue from the sealant should be disposed of by your vehicle or tire dealer or in accordance with local waste disposal regulations.

امداد خودرو فارما

تلفن شبانه روزی: ۰۲۱-۸۸۸۶۲۰۸۵

FarmaSOS.com

TOWING

Towing service

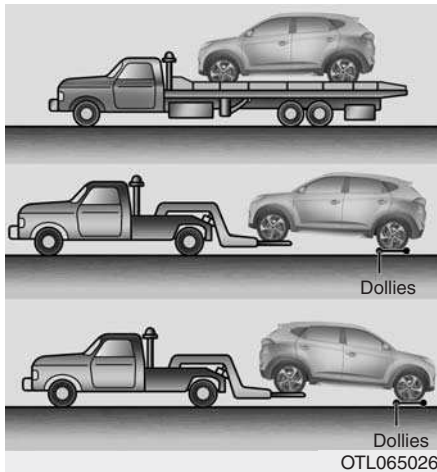

If emergency towing is necessary, we recommend having it done by an authorized HYUNDAI dealer or a commercial tow-truck service.

Proper lifting and towing procedures are necessary to prevent damage to the vehicle. The use of wheel dollies or flatbed is recommended.

On 4WD vehicles, your vehicle must be towed with a wheel lift and dollies or flatbed equipment with all the wheels off the ground.

CAUTION

The 4WD vehicle should never be towed with the wheels on the ground. This can cause serious damage to the transaxle or the 4WD system.

On 2WD vehicles, it is acceptable to tow the vehicle with the rear wheels on the ground (without dollies) and the front wheels off the ground.

If any of the loaded wheels or suspension components are damaged or the vehicle is being towed with the front wheels on the ground, use a towing dolly under the front wheels.

When being towed by a commercial tow truck and wheel dollies are not used, the front of the vehicle should always be lifted, not the rear.

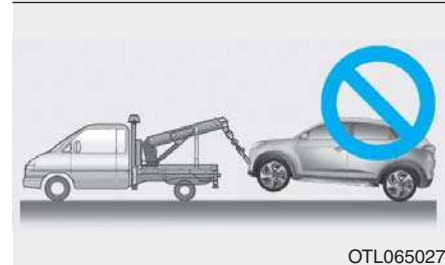
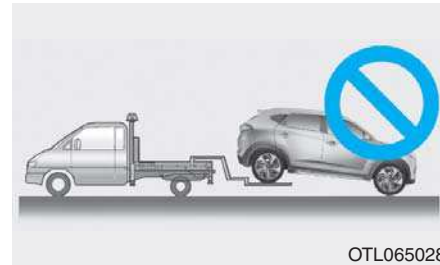

CAUTION

- **Do not tow the vehicle with the front wheels on the ground as this may cause damage to the vehicle.**
- **Do not tow with sling-type equipment. Use wheel lift or flatbed equipment.**

WARNING

If your vehicle is equipped with a rollover sensor, place the ignition switch in the LOCK/OFF or ACC position when the vehicle is being towed. The side impact and curtain air bag may deploy if the sensor detects the situation as a rollover.

When towing your vehicle in an emergency without wheel dollies:

1. Place the ignition switch in the LOCK/OFF or ACC position.
2. Place the shift lever in N (Neutral).
3. Release the parking brake.

CAUTION

Failure to place the shift lever in N (Neutral) may cause internal damage to the transaxle.

Removable towing hook

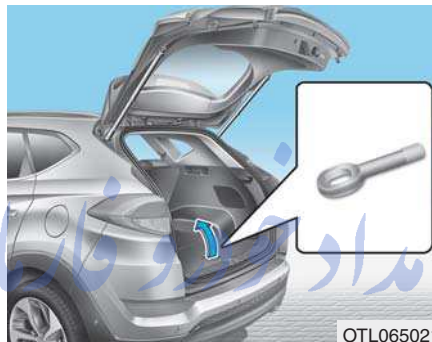

1. Open the tailgate, and remove the towing hook from the tool case.

FarmaSOS.com

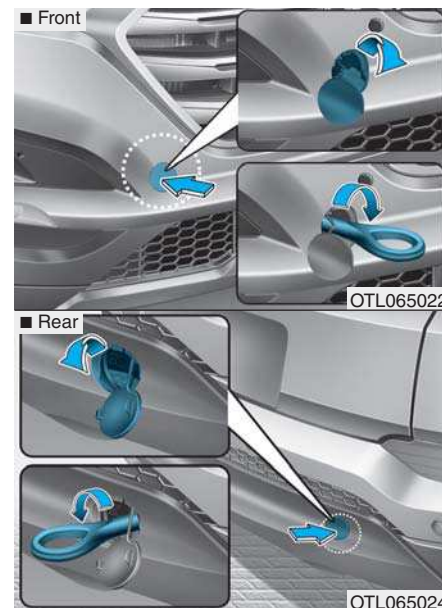

2. Remove the hole cover pressing the lower part of the cover on the front bumper.
3. Install the towing hook by turning it clockwise into the hole until it is fully secured.
4. Remove the towing hook and install the cover after use.

Emergency towing

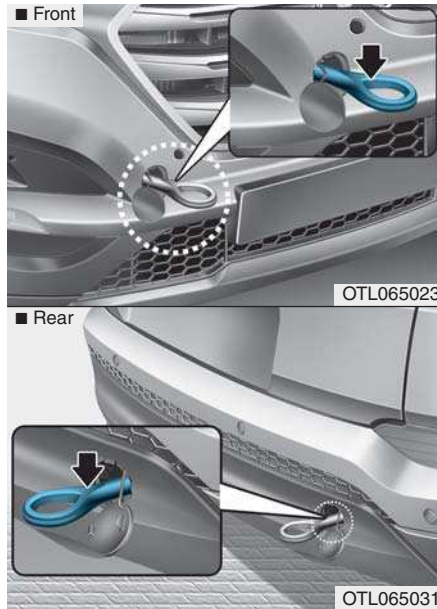

If towing is necessary, we recommend you have it done by an authorized HYUNDAI dealer or a commercial tow truck service.

If towing service is not available in an emergency, your vehicle may be temporarily towed using a cable or chain secured to the emergency towing hook at the front (or rear) of the vehicle.

Use extreme caution when towing the vehicle with a cable or chain. A driver must be in the vehicle to steer it and operate the brakes.

Towing in this manner may be done only on hard-surfaced roads for a short distance and at low speeds. Also, the wheels, axles, power train, steering and brakes must all be in good condition. تلفن شبانه روزی: ۰۸۵

FarmaSOS.com

Always follow these emergency towing precautions:

- Place the ignition switch in the ACC position so the steering wheel is not locked.
- Place the shift lever in N (Neutral).
- Release the parking brake.
- Depress the brake pedal with more force than normal since you will have reduced braking performance.
- More steering effort will be required because the power steering system will be disabled.
- Use a vehicle heavier than your own to tow your vehicle.
- The drivers of both vehicles should communicate with each other frequently.
- Before emergency towing, check that the hook is not broken or damaged.
- Fasten the towing cable or chain securely to the hook.
- Do not jerk the hook. Apply steady and even force.

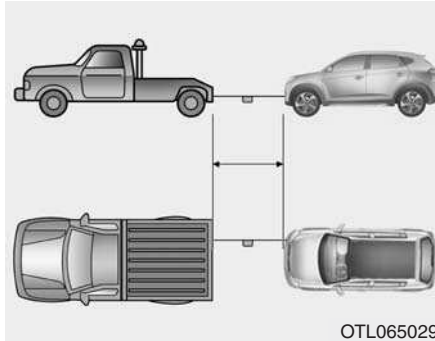

- Use a towing cable or chain less than 5 m (16 feet) long. Attach a white or red cloth (about 30 cm (12 inches) wide) in the middle of the cable or chain for easy visibility.
- Drive carefully so the towing cable or chain remains tight during towing.
- Before towing, check the automatic transaxle/dual clutch transmission for fluid leaks under your vehicle. If the automatic transaxle fluid is leaking, flatbed equipment or a towing dolly must be used.

CAUTION

To avoid damage to your vehicle and vehicle components when towing:

- Always pull straight ahead when using the towing hooks. Do not pull from the side or at a vertical angle.
- Do not use the towing hooks to pull a vehicle out of mud, sand or other conditions from which the vehicle cannot be driven out under its own power.
- Limit the vehicle speed to 15 km/h (10 mph) and drive less than 1.5 km (1 mile) when towing to avoid serious damage to the automatic transaxle.

EMERGENCY COMMODITY (IF EQUIPPED)

Your vehicle is equipped with emergency commodities to help you respond to emergency situation.

Fire extinguisher

If there is small fire and you know how to use the fire extinguisher, follow these steps carefully.

1. Pull out the safety pin at the top of the extinguisher that keeps the handle from being accidentally pressed.
2. Aim the nozzle towards the base of the fire.
3. Stand approximately 2.5 m (8 ft) away from the fire and squeeze the handle to discharge the extinguisher. If you release the handle, the discharge will stop.
4. Sweep the nozzle back and forth at the base of the fire. After the fire appears to be out, watch carefully since it may re-ignite.

First aid kit

Supplies for use in giving first aid such as scissors, bandage and adhesive tape, etc. are provided.

Triangle reflector

Place the triangle reflector on the road to warn oncoming vehicles during emergencies, such as when the vehicle is parked by the roadside due to problems.

Tire pressure gauge (if equipped)

Tires normally lose some air in day-to-day use, and you may have to add a air periodically and usually it is not a sign of a leaking tire, but of normal wear. Always check tire pressure when the tires are cold because tire pressure increases with temperature.

To check the tire pressure, take the following steps:

1. Unscrew the inflation valve cap that is located on the rim of the tire.
2. Press and hold the gauge against the tire valve. Some air will leak as you begin and more will leak if you don't press the gauge in firmly.
3. A firm non-leaking push will activate the gauge.
4. Read the tire pressure on the gauge to see whether the tire pressure is low or high.
5. Adjust the tire pressure to the specified pressure. Refer to "Tires and Wheels" in chapter 8.
6. Reinstall the inflation valve cap.

ERA-GLONASS EMERGENCY CALL (IF EQUIPPED)

The car is equipped with a device* connected with the system ERA-GLONASS for making emergency call to response teams. The system ERA-GLONASS is an automatic emergency call service made in event of a traffic accident or other** accidents on the roads of Russian Federation.

The system allows contacting with an officer of the single duty dispatch service in case of accidents on the roads of Russian Federation. The system ERA-GLONASS given conditions, stated in the Owner's Manual as well as Warranty and Service book transmits data to the single duty dispatch service, including such information as vehicle location, vehicle type, VIN (vehicle identification number of the car).

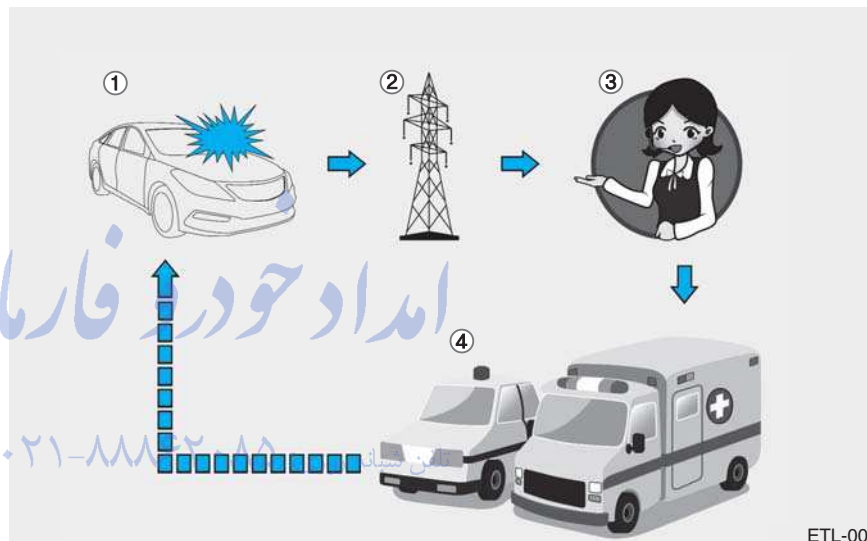

- ① Road accident
- ② Wireless network
- ③ Single duty dispatch service (SDDS)
- ④ Rescue

* ERA-GLONASS device in the Owner's Manual means equipment, installed in the car, which provides connection with the ERA-GLONASS system.

** "Other accidents" mean any accidents on the roads of Russian Federation resulted in injured people and/or necessity of provision of assistance. In case of registration of any accident, it is necessary to stop a vehicle, press button SOS (location of the button is specified on the picture in the chapter "ERA-GLONASS EMERGENCY CALL (IF EQUIPPED)") of the Owner's Manual. When making a call, the system gathers information about the car (from which a call was made), after which connects the car with an officer of the single duty dispatch service to tell about the reason of the emergency call.

Once the data which stored in the ERA-GLONASS system is delivered to the rescue center to assist the driver and passengers with proper rescue operations, the data will be deleted after rescue operation is completed.

Operator of the system ERA-GLONASS (stock company "GLONASS") is responsible for all components of the system ERA-GLONASS (excluding equipment, installed in the car) in accordance with the federal law "On state automated information system ERA-GLONASS" # 395-FZ from 28.12.2013.

ERA-GLONASS system



Elements of the system ERA-GLONASS, installed in passenger compartment:

- ① Microphone
- ② SOS button
- ③ SOS TEST button
- ④ LED

SOS button: the driver/passenger makes an emergency call to the single duty dispatch service by pressing the button.

SOS TEST button (test): the button is to check working ability of the system in the official dealership of Hyundai. The mode "SOS TEST" can be activated strictly by the specialist of the authorized dealership of Hyundai. To avoid erroneous calls, please, do not press this button and do not activate the mode "SOS TEST" by yourself.

LED: The red and green LED illuminates for 3 seconds when the ignition switch is in the ON position. After that they will switch off at normal operation of the system.

If there are some problems in the system, the LED remains in red.

Automatic accident reporting

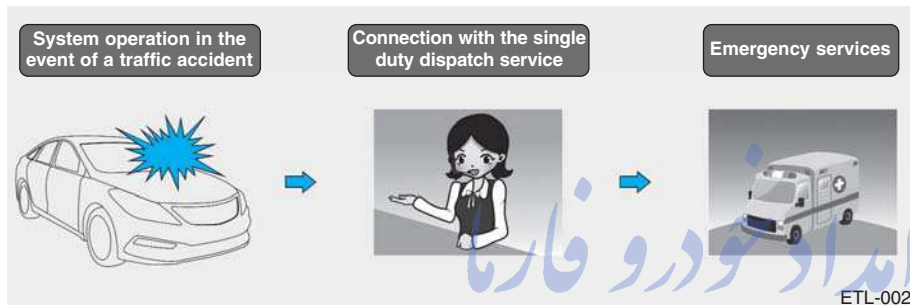

The ERA-GLONASS device automatically makes an emergency call to the single duty dispatch service for proper rescuing operations in event of car accident.

For proper emergency services and support the ERA-GLONASS system automatically transmits the accident data to the single duty dispatch service when a traffic accident is detected.

In this case, the emergency call cannot be hung up by pressing the SOS button and the ERA-GLONASS system remains connected until the emergency service officer, receiving the call, disconnects the emergency call.

i Information

In even of minor traffic accidents the ERA-GLONASS system may not execute an emergency call. However, an emergency call may be made manually by pressing the SOS button.

! CAUTION

Operation of the system is impossible in case of absence of mobile transmission and GPS and GLONASS signals.

Manual accident reporting

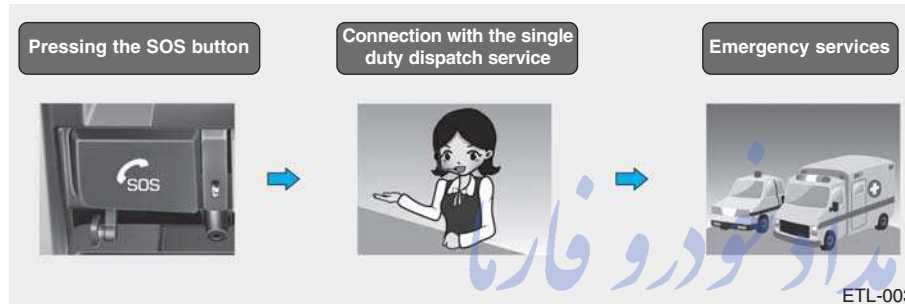

Driver or passenger manually can make an emergency call in the single duty dispatch service, by pressing SOS button to call the necessary emergency services.

A call to the emergency services through the ERA-GLONASS system can be cancelled by pressing the SOS button again only before the call connection.

After activation of emergency call in the manual mode (for proper emergency services and support), the ERA-GLONASS system automatically transmits the road accident data / or data on other accident to the officer of the single duty dispatch service (during emergency call) by pressing the SOS button.

In case of road accident or other accident for activation of emergency call in manual mode it is necessary:

1. Stop a car, after which in accordance with traffic rules to ensure safety to yourself and other participants of road traffic;
2. Press the SOS button, when pressing the button SOS registration of the device in the wireless telephonic communication networks is carried out, minimum data set about car and its location is collected in accordance with of the technical requirements of the device. After that connection with the officer of the ERA-GLONASS system is made for clearing up reasons (conditions) of the emergency call.
3. After clearing up reasons of the emergency call, the officer of the single duty dispatch service sends minimum data set to emergency services and completes the emergency call.

If the emergency call is not carried out in accordance with the procedure, mentioned above, the emergency call will be considered as erroneous.

⚠ WARNING

Emergency power supply of the system ERA-GLONASS from the battery

- The ERA-GLONASS system battery supplies power during 1 hour in case main power source of the vehicle is cut off due to the collision during the emergency situations.
- The ERA-GLONASS system battery should be replaced every 3 years. For more information refer to the Maintenance Schedule in chapter 7.

(Continued)

(Continued)

LED illumination in red (system malfunction)

If red LED illuminates in normal driving conditions, this can indicate malfunction of the ERA-GLONASS system. Please, have the ERA-GLONASS system checked at an authorized Hyundai dealership immediately. Otherwise correct operation of the ERA-GLONASS system device, installed in your car is not guaranteed. Owner of the car incurs liability for consequences, occurred as a result of nonobservance of conditions, mentioned above.

(Continued)

(Continued)

Arbitrary Removal or Modification

The ERA-GLONASS system calls emergency services for assistance. Thus, any arbitrary removal or changes to the ERA-GLONASS system settings may affect your driving safety. Also, it may even make an erroneous emergency call to the single duty dispatch service. Thereby, we kindly ask you not to make any changes by yourself or by the third parties in the settings of the equipment of the ERA-GLONASS system, installed in your car.

Test Mode



Elements of the system ERA-GLONASS, installed in passenger compartment:

- ① Microphone
- ② SOS button
- ③ SOS TEST button
- ④ LED

There is a technical opportunity to check working ability of the ERA-GLONASS device, installed in your car. In order to avoid making erroneous calls and incorrect operation of the device, checking of the ERA-GLONASS device, installed in your car, should be carried out only by specialists of authorized Hyundai dealerships and on their territory in accordance with the following manual (on applying user interface for launching test mode).

You can start the ERA-GLONASS test mode by pressing the SOS TEST button. The test mode starts with a voice guidance to check working ability of the ERA-GLONASS device. In the course of checking working ability of the ERA-GLONASS device red and green LED illuminate.

Re-press the SOS TEST button again to deactivate the test mode during the voice guidance.

تلفن شبانه روزی: ۰۲۱-۸۸۸۶۲۰۸۵

FarmaSOS.com

Maintenance

Engine compartment	7-3
Maintenance services	7-6
Owner's responsibility	7-6
Owner maintenance precautions	7-6
Owner maintenance	7-7
Owner maintenance schedule	7-8
Scheduled maintenance services	7-10
Normal Maintenance Schedule (For Europe, Except Russia)	7-11
Maintenance Under Severe Usage and Low Mileage Conditions (For Europe, Except Russia)	7-15
Normal Maintenance Schedule (Except Europe, For Russia)	7-17
Maintenance Under Severe Usage and Low Mileage Conditions (Except Europe, For Russia)	7-21
Explanation of scheduled maintenance items ..	7-24
Engine oil	7-28
Checking the engine oil level (Gasoline engine) ..	7-28
Checking the engine oil level (Diesel engine) ..	7-29
Checking the engine oil and filter	7-30
Engine coolant	7-31
Checking the engine coolant level	7-31
Changing the engine coolant	7-34
Brake/clutch fluid	7-35
Checking the brake/clutch fluid level	7-35
Washer fluid	7-36
Checking the washer fluid level	7-36
Parking brake	7-36
Checking the parking brake	7-36
Fuel filter (for Diesel)	7-37
Draining water from fuel filter	7-37
Fuel filter cartridge replacement	7-37
Air cleaner	7-38
Filter replacement	7-38
Climate control air filter	7-40
Filter inspection	7-40
Filter replacement	7-40
Wiper blades	7-41
Blade inspection	7-41
Blade replacement	7-41
Battery	7-44
For best battery service	7-44
Battery capacity label	7-46
Battery recharging	7-46
Reset items	7-47

Tires and wheels	7-48
Tire care	7-48
Recommended cold tire inflation pressures	7-48
Checking tire inflation pressure	7-50
Tire rotation	7-51
Wheel alignment and tire balance	7-52
Tire replacement	7-52
Wheel replacement	7-54
Tire traction	7-54
Tire maintenance	7-54
Tire sidewall labeling	7-54
Low aspect ratio tire	7-59
Fuses	7-60
Fuse/Relay panel description	7-65
Light bulbs	7-75
Headlamp, static bending lamp, position lamp, turn signal lamp and fog lamp light bulb replacement	7-76
Side repeater lamp replacement	7-81
Headlamp and front fog lamp aiming	7-82
Rear combination light bulb replacement	7-87
High mounted stop lamp replacement	7-90
License plate light bulb replacement	7-90
Interior light bulb replacement	7-91

Appearance care	7-93
Exterior care	7-93
Interior care	7-99
Emission control system	7-100
Crankcase emission control system	7-100
Evaporative emission control system	7-100
Exhaust emission control system	7-101

امداد خودرو پارسیا

تلفن شبانه روزی: ۰۲۱-۸۸۶۲۰۸۵

FarinaSOS.com

ENGINE COMPARTMENT

■ Gasoline Engine (Gamma 1.6L GDI)

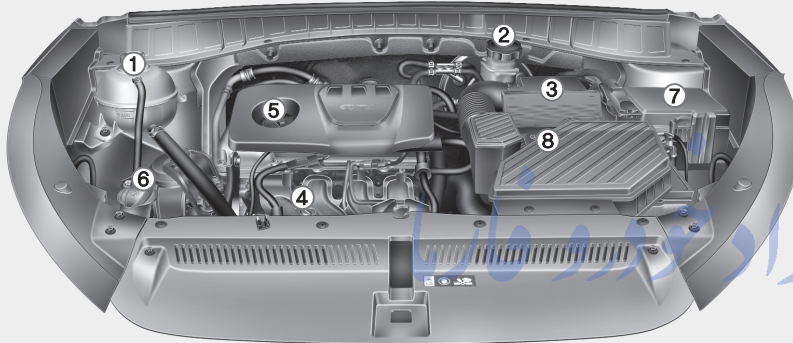

1. Engine coolant reservoir/Radiator cap
2. Brake/clutch fluid reservoir
3. Air cleaner
4. Engine oil dipstick
5. Engine oil filler cap
6. Windshield washer fluid reservoir
7. Fuse box
8. Battery

■ Gasoline Engine (Gamma 1.6L T-GDI)

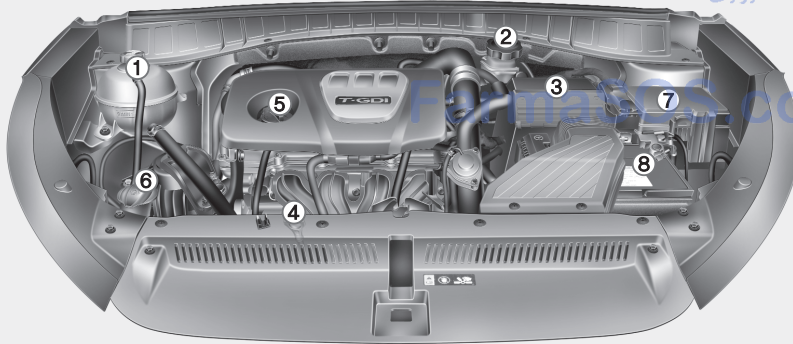

The actual engine room in the vehicle may differ from the illustration.

OTLE075001/OTLE075002

■ Gasoline Engine (Nu 2.0 MPI)

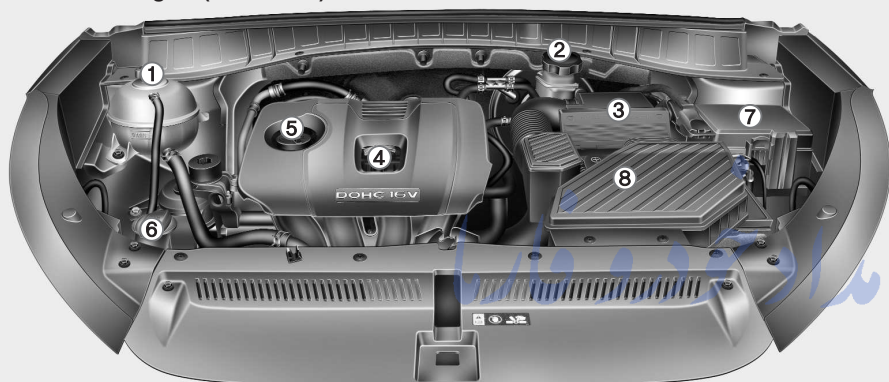

1. Engine coolant reservoir/Radiator cap
2. Brake/clutch fluid reservoir
3. Air cleaner
4. Engine oil dipstick
5. Engine oil filler cap
6. Windshield washer fluid reservoir
7. Fuse box
8. Battery

■ Gasoline Engine (Theta II 2.4 GDI)

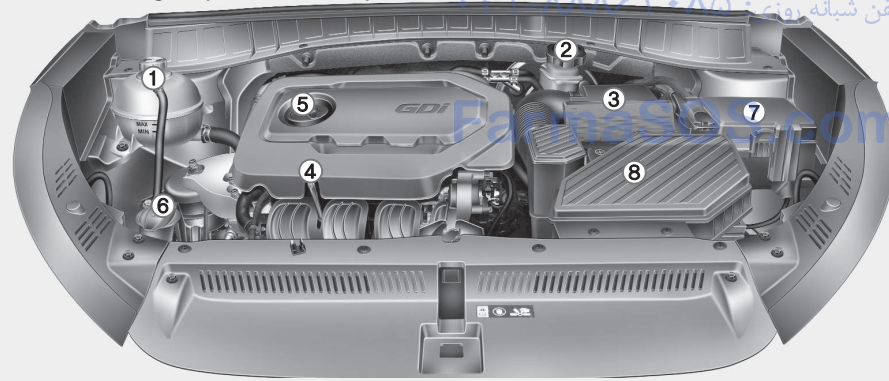

The actual engine room in the vehicle may differ from the illustration.

OTLE075003/OTLE075104

■ Diesel Engine (U2 1.7 TCI)

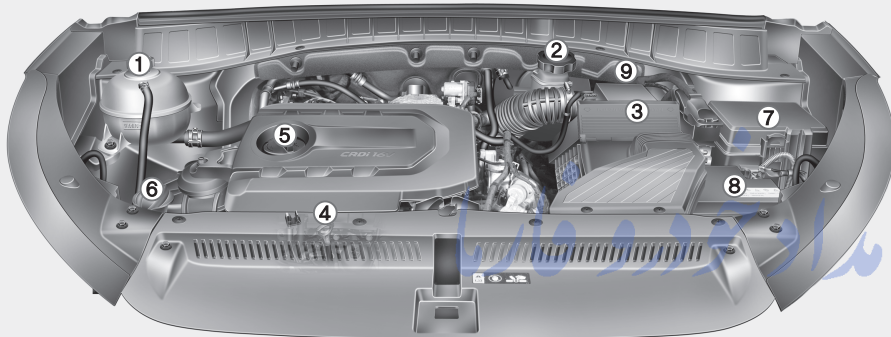

1. Engine coolant reservoir/Radiator cap
2. Brake/clutch fluid reservoir
3. Air cleaner
4. Engine oil dipstick
5. Engine oil filler cap
6. Windshield washer fluid reservoir
7. Fuse box
8. Battery
9. Fuel filter

■ Diesel Engine (R 2.0 TCI)

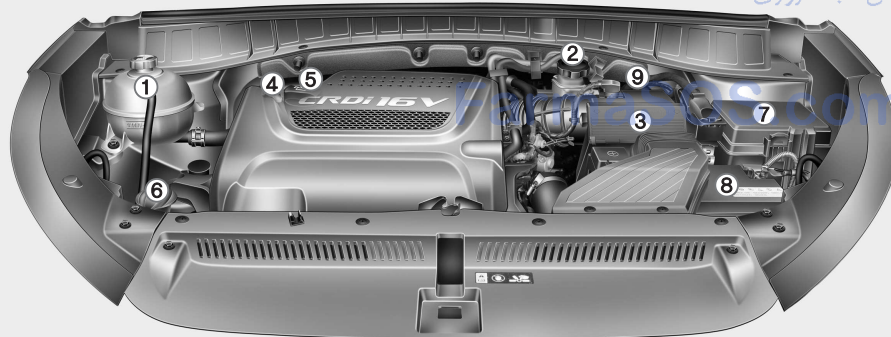

The actual engine room in the vehicle may differ from the illustration.

OTL075002/OTL075001

MAINTENANCE SERVICES

You should exercise the utmost care to prevent damage to your vehicle and injury to yourself whenever performing any maintenance or inspection procedures.

We recommend you have your vehicle maintained and repaired by an authorized HYUNDAI dealer. An authorized HYUNDAI dealer meets HYUNDAI's high service quality standards and receives technical support from HYUNDAI in order to provide you with a high level of service satisfaction.

Owner's responsibility

Maintenance service and record retention are the owner's responsibility.

You should retain documents that show proper maintenance has been performed on your vehicle in accordance with the scheduled maintenance service charts shown on the following pages. You need this information to establish your compliance with the servicing and maintenance requirements of your vehicle warranties.

Detailed warranty information is provided in your Service Passport.

Repairs and adjustments required as a result of improper maintenance or a lack of required maintenance are not covered.

Owner maintenance precautions

Inadequate, incomplete or insufficient servicing may result in operational problems with your vehicle that could lead to vehicle damage, an accident, or personal injury. This chapter provides instructions only for the maintenance items that are easy to perform.

Several procedures can be done only by an authorized HYUNDAI dealer with special tools.

Your vehicle should not be modified in any way. Such modifications may adversely affect the performance, safety or durability of your vehicle and may, in addition, violate conditions of the limited warranties covering the vehicle.

NOTICE

Improper owner maintenance during the warranty period may affect warranty coverage. For details, read the separate Service Passport provided with the vehicle. If you're unsure about any servicing or maintenance procedure, we recommend that the system be serviced by an authorized HYUNDAI dealer.

OWNER MAINTENANCE

WARNING

Performing maintenance work on a vehicle can be dangerous. If you lack sufficient knowledge and experience or the proper tools and equipment to do the work, we recommend that the system be serviced by an authorized HYUNDAI dealer. ALWAYS follow these precautions for performing maintenance work:

- Park your vehicle on level ground, move the shift lever into the P (Park, for automatic transaxle/dual clutch transmission vehicle) position, apply the parking brake, place the ignition switch in the LOCK/OFF position.

(Continued)

(Continued)

- Block the tires (front and back) to prevent the vehicle from moving.

Remove loose clothing or jewelry that can become entangled in moving parts.

- If you must run the engine during maintenance, do so out doors or in an area with plenty of ventilation.
- Keep flames, sparks, or smoking materials away from the battery and fuel-related parts.

The following lists are vehicle checks and inspections that should be performed by the owner or an authorized HYUNDAI dealer at the frequencies indicated to help ensure safe, dependable operation of your vehicle.

Any adverse conditions should be brought to the attention of your dealer as soon as possible.

These Owner Maintenance vehicle checks are generally not covered by warranties and you may be charged for labor, parts and lubricants used.

FarmaSOS.com

 **WARNING**

Diesel Engine

Never manipulate or modify the injection system while running the diesel engine or within 30 seconds after turning OFF the diesel engine. The high-pressure pump, high-pressure pipes, rail, and injectors are still subject to the high pressure right after stopping the diesel engine.

When the fuel leakage vents out, it may cause serious body injury. Any people, who are implemented with the artificial cardiac pacemaker, should remain away from the ECU or the wiring harness by at least 30 cm, while running the diesel engine. The high currents of the electric engine control system produce a considerable amount of magnetic fields.

Owner maintenance schedule

When you stop for fuel:

- Check the engine oil level.
- Check coolant level in the engine coolant reservoir.
- Check the windshield washer fluid level.
- Check for low or under-inflated tires.

 **WARNING**

Be careful when checking your engine coolant level when the engine is hot. This may result in coolant being blown out of the opening and cause serious burns and other injuries.

While operating your vehicle:

- Note any changes in the sound of the exhaust or any smell of exhaust fumes in the vehicle.
- Check for vibrations in the steering wheel. Notice if there is any increased steering effort or looseness in the steering wheel, or change in its straight-ahead position.
- Notice if your vehicle constantly turns slightly or “pulls” to one side when traveling on smooth, level road.
- When stopping, listen and check for unusual sounds, pulling to one side, increased brake pedal travel or “hard-to-push” brake pedal.
- If any slipping or changes in the operation of your transaxle occurs, check the transaxle fluid level.
- Check the automatic transaxle/dual clutch transmission P (Park) function.
- Check the parking brake.
- Check for fluid leaks under your vehicle (water dripping from the air conditioning system during or after use is normal).

At least monthly:

- Check coolant level in the engine coolant reservoir.
- Check the operation of all exterior lights, including the stoplights, turn signals and hazard warning flashers.
- Check the inflation pressures of all tires including the spare for tires that are worn, show uneven wear, or are damaged.
- Check for loose wheel lug nuts.

**At least twice a year:
(i.e., every Spring and Fall)**

- Check radiator, heater and air conditioning hoses for leaks or damage.
- Check windshield washer spray and wiper operation. Clean wiper blades with clean cloth dampened with washer fluid.
- Check headlamp alignment.
- Check muffler, exhaust pipes, shields and clamps.
- Check the seat belts for wear and function.

تلفن شبانه روزی: ۰۲۱-۸۸۸۶۲۰۸۵

FarmaSOS.com

At least once a year:

- Clean body and door drain holes.
- Lubricate door hinges and hood hinges.
- Lubricate door and hood locks and latches.
- Lubricate door rubber weather strips.
- Check the air conditioning system.
- Inspect and lubricate automatic transaxle linkage and controls.
- Clean the battery and terminals.
- Check the brake fluid level.

SCHEDULED MAINTENANCE SERVICES

Follow Normal Maintenance Schedule if the vehicle is usually operated where none of the following conditions apply. If any of the following conditions apply, you must follow the Maintenance Under Severe Usage Conditions.

- Repeated driving short distance of less than 8 km (5 miles) in normal temperature or less than 16 km (10 miles) in freezing temperature
- Extensive engine idling or low speed driving for long distances
- Driving on rough, dusty, muddy, unpaved, graveled or salt-spread roads
- Driving in areas using salt or other corrosive materials or in very cold weather
- Driving in the condition of inflowing sand or dust into engine
- Driving in heavy traffic area
- Driving on uphill, downhill, or mountain road repeatedly
- Towing a trailer or using a camper, or roof rack
- Driving as a patrol car, taxi, other commercial use of vehicle towing
- Driving over 170 km/h (106 mile/h)
- Frequently driving in stop-and-go condition

If your vehicle is operated under the above conditions, you should inspect, replace or refill more frequently than the following Normal Maintenance Schedule. After the periods or distance shown in the chart, continue to follow the prescribed maintenance intervals.

Normal Maintenance Schedule (For Europe, Except Russia)

MAINTENANCE ITEM	MAINTENANCE INTERVALS	Months	24	48	72	96	120	144	168	192
	Miles x 1,000		20	40	60	80	100	120	140	160
	Km x 1,000		30	60	90	120	150	180	210	240
Drive belts (Gasoline) *1		First Inspect at 90,000 km (60,000 miles) or 72 months, after every 30,000 km (20,000 miles) or 24 months								
Drive belts (Diesel) *1		First Inspect at 90,000 km (60,000 miles) or 48 months, after every 30,000 km (20,000 miles) or 24 months								
Engine oil and engine oil filter **	Diesel *2 *3 *4	R	R	R	R	R	R	R	R	R
	Gasoline (1.6 GDI) *2 *5	R	R	R	R	R	R	R	R	R
	Gasoline (1.6 T-GDI) *2	Replace every 15,000 km (10,000 miles) or 12 months								
	Gasoline (2.0 MPI) *2	Replace every 15,000 km (10,000 miles) or 12 months								

I : Inspect and if necessary, adjust, correct, clean or replace.

R : Replace or change.

** : The engine oil level should be checked regularly and maintained properly. Operating with an insufficient amount of oil can damage the engine, and such damage is not covered by warranty.

*1 : Inspect drive belt tensioner, idler and alternator pulley and if necessary correct or replace.

*2 : Check the engine oil level and leak every 500 km (350 miles) or before starting a long trip.

*3 : This maintenance schedule depends on fuel quality. It is applicable only when using a qualified fuel <"EN590 or equivalent">. If the diesel fuel specifications don't meet the EN590, it must be replaced according to the severe maintenance schedule.

*4 : If the recommended oil is not available, replace engine oil and engine oil filter every 20,000 km or 12 months.

*5 : If the recommended oil is not available, replace engine oil and engine oil filter every 15,000 km.

Normal Maintenance Schedule (For Europe, Except Russia) (Cont.)

MAINTENANCE ITEM	MAINTENANCE INTERVALS	Months	24	48	72	96	120	144	168	192
		Miles x 1,000	20	40	60	80	100	120	140	160
		Km x 1,000	30	60	90	120	150	180	210	240
Fuel additives (Gasoline) *7		Add every 15,000 km (10,000 miles) or 12 months								
Intercooler, in/out hose, air intake hose	1.6 T-GDI	Inspect every 10,000 km (6,500 miles)								
Air cleaner filter		I	R	I	R	I	R	I	R	
Spark plugs	For 1.6 T-GDI	Replace every 75,000 km (50,000 miles) *8 or 60 months								
	Except 1.6 T-GDI	Replace every 160,000 km (100,000 miles) *8 or 120 months								
Vapor hose and fuel filler cap (Gasoline)			I		I		I		I	
Fuel tank air filter (Gasoline)			I		I		I		I	
Fuel filter (Gasoline) *9		I		I		I		I		I
Fuel lines, hoses and connections (Gasoline)			I		I		I		I	
Fuel lines, hoses and connections (Diesel)		I	I	I	I	I	I	I	I	I

I : Inspect and if necessary, adjust, correct, clean or replace.

R : Replace or change.

*7 : If good quality gasolines meet Europe Fuel standards (EN228) or equivalents including fuel additives is not available, one bottle of additive is recommended. Additives are available from your authorized HYUNDAI dealer along with information on how to use them. Do not mix other additives.

*8 : For your convenience, it can be replaced prior to its interval when you do maintenance of other items.

*9 : The fuel filter is considered to be maintenance free but periodic inspection is recommended for this maintenance schedule depends on fuel quality. If there are some important matters like fuel flow restriction, surging, loss of power, hard starting problem etc, replace the fuel filter immediately regardless of maintenance schedule and consult an authorized HYUNDAI dealer for details.

Normal Maintenance Schedule (For Europe, Except Russia) (Cont.)

MAINTENANCE ITEM	MAINTENANCE INTERVALS	Months	24	48	72	96	120	144	168	192
	Miles x 1,000		20	40	60	80	100	120	140	160
	Km x 1,000		30	60	90	120	150	180	210	240
Fuel filter cartridge (Diesel) ^{*10}			I	R	I	R	I	R	I	R
Cooling system			Inspect "Coolant level adjustment and leak" every day. At first, inspect 60,000 km (40,000 miles) or 48 months after that, inspect every 30,000 km (20,000 miles) or 24 months							
Engine coolant ^{*11}			At first, replace at 210,000 km (120,000 miles) or 10 years : after that, replace every 30,000 km (20,000 miles) or 24 months ^{*12}							
Battery condition			I	I	I	I	I	I	I	I
Brake lines, hoses and connections			I	I	I	I	I	I	I	I
Parking brake			I	I	I	I	I	I	I	I
Brake/clutch fluid			R	R	R	R	R	R	R	R
Disc brakes and pads			I	I	I	I	I	I	I	I
Steering gear rack, linkage and boots			I	I	I	I	I	I	I	I

I : Inspect and if necessary, adjust, correct, clean or replace.

R : Replace or change.

^{*10} : This maintenance schedule depends on fuel quality. It is applicable only when using a qualified fuel <"EN590 or equivalent">. If the diesel fuel specifications don't meet the EN590, it must be replaced more frequently. If there are some important safety matters like fuel flow restriction, surging, loss of power, hard starting problem etc., replace the fuel filter immediately regardless of maintenance schedule. We recommend that you consult an authorized HYUNDAI dealer for details.

^{*11} : When adding coolant, use only deionized water or soft water for your vehicle and never mix hard water in the coolant filled at the factory. An improper coolant mixture can result in serious malfunction or engine damage.

^{*12} : For your convenience, it can be replaced prior to it's interval when you do maintenance of other items.

Normal Maintenance Schedule (For Europe, Except Russia) (Cont.)

MAINTENANCE ITEM	MAINTENANCE INTERVALS	Months	24	48	72	96	120	144	168	192
	Miles x 1,000		20	40	60	80	100	120	140	160
	Km x 1,000		30	60	90	120	150	180	210	240
Driveshaft and boots			I	I	I	I	I	I	I	I
Tire (pressure & tread wear)			I	I	I	I	I	I	I	I
Front suspension ball joints			I	I	I	I	I	I	I	I
Air conditioner refrigerant			I	I	I	I	I	I	I	I
Air conditioner compressor			I	I	I	I	I	I	I	I
Climate control air filter			R	R	R	R	R	R	R	R
Manual transaxle fluid ^{*13}				I		I		I		I
Dual clutch transmission fluid ^{*13}				I		I		I		I
Automatic transaxle fluid					No check, No service required					
Transfer case oil (4WD) ^{*13}				I		I		I		I
Rear differential oil (4WD) ^{*13}				I		I		I		I
Propeller shaft (4WD)			I	I	I	I	I	I	I	I
Valve clearance (Gasoline 1.6) ^{*14}					I			I		
Exhaust system			I	I	I	I	I	I	I	I

I : Inspect and if necessary, adjust, correct, clean or replace.

R : Replace or change.

^{*13} : Manual transaxle/dual clutch transmission fluid, transfer case oil and differential oil should be changed anytime they have been submerged in water.

^{*14} : Inspect for excessive valve noise and/or engine vibration and adjust if necessary. We recommend that the system be checked by an authorized HYUNDAI dealer.

Maintenance Under Severe Usage and Low Mileage Conditions (For Europe, Except Russia)

The following items must be serviced more frequently on cars mainly used under severe and low mileage driving conditions. Refer to the chart below for the appropriate maintenance intervals.

R : Replace I : Inspect and if necessary, adjust, correct, clean or replace

Maintenance item	Maintenance operation	Maintenance intervals	Driving condition
Engine oil and engine oil filter	R	Diesel Replace every 15,000 km (10,000 miles) or 12 months	A, B, C, D, E, F, G, H, I, K, L
		Gasoline (1.6 GDI) Replace every 7,500 km (4,500 miles) or 6 months	
		Gasoline (1.6 T-GDI) Replace every 7,500 km (4,500 miles) or 6 months	
		Gasoline (2.0 MPI) Replace every 7,500 km (4,500 miles) or 6 months	
Air cleaner filter	R	Replace more frequently depending on the condition	C, E
Spark plugs	R	Replace more frequently depending on the condition	B, H
Steering gear rack, linkage and boots	I	Inspect more frequently depending on the condition	C, D, E, F, G
Front suspension ball joints	I	Inspect more frequently depending on the condition	C, D, E, F, G
Disc brakes and pads, calipers and rotors	I	Inspect more frequently depending on the condition	C, D, E, G, H
Parking brake	I	Inspect more frequently depending on the condition	C, D, G, H
Driveshaft and boots	I	Inspect more frequently depending on the condition	C, D, E, F, G, H, I

Maintenance

Maintenance item	Maintenance operation	Maintenance intervals	Driving condition
Climate control air filter	R	Replace more frequently depending on the condition	C, E, G
Manual transaxle fluid	R	Every 120,000 km (80,000 miles)	C, D, E, F, G, H, I, K
Automatic transaxle fluid	R	Every 100,000 km (62,000 miles)	A, C, D, E, F, G, H, I, K
Dual clutch transmission fluid	R	Every 120,000 km (80,000 miles)	C, D, E, G, H, I, K
Rear differential oil (4WD)	R	Every 120,000 km (80,000 miles)	C, D, E, G, I, K, H
Transfer case oil (4WD)	R	Every 120,000 km (80,000 miles)	C, D, E, G, I, K, H
Propeller shaft (4WD)	I	Every 20,000 km (12,500 miles) or 12 months	C, E

Severe driving conditions

- A : Repeatedly driving short distance of less than 5 miles (8 km) in normal temperature or less than 10 miles (16 km) in freezing temperature
- B : Extensive engine idling or low speed driving for long distances
- C : Driving on rough, dusty, muddy, unpaved, graveled or salt spread roads
- D : Driving in areas using salt or other corrosive materials or in very cold weather
- E : Driving in the condition of inflowing sand or dust into engine
- F : Driving in heavy traffic area
- G : Driving on uphill, downhill, or mountain roads repeatedly
- H : Towing a trailer, or using a camper or roof rack
- I : Driving for patrol car, taxi, commercial car or vehicle towing
- J : Driving over 140 km/h (87 mile/h)
- K : Driving over 170 km/h (106 mile/h)
- L : Frequently driving in stop-and-go conditions and under 15,000 km per year.

Normal Maintenance Schedule (Except Europe, For Russia)

MAINTENANCE ITEM	MAINTENANCE INTERVALS	Months	12	24	36	48	60	72	84	96
		Miles x 1,000	10	20	30	40	50	60	70	80
		Km x 1,000	15	30	45	60	75	90	105	120
Drive belts *1	Gasoline		I	I	I	I	I	I	I	I
	Diesel		At first, inspect at 90,000 km (60,000 miles) or 48 months after that, inspect every 30,000 km (20,000 miles) or 24 months							
Engine oil and engine oil filter *3	Diesel *2 - For Russia		Replace every 15,000 km (10,000 miles) or 12 months							
	Diesel *2 - Except Russia		Replace every 10,000 km (6,500 miles) or 12 months							
	Gasoline (1.6 GDI, 2.0 MPI, 2.4 GDI) - Except Middle East, Morocco, Egypt *2		R	R	R	R	R	R	R	R
	Gasoline (1.6 GDI, 2.0 MPI, 2.4 GDI) - For Middle East, Morocco, Egypt *2		Replace every 10,000 km (6,500 miles) or 12 months							
	Gasoline (1.6 T-GDI) - For South Africa *2		R	R	R	R	R	R	R	R
	Gasoline (1.6 T-GDI) - Except South Africa *2		Replace every 10,000 km (6,500 miles) or 6 months							

I : Inspect and if necessary, adjust, correct, clean or replace.

R : Replace or change.

*1 : Inspect drive belt tensioner, idler and alternator pulley and if necessary correct or replace.

*2 : Check the engine oil level and leak every 500 km (350 miles) or before starting a long trip.

*3 : The engine oil level should be checked regularly and maintained properly. Operating with an insufficient amount of oil can damage the engine, and such damage is not covered by warranty.

Normal Maintenance Schedule (Except Europe, For Russia) (Cont.)

MAINTENANCE INTERVALS MAINTENANCE ITEM	Months	12	24	36	48	60	72	84	96
	Miles x 1,000	10	20	30	40	50	60	70	80
	Km x 1,000	15	30	45	60	75	90	105	120
Fuel additives (Gasoline) *4	Add every 10,000 km (6,500 miles) or 6 months								
Intercooler, in/out hose, air intake hose	1.6 T-GDI	Inspect every 10,000 km (6,500 miles)							
Air cleaner filter	Except Middle East	I	I	R	I	I	R	I	I
	For Middle East	R	R	R	R	R	R	R	R
Spark plugs	For 1.6 T-GDI	Replace every 75,000 km (50,000 miles) *5 or 60 months							
	Except 1.6 T-GDI	Replace every 160,000 km (100,000 miles) *5 or 120 months							
Vapor hose and fuel filler cap (Gasoline)					I				I
Fuel tank air filter (Gasoline)					R		I		R
Fuel filter (Gasoline) *6			I		R		I		R
Fuel lines, hoses and connections (Gasoline)					I				I
Fuel lines, hoses and connections (Diesel)			I		I		I		I

I : Inspect and if necessary, adjust, correct, clean or replace.

R : Replace or change.

*4 : If good quality gasolines meet Europe Fuel standards (EN228) or equivalents including fuel additives is not available, one bottle of additive is recommended. Additives are available from your authorized HYUNDAI dealer along with information on how to use them. Do not mix other additives.

*5 : For your convenience, it can be replaced prior to it's interval when you do maintenance of other items.

*6 : The fuel filter is considered to be maintenance free but periodic inspection is recommended for this maintenance schedule depends on fuel quality. If there are some important matters like fuel flow restriction, surging, loss of power, hard starting problem etc, replace the fuel filter immediately regardless of maintenance schedule. We recommend that you consult an authorized HYUNDAI dealer for details.

Normal Maintenance Schedule (Except Europe, For Russia) (Cont.)

MAINTENANCE ITEM	MAINTENANCE INTERVALS	Months	12	24	36	48	60	72	84	96
		Miles x 1,000	10	20	30	40	50	60	70	80
		Km x 1,000	15	30	45	60	75	90	105	120
Fuel filter cartridge (Diesel) *7			I			R		I		R
Cooling system		Inspect "Coolant level adjustment and leak" every day. At first, inspect 60,000 km (40,000 miles) or 48 months after that, inspect every 30,000 km (20,000 miles) or 24 months								
Engine coolant *8		At first, replace at 200,000 km (120,000 miles) or 120 months : after that, replace every 40,000 km (25,000 miles) or 24 months *5								
Battery condition		I	I	I	I	I	I	I	I	I
Brake lines, hoses and connections		I	I	I	I	I	I	I	I	I
Parking brake		I	I	I	I	I	I	I	I	I
Brake/clutch fluid		I	I	I	I	I	I	I	I	I
Disc brakes and pads		I	I	I	I	I	I	I	I	I

I : Inspect and if necessary, adjust, correct, clean or replace.

R : Replace or change.

*5 : For your convenience, it can be replaced prior to it's interval when you do maintenance of other items.

*7 : This maintenance schedule depends on fuel quality. It is applicable only when using a qualified fuel <"EN590 or equivalent">. If the diesel fuel specifications don't meet the EN590, it must be replaced more frequently. HYUNDAI recommends "every 7,500km inspection, every 15,000km replacement". If there are some important safety matters like fuel flow restriction, surging, loss of power, hard starting problem etc., replace the fuel filter immediately regardless of maintenance schedule. We recommend that you consult an authorized HYUNDAI dealer for details.

*8 : When adding coolant, use only deionized water or soft water for your vehicle and never mix hard water in the coolant filled at the factory. An improper coolant mixture can result in serious malfunction or engine damage. For your convenience, it can be replaced prior to it's interval when you do maintenance of other items.

Maintenance

Normal Maintenance Schedule (Except Europe, For Russia) (Cont.)

MAINTENANCE ITEM	MAINTENANCE INTERVALS	Months	12	24	36	48	60	72	84	96
		Miles x 1,000	10	20	30	40	50	60	70	80
		Km x 1,000	15	30	45	60	75	90	105	120
Steering gear rack, linkage and boots		I	I	I	I	I	I	I	I	I
Driveshaft and boots			I		I		I		I	
Tire (pressure & tread wear)		I	I	I	I	I	I	I	I	I
Front suspension ball joints		I	I	I	I	I	I	I	I	I
Air conditioner refrigerant		I	I	I	I	I	I	I	I	I
Air conditioner compressor		I	I	I	I	I	I	I	I	I
Climate control air filter		R	R	R	R	R	R	R	R	R
Manual transaxle fluid * ⁹					I					I
Dual clutch transmission fluid * ⁹					I					I
Automatic transaxle fluid		No check, No service required								
Transfer case oil (4WD) * ⁹					I					I
Rear differential oil (4WD) * ⁹					I					I
Propeller shaft (4WD)			I		I			I		I
Valve clearance (Gasoline) * ¹⁰								I		
Exhaust system			I		I			I		I
ERA-GLONASS system (for Russia)		I	I	I	I	I	I	I	I	I
ERA-GLONASS system battery (for Russia, if equipped)		Replace every 3 years								

I : Inspect and if necessary, adjust, correct, clean or replace.

R : Replace or change.

*⁹ : Manual transaxle/Dual clutch transmission fluid, transfer case oil and differential oil should be changed anytime they have been submerged in water.

*¹⁰ : Inspect for excessive valve noise and/or engine vibration and adjust if necessary. We recommend that the system be checked by an authorized HYUNDAI dealer.

Maintenance Under Severe Usage and Low Mileage Conditions (Except Europe, For Russia)

The following items must be serviced more frequently on cars mainly used under severe driving conditions. Refer to the chart below for the appropriate maintenance intervals.

R : Replace I : Inspect and if necessary, adjust, correct, clean or replace

Maintenance item		Maintenance operation	Maintenance intervals	Driving condition
Engine oil and engine oil filter	Diesel - For Russia		7,500 km (4,500 miles) or 6 months	A, B, C, D, E, F, G, H, I, K, L
	Diesel - Except Russia		5,000 km (3,000 miles) or 6 months	
	Gasoline (1.6 GDI, 2.0 MPI, 2.4 GDI) - Except Middle East, Morocco, Egypt		7,500 km (4,500 miles) or 6 months	
	Gasoline (1.6 GDI, 2.0 MPI, 2.4 GDI) - For Middle East, Morocco, Egypt		5,000 km (3,000 miles) or 6 months	
	Gasoline (1.6 T-GDI) - For South Africa		7,500 km (4,500 miles) or 6 months	
	Gasoline (1.6 T-GDI) - Except South Africa		5,000 km (3,000 miles) or 6 months	
Air cleaner filter		R	Replace more frequently depending on the condition	C, E
Spark plugs		R	Replace more frequently depending on the condition	B, H
Steering gear rack, linkage and boots		I	Inspect more frequently depending on the condition	C, D, E, F, G

Maintenance

Maintenance item	Maintenance operation	Maintenance intervals	Driving condition
Front suspension ball joints	I	Inspect more frequently depending on the condition	C, D, E, F, G
Disc brakes and pads, calipers and rotors	I	Inspect more frequently depending on the condition	C, D, E, G, H
Parking brake	I	Inspect more frequently depending on the condition	C, D, G, H
Driveshaft and boots	I	Inspect more frequently depending on the condition	C, D, E, F, G, H, I, K
Climate control air filter	R	Replace more frequently depending on the condition	C, E, G
Manual transaxle fluid	R	Every 120,000 km (80,000 miles)	C, D, E, F, G, H, I, K
Automatic transaxle fluid	R	Every 100,000 km (62,000 miles)	A, C, F, G, H, I, K
Dual clutch transmission fluid	R	Every 120,000 km (80,000 miles)	C, D, E, G, H, I, K
Rear differential oil (4WD)	R	Every 120,000 km (80,000 miles)	C, D, E, G, I, K, H
Transfer case oil (4WD)	R	Every 120,000 km (80,000 miles)	C, D, E, G, I, K, H
Propeller shaft (4WD)	I	Every 15,000 km (10,000 miles) or 12 months	C, E
ERA-GLONASS system (for Russia)	I	Every 7,500 km (4,650 miles) or 6 months	A, L

Severe driving conditions

- A : Repeatedly driving short distance of less than 5 miles (8 km) in normal temperature or less than 10 miles (16 km) in freezing temperature
- B : Extensive engine idling or low speed driving for long distances
- C : Driving on rough, dusty, muddy, unpaved, graveled or salt spread roads
- D : Driving in areas using salt or other corrosive materials or in very cold weather
- E : Driving in the condition of inflowing sand or dust into engine
- F : Driving in heavy traffic area
- G : Driving on uphill, downhill, or mountain roads repeatedly
- H : Towing a trailer, or using a camper or roof rack
- I : Driving for patrol car, taxi, commercial car or vehicle towing
- J : Driving over 140 km/h (87 mile/h)
- K : Driving over 170 km/h (106 mile/h)
- L : Frequently driving in stop-and-go conditions

تلفن شبانه روزی: ۰۲۱-۸۸۸۶۲۰۸۵

FarmaSOS.com

EXPLANATION OF SCHEDULED MAINTENANCE ITEMS

Engine oil and filter

The engine oil and filter should be changed at the intervals specified in the maintenance schedule. If the car is being driven in severe conditions, more frequent oil and filter changes are required.

Drive belts

Inspect all drive belts for evidence of cuts, cracks, excessive wear or oil saturation and replace if necessary. Drive belts should be checked periodically for proper tension and adjusted as necessary.



CAUTION

When you are inspecting the belt, place the ignition switch to the LOCK/OFF or ACC position.

Fuel filter (cartridge)

A clogged-up fuel filter may limit the vehicle driving speed, damage the emission system, and cause the hard starting. When a considerable amount of foreign substances are accumulated in the fuel tank, the fuel filter should be replaced.

Upon installing a new fuel filter, operate the diesel engine for several minutes, and check the connections for any leakages. We recommend you to have the fuel filter replaced by an authorized HYUNDAI dealer.

Fuel lines, fuel hoses and connections

Check the fuel lines, fuel hoses and connections for leakage and damage. We recommend that the fuel lines, fuel hoses and connections be replaced by an authorized HYUNDAI dealer.



WARNING

Diesel Engine

Never manipulate or modify the injection system while running the diesel engine or within 30 seconds after turning OFF the diesel engine. The high-pressure pump, high-pressure pipes, rail, and injectors are still subject to the high pressure right after stopping the diesel engine. When the fuel leakage vents out, it may cause serious body injury. Any people, who are implemented with the artificial cardiac pacemaker, should remain away from the ECU or the wiring harness by at least 30 cm while running the diesel engine. The high currents of the common rail system produce a considerable amount of magnetic fields.

Vapor hose and fuel filler cap

The vapor hose and fuel filler cap should be inspected at those intervals specified in the maintenance schedule. Make sure that a new vapor hose or fuel filler cap is correctly replaced.

Vacuum crankcase ventilation hoses (if equipped)

Inspect the surface of hoses for evidence of heat and/or mechanical damage. Hard and brittle rubber, cracking, tears, cuts, abrasions, and excessive swelling indicate deterioration. Particular attention should be paid to examine those hose surfaces nearest to high heat sources, such as the exhaust manifold.

Inspect the hose routing to assure that the hoses do not come in contact with any heat source, sharp edges or moving component which might cause heat damage or mechanical wear. Inspect all hose connections, such as clamps and couplings, to make sure they are secure, and that no leaks are present. Hoses should be replaced immediately if there is any evidence of deterioration or damage.

Air cleaner filter

We recommend that the air cleaner filter be replaced by an authorized HYUNDAI dealer.

Spark plugs (For Gasoline Engine)

Make sure to install new spark plugs of the correct heat range.

WARNING

Do not disconnect and inspect spark plugs when the engine is hot. You may burn yourself.

Valve clearance (For Gasoline Engine)

Inspect excessive valve noise and/or engine vibration and adjust if necessary. We recommend that the system be serviced by an authorized HYUNDAI dealer.

Cooling system

Check the cooling system parts, such as radiator, coolant reservoir, hoses and connections for leakage and damage. Replace any damaged parts.

Engine coolant

The coolant should be changed at the intervals specified in the maintenance schedule.

Automatic transaxle fluid

Automatic transaxle fluid should not be checked under normal usage conditions.

We recommend that the automatic transaxle fluid changed by an authorized HYUNDAI dealer according to the maintenance schedule.

i Information

Automatic transaxle fluid color is basically red.

As the vehicle is driven, the automatic transaxle fluid will begin to look darker.

It is normal condition and you should not judge the need to replace the fluid based upon the changed color.

NOTICE

The use of a non-specified fluid could result in transaxle malfunction and failure.

Use only specified automatic transaxle fluid.

(Refer to “Recommended lubricants and capacities” in chapter 8.)

Manual transaxle fluid (if equipped)

Inspect the manual transaxle fluid according to the maintenance schedule.

Dual clutch transmission fluid (if equipped)

Inspect the dual clutch transmission fluid according to the maintenance schedule.

Brake hoses and lines

Visually check for proper installation, chafing, cracks, deterioration and any leakage. Replace any deteriorated or damaged parts immediately.

Brake/Clutch fluid (if equipped)

Check brake fluid level in the brake fluid reservoir. The level should be between "MIN" and "MAX" marks on the side of the reservoir. Use only hydraulic brake fluid conforming to DOT 3 or DOT 4 specification.

Parking brake

Inspect the parking brake system including the parking brake lever and cables.

Brake pads, calipers and rotors

Check the pads for excessive wear, discs for run out and wear, and calipers for fluid leakage.

For more information on checking the pads or lining wear limit, refer to the HYUNDAI web site.

(<http://service.hyundai-motor.com>)

Suspension mounting bolts

Check the suspension connections for looseness or damage. Retighten to the specified torque.

FarmaSOS.com

Steering gear box, linkage & boots/lower arm ball joint

With the vehicle stopped and engine off, check for excessive free-play in the steering wheel.

Check the linkage for bends or damage. Check the dust boots and ball joints for deterioration, cracks, or damage. Replace any damaged parts.

Drive shafts and boots

Check the drive shafts, boots and clamps for cracks, deterioration, or damage. Replace any damaged parts and, if necessary, repack the grease.

Air conditioning refrigerant/compressor

Check the air conditioning lines and connections for leakage and damage.

ENGINE OIL

Checking the engine oil level (Gasoline engine)

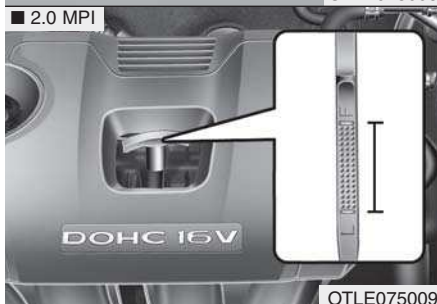
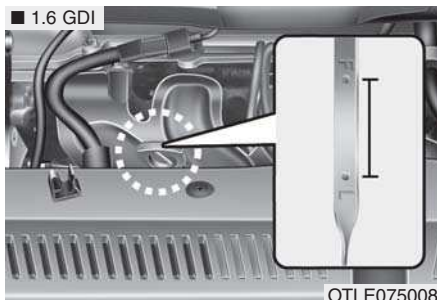

1. Be sure the vehicle is on level ground.
2. Start the engine and allow it to reach normal operating temperature.

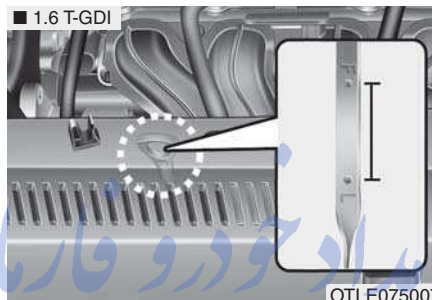

3. Turn the engine off and wait for a few minutes (about 5 minutes) for the oil to return to the oil pan.
4. Pull the dipstick out, wipe it clean, and re-insert it fully.

5. Pull the dipstick out again and check the level. The level should be between F (Full) and L (Low).
6. If it is near or at L, add enough oil to bring the level to F.

⚠ WARNING

Radiator hose

Be very careful not to touch the radiator hose when checking or adding the engine oil as it may be hot enough to burn you.

NOTICE

- Do not overfill the engine oil. It may damage the engine.
- Do not spill engine oil, when adding or changing engine oil. If you drop the engine oil on the engine room, wipe it off immediately.
- When you wipe the oil level gauge, you should wipe it with a clean cloth. When mixed with debris, it can cause engine damage.

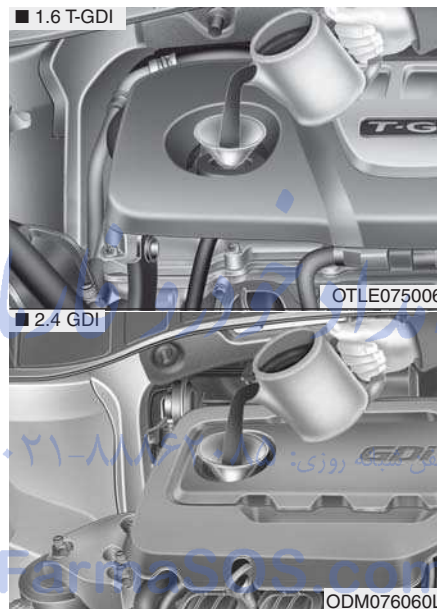
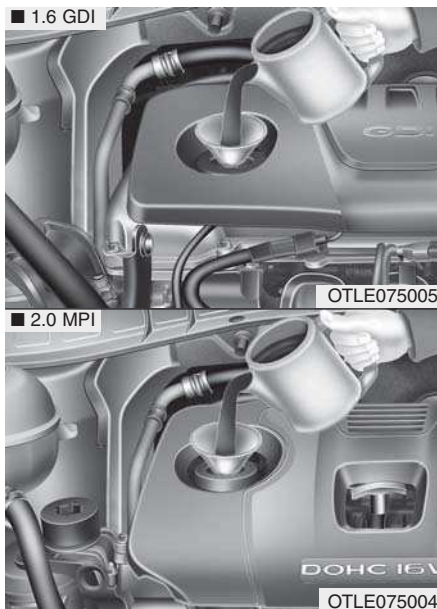

Use only the specified engine oil.
(Refer to “Recommended lubricants and capacities” in chapter 8.)

Checking the engine oil level (Diesel engine)

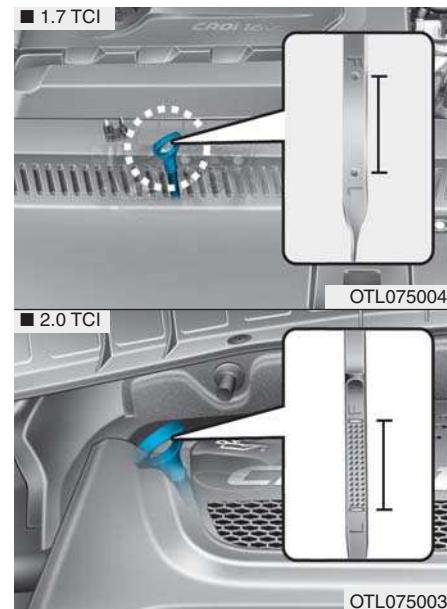

1. Be sure the vehicle is on level ground.
2. Start the engine and allow it to reach normal operating temperature.

3. Turn the engine off and wait for a few minutes (about 5 minutes) for the oil to return to the oil pan.
4. Pull the dipstick out, wipe it clean, and re-insert it fully.
5. Pull the dipstick out again and check the level. The level should be between F (Full) and L (Low).
6. If it is near or at L, add enough oil to bring the level to F.

WARNING

Radiator hose

Be very careful not to touch the radiator hose when checking or adding the engine oil as it may be hot enough to burn you.

NOTICE

- Do not spill engine oil, when adding or changing engine oil. If you drop the engine oil on the engine room, wipe it off immediately.
- When you wipe the oil level gauge, you should wipe it with a clean cloth. When mixed with debris, it can cause engine damage.

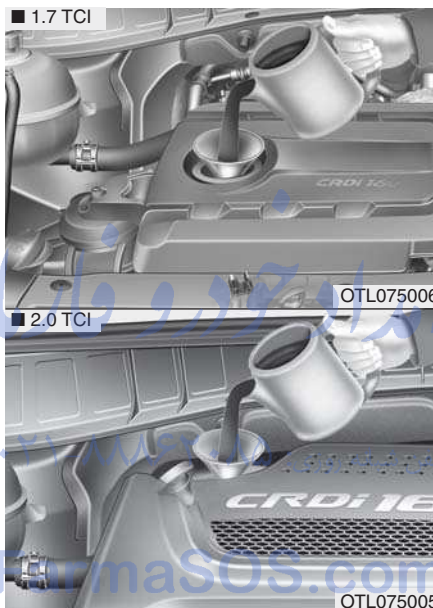

Use only the specified engine oil.
(Refer to “Recommended lubricants and capacities” in chapter 8.)

Checking the engine oil and filter



We recommend that the engine oil and filter be replaced by an authorized HYUNDAI dealer.

WARNING

Used engine oil may cause irritation or cancer of the skin if left in contact with the skin for prolonged periods of time. Used engine oil contains chemicals that have caused cancer in laboratory animals. Always protect your skin by washing your hands thoroughly with soap and warm water as soon as possible after handling used oil.

ENGINE COOLANT

The high-pressure cooling system has a reservoir filled with year-round antifreeze coolant. The reservoir is filled at the factory.

Check the antifreeze protection and coolant concentration level at least once a year, at the beginning of the winter season, and before traveling to a colder climate.

NOTICE

- **When the engine overheats from low engine coolant, suddenly adding engine coolant may cause cracks in the engine. To prevent damage, add engine coolant slowly in small quantities.**
- **Do not drive with no engine coolant. It may cause water pump failure and engine seizure, etc.**

Checking the engine coolant level

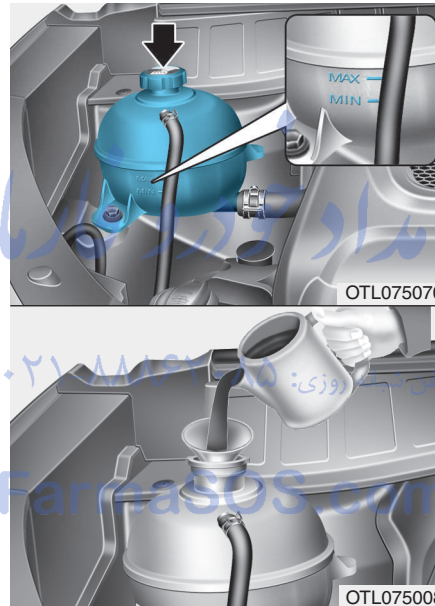

Check the condition and connections of all cooling system hoses and heater hoses. Replace any swollen or deteriorated hoses.

The coolant level should be filled between MAX and MIN marks on the side of the coolant reservoir when the engine is cool.

If the coolant level is low, add enough distilled (deionized) or soft water. Bring the level to MAX, but do not overfill.

If frequent additions are required, we recommend that the system be inspected by an authorized HYUNDAI dealer.

⚠ WARNING



Removing radiator cap

- Never attempt to remove the radiator cap while the engine is operating or hot. Doing so might lead to cooling system and engine damage and could result in serious personal injury from escaping hot coolant or steam.

(Continued)

(Continued)

- Turn the engine off and wait until it cools down. Use extreme care when removing the radiator cap. Wrap a thick towel around it, and turn it counterclockwise slowly to the first stop. Step back while the pressure is released from the cooling system.

When you are sure all the pressure has been released, press down on the cap, using a thick towel, and continue turning counterclockwise to remove it.

- Even if the engine is not operating, do not remove the radiator cap or the drain plug while the engine and radiator are hot. Hot coolant and steam may still blow out under pressure, causing serious injury.

⚠ WARNING



The electric motor (cooling fan) is controlled by engine coolant temperature, refrigerant pressure

and vehicle speed. It may sometimes operate even when the engine is not running. Use extreme caution when working near the blades of the cooling fan so that you are not injured by a rotating fan blades. As the engine coolant temperature decreases, the electric motor will automatically shut off. This is a normal condition.

The electric motor (cooling fan) may operate until you disconnect the negative battery cable.

NOTICE

Make sure the coolant cap is properly closed after refill of coolant. Otherwise the engine could be overheated while driving.

■ Engine room front view

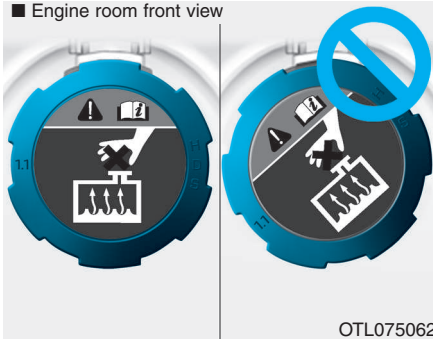

OTL075062

1. Check if the radiator cap label is straight in front.

(Continued)

(Continued)

■ Engine room rear view

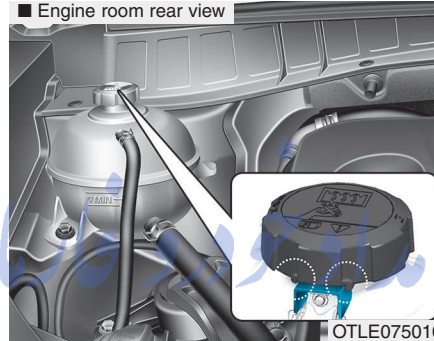

OTLE075010

2. Make sure that the tiny protrusions inside the coolant cap should be securely interlocked.

FarmaSOS.com

Recommended engine coolant

- When adding coolant, use only deionized water or soft water for your vehicle and never mix hard water in the coolant filled at the factory. An improper coolant mixture can result in serious malfunction or engine damage.
- The engine in your vehicle has aluminum engine parts and must be protected by an ethylene-glycol-based coolant to prevent corrosion and freezing.
- DO NOT USE alcohol or methanol coolant or mix them with the specified coolant.
- Do not use a solution that contains more than 60% antifreeze or less than 35% antifreeze, which would reduce the effectiveness of the solution.

For mixture percentage, refer to the following table.

Ambient Temperature	Mixture Percentage (volume)	
	Antifreeze	Water
-15°C (5°F)	35	65
-25°C (-13°F)	40	60
-35°C (-31°F)	50	50
-45°C (-49°F)	60	40

i Information

If in doubt about the mix ratio, a 50% water and 50% antifreeze mix is the easiest to mix together as it will be the same quantity of each. It is suitable to use for most temperature ranges of -35°C (-31°F) and higher.

Changing the engine coolant

We recommend that the coolant be replaced by an authorized HYUNDAI dealer.

NOTICE

Put a thick cloth or fabric around the radiator cap before refilling the coolant in order to prevent the coolant from overflowing into engine parts such as generator.

⚠ WARNING

- Do not use engine coolant or antifreeze in the washer fluid reservoir.
- Engine coolant can severely obscure visibility when sprayed on the windshield and may cause loss of vehicle control or damage to paint and body trim.

BRAKE/CLUTCH FLUID (IF EQUIPPED)

Checking the brake/clutch fluid level

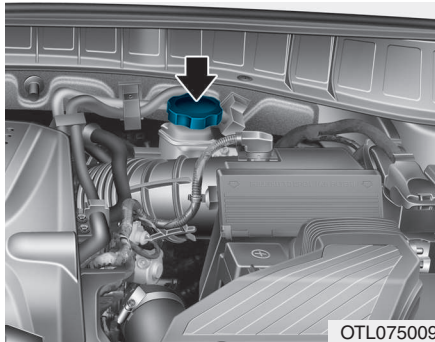

Check the fluid level in the reservoir periodically. The fluid level should be between MAX and MIN marks on the side of the reservoir.

Before removing the reservoir cap and adding brake/clutch fluid, clean the area around the reservoir cap thoroughly to prevent brake/clutch fluid contamination.

If the level is low, add fluid to the MAX level. The level will fall with accumulated mileage. This is a normal condition associated with the wear of the brake linings.

If the fluid level is excessively low, we recommend that the system be checked by an authorized HYUNDAI dealer.

i Information

Use only the specified brake/clutch fluid. (Refer to “Recommended lubricants and capacities” in chapter 8.)

⚠ WARNING

In the event the brake/clutch system requires frequent additions of fluid, we recommend that the system be inspected by an authorized HYUNDAI dealer.

i Information

Before removing the brake/clutch filler cap, read the warning on the cap.

i Information

Clean filler cap before removing. Use only DOT3 or DOT4 brake/clutch fluid from a sealed container.

⚠ WARNING

When changing and adding brake/clutch fluid, handle it carefully. Do not let it come in contact with your eyes. If brake/ clutch fluid should come in contact with your eyes, immediately flush them with a large quantity of fresh tap water. Have your eyes examined by a doctor as soon as possible.

NOTICE

Do not allow brake/clutch fluid to contact the vehicle's body paint, as paint damage will result.

Brake/clutch fluid, which has been exposed to open air for an extended time should never be used as its quality cannot be guaranteed. It should be disposed of properly. Don't put in the wrong kind of fluid.

A few drops of mineral-based oil, such as engine oil, in your brake/clutch system can damage brake/clutch system parts.

WASHER FLUID

Checking the washer fluid level

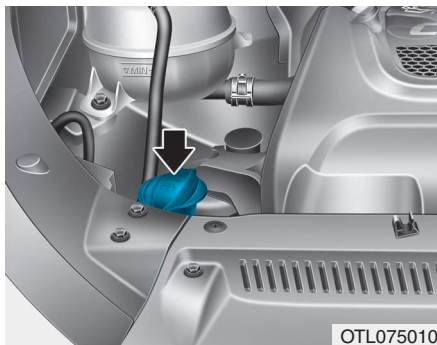

The reservoir is translucent so that you can check the level with a quick visual inspection.

Check the fluid level in the washer fluid reservoir and add fluid if necessary.

Plain water may be used if washer fluid is not available.

However, use washer solvent with antifreeze characteristics in cold climates to prevent freezing.

NOTICE

Do not use engine coolant or antifreeze in the washer fluid reservoir.

⚠ WARNING

- Engine coolant can severely obscure visibility when sprayed on the windshield and may cause loss of vehicle control or damage to paint and body trim.
- Windshield Washer fluid agents contain some amounts of alcohol and can be flammable under certain circumstances. Do not allow sparks or flame to contact the washer fluid or the washer fluid reservoir. Damage to the vehicle or occupants could occur.
- Windshield washer fluid is poisonous to humans and animals. Do not drink and avoid contacting windshield washer fluid. Serious injury or death could occur.

PARKING BRAKE

Checking the parking brake

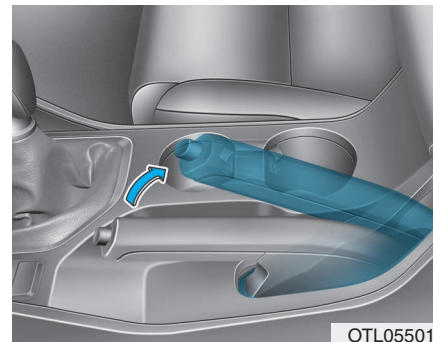

Check the stroke of the parking brake by counting the number of “clicks” heard while fully applying it from the released position. Also, the parking brake alone should securely hold the vehicle on a fairly steep grade. If the stroke is more or less than specified, we recommend that the system be serviced by an authorized HYUNDAI dealer.

Stroke : 5~6 “clicks” at a force of 20 kg (44 lbs, 196 N).

FUEL FILTER (FOR DIESEL)

Draining water from fuel filter

The fuel filter in the diesel engine operates the critical function of separating water from the fuels and accumulating the water in its bottom.

When enough water is accumulated inside the fuel filter, the warning light illuminates with the ignition switch in the ON position.

In this case, we recommend you to have the system checked by an authorized HYUNDAI dealer.

NOTICE

When the accumulated water is not drained at a proper timing, water may permeate in the fuel filter, damaging the major vehicle components, such as the fuel system.

Fuel filter cartridge replacement

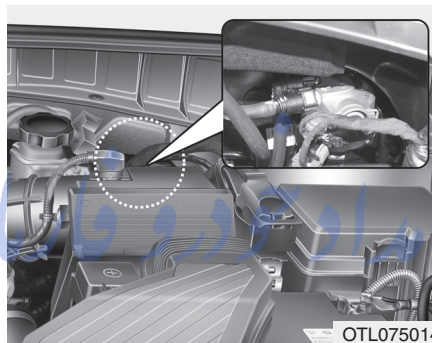

Information

تلفن شبانه روزی: ۰۲۱-۸۸۶۲۰۸۵
When replacing the fuel filter cartridge, we recommend that you use parts for replacement from an authorized HYUNDAI dealer.

AIR CLEANER

Filter replacement

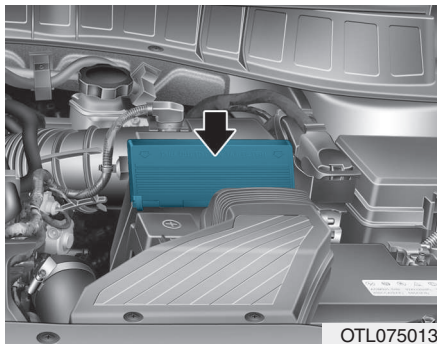

The air cleaner filter can be cleaned for inspection using compressed air.

Do not attempt to wash or to rinse it, as water will damage the filter.

If soiled, the air cleaner filter must be replaced.

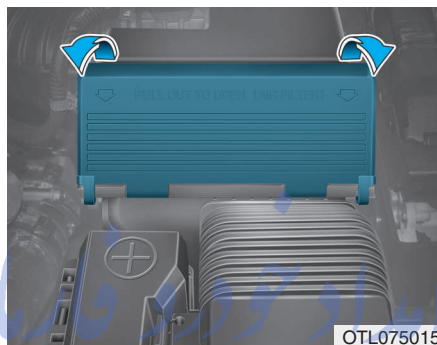

1. Pull down the air cleaner filter cover.
2. Wipe the inside of the air cleaner.

تلفن شبانه روزی: ۰۲۱-۸۸۸۶۲۰۸۵

FarmaSOS.com

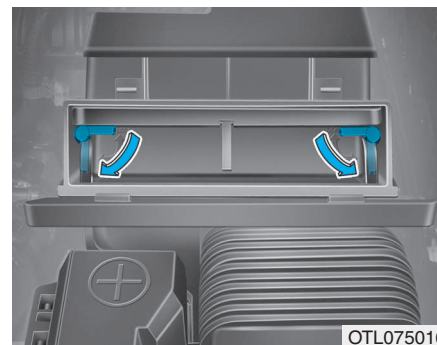

3. Pull down the lever to the UNLOCK position.

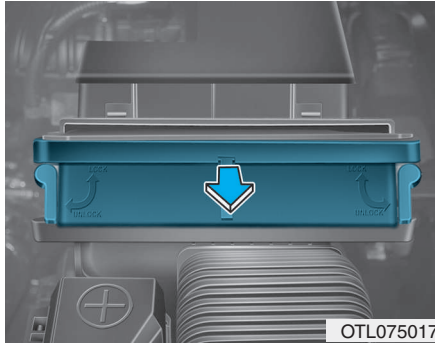

4. Replace the air cleaner filter.

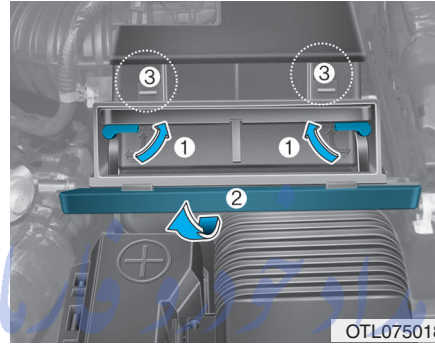

5. Pull up the lever (1) to the LOCK position.

6. Rise up the cover (2) until the hooks on the cover are securely fastened into the latches (3).

7. Check if the cover is firmly installed.

FarmaSOS.com

i Information

If the vehicle is operated in extremely dusty or sandy areas, replace the element more often than the usual recommended intervals (refer to “Maintenance Under Severe Usage Conditions” in this chapter).

NOTICE

- Do not drive with the air cleaner filter removed. This will result in excessive engine wear.
- When removing the air cleaner filter, be careful that dust or dirt does not enter the air intake, or damage may result.
- Use HYUNDAI genuine parts, use of non-genuine parts could damage the air flow sensor.

CLIMATE CONTROL AIR FILTER

Filter inspection

If the vehicle is operated in the severely air-polluted cities or on dusty rough roads for a long period, it should be inspected more frequently and replaced earlier. When you, the owner, replace the climate control air filter, replace it performing the following procedure, and be careful to avoid damaging other components.

Replace the filter according to the Maintenance Schedule.

NOTICE

Install a new climate control air filter in the correct direction with the arrow symbol(↓) facing downwards. Otherwise, the climate control effects may decrease, possibly with a noise.

Filter replacement

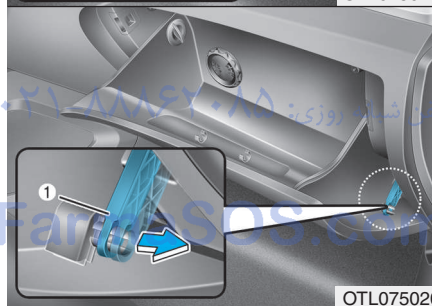
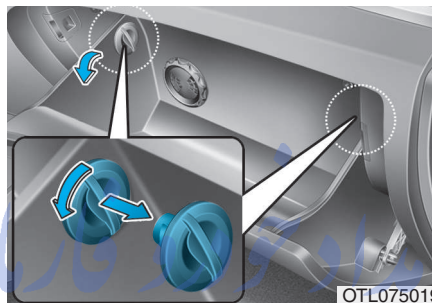

1. With the glove box open, remove the stoppers on both sides.
2. Remove the support strap (1).

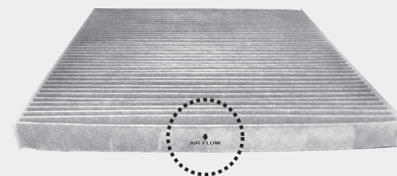
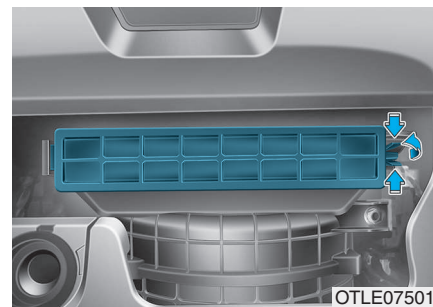

3. Remove the climate control air filter case while pressing the lock on the right side of the cover.
4. Replace the climate control air filter.
5. Reassemble in the reverse order of disassembly.

WIPER BLADES

Blade inspection

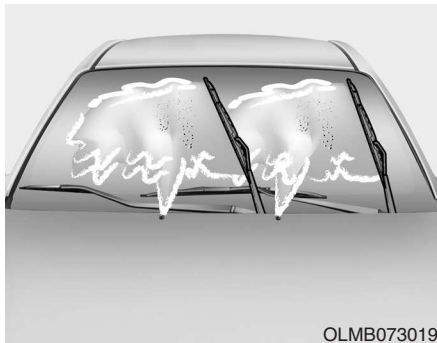

OLMB073019

i Information

Commercial hot waxes applied by automatic car washes have been known to make the windshield difficult to clean.

Contamination of either the windshield or the wiper blades with foreign matter can reduce the effectiveness of the windshield wipers.

Common sources of contamination are insects, tree sap, and hot wax treatments used by some commercial car washes. If the blades are not wiping properly, clean both the window and the blades with a good cleaner or mild detergent, and rinse thoroughly with clean water.

NOTICE

To prevent damage to the wiper blades, do not use gasoline, kerosene, paint thinner, or other solvents on or near them.

i Information

Wiper blades are consumable item and normal wear of the wipers may not be covered by your vehicle warranty.

Blade replacement

When the wipers no longer clean adequately, the blades may be worn or cracked, and require replacement.

NOTICE

To prevent damage to the wiper arms or other components, do not attempt to move the wipers manually.

NOTICE

The use of a non-specified wiper blade could result in wiper malfunction and failure.



CAUTION

Do not allow the wiper arm to fall against the windshield, since it may chip or crack the windshield.

Front windshield wiper blade

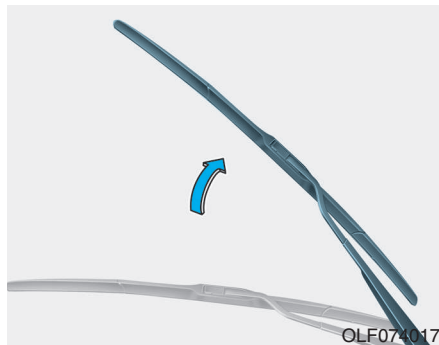

1. Raise the wiper arm.

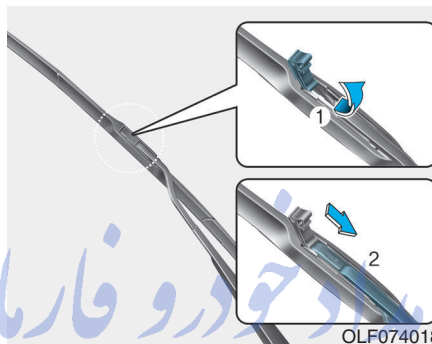

2. Lift up the wiper blade clip. Then pull down the blade assembly and remove it.

تلفن شبانه روزی: ۰۲۱-۸۸۸۶۲۰۸۵

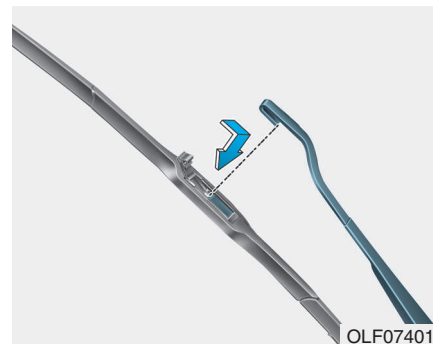

3. Install the new blade assembly in the reverse order of removal.

4. Return the wiper arm on the windshield.

FarmaSOS.com

Rear window wiper blade

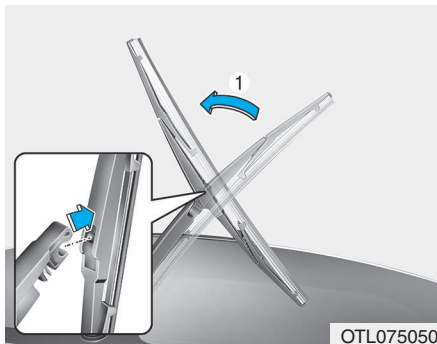

1. Raise the wiper arm and pull out the wiper blade assembly.

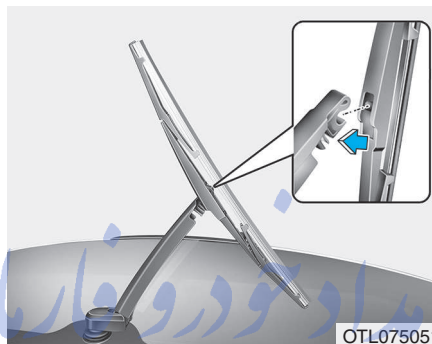

2. Install the new blade assembly by inserting the center part into the slot in the wiper arm until it clicks into place.
3. Make sure the blade assembly is installed firmly by trying to pull it slightly.

To prevent damage to the wiper arms or other components, we recommend that the wiper blade be replaced by an authorized HYUNDAI dealer.

BATTERY

For best battery service

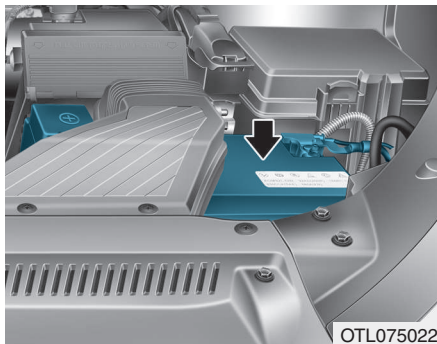

OTL075022

- Keep the battery securely mounted.
- Keep the battery top clean and dry.
- Keep the terminals and connections clean, tight, and coated with petroleum jelly or terminal grease.
- Rinse any spilled electrolyte from the battery immediately with a solution of water and baking soda.
- If the vehicle is not going to be used for an extended time, disconnect the battery cables.

i Information

The battery, which is originally installed in your vehicle, is maintenance free. However, your vehicle is equipped with a battery marked with LOWER and UPPER on the side, you should check the electrolyte level. The electrolyte level should be between the LOWER and the UPPER. When the electrolyte level is low, add distilled (or de-mineralized) water. (Never add sulfuric acids or other electrolyte). Be careful not to spill distilled (or de-mineralized) water over the battery surface or other adjacent components. Also, do not overfill the battery cells. If not, it may corrode the battery or other components. Finally, securely close the cell cap. However, we recommend you to contact an authorized HYUNDAI dealer for better battery service.

⚠ WARNING

To prevent **SERIOUS INJURY** or **DEATH** to you or bystanders, always follow these precautions when working near or handling the battery:



Always read and follow instructions carefully when handling a battery.



Wear eye protection designed to protect the eyes from acid splashes.



Keep all flames, sparks, or smoking materials away from the battery.



Hydrogen is always present in battery cells, is highly combustible, and may explode if ignited.



Keep batteries out of reach of children.

(Continued)

(Continued)



Batteries contain sulfuric acid which is highly corrosive. Do not allow acid to contact your eyes, skin or clothing.

If acid gets into your eyes, flush your eyes with clean water for at least 15 minutes and get immediate medical attention. If acid gets on your skin, thoroughly wash the area. If you feel pain or a burning sensation, get medical attention immediately.

- When lifting a plastic-cased battery, excessive pressure on the case may cause battery acid to leak. Lift with a battery carrier or with your hands on opposite corners.
- Do not attempt to jump start your vehicle if your battery is frozen.

(Continued)

(Continued)

- NEVER attempt to recharge the battery when the vehicle's battery cables are connected to the battery.
- The electrical ignition system works with high voltage. NEVER touch these components with the engine running or when the Engine Start/Stop button is in the ON position.
- Do not allow the (+) and (-) jumper cables to touch. It may cause sparks.
- The battery may rupture or explode when you jump start with a low or frozen battery.

Information



An inappropriately disposed battery can be harmful to the environment and human health. Dispose the battery according to your local law(s) or regulations.

NOTICE

If you connect unauthorized electronic devices to the battery, the battery may be discharged. Never use unauthorized devices.

FarmaSOS.com

Battery capacity label

■ Example



OLMB073072

The actual battery label in the vehicle may differ from the illustration.

1. CMF60L-BCI : The HYUNDAI model name of battery
2. 12V : The nominal voltage
3. 60Ah(20HR) : The nominal capacity (in Ampere hours)
4. 92RC : The nominal reserve capacity (in min.)
5. 550CCA : The cold-test current in amperes by SAE
6. 440A : The cold-test current in amperes by EN

⚠ CAUTION

AGM battery (if equipped)

- **Absorbent Glass Matt (AGM) batteries are maintenance-free and we recommend that the AGM battery be serviced by an authorized HYUNDAI dealer. For charging your AGM battery, use only fully automatic battery chargers that are specially developed for AGM batteries.**
- **When replacing the AGM battery, we recommend that you use parts for replacement from an authorized HYUNDAI dealer.**
- **Do not open or remove the cap on top of the battery. This may cause leaks of internal electrolyte that could result in severe injury.**

Battery recharging

Your vehicle has a maintenance-free, calcium-based battery.

- If the battery becomes discharged in a short time (because, for example, the headlights or interior lights were left on while the vehicle was not in use), recharge it by slow charging (trickle) for 10 hours.
- If the battery gradually discharges because of high electric load while the vehicle is being used, recharge it at 20-30A for two hours.

WARNING

When recharging the battery, observe the following precautions:

- Before performing maintenance or recharging the battery, turn off all accessories and stop the engine.
- Do not allow cigarettes, sparks, or flame near the battery.
- Wear eye protection when checking the battery during charging.
- The battery must be removed from the vehicle and placed in an area with good ventilation.
- Watch the battery during charging, and stop or reduce the charging rate if the battery cells begin gassing (boiling) violently or if the temperature of the electrolyte of any cell exceeds 49°C (120°F).

(Continued)

(Continued)

- The negative battery cable must be removed first and installed last when the battery is disconnected.
- Disconnect the battery charger in the following order.
 1. Turn off the battery charger main switch.
 2. Unhook the negative clamp from the negative battery terminal.
 3. Unhook the positive clamp from the positive battery terminal.

Reset items

Items should be reset after the battery has been discharged or the battery has been disconnected.

- Auto up/down window (See chapter 3)
- Sunroof (See chapter 3)
- Trip computer (See chapter 3)
- Climate control system (See chapter 3)

FarmaSOS.com

TIRES AND WHEELS

Tire care

For proper maintenance, safety, and maximum fuel economy, you must always maintain recommended tire inflation pressures and stay within the load limits and weight distribution recommended for your vehicle.

Recommended cold tire inflation pressures

All tire pressures (including the spare) should be checked when the tires are cold. "Cold Tires" means the vehicle has not been driven for at least three hours or driven less than 1.6 km (1 mile).

Recommended pressures must be maintained for the best ride, top vehicle handling, and minimum tire wear.

For recommended inflation pressure refer to "Tire and wheels" in chapter 8.

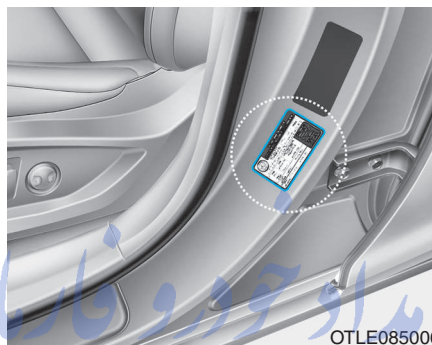

All specifications (sizes and pressures) can be found on a label attached to the vehicle.

تلفن شبانه روزی: ۰۸۵-۸۸۸۶۰۰۲۱

FarmaSOS.com

WARNING

Tire underinflation

Severe underinflation (70 kPa (10 psi) or more) can lead to severe heat build-up, causing blowouts, tread separation and other tire failures that can result in the loss of vehicle control leading to severe injury or death. This risk is much higher on hot days and when driving for long periods at high speeds.

⚠ CAUTION

- Underinflation also results in excessive wear, poor handling and reduced fuel economy. Wheel deformation also is possible. Keep your tire pressures at the proper levels. If a tire frequently needs refilling, we recommend that the tire be checked by an authorized HYUNDAI dealer.
- Overinflation produces a harsh ride, excessive wear at the center of the tire tread, and a greater possibility of damage from road hazards.

⚠ CAUTION

- Warm tires normally exceed recommended cold tire pressures by 28 to 41 kPa (4 to 6 psi). Do not release air from warm tires to adjust the pressure or the tires will be under-inflated.
- Be sure to reinstall the tire inflation valve caps. Without the valve cap, dirt or moisture could get into the valve core and cause air leakage. If a valve cap is missing, install a new one as soon as possible.

⚠ WARNING

Tire inflation

Overinflation or underinflation can reduce tire life, adversely affect vehicle handling, and lead to sudden tire failure. This could result in loss of vehicle control and potential injury.

⚠ CAUTION

Tire pressure

Always observe the following:

- Check tire pressure when the tires are cold. (After vehicle has been parked for at least three hours or hasn't been driven more than 1.6 km (1 mile) since startup.)
- Check the pressure of your spare tire each time you check the pressure of other tires.
- Never overload your vehicle. Be careful not to overload a vehicle luggage rack if your vehicle is equipped with one.
- Worn, old tires can cause accidents. If your tread is badly worn, or if your tires have been damaged, replace them.

Checking tire inflation pressure

Check your tires once a month or more.

Also, check the tire pressure of the spare tire.

How to check

Use a good quality gage to check tire pressure. You can not tell if your tires are properly inflated simply by looking at them. Radial tires may look properly inflated even when they're underinflated.

Check the tire's inflation pressure when the tires are cold. - "Cold" means your vehicle has been sitting for at least three hours or driven no more than 1.6 km (1 mile).

Remove the valve cap from the tire valve stem. Press the tire gage firmly onto the valve to get a pressure measurement. If the cold tire inflation pressure matches the recommended pressure on the tire and loading information label, no further adjustment is necessary. If the pressure is low, add air until you reach the recommended amount.

If you overfill the tire, release air by pushing on the metal stem in the center of the tire valve. Recheck the tire pressure with the tire gage. Be sure to put the valve caps back on the valve stems. They help prevent leaks by keeping out dirt and moisture.

FarmaSOS.com

WARNING

- **Inspect your tires frequently for proper inflation as well as wear and damage. Always use a tire pressure gauge.**
- **Tires with too much or too little pressure wear unevenly causing poor handling, loss of vehicle control, and sudden tire failure leading to accidents, injuries, and even death. The recommended cold tire pressure for your vehicle can be found in this manual and on the tire label located on the driver's side center pillar.**
- **Worn tires can cause accidents. Replace tires that are worn, show uneven wear, or are damaged.**
- **Remember to check the pressure of your spare tire.**
HYUNDAI recommends that you check the spare every time you check the pressure of the other tires on your vehicle.

Tire rotation

To equalize tread wear, it is recommended that the tires be rotated every 12,000 km (7,500 miles) or sooner if irregular wear develops.

During rotation, check the tires for correct balance.

When rotating tires, check for uneven wear and damage. Abnormal wear is usually caused by incorrect tire pressure, improper wheel alignment, out-of-balance wheels, severe braking or severe cornering. Look for bumps or bulges in the tread or side of tire. Replace the tire if you find either of these conditions. Replace the tire if fabric or cord is visible. After rotation, be sure to bring the front and rear tire pressures to specification and check lug nut tightness.

Refer to "Tire and wheels" in chapter 8.

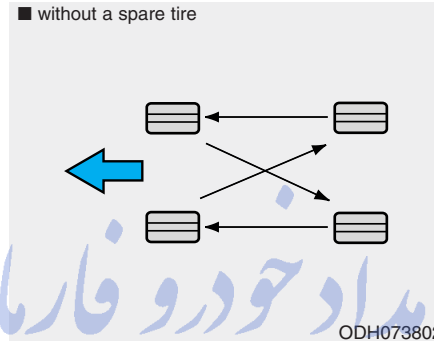

Disc brake pads should be inspected for wear whenever tires are rotated.

تلفن شبانه روزی: ۰۲۱-۸۸۶۲۰۸۵

FarmaSOS.com

Information

The outside and inside of the unsymmetrical tire is distinguishable. When installing an unsymmetrical tire, be sure to install the side marked "outside" face the outside. If the side marked "inside" is installed on the outside, it will have a bad effect on vehicle performance.

WARNING

- Do not use the compact spare tire for tire rotation.
- Do not mix bias ply and radial ply tires under any circumstances. This may cause unusual handling characteristics that could result in death, severe injury, or property damage.

Wheel alignment and tire balance

The wheels on your vehicle were aligned and balanced carefully at the factory to give you the longest tire life and best overall performance.

In most cases, you will not need to have your wheels aligned again. However, if you notice unusual tire wear or your vehicle pulling one way or the other, the alignment may need to be reset.

If you notice your vehicle vibrating when driving on a smooth road, your wheels may need to be rebalanced.

NOTICE

Improper wheel weights can damage your vehicle's aluminum wheels. Use only approved wheel weights.

Tire replacement

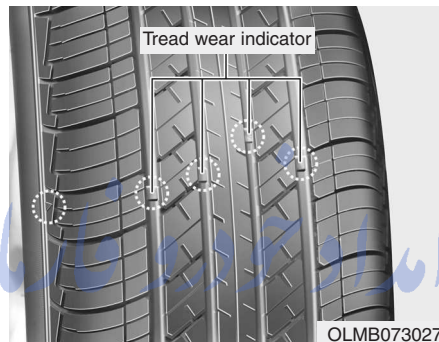

If the tire is worn evenly, a tread wear indicator will appear as a solid band across the tread. This shows there is less than 1.6 mm (1/16 in.) of tread left on the tire. Replace the tire when this happens.

Do not wait for the band to appear across the entire tread before replacing the tire.

⚠ WARNING

When replacing the tires, recheck and tighten the wheel nuts after driving about 1,000 km (620 miles). If the steering wheel shakes or the vehicle vibrates while driving, the tire is out of balance. Align the tire balance. If the problem is not solved, we recommend that you contact an authorized HYUNDAI dealer.

WARNING

- Driving on worn-out tires is very hazardous and will reduce braking effectiveness, steering accuracy, and traction.
- Your vehicle is equipped with tires designed to provide for safe ride and handling capability. Do not use a size and type of tire and wheel that is different from the one that is originally installed on your vehicle. It can affect the safety and performance of your vehicle, which could lead to handling failure or rollover and serious injury. When replacing the tires, be sure to equip all four tires with the tire and wheel of the same size, type, tread, brand and load-carrying capacity.

(Continued)

(Continued)

- The use of any other tire size or type may seriously affect ride, handling, ground clearance, stopping distance, body to tire clearance, snow tire clearance, and speedometer reliability.
- When replacing tires (or wheels), it is recommended to replace the two front or two rear tires (or wheels) as a pair. Replacing just one tire can seriously affect your vehicle's handling.
- The ABS works by comparing the speed of the wheels. Tire size can affect wheel speed. When replacing tires, all 4 tires must use the same size originally supplied with the vehicle. Using tires of a different size can cause the ABS (Anti-lock Brake System) and ESC (Electronic Stability Control) (if equipped) to work irregularly.

Compact spare tire replacement (if equipped)

A compact spare tire has a shorter tread life than a regular size tire. Replace it when you can see the tread wear indicator bars on the tire. The replacement compact spare tire should be the same size and design tire as the one provided with your new vehicle and should be mounted on the same compact spare tire wheel. The compact spare tire is not designed to be mounted on a regular size wheel, and the compact spare tire wheel is not designed for mounting a regular size tire.

Wheel replacement

When replacing the metal wheels for any reason, make sure the new wheels are equivalent to the original factory units in diameter, rim width and offset.

WARNING

A wheel that is not the correct size may adversely affect wheel and bearing life, braking and stopping abilities, handling characteristics, ground clearance, body-to-tire clearance, snow chain clearance, speedometer and odometer calibration, head-lamp aim and bumper height.

Tire traction

Tire traction can be reduced if you drive on worn tires, tires that are improperly inflated or on slippery road surfaces. Tires should be replaced when tread wear indicators appear. To reduce the possibility of losing control, slow down whenever there is rain, snow or ice on the road.

Tire maintenance

In addition to proper inflation, correct wheel alignment helps to decrease tire wear. If you find a tire is worn unevenly, have your dealer check the wheel alignment.

When you have new tires installed, make sure they are balanced. This will increase vehicle ride comfort and tire life. Additionally, a tire should always be rebalanced if it is removed from the wheel.

Tire sidewall labeling

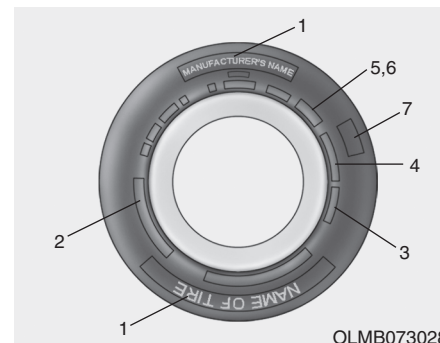

This information identifies and describes the fundamental characteristics of the tire and also provides the tire identification number (TIN) for safety standard certification. The TIN can be used to identify the tire in case of a recall.

1. Manufacturer or brand name

Manufacturer or Brand name is shown.

2. Tire size designation

A tire's sidewall is marked with a tire size designation. You will need this information when selecting replacement tires for your car. The following explains what the letters and numbers in the tire size designation mean.

Example tire size designation:

(These numbers are provided as an example only; your tire size designator could vary depending on your vehicle.)

215/70R16 100H

215 - Tire width in millimeters.

70 - Aspect ratio. The tire's section height as a percentage of its width.

R - Tire construction code (Radial).

16 - Rim diameter in inches.

100 - Load Index, a numerical code associated with the maximum load the tire can carry.

H - Speed Rating Symbol. See the speed rating chart in this section for additional information.

تلفن شبانه روزی: ۰۲۱-۸۸۸۶۲۰۸۵

FarmaSOS.com

Wheel size designation

Wheels are also marked with important information that you need if you ever have to replace one. The following explains what the letters and numbers in the wheel size designation mean.

Example wheel size designation:

6.5JX16

6.5 - Rim width in inches.

J - Rim contour designation.

16 - Rim diameter in inches.

Tire speed ratings

The chart below lists many of the different speed ratings currently being used for passenger car tires. The speed rating is part of the tire size designation on the sidewall of the tire. This symbol corresponds to that tire's designed maximum safe operating speed.

Speed Rating Symbol	Maximum Speed
S	180 km/h (112 mph)
T	190 km/h (118 mph)
H	210 km/h (130 mph)
V	240 km/h (149 mph)
W	270 km/h (168 mph)
Y	300 km/h (186 mph)

3. Checking tire life (TIN : Tire Identification Number)

Any tires that are over 6 years old, based on the manufacturing date, tire strength and performance, decline with age naturally (even unused spare tires). Therefore, the tires (including the spare tire) should be replaced by new ones. You can find the manufacturing date on the tire sidewall (possibly on the inside of the wheel), displaying the DOT Code. The DOT Code is a series of numbers on a tire consisting of numbers and English letters. The manufacturing date is designated by the last four digits (characters) of the DOT code.

DOT : XXXX XXXX 0000

The front part of the DOT means a plant code number, tire size and tread pattern and the last four numbers indicate week and year manufactured.

For example:

DOT XXXX XXXX 1616 represents that the tire was produced in the 16th week of 2016.

WARNING

Tire age

Tires degrade over time, even when they are not being used. Regardless of the remaining tread, it is recommended that tires generally be replaced after six (6) years of normal service. Heat caused by hot climates or frequent high loading conditions can accelerate the aging process. Failure to follow this Warning can result in sudden tire failure, which could lead to a loss of control and an accident involving serious injury or death.

4. Tire ply composition and material

The number of layers or plies of rubber-coated fabric are in the tire. Tire manufacturers also must indicate the materials in the tire, which include steel, nylon, polyester, and others. The letter "R" means radial ply construction; the letter "D" means diagonal or bias ply construction; and the letter "B" means belted-bias ply construction.

5. Maximum permissible inflation pressure

This number is the greatest amount of air pressure that should be put in the tire. Do not exceed the maximum permissible inflation pressure. Refer to the Tire and Loading Information label for recommended inflation pressure.

6. Maximum load rating

This number indicates the maximum load in kilograms and pounds that can be carried by the tire. When replacing the tires on the vehicle, always use a tire that has the same load rating as the factory installed tire.

7. Uniform tire quality grading

Quality grades can be found where applicable on the tire sidewall between tread shoulder and maximum section width.

For example: تلفن شبانه روزی: ۰۸۵ ۶۲۰۸۵۰۸۵

TREADWEAR 200

TRACTION AA

TEMPERATURE A

Tread wear

The tread wear grade is a comparative rating based on the wear rate of the tire when tested under controlled conditions on a specified government test course. For example, a tire graded 150 would wear one-and-a-half times ($1\frac{1}{2}$) as well on the government course as a tire graded 100.

The relative performance of tires depends upon the actual conditions of their use, however, and may depart significantly from the norm because of variations in driving habits, service practices and differences in road characteristics and climate.

These grades are molded on the side-walls of passenger vehicle tires. The tires available as standard or optional equipment on your vehicles may vary with respect to grade.

Traction - AA, A, B & C

The traction grades, from highest to lowest, are AA, A, B and C. Those grades represent the tires ability to stop on wet pavement as measured under controlled conditions on specified government test surfaces of asphalt and concrete. A tire marked C may have poor traction performance.

WARNING

The traction grade assigned to this tire is based on straight-ahead braking traction tests, and does not include acceleration, cornering, hydroplaning, or peak traction characteristics.

Temperature -A, B & C

The temperature grades are A (the highest), B and C representing the tire's resistance to the generation of heat and its ability to dissipate heat when tested under controlled conditions on a specified indoor laboratory test wheel.

Sustained high temperature can cause the material of the tire to degenerate and reduce tire life, and excessive temperature can lead to sudden tire failure. Grades B and A represent higher levels of performance on the laboratory test wheel than the minimum required by the law.

WARNING

Tire temperature

The temperature grade for this tire is established for a tire that is properly inflated and not overloaded. Excessive speed, under-inflation, or excessive loading, either separately or in combination, can cause heat build-up and possible sudden tire failure. This can cause loss of vehicle control and serious injury or death.

FarmaSOS.com

Low aspect ratio tire (if equipped)

The low aspect ratio tires, of which aspect ratio is below 50, are equipped with for the sporty look.

Riding with high aspect ratio tires may be uncomfortable with unpleasant noises, because the low aspect ratio tires are optimized for handling and braking.

NOTICE

The sidewall of the low aspect ratio tire is thinner than the high aspect ratio tire. Thus, the wheel and the tire may be easily damaged. Thus, follow the below instructions.

- Cautiously drive the vehicle on a rough road or off the road. Otherwise, the tires and wheels may be damaged. After driving those areas, inspect the tires and wheels.
- Slowly drive the vehicle to pass over a pothole, speed bump, manhole, or curb stone. Otherwise, the tires and wheels may be damaged.
- Upon having an impact on the tire, we recommend you to have the tires inspected by an authorized HYUNDAI dealer.
- Inspect the tires every 3,000 km to prevent damage

NOTICE

- It is difficult to recognize tire damage only with eyes. However, we recommend you to have the tire checked or replaced upon detecting even the slightest tire damage. The tire damage may leak air from the tire.
- Tire damage, caused by driving on a rough road, pothole, manhole or curb stone, or off the road, is not covered by the manufacturer's warranty.
- For further information about the tire, refer to the label on the tire sidewall.

FUSES

■ Blade type



Normal



Blown

■ Cartridge type



Normal



Blown

■ Multi fuse

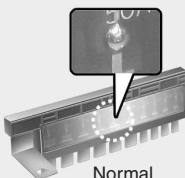

Normal

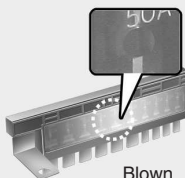

Blown

■ Battery fuse terminal

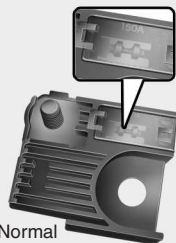

Normal



Blown

OLF074075

A vehicle's electrical system is protected from electrical overload damage by fuses.

This vehicle has 2 (or 3) fuse panels, one located in the driver's side panel bolster, the other in the engine compartment near the battery.

If any of your vehicle's lights, accessories, or controls do not work, check the appropriate circuit fuse. If a fuse has blown, the element inside the fuse will be melted.

If the electrical system does not work, first check the driver's side panel. Before replacing a blown fuse, turn the engine and all switches off, and then disconnect the negative battery cable. Always replace a blown fuse with one of the same rating.

If the replacement fuse blows, this indicates an electrical problem. Avoid using the system involved and immediately consult an authorized HYUNDAI dealer.

i Information

Four kinds of fuses are used : blade type for lower amperage rating, cartridge type/Multi fuse/Battery fuse terminal for higher amperage ratings.

WARNING

Fuse replacement

- Never replace a fuse with anything but another fuse of the same rating.
- A higher capacity fuse could cause damage and possibly a fire.
- Never install a wire or aluminum foil instead of the proper fuse - even as a temporary repair. It may cause extensive wiring damage and a possible fire.

NOTICE

Do not use a screwdriver or any other metal object to remove fuses because it may cause a short circuit and damage the system.

امداد خودرو فارما

تلفن شبانه روزی: ۰۸۵-۸۸۸۶۲۰۲۱

FarmaSOS.com

NOTICE

- When replacing a blown fuse or relay with a new one, make sure the new fuse or relay fits tightly into the clips. The incomplete fastening fuse or relay may cause the vehicle wiring and electric systems damage and a possible fire.
- Do not remove fuses, relays and terminals fastened with bolts or nuts. The fuses, relays and terminals may be fastened incompletely, and it may cause a possible fire. If fuses, relays and terminals fastened with bolts or nuts are blown, we recommend that you consult an authorized HYUNDAI dealer.
- Do not input any other objects except fuses or relays into fuse/relay terminals such as a driver or wiring. It may cause contact failure and system malfunction.

Inner panel fuse replacement



1. Turn the engine and all other switches off.
2. Open the fuse panel cover.

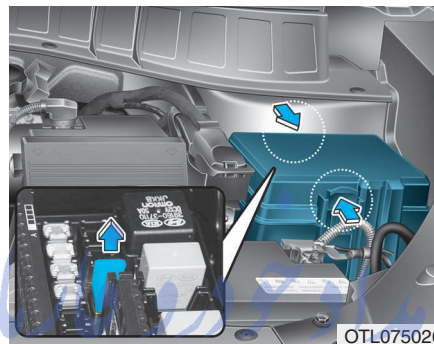

3. Pull the suspected fuse straight out. Use the removal tool provided in the engine compartment fuse panel.
4. Check the removed fuse; replace it if it is blown.
5. Push in a new fuse of the same rating, and make sure it fits tightly in the clips.

If it fits loosely, we recommend that you consult an authorized HYUNDAI dealer.

i Information

If you do not have a spare, use a fuse of the same rating from a circuit you may not need for operating the vehicle, such as the cigar lighter fuse.

If the headlights or other electrical components do not work and the fuses are OK, check the fuse block in the engine compartment. If a fuse is blown, it must be replaced with the same rating.

Fuse switch

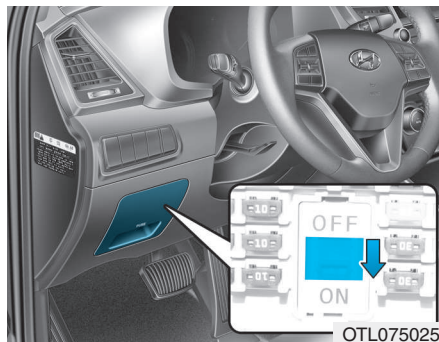

Always, place the fuse switch to the ON position.

If you move the switch to the OFF position, some items such as the audio system and digital clock must be reset and the smart key may not work properly.

i Information



If the fuse switch is OFF, the above message will appear.

NOTICE

- **Always place the fuse switch in the ON position while driving the vehicle.**
- **Place the fuse switch in the OFF position when the vehicle is parked more than a month to prevent battery discharge.**
- **Do not move the transportation fuse switch repeatedly. The fuse switch may be damaged.**

Engine compartment panel fuse replacement

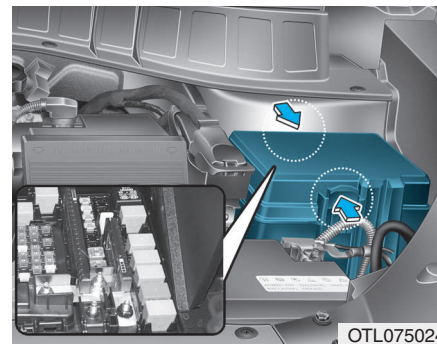

1. Turn the engine off and all other switches off.
2. Turn all the switches off.
3. Remove the fuse box cover by pressing the tab and pulling up.
4. Check the removed fuse; replace it if it is blown. To remove or insert the fuse, use the fuse puller in the engine compartment fuse panel.
5. Push in a new fuse of the same rating, and make sure it fits tightly in the clips. If it fits loosely, we recommend that you consult an authorized HYUNDAI dealer.

NOTICE

After checking the fuse box in the engine compartment, securely install the fuse box cover. If not, electrical failures may occur from water leaking in.

Main fuse

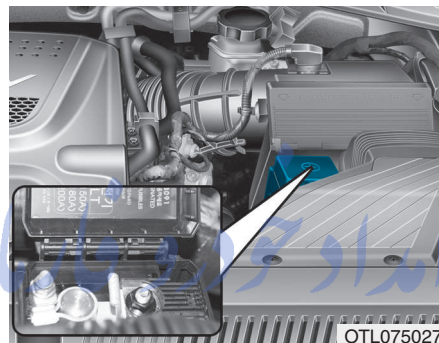

If an electrical system does not operate with no blown fuse in the engine room and inner fuse box, the main fuse inside the battery (+) cap may be blown.

The main fuse is heavily connected to many other parts. In this case, we recommend you to contact an authorized HYUNDAI dealer.

Multi fuse

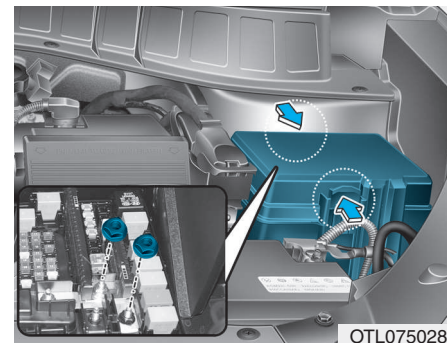

If the multi fuse is blown, it must be removed as follows:

1. Disconnect the negative battery cable.
2. Remove the nuts shown in the picture above.
3. Replace the fuse with a new one of the same rating.
4. Reinstall in the reverse order of removal.

i Information

If the multi fuse is blown, we recommend that you consult an authorized HYUNDAI dealer.

Fuse/Relay panel description

Driver's side fuse panel



Inside the fuse/relay box covers, you can find the fuse/relay label describing fuse/relay name and capacity.

i Information

Not all fuse panel descriptions in this manual may be applicable to your vehicle. It is accurate at the time of printing. When you inspect the fuse box on your vehicle, refer to the fuse box label.

USE THE DESIGNATED FUSE ONLY
 USE SOLO LOS FUSIBLES ESPECIFICADOS
 используйте только предназначенные предохранители
 استخدم الفيوز ذو القياس المناسب

1 7.5A MODULE	7 7.5A MODULE	1 15A SMART KEY	2 10A SMART KEY	7.5A 7.5A BRAKE SWITCH	15A 15A RR	10A 10A 10A	10A 10A 10A	6 10A MODULE	15A 15A RR	5 7.5A MODULE	4 7.5A MODULE	1 10A MODULE	3 10A MODULE	1 10A MODULE	2 20A POWER OUTLET
15A 15A 15A	15A 15A 15A	20A 20A 20A	15A 15A 15A	10A 10A 10A	10A 10A 10A	10A 10A 10A	10A 10A 10A	15A 15A 15A	15A 15A 15A	7.5A 7.5A 7.5A	7.5A 7.5A 7.5A	7.5A 7.5A 7.5A	7.5A 7.5A 7.5A	10A 10A 10A	15A 15A 15A
10A 10A 10A	10A 10A 10A	10A 10A 10A	10A 10A 10A	10A 10A 10A	10A 10A 10A	10A 10A 10A	10A 10A 10A	10A 10A 10A	10A 10A 10A	10A 10A 10A	10A 10A 10A	10A 10A 10A	10A 10A 10A	10A 10A 10A	10A 10A 10A
10A 10A 10A	10A 10A 10A	10A 10A 10A	10A 10A 10A	10A 10A 10A	10A 10A 10A	10A 10A 10A	10A 10A 10A	10A 10A 10A	10A 10A 10A	10A 10A 10A	10A 10A 10A	10A 10A 10A	10A 10A 10A	10A 10A 10A	10A 10A 10A











91941-D3641

FUSE SWITCH

تلفن شماره ۰۲۱-۸۶۹۰۰۰۰۰
 Фармас۰۰۰.com





OTL077031L

Driver's side fuse panel





Fuse Name	Symbol	Fuse Rating	Circuit Protected
A/CON 1		7.5A	A/C Control Module, Cluster Ionizer (Auto A/C), E/R Junction Block (RLY.4, 5, 13)
RR WIPER		15A	Rear Wiper Motor, ICM Relay Box (Rear Wiper Relay)
MODULE 6		10A	BCM, Smart Key Control Module
WASHER		15A	Multifunction Switch (Washer Switch)
MODULE 5		7.5A	Crash Pad Switch, Rear Parking Assist Buzzer, BCM, 4WD ECM, AEB Sensor, Steering Angle Sensor, Blind Spot Detection Radar LH/RH, Console Switch, Smart Parking Assist Control Module, Lane Keeping Assist Control Module
A/BAG		15A	SRS Control Module
MODULE 1		10A	BCM, A/V & Navigation Head Unit, MTS Module, AUDIO, Low DC-DC Converter, Smart Key Control Module, Power Outside Mirror Switch, PCB Block (Power Outlet Relay)
START		10A	ICM Relay Box (Burglar Alarm Relay), Transaxle Range Switch
MODULE 7		7.5A	Front Air Ventilation Seat Module, Front Seat Warmer Module, Rear Seat Warmer
HTD STRG		15A	BCM
MODULE 8		7.5A	Driver/Passenger Power Outside Mirror, Center Facia Switch, Driver/Passenger Smart Key Outside Handle, Key Solenoid, AEB Sensor

Fuse Name	Symbol	Fuse Rating	Circuit Protected
MODULE 4	⁴ MODULE	7.5A	Data Link Connector, A/C Control Module, ATM Shift Lever III., A/V & Navigation Head Unit, Electro Chromic Mirror, Head Lamp Leveling Device Actuator LH/RH, Auto Head Lamp Leveling Device Module, Crash Pad Switch, Front Air Ventilation Seat Module, Low DC-DC Converter, Front Seat Warmer Module, Rear Seat Warmer, MTS Module
A/BAG IND	^{IND} 	7.5A	Instrument Cluster, Center Facia Switch
MODULE 3	³ MODULE	10A	BCM, ATM Shift Lever, Stop Lamp Switch
SMART KEY 1	¹ SMART KEY	15A	Smart Key Control Module
4WD		20A	4WD ECM
T/GATE OPEN		10A	Tail Gate Relay
S/HEATER RR	^{RR} 	15A	Rear Seat Warmer
MDPS	 1	7.5A	MDPS Unit
SMART KEY 3	³ SMART KEY	7.5A	Immobilizer Module, Smart Key Control Module
CLUSTER	CLUSTER	7.5A	Instrument Cluster
SMART KEY 2	² SMART KEY	10A	Immobilizer Module, Smart Key Control Module, Start/Stop Button Switch
MULTI MEDIA	MULTI MEDIA	15A	AUDIO, A/V & Navigation Head Unit, Low DC-DC Converter

Driver's side fuse panel

Fuse Name	Symbol	Fuse Rating	Circuit Protected
INTERIOR LAMP		10A	Glove Box Lamp, Ignition Key Ill. & Door Warning Switch, Luggage Lamp, Front Vanity Lamp Switch LH/RH, Room Lamp, Overhead Console Lamp, Rear Personal Lamp LH/RH
DOOR LOCK		20A	Door Lock Relay, Door Unlock Relay, ICM Relay Box (Dead Lock Relay)
SUN ROOF 2	² 	20A	Panorama Sunroof
POWER OUTLET	POWER OUTLET	20A	Front Power Outlet & Cigarette Lighter
BRAKE SWITCH	BRAKE SWITCH	7.5A	Stop Lamp Switch, Smart Key Control Module
MEMORY 2	² MEMORY	10A	Auto Light & Photo Sensor, Data Link Connector, UIP Sensor A/C Control Module, Instrument Cluster, Electro Chromic Mirror, BCM, ICM Relay Box (Outside Mirror Folding/Unfolding Relay)
MEMORY 1	¹ MEMORY	10A	MTS Module
P/SEAT PASS	PASS 	30A	Passenger Seat Manual Switch
S/HEATER FRT	FRT 	20A	Front Air Ventilation Seat Control Module, Front Seat Warmer Control Module
SUN ROOF 1	¹ 	20A	Panorama Sunroof
MODULE 2	² MODULE	20A	PCB Block (Fuse - F44/F45/F49/F50/F52/F53)
RR FOG LAMP	RR 	10A	ICM Relay Box (Rear Fog Lamp Relay)
A/CON 2	² 	7.5A	A/C Control Module

Driver's side fuse panel

Fuse Name	Symbol	Fuse Rating	Circuit Protected
HEATED MIRROR		10A	A/C Control Module, Driver/Passenger Power Outside Mirror, ECM/PCM
P/SEAT DRV		30A	Driver Seat Manual Switch
SAFETY P/ WINDOW		25A	Driver Safety Power Window Module
P/ WINDOW RH		25A	Power Window Main Switch, Passenger Power Window Switch
P/ WINDOW LH		25A	Power Window Main Switch, Passenger Power Window Switch

تلفن شبانه روزی: ۰۲۱-۸۸۸۶۲۰۸۵

FarmaSOS.com

Engine compartment fuse panel

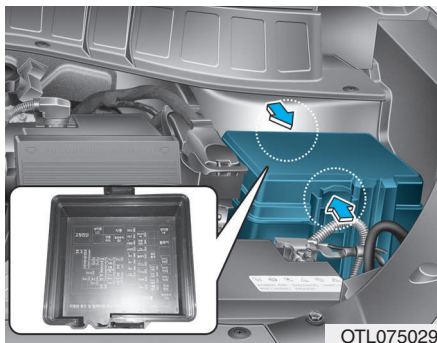

Inside the fuse/relay box covers, you can find the fuse/relay label describing fuse/relay name and capacity.

i Information

Not all fuse panel descriptions in this manual may be applicable to your vehicle. It is accurate at the time of printing. When you inspect the fuse box on your vehicle, refer to the fuse box label.

91941-D7042









BAR CODE

USE THE DESIGNATED FUSE AND RELAY ONLY
 USE SOLO LOS FUSIBLES Y RELEVADORES ESPECIFICADOS
 ИСПОЛЬЗУЙТЕ ТОЛЬКО ПРЕДНАЗНАЧЕННЫЕ ПРЕДОХРАНИТЕЛИ И РЕЛЕ
 استخدم القبول والمرحل المتناسبين





*(): NU, G-GDI, THETA
 **(): U II, R, G-T/GDI

OTLE077030

Engine compartment main fuse panel (Gasoline Engine)









	Fuse Name	Symbol	Fuse rating	Circuit Protected
MULTI FUSE	POWER STEERING1	¹ 	100A	MDPS Unit
	POWER STEERING2	² 	80A	MDPS Unit
	B+ 1	¹ 	60A	Smart Junction Block (IPS1, IPS2, IPS3, IPS4)
	B+ 2	² 	60A	Smart Junction Block (IPS1, IPS2, IPS3, IPS4)
	B+ 3	³ 	50A	Smart Junction Block (IPS5, IPS6, IPS7, IPS8, IPS9, Fuse - F19/F28/F35/F42)
	ABS 1	¹ 	40A	ESP Control Module, ABS Control Module, Multipurpose Check Connector
	ABS 2	² 	40A	ESP Control Module, ABS Control Module, Multipurpose Check Connector
	IG1	IG1	40A	W/O Smart Key : Ignition Switch With Smart Key : PCB Block (PDM (IG1) Relay, PDM (ACC) Relay)
IG2	IG2	30A	W/O Smart Key : Ignition Switch With Smart Key : PCB Block (PDM (IG2) Relay)	
FUSE	B+ 4	⁴ 	50A	Smart Junction Block (Fuse - F14/F21/F22/F31/F38/F45/F40/F46, Leak Current Autocut Device)
	COOLING FAN1	¹ 	(50A) [60A]	(G4NA/G4FD) : E/R Junction Block (RLY. 1, RLY. 9) (G4FJ) : E/R Junction Block (RLY. 1)
	E-CVVT1	E-CVVT1	20A	ECVVT RLY 1
	E-CVVT2	E-CVVT2	20A	ECVVT RLY 2

Engine compartment main fuse panel (Gasoline Engine)









	Fuse Name	Symbol	Fuse rating	Circuit Protected
FUSE	TCU 3	^{T3} 	40A	TCM
	TCU 4	^{T4} 	40A	TCM
	BLOWER		40A	E/R Junction Block (RLY. 13)
	POWER TAILGATE		40A	Power Tail Gate Module
	REAR HEATED	REAR HEATED	40A	E/R Junction Block (RLY. 2)
	COOLING FAN2	² 	40A	G4FJ : E/R Junction Block (RLY. 9)

FarmaSOS.com

Engine compartment main fuse panel (Diesel Engine)

	Fuse Name	Symbol	Fuse rating	Circuit Protected
MULTI FUSE	POWER STEERING1	¹ 	100A	MDPS Unit
	POWER STEERING2	² 	80A	MDPS Unit
	B+ 1	¹ 	60A	Smart Junction Block (IPS1, IPS2, IPS3, IPS4)
	B+ 2	² 	60A	Smart Junction Block (IPS5, IPS6, IPS7, IPS8, IPS9, Fuse - F19/F28/F35/F42)
	B+ 3	³ 	50A	Smart Junction Block (Fuse - F23/F32/F39/F40/F46, Power Window Relay)
	ABS 1	¹ 	40A	ESP Control Module, ABS Control Module, Multipurpose Check Connector
	ABS 2	² 	40A	ESP Control Module, ABS Control Module, Multipurpose Check Connector
	IG1	IG1	40A	W/O Smart Key : Ignition Switch With Smart Key : PCB Block (PDM (IG1) Relay, PDM (ACC) Relay)
	IG2	IG2	30A	W/O Smart Key : Ignition Switch With Smart Key : PCB Block (PDM (IG2) Relay)
	GLOW PLUG		50A	Glow Relay Unit
	PTC 1 HEATER	¹ PTC HEATER	50A	E/R Junction Block (RLY. 6)
	PTC 2 HEATER	² PTC HEATER	50A	E/R Junction Block (RLY. 5)
PTC 3 HEATER	³ PTC HEATER	50A	E/R Junction Block (RLY. 4)	

Engine compartment main fuse panel (Diesel Engine)

	Fuse Name	Symbol	Fuse rating	Circuit Protected
FUSE	B+ 4		50A	Smart Junction Block (Fuse - F14/F21/F22/F31/F38/F45/F40/F46, Leak Current Autocut Device)
	COOLING FAN1		(50A) [60A]	(G4NA/G4FD) : E/R Junction Block (RLY. 1, RLY. 9) (G4FJ) : E/R Junction Block (RLY. 1)
	TCU 3		40A	TCM
	TCU 4		40A	TCM
	BLOWER		40A	E/R Junction Block (RLY. 13)
	POWER TAILGATE		40A	Power Tail Gate Module
	FUEL HEATER		30A	E/R Junction Block (RLY. 10)
	REAR HEATED	REAR HEATED	40A	E/R Junction Block (RLY. 2)
	COOLING FAN2		40A	G4FJ : E/R Junction Block (RLY. 9)

LIGHT BULBS

Consult an authorized HYUNDAI dealer to replace most vehicle light bulbs. It is difficult to replace vehicle light bulbs because other parts of the vehicle must be removed before you can get to the bulb. This is especially true for removing the headlamp assembly to get to the bulb(s).

Removing/installing the headlamp assembly can result in damage to the vehicle.

WARNING

Prior to working on the light, firmly apply the parking brake, ensure that the ignition switch is in the LOCK/OFF position and turn off the lights to avoid sudden movement of the vehicle and burning your fingers or receiving an electric shock.

NOTICE

Be sure to replace the burned-out bulb with one of the same wattage rating. Otherwise, it may cause damage to the fuse or electric wiring system.

Information

After heavy driving, rain or washing, headlamp and tail lamp lenses could appear frosty. This condition is caused by the temperature difference between the lamp inside and outside. This is similar to the condensation on your windows inside your vehicle during the rain and doesn't indicate a problem with your vehicle. If the water leaks into the lamp bulb circuitry, we recommend that the system be checked by an authorized HYUNDAI dealer.

Information - Traffic Change (for Europe)

The low beam light distribution is asymmetric. If you go abroad to a country with opposite traffic direction, this asymmetric part will dazzle oncoming car driver. To prevent dazzle, ECE regulation demand several technical solutions (ex. automatic change system, adhesive sheet, down aiming). These headlamps are designed not to dazzle opposite drivers. So, you need not change your headlamps in a country with opposite traffic direction.

Headlamp, static bending lamp, position lamp, turn signal lamp and fog lamp light bulb replacement

Type A



- (1) Headlamp (Low)
- (2) Headlamp (High)
- (3) Turn signal lamp
- (4) Position lamp
- (5) Daytime running lamp
- (6) Fog lamp
- (7) Static bending lamp (if equipped)



Headlamp and Static bending lamp

⚠ WARNING

- **Handle halogen bulbs with care. Halogen bulbs contain pressurized gas that will produce flying pieces of glass that could cause injuries if broken.**
- **Wear eye protection when changing a bulb. Allow the bulb to cool down before handling it.**

- Always handle them carefully, and avoid scratches and abrasions. If the bulbs are lit, avoid contact with liquids.
- Never touch the glass with bare hands. Residual oil may cause the bulb to overheat and burst when lit.
- A bulb should be operated only when installed in a headlamp.
- If a bulb becomes damaged or cracked, replace it immediately and carefully dispose of it.

■ High/Low beam

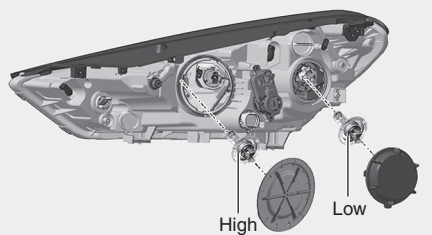

OTLE075013

■ Static bending lamp

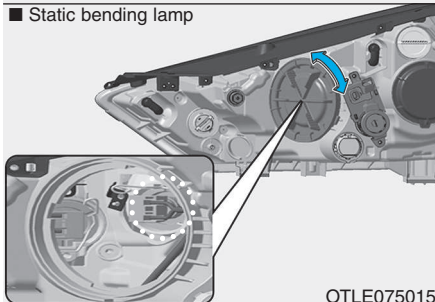

OTLE075015

1. Open the hood.
2. Disconnect the negative battery cable.
3. Remove the bulb cover by turning it counterclockwise.
4. Disconnect the bulb socket-connector.

5. Unsnap the bulb retaining wire by pressing the end and pushing it upward.
6. Remove the bulb from the headlamp assembly.
7. Install a new bulb and snap the bulb retaining wire into position by aligning the wire with the groove on the bulb.
8. Connect the bulb socket-connector.
9. Install the bulb cover by turning it clockwise.

Information تلفن شیانه روزی: ۸۵

The headlamp aiming should be adjusted after an accident or after the headlamp assembly is reinstalled at an authorized HYUNDAI dealer.

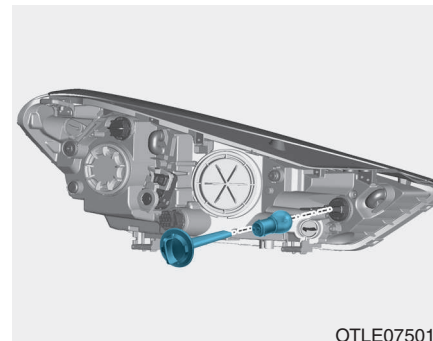

OTLE075019

Turn signal lamp

1. Open the hood.
2. Disconnect the negative battery cable.
3. Remove the socket from the assembly by turning the socket counterclockwise until the tabs on the socket align with the slots on the assembly.
4. Remove the bulb from the socket by pressing it in and rotating it counterclockwise until the tabs on the bulb align with the slots in the socket. Pull the bulb out of the socket.

5. Insert a new bulb by inserting it into the socket and rotating it until it locks into place.
6. Install the socket in the assembly by aligning the tabs on the socket with the slots in the assembly.
7. Push the socket into the assembly and turn the socket clockwise.

Position lamp/Daytime running lamp/Fog lamp

If the LED lamp does not operate, we recommend you to have the vehicle checked by an authorized HYUNDAI dealer.

Type B

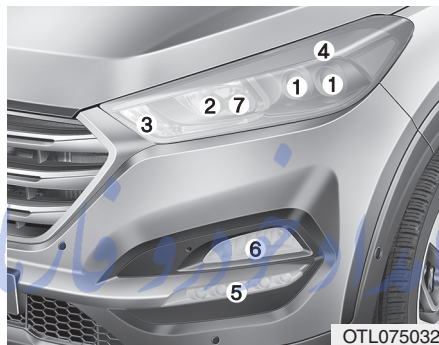

- (1) Headlamp (Low)
- (2) Headlamp (High)
- (3) Turn signal lamp
- (4) Position lamp
- (5) Daytime running lamp
- (6) Fog lamp
- (7) Static bending lamp

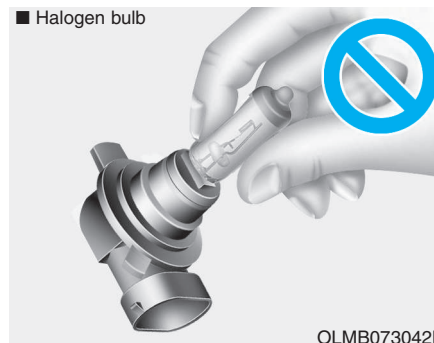

Headlamp (High beam)

⚠ WARNING

- Handle halogen bulbs with care. Halogen bulbs contain pressurized gas that will produce flying pieces of glass that could cause injuries if broken.
- Wear eye protection when changing a bulb. Allow the bulb to cool down before handling it.

- Always handle them carefully, and avoid scratches and abrasions. If the bulbs are lit, avoid contact with liquids.
- Never touch the glass with bare hands. Residual oil may cause the bulb to overheat and burst when lit.
- A bulb should be operated only when installed in a headlamp.
- If a bulb becomes damaged or cracked, replace it immediately and carefully dispose of it.

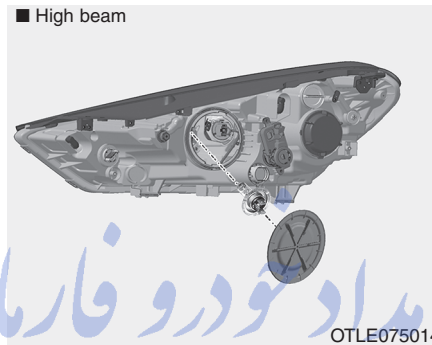

1. Open the hood.
2. Disconnect the negative battery cable.
3. Remove the bulb cover by turning it counterclockwise.
4. Disconnect the bulb socket-connector.
5. Unsnap the bulb retaining wire by pressing the end and pushing it upward.

6. Remove the bulb from the headlamp assembly.
7. Install a new bulb and snap the bulb retaining wire into position by aligning the wire with the groove on the bulb.
8. Connect the bulb socket-connector.
9. Install the bulb cover by turning it clockwise.

Headlamp (Low, LED type)

If the LED lamp does not operate, we recommend you to have the vehicle checked by an authorized HYUNDAI dealer.

i Information

The headlamp aiming should be adjusted after an accident or after the headlamp assembly is reinstalled at an authorized HYUNDAI dealer.

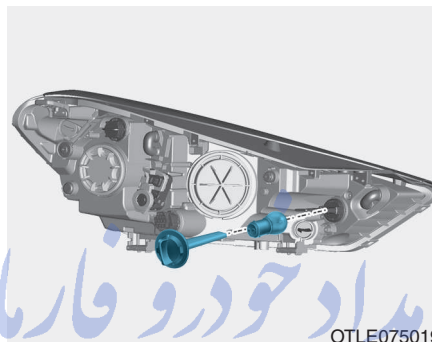

Turn signal lamp

1. Open the hood.
2. Disconnect the negative battery cable.
3. Remove the socket from the assembly by turning the socket counterclockwise until the tabs on the socket align with the slots on the assembly.
4. Remove the bulb from the socket by pressing it in and rotating it counterclockwise until the tabs on the bulb align with the slots in the socket. Pull the bulb out of the socket.

5. Insert a new bulb by inserting it into the socket and rotating it until it locks into place.
6. Install the socket in the assembly by aligning the tabs on the socket with the slots in the assembly.
7. Push the socket into the assembly and turn the socket clockwise.

Position lamp/ Daytime running lamp/ Fog lamp/Static bending lamp

If the LED lamp does not operate, we recommend you to have the vehicle checked by an authorized HYUNDAI dealer.

Side repeater lamp replacement

Type A

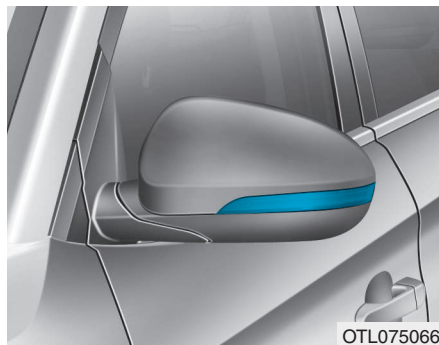

If the light bulb does not operate, we recommend you to have the vehicle checked by an authorized HYUNDAI dealer.

Type B

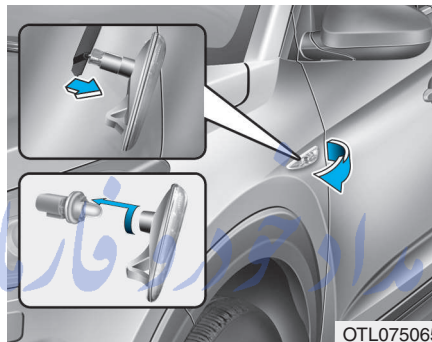

1. Remove the lamp assembly from the vehicle by prying the lens and pulling the assembly out.
2. Disconnect the bulb electrical connector.
3. Separate the socket and the lens parts by turning the socket counterclockwise until the tabs on the socket align with the slots on the lens part.
4. Remove the bulb by pulling it straight out.
5. Insert a new bulb in the socket.
6. Reassemble the socket and the lens part.

7. Connect the bulb electrical connector.

8. Reinstall the lamp assembly to the body of the vehicle.

Headlamp and front fog lamp aiming (for Europe)

Headlamp aiming

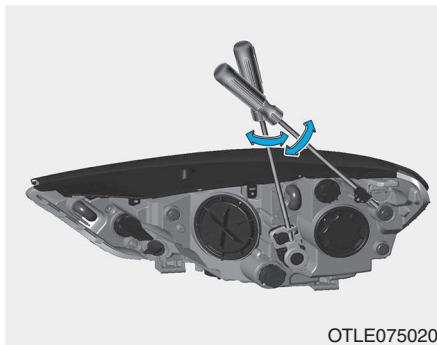

OTLE075020

1. Inflate the tires to the specified pressure and remove any loads from the vehicle except the driver, spare tire, and tools.
2. The vehicle should be placed on a flat floor.
3. Draw vertical lines (Vertical lines passing through respective head lamp centers) and a horizontal line (Horizontal line passing through center of head lamps) on the screen.

4. With the headlamp and battery in normal condition, aim the headlamps so the brightest portion falls on the horizontal and vertical lines.

5. To aim the low beam left or right, turn the driver clockwise or counterclockwise. To aim the low beam up or down, turn the driver clockwise or counterclockwise.

To aim the high beam up or down, turn the driver clockwise or counterclockwise.

Front fog lamp aiming



OTLE075021

The front fog lamp can be aimed in the same manner as the headlamps.

With the front fog lamps and battery in normal condition, aim the front fog lamps.

To aim the front fog lamp up or down, turn the driver clockwise or counterclockwise.

تلفن شبانه روزی: ۰۲۱-۸۸۸۶۲۰۸۵

FarmaSOS.com

Aiming point

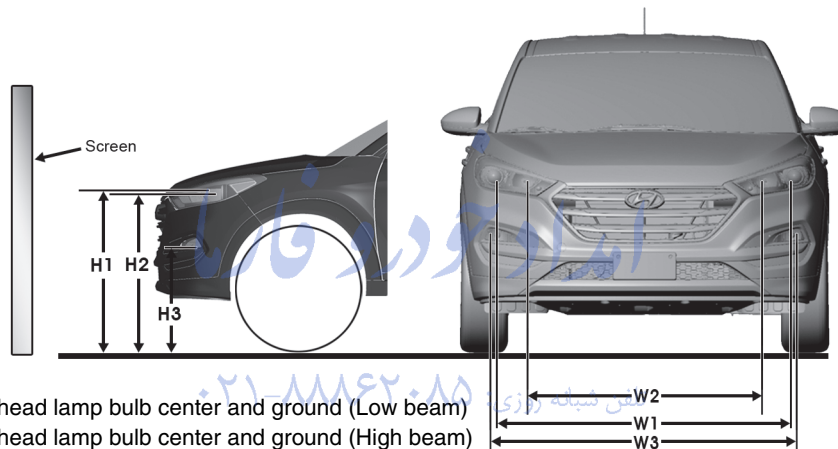

H1 : Height between the head lamp bulb center and ground (Low beam)

H2 : Height between the head lamp bulb center and ground (High beam)

H3 : Height between the fog lamp bulb center and ground

W1 : Distance between the two head lamp bulbs centers (Low beam)

W2 : Distance between the two head lamp bulbs centers (High beam)

W3 : Distance between the two fog lamp bulbs centers

OTLE075022

Unit: mm (in)

Vehicle condition	Lamp type	H1	H2	H3		W1	W2	W3	
				FOG	FOG+DRL			FOG	FOG+DRL
Without driver	Halogen/HID	886 (34.89)	862 (33.94)	578 (22.76)	565 (22.24)	1502 (59.13)	1208 (47.56)	1474 (58.03)	1452 (57.17)
	LED	884 (34.80)				1494 (58.82)			
With driver	Halogen/HID	879 (34.60)	855 (33.66)	571 (22.48)	558 (21.97)	1502 (59.13)	1208 (47.56)	1474 (58.03)	1452 (57.17)
	LED	877 (34.53)				1494 (58.82)			

Headlamp low beam (LHD side)

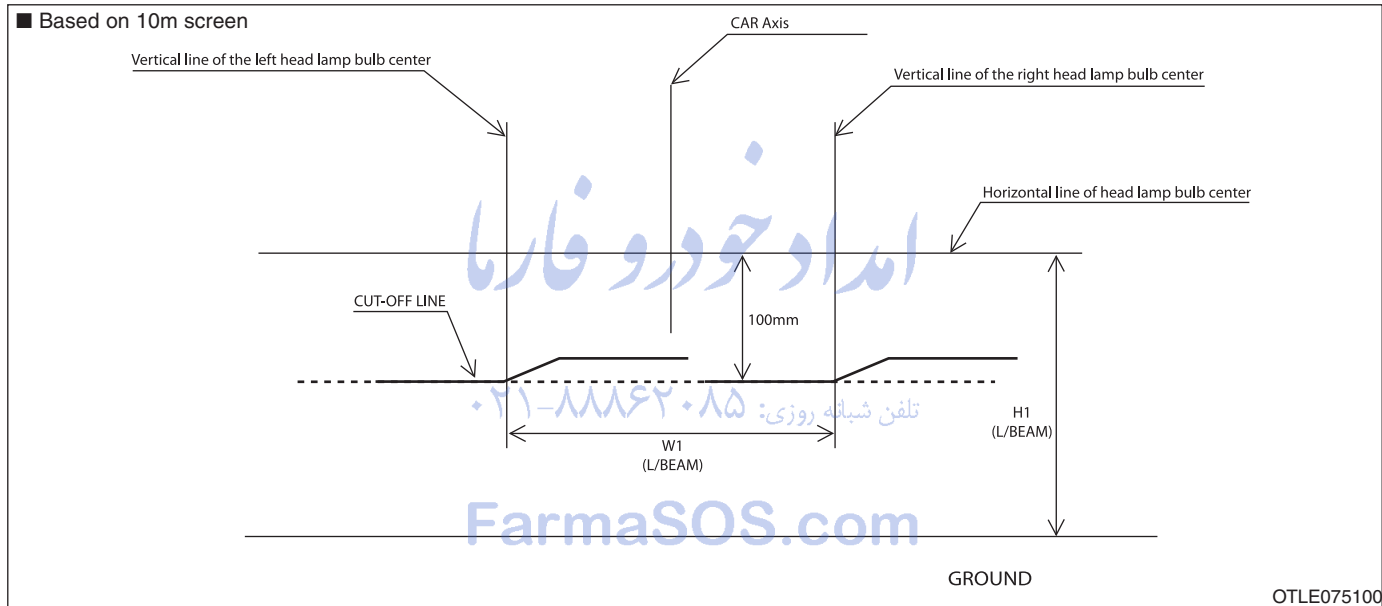

1. Turn the low beam on without driver aboard.
2. The cut-off line should be projected in the cut-off line shown in the picture.
3. When aiming the low beam, vertical aiming should be adjusted after adjusting the horizontal aiming.
4. If headlamp leveling device is equipped, adjust the head lamp leveling device switch with 0 positions.

Headlamp low beam (RHD side)

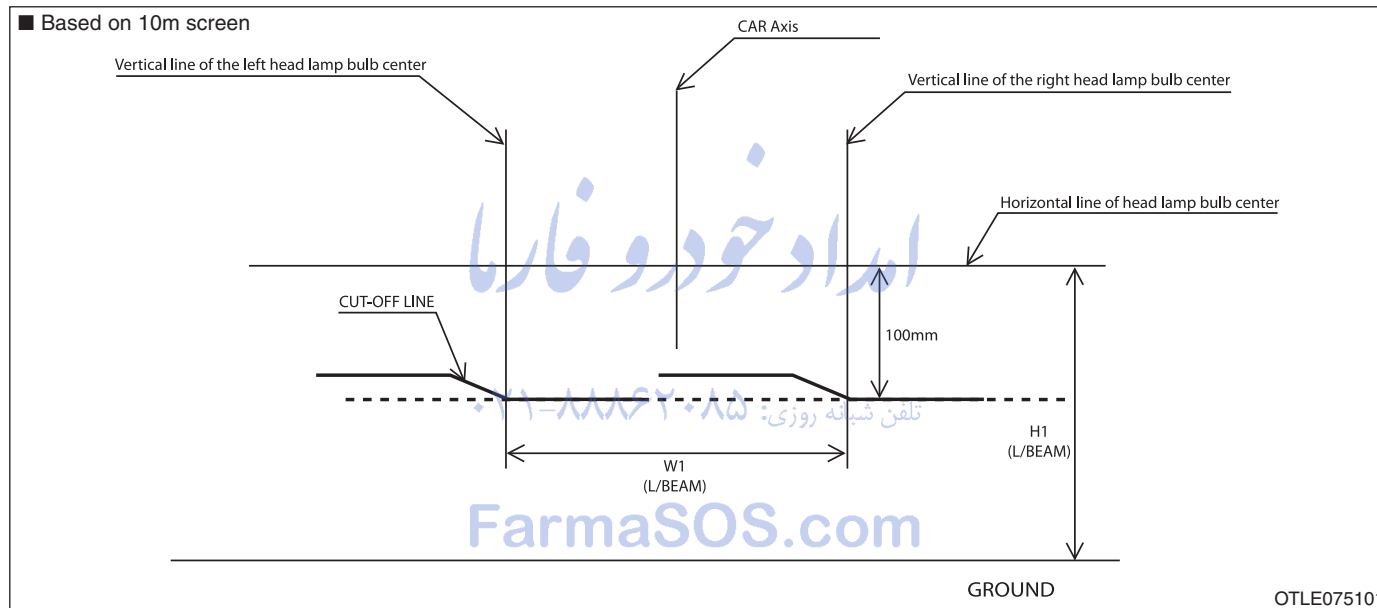

1. Turn the low beam on without driver aboard.
2. The cut-off line should be projected in the cut-off line shown in the picture.
3. When aiming the low beam, vertical aiming should be adjusted after adjusting the horizontal aiming.
4. If headlamp leveling device is equipped, adjust the head lamp leveling device switch with 0 positions.

Front fog lamp

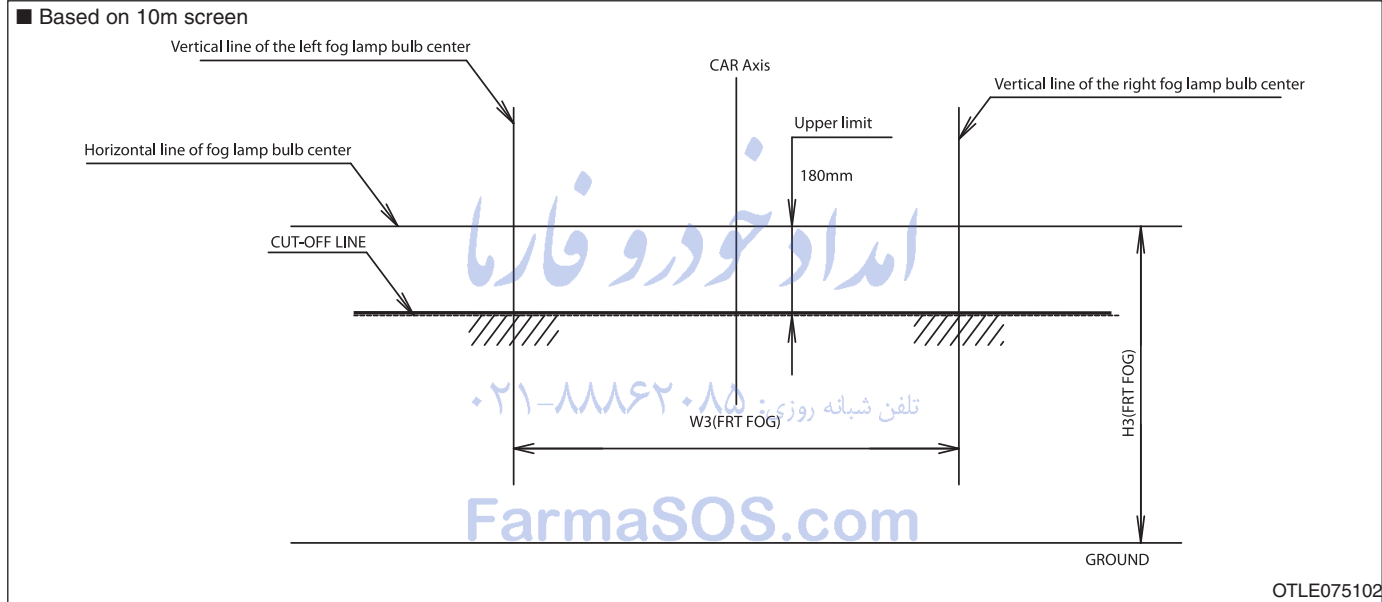

1. Turn the front fog lamp on without the driver aboard.
2. The cut-off line should be projected in the allowable range (shaded region).

Rear combination light bulb replacement

■ Type A

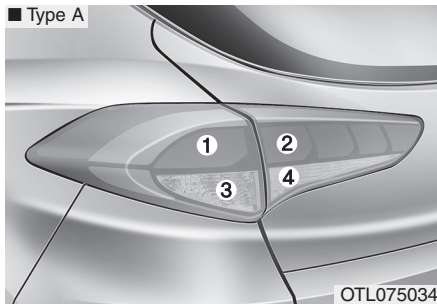

■ Type B

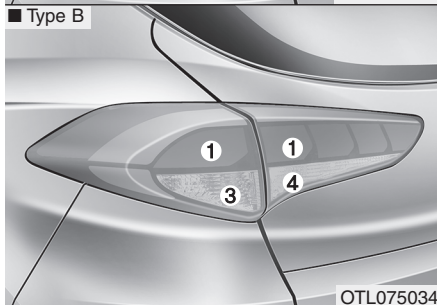

- (1) Stop lamp
- (2) Tail lamp
- (3) Rear turn signal lamp
- (4) Back-up lamp

Outside lamp

Stop/tail Lamp and Turn signal lamp

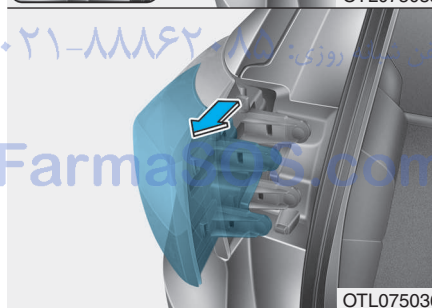
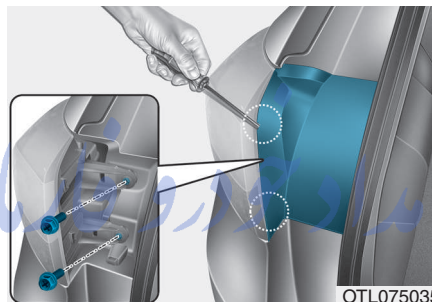

1. Turn off the engine.
2. Open the tailgate.

3. Loosen the lamp assembly retaining screws with a cross-tip screwdriver.
4. Remove the rear combination lamp assembly from the body of the vehicle.

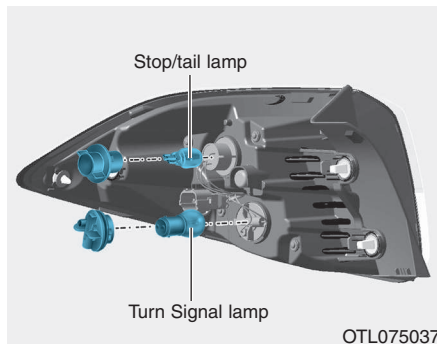

5. Remove the socket from the assembly by turning the socket counterclockwise until the tabs on the socket align with the slots on the assembly.
6. Remove the bulb from the socket by pressing it in and rotating it counterclockwise until the tabs on the bulb align with the slots in the socket. Pull the bulb out of the socket.
7. Insert a new bulb by inserting it into the socket and rotating it until it locks into place.

8. Install the socket in the assembly by aligning the tabs on the socket with the slots in the assembly.

Push the socket into the assembly and turn the socket clockwise.

9. Reinstall the lamp assembly to the body of the vehicle. ♦

Stop/tail lamp (LED type)

If the LED lamp does not operate, we recommend you to have the vehicle checked by an authorized HYUNDAI dealer.

امداد خودرو فارما

تلفن شبانه روزی: ۰۲۱-۸۸۸۶۲۰۸۵

FarmaSOS.com

Inside lamp

Tail lamp/Back-up lamp



1. Turn off the engine.
2. Open the tailgate.
3. Remove the service cover using a flat-blade screwdriver.

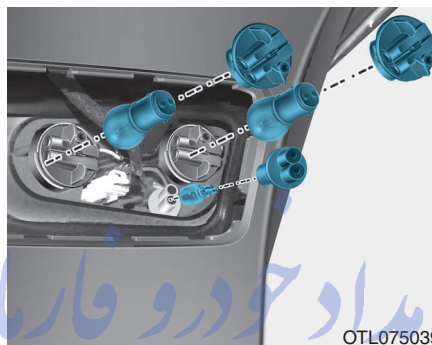

4. Remove the socket from the assembly by turning the socket counterclockwise until the tabs on the socket align with the slots on the assembly.
5. Pull the bulb out of the socket.
6. Insert a new bulb into the socket.
7. Install the socket into the assembly by aligning the tabs on the socket with the slots on the assembly and turning the socket clockwise.
8. Reinstall the lamp assembly to the body of the vehicle

Stop and tail lamp (LED type)

If the LED lamp does not operate, we recommend you to have the vehicle checked by an authorized HYUNDAI dealer.

Rear fog lamp (if equipped)

1. Remove the socket from the assembly by turning the socket counterclockwise until the tabs on the socket align with the slots on the assembly.
2. Remove the bulb from the socket by pressing it in and rotating it counterclockwise until the tabs on the bulb align with the slots in the socket. Pull the bulb out of the socket.
3. Insert a new bulb in the socket.
4. Reinstall the light assembly to the body of the vehicle.

High mounted stop lamp replacement

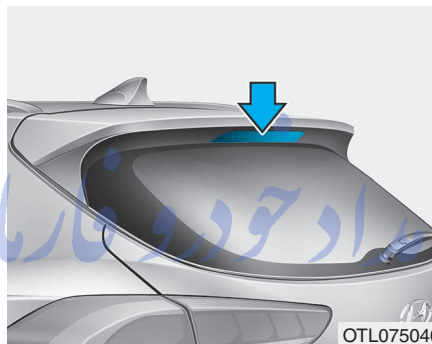

If the high mounted stop lamp does not operate, we recommend that you contact an authorized HYUNDAI dealer.

License plate light bulb replacement

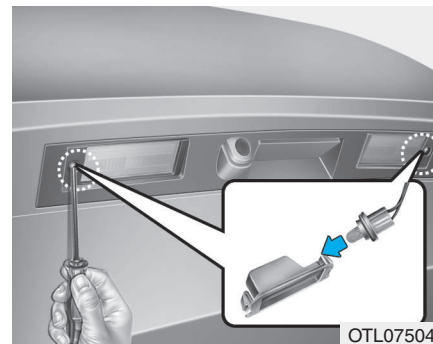

1. Loosen the lens retaining screws with a screwdriver.
2. Remove the lens.
3. Remove the bulb by pulling it straight out.
4. Install a new bulb.
5. Reinstall the lens securely with the lens retaining screws.

FarmaSOS.com

Interior light bulb replacement

Map lamp and Room lamp

■ Map lamp - with sunroof



■ Room lamp - with sunroof

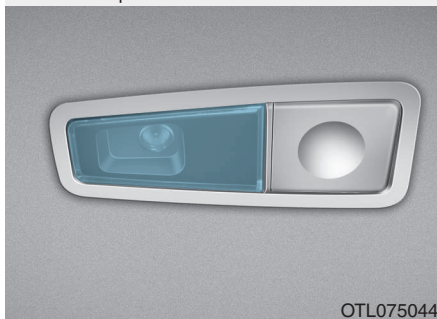

Map lamp, Room lamp, Vanity mirror lamp and glove box lamp

■ Map lamp - without sunroof

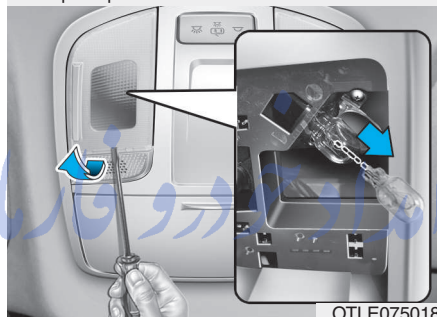

■ Room lamp - without sunroof

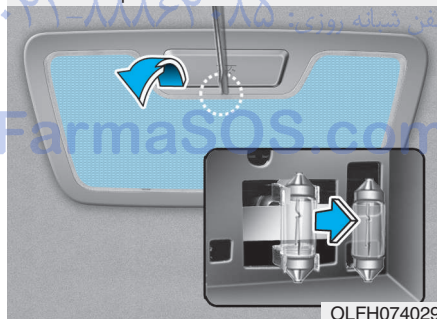

■ Vanity mirror lamp



■ Tailgate room lamp

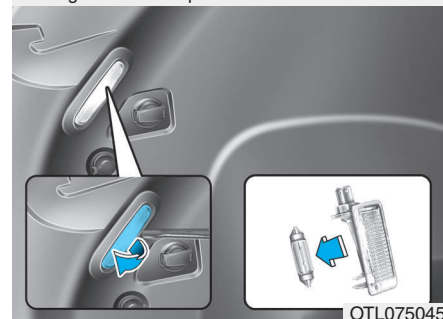

If the LED lamp does not operate, we recommend you to have the vehicle checked by an authorized HYUNDAI dealer.

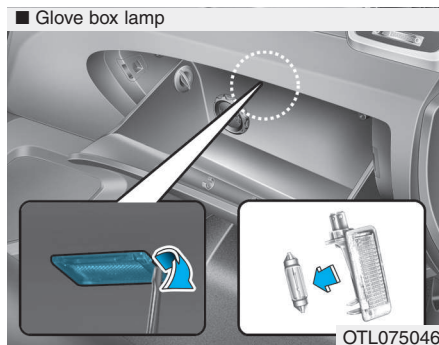

1. Using a flat-head screwdriver, gently pry the lens from the interior light housing.
2. Remove the bulb by pulling it straight out.
3. Install a new bulb in the socket.
4. Align the lens tabs with the interior light housing notches and snap the lens into place.

NOTICE

Be careful not to damage the cover, tab, and plastic housing.

امداد خودرو فارما

تلفن شبانه روزی: ۰۲۱-۸۸۸۶۲۰۸۵

FarmaSOS.com

APPEARANCE CARE

Exterior care

Exterior general caution

It is very important to follow the label directions when using any chemical cleaner or polish. Read all warning and caution statements that appear on the label.

Finish maintenance

Washing

To help protect your vehicle's finish from rust and deterioration, wash it thoroughly and frequently at least once a month with lukewarm or cold water.

If you use your vehicle for off-road driving, you should wash it after each off-road trip. Pay special attention to the removal of any accumulation of salt, dirt, mud, and other foreign materials. Make sure the drain holes in the lower edges of the doors and rocker panels are kept clear and clean.

Insects, tar, tree sap, bird droppings, industrial pollution and similar deposits can damage your vehicle's finish if not removed immediately.

Even prompt washing with plain water may not completely remove all these deposits.

A mild soap, safe for use on painted surfaces, may be used.

After washing, rinse the vehicle thoroughly with lukewarm or cold water. Do not allow soap to dry on the finish.

NOTICE

- Do not use strong soap, chemical detergents or hot water, and do not wash the vehicle in direct sunlight or when the body of the vehicle is warm.
- Be careful when washing the side windows of your vehicle. Especially, with high-pressure water, water may leak through the windows and wet the interior.
- To prevent damage to the plastic parts and lamps, do not clean with chemical solvents or strong detergents.

⚠ WARNING

Wet brakes

After washing the vehicle, test the brakes while driving slowly to see if they have been affected by water. If braking performance is impaired, dry the brakes by applying them lightly while maintaining a slow forward speed.

High-pressure washing

- When using high-pressure washers, make sure to maintain sufficient distance from the vehicle.

Insufficient clearance or excessive pressure can lead to component damage or water penetration.

- Do not spray the camera, sensors or its surrounding area directly with a high pressure washer. Shock applied from high pressure water may cause the device to not operate normally.
- Do not bring the nozzle tip close to boots (rubber or plastic covers) or connectors as they may be damaged if they come into contact with high pressure water.



NOTICE

- **Water washing in the engine compartment including high pressure water washing may cause the failure of electrical circuits located in the engine compartment.**
- **Never allow water or other liquids to come in contact with electrical/electronic components inside the vehicle as this may damage them.**

Waxing

Wax the vehicle when water will no longer bead on the paint.

Always wash and dry the vehicle before waxing. Use a good quality liquid or paste wax, and follow the manufacturer's instructions. Wax all metal trim to protect it and to maintain its luster. Removing oil, tar, and similar materials with a spot remover will usually strip the wax from the finish. Be sure to re-wax these areas even if the rest of the vehicle does not yet need waxing.

NOTICE

- **Wiping dust or dirt off the body with a dry cloth will scratch the finish.**
- **Do not use steel wool, abrasive cleaners, or strong detergents containing highly alkaline or caustic agents on chrome-plated or anodized aluminum parts. This may result in damage to the protective coating and cause discoloration or paint deterioration.**

Finish damage repair

Deep scratches or stone chips in the painted surface must be repaired promptly. Exposed metal will quickly rust and may develop into a major repair expense.

NOTICE

If your vehicle is damaged and requires any metal repair or replacement, be sure the body shop applies anti-corrosion materials to the parts repaired or replaced.

Bright-metal maintenance

- To remove road tar and insects, use a tar remover, not a scraper or other sharp object.
- To protect the surfaces of bright-metal parts from corrosion, apply a coating of wax or chrome preservative and rub to a high luster.
- During winter weather or in coastal areas, cover the bright metal parts with a heavier coating of wax or preservative. If necessary, coat the parts with non-corrosive petroleum jelly or other protective compound.

تلفن شبانه روزی: ۰۲۱-۸۸۸۶۲۰۸۵

FarmaSOS.com

Underbody maintenance

Corrosive materials used for ice and snow removal and dust control may collect on the underbody. If these materials are not removed, accelerated rusting can occur on underbody parts such as the fuel lines, frame, floor pan and exhaust system, even though they have been treated with rust protection.

Thoroughly flush the vehicle underbody and wheel openings with lukewarm or cold water once a month, after off-road driving and at the end of each winter. Pay special attention to these areas because it is difficult to see all the mud and dirt. It will do more harm than good to wet down the road grime without removing it. The lower edges of doors, rocker panels, and frame members have drain holes that should not be allowed to clog with dirt; trapped water in these areas can cause rusting.

⚠ WARNING

After washing the vehicle, test the brakes while driving slowly to see if they have been affected by water. If braking performance is impaired, dry the brakes by applying them lightly while maintaining a slow forward speed.

Aluminum wheel maintenance

The aluminum wheels are coated with a clear protective finish.

NOTICE

- Do not use any abrasive cleaner, polishing compound, solvent, or wire brushes on aluminum wheels.
- Clean the wheel when it has cooled.
- Use only a mild soap or neutral detergent, and rinse thoroughly with water. Also, be sure to clean the wheels after driving on salted roads.
- Do not wash the wheels with high-speed car wash brushes.
- Do not use any cleanser containing acid or alkaline detergents.

Corrosion protection

Protecting your vehicle from corrosion

By using the most advanced design and construction practices to combat corrosion, we produce cars of the highest quality. However, this is only part of the job. To achieve the long-term corrosion resistance your vehicle can deliver, the owner's cooperation and assistance is also required.

Common causes of corrosion

The most common causes of corrosion on your car are:

- Road salt, dirt and moisture that is allowed to accumulate underneath the car.
- Removal of paint or protective coatings by stones, gravel, abrasion or minor scrapes and dents which leave unprotected metal exposed to corrosion.

High-corrosion areas

If you live in an area where your car is regularly exposed to corrosive materials, corrosion protection is particularly important. Some of the common causes of accelerated corrosion are road salts, dust control chemicals, ocean air and industrial pollution.

Moisture breeds corrosion

Moisture creates the conditions in which corrosion is most likely to occur. For example, corrosion is accelerated by high humidity, particularly when temperatures are just above freezing. In such conditions, the corrosive material is kept in contact with the car surfaces by moisture that is slow to evaporate.

Mud is particularly corrosive because it is slow to dry and holds moisture in contact with the vehicle. Although the mud appears to be dry, it can still retain the moisture and promote corrosion.

High temperatures can also accelerate corrosion of parts that are not properly ventilated so the moisture can be dispersed. For all these reasons, it is particularly important to keep your car clean and free of mud or accumulations of other materials. This applies not only to the visible surfaces but particularly to the underside of the car.

To help prevent corrosion

You can help prevent corrosion from getting started by observing the following:

تلفن شبانه روزی: ۰۲۱-۸۸۸۶۲۰۸۵

FarmaSOS.com

Keep your car clean

The best way to prevent corrosion is to keep your car clean and free of corrosive materials. Attention to the underside of the car is particularly important.

- If you live in a high-corrosion area — where road salts are used, near the ocean, areas with industrial pollution, acid rain, etc.—, you should take extra care to prevent corrosion. In winter, hose off the underside of your car at least once a month and be sure to clean the underside thoroughly when winter is over.
- When cleaning underneath the car, give particular attention to the components under the fenders and other areas that are hidden from view. Do a thorough job; just dampening the accumulated mud rather than washing it away will accelerate corrosion rather than prevent it. Water under high pressure and steam are particularly effective in removing accumulated mud and corrosive materials.

- When cleaning lower door panels, rocker panels and frame members, be sure that drain holes are kept open so that moisture can escape and not be trapped inside to accelerate corrosion.

Keep your garage dry

Don't park your car in a damp, poorly ventilated garage. This creates a favorable environment for corrosion. This is particularly true if you wash your car in the garage or drive it into the garage when it is still wet or covered with snow, ice or mud. Even a heated garage can contribute to corrosion unless it is well ventilated so moisture is dispersed.

Keep paint and trim in good condition

Scratches or chips in the finish should be covered with "touch-up" paint as soon as possible to reduce the possibility of corrosion. If bare metal is showing through, the attention of a qualified body and paint shop is recommended.

Bird droppings : Bird droppings are highly corrosive and may damage painted surfaces in just a few hours. Always remove bird droppings as soon as possible.

تلفن شبانه روزی: ۰۸۵-۸۸۸۸۸۸۸۸-۰۲۱

FarmaSOS.com

Don't neglect the interior

Moisture can collect under the floor mats and carpeting to cause corrosion. Check under the mats periodically to be sure the carpeting is dry. Use particular care if you carry fertilizers, cleaning materials or chemicals in the car.

These should be carried only in proper containers and any spills or leaks should be cleaned up, flushed with clean water and thoroughly dried.

Interior care

Interior general precautions

Prevent chemicals such as perfume, cosmetic oil, sun cream, hand cleaner and air freshener from contacting the interior parts because they may cause damage or discoloration. If they do contact the interior parts, wipe them off immediately.

See the instructions that follow for the proper way to clean vinyl.

NOTICE

Never allow water or other liquids to come in contact with electrical/electronic components inside the vehicle as this may damage them.

NOTICE

When cleaning leather products (steering wheel, seats etc.), use neutral detergents or low alcohol content solutions. If you use high alcohol content solutions or acid/alkaline detergents, the color of the leather may fade or the surface may get stripped off.

Cleaning the upholstery and interior trim

Vinyl

Remove dust and loose dirt from vinyl with a whisk broom or vacuum cleaner. Clean vinyl surfaces with a vinyl cleaner.

Fabric

Remove dust and loose dirt from fabric with a whisk broom or vacuum cleaner. Clean with a mild soap solution recommended for upholstery or carpets.

Remove fresh spots immediately with a fabric spot cleaner. If fresh spots do not receive immediate attention, the fabric can be stained and its color can be affected. Also, its fire-resistant properties can be reduced if the material is not properly maintained.

NOTICE

Using anything but recommended cleaners and procedures may affect the fabric's appearance and fire-resistant properties.

Cleaning the lap/shoulder belt webbing

Clean the belt webbing with any mild soap solution recommended for cleaning upholstery or carpet. Follow the instructions provided with the soap. Do not bleach or re-dye the webbing because this may weaken it.

Cleaning the interior window glass

If the interior glass surfaces of the vehicle become fogged (that is, covered with an oily, greasy or waxy film), they should be cleaned with glass cleaner. Follow the directions on the glass cleaner container.

NOTICE

Do not scrape or scratch the inside of the rear window. This may result in damage to the rear window defroster grid.

EMISSION CONTROL SYSTEM

The emission control system of your vehicle is covered by a written limited warranty. Please see the warranty information contained in the Service Passport in your vehicle.

Your vehicle is equipped with an emission control system to meet all emission regulations.

There are three emission control systems which are as follows.

- (1) Crankcase emission control system
- (2) Evaporative emission control system
- (3) Exhaust emission control system

In order to assure the proper function of the emission control systems, it is recommended that you have your car inspected and maintained by an authorized HYUNDAI dealer in accordance with the maintenance schedule in this manual.

CAUTION

For the Inspection and Maintenance Test (With Electronic Stability Control (ESC) system)

- **To prevent the vehicle from misfiring during dynamometer testing, turn the Electronic Stability Control (ESC) system off by pressing the ESC switch.**
- **After dynamometer testing is completed, turn the ESC system back on by pressing the ESC switch again.**

1. Crankcase emission control system

The positive crankcase ventilation system is employed to prevent air pollution caused by blow-by gases being emitted from the crankcase. This system supplies fresh filtered air to the crankcase through the air intake hose. Inside the crankcase, the fresh air mixes with blow-by gases, which then pass through the PCV valve into the induction system.

2. Evaporative emission control system

The Evaporative Emission Control System is designed to prevent fuel vapors from escaping into the atmosphere.

Canister

Fuel vapors generated inside the fuel tank are absorbed and stored in the onboard canister. When the engine is running, the fuel vapors absorbed in the canister are drawn into the surge tank through the purge control solenoid valve.

Purge Control Solenoid Valve (PCSV)

The purge control solenoid valve is controlled by the Engine Control Module (ECM); when the engine coolant temperature is low during idling, the PCSV closes so that evaporated fuel is not taken into the engine. After the engine warms-up during ordinary driving, the PCSV opens to introduce evaporated fuel to the engine.

3. Exhaust emission control system

The Exhaust Emission Control System is a highly effective system which controls exhaust emissions while maintaining good vehicle performance.

Vehicle modifications

This vehicle should not be modified. Modification of your vehicle could affect its performance, safety or durability and may even violate governmental safety and emissions regulations.

In addition, damage or performance problems resulting from any modification may not be covered under warranty.

- If you use unauthorized electronic devices, it may cause the vehicle to operate abnormally, wire damage, battery discharge and fire. For your safety, do not use unauthorized electronic devices.

Engine exhaust gas precautions (carbon monoxide)

- Carbon monoxide can be present with other exhaust fumes. Therefore, if you smell exhaust fumes of any kind inside your vehicle, have it inspected and repaired immediately. If you ever suspect exhaust fumes are coming into your vehicle, drive it only with all the windows fully open. Have your vehicle checked and repaired immediately.

 **WARNING**

Engine exhaust gases contain carbon monoxide (CO). Though colorless and odorless, it is dangerous and could be lethal if inhaled. Follow the instructions following to avoid CO poisoning.

- Do not operate the engine in confined or closed areas (such as garages) any more than what is necessary to move the vehicle in or out of the area.
- When the vehicle is stopped in an open area for more than a short time with the engine running, adjust the ventilation system (as needed) to draw outside air into the vehicle.
- Never sit in a parked or stopped vehicle for any extended time with the engine running.
- When the engine stalls or fails to start, excessive attempts to restart the engine may cause damage to the emission control system.

FarmaSOS.com

Operating precautions for catalytic converters (if equipped)

 **WARNING**

- **A hot exhaust system can ignite flammable items under your vehicle. Do not park, idle, or drive the vehicle over or near flammable objects, such as dry grass, paper, leaves, etc.**
 - **The exhaust system and catalytic system are very hot while the engine is running or immediately after the engine is turned off. Keep away from the exhaust system and catalytic, you may get burned.**
- Also, do not remove the heat sink around the exhaust system, do not seal the bottom of the vehicle or do not coat the vehicle for corrosion control. It may present a fire risk under certain conditions.**

Your vehicle is equipped with a catalytic converter emission control device.

Therefore, the following precautions must be observed:

 **CAUTION**

- Use only **UNLEADED FUEL** for gasoline engine.
- Do not operate the vehicle when there are signs of engine malfunction, such as misfire or a noticeable loss of performance.
- Do not misuse or abuse the engine. Examples of misuse are coasting with the engine off and descending steep grades in gear with the engine off.

(Continued)

(Continued)

- Do not operate the engine at high idle speed for extended periods (5 minutes or more).
- Do not modify or tamper with any part of the engine or emission control system. All inspections and adjustments must be made by an authorized HYUNDAI dealer.
- Avoid driving with a very low fuel level. If you run out of gasoline, it could cause the engine to misfire and result in excessive loading of the catalytic converter.

Failure to observe these precautions could result in damage to the catalytic converter and to your vehicle.

Additionally, such actions could void your warranties.

FarmaSOS.com

Diesel particulate filter (DPF) (if equipped)

The Diesel Particulate Filter (DPF) system removes the soot in the exhaust gas.

The DPF system automatically burns (or oxidizes) the accumulated soot in accordance with the driving situations, unlike a disposable air filter.

In other words, the accumulated soot is automatically purged out by the engine control system and by the high exhaust-gas temperature at normal/high driving speeds.

However, when the vehicle is continually driven at repeated short distance or driven at low speed for a long time, the accumulated soot may not be automatically removed because of low exhaust gas temperature. In this case, the accumulated soot is out of the detection range, the soot oxidization process does not occur, and the Malfunction Indicator Lamp (MIL) illuminates.

The Malfunction Indicator Lamp (MIL) stops illuminating, when the driving speed exceeds 60 km/h (37mph), or when the engine rpm is between 1,500 and 2,500 with the gear in the 2nd position or above for approximately 25 minutes.

When the MIL continuously blinks or the warning message "Check exhaust system" illuminates in the above cases, we recommend you to have the DPF system checked by an authorized HYUNDAI dealer.

When the vehicle is continuously driven with the MIL flashing for an extended period of time, it may damage the DPF system and lower the fuel economy.

CAUTION

Diesel Fuel (if equipped with DPF)

We recommend you to use only the regulated diesel fuels, when your vehicle is equipped with the DPF system.

When you use other diesel fuels, which is high in sulfurs (above 50 ppm) or contains unspecified additives, it may damage the DPF system and cause the white smoke emission.

Lean NOx Trap (if equipped)

The Lean NOx Trap (LNT) system removes the nitrogen oxide in the exhaust gas. The smell can occur in the exhaust gas depending on the quality of the fuel and it can degrade NOx reduction performance, please use the regulated automotive diesel fuel.

Specifications & Consumer information

Dimensions	8-2
Engine	8-2
Bulb wattage	8-3
Tires and wheels	8-4
Load and speed capacity tires	8-5
Gross vehicle weight	8-6
Luggage volume	8-6
Recommended lubricants and capacities	8-7
Recommended engine oil	8-9
Recommended sae viscosity number	8-10
Vehicle identification number (VIN)	8-11
Vehicle certification label	8-11
Tire specification and pressure label	8-12
Engine number	8-12
Air conditioner compressor label	8-13
Refrigerant label	8-13
Declaration of conformity	8-13

امداد خودرو فارما

تلفن شبانه روزی: ۰۲۱-۸۸۸۴۸۵

FarmaSOS.com

DIMENSIONS

item		mm (in)	
Overall length		4,475 (176.18)	
Overall width		1,850 (72.83)	
Overall height	For Western Europe	1,645 (64.76) / 1,650 (66.34) *1	
	Except Western Europe	1,655 (65.16) / 1,660 (65.35) *1	
Front tread	215/70 R16	1,620 (63.78)	
	225/60 R17	1,608 (63.31)	
	245/45 R19	1,604 (63.15)	
Rear tread	215/70 R16	1,631 (64.21)	
	225/60 R17	1,620 (63.78)	
	245/45 R19	1,615 (63.58)	
Wheelbase		2,670 (105.12)	

*1 with roof rack



ENGINE

Item	1.6 GDI / 1.6 T-GDI	2.0 MPI	2.4 GDI	1.7 TCI	2.0 TCI
Displacement cc (cu. in)	1,591 (97.09)	1,999 (121.99)	2,359 (143.96)	1,685 (102.8)	1,995 (121.74)
Bore x Stroke mm (in.)	77X85.4 (3.03X3.36)	81X97 (3.19X3.81)	88X96 (3.46X3.78)	77.2X90 (3.04X3.81)	84X90 (3.30X3.54)
Firing order	1-3-4-2	1-3-4-2	1-3-4-2	1-3-4-2	1-3-4-2
No. of cylinders	4. In-line	4. In-line	4. In-line	4. In-line	4. In-line

BULB WATTAGE

Light Bulb			Bulb type	Wattage	
Front	Headlamp	Low	Type A	H7LL	55
			Type B	LED	LED
		High		H7LL	55
	Turn signal lamp			PY21W	21
	Position lamp			LED	LED
	Fog lamp			H8L	35
	Side Repeater lamp (Outside mirror)		Type A	LED	LED
			Type B	WY5W	5
	Static bending lamp (SBL)			H7LL	55
	Daytime running lamp (DRL)			LED	LED
Rear	Rear combination lamp	Type A	Stop/Tail	21/5W	21/5
			Tail	21/5W	21/5
			Turn signal	PY21W	21
		Type B	Back up	W16W	16
			Stop/Tail	LED	LED
			Turn signal	PY21W	21
	High mounted stop lamp			W16W	W16W
	License plate lamp			LED	LED
	Fog lamp			W5W	5
	Fog lamp			P21W	21
Interior	Map lamp	with sunroof	LED	LED	
		without sunroof	W10W	10	
	Room lamp	with sunroof	LED	LED	
		without sunroof	FESTOON	10	
	Sunvisor lamp			FESTOON	5
	Tailgate room lamp			FESTOON	10
Glove box lamp			W5W	5	
Etc	Puddle lamp			LED	LED

TIRES AND WHEELS

Item	Tire size	Wheel size	Inflation pressure bar (kPa, psi)				Wheel lug nut torque kgf·m (lbf·ft, N·m)
			Normal load ( + \emptyset)		Maximum load ( + )		
			Front	Rear	Front	Rear	
Full size tire	215/70 R16	6.5J X 16	2.4 (240, 35)	2.4 (240, 35)	2.4 (240, 35)	2.4 (240, 35)	9~11 (65~79, 88~107)
	225/60 R17	7.0J X 17	2.5* (250, 36)	2.5* (250, 36)	2.5* (250, 36)	2.5* (250, 36)	
	245/45 R19	7.5J X 19	2.4 (240, 35)	2.4 (240, 35)	2.4 (240, 35)	2.4 (240, 35)	

* Applies to MSTA Tire Pressure

Information

For U2 1.7 (M/T) lowest fuel consumption pack, the inflation pressure for the front tire is 2.6 bar (260 kPa, 37 psi).

NOTICE

- It is permissible to add 20 kPa (3 psi) to the standard tire pressure specification if colder temperatures are expected soon. Tires typically lose 7 kPa (1 psi) for every 7°C (12°F) temperature drop. If extreme temperature variations are expected, recheck your tire pressure as necessary to keep them properly inflated.
- An air pressure generally decreases, as you drive up to a high-altitude area above sea level. Thus, if you plan to drive a high-altitude area, check the tire pressures in advance. If necessary, inflate them to a proper level (Air inflation per altitude: +10 kPa/1 km (+2.4 psi/1 mile)).

CAUTION

When replacing tires, use the same size originally supplied with the vehicle.
Using tires of a different size can damage the related parts or make it work irregularly.

LOAD AND SPEED CAPACITY TIRES (FOR EUROPE)

Item	Tire size	Wheel size	Load Capacity		Speed Capacity	
			LI *1	kg	SS *2	km/h
Full size tire	215/70 R16	6.5J X 16	100	800	H	210
	225/60 R17	7.0J X 17	99	775	H	210
					V	240
245/45 R19	7.5J X 19	98	750	W	270	

*1 LI : LOAD INDEX

*2 SS : SPEED SYMBOL

امداد خودرو فارما

تلفن شبانه روزی: ۰۲۱-۸۸۸۶۲۰۸۵

FarmaSOS.com

GROSS VEHICLE WEIGHT

kg (lbs)

Item	Gasoline Engine										
	1.6 GDI		1.6 T-GDI				2.0 MPI				2.4 GDI
	2WD		2WD		4WD		2WD		4WD		4WD
	MT	AT	MT	DCT	MT	DCT	MT	AT	MT	AT	AT
5 seater	1,895 (4,178)	2,050 (4,519)	2,120 (4,674)	2,130 (4,696)	2,170 (4,784)	2,190 (4,828)	2,050 (4,519)	2,060 (4,541)	2,110 (4,652)	2,130 (4,696)	2,140 (4,717)

Item	Diesel Engine				
	1.7 TCI		2.0 TCI		
	2WD		2WD	4WD	
	MT	DCT	MT	MT	AT
5 seater	2,000 (4,409)	2,085 (4,597)	2,235 (4,927)	2,250 (4,960)	2,250 (4,960)

FarmaSOS.com

LUGGAGE VOLUME

l (cu. ft.)

Item		Full size tire	Tire Mobility Kit (TMK)
VDA	MIN	488 (17.23)	513 (18.12)
	MAX	1478 (52.20)	1503 (53.08)

Min : Behind rear seat to upper edge of the seat back.

Max : Behind front seat to roof.

RECOMMENDED LUBRICANTS AND CAPACITIES

To help achieve proper engine and powertrain performance and durability, use only lubricants of the proper quality. The correct lubricants also help promote engine efficiency that results in improved fuel economy.

These lubricants and fluids are recommended for use in your vehicle.

Lubricant		Volume	Classification		
Engine oil *1 *2 (drain and refill) Recommends 	Gamma 1.6	GDI	3.6 l (3.8 US qt.)	ACEA A5*3 (or above)	
		T-GDI	4.5 l (4.76 US qt.)		
	Nu 2.0	MPI	4.0 l (4.23 US qt.)	For Middle East, Morocco, Egypt	ACEA A5*3 (or above)
				Except Middle East, Morocco, Egypt	API SM*4 & ILSAC GF-4 (or above) ACEA A5*3 (or above)
	Theta II 2.4	GDI	4.8 l (5.07 US qt.)	ACEA A5*3 (or above)	
	U2 1.7	TCI	5.3 l (5.6 US qt.)	with DPF	ACEA C2 or C3*5
				without DPF	ACEA B4*5
	R 2.0	TCI	7.6 l (8.03 US qt.)	with DPF	ACEA C2 or C3*5
without DPF				ACEA B4*5	
Manual transaxle fluid	Gamma 1.6	GDI	1.6~1.7 l (1.7~1.8 US qt.)	HK MTF 70W (SK) SPIRAX S6 GHME 70W (H.K.SHELL) GS MTF HD 70W (GS CALTEX) (API GL-4, SAE 70W)	
	Gamma 1.6	T-GDI	2WD : 1.7~1.8 l (1.8~1.9 US qt.)		
	Nu 2.0	MPI	4WD : 1.6~1.7 l (1.7~1.8 US qt.)		
	U2 1.7	TCI	1.7~1.8 l (1.8~1.9 US qt.)		
	R 2.0	TCI	1.8~1.9 l (1.9~2.0 US qt.)		

Specifications & Consumer information

Lubricant		Volume	Classification	
Automatic transaxle fluid	Gamma 1.6	7.3 l (7.71 US qt.)	MICHANG ATF SP-IV, SK ATF SP-IV, NOCA ATF SP-IV, HYUNDAI genuine ATF SP-IV	
	Nu 2.0			
	Theta II 2.4	6.7 l (7.08 US qt.)		
	R 2.0	8.3 l (8.77 US qt.)		
Dual clutch transmission fluid		1.9 l ~ 2.0 l (2.01~2.11 US qt.)	HK MTF 70W (SK) SPIRAX S6 GHME 70W (H.K.SHELL) GS MTF HD 70W (GS CALTEX) (API GL-4, SAE 70W)	
Engine coolant	Gamma 1.6 GDI	A/T	7.1 l (7.50 US qt.)	Mixture of antifreeze and water (Phosphate-based Ethylene glycol coolant for aluminum radiator)
		M/T	7.3 l (7.71 US qt.)	
	Gamma 1.6 T-GDI		7.2 l (7.61 US qt.)	
	Nu 2.0	A/T	6.9 l (7.29 US qt.)	
		M/T	7.0 l (7.40 US qt.)	
	Theta II 2.4	A/T	7.1 l (7.50 US qt.)	
	U2 1.7	M/T	7.1 l (7.50 US qt.)	
		DCT	7.5 l (7.93 US qt.)	
R 2.0		8.5~8.8 l (8.98~9.3 US qt.)		
Brake/Clutch fluid		0.7~0.8 l (0.74~0.85 US qt.)	FMVSS116 DOT-3 or DOT-4	

Lubricant		Volume	Classification
Rear differential oil (4WD)		0.53~0.63 l (0.56~0.67 US qt.)	
Transfer case oil (4WD)	Gamma 1.6 T-GDI/ Nu 2.0 (M/T * ⁶)	0.48~0.52 l (0.51~0.55 US qt.)	HYPOID GEAR OIL API GL-5, SAE75W/90 (SHELL HD AXLE OIL 75W90 or equivalent)
	R 2.0/Nu 2.0/ Theta II 2.4 (A/T * ⁷)	0.34~0.36 l (0.36~0.38 US qt.)	
Fuel		55 l (58.12 US qt.) * ⁸ 62 l (65.51 US qt.)	Refer to "Fuel requirements" in Foreword chapter

*¹ : Refer to the recommended SAE viscosity numbers on the next page.

*² : Engine oils labeled Energy Conserving Oil are now available. Along with other additional benefits, they contribute to fuel economy by reducing the amount of fuel necessary to overcome engine friction. Often, these improvements are difficult to measure in everyday driving, but in a year's time, they can offer significant cost and energy savings.

*³ : If the ACEA A5 engine oil is not available in your country, you are able to use ILSAC GF-3 (or above) or ACEA A3 (or above).

*⁴ : If the API service SM engine oil is not available in your country, you are able to use API service SL.

*⁵ : If the ACEA C2 or C3, B4 engine oil is not available in your country, you are able to use API CH-4 (or above).

*⁶ : Manual transaxle

*⁷ : Automatic transaxle

*⁸ : For U2 1.7 (M/T) lowest fuel consumption pack

Recommended engine oil (For Europe)

Supplier	Product	
	Gasoline Engine	Diesel Engine
Shell	HELIX ULTRA AH-E 5W-30	HELIX ULTRA AP 5W-30
	HELIX ULTRA 5W-40	HELIX ULTRA AP-L 5W-30

Recommended SAE viscosity number

⚠ CAUTION

Always be sure to clean the area around any filler plug, drain plug, or dipstick before checking or draining any lubricant. This is especially important in dusty or sandy areas and when the vehicle is used on unpaved roads. Cleaning the plug and dipstick areas will prevent dirt and grit from entering the engine and other mechanisms that could be damaged.

Engine oil viscosity (thickness) has an effect on fuel economy and cold weather operating (engine start and engine oil flowability). Lower viscosity engine oils can provide better fuel economy and cold weather performance, however, higher viscosity engine oils are required for satisfactory lubrication in hot weather. Using oils of any viscosity other than those recommended could result in engine damage.

When choosing an oil, consider the range of temperature your vehicle will be operated in before the next oil change. Proceed to select the recommended oil viscosity from the chart.

		Temperature Range for SAE Viscosity Numbers										
Temperature		°C	-30	-20	-10	0	10	20	30	40	50	
		(°F)	-10	0	20	40	60	80	100	120		
Gasoline Engine Oil	1.6 GDI, T-GDI										20W-50	
	2.0 MPI, 2.4 GDI (for Middle East, Morocco, Egypt)										15W-40	
											10W-30	
											5W-30, 5W-40	
		2.0 MPI (for Europe)										0W-40, 5W-20, 5W-30, 5W-40
Diesel Engine Oil											20W-50	
											15W-40	
											10W-30	
											5W-20, 5W-30	
											15W-40	
		1.7 TCI										10W-30
												5W-30
												0W-30
Diesel Engine Oil											15W-40	
											10W-30/40	
											5W-30/40	
		2.0 TCI									0W-30/40	

VEHICLE IDENTIFICATION NUMBER (VIN)

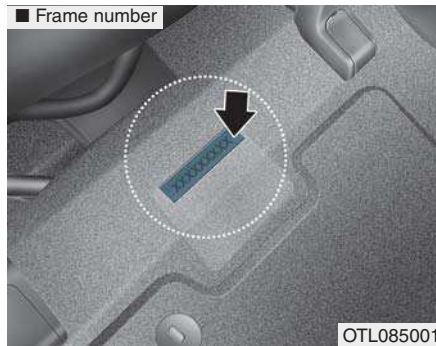

The vehicle identification number (VIN) is the number used in registering your vehicle and in all legal matters pertaining to its ownership, etc. The number is punched on the floor under the passenger seat. To check the number, open the cover.



The VIN is also on a plate attached to the top of the dashboard. The number on the plate can easily be seen through the windshield from outside.

FarmaSOS.com

VEHICLE CERTIFICATION LABEL

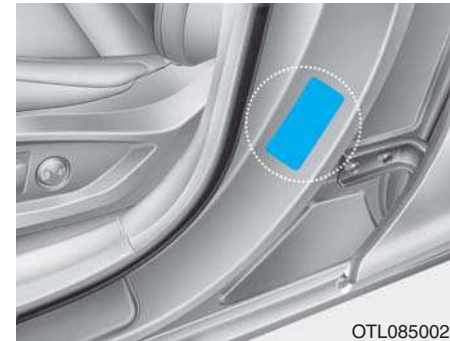

The vehicle certification label attached on the driver's (or front passenger's) side center pillar gives the vehicle identification number (VIN).

TIRE SPECIFICATION AND PRESSURE LABEL

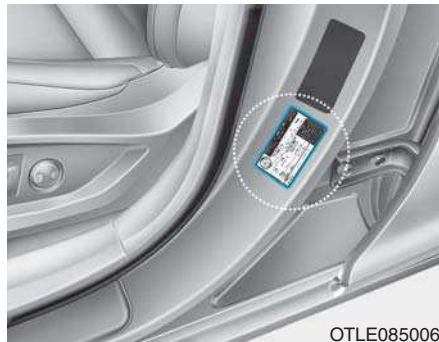

The tires supplied on your new vehicle are chosen to provide the best performance for normal driving.

The tire label located on the driver's side center pillar gives the tire pressures recommended for your vehicle.

ENGINE NUMBER

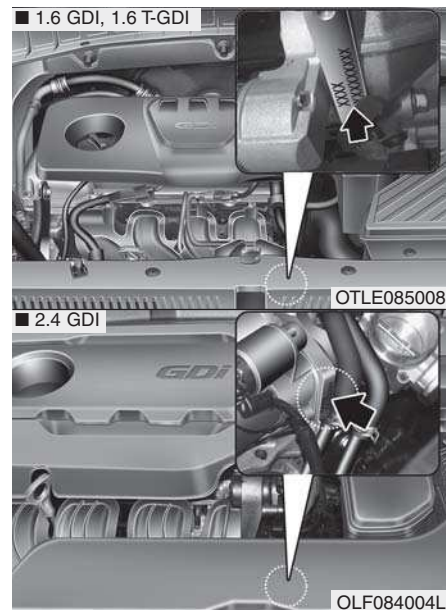
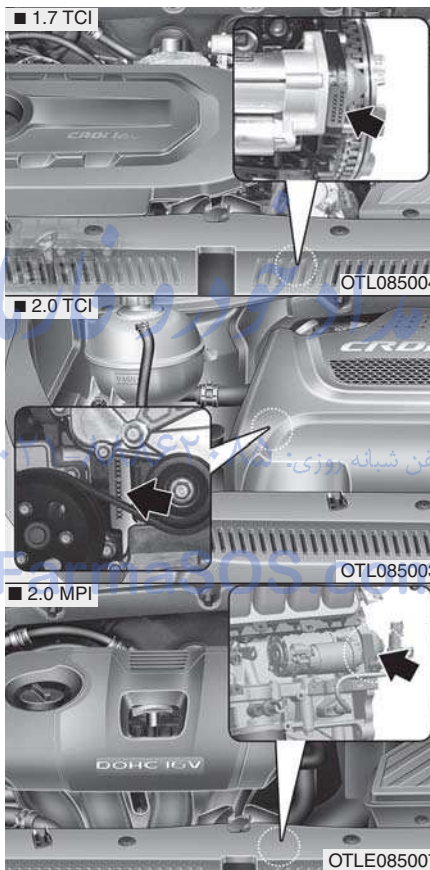

The engine number is stamped on the engine block as shown in the drawing.

AIR CONDITIONER COMPRESSOR LABEL



A compressor label informs you the type of compressor your vehicle is equipped with such as model, supplier part number, production number, refrigerant (1) and refrigerant oil (2).

REFRIGERANT LABEL

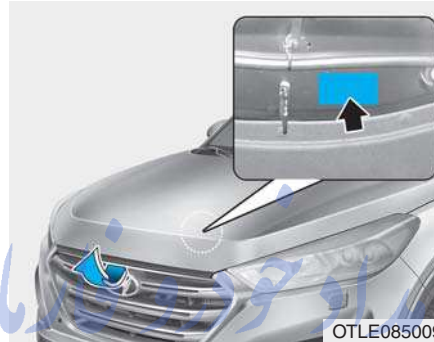

The refrigerant label provides information such as refrigerant type and amount. The label is located on the underside of the hood.

DECLARATION OF CONFORMITY (IF EQUIPPED)

■ Example

CE CE 0678

CE0678

The radio frequency components of the vehicle comply with requirements and other relevant provisions of Directive 1995/5/EC.

Further information including the manufacturer's declaration of conformity is available on HYUNDAI web site as follows;

<http://service.hyundai-motor.com>

FarmaSOS.com

امداد خودرو فارما

تلفن شبانه روزی: ۰۲۱-۸۸۸۶۲۰۸۵

FarmaSOS.com

A

Adjusting the outside rearview mirror	3-30	Appearance care	
Air bag warning labels	2-69	Exterior care.....	7-93
Air bags.....	2-50	Interior care.....	7-99
Additional safety precautions	2-69	Ashtray.....	3-186
Air bag warning labels.....	2-69	Audio	
Curtain air bags.....	2-56	Audio head unit	4-15
Do not install a child restraint on the front passenger seat	2-62	Audio setup.....	4-19
Driver's air bag.....	2-52	<i>Bluetooth</i> [®] Wireless Technology	4-37
How does the air bags system operate?.....	2-57	Radio.....	4-28
Passenger's front air bag	2-52	USB / iPod [®] / My Music	4-32
Passenger's front air bag ON/OFF switch	2-53	Voice recognition	4-41
Side air bags.....	2-54	Auto defogging system.....	3-181
SRS Care.....	2-68	Auto door lock/unlock features	3-18
What to expect after an air bag inflates.....	2-61	Auto hold	5-49
Where are the air bags?	2-52	Auto light position.....	3-109
Why didn't my air bag go off in a collision	2-63	Auto stop time	3-90
Air cleaner	7-40	Automatic climate control system.....	3-165
Air conditioner compressor label	8-13	Air conditioning.....	3-172
Air ventilation seat (Front).....	2-22	Automatic heating and air conditioning	3-166
Airconditioning system		Climate control air filter	3-175
Automatic climate control system	3-172	Manual heating and air conditioning	3-167
Manual climate control system.....	3-159	Automatic transaxle.....	5-24
Antenna.....	4-3	Shift lock system	5-28
Anti-lock brake system (ABS).....	5-53	Automatic ventilation	3-182
		Autonomous emergency braking (AEB).....	5-90
		AUX, USB and iPod port.....	4-2

B

Battery.....7-44
Before driving.....5-4
Blind spot detection system.....5-82
Bluetooth[®] Wireless Technology.....4-37
Brake system.....5-40
 Anti-lock brake system (ABS).....5-53
 Auto hold.....5-49
 Downhill brake control (DBC).....5-61
 Electronic parking brake (EPB).....5-43
 Electronic stability control (ESC).....5-55
 Emergency stop signal (ESS).....5-63
 Hill-start assist control (HAC).....5-60
 Parking brake (Manual).....5-41
 Power brakes.....5-40
 Vehicle stability management.....5-59
Brake/clutch fluid.....7-35
Bulb replacement.....7-75
Bulb wattage.....8-3
Button start/stop, see engine start/stop button.....5-11

C

Capacities (Lubricants).....8-7
Care
 Tire care.....7-48
 Exterior care.....7-89
 Interior care.....7-99
Cargo security screen.....3-194
Center console storage.....3-178
Central door lock switch.....3-17
Certification label.....8-11
Chains
 Tire chains.....5-134
Checking tire inflation pressure.....7-50
Child restraint system (CRS).....2-38
 Children always in the rear.....2-38
 Installing a Child Restraint System (CRS).....2-41
 Selecting a Child Restraint System (CRS).....2-39
Child-protector rear door lock.....3-19
Cigarette lighter.....3-190
Climate control air filter.....3-162, 175
Climate control air filter replacement.....7-39
Clock.....3-190
Clothes hanger.....3-192
Cluster ionizer.....3-182
Combined instrument, see instrument cluster.....3-60
Compact spare tire.....6-22
Compass with Electric chromic mirror.....3-26

Index

Cool box	3-184
Coolant.....	7-31
Cooling fluid, see engine coolant.....	7-31
Crankcase emission control system.....	7-90
Cruise control system	
With speed limit control	5-117
Without speed limit control	5-122
Cup holder	3-186
Curtain air bags.....	2-56

D

Dashboard illumination, see instrument panel illumination.....	3-62
Dashboard, see instrument cluster.....	3-60
Day/night rearview mirror.....	3-25
Daytime running light.....	3-114
Deadlocks	3-18
Declaration of conformity	8-13
Defogging (Windshield)	3-178
Defroster	3-152
Front wiper deicer.....	3-153
Outside mirror defroster	3-153
Rear window defroster.....	3-152
Defrosting (Windshield).....	3-178
Digital speedometer.....	3-91
Dimensions	8-2
Display illumination, see instrument panel illumination.....	3-62
Displays, see instrument cluster.....	3-60
Do not install a child restraint on the front passenger seat.....	2-62
Door locks.....	3-14
Auto door lock/unlock features	3-18
Central door lock switch.....	3-17
Child-protector rear door lock	3-19
Deadlocks.....	3-18
Downhill brake control (DBC).....	5-61
Drinks holders, see cup holders.....	3-186
Drive mode integrated control system	5-80
Driver assist system.....	3-126
Parking assist system	3-131
Rear parking assist system.....	3-127
Rear view camera	3-126
Smart parking assist system.....	3-134
Driver's air bag	2-52
Driving at night.....	5-130
Driving in flooded areas.....	5-131
Driving in the rain	5-130
Dual clutch transmission	5-31
Shift lock system	5-37

E

Electric chromic mirror (ECM).....	3-26
Electric chromic mirror (ECM) with compass.....	3-26
Electric power steering.....	3-22
Electronic parking brake (EPB).....	5-43
Electronic stability control (ESC).....	5-55
Emergency commodity.....	6-37
Emergency stop signal (ESS).....	5-63
Emission control system.....	7-90
Crankcase emission control system.....	7-90
Evaporative emission control System.....	7-90
Exhaust emission control system.....	7-101
Engine.....	8-2
Engine compartment.....	1-6, 7-3
Engine coolant.....	7-31
Engine coolant temperature gauge.....	3-63
Engine number.....	8-12
Engine oil.....	7-28
Engine Start/Stop button.....	5-11
Evaporative emission control System.....	7-90
Exhaust emission control system.....	7-101
Explanation of scheduled maintenance items.....	7-24
Exterior care.....	7-93
Exterior features	
Fuel filler door.....	3-44
Hood.....	3-42
Roof rack.....	3-198
Exterior lights.....	3-109

F

Flat tire	
Changing tires.....	6-18
Compact spare tire.....	6-22
Flat tire	
Jack and tools.....	6-17
With spare tire.....	6-15
With Tire Mobility Kit (TMK).....	6-25
Flex steering wheel.....	5-78
Floor mat anchor(s).....	3-193
Fluid	
Brake/clutch fluid.....	7-35
Washer fluid.....	7-36
Fog lamp (Front).....	3-112
Fog lamp (Rear).....	3-112
Folding the outside rearview mirror.....	3-31
Four wheel drive (4WD).....	5-65
Front lamps (Interior).....	3-118
Front seats.....	2-6
Fuel Economy.....	3-89
Fuel filler door.....	3-44
Fuel filter.....	7-37
Fuel gauge.....	3-64
Fuel gauge.....	3-64
Fuel requirements.....	F-6
Fuse switch.....	7-63

Index

Fuses	7-60
Fuse switch	7-63
Fuse/relay panel description	7-65
Main fuse	7-64
Multi fuse.....	7-64

G

Gauges	3-63
Glove box	3-184
Glove box lamp	3-120
Gross vehicle weight	8-6

H

Hazardous driving conditions.....	5-129
Headlamp and fog lamp aiming	7-82
Headlamp washer.....	3-115
Headlight leveling device	3-114
Headrest	2-16
Heated steering wheel.....	3-24
Heater	
Automatic climate control system.....	3-165
Manual climate control system.....	3-154
High beam operation	3-110
High mounted stop lamp replacement.....	7-90
Highway driving.....	5-131

Hill-start assist control (HAC)	5-60
Hood	3-42
Horn	3-24
How to use this manual.....	F-5
How vehicle audio works.....	4-6

I

Icy road warning light	3-65
Idle stop and go (ISG) system.....	5-72
If the engine overheats	6-8
If the engine stalls at a crossroad or crossing	6-3
If the engine stalls while driving.....	6-2
If the engine will not start	6-4
If you have a flat tire	6-17
If you have a flat tire while driving	6-3
Ignition switch.....	5-6
Engine Start/Stop button.....	5-11
Key ignition switch.....	5-6
Immobilizer system	3-13
Important safety precautions	2-2
Air bag hazards.....	2-2
Always wear your seat belt.....	2-2
Control your speed.....	2-3
Don't drink or take drugs and drive.....	2-2
Driver distraction	2-2
Keep your vehicle in safe condition	2-3
Restrain all children.....	2-2

In case of emergency while driving	6-2
Indicator lights	3-102
Inside rearview mirror	3-25
Instrument cluster	3-60
Gauges	3-63
Instrument panel illumination.....	3-62
LCD Display Control.....	3-69
Transaxle shift indicator	3-66
Instrument panel overview	1-4, 5
Interior care.....	7-99
Interior features	
Ashtray.....	3-186
Cargo security screen.....	3-194
Cigarette lighter	3-190
Clock	3-190
Clothes hanger	3-192
Cup holder	3-186
Floor mat anchor(s)	3-193
Luggage net (holder)	3-193
Luggage tray	3-197
Power outlet	3-188
Sunvisor	3-188
Interior lamp AUTO cut	3-117
Interior light	3-117
Front lamps	3-118
Glove box lamp	3-120
Interior lamp AUTO cut.....	3-117
Puddle lamp	3-121

Rear lamps	3-119
Tailgate room lamp	3-119
Vanity mirror lamp.....	3-120
Interior light bulb replacement	7-91
Interior overview	1-2, 3

J

Jack and tools	6-17
Jack label	6-23
Jump starting.....	6-4

K

Keys	3-4
------------	-----

L

Label	
Air conditioner compressor label	8-13
Refrigerant label	8-13
Tire sidewall labeling.....	7-54
Tire specification and pressure label	8-12
Vehicle certification label	8-11
Lane keeping assist system (LKAS)	5-106
LCD display.....	3-69
LCD modes.....	3-69
User Settings Mode	3-74
Warning Messages	3-78

LCD display control	3-69
LCD modes.....	3-69
License plate light bulb replacement.....	7-90
Light	
Auto light position	3-109
Daytime running light.....	3-114
Exterior lights	3-109
Front fog lamp	3-112
Headlamp washer.....	3-115
Headlight leveling device	3-114
High beam operation.....	3-110
Interior lights.....	3-117
Rear fog lamp.....	3-112
Turn signals.....	3-111
Welcome system	3-116
Light bulb replacement.....	7-75
Lubricants and capacities	8-7
Luggage net (holder)	3-193
Luggage tray	3-197
Luggage volume	8-6

M

Main fuse	7-64
Maintenance	
Explanation of scheduled maintenance items.....	7-24
Maintenance services.....	7-6
Owner maintenance	7-7
Scheduled maintenance service	7-10
Tire maintenance.....	7-54
Maintenance schedule.....	7-10
Maintenance services.....	7-6
Manual climate control system.....	3-154
Air conditioning.....	3-159
Climate control air filter	3-162
Heating and air conditioning	3-154
Manual transaxle.....	5-20
Mirrors	3-25
Adjusting the outside rearview mirror.....	3-30
Day/night rearview mirror	3-25
Electric chromic mirror (ECM).....	3-26
Electric chromic mirror (ECM) with compass.....	3-26
Folding the outside rearview mirror	3-31
Inside rearview mirror	3-25
Outside rearview mirror.....	3-29
Moonroof, see panorama sunroof.....	3-37
Multi fuse.....	7-64

Multimedia system	4-2
Antenna	4-3
AUX, USB and iPod port	4-2
Steering wheel audio control	4-4

N

Non-power tailgate	3-47
--------------------------	------

O

Odometer	3-68
Oil (Engine)	7-28
One time driving information mode	3-91
Outside rearview mirror	3-29
Outside temperature gauge	3-65
Owner maintenance	7-7

P

Panorama sunroof	3-37
Parking assist system	3-131
Parking brake (manual)	5-41
Passenger's front air bag	2-52
Passenger's front air bag ON/OFF switch	2-53
Power brakes	5-40
Power outlet	3-188
Power tailgate	3-49
Power window lock switch	3-37
Puddle lamp	3-121

R

Rear combination light bulb replacement	7-87
Rear lamps	3-119
Rear parking assist system	3-127
Rear seats	2-13
Rear view camera	3-126
Rear window wiper and washer	3-125
Recommended cold tire inflation pressures	7-48
Recommended lubricants and capacities	8-7
Recommended SAE viscosity number	8-10
Reducing the risk of a rollover	5-132
Refrigerant label	8-13
Remote key	3-4
Returning used vehicles	F-11
Rocking the vehicle	5-129
Roof rack	3-198
Rotation (Tire)	7-51

FarmaSOS.com

S

- Scheduled maintenance service 7-10
- Seat belts 2-24
- Additional seat belt safety precautions 2-34
 - Care of seat belts 2-37
 - Pre-tensioner seat belt 2-32
 - Rear center seatbelt 2-30
 - Seat belt restraint system 2-28
 - Seat belt safety precautions 2-24
 - Seat belt warning light 2-25
- Seat warmers (Front) 2-20
- Seat warmers (Rear) 2-23
- Seats 2-4
- Front air ventilation seat 2-22
 - Front seat warmers 2-20
 - Front seats 2-6
 - Headrest 2-16
 - Rear seat warmers 2-23
 - Rear seats 2-13
 - Safety precautions 2-5
- Shift lock system 5-28, 37
- Side air bags 2-54
- Side repeater lamp replacement 7-81
- Smart key 3-8
- Smart parking assist system 3-134
- Smart tailgate 3-56
- Smooth cornering 5-130
- Snow tires 5-133
- Spare tire
- Changing tires 6-18
 - Compact spare tire 6-22
- Special driving conditions 5-129
- Driving at night 5-130
 - Driving in flooded areas 5-131
 - Driving in the rain 5-130
 - Hazardous driving conditions 5-129
 - Highway driving 5-131
 - Reducing the risk of a rollover 5-132
 - Rocking the vehicle 5-129
 - Smooth cornering 5-130
- Speed limit control system 5-115
- Speed limit information function (SLIF) 5-101
- Speedometer 3-63
- Starting difficulties, see engine will not start 6-4
- Steering wheel 3-22
- Electric power steering 3-22
 - Heated steering wheel 3-24
 - Horn 3-24
 - Tilt steering/Telescope steering 3-23
- Steering wheel audio control 4-4
- Storage compartment 3-183
- Center console storage 3-183
 - Cool box 3-184
 - Glove box 3-184
 - Sunglass holder 3-184

Sunroof inside air recirculation	3-182
Sunroof, see panorama sunroof	3-37
Sunvisor	3-188

T

Tachometer	3-63
Tailgate	3-47
Non-power tailgate	3-47
Power tailgate	3-49
Smart tailgate	3-56
Tailgate room lamp	3-119
Theft-alarm system	3-20
Tilt steering/Telescope steering	3-23
Tire chains	5-134
Tire pressure monitoring system (TPMS)	6-9
Tire rotation	7-51
Tire specification and pressure label	8-12
Tires and wheels	7-48
Checking tire inflation pressure	7-50
Recommended cold tire inflation pressures	7-48
Tire care	7-48
Tire maintenance	7-54
Tire replacement	7-52
Tire rotation	7-51
Tire sidewall labeling	7-54
Tire traction	7-54
Wheel alignment and tire balance	7-52
Wheel replacement	7-54

Tires and wheels specification	8-4
Tire Mobility Kit (TMK)	6-25
Towing	6-33
Trailer towing	5-138
Transaxle	
Automatic transaxle	5-24
Dual clutch transmission	5-31
Manual transaxle	5-20
Transaxle shift indicator	3-66
Trip A/B	3-87
Trip computer	3-87
Fuel Economy	3-89
Trip A/B	3-87
Turn signals	3-111

U

User Settings Mode	3-74
--------------------------	------

V

Vanity mirror lamp3-120
Vehicle break-in process..... F-11
Vehicle certification label8-11
Vehicle handling instructionsF-10
Vehicle identification number (VIN).....8-11
Vehicle stability management.....5-59
Vehicle weight5-148
Voice Recognition.....4-41

W

Warning lights.....3-92
Warning Messages - LCD display.....3-78
Washer fluid.....7-36
Welcome system3-116
Wheel alignment and tire balance7-52
Wheel replacement7-54
Windows3-32
 Power window lock switch.....3-35
Windshield defrosting and defogging3-178
Windshield washers (Front).....3-122
Windshield wipers (Front).....3-122
Winter driving.....5-133
 Snow tires5-133
 Tire chains.....5-134
Wiper blades7-41

Wipers and washers3-122
Rear window wiper and washer3-125
Windshield washers (Front).....3-122
Windshield wipers (Front).....3-122

امداد خودرو فارما

تلفن شبانه روزی: ۰۲۱-۸۸۵۲۰۸۵

FarmaSOS.com