

# Foreword

Welcome to the growing family of new NISSAN owners. This vehicle has been delivered to you with confidence. It has been produced using the latest techniques and strict quality control.

This manual was prepared to help you understand the operation and maintenance of your vehicle so that you may enjoy many kilometers (miles) of driving pleasure. Please read through this manual before operating your vehicle.

A separate Warranty Information & Maintenance Booklet explains details about the warranties covering your vehicle.

Your NISSAN dealer knows your vehicle best. When you require any service or have any questions, we will be glad to assist you with the extensive resources available for you.

## IMPORTANT SAFETY INFORMATION

### Reminders for safety!

Follow these important driving rules to help ensure a safe and complete trip for you and your passengers!

- **NEVER drive under the influence of alcohol or drugs.**
- **ALWAYS observe posted speed limits and never drive too fast for conditions.**
- **ALWAYS use your seat belts and appropriate child restraint systems. Preteen children should be seated in the rear seat.**
- **ALWAYS provide information about the proper use of vehicle safety features to all occupants of the vehicle.**
- **ALWAYS review this Owner's Manual for important safety information.**

### When reading the manual

This manual includes information for all options available on this model. Therefore, you may find some information that does not apply to your vehicle.

All information, specifications and illustrations in this manual are those in effect at the time of printing. NISSAN reserves the right to change specifications or designs without notice and without obligation.

## MODIFICATION OF YOUR VEHICLE

This vehicle should not be modified. Modification could affect its performance, safety or durability, and may even violate governmental regulations. In addition, damage or performance problems resulting from modifications may not be covered under NISSAN warranties.

### Read first — then drive safely

Before driving your vehicle, read this Owner's Manual carefully. This will ensure familiarity with controls and maintenance requirements, assisting you in the safe operation of your vehicle.

Throughout this manual we have used the symbol  followed by the word **WARNING**. This is used to indicate the presence of a hazard that could cause death or serious personal injury. To avoid or reduce the risk, the procedures must be followed precisely.

The symbol  followed by the word **CAUTION** is also used throughout this manual to indicate the presence of a hazard that could cause minor or moderate personal injury or damages to your vehicle. To avoid or reduce the risk, the procedures must be followed carefully.

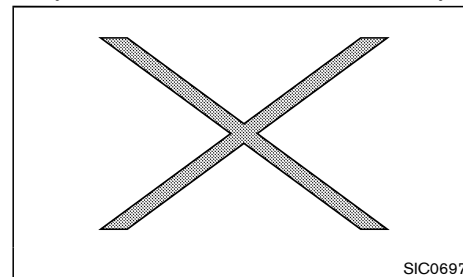

If you see this symbol, it means “**Do not do this**” or “**Do not let this happen**”.

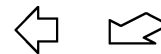

If you see a symbol similar to these in an illustration, it means the arrow points to the front of the vehicle.



Arrows in an illustration that are similar to these indicate movement or action.



Arrows in an illustration that are similar to these call attention to an item in the illustration.

**Air bag warning labels:**

“NEVER use a rearward facing child restraint on a seat protected by an ACTIVE AIRBAG in front of it, DEATH or SERIOUS INJURY to the CHILD can occur.”

Be sure to read “Air bag warning labels” (P.1-30).

**Trademarks:**

Bluetooth® is a trademark owned by Bluetooth SIG, Inc. and licensed to Visteon Corporation and Bosch.

**ON-PAVEMENT AND OFF-ROAD DRIVING (4WD model)**

This vehicle will handle and maneuver differently from an ordinary passenger car, because it has a higher center of gravity. As with other vehicles with features of this type, failure to operate this vehicle correctly may result in loss of control or an accident.

Be sure to read the “On-pavement and off-road driving precautions” (P.5-7) of this manual.

© 2014 NISSAN MOTOR CO., LTD.

# Table of Contents

<b>Illustrated table of contents</b>	<b>0</b>
<b>Safety — seats, seat belts and supplemental restraint system</b>	<b>1</b>
<b>Instruments and controls</b>	<b>2</b>
<b>Pre-driving checks and adjustments</b>	<b>3</b>
<b>Display screen, heater and air conditioner, and audio system</b>	<b>4</b>
<b>Starting and driving</b>	<b>5</b>
<b>In case of emergency</b>	<b>6</b>
<b>Appearance and care</b>	<b>7</b>
<b>Maintenance and do-it-yourself</b>	<b>8</b>
<b>Technical information</b>	<b>9</b>
<b>Index</b>	<b>10</b>

(2,1)

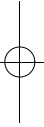
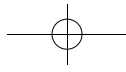
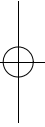
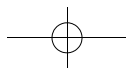



# 0 Illustrated table of contents

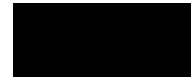

Seats, seat belts and Supplemental Restraint System (SRS) ....	0-2	Instrument panel .....	0-8
Exterior front .....	0-3	Left-Hand Drive (LHD) model .....	0-8
Exterior rear .....	0-4	Right-Hand Drive (RHD) model .....	0-9
Passenger compartment .....	0-5	Meters and gauges .....	0-10
Cockpit .....	0-6	Engine compartment .....	0-11
Left-Hand Drive (LHD) model .....	0-6	QR25DE engine model .....	0-11
Right-Hand Drive (RHD) model .....	0-7	MR20DD engine model .....	0-12
		R9M engine model .....	0-13

## SEATS, SEAT BELTS AND SUPPLEMENTAL RESTRAINT SYSTEM (SRS)

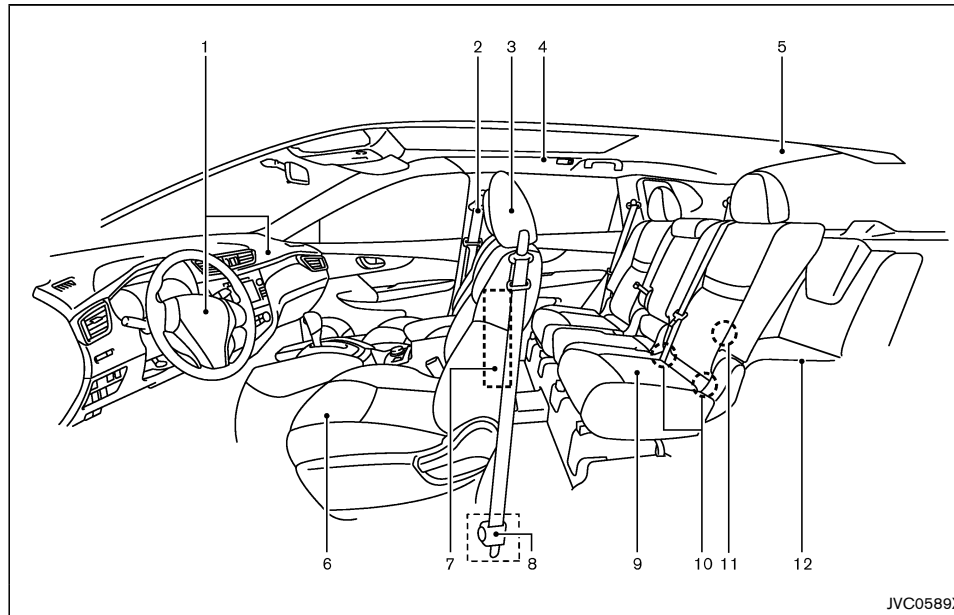

JVC0589X

- |  |  |
|--|--|
| 1. Supplemental front-impact air bags (Page 1-27)                                | 8. Pre-tensioner seat belt system (P.1-36)                                       |
| 2. Seat belts (P.1-9)  | 9. Second row seats (P.1-5)  |
| 3. Head restraints (P.1-7)   | — Child restraints (P.1-14)  |
| 4. Supplemental curtain side-impact air bags* (P.1-27)                           | 10. ISOFIX child restraint system (for second row seats) (P.1-19)                |
| 5. Child restraint anchor point (for top tether strap child restraint)* (P.1-20) | 11. Child restraint anchor point (for top tether strap child restraint) (P.1-20) |
| 6. Front seats (P.1-2)   | 12. Third row seats* (P.1-6)   |
| 7. Supplemental side-impact air bags* (P.1-27)                                   | *: if equipped   |

### 0-2 Illustrated table of contents

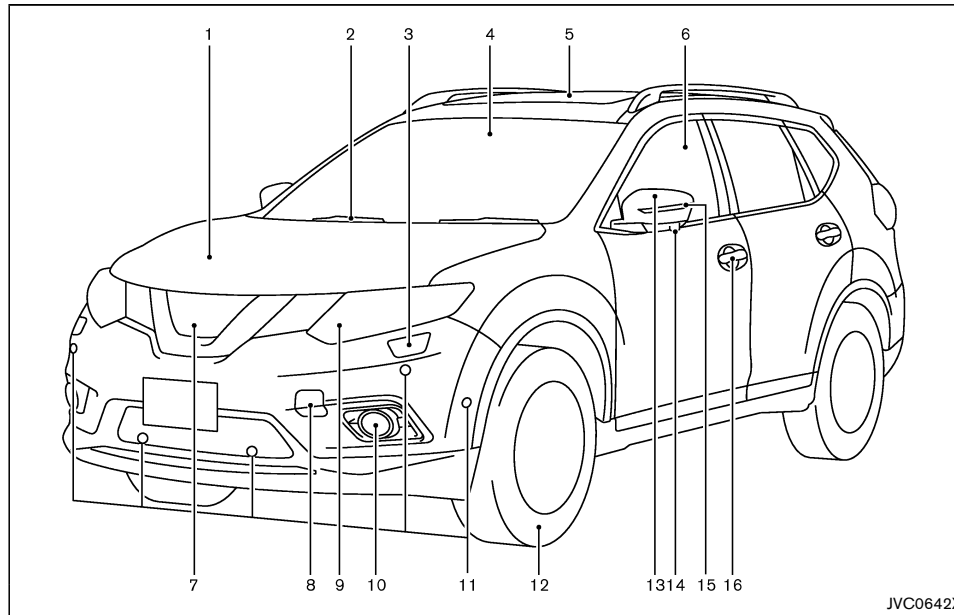
**EXTERIOR FRONT**

- |   |  |
|---|--|
| 1. Engine hood (P.3-22)   | 8. Recovery hook (P.6-12)  |
| 2. Windshield wiper and washer<br>— Switch operation (P.2-47)<br>— Window washer fluid (P.8-19) | 9. Headlights and turn signal lights (P.2-39)  |
| 3. Headlight cleaner* (P.2-44)  | 10. Fog lights* (P.2-45)   |
| 4. Front camera* (P.4-10, 2-37, 5-39)   | 11. Sonar (parking sensor) system* (P.5-50)<br>— Park Assist (PA)* (P.4-17)                    |
| 5. Sunroof* (P.2-52)  | 12. Tires<br>— Tires and wheels (P.8-36, 9-7)<br>— Flat tire (P.6-2)<br>— Tire placard (P.9-9) |
| 6. Power windows (P.2-50)   |  |
| 7. Front view camera* (P.4-10)  |  |

- 13. Outside mirrors (P.3-29)
- 14. Side view camera\* (P.4-10)
- 15. Side turn signal light (P.2-44)
- 16. Doors
  - Keys (P.3-2)
  - Door locks (P.3-4)
  - Intelligent Key system\* (P.3-10)
  - Remote keyless entry system\* (P.3-7)
  - Security system (P.3-20)

\*: if equipped

**Illustrated table of contents 0-3**

## EXTERIOR REAR

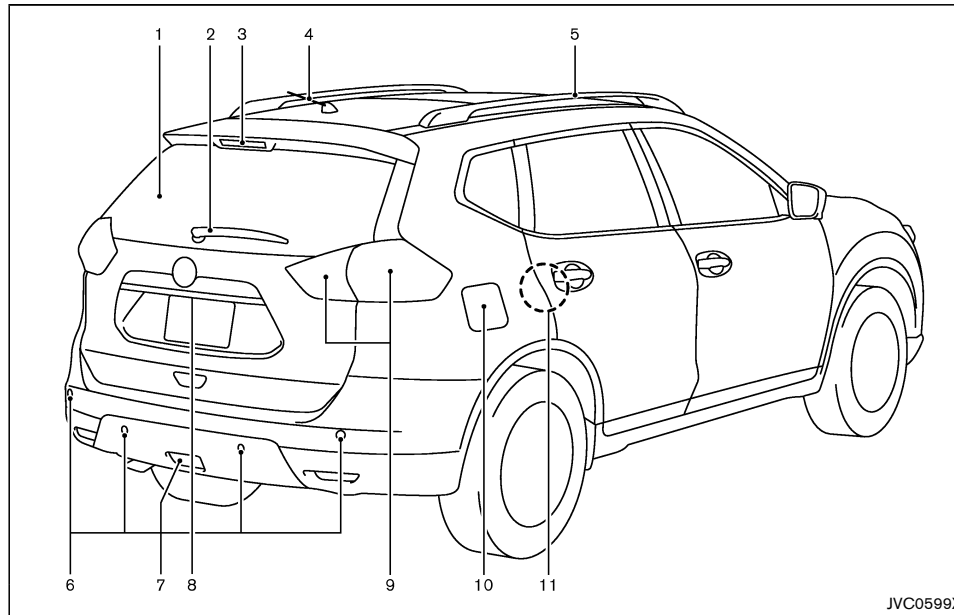

JVC0599X

- |  |  |
|--|--|
| 1. Rear window defogger (P.2-49)   | 7. Rear fog light* (P. 2-46)   |
| 2. Rear window wiper and washer<br>— Switch operation (P.2-49)<br>— Window washer fluid (P.8-19) | 8. Back door (P.3-23)<br>— Intelligent Key system* (P.3-10)<br>— Remote keyless entry system* (P.3-7)<br>— Rear view camera* (P.4-7, P.4-10) |
| 3. High-mounted stop light<br>— Bulb replacement (P.8-28)  | 9. Rear combination light (P. 8-27)  |
| 4. Antenna (P.4-43)  | 10. Fuel filler lid (P.3-27)   |
| 5. Roof rail* (P.2-60)   | 11. Child safety rear door locks (P.3-7)   |
| 6. Parking sensor (sonar) system* (P. 5-50)<br>— Park Assist (PA)* (P.4-17)                      |  |

\*: if equipped

### 0-4 Illustrated table of contents

## PASSENGER COMPARTMENT

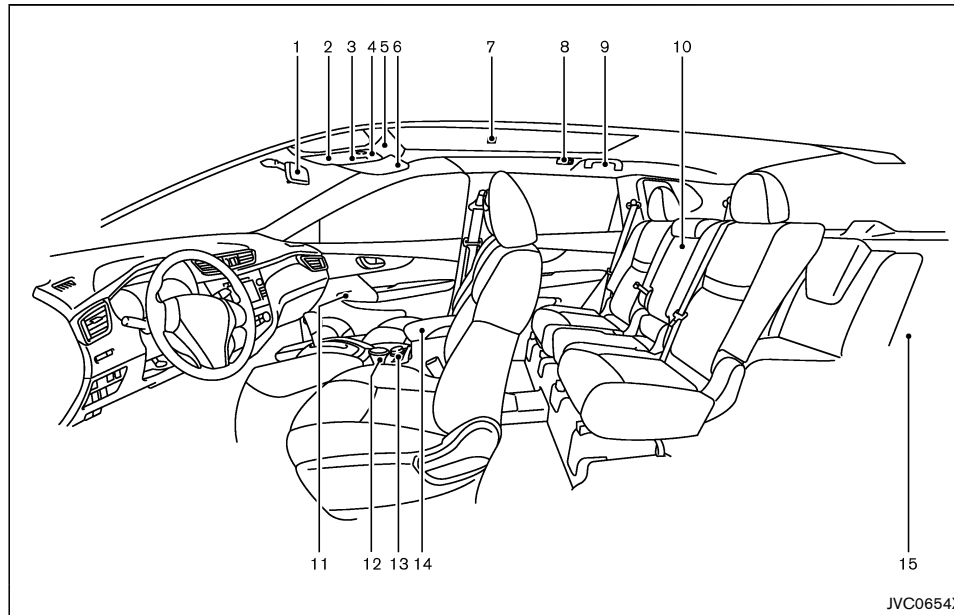

12. Front cup holders (P.2-55)/Ashtray\* (P.2-54)
13. Heated seat switch\* (P.1-4)
14. Console box (P.2-55)
15. Luggage room
  - Storages (P.2-54)
  - Luggage hooks (P.2-57)
  - Tonneau cover\* (P.2-60)
  - Power outlet (P.2-53)
  - Spare tire (P.6-2)

\*: if equipped

- |  |  |
|--|--|
| 1. Inside rearview mirror (P.3-28)                         | 7. Room light* (P.2-62)  |
| 2. Sunglasses holder (P.2-55)                              | 8. Rear personal lights* (P.2-63)  |
| 3. Front map lights (P.2-62)                               | 9. Coat hook (Driver's side) (P.2-59)                                    |
| — Microphone* (P.4-78, P.4-84, P.4-87, P.4-94, P.4-98)     | 10. Rear armrest (Second row seats) (P.1-7)                              |
| 4. Sunroof* (P.2-52)                                       | — Rear cup holders (P.2-55)  |
| 5. Cancel switch for ultrasonic and tilt sensors* (P.3-20) | 11. Door armrest   |
| 6. Sun visors (P.2-61, P.3-29)                             | — Power window switch (P.2-50)   |
|  | — Power door lock switch* (P.3-6)  |
|  | — Outside rearview mirror remote control switch (Driver's side) (P.3-29) |

**Illustrated table of contents 0-5**

## COCKPIT

### LEFT-HAND DRIVE (LHD) MODEL

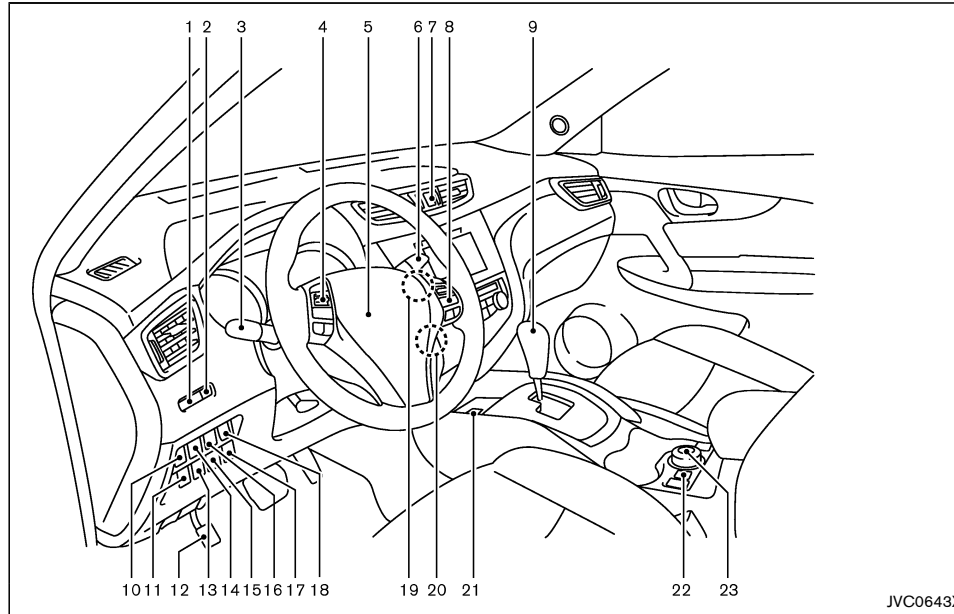

- |  |  |  |
|--|--|--|
| 1. Instrument brightness control (P.2-10)                                  | — Bluetooth® Hands-Free Phone System (with-<br>out navigation)* (P.4-78, P.4-84, P.4-87) | 8. Steering-wheel-mounted controls (right side)  |
| 2. TRIP RESET switch (P.2-7, P.2-8)  | — Bluetooth® Hands-Free Phone System (with<br>navigation)* (P.4-94)                      | — Cruise control switches* (P.5-43)  |
| 3. Headlight and turn signal switch (P.2-39)/Fog<br>light switch* (P.2-45) | 5. Steering wheel (P.3-28)   | — Speed limiter switches* (P.5-41)   |
| 4. Steering-wheel-mounted controls (left side)                             | 6. Wiper and washer switch (P.2-47)  | — Bluetooth® Hands-Free Phone System (with-<br>out navigation)* (P.4-78, P.4-84, P.4-87)                     |
| — Audio control* (P.4-76 or Navigation system<br>**)                       | 7. Hazard indicator flasher switch (P.6-2)   | — Bluetooth® Hands-Free Phone System (with<br>navigation)* (P.4-94)  |
| — Vehicle information display control (P.2-20)                             |  | — Voice recognition system switch* (P.4-98)  |
|  |  | 9. Shift lever   |
|  |  | — Continuously Variable Transmission (CVT)<br>(P.5-13)   |
|  |  | — Manual Transmission (MT) (P.5-17)  |
|  |  | 10. Vehicle Dynamic Control (VDC) OFF switch or<br>Electronic Stability Program (ESP) OFF switch<br>(P.5-27) |
|  |  | 11. Headlight aiming control switch* (P.2-42)  |
|  |  | 12. Parking brake (Pedal type)* (P.3-30)   |
|  |  | 13. ECO switch* (P.5-47)   |
|  |  | 14. Headlight cleaner switch* (P.2-44)   |
|  |  | 15. Parking sensor (sonar) system OFF switch*<br>(P.5-51)  |
|  |  | 16. Power back door switch* (P.3-24)   |
|  |  | 17. Stop/Start OFF switch* (P.5-21)  |
|  |  | 18. Power back door main switch* (P.3-24)  |
|  |  | 19. Push-button ignition switch (model with Intelli-<br>gent Key system)* (P.5-9)                            |
|  |  | 20. Ignition switch (model without Intelligent Key<br>system)* (P.5-7)                                       |
|  |  | 21. Parking brake (Switch type)* (P.3-30)  |
|  |  | 22. Hill descent control switch* (P.5-30)  |
|  |  | 23. Four-Wheel Drive (4WD) mode switch* (P.5-22)   |

\*: if equipped

\*\* : See the separate Navigation System Owner's  
Manual (if equipped).

### 0-6 Illustrated table of contents

## RIGHT-HAND DRIVE (RHD) MODEL

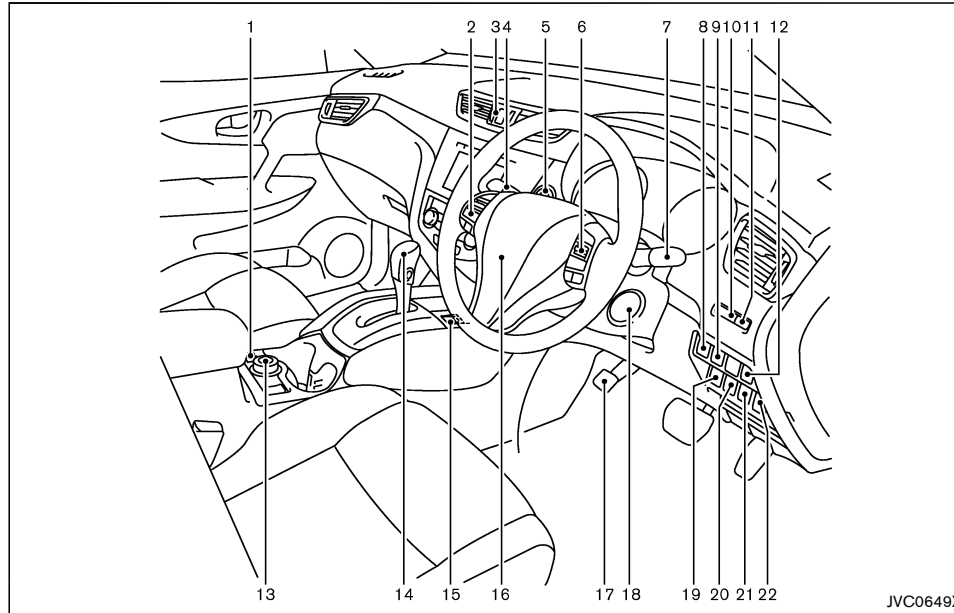

- |   |  |   |
|---|--|---|
| <p>1. Hill descent control switch* (P.5-30)</p> <p>2. Steering-wheel-mounted controls (left side)</p> <ul style="list-style-type: none"> <li>— Audio control* (P.4-76 or Navigation system**)</li> <li>— Vehicle information display control (P.2-20)</li> <li>— Bluetooth® Hands-Free Phone System (without navigation)* (P.4-78, P.4-84)</li> <li>— Bluetooth® Hands-Free Phone System (with navigation)* (P.4-94)</li> </ul> | <p>3. Hazard indicator flasher switch (P.6-2)</p> <p>4. Headlight and turn signal switch (P.2-39)/Fog light switch* (P.2-45) or Wiper and washer switch (P.2-47)</p> <p>5. Push-button ignition switch (model with Intelligent Key system)* (P.5-9)</p> <p>6. Steering-wheel-mounted controls (right side)</p> <ul style="list-style-type: none"> <li>— Cruise control switches* (P.5-43)</li> <li>— Speed limiter switches* (P.5-41)</li> </ul> | <ul style="list-style-type: none"> <li>— Bluetooth® Hands-Free Phone System (without navigation)* (P.4-78, P.4-84)</li> <li>— Bluetooth® Hands-Free Phone System (with navigation)* (P.4-94)</li> <li>— Voice recognition system switch* (P.4-98)</li> </ul> <p>7. Wiper and washer switch (P.2-47) or Headlight and turn signal switch (P.2-39)/Fog light switch* (P.2-45)</p> <p>8. Power back door main switch* (P.3-24)</p> <p>9. Power back door switch* (P.3-24)</p> <p>10. Instrument brightness control (P.2-10)</p> <p>11. TRIP RESET switch (P.2-7, P.2-8)</p> <p>12. Vehicle Dynamic Control (VDC) OFF switch or Electronic Stability Program (ESP) OFF switch (P.5-27)</p> <p>13. Four-Wheel Drive (4WD) mode switch* (P.5-22)</p> <p>14. Shift lever</p> <ul style="list-style-type: none"> <li>— Continuously Variable Transmission (CVT) (P.5-13)</li> <li>— Manual Transmission (MT) (P.5-17)</li> </ul> <p>15. Parking brake (Switch type)* (P.3-30)</p> <p>16. Steering wheel (P.3-28)</p> <ul style="list-style-type: none"> <li>— Horn (P.2-50)</li> </ul> <p>17. Parking brake (Pedal type)* (P.3-30)</p> <p>18. Ignition switch (model without Intelligent Key system)* (P.5-7)</p> <p>19. Stop/Start or Idling Stop OFF switch* (P.5-21)</p> <p>20. Parking sensor (sonar) system OFF switch* (P.5-51)</p> <p>21. ECO switch* (P.5-47)</p> <p>22. Headlight aiming control switch* (P.2-42)</p> <p>*: if equipped</p> <p>** : See the separate Navigation System Owner's Manual (if equipped).</p> |
|---|--|---|

**Illustrated table of contents 0-7**

## INSTRUMENT PANEL

### LEFT-HAND DRIVE (LHD) MODEL

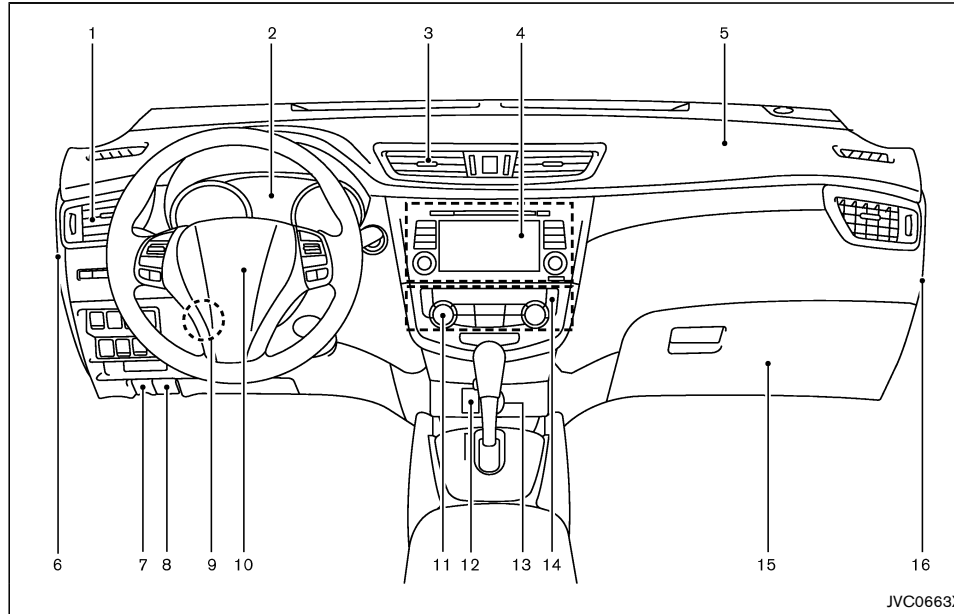

- |   |  |
|---|--|
| 1. Side ventilator (P.4-26)   | — Bluetooth® Hands-Free Phone System (with navigation)* (P.4-94) |
| 2. Meters and gauges (P.2-7)/Clock (P.2-22)                         | — Voice Recognition System* (P.4-98)                             |
| 3. Center ventilator (P.4-25)                                       | 5. Passenger's front-impact air bag (P.1-27)                     |
| 4. Audio system* (P.4-35) or Navigation system**                    | 6. Fuse box cover (P.8-24)                                       |
| — Rear view monitor* (P.4-7)  | 7. Fuel filler lid release handle (P.3-27)                       |
| — Around view monitor* (P.4-10)                                     | 8. Hood release handle (P.3-22)                                  |
| — Bluetooth® Hands-Free Phone System (without navigation)* (P.4-78) | 9. Steering wheel lock lever (P.3-28)                            |

10. Driver's front-impact air bag (P.1-27)/Horn (P.2-50)
11. Heater/air conditioner control (P.4-26)
12. Auxiliary input jack\* (P.4-75) and USB port\* (P.4-75)
13. Power outlet\*/Cigarette lighter\* (P.2-53)
14. Defogger switch (P.2-49)
15. Glove box (P.2-54)
16. Fuse box cover\* (P.8-24)

\*: if equipped

\*\* : See the separate Navigation System Owner's Manual (if equipped).

### 0-8 Illustrated table of contents



## RIGHT-HAND DRIVE (RHD) MODEL

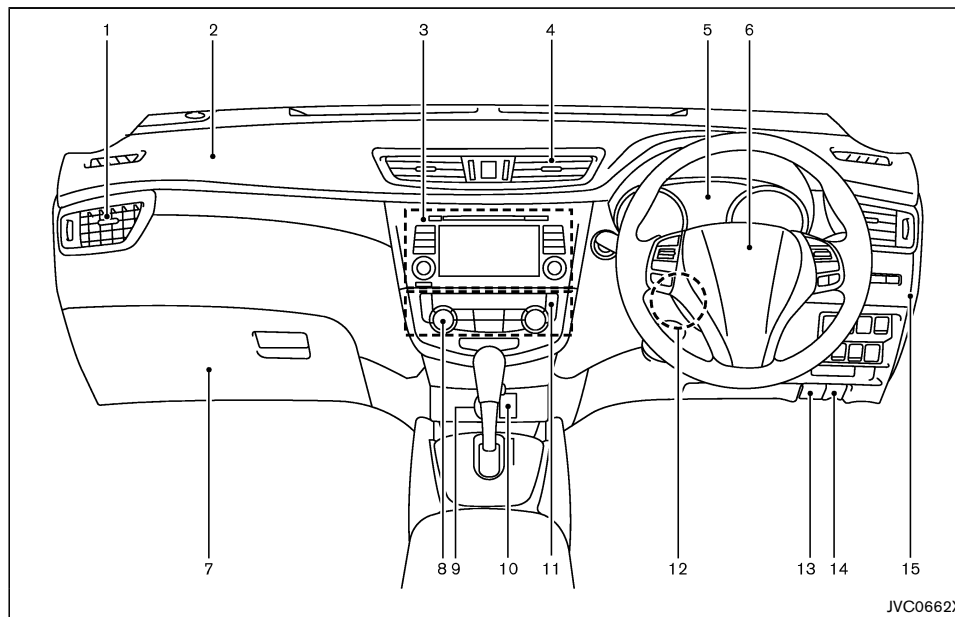

- |  |   |
|--|---|
| 1. Side ventilator (P.4-26)  | — Voice Recognition System* (P.4-98)                    |
| 2. Passenger's front-impact air bag (P.1-27)                         | 4. Center ventilator (P.4-25)                           |
| 3. Audio system* (P.4-35) or Navigation system**                     | 5. Meters and gauges (P.2-7)/Clock (P.2-22)             |
| — Rear view monitor* (P.4-7)   | 6. Driver's front-impact air bag (P.1-27)/Horn (P.2-50) |
| — Around view monitor* (P.4-10)                                      | 7. Glove box (P.2-54)                                   |
| — Bluetooth® Hands-Free Phone System (with-out navigation)* (P.4-78) | — Fuse box (P.8-24)                                     |
| — Bluetooth® Hands-Free Phone System (with navigation)* (P.4-94)     | 8. Heater/air conditioner control (P.4-26)              |

9. Power outlet\*/Cigarette lighter\* (P.2-53)
  10. Auxiliary input jack\* (P.4-75) and USB port\* (P.4-75)
  11. Defogger switch (P.2-49)
  12. Steering wheel lock lever (P.3-28)
  13. Hood release handle (P.3-22)
  14. Fuel filler lid release handle (P.3-27)
  15. Fuse box cover\* (P.8-24)
- \*: if equipped  
 \*\*: See the separate Navigation System Owner's Manual (if equipped).

**Illustrated table of contents 0-9**

## METERS AND GAUGES

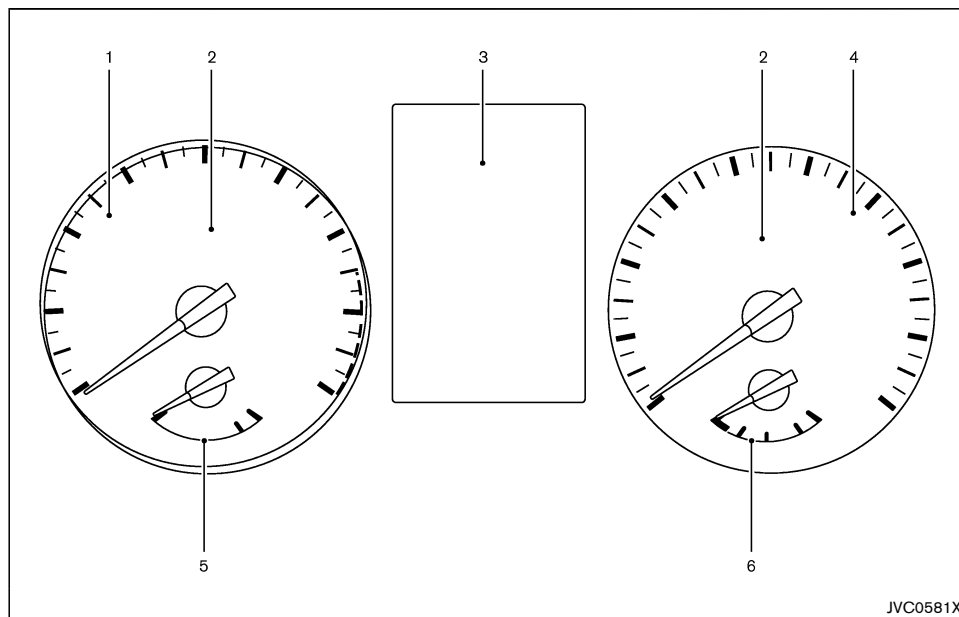

1. Tachometer (P.2-8)
2. Warning/indicator lights (P.2-12)
3. Vehicle information display (P.2-20)
  - Odometer/twin trip odometer (P.2-7, P.2-8)
4. Speedometer (P.2-7)
5. Engine coolant temperature gauge (P.2-9)
6. Fuel gauge (P.2-9)

### 0-10 Illustrated table of contents

## ENGINE COMPARTMENT

### QR25DE ENGINE MODEL

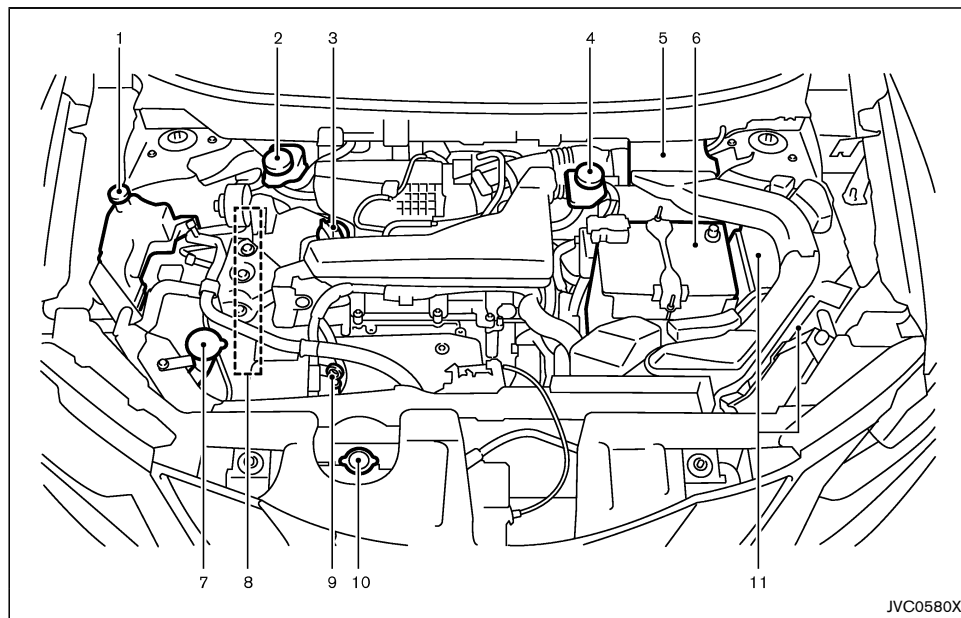

- |   |                                    |
|---|------------------------------------|
| 1. Engine coolant reservoir (P.8-9)           | 8. Engine drive belts (P.8-14)     |
| 2. Brake fluid reservoir (P.8-16) — RHD model | 9. Engine oil dipstick (P.8-10)    |
| 3. Engine oil filler cap (P.8-10)             | 10. Radiator cap (P.8-8)           |
| 4. Brake fluid reservoir (P.8-16) — LHD model | — Vehicle overheat (P.6-10)        |
| 5. Air cleaner (P.8-17)                       | 11. Fuse/fusible link box (P.8-24) |
| 6. Battery (P.8-20)                           |                                    |
| 7. Window washer fluid reservoir (P.8-19)     |                                    |

Illustrated table of contents 0-11

## MR20DD ENGINE MODEL

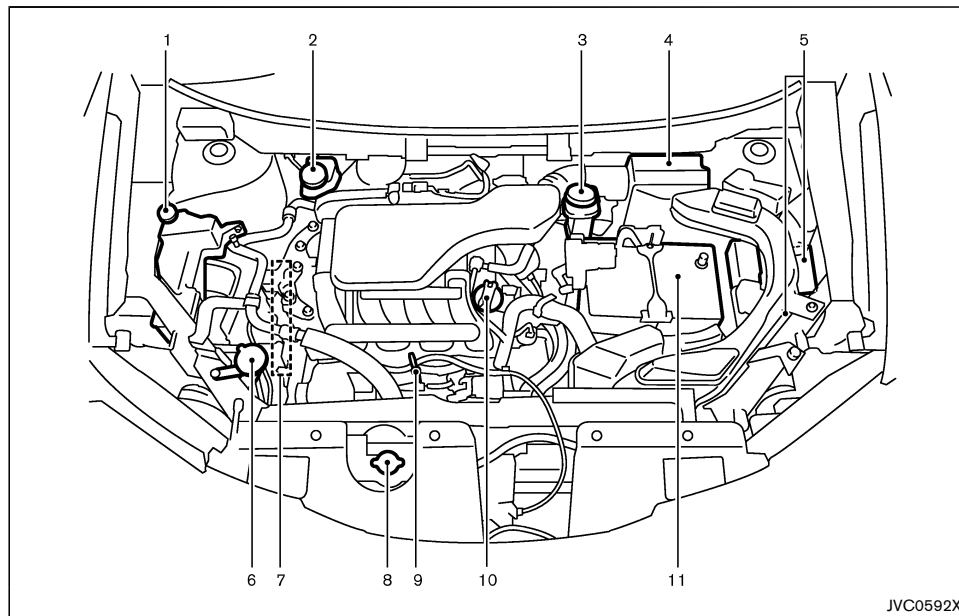

JVC0592X

- |   |  |
|---|--|
| 1. Engine coolant reservoir (P.8-9)                       | 7. Engine drive belts (P.8-14)                         |
| 2. Brake and clutch* fluid reservoir (P.8-16) — RHD model | 8. Radiator cap (P.8-8)<br>— Vehicle overheat (P.6-10) |
| 3. Brake and clutch* fluid reservoir (P.8-16) — LHD model | 9. Engine oil dipstick (P.8-10)                        |
| 4. Air cleaner (P.8-17)                                   | 10. Engine oil filler cap (P.8-10)                     |
| 5. Fuse/fusible link box (P.8-24)                         | 11. Battery (P.8-20)                                   |
| 6. Window washer fluid reservoir (P.8-19)                 | *: For Manual Transmission (MT) Model                  |

## 0-12 Illustrated table of contents

## R9M ENGINE MODEL

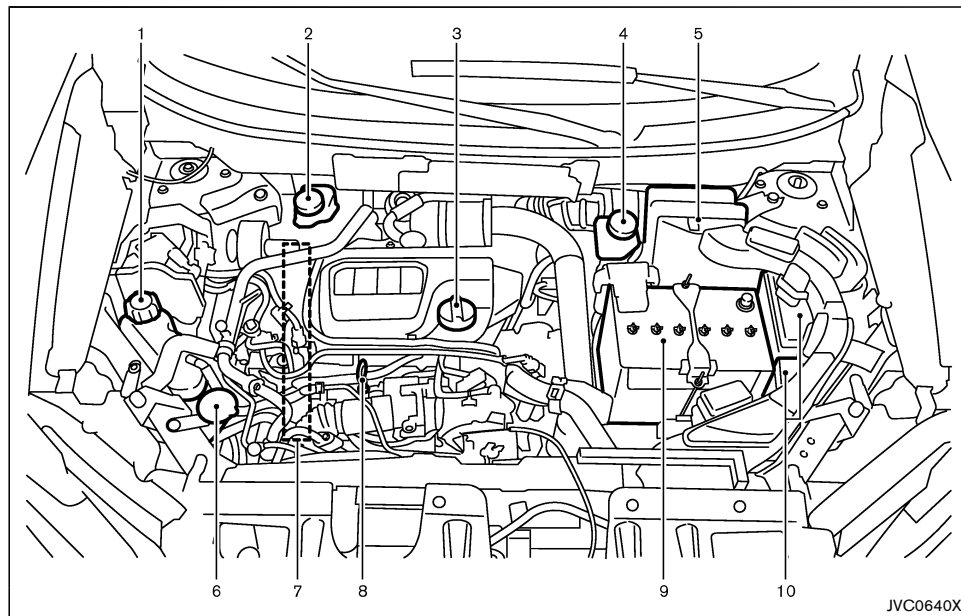

- |   |                                       |
|---|---------------------------------------|
| 1. Engine coolant reservoir (P.8-9)                       | 7. Engine drive belts (P.8-14)        |
| 2. Brake and clutch* fluid reservoir (P.8-16) — RHD model | 8. Engine oil dipstick (P.8-10)       |
| 3. Engine oil filler cap (P.8-10)                         | 9. Battery (P.8-20)                   |
| 4. Brake and clutch* fluid reservoir (P.8-16) — LHD model | 10. Fuse/fusible link box (P.8-24)    |
| 5. Air cleaner (P.8-17)                                   | *: For Manual Transmission (MT) Model |
| 6. Window washer fluid reservoir (P.8-19)                 |                                       |

**Illustrated table of contents 0-13**

**MEMO**

**0-14 Illustrated table of contents**

Condition: 'Except for China'

[ Edit: 2014/ 11/ 7 Model: T32-A ]

# 1 Safety — seats, seat belts and supplemental restraint system

Seats .....	1-2	Three-point type seat belts .....	1-12
Front seats .....	1-2	Seat belt maintenance .....	1-13
Second row seats .....	1-5	Child restraints .....	1-14
Third row seats (if equipped) .....	1-6	Precautions on child restraint usage .....	1-14
Armrest .....	1-7	Universal child restraints for front seat and rear seats (for Europe) .....	1-15
Head restraints .....	1-7	ISOFIX child restraint system (for second row seats) .....	1-19
Adjustable head restraint .....	1-7	Child restraint anchorage (for second row seats) .....	1-20
Non-adjustable head restraint .....	1-7	Child restraint installation using ISOFIX .....	1-20
Remove .....	1-8	Child restraint installation using 3-point type seat belt .....	1-23
Install .....	1-8	Supplemental Restraint System (SRS) .....	1-27
Adjust .....	1-8	Precautions on Supplemental Restraint System (SRS) .....	1-27
Seat belts .....	1-9	Supplemental air bag systems .....	1-32
Precautions on seat belt usage .....	1-9	SRS air bag deployment conditions .....	1-34
Child safety .....	1-11	Pre-tensioner seat belt system .....	1-36
Pregnant women .....	1-12	Repair and replacement procedure .....	1-37
Injured persons .....	1-12		
Center mark on seat belts .....	1-12		

## SEATS

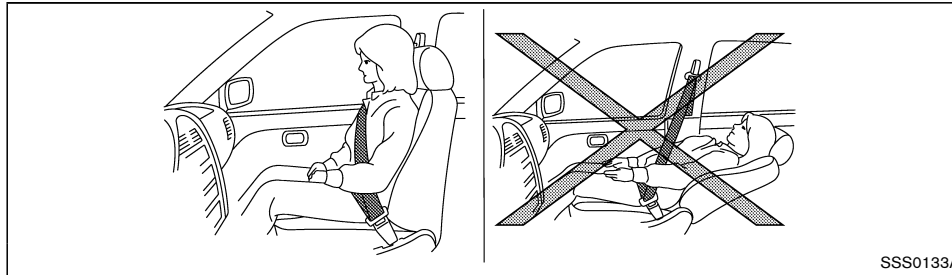

### **WARNING:**

- Do not drive and/or ride in the vehicle with the seatback reclined. This can be dangerous. The shoulder belt will not be properly against the body. In an accident, you and your passengers could be thrown into the shoulder belt and receive neck or other serious injuries. You and your passengers could also slide under the lap belt and receive serious injuries.
- For the most effective protection while the vehicle is in motion, the seatback should be upright. Always sit well back in the seat and adjust the seat belt properly. (See "Seat belts" (P.1-9).)

### **CAUTION:**

When adjusting the seat positions, be sure not to contact any moving parts to avoid possible injuries and/or damages.

## FRONT SEATS

### **WARNING:**

Do not adjust the driver's seat while driving so that full attention may be given to vehicle operation.

### Manual seat adjustment

### **WARNING:**

After adjusting a seat, gently shake the seat to confirm that the seat is locked securely. If the seat is not locked securely, it may move suddenly and could cause the loss of control of the vehicle.

## 1-2 Safety — seats, seat belts and supplemental restraint system

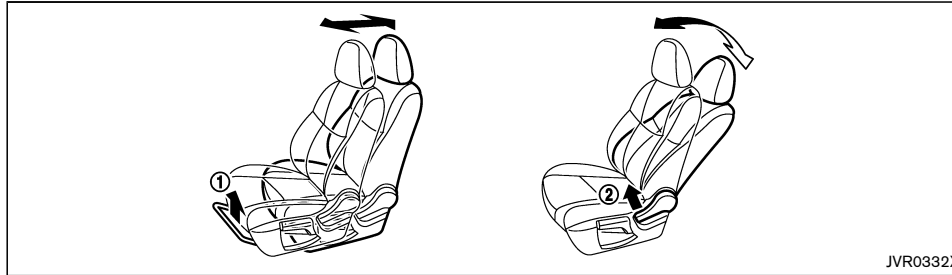

**Forward and backward:**

1. Pull up the adjusting lever ①.
2. Slide the seat to the desired position.
3. Release the adjusting lever to lock the seat in position.

**Reclining:**

1. Pull up the adjusting lever ②.
2. Tilt the seatback to the desired position.
3. Release the adjusting lever to lock the seatback in position.

The reclining feature allows the adjustment of the seatback for occupants of different sizes to help obtain the proper seat belt fit. (See "Seat belts" (P.1-9).)

The seatback may be reclined to allow occupants to rest when the vehicle is parked.

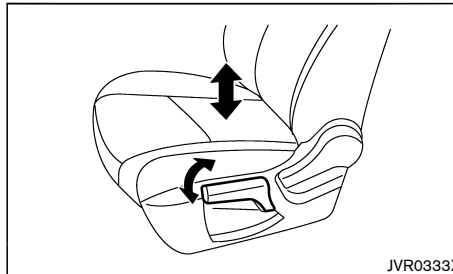
**Seat lifter (if equipped):**

Pull up or push down the adjusting lever to adjust the seat height until the desired position is achieved.

**Power seat adjustment****WARNING:**

**Never leave children or adults who would normally require the support of others alone in the vehicle. Pets should not be left alone either. They could unknowingly activate switches or controls and inadvertently become involved in a serious accident and injure themselves.**

**Operating tips:**

- The power seat motor has an auto-reset overload protection circuit. If the motor stops during the seat adjustment, wait 30 seconds, then reactivate the switch.
- To avoid discharge of the battery, do not operate the power seats for a long period of time when the engine is not running.

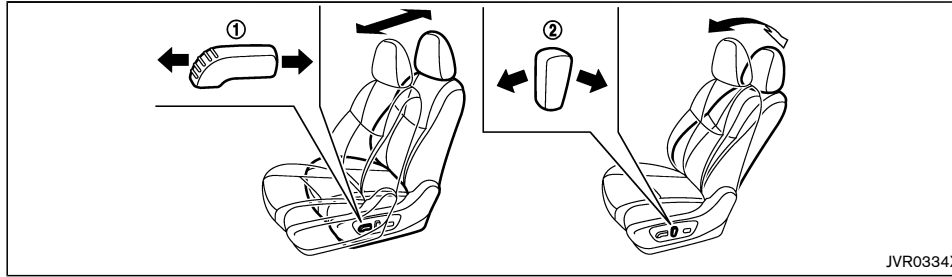

**Forward and backward:**

Move forward or backward the adjusting switch ① to the desired position.

**Reclining:**

Move forward or backward the adjusting switch ② to the desired position.

The reclining feature allows the adjustment of the seatback for occupants of different sizes to help obtain the proper seat belt fit. (See "Seat belts" (P.1-9).)

The seatback may be reclined to allow occupants to rest when the vehicle is parked.

**Seat lifter (if equipped):**

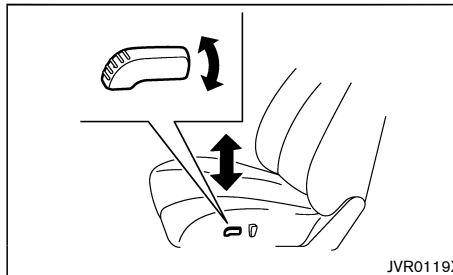

Pull up or push down the adjusting switch to adjust the seat height until the desired position is achieved.

**Lumbar support (if equipped):**

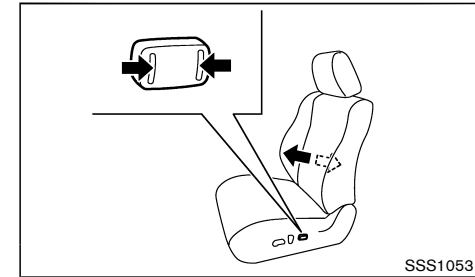

The lumbar support feature provides lower back support to the driver.

Push each side of the adjusting switch to adjust the seat lumbar area until the desired position is achieved.

**Heated seats (if equipped)**

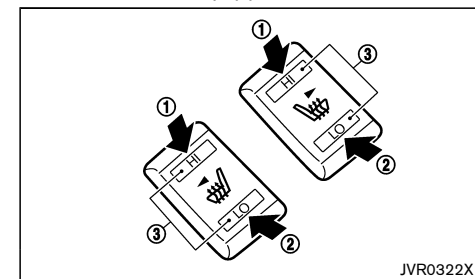

The front seats can be warmed by built-in heaters. The switches located on the center console can be operated independently of each other.

1. Start the engine.

**1-4 Safety — seats, seat belts and supplemental restraint system**

2. Select heat range.
  - For high heat, push the HI (High) side of the switch ①.
  - For low heat, push the LO (Low) side of the switch ②.
  - The indicator light ③ will illuminate when low or high is selected.
3. To turn off the heater, return the switch to the level position. Make sure the indicator light turns off.

The heater is controlled by a thermostat, automatically turning the heater on and off. The indicator light will remain on as long as the switch is on.

When the vehicle's interior is warmed, or before you leave the vehicle, be sure to turn off the switch.

#### CAUTION:

- **The battery could run down if the seat heater is operated while the engine is not running.**
- **Do not use the seat heater for extended periods or when no one is using the seat.**
- **Do not put anything on the seat which insulates heat, such as a blanket, cushion, seat cover, etc. Otherwise, the seat may become overheated.**
- **Do not place anything hard or heavy on the seat or pierce it with a pin or similar object. This may result in damage to the seat heater.**
- **Any liquid spilled on the heated seat should be removed immediately with a dry cloth.**
- **When cleaning the seat, never use gasoline, thinner, or any similar materials.**

## SECOND ROW SEATS

### Adjustment

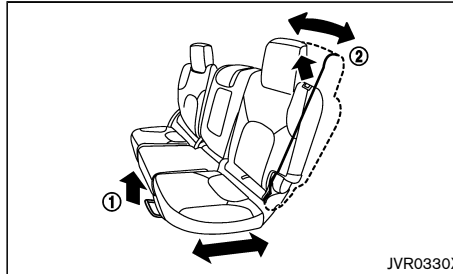

#### Forward and backward:

1. Pull up the adjusting lever ①.
2. Slide the seat to the desired position.
3. Release the adjusting lever ① to lock the seat in position.

#### Reclining:

1. Pull the adjusting lever ②.
2. Tilt the seatback to the desired position.
3. Release the adjusting lever ② to lock the seatback in position.

The reclining feature allows the adjustment of the seatback for occupants of different sizes to help obtain the proper seat belt fit. (See "Seat belts" (P.1-9).)

The seatback may be reclined to allow occupants to rest when the vehicle is parked.

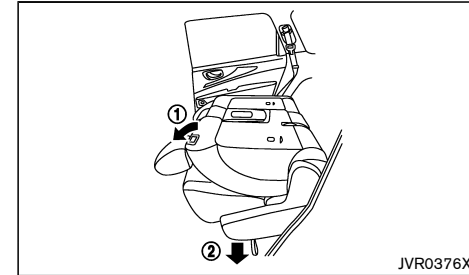

#### Folding:

1. For vehicles not equipped with third row seat: Pull up the lever ① and fold the seatback flat.  
For vehicles equipped with third row seat: Pull up the lever ① and pull the strap ② on the lower side of the outboard seats to fold the seatback flat.
2. To return the seats to a seating position, push up on the seatback until it latches in place.

#### WARNING:

- **Never allow anyone to ride in the luggage area or on the rear seats when they are in the fold-down position. Use of these areas by passengers without proper restraints could result in serious injury in an accident or sudden stop.**
- **Do not fold down the second row seats when occupants are in the second row seat area or any luggage is on the second row seats.**
- **Properly secure all luggage to help prevent it from sliding or shifting. Do not place luggage higher than the seatbacks.**

**Safety — seats, seat belts and supplemental restraint system 1-5**

- When returning the seatbacks to the upright position, be certain they are completely secured in the latched position. If they are not completely secured, passengers may be injured in an accident or sudden stop.

#### Walk-in mechanism (Three-row model):

The second row seats can tilt and slide for easy entry/exit to/from the third row seats.

#### WARNING:

After operating the walk-in mechanism, be sure to return the seat to the rearmost position and then tilt up the seatback until it latches.

#### CAUTION:

- When operating the walk-in mechanism, push and hold the seatback and operate slowly. If the seatback is tilted down quickly and then allowed to slide, there is a risk that it could contact your face or other parts of your body, or pinch your hand or foot, causing injury.
- When operating the walk-in mechanism, be sure not to contact any moving parts to avoid possible injuries and/or damage.
- When operating the walk-in mechanism, be sure that the second row seats are not occupied by passengers and/or any objects to avoid possible injuries and/or damage.
- Do not operate the walk-in mechanism with objects, drinks, etc. on the seat. This may cause objects to break or cause the passenger room to be soiled.

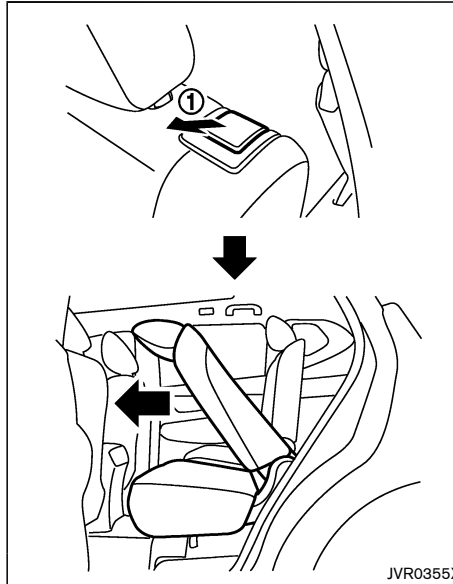

1. Pull the lever ① to tilt down the seatback.
2. Slide the seat forward.
3. When returning the seat to its original position, slide the seat backward, tilt the seatback up and then secure it in place.

#### THIRD ROW SEATS (if equipped)

##### Folding

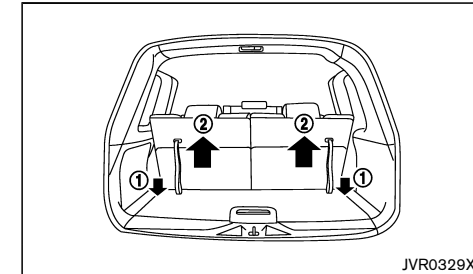

To fold the third row seats flat for maximum cargo capacity:

1. Make sure the head restraints are all the way down.
2. Pull the strap ① to release the seat.
3. Once released, push the seatback forward ②.

To return the third row seats to a seating position:

Use the pull straps ① to raise each seatback. Pull back until the seatback latches into position. Make sure to properly raise each seatback to an upright and secured position.

#### WARNING:

When the seat is returned to the normal seating position, the head restraints must be returned to the upright position to properly protect vehicle occupants.

## 1-6 Safety — seats, seat belts and supplemental restraint system

**ARMREST**

Pull the armrest down until it rests on the seat cushion.

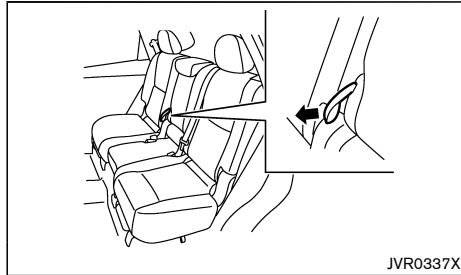
**Second row seats**

Fold down the armrest while pulling the strap until it rests on the seat cushion.

**HEAD RESTRAINTS**

**⚠ WARNING:**

Head restraints supplement the other vehicle safety systems. They may provide additional protection against injury in certain rear end collisions. Adjustable head restraints must be adjusted properly, as specified in this section. Check the adjustment after someone else uses the seat. Do not attach anything to the head restraint stalks or remove the head restraint. Do not use the seat if the head restraint has been removed. If the head restraint was removed, reinstall and properly adjust the head restraint before an occupant uses the seating position. Failure to follow these instructions can reduce the effectiveness of the head restraint. This may increase the risk of serious injury or death in a collision.

- Your vehicle is equipped with a head restraint that may be integrated, adjustable or non-adjustable.
- Adjustable head restraints have multiple notches along the stalk to lock them in a desired adjustment position.
- The non-adjustable head restraints have single locking notch to secure them to the seat frame.
- Proper Adjustment:
  - For the adjustable type, align the head restraint so the center of your ear is approximately level with the center of the head restraint.
  - If your ear position is still higher than the recommended alignment, place the head restraint at the highest position.
- If the head restraint has been removed, ensure that it is reinstalled and locked in place before riding in that designated seating position.

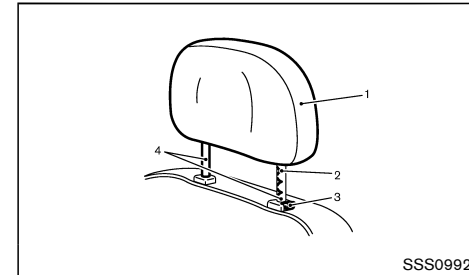
**ADJUSTABLE HEAD RESTRAINT**

1. Removable head restraint
2. Multiple notches
3. Lock knob
4. Stalks

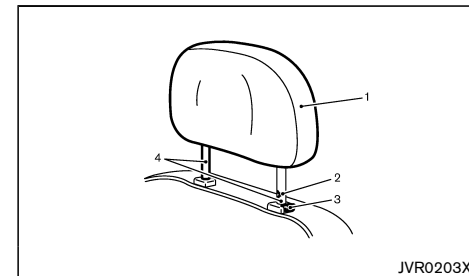
**NON-ADJUSTABLE HEAD RESTRAINT**

1. Removable head restraint
2. Single notch
3. Lock knob

## 4. Stalks

## REMOVE

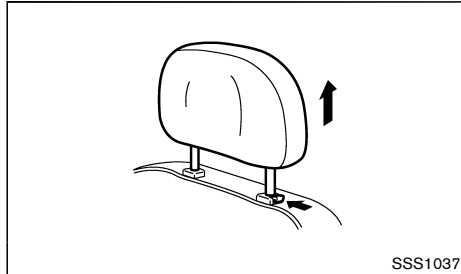

Use the following procedure to remove the head restraint.

1. Pull the head restraint up to the highest position.
2. Push and hold the lock knob.
3. Remove the head restraint from the seat.
4. Store the head restraint properly in a secure place so it is not loose in the vehicle.
5. Reinstall and properly adjust the head restraint before an occupant uses the seating position.

## INSTALL

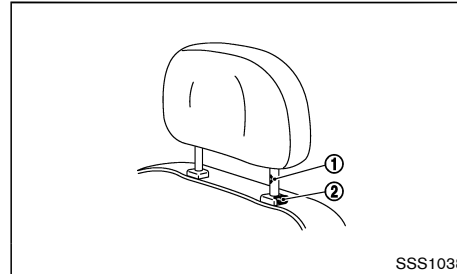

1. Align the head restraint stalks with the holes in the seat. Make sure that the head restraint is facing the correct direction. The stalk with the adjustment notch ① must be installed in the hole with the lock knob ②.
2. Push and hold the lock knob and push the head restraint down.
3. Properly adjust the head restraint before an occupant uses the seating position.

## ADJUST

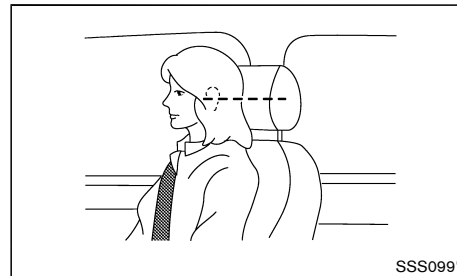
**For adjustable head restraint**

Adjust the head restraint so the center is level with the center of your ears. If your ear position is still higher than the recommended alignment, place the head restraint at the highest position.

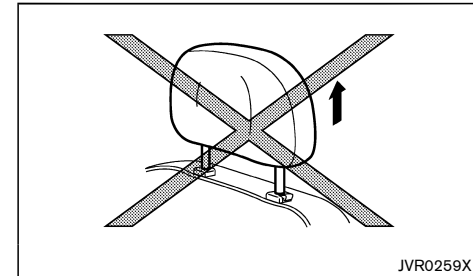
**For non-adjustable head restraint**

Make sure the head restraint is positioned from the stored position or any non-latch position so the lock knob is engaged in the notch before riding in that designated seating position.

## Raise

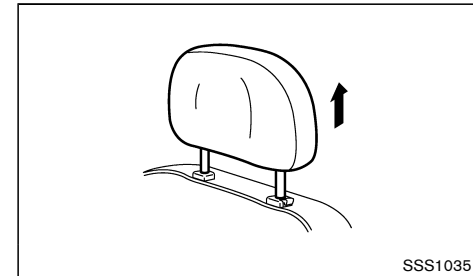
**Type A**

To raise the head restraint, pull it up.

**1-8 Safety — seats, seat belts and supplemental restraint system**

## SEAT BELTS

### PRECAUTIONS ON SEAT BELT USAGE

If you are wearing the seat belt properly adjusted and sitting upright and well back in the seat, chances of being injured or killed in an accident and/or the severity of injury may be greatly reduced. NISSAN strongly encourages you and all of your passengers to buckle up every time you drive, even if your seating position includes the supplemental air bag systems.

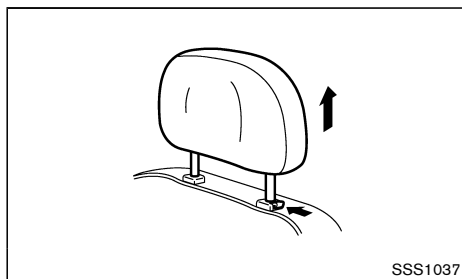

**Type B**

To raise the head restraint, push and hold the lock knob. Then, pull it up.

Make sure the head restraint is positioned from the stored position or any non-latch position so the lock knob is engaged in the notch before riding in that designated seating position.

#### Lower

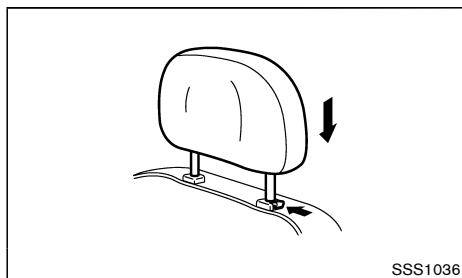

To lower, push and hold the lock knob and push the head restraint down.

Make sure the head restraint is positioned so the lock knob is engaged in the notch before riding in that designated seating position.

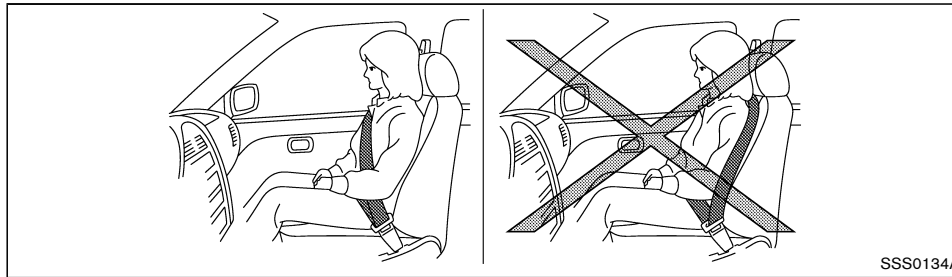

SSS0134A

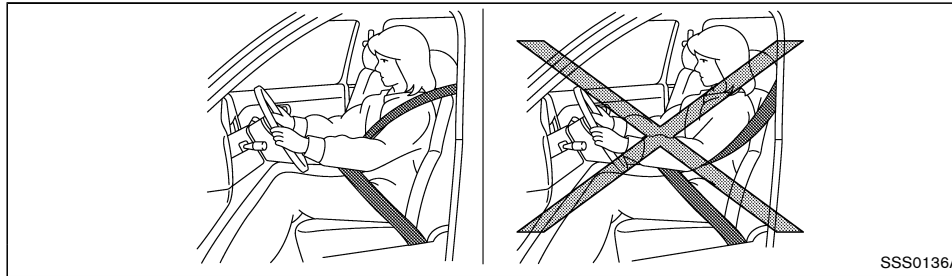

SSS0136A

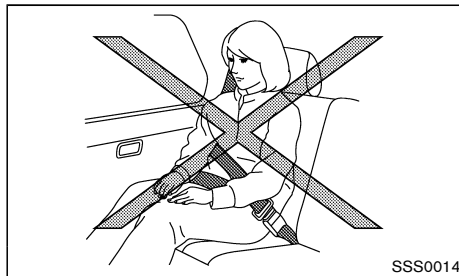

SSS0014

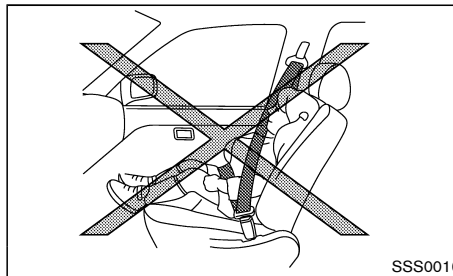

SSS0016

**WARNING:**

- Seatbelts are designed to bear upon the bony structure of the body, and should be worn low across the front of the pelvis or the pelvis, chest and shoulders, as applicable; wearing the lap section of the belt across the abdominal area must be avoided. Serious injury may occur if a seat belt is not worn properly.
- Position the lap belt as low and snug as possible around the hips, not the waist. A lap belt worn too high could increase the risk of internal injuries in an accident.
- Do not allow more than one person to use the same seat belt. Each belt assembly must only be used by one occupant; it is dangerous to put a belt around a child being carried on the occupant's lap.
- Never carry more people in the vehicle than there are seat belts.
- Never wear seat belts inside out. Belts should not be worn with straps twisted. Doing so may reduce their effectiveness.
- Seatbelts should be adjusted as firmly as possible, consistent with comfort, to provide the protection for which they have been designed. A slack belt will greatly reduce the protection afforded to the wearer.
- Every person who drives or rides in this vehicle should use a seat belt at all times. Children should be properly restrained in the rear seat and, if appropriate, in a child restraint system.

**1-10 Safety — seats, seat belts and supplemental restraint system**



- Do not run the belt behind your back or under your arm. Always route the shoulder belt over your shoulder and across your chest. The belt should be away from your face and neck, but not falling off your shoulder. Serious injury may occur if a seat belt is not worn properly.
- No modifications or additions should be made by the user which will either prevent the seat belt adjusting devices from operating to remove slack, or prevent the seat belt assembly from being adjusted to remove slack.
- Care should be taken to avoid contamination of the webbing with polishes, oils and chemicals, and particularly battery acid. Cleaning may safely be carried out using mild soap and water. The belt should be replaced if webbing becomes frayed, contaminated or damaged.
- All seat belt assemblies including retractors and attaching hardware should be inspected after any collision by a NISSAN dealer. NISSAN recommends that all seat belt assemblies in use during a collision be replaced unless the collision was minor and the belts show no damage and continue to operate properly. Seat belt assemblies not in use during a collision should also be inspected and, when necessary, replaced if either damage or improper operation is noted.
- It is essential to replace the entire assembly after it has been worn in a severe impact even if damage to the assembly is not obvious.

- Once the pre-tensioner seat belt has activated, it cannot be reused. It must be replaced together with the retractor. Contact a NISSAN dealer.
- Removal and installation of the pre-tensioner seat belt system components should be done by a NISSAN dealer.

#### CHILD SAFETY

##### WARNING:

- Infants and children need special protection. The vehicle's seat belts may not fit them properly. The shoulder belt may come too close to the face or neck. The lap belt may not fit over their small hipbones. In an accident, an improperly fitted seat belt could cause serious or fatal injury.
- Always use an appropriate child restraint system.

Children need adults to help protect them. They need to be properly restrained. The proper restraint depends on the child's size.

#### Infants and small children

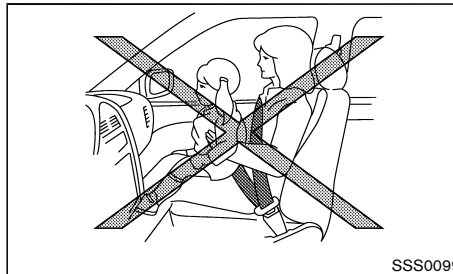

NISSAN recommends that infants and small children be seated in a child restraint system. You should choose a child restraint system that fits your vehicle and the child, and always follow the manufacturer's instructions for installation and use.

#### Large children

##### WARNING:

- Never allow children to stand or kneel on any seats.
- Never allow children in the cargo areas while the vehicle is moving. A child could be seriously injured in an accident or sudden stop.

Children who are too large for a child restraint system should be seated and restrained by the seat belts that are provided.

If the child's seating position has a shoulder belt that fits close to the face or neck, the use of a booster seat (commercially available) may help overcome this. The booster seat should raise the child so that the shoulder belt is properly positioned across the top, middle portion of the shoulder and the lap belt is low on the hips. The booster seat should also fit the vehicle seat. Once the child has grown so that the shoulder belt is no longer on or near the face or neck of the child, use the shoulder belt without the booster seat. In addition, there are many types of child restraint systems available for larger children that should be used for maximum protection.

## PREGNANT WOMEN

NISSAN recommends that pregnant women use seat belts. The seat belt should be worn snug, and always position the lap belt as low as possible around the hips, not the waist. Place the shoulder belt over your shoulder and across your chest. Never run the lap/shoulder belt over your abdominal area. Contact your doctor for specific recommendations.

## INJURED PERSONS

NISSAN recommends that injured persons use seat belts. Contact your doctor for specific recommendations.

## CENTER MARK ON SEAT BELTS

Selecting correct set of seat belts

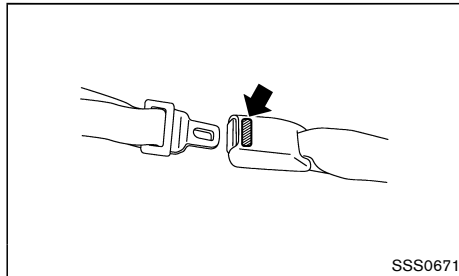

The center seat belt buckle is identified by the CENTER mark. The center seat belt tongue can be fastened only into the center seat belt buckle.

## THREE-POINT TYPE SEAT BELTS

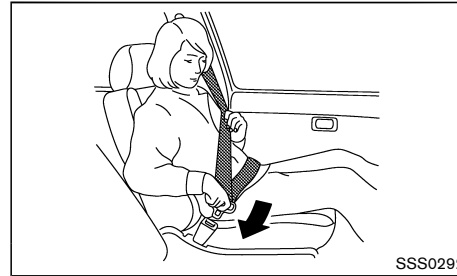

### WARNING:

**Every person who drives or rides in this vehicle should use a seat belt at all times.**

Fastening seat belts

### WARNING:

**The seatback should not be in a reclined position any more than needed for comfort. Seat belts are most effective when the passenger sits well back and straight up in the seat.**

1. Adjust the seat. (See "Seats" (P.1-2).)
2. Slowly pull the seat belt out of the retractor and insert the tongue into the buckle until you hear and feel the latch engage.

- **The retractor is designed to lock during a sudden stop or on impact. A slow pulling motion permits the seat belt to move, and allows you some freedom of movement in the seat.**

- **If the seat belt cannot be pulled from its fully retracted position, firmly pull the belt and release it. Then smoothly pull the belt out of the retractor.**



3. Position the lap belt portion low and snug on the hips as shown.
4. Pull the shoulder belt portion toward the retractor to take up extra slack. Be sure the shoulder belt is routed over your shoulder and is snug across your chest.

Shoulder belt height adjustment (if equipped)

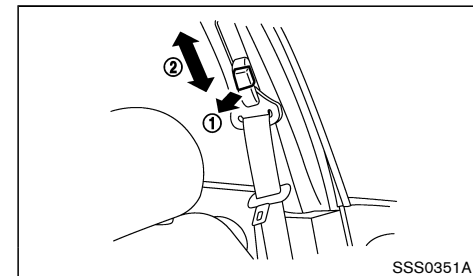

## 1-12 Safety — seats, seat belts and supplemental restraint system

**WARNING:**

- **The shoulder belt anchor height should be adjusted to the position best for you. Failure to do so may reduce the effectiveness of the entire restraint system and increase the chance or severity of injury in an accident.**
- **The shoulder belt should rest on the middle of the shoulder. It must not rest against the neck.**
- **Be sure that the seat belt is not twisted in any way.**
- **Be sure that the shoulder belt anchor is secured by trying to move the shoulder belt anchor up and down after adjustment.**

The shoulder belt anchor height should be adjusted to the position best for you.

The belt should be away from your face and neck, but not falling off your shoulder.

To adjust, pull the release button ① and move the shoulder belt anchor to the proper position ②, so that the belt passes over the center of the shoulder.

Release the button to lock the shoulder belt anchor into position.

**Unfastening seat belts**

Push the button on the buckle. The seat belt automatically retracts.

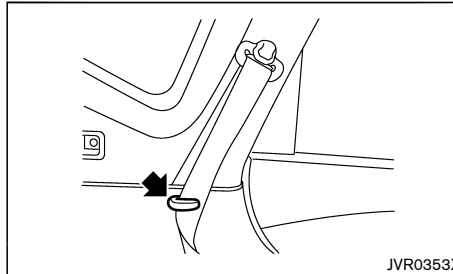
**Belt hook (if equipped)**

Seat belt can be hooked on the belt hook.

**Checking seat belt operation**

Seat belt retractors are designed to lock seat belt movement:

- When the seat belt is pulled quickly from the retractor.
- When the vehicle slows down rapidly.

To increase your confidence in the seat belts, check the operation by grasping the shoulder belt and pulling forward quickly. The retractor should lock and restrict further belt movement. If the retractor does not lock during this check, contact a NISSAN dealer immediately.

**SEAT BELT MAINTENANCE**

Periodically check that the seat belt and all the metal components, such as buckles, tongues, retractors, flexible wires and anchors, work properly. If loose parts, deterioration, cuts or other damage on the seat belt webbing is found, the entire seat belt assembly should be replaced.

If dirt builds up in the shoulder belt guide of the seat belt anchors, the seat belts may retract slowly. Wipe the shoulder belt guide with a clean, dry cloth.

To clean the seat belt webbing, apply a mild soap solution or any solution recommended for cleaning upholstery or carpet. Then wipe with a cloth and allow the seat belts to dry in the shade. Do not allow the seat belts to retract until they are completely dry.

## CHILD RESTRAINTS

### PRECAUTIONS ON CHILD RESTRAINT USAGE

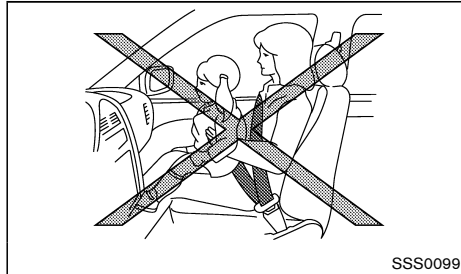

#### **WARNING:**

- Infants and small children should always be placed in an appropriate child restraint while riding in the vehicle. Failure to use a child restraint can result in serious injury or death.
- Infants and small children should never be carried on your lap. It is not possible for even the strongest adult to resist the forces of a severe accident. The child could be crushed between the adult and parts of the vehicle. Also, do not put the same seat belt around both your child and yourself.
- NISSAN recommends that the child restraints be installed in the rear seat. According to accident statistics, children are safer when properly restrained in the rear seat than in the front seat.
- Improper use or improper installation of a child restraint can increase the risk or severity of injury for both the child and other occupants of the vehicle and can lead to serious injury or death in an accident.

- Follow all of the child restraint manufacturer's instructions for installation and use. When purchasing a child restraint, be sure to select one which will fit your child and vehicle. It may not be possible to properly install some types of child restraint in your vehicle.
- The direction of the child restraint, either front-facing or rear-facing, depends on the type of the child restraint and the size of the child. Refer to the child restraint manufacturer's instructions for details.
- Adjustable seatbacks should be positioned to ensure full contact between child restraint and seatback.
- After attaching a child restraint, test it before you place the child in it. Push it from side to side and tug it forward to make sure that it is held securely in place. The child restraint should not move more than 25 mm (1 in). If the restraint is not secure, tighten the belt as necessary, or install the restraint in another seat and test it again.
- When the child restraint is not in use, keep it secured with the ISOFIX child restraint system or a seat belt to prevent it from being thrown around in case of a sudden stop or accident.
- Never install a rear-facing child restraint on the front passenger's seat when the front passenger's air bag is available. Supplemental front-impact air bags inflate with great force. A rear-facing child restraint could be struck by the supplemental front-impact air bags in an accident and could

seriously injure or kill your child.

- If the seat belt in the position where a child restraint is installed requires a locking device and if it is not used, injuries could result from a child restraint tipping over during normal vehicle braking or cornering.



#### **CAUTION:**

Remember that a child restraint left in a closed vehicle can become very hot. Check the seating surface and buckles before placing your child in a child restraint.

NISSAN recommends that infants and small children be seated in a child restraint. You should choose a child restraint that fits your vehicle and always follow the manufacturer's instructions for installation and use. In addition, there are many types of child restraints available for larger children that should be used for maximum protection.

### 1-14 Safety — seats, seat belts and supplemental restraint system

## UNIVERSAL CHILD RESTRAINTS FOR FRONT SEAT AND REAR SEATS (for Europe)

When selecting any child restraint, keep the following points in mind:

- Choose a child restraint that complies with the latest European safety standard, ECE Regulation 44.04.
- Place your child in the child restraint and check the various adjustments to be sure the child restraint is compatible with your child. Always follow all of the recommended procedures.
- Check the child restraint in your vehicle to be sure it is compatible with vehicle's seat belt system.
- Refer to the tables later in this section for a list of the recommended fitment positions and the approved child restraints for your vehicle.

### Mass group of child seat

Mass group	Child's weight
Group 0	up to 10 kg
Group 0+	up to 13 kg
Group I	9 to 18 kg
Group II	15 to 25 kg
Group III	22 to 36 kg

### Kind of child seats (example):

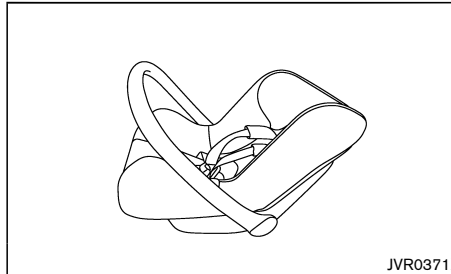

Child safety seat categories 0 and 0+

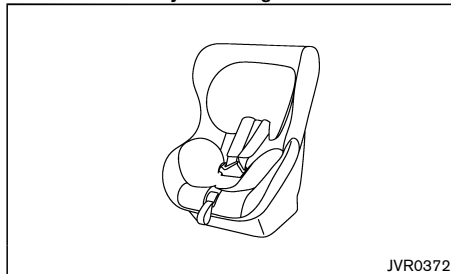

Child safety seat categories 0+ and I

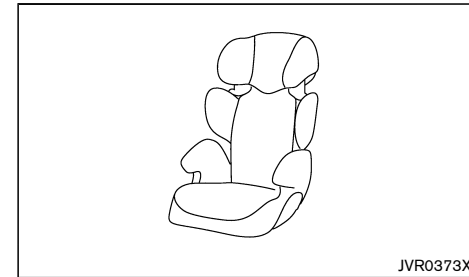

Child safety seat categories II and III

### Approved child restraint positions

The following restriction is applied when using child restraints varying by infants weight and installation position.

Mass group		Suitability				
		Front passenger seat (Air bag ON)	Front passenger seat (Air bag OFF)	2nd row outer seat	2nd row center seat	3rd row seat
0	<10 kg	X	X	U*2	X	X
0+	<13 kg	X	L*2	U/L*2	X	X
I	9 - 18 kg	X	L*2	U*2	X	X
II	15 - 25 kg	X	L*1*2	UF/L*1*2	X	X
III	22 - 36 kg	X	L*1*2	UF/L*1*2	X	X

X: not suitable for child restraint system

U: suitable for universal category child restraint system approved for this weight group

UF: suitable for forward-facing universal category child restraint system approved for this weight group

L: suitable for particular child restraints given on attached list or vehicle list of child restraint manufacturer

\*1: If you install the child seat, remove the head restraint.

\*2: If you install the child seat, set to most rearward slide position.

## 1-16 Safety — seats, seat belts and supplemental restraint system

## Permissible options for fitting an ISOFIX child restraint

Mass group			Suitability			
			Front passenger seat	2nd row outer seat	2nd row center seat	3rd row seat
Carry-cot	F	ISO/L1	X	X	X	X
	G	ISO/L2	X	X	X	X
0+ (<10 kg)	E	ISO/R1	X	IL*	X	X
0+ (<13 kg)	E	ISO/R1	X	IL	X	X
	D	ISO/R2	X	IL*	X	X
	C	ISO/R3	X	IL	X	X
I (9 - 18 kg)	D	ISO/R2	X	IL*	X	X
	C	ISO/R3	X	IL	X	X
	B	ISO/F2	X	IUF	X	X
	B1	ISO/F2X	X	IL*1/IUF	X	X
	A	ISO/F3	X	IUF	X	X
II (15 - 25 kg)	—	—	X	IL	X	X
III (22 - 36 kg)	—	—	X	IL	X	X

X: not suitable for child restraint system

IUF: suitable for universal category forward facing child restraint system approved for this weight group

IL: suitable particular ISOFIX category child restraint system (CRS) given in the below list or vehicle list of child seat manufacturer.

IL\*: suitable particular ISOFIX category child restraint system (CRS) given in the vehicle list of child seat manufacturer.

\*1: If you install the child seat, remove the head restraint.

## List of Universal recommended child restraints

	Front passenger seat (Air bag OFF)	2nd row outer seat	2nd row center seat	3rd row seat
0+ (<13 kg)	Maxi Cosi Cabrio Fix	Maxi Cosi Cabrio Fix	—	—
I (9 - 18 kg)	Römer King plus	Römer King plus	—	—
	—	Römer Duo plus	—	—
II (15 - 25 kg)	Römer Kid fix (belt mounted)	Römer Kid fix (belt mounted)	—	—
III (22 - 36 kg)	Römer Kid fix (belt mounted)	Römer Kid fix (belt mounted)	—	—

## List of Semi-universal recommended child restraints

	Front passenger seat (Air bag OFF)	2nd row outer seat	2nd row center seat	3rd row seat
0+ (<13 kg)	Maxi Cosi Cabrio Fix plus Easy Fix	Maxi Cosi Cabrio Fix plus Easy Fix	—	—
	—	Maxi Cosi Cabrio Fix plus Easy Fix Base	—	—
I (9 - 18 kg)	—	Maxi Cosi pearl plus family fix	—	—
II (15 - 25 kg)	—	Römer Kid fix (ISOFIX mounted)	—	—
III (22 - 36 kg)	—	Römer Kid fix (ISOFIX mounted)	—	—

## 1-18 Safety — seats, seat belts and supplemental restraint system



## List of approved child restraints

	Name of CRS	Fixture of CRS	Facing position	Category
0+ (<13 kg)	Römer Baby safe plus SHR II+ ISO-FIX base	ISOFIX + base and support leg	Rear facing	Semi-universal
I (9 - 18 kg)	Be safe IZI kid X3 iso fix	ISOFIX+support leg	Rear facing	Semi-universal

## ISOFIX CHILD RESTRAINT SYSTEM (for second row seats)

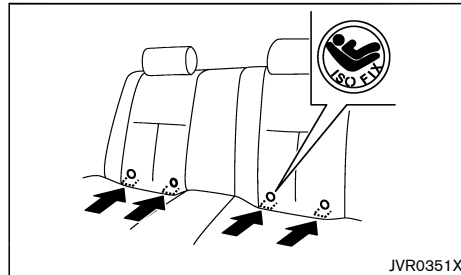
**ISOFIX label location**

Your vehicle is equipped with special anchor points that are used with ISOFIX child restraint systems.

## ISOFIX lower anchor point locations

The ISOFIX anchor points are provided to install child restraints in the second row outboard seating positions only. **Do not attempt to install a child restraint in the center seating position using the ISOFIX anchors.**

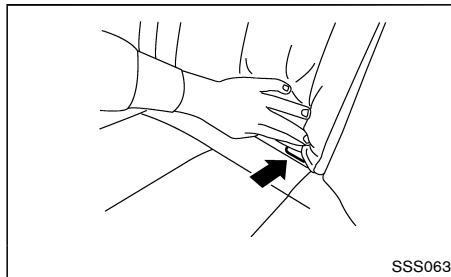
**ISOFIX lower anchor location**

The ISOFIX anchors are located at the rear of the seat cushion near the seatback. A label is attached to the seatback to help you locate the ISOFIX anchors.

## ISOFIX child restraint anchor attachments

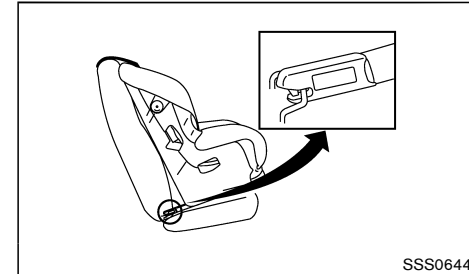
**Anchor attachment**

ISOFIX child restraints include two rigid attachments that can be connected to two anchors located in the seat. With this system, you do not have to use a vehicle seat belt to secure the child restraint. Check your child restraint for a label stating that it is compatible with the ISOFIX child restraints. This information may also be in the instructions provided by the child restraint manufacturer.

ISOFIX child restraints generally require the use of a top tether strap or other anti-rotation devices such as support legs. When installing ISOFIX child restraints, carefully read and follow the instructions in this manual and those supplied with the child restraints. (See "Child restraint installation using ISOFIX" (P.1-20).)

## CHILD RESTRAINT ANCHORAGE (for second row seats)

Your vehicle is designed to accommodate a child restraint system on the second row seat. When installing a child restraint system, carefully read and follow the instructions in this manual and those supplied with the child restraint system.

### **WARNING:**

- **Child restraint anchorages are designed to withstand only those loads imposed by correctly fitted child restraints. Under no circumstances are they to be used for adult seat belts, harnesses or for attaching other items or equipment to the vehicle. Doing so could damage the child restraint anchorages. The child restraint will not be properly installed using the damaged anchorage, and a child could be seriously injured or killed in a collision.**
- **The child restraint top tether strap may be damaged by contact with the tonneau cover (if equipped) or items in the luggage area. Remove the tonneau cover from the vehicle or secure it and any luggage. Your child could be seriously injured or killed in a collision if the top tether strap is damaged.**

### Anchorage location

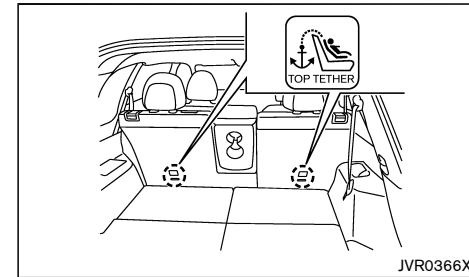
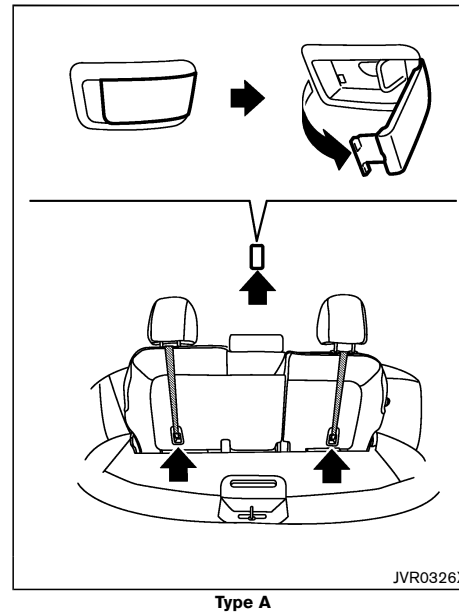

**Type B (example)**

Anchorage locations are as illustrated.

Position the top tether strap over the top of the seatback and secure it to the tether anchorage that provides the straightest installation. Tighten the tether strap according to the manufacturer's instruction to remove any slack.

## CHILD RESTRAINT INSTALLATION USING ISOFIX

### **WARNING:**

- **Attach ISOFIX child restraints only at the specified locations. For the ISOFIX lower anchor locations, see "ISOFIX child restraint system (for second row seats)" (P.1-19). If a child restraint is not secured properly, your child could be seriously injured or killed in an accident.**
- **Do not install child restraints that require the use of a top tether strap to seating positions that do not have a top tether anchor.**
- **Do not secure a child restraint in the center rear seating position using the ISOFIX lower anchors. The child restraint will not be**

secured properly.

- **Inspect the lower anchors by inserting your fingers into the lower anchor area and feeling to make sure there are no obstructions over the ISOFIX anchors, such as seat belt webbing or seat cushion material. The child restraint will not be secured properly if the ISOFIX anchors are obstructed.**
- **Child restraint anchorages are designed to withstand only those loads imposed by correctly fitted child restraints. Under no circumstance are they to be used for adult seat belts, harnesses or for attaching other items or equipment to the vehicle. Doing so could damage the child restraint anchorages. The child restraint will not be properly installed using the damaged anchorage, and a child could be seriously injured or killed in a collision.**

Installation on rear outboard seats

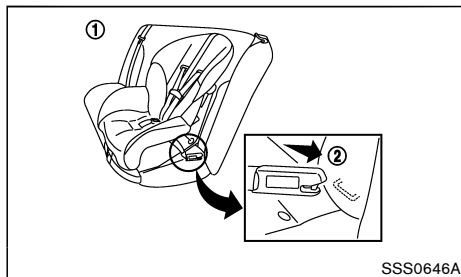

Steps 1 and 2

#### Front-facing:

Be sure to follow the manufacturer's instructions for the proper use of your child restraint. Follow these steps to install a front-facing child restraint on the second row outboard seats using ISOFIX:

1. Position the child restraint on the seat ①.
2. Secure the child restraint anchor attachments to the ISOFIX lower anchors ②.
3. **For Europe (Mass group I-F2X):**

The back of the child restraint should be secured against the vehicle seatback. The head restraint should be removed to obtain the correct child restraint fit. Store the head restraint in a secure place. Be sure to install the head restraint when the child restraint is removed. (See "Head restraints" (P.1-7), "Universal child restraints for front seat and rear seats" (P.1-15).)

#### For Europe (except for Mass group I-F2X):

##### Except for Europe:

The back of the child restraint should be secured against the vehicle seat back. If necessary, adjust or remove the head restraint to obtain the correct child restraint fit. If the head restraint is removed, store it in a secure place. Be sure to install the head restraint when the child restraint is removed. If the seating position does not have an adjustable head restraint and it is interfering with the proper child restraint fit, try another seating position or a different child restraint. (See "Head restraints" (P.1-7), "Universal child restraints for front seat and rear seats" (P.1-15).)

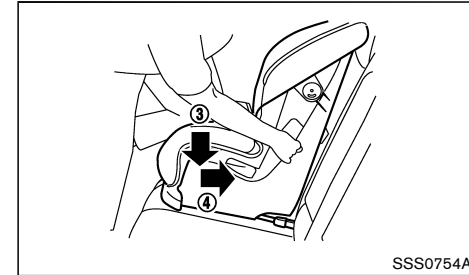

Step 4

4. Shorten the rigid attachment to have the child restraint firmly tightened; press downward ③ and rearward ④ firmly in the center of the child restraint with your knee to compress the vehicle seat cushion and seatback. Adjustable seatbacks should be positioned to ensure full contact between child restraint and seatback.
5. If the child restraint is equipped with a top tether strap, route the top tether strap and secure the tether strap to the tether anchor point. (See "Child restraint anchorage (for second row seats)" (P.1-20).)
6. If the child restraint is equipped with other anti-rotation devices such as support legs, use them instead of the top tether strap following the child restraint manufacturer's instructions.

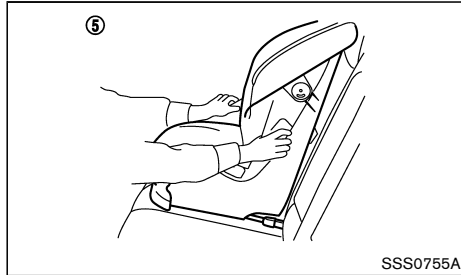
**Step 7**

7. Test the child restraint before you place the child in it ⑤. Push the child restraint from side to side and tug it forward to make sure that it is held securely in place.
8. Check to make sure that the child restraint is properly secured prior to each use. If the child restraint is loose, repeat steps 3 through 7.

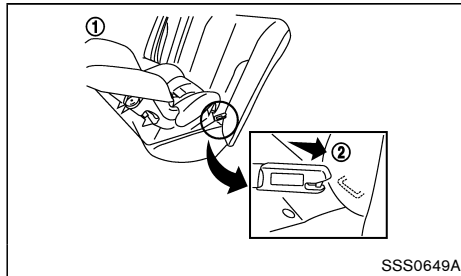
**Rear-facing:****Steps 1 and 2**

Be sure to follow the manufacturer's instructions for the proper use of your child restraint. Follow these steps to install a rear-facing child restraint on the second row outboard seats using ISOFIX:

**1-22 Safety — seats, seat belts and supplemental restraint system**

1. Position the child restraint on the seat ①.
2. Secure the child restraint anchor attachments to the ISOFIX lower anchors ②.

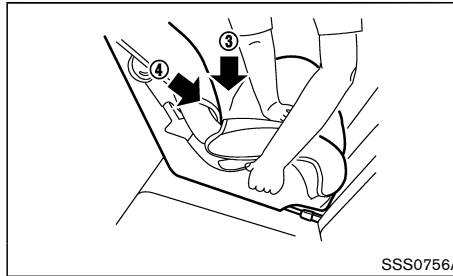
**Step 3**

3. Shorten the rigid attachment to have the child restraint firmly tightened; press downward ③ and rearward ④ firmly in the center of the child restraint with your hand to compress the vehicle seat cushion and seatback.
4. If the child restraint is equipped with a top tether strap, route the top tether strap and secure the tether strap to the tether anchor point. (See "Child restraint anchorage (for second row seats)" (P.1-20).)
5. If the child restraint is equipped with other anti-rotation devices such as support legs, use them instead of the top tether strap following the child restraint manufacturer's instructions.

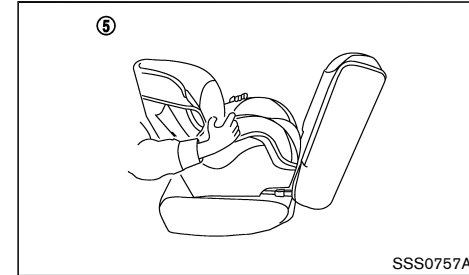
**Step 6**

6. Test the child restraint before you place the child in it ⑤. Push the child restraint from side to side and tug it forward to make sure that it is held securely in place.
7. Check to make sure that the child restraint is properly secured prior to each use. If the child restraint is loose, repeat steps 3 through 6.

## CHILD RESTRAINT INSTALLATION USING 3-POINT TYPE SEAT BELT

Installation on rear seats - without automatic locking mode

### Front-facing:

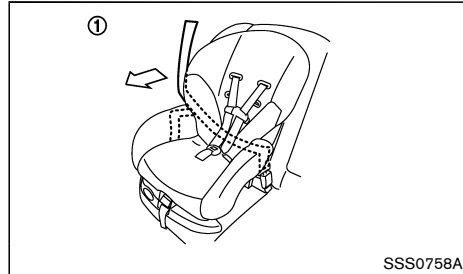

**Step 1**

Be sure to follow the manufacturer's instructions for the proper use of your child restraint. Follow these steps to install a front-facing child restraint on the rear seats using 3-point type seat belt without automatic locking mode:

1. Position the child restraint on the seat ①.
2. **Installation on rear outboard seats (for Europe (Mass group II and III)):**

Remove the head restraint. (See "Head restraints" (P.1-7), "Universal child restraints for front seat and rear seats" (P.1-15).)

**Installation on rear outboard seats (for Europe (except for Mass group II and III)):**

**Installation on rear outboard seats (except for Europe):**

Adjust the head restraint to its highest position. (See "Head restraints" (P.1-7), "Universal child

restraints for front seat and rear seats" (P.1-15).)

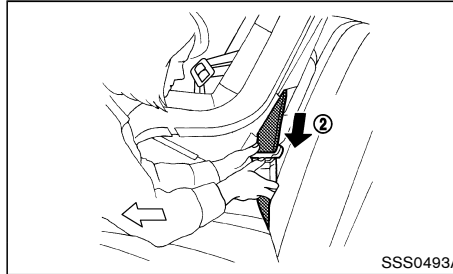

**Step 3**

3. Route the seat belt tongue through the child restraint and insert it into the buckle ② until you hear and feel the latch engage.
4. To prevent slack in the seat belt webbing, it is necessary to secure the seat belt in place with locking devices attached to the child restraint.

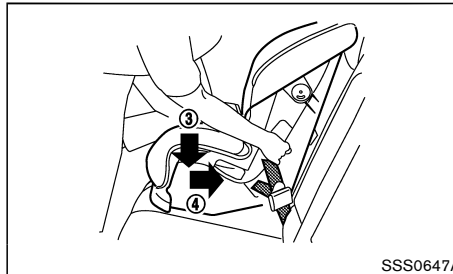

**Step 5**

5. Remove any additional slack from the seat belt; press downward ③ and rearward ④ firmly in the center of the child restraint with your knee to compress the vehicle seat cushion and seatback while pulling up on the seat belt. Adjustable

seatbacks should be positioned to ensure full contact between child restraint and seatback.

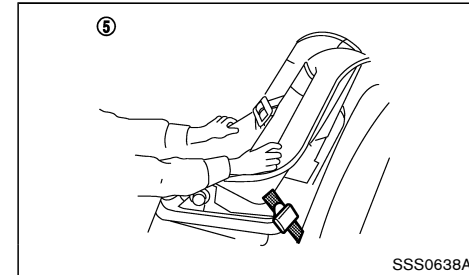

**Step 6**

6. Test the child restraint before you place the child in it ⑤. Push the child restraint from side to side and tug it forward to make sure that it is held securely in place.
7. Check to make sure that the child restraint is properly secured prior to each use. If the child restraint is loose, repeat steps 3 through 5.

### Rear-facing:

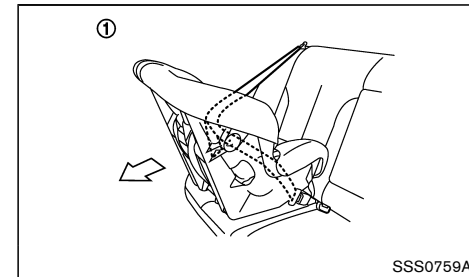

**Step 1**

Be sure to follow the manufacturer's instructions for the proper use of your child restraint. Follow these

steps to install a rear-facing child restraint on the rear seats using 3-point type seat belt without automatic locking mode:

1. Position the child restraint on the seat ①.

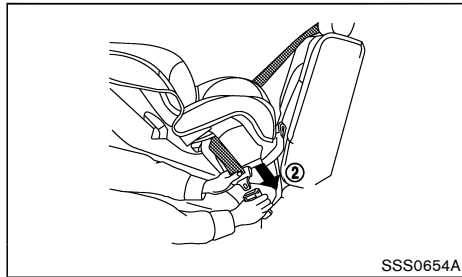

**Step 2**

2. Route the seat belt tongue through the child restraint and insert it into the buckle ② until you hear and feel the latch engage.
3. To prevent slack in the seat belt webbing, it is necessary to secure the seat belt in place with locking devices attached to the child restraint.

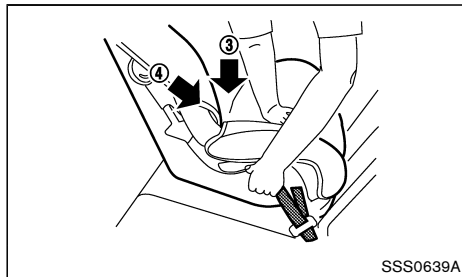

**Step 4**

4. Remove any additional slack from the seat belt; press downward ③ and rearward ④ firmly in the center of the child restraint with your hand to compress the vehicle seat cushion and seatback while pulling up on the seat belt.

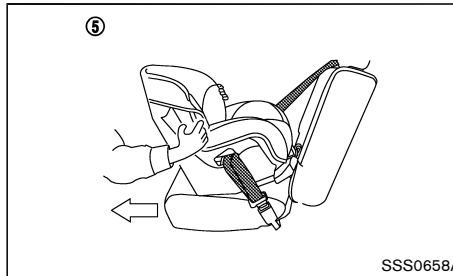

**Step 5**

5. Test the child restraint before you place the child in it ⑤. Push the child restraint from side to side and tug it forward to make sure that it is held securely in place.
6. Check to make sure that the child restraint is properly secured prior to each use. If the child restraint is loose, repeat steps 3 through 5.

## 1-24 Safety — seats, seat belts and supplemental restraint system

## Installation on front passenger's seat

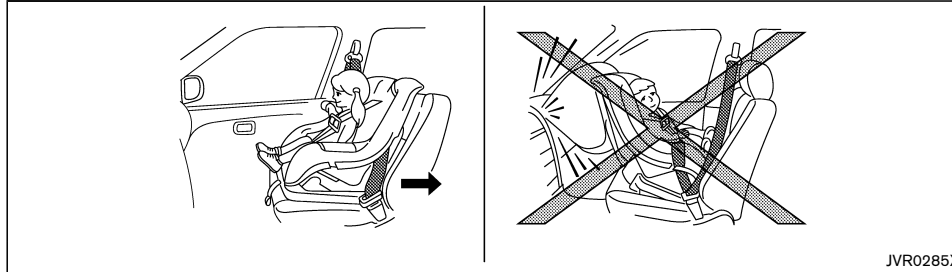

JVR0285X

For Europe (Mass group II and III)

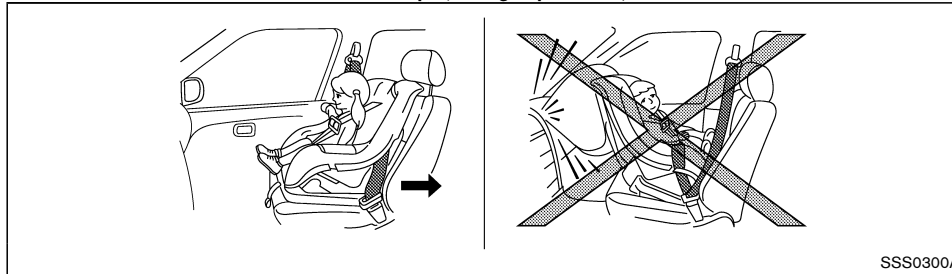

SSS0300A

For Europe (except for Mass group II and III) and except for Europe

**WARNING:**

- Never install a rear-facing child restraint on the front passenger's seat when the front passenger's air bag is available. Supplemental front-impact air bags inflate with great force. A rear-facing child restraint could be struck by the supplemental front-impact air bags in an accident and could seriously injure or kill your child.

- Never install a child restraint with a top tether strap on the front seat.
- NISSAN recommends that a child restraint be installed on the rear seat. However, if you must install a child restraint on the front passenger's seat, move the passenger's seat to the rearmost position.
- Child restraints for infants must be used in the rear-facing direction and therefore must not be used on the front passenger's seat

when the front passenger's air bag is available.

**Front-facing:**

Be sure to follow the manufacturer's instructions for the proper use of your child restraint. Follow these steps to install a front-facing child restraint on the front passenger's seat using 3-point type seat belt without automatic locking mode:

1. Turn off the front passenger's air bag using the front passenger air bag switch (if equipped). (See "Supplemental air bag systems" (P.1-32).) Place the ignition switch in the "ON" position and make sure that the front passenger air bag status light  (OFF) illuminates. (if equipped)

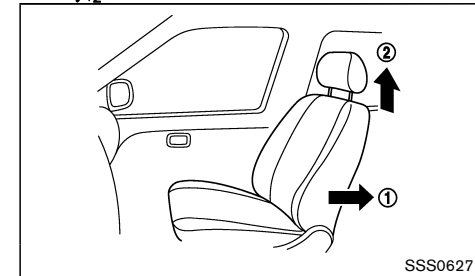

SSS0627

**Steps 2 and 3**

2. Move the seat to the rearmost position ①.
3. **For Europe (Mass group II and III):**

Remove the head restraint ②. (See "Head restraints" (P.1-7), "Universal child restraints for front seat and rear seats" (P.1-15).)

**For Europe (except for Mass group II and III):**  
**Except for Europe:**

Adjust the head restraint ② to its highest

position. (See “Head restraints” (P.1-7), “Universal child restraints for front seat and rear seats” (P.1-15).)

4. Position the child restraint in the seat.

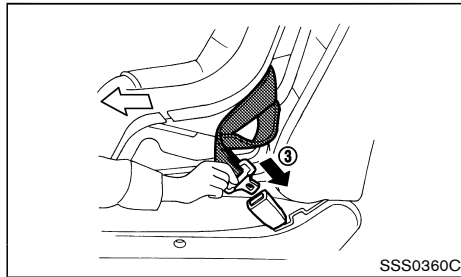

**Step 5**

5. Route the seat belt tongue through the child restraint and insert it into the buckle ③ until you hear and feel the latch engage.

6. To prevent slack in the seat belt webbing, it is necessary to secure the seat belt in place with locking devices attached to the child restraint.

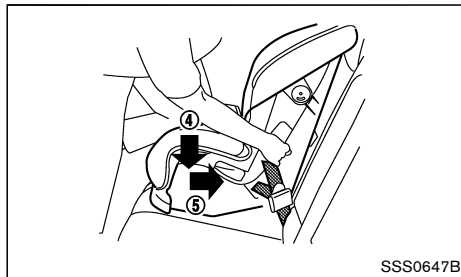

**Step 7**

7. Remove any additional slack from the seat belt; press downward ④ and rearward ⑤ firmly in the center of the child restraint with your knee to compress the vehicle seat cushion and seatback while pulling up on the seat belt.

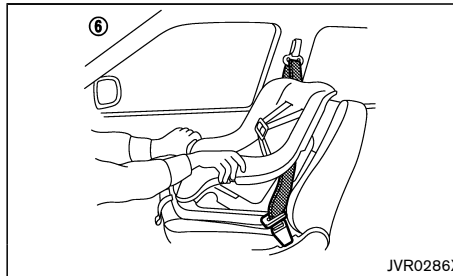

JVR0286X

**Step 8 (for Europe (Mass group II and III))**

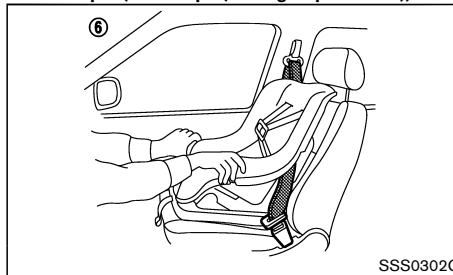

SSS0302G

**Step 8 (For Europe (except for Mass group II and III) and except for Europe)**

8. Test the child restraint before you place the child in it ⑥. Push the child restraint from side to side and tug it forward to make sure that it is held securely in place.

9. Check to make sure that the child restraint is properly secured prior to each use. If the child restraint is loose, repeat steps 6 through 8.

**1-26 Safety — seats, seat belts and supplemental restraint system**



## SUPPLEMENTAL RESTRAINT SYSTEM (SRS)

### PRECAUTIONS ON SUPPLEMENTAL RESTRAINT SYSTEM (SRS)

This Supplemental Restraint System (SRS) section contains important information concerning the driver's and passenger's supplemental front-impact air bags, supplemental side-impact air bags, supplemental curtain side-impact air bags and pre-tensioner seat belts.

#### Supplemental front-impact air bag system

This system can help cushion the impact force to the head and chest area of the driver and/or front passenger in certain frontal collisions. The supplemental front-impact air bag is designed to inflate on the front where the vehicle is impacted.

#### Supplemental side-impact air bag system (if equipped)

This system can help cushion the impact force to the chest area of the driver and front passenger in certain side-impact collisions. The supplemental side-impact air bag is designed to inflate on the side where the vehicle is impacted.

#### Supplemental curtain side-impact air bag system (if equipped)

This system can help cushion the impact force to the head of the driver and passengers in front and rear outboard seating positions in certain side-impact collisions. The supplemental curtain side-impact air bag is designed to inflate on the side where the vehicle is impacted.

The SRS is designed to **supplement** the accident protection provided by the driver's and passenger's seat belts and **is not** designed to **substitute** for them. The SRS can help save lives and reduce serious injuries. However, inflating air bags may cause abra-

sions or other injuries. Air bags do not provide protection to the lower body. Seat belts should always be correctly worn and the occupants should always be seated a suitable distance away from the steering wheel and instrument panel. (See "Seat belts" (P.1-9).) The air bags inflate quickly in order to help protect the occupants. The force of the air bags inflating can increase the risk of injury if the occupants are too close to, or are against, the air bag modules during inflation. The air bags will deflate quickly after deployment.

**The SRS operates only when the ignition switch is in the "ON" position.**

**When the ignition switch is in the "ON" position, the SRS air bag warning light illuminates for about 7 seconds and then turns off. This indicates that the SRS air bag system is operational.** (See "SRS air bag warning light" (P.1-31).)

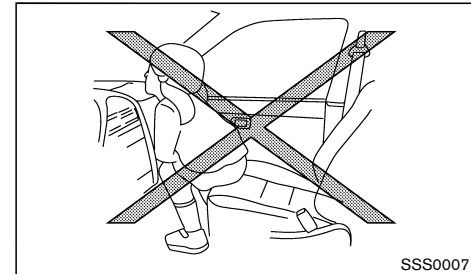
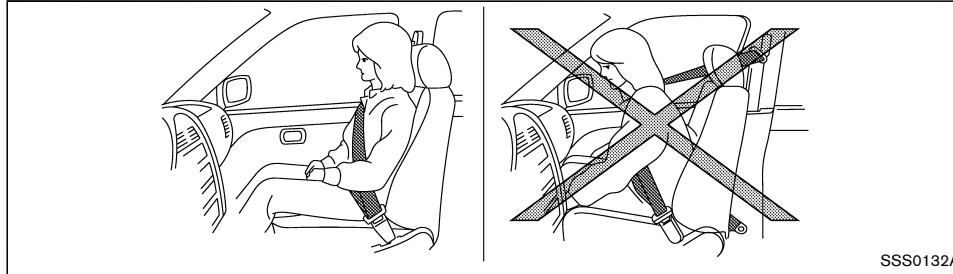
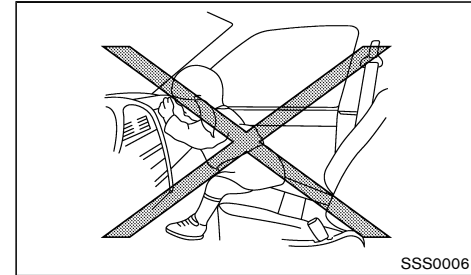
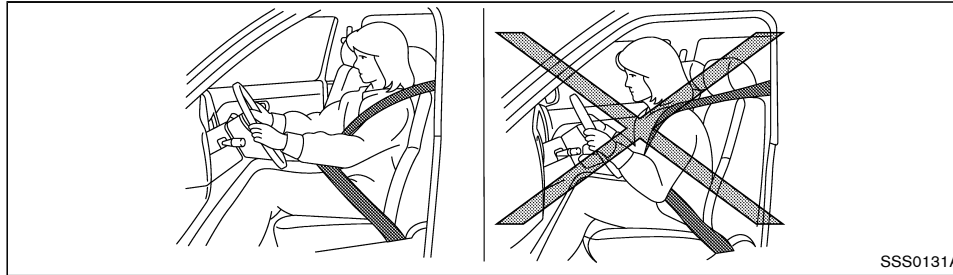

**WARNING:**

- The supplemental front-impact air bags ordinarily will not inflate in the event of a side impact, rear impact, rollover, or lower severity frontal collision. Always wear the seat belts to help reduce the risk or severity of injury in accidents.
- The seat belts and the supplemental front-impact air bags are most effective when you are sitting well back and upright in the seat. The front-impact air bags inflate with great force. If you and your passengers are unres-

trained, leaning forward, sitting sideways, or out of position in any way, you and your passengers are at greater risk of injury or death in an accident. You and your passengers may also receive serious or fatal injuries from the supplemental front-impact air bag if you are up against it when it inflates. Always sit back against the seat-back and as far away as practical from the steering wheel or instrument panel. Always use the seat belts.

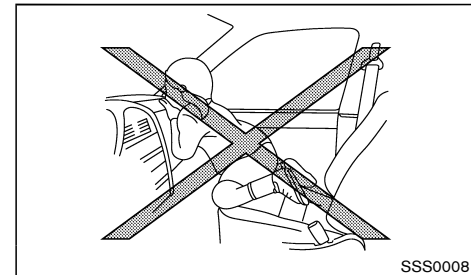

1-28 Safety — seats, seat belts and supplemental restraint system

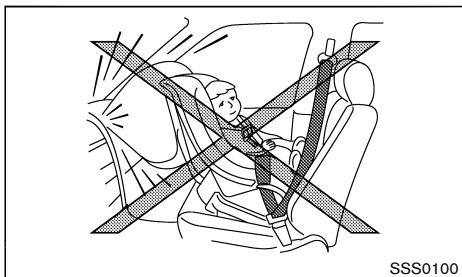
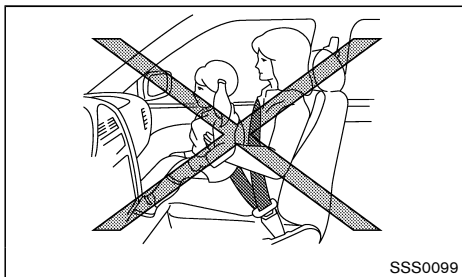
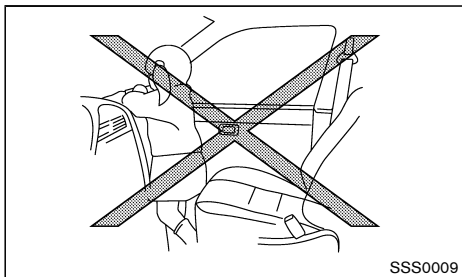

- ⚠ WARNING:**
- Never let children ride unrestrained or extend their hands or face out of the window. Do not attempt to hold them in your lap or arms. Some examples of dangerous riding positions are shown in the illustrations.
  - Children may be severely injured or killed when the supplemental front-impact air bags, supplemental side-impact air bags, or supplemental curtain side-impact air bags inflate if they are not properly restrained.
  - Never install a rear-facing child restraint system on the front seat. An inflating supplemental front-impact air bag could seriously injure or kill your child. (See "Child restraints" (P.1-14).)

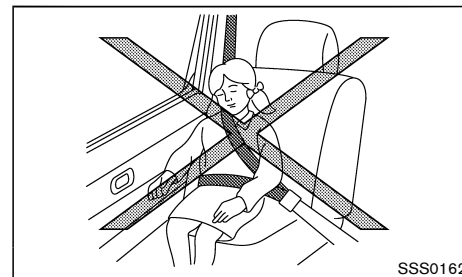
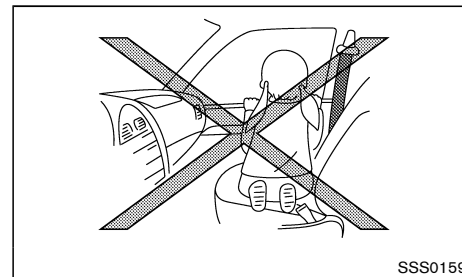
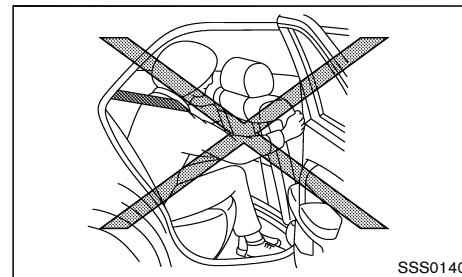
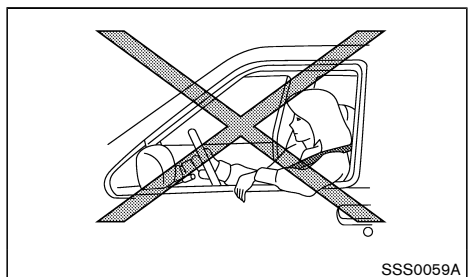

**! WARNING:**

- The supplemental side-impact air bags and supplemental curtain side-impact air bags ordinarily will not inflate in the event of a front impact, rear impact, rollover, or lower severity side collision. Always wear the seat belts to help reduce the risk or severity of injury in accidents.
- The seat belts and the supplemental side-impact air bags and supplemental curtain side-impact air bags are most effective when you are sitting well back and upright in the seat. The supplemental side-impact air bags and supplemental curtain side-impact air bags inflate with great force. If you and your passengers are unrestrained, leaning forward, sitting sideways, or out of position in any way, you and your passengers are at greater risk of injury or death in an accident.
- Do not allow anyone to place their hands, legs, or face near the supplemental side-impact air bags and supplemental curtain side-impact air bags on the sides of the seatback of the front seats or near the side roof rails. Do not allow anyone sitting in the front seats or rear outboard seats to extend their hands out of the windows or lean against the doors. Some examples of dangerous riding positions are shown in the illustrations.
- When sitting in the rear seats, do not hold onto the seatback of the front seats. If the supplemental side-impact air bags and supplemental curtain side-impact air bags inflate, you may be seriously injured. Be especially careful with children, who should

always be properly restrained.

- Do not use seat covers on the front seatbacks. They may interfere with the supplemental side-impact air bag inflations.

#### Pre-tensioner seat belt system

The pre-tensioner seat belt system activates in conjunction with the supplemental front-impact air bag. Working with the seat belt retractor and anchor, it helps tighten the seat belt the instant the vehicle becomes involved in certain types of collisions, helping to restrain front seat occupants. (See "Pre-tensioner seat belt system " (P.1-36).)

#### Air bag warning labels

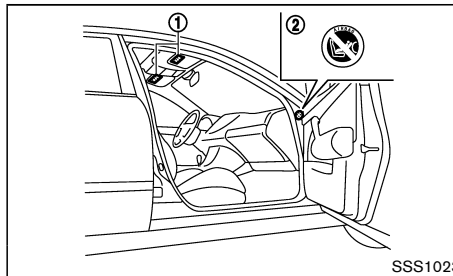

Warning labels about the supplemental air bag system are placed in the vehicle as shown in the illustration.

The warning label ① is located on the surface of the driver's and/or passenger's sun visor.

The warning label ② (if equipped) is located on the side of the passenger's side body panel.

The label(s) warn you not to fit a rear-facing child restraint system on the front passenger seat as such a restraint system used in this position could cause

serious injury to the infant in case of air bag deployment during a collision.

#### Type A:



#### ① Air bag warning label (sample)

The label ① design varies depending on the model.

The label warns:

"Extreme Hazard! Do not use a rearward facing child restraint on a seat protected by an airbag in front of it!"

#### Type B:



#### ① Air bag warning label

The label ① warns:

"NEVER use a rearward facing child restraint on a seat

protected by an ACTIVE AIRBAG in front of it, DEATH or SERIOUS INJURY to the CHILD can occur.”

In vehicles equipped with a front-impact passenger air bag system, use a rear-facing child restraint system only on the rear seats.

When installing a child restraint system in your vehicle, always follow the child restraint system manufacturer's instructions for installation. For additional information, see "Child restraints" (P.1-14).

### SRS air bag warning light



The SRS air bag warning light, displaying  in the meter, monitors the circuits for the air bag systems, pre-tensioner seat belt systems and all related wiring.

When the ignition switch is in the "ON" position, the SRS air bag warning light illuminates for about 7 seconds and then turns off. This indicates that the SRS air bag systems are operational.

If any of the following conditions occur, the air bag and/or pre-tensioner seat belt systems need servicing:

- The SRS air bag warning light remains on after approximately 7 seconds.

- The SRS air bag warning light flashes intermittently.
- The SRS air bag warning light does not illuminate at all.

Under these conditions, the air bag and/or pre-tensioner seat belt systems may not operate properly. They must be checked and repaired. Contact a NISSAN dealer immediately.

## SUPPLEMENTAL AIR BAG SYSTEMS

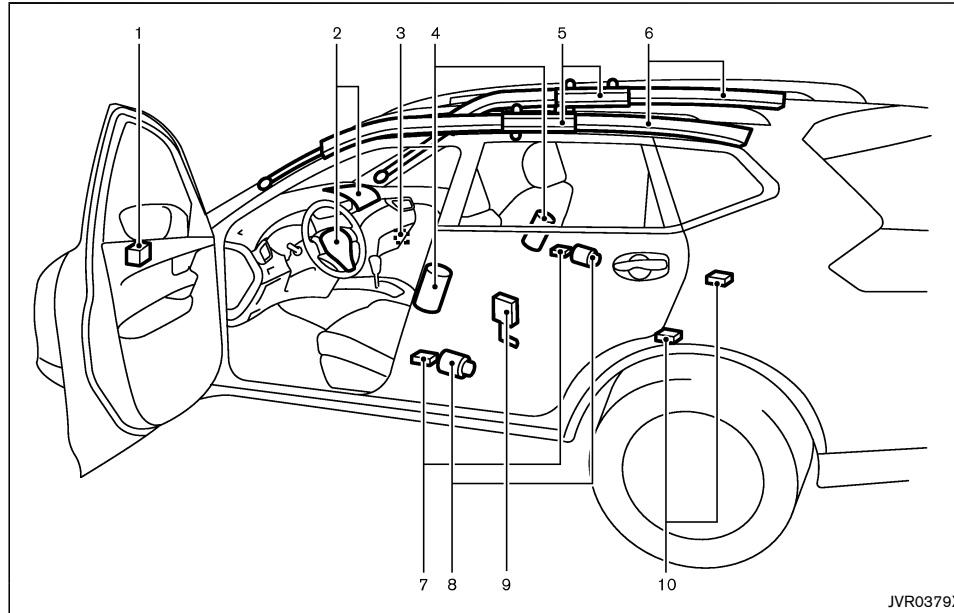

- |   |  |
|---|--|
| 1. Crash zone sensor  | 7. Satellite sensors (if equipped)       |
| 2. Supplemental front-impact air bag modules                        | 8. Pre-tensioner seat belt retractors    |
| 3. Front passenger air bag switch (if equipped)                     | 9. Lap outer pre-tensioner (if equipped) |
| 4. Supplemental side-impact air bag modules (if equipped)           | 10. Satellite sensors (if equipped)      |
| 5. Supplemental curtain side-impact air bag inflators (if equipped) |  |
| 6. Supplemental curtain side-impact air bag modules (if equipped)   |  |

**⚠ WARNING:**

- Do not place any objects on the steering wheel pad, on the instrument panel, and near the front door finishers and the front

seats. Do not place any objects between any occupants and the steering wheel pad, on the instrument panel, and near the front door finishers and the front seats. Such objects may become dangerous projectiles and cause injury if a supplemental air bag inflates.

- Immediately after inflation, several supplemental air bag system components will be hot. Do not touch them: you may severely burn yourself.
- No unauthorized changes should be made to any components or wiring of the supplemental air bag systems. This is to prevent accidental inflation of the supplemental air bags or damage to the supplemental air bag systems.
- Do not make unauthorized changes to your vehicle's electrical system, suspension system, front end structure, and side panels. This could affect proper operation of the supplemental air bag systems.
- Tampering with the supplemental air bag systems may result in serious personal injury. Tampering includes changes to the steering wheel and the instrument panel by placing materials over the steering wheel pad and above, around or on the instrument panel or by installing additional trim materials around the supplemental air bag systems.
- Work around and on the supplemental air bag systems should be done by a NISSAN dealer. The SRS wiring should not be modified or disconnected. Unauthorized electrical test equipment and probing de-

### 1-32 Safety — seats, seat belts and supplemental restraint system

vices should not be used on the supplemental air bag systems.

- The SRS wiring harness connectors are yellow and/or orange for easy identification.

When the air bags inflate, a fairly loud noise may be heard, followed by the release of smoke. This smoke is not harmful and does not indicate a fire. Care should be taken not to inhale it, as it may cause irritation and choking. Those with a history of a breathing condition should get fresh air promptly.

#### Supplemental front-impact air bag system

The driver's supplemental front-impact air bag is located at the center of the steering wheel. The passenger's supplemental front-impact air bag is located at the instrument panel above the glove box.

The supplemental front-impact air bag system is designed to inflate in higher severity frontal collisions, although it may inflate if the forces in another type of collision are similar to those of a higher severity frontal impact. It may not inflate in certain frontal collisions. Vehicle damage (or lack of it) is not always an indication of proper supplemental front-impact air bag system operation.

#### Front passenger air bag status light (if equipped):

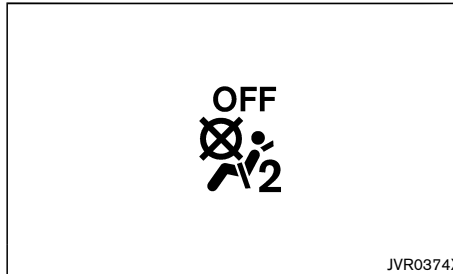

OFF light





ON light

The front passenger air bag status light is located on the instrument panel.

When the ignition switch is placed in the "ON" position, the front passenger air bag status ON and OFF lights illuminate and then turn off or remain on depending on the front passenger air bag status.

- When the ignition switch is placed in the "ON" position and the front passenger air bag is active, the front passenger air bag status OFF light  will turn off after about 7 seconds.

The front passenger air bag status ON light  will illuminate and then turn off after 1 minute when the front passenger air bag switch is in the "ON" position.

- When the ignition switch is placed in the "ON" position and the front passenger air bag is inactive, the front passenger air bag status ON light  will turn off after about 7 seconds.

The front passenger air bag status OFF light  will illuminate and remain on as long as the front passenger air bag switch is in the "OFF" position.

If the front passenger air bag status light operates in a way other than described above, the front passenger air bag may not function properly. Have the system checked, and if necessary repaired, by a NISSAN dealer promptly.

#### Front passenger air bag switch (if equipped):

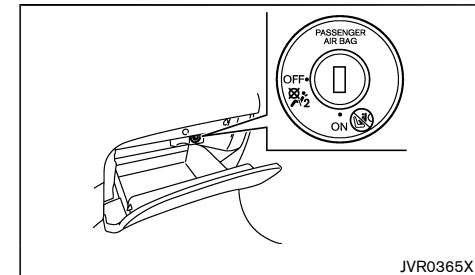



The front passenger air bag can be turned off with the front passenger air bag switch located in the glove box.

To turn off the front passenger air bag:

1. Place the ignition switch in the "OFF" position.

- Open the glove box and insert the mechanical key into the front passenger air bag switch. For the mechanical key usage, see "Keys" (P.3-2).
- Push and turn the key to the "OFF" position.
- Place the ignition switch in the "ON" position. The front passenger air bag status OFF light  will illuminate and remain on.

To turn on the front passenger air bag:

- Place the ignition switch in the "OFF" position.
- Open the glove box and insert the mechanical key into the front passenger air bag switch.
- Push and turn the key to the "ON" position.
- Place the ignition switch in the "ON" position. The front passenger air bag status ON light  will illuminate.
- After 1 minute, the front passenger air bag status ON light  will turn off.

Supplemental side-impact air bag system (if equipped)

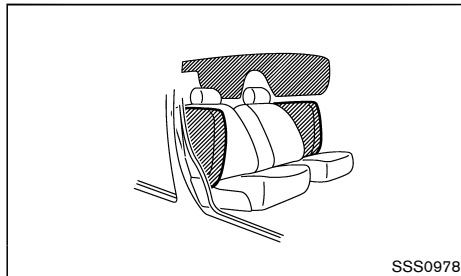

The supplemental side-impact air bag is located at the outside of the front seats' seatbacks.

The supplemental side-impact air bag system is

designed to inflate in higher severity side collisions, although it may inflate if the forces in another type of collision are similar to those of a higher severity side impact. It may not inflate in certain side collisions. Vehicle damage (or lack of it) is not always an indication of proper supplemental side-impact air bag system operation.

Supplemental curtain side-impact air bag system (if equipped)

The supplemental curtain side-impact air bag is located at the roof rails.

The supplemental curtain side-impact air bag system is designed to inflate in higher severity side collisions, although it may inflate if the forces in another type of collision are similar to those of a higher severity side impact. It may not inflate in certain side collisions. Vehicle damage (or lack of it) is not always an indication of proper supplemental curtain side-impact air bag system operation.

**SRS AIR BAG DEPLOYMENT CONDITIONS**

The SRS air bags activate in the event of a front or side impact in which the vehicle occupants may be severely injured even if they are wearing the seat belts properly.

They may not activate when the crash energy is absorbed and/or distributed by the vehicle body. Vehicle damage (or lack of it) is not always an indication of proper SRS air bag system operation.

When the SRS air bag will deploy

**Supplemental front-impact air bags:**

The supplemental front-impact air bag system is designed to inflate in higher severity frontal collisions. Some examples are shown in the following illustrations.

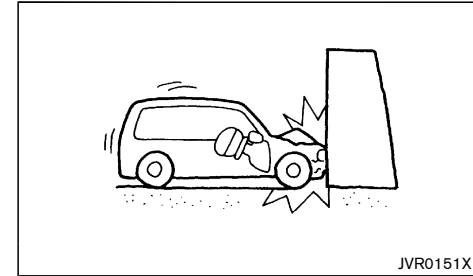

The supplemental front-impact air bag system will deploy in the event of an impact which exceeds a 25 km/h frontal collision with a solid wall that does not move or deform.

The supplemental front-impact air bag system may also deploy when the vehicle receives severe damage to the undercarriage.

## 1-34 Safety — seats, seat belts and supplemental restraint system



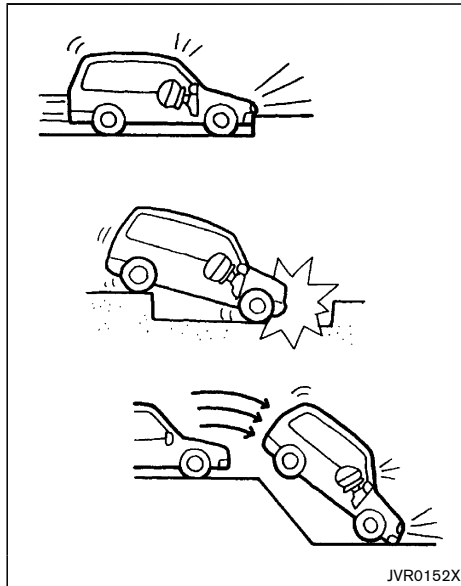

JVR0152X

- Hitting a curb, pavement edge or hard surface at high speed
- Falling into a deep hole or ditch
- Landing hard on the ground after jumping

**Supplemental side-impact and curtain side-impact air bags (if equipped):**

The supplemental side-impact and curtain side-impact air bag systems are designed to inflate in higher severity side collisions. Some examples are shown in the following illustrations.

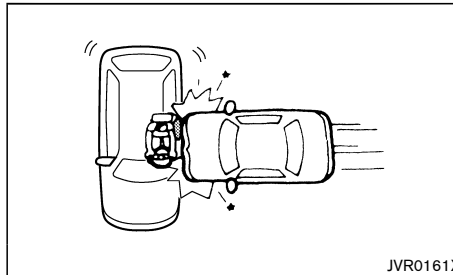

JVR0161X

(supplemental side-impact air bag system)

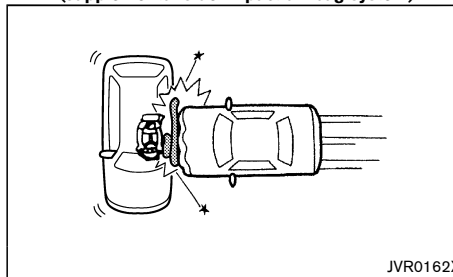

JVR0162X

(supplemental curtain side-impact air bag system)

- The supplemental side-impact and curtain side-impact air bags will deploy in the event of a side impact with a normal passenger vehicle that exceeds at a speed of 25 km/h.

When the SRS air bag is unlikely to deploy

The SRS air bags may not deploy in cases where the impact is not forceful enough to inflate the SRS air bags.

For example, if the vehicle strikes an object, such as a parked vehicle or sign pole, which can move or deform on impact, the SRS air bags are unlikely to deploy.

**Supplemental front-impact air bags:**

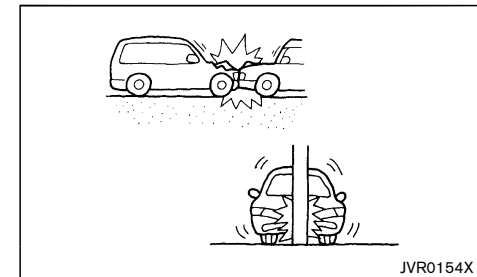

JVR0154X

- Striking a vehicle of the same class that is parked
- Crashing into a solid utility pole

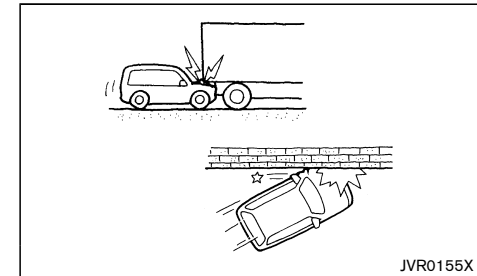

JVR0155X

- Running under the tail gate of a truck
- A frontal offset impact to the guard rails

**Supplemental side-impact and curtain side-impact air bags (if equipped):**

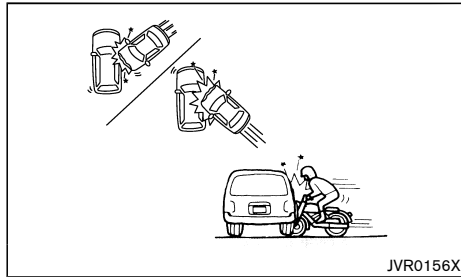

- A collision from the side at an angle
- A side impact with a two-wheeled vehicle

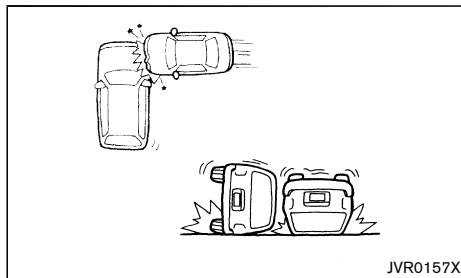

- A collision from the side impacting the vehicle engine room (luggage room)
- Vehicle rollover

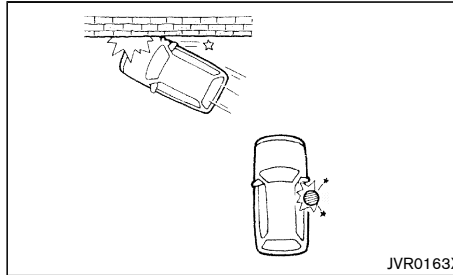

- A frontal offset impact to the guard rails
- A collision with a pole

**When the SRS air bag will not deploy**

Once the SRS air bag has inflated, the air bag module will not function again if your vehicle collides with another vehicle or an object.

Other examples where the SRS air bag will not deploy are shown in the following illustrations.

**Supplemental front-impact air bags:**

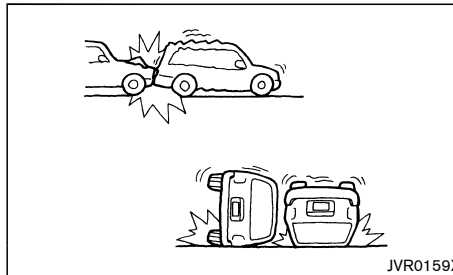

- A collision from the side or rear

- Vehicle rollover

**Supplemental side-impact and curtain side-impact air bags (if equipped):**

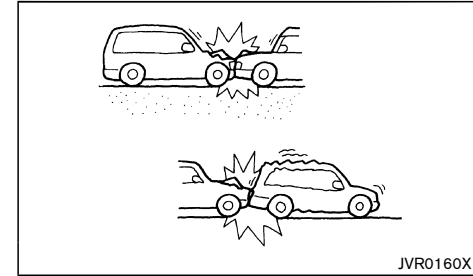

- A frontal collision with a parked or moving vehicle
- A rear collision

**PRE-TENSIONER SEAT BELT SYSTEM**



**WARNING:**

- **The pre-tensioner seat belt cannot be re-used after activation. It must be replaced together with the retractor and buckle as a unit.**
- **If the vehicle becomes involved in a collision but the pre-tensioner is not activated, be sure to have the pre-tensioner system checked and, if necessary, replaced by a NISSAN dealer.**
- **No unauthorized changes should be made to any components or wiring of the pre-tensioner seat belt system. This is to prevent accidental activation of the pre-tensioner seat belt or damage to the pre-tensioner seat belt system.**

- **Work around or on the pre-tensioner seat belt system should be done by a NISSAN dealer. The SRS wiring should not be modified or disconnected. Unauthorized electrical test equipment and probing devices should not be used on the pre-tensioner seat belt system.**
- **If you need to dispose of the pre-tensioner seat belt system, or scrap the vehicle, contact a NISSAN dealer. Correct pre-tensioner disposal procedures are set forth in the appropriate NISSAN Service Manual. Incorrect disposal procedures could cause personal injury.**
- **If you need to dispose of the SRS or scrap the vehicle, contact a NISSAN dealer. Correct disposal procedures are set forth in the appropriate NISSAN Service Manual. Incorrect disposal procedures could cause personal injury.**

The pre-tensioner is encased with the front seat belt's retractor and anchor. These seat belts are used the same as conventional seat belts.

When the pre-tensioner seat belt activates, a fairly loud noise may be heard, followed by the release of smoke. This smoke is not harmful and does not indicate a fire. Care should be taken not to inhale it, as it may cause irritation and choking. Those with a history of a breathing condition should get fresh air promptly.

#### REPAIR AND REPLACEMENT PROCEDURE



#### **WARNING:**

- **Once the air bags have been inflated, the air bag modules will not function and must be replaced. The air bag modules must be replaced by a NISSAN dealer. The inflated air bag modules cannot be repaired.**
- **The air bag systems should be inspected by a NISSAN dealer if there is any damage to the front end portion of the vehicle.**

**MEMO**

**1-38 Safety – seats, seat belts and supplemental restraint system**

Condition: 'Except for China'

[ Edit: 2014/ 11/ 7 Model: T32-A ]

## 2 Instruments and controls

Cockpit .....	2-3	Headlight and turn signal switch .....	2-39
Left-Hand Drive (LHD) model .....	2-3	Headlight switch .....	2-39
Right-Hand Drive (RHD) model .....	2-4	Headlight aiming control .....	2-42
Instrument panel .....	2-5	Battery saver system .....	2-44
Left-Hand Drive (LHD) model .....	2-5	Headlight cleaner (if equipped) .....	2-44
Right-Hand Drive (RHD) model .....	2-6	Turn signal switch .....	2-44
Meters and gauges .....	2-7	Fog light switch .....	2-45
Speedometer and odometer .....	2-7	Front fog lights (if equipped) .....	2-46
Tachometer .....	2-8	Rear fog light (if equipped) .....	2-46
Engine coolant temperature gauge .....	2-9	Wiper and washer switch .....	2-47
Fuel gauge .....	2-9	Windshield wiper and washer switch .....	2-47
Instrument brightness control .....	2-10	Rain-sensing auto wiper system (if equipped) .....	2-48
Continuously Variable Transmission (CVT) position indicator (if equipped) .....	2-10	Rear window wiper and washer switch .....	2-49
Compass (if equipped) .....	2-10	Defogger switch .....	2-49
Zone variation change procedure .....	2-11	Horn .....	2-50
Warning/indicator lights and audible reminders .....	2-12	Windows .....	2-50
Checking bulbs .....	2-13	Power windows .....	2-50
Warning lights .....	2-13	Sunroof (if equipped) .....	2-52
Indicator lights .....	2-17	Automatic sunroof and sunshade .....	2-52
Audible reminders .....	2-19	Power outlets .....	2-53
Vehicle information display .....	2-20	Ashtrays and cigarette lighter (if equipped) .....	2-54
How to use the vehicle information display .....	2-20	Ashtray .....	2-54
Startup display .....	2-21	Cigarette lighter .....	2-54
Settings .....	2-21	Storages .....	2-54
Vehicle information display warnings and indicators .....	2-28	Glove box .....	2-54
Oil control system (for diesel engine model) .....	2-33	Console box .....	2-55
Trip computer .....	2-34	Sunglasses holder .....	2-55
Clock and outside air temperature .....	2-36	Cup holders .....	2-55
Driver Attention Alert (if equipped) .....	2-36	Soft bottle holders .....	2-56
Traffic Sign Recognition (if equipped) .....	2-37	Card holder .....	2-56
		Luggage hooks .....	2-57

Luggage compartment .....	2-57	Room light (if equipped) .....	2-62
Coat hook .....	2-59	Rear personal lights (if equipped) .....	2-63
Tonneau cover (if equipped) .....	2-60	Vanity mirror light .....	2-63
Roof rail (if equipped) .....	2-60	Luggage room light .....	2-63
Sun visors .....	2-61	Battery saver system .....	2-63
Type A .....	2-61	HomeLink® Universal Transceiver (if equipped) .....	2-63
Type B .....	2-61	Programming HomeLink® .....	2-64
Interior lights .....	2-62	Operating the HomeLink® Universal Transceiver .....	2-64
Interior light switch .....	2-62	Programming troubleshooting .....	2-64
Console light .....	2-62	Clearing the programmed information .....	2-65
Map lights .....	2-62	Reprogramming a single HomeLink® button .....	2-65
		If your vehicle is stolen .....	2-65

## COCKPIT

### LEFT-HAND DRIVE (LHD) MODEL

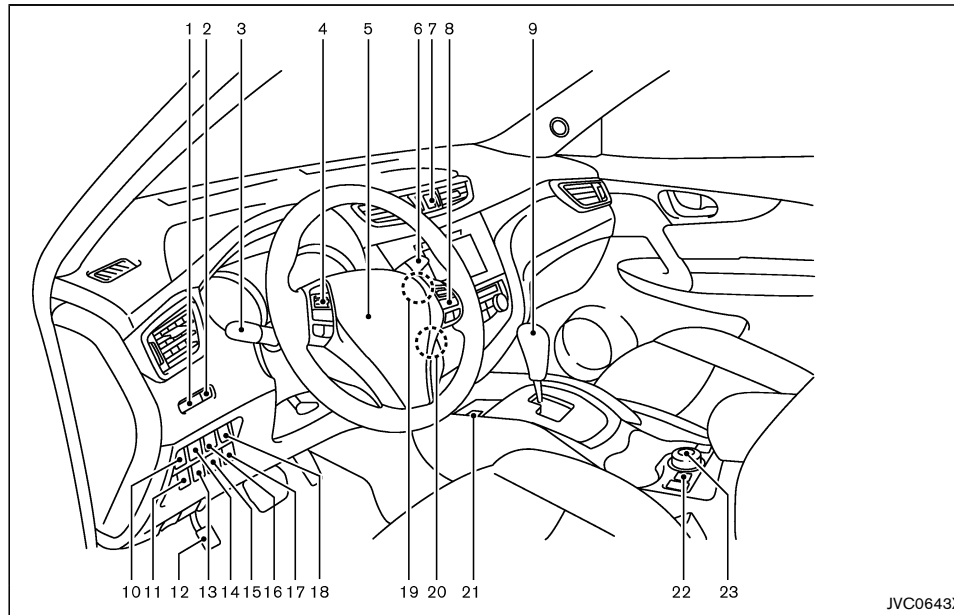

- |  |   |
|--|---|
| 1. Instrument brightness control                           | — Bluetooth® Hands-Free Phone System (with navigation)* |
| 2. TRIP RESET switch                                       |   |
| 3. Headlight and turn signal switch/Fog light switch*      | 5. Steering wheel                                       |
| 4. Steering-wheel-mounted controls (left side)             | — Horn  |
| — Audio control* or Navigation system **                   | 6. Wiper and washer switch                              |
| — Vehicle information display control                      | 7. Hazard indicator flasher switch                      |
| — Bluetooth® Hands-Free Phone System (without navigation)* | 8. Steering-wheel-mounted controls (right side)         |
|  | — Cruise control switches*                              |

- Speed limiter switches\*
  - Bluetooth® Hands-Free Phone System (without navigation)\*
  - Bluetooth® Hands-Free Phone System (with navigation)\*
  - Voice recognition system switch\*
9. Shift lever
- Continuously Variable Transmission (CVT)
  - Manual Transmission (MT)
10. Vehicle Dynamic Control (VDC) OFF switch or Electronic Stability Program (ESP) OFF switch
11. Headlight aiming control switch\*
12. Parking brake (Pedal type)\*
13. ECO switch\*
14. Headlight cleaner switch\*
15. Parking sensor (sonar) system OFF switch\*
16. Power back door switch\*
17. Stop/Start OFF switch\*
18. Power back door main switch\*
19. Push-button ignition switch (model with Intelligent Key system)\*
20. Ignition switch (model without Intelligent Key system)\*
21. Parking brake (Switch type)\*
22. Hill descent control switch\*
23. Four-Wheel Drive (4WD) mode switch\*

\*: if equipped

\*\* : See the separate Navigation System Owner's Manual (if equipped).

## RIGHT-HAND DRIVE (RHD) MODEL

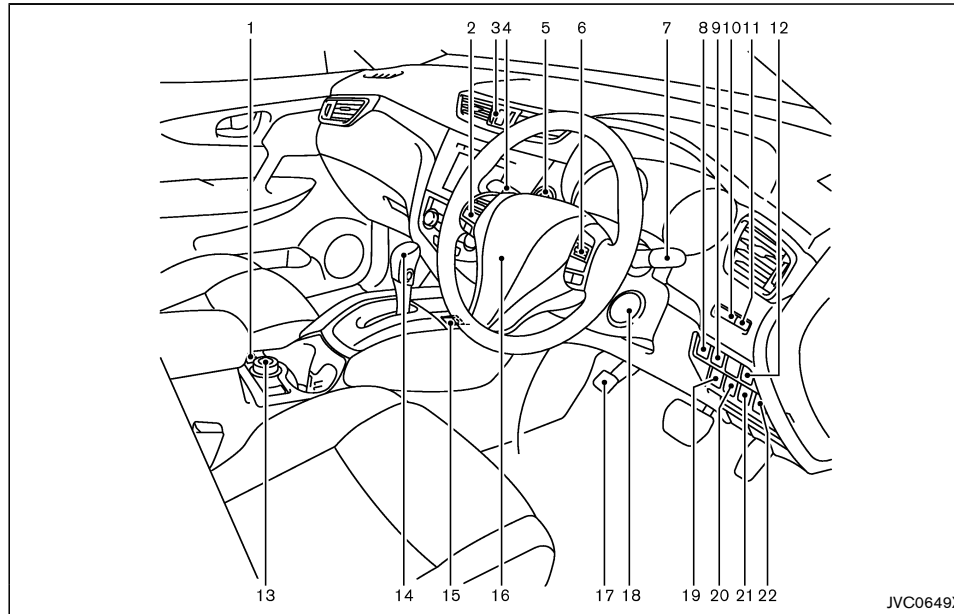

- |   |  |
|---|--|
| <p>1. Hill descent control switch*</p> <p>2. Steering-wheel-mounted controls (left side)</p> <ul style="list-style-type: none"> <li>— Audio control* or Navigation system **</li> <li>— Vehicle information display control</li> <li>— Bluetooth® Hands-Free Phone System (without navigation)*</li> <li>— Bluetooth® Hands-Free Phone System (with navigation)*</li> </ul> | <p>3. Hazard indicator flasher switch</p> <p>4. Headlight and turn signal switch/Fog light switch* or Wiper and washer switch</p> <p>5. Push-button ignition switch (model with Intelligent Key system)*</p> <p>6. Steering-wheel-mounted controls (right side)</p> <ul style="list-style-type: none"> <li>— Cruise control switches*</li> <li>— Speed limiter switches*</li> <li>— Bluetooth® Hands-Free Phone System (with-</li> </ul> |
|---|--|

- out navigation)\*
  - Bluetooth® Hands-Free Phone System (with navigation)\*
  - Voice recognition system switch\*
7. Wiper and washer switch or Headlight and turn signal switch/Fog light switch\*
8. Power back door main switch\*
9. Power back door switch\*
10. Instrument brightness control
11. TRIP RESET switch
12. Vehicle Dynamic Control (VDC) OFF switch or Electronic Stability Program (ESP) OFF switch
13. Four-Wheel Drive (4WD) mode switch\*
14. Shift lever
- Continuously Variable Transmission (CVT)
  - Manual Transmission (MT)
15. Parking brake (Switch type)\*
16. Steering wheel
- Horn
17. Parking brake (Pedal type)\*
18. Ignition switch (model without Intelligent Key system)\*
19. Stop/Start or Idling Stop OFF switch\*
20. Parking sensor (sonar) system OFF switch\*
21. ECO switch\*
22. Headlight aiming control switch\*
- \*: if equipped
- \*\* : See the separate Navigation System Owner's Manual (if equipped).

## 2-4 Instruments and controls



## INSTRUMENT PANEL

### LEFT-HAND DRIVE (LHD) MODEL

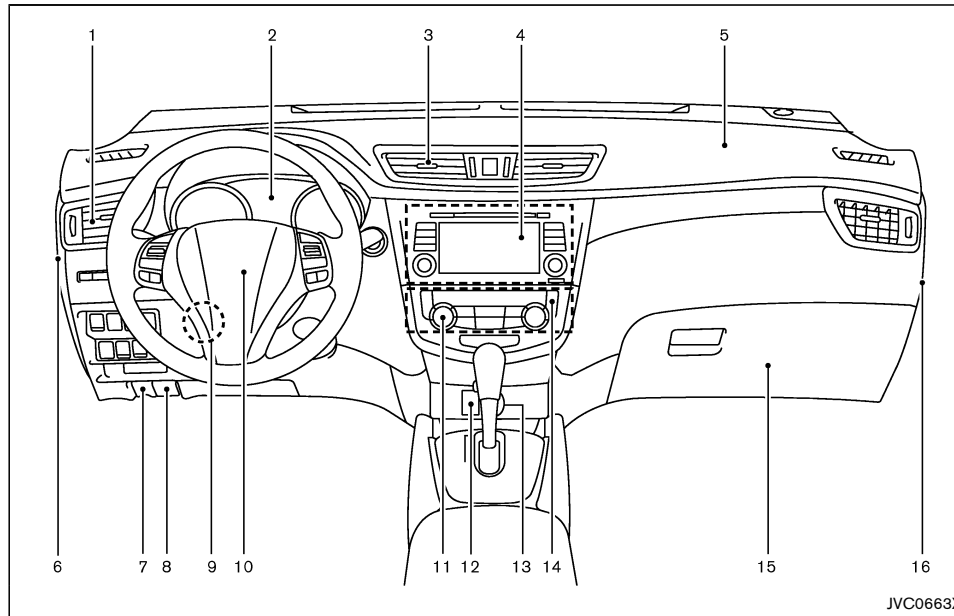

- |  |   |
|--|---|
| 1. Side ventilator   | — Bluetooth® Hands-Free Phone System (with navigation)* |
| 2. Meters and gauges/Clock                                 | — Voice Recognition System*                             |
| 3. Center ventilator                                       | 5. Passenger's front-impact air bag                     |
| 4. Audio system* or Navigation system**                    | 6. Fuse box cover                                       |
| — Rear view monitor*                                       | 7. Fuel filler lid release handle                       |
| — Around view monitor*                                     | 8. Hood release handle                                  |
| — Bluetooth® Hands-Free Phone System (without navigation)* | 9. Steering wheel lock lever                            |

10. Driver's front-impact air bag/Horn  
 11. Heater/air conditioner control  
 12. Auxiliary input jack\* and USB port\*  
 13. Power outlet\*/Cigarette lighter\*  
 14. Defogger switch  
 15. Glove box  
 16. Fuse box cover\*
- \*: if equipped  
 \*\*: See the separate Navigation System Owner's Manual (if equipped).

## RIGHT-HAND DRIVE (RHD) MODEL

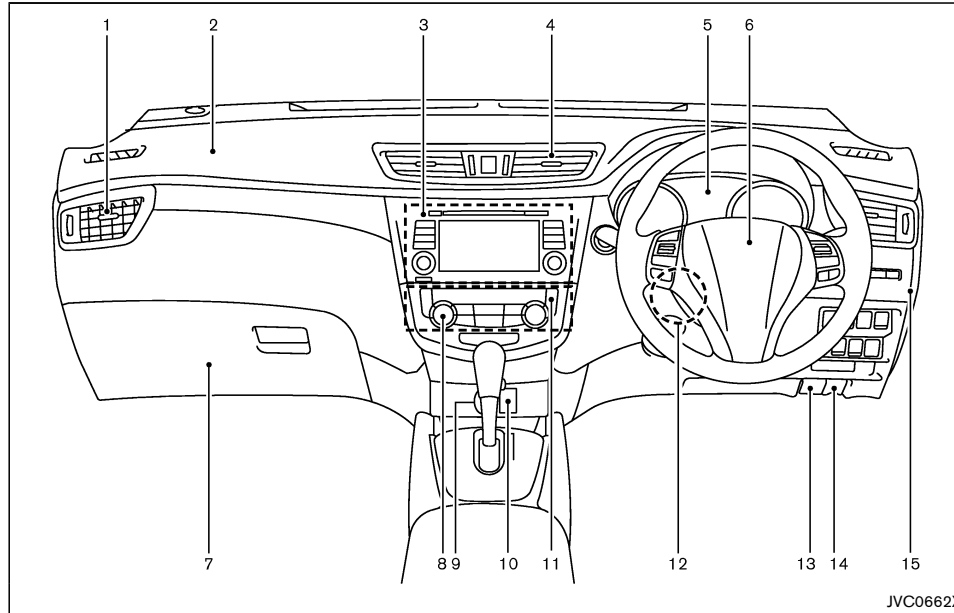

- |   |                                       |
|---|---------------------------------------|
| 1. Side ventilator  | — Voice Recognition System*           |
| 2. Passenger's front-impact air bag                             | 4. Center ventilator                  |
| 3. Audio system* or Navigation system**                         | 5. Meters and gauges/Clock            |
| — Rear view monitor*  | 6. Driver's front-impact air bag/Horn |
| — Around view monitor*  | 7. Glove box                          |
| — Bluetooth® Hands-Free Phone System (with-<br>out navigation)* | — Fuse box                            |
| — Bluetooth® Hands-Free Phone System (with<br>navigation)*      | 8. Heater/air conditioner control     |
|   | 9. Power outlet*/Cigarette lighter*   |

10. Auxiliary input jack\* and USB port\*

11. Defogger switch

12. Steering wheel lock lever

13. Hood release handle

14. Fuel filler lid release handle

15. Fuse box cover\*

\*: if equipped

\*\*: See the separate Navigation System Owner's  
Manual (if equipped).

## 2-6 Instruments and controls

## METERS AND GAUGES

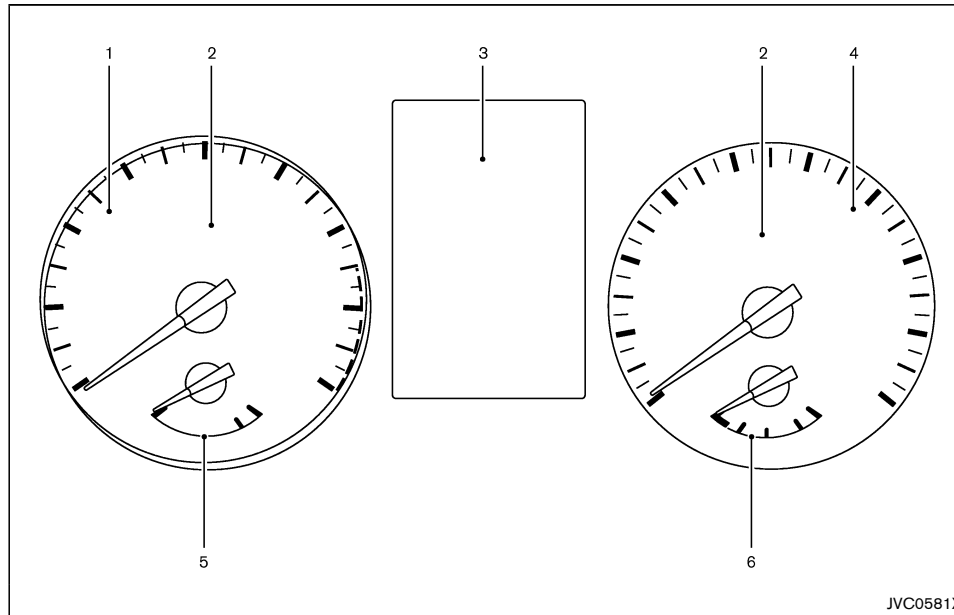

1. Tachometer
2. Warning/indicator lights
3. Vehicle information display  
— Odometer/twin trip odometer
4. Speedometer
5. Engine coolant temperature gauge
6. Fuel gauge

## SPEEDOMETER AND ODOMETER

### Speedometer

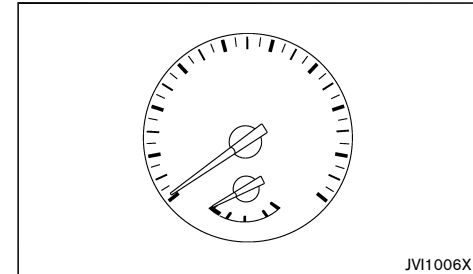

The speedometer indicates the vehicle speed (km/h or MPH).

Odometer (except for Europe, Australia, New Zealand and South Africa)

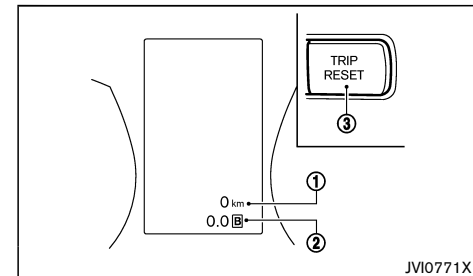

**Odometer/Twin trip odometer:**

The odometer/twin trip odometer is displayed in the vehicle information display when the ignition switch is in the "ON" position.

The odometer ① displays the total distance the vehicle has been driven.

The twin trip odometer ② displays the distance of individual trips.

**Changing twin trip odometer display:**

Push the TRIP RESET switch ③ (located on the instrument panel) to change the display as follows:

TRIP A → TRIP B → TRIP A

**Resetting twin trip odometer:**

Push the TRIP RESET switch ③ for more than 1 second to reset the trip odometer to zero.

Distance to empty (dte — km or mile)/  
Odometer (for Europe, Australia, New Zealand and South Africa)

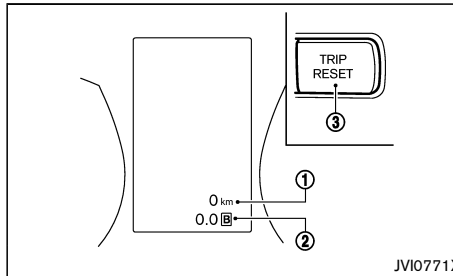
**Distance to empty (dte — km or mile):**

The distance to empty (dte) ① provides you with an estimation of the distance that can be driven before refueling. The dte is constantly being calculated, based on the amount of fuel in the fuel tank and the actual fuel consumption.

The display is updated every 30 seconds.

The dte mode includes a low range warning feature. If the fuel level is low, the warning is displayed on the screen.

When the fuel level drops even lower, the dte display will change to "——".

- If the amount of fuel added is small, the display just before the ignition switch is placed in the "OFF" position may continue to be displayed.
- When driving uphill or rounding curves, the fuel in the tank shifts, which may momentarily change the display.

**Odometer/Twin trip odometer:****Odometer/Twin trip odometer:**

The odometer/twin trip odometer is displayed in the vehicle information display when the ignition switch is in the "ON" position.

The odometer ② displays the total distance the vehicle has been driven.

The twin trip odometer ② displays the distance of individual trips.

**Changing twin trip odometer display:**

Push the TRIP RESET switch ③ (located on the instrument panel) to change the display as follows:

ODO → TRIP A → TRIP B → ODO

**Resetting twin trip odometer:**

Push the TRIP RESET switch ③ for more than 1 second to reset the trip odometer to zero.

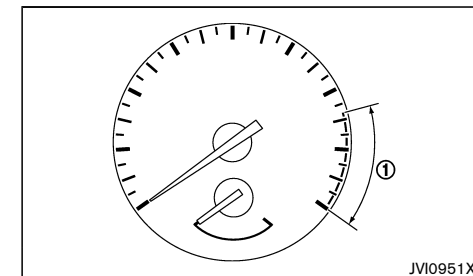
**TACHOMETER**

The tachometer indicates the engine speed in revolutions per minute (rpm). **Do not rev the engine into the red zone ①.**

The red zone varies with models.

**2-8 Instruments and controls**

## ENGINE COOLANT TEMPERATURE GAUGE

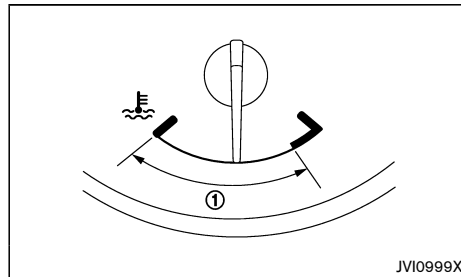

Type A

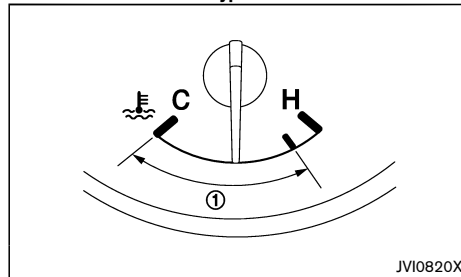

Type B

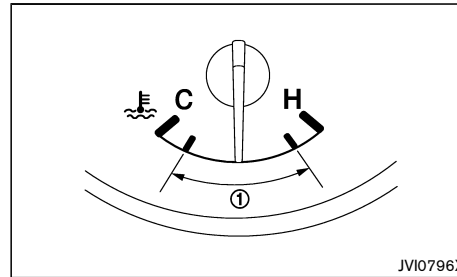

Type C

The engine coolant temperature gauge indicates the engine coolant temperature.

The engine coolant temperature is normal when the gauge needle points within the zone ① shown in the illustration.

The engine coolant temperature will vary with the outside air temperature and driving conditions.

### ⚠ CAUTION:

- If the gauge indicates the engine coolant temperature is near the hot (H) end of the normal range, reduce vehicle speed to decrease the temperature.
- If the gauge is over the normal range, stop the vehicle as soon as safely possible and let the engine idle.
- If the engine is overheated, continued operation of the vehicle may seriously damage the engine. (See "If your vehicle overheats" (P.6-10) for immediate action required.)

## FUEL GAUGE

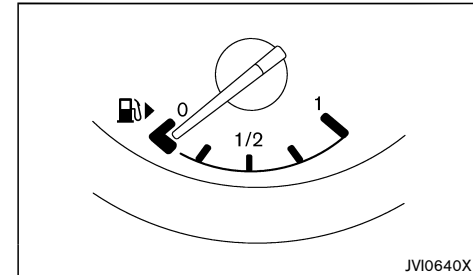

The fuel gauge indicates the approximate fuel level in the tank when the ignition switch is in the "ON" position.

The gauge may move slightly during braking, turning, accelerating, or going up and down hills due to movement of fuel in the tank.

The low fuel warning  appears on the vehicle information display when the fuel level in the tank is getting low. Refuel as soon as it is convenient, preferably before the gauge reads 0 (empty).

The arrow, , indicates the fuel filler lid is located on the right side of the vehicle.

### ⚠ CAUTION:

**Refuel before the gauge reads the empty (0) position.**

There is a small reserve of fuel in the tank when the fuel gauge reads the empty (0) position.

## INSTRUMENT BRIGHTNESS CONTROL

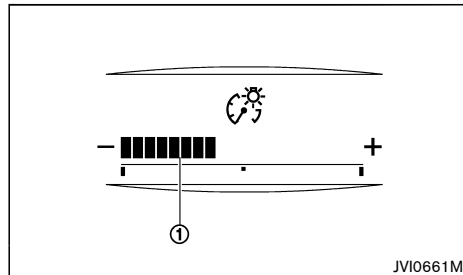
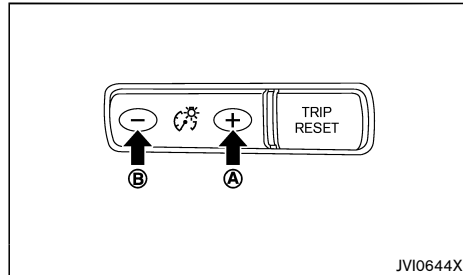

The instrument brightness control switch can be operated when the ignition switch is in the "ON" position. When the switch is operated, the vehicle information display switches to the brightness adjustment mode.

Push the + side of the switch (A) to brighten the meter panel lights and instrument panel lights (if equipped). The bar (1) moves to the + side.

Push the - side of the switch (B) to dim the lights. The bar (1) moves to the - side.

The vehicle information display returns to the normal

display when the instrument brightness control switch is not operated for more than 5 seconds.

## CONTINUOUSLY VARIABLE TRANSMISSION (CVT) POSITION INDICATOR (if equipped)

The Continuously Variable Transmission (CVT) position indicator indicates the shift lever position when the ignition switch is in the "ON" position.

## COMPASS (if equipped)

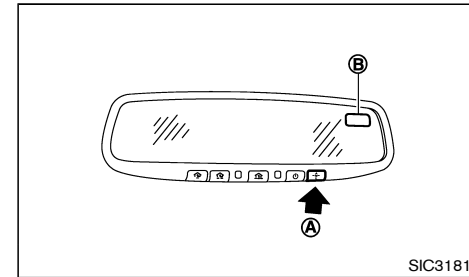

When the ignition switch is placed in the "ON" position, the compass display (B) will indicate the direction the vehicle is heading.

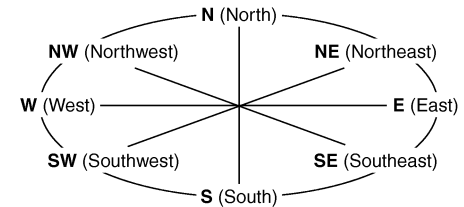

If the display reads "C", calibrate the compass by driving the vehicle in 3 complete circles at less than 8 km/h (5 MPH). You can also calibrate the compass by driving your vehicle on your everyday route. The compass will be calibrated once it has tracked 3 complete circles.

To turn on and off the compass manually, push the  switch (A) while the ignition switch is in the "ON" position.

## 2-10 Instruments and controls

## ZONE VARIATION CHANGE PROCEDURE

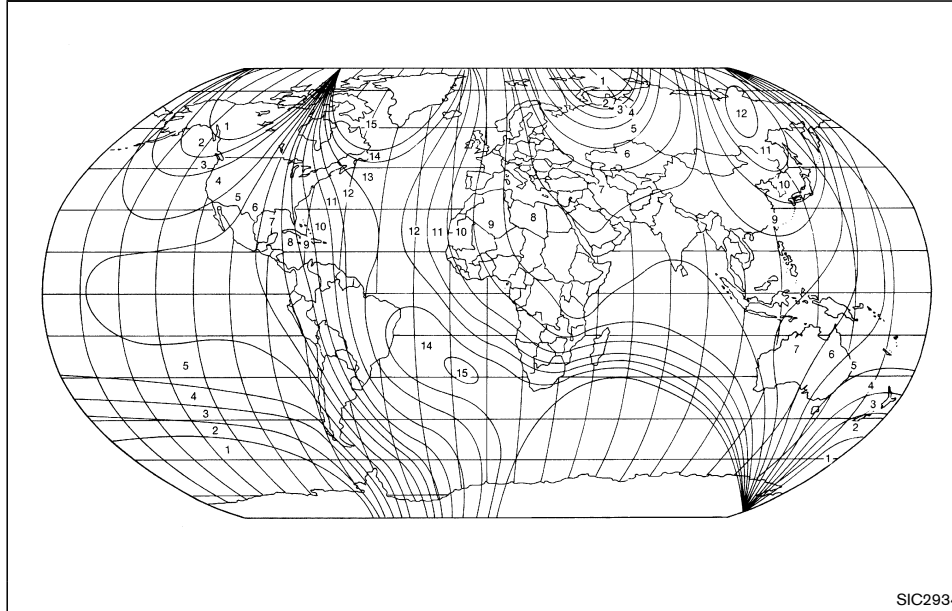

Zone map

The difference between magnetic north and geographical north is known as variance. In some areas, this difference can sometimes be great enough to cause false compass readings. Follow these instructions to set the variance for your particular location if this happens:

1. Push the  switch for more than 3 seconds. The current zone number will appear in the display.

2. Find your current location and variance one number on the zone map.
  3. Push the  switch repeatedly until the new zone number appears in the display. After you stop pushing the switch in, the display will show a compass direction within a few seconds.
- If the compass deviates from the correct indication soon after repeated adjustment, have the compass checked at a NISSAN dealer.



































- The compass may not indicate the correct compass point in tunnels or while driving up or down a steep hill. (The compass returns to the correct compass point when the vehicle moves to an area where the geomagnetism is stabilized.)



### CAUTION:

- Do not install a ski rack, antenna, etc. which are attached to the vehicle by means of a magnet. They affect the operation of the compass.
- When cleaning the mirror, use a paper towel or similar material dampened with glass cleaner. Do not spray glass cleaner directly on the mirror as it may cause the liquid cleaner to enter the mirror housing.



## WARNING/INDICATOR LIGHTS AND AUDIBLE REMINDERS











	Anti-lock Braking System (ABS) warning light		Supplemental Restraint System (SRS) air bag warning light		High beam indicator light
	Brake warning light (red)		Vehicle Dynamic Control (VDC) warning light (except for Europe)/Electronic Stability Program (ESP) warning light (for Europe)		Hill descent control system on indicator light (if equipped)
	Charge warning light		Water-in-fuel-filter warning light (diesel engine model)		Hill Start Assist system on indicator light (if equipped)
	Electric power steering warning light		Dipped beam indicator light (if equipped)		Malfunction Indicator Light (MIL)
	Electronic parking brake system warning light (yellow) (if equipped)		Door lock indicator light (if equipped)		Rear fog light indicator light (if equipped)
	Electronic parking brake warning light (if equipped)		ECO mode system indicator light (if equipped)		Security indicator light
	Forward emergency braking system warning light (if equipped)		Four-Wheel Drive (4WD) AUTO indicator light (4WD model)		Small light indicator light
	Low tire pressure warning light (if equipped)		Four-Wheel Drive (4WD) LOCK indicator light (4WD model)		SPORT mode indicator light (if equipped)
	Malfunction warning light (red) (diesel engine model)		Front fog lights indicator light (if equipped)		Trailer direction indicator light (if equipped)
	Master warning light		Front passenger air bag status light (if equipped)		Turn signals/hazard indicator lights
	Seat belt warning light		Glow plug indicator light (diesel engine model)		Vehicle Dynamic Control (VDC) off indicator light (except for Europe)/Electronic Stability Program (ESP) off indicator light (for Europe)
	Speed [120 km/h (75 MPH)] warning light (if equipped)		High beam assist indicator light (if equipped)		

## 2-12 Instruments and controls



## CHECKING BULBS

With all doors closed, apply the parking brake, fasten the seat belts and place the ignition switch in the "ON" position without starting the engine. If equipped, the following lights will illuminate: , , .

If equipped, the following lights will illuminate briefly and then turn off: , , , , , , , , , .

If any lights fail to illuminate, it may indicate a burned-out bulb or an open circuit in the electrical system. Have the system checked, and if necessary repaired, by a NISSAN dealer promptly.

Some indicators and warnings are also displayed on the vehicle information display between the speedometer and tachometer. (See "Vehicle information display" (P.2-20).)

## WARNING LIGHTS

### Anti-lock Braking System (ABS) warning light

When the ignition switch is in the "ON" position, the Anti-lock Braking System (ABS) warning light illuminates and then turns off. This indicates the ABS is operational.

If the ABS warning light illuminates while the engine is running, or while driving, it may indicate the ABS is not functioning properly. Have the system checked by a NISSAN dealer promptly.

If an ABS malfunction occurs, the anti-lock function is turned off. The brake system then operates normally, but without anti-lock assistance. (See "Brake system" (P.5-57).)

### Brake warning light (red)

#### **WARNING:**

- **If the brake fluid level is below the minimum mark on the brake fluid reservoir, do not drive the vehicle until the brake system has been checked by a NISSAN dealer.**
- **Even if you judge it to be safe, have your vehicle towed because driving it could be dangerous.**
- **Depressing the brake pedal without the engine running and/or with a low brake fluid level could increase the stopping distance and require greater pedal travel distance and effort.**

The brake warning light indicates the parking brake system operation (models not equipped with electronic parking brake system), a low brake fluid level of the brake system and an Anti-lock Braking System (ABS) malfunction.

#### **Parking brake warning indicator (models not equipped with electronic parking brake system):**

When the ignition switch is placed in the "ON" position, the brake warning light illuminates. When the engine is started and the parking brake is released, the brake warning light turns off.

If the parking brake is not fully released, the brake warning light remains on. Be sure that the brake warning light has turned off before driving. (See "Parking brake" (P.3-30).)

#### **Low brake fluid warning indicator:**

If the brake warning light illuminates while the engine is running, or while driving, and the parking brake is released, it may indicate the brake fluid level is low.

When the brake warning light illuminates while driving, stop the vehicle safely as soon as possible. Stop the engine and check the brake fluid level. If the brake fluid level is at the minimum mark, add brake fluid as necessary. (See "Brake fluid" (P.8-16).)

If the brake fluid level is sufficient, have the brake system checked by a NISSAN dealer promptly.

#### **Anti-lock Braking System (ABS) warning indicator:**

When the parking brake is released and the brake fluid level is sufficient, if both the brake warning light and the Anti-lock Braking System (ABS) warning light illuminate, it may indicate the ABS is not functioning properly. Have the brake system checked, and if necessary repaired, by a NISSAN dealer promptly. (See "Anti-lock Braking System (ABS) warning light" (P.2-13).)

### Charge warning light

When the ignition switch is in the "ON" position, the charge warning light illuminates, and then turns off. This indicates the charging system is operational.

If the charge warning light illuminates while the engine is running, or while driving, it may indicate the charging system is not functioning properly and may need servicing.

When the charge warning light illuminates while driving, stop the vehicle safely as soon as possible. Stop the engine and check the alternator belt. If the alternator belt is loose, broken or missing, the charging system needs repair. (See "Drive belt" (P.8-14).)

## Instruments and controls 2-13

If the alternator belt appears to be functioning correctly but the charge warning light remains illuminated, have the charging system checked by a NISSAN dealer promptly.



**CAUTION:**

**Do not continue driving if the alternator belt is loose, broken or missing.**



**Electric power steering warning light**

When the ignition switch is in the "ON" position, the electric power steering warning light illuminates. After starting the engine, the electric power steering warning light turns off. This indicates the electric power steering system is operational.

If the electric power steering warning light illuminates while the engine is running, it may indicate the electric power steering system is not functioning properly and may need servicing. Have the electric power steering system checked by a NISSAN dealer.

When the electric power steering warning light illuminates with the engine running, the power assist to the steering will cease operation but you will still have control of the vehicle. At this time, greater steering efforts are required to operate the steering wheel, especially in sharp turns and at low speeds.

(See "Electric power steering system" (P.5-56).)



**Electronic parking brake system warning light (yellow) (if equipped)**

The electronic parking brake system warning light functions for the electronic parking brake system. When the ignition switch is placed in the "ON" position, the light illuminates for a few seconds. If the warning light illuminates at any other time, it may indicate that the electronic parking brake system is not functioning properly. Have the brake system checked, and if necessary repaired, by a NISSAN dealer promptly.



**Electronic parking brake warning light (if equipped)**

The electronic parking brake warning light indicates that the electronic parking brake system is operating.

When the ignition switch is placed in the "ON" position, the electronic parking brake warning light illuminates. When the engine is started and the parking brake is released, the warning light turns off.

If the parking brake is not fully released, the electronic parking brake warning light remains on. Be sure that the electronic parking brake warning light has turned off before driving. (See "Parking brake" (P.3-30).)

If the electronic parking brake warning light illuminates or flashes while the electronic parking brake system warning light  (yellow) illuminates, it may indicate that the electronic parking brake system is not functioning properly. Have the brake system checked, and if necessary repaired, by a NISSAN dealer promptly.



**Forward emergency braking system warning light (if equipped)**

When the ignition switch is in the "ON" position, the forward emergency braking system warning light illuminates and then turns off.

This light illuminates when the forward emergency braking system is set to OFF on the vehicle information display.

If the light illuminates when the forward emergency braking system is ON, it may indicate that the system is unavailable. See "Forward emergency braking system" (P.5-45) for more details.



**Low tire pressure warning light (if equipped)**

When the ignition switch is in the "ON" position, the low tire pressure warning light illuminates and then turns off. This indicates that the low tire pressure warning system is operational.

This light illuminates if there is low tire pressure or a tire pressure warning system malfunction.

The Tire Pressure Monitoring System (TPMS) monitors the tire pressure of all tires except the spare.

**Low tire pressure warning:**

If the vehicle is being driven with low tire pressure, the low tire pressure warning light will illuminate.

When the low tire pressure warning light illuminates, you should stop and adjust the tire pressure to the recommended COLD tire pressure shown on the tire placard. Use a tire pressure gauge to check the tire pressure. The low tire pressure warning light may not automatically turn off when the tire pressure is adjusted. After the tire is inflated to the recommended

**2-14 Instruments and controls**

pressure, reset the tire pressures registered in your vehicle and then drive the vehicle at speeds above 25 km/h (16 MPH). These operations are required to activate the TPMS and turn off the low tire pressure warning light.

Depending on a change in the outside temperature, the low tire pressure warning light may illuminate even if the tire pressure has been adjusted properly. Adjust the tire pressure to the recommended COLD tire pressure again when the tires are cold, and reset the TPMS.

If the low tire pressure warning light still continues to illuminate after the resetting operation, it may indicate that the TPMS is not functioning properly. Have the system checked by a NISSAN dealer.

For additional information, see "Tire Pressure Monitoring System (TPMS)" (P.5-4).

#### TPMS malfunction:

If the TPMS is not functioning properly, the low tire pressure warning light will flash for approximately 1 minute when the ignition switch is placed in the "ON" position. The light will remain on after the 1 minute. Have the system checked by a NISSAN dealer.

For additional information, see "Tire Pressure Monitoring System (TPMS)" (P.5-4).



#### WARNING:

- If the light does not illuminate with the ignition switch placed in the "ON" position, have the vehicle checked by a NISSAN dealer as soon as possible.
- If the light illuminates while driving, avoid sudden steering maneuvers or abrupt braking, reduce vehicle speed, pull off the road to a safe location and stop the vehicle as soon

as possible. Driving with under-inflated tires may permanently damage the tires and increase the likelihood of tire failure. Serious vehicle damage could occur and may lead to an accident and could result in serious personal injury. Check the tire pressure for all four tires. Adjust the tire pressure to the recommended COLD tire pressure shown on the tire placard to turn the low tire pressure warning light off. If you have a flat tire, replace it with a spare tire as soon as possible.

- After adjusting the tire pressure, be sure to reset the TPMS. Otherwise, the TPMS will not warn of low tire pressure.
- When a spare tire is mounted or a wheel is replaced, the TPMS will not function and the low tire pressure warning light will flash for approximately 1 minute. The light will remain on after the 1 minute. Contact your NISSAN dealer as soon as possible for tire replacement and/or system resetting.
- Replacing tires with those not originally specified by NISSAN could affect the proper operation of the TPMS.



#### CAUTION:

- The TPMS is not a substitute for the regular tire pressure check. Be sure to check the tire pressure regularly.
- If the vehicle is being driven at speeds of less than 25 km/h (16 MPH), the TPMS may not operate correctly.
- Be sure to install the specified size of tires to all four wheels correctly.



Malfunction warning light (red) (diesel engine model)

When the ignition switch is placed in the "ON" position, the malfunction warning light illuminates in red. This means that the system is operational. After starting the engine, the warning light turns off.

For the orange Malfunction Indicator Light (MIL), see "Malfunction Indicator Light (MIL)" (P.2-18) for details.

If the malfunction warning light (red) illuminates continuously while the engine is running, it may indicate an engine control system malfunction. Have your vehicle inspected by a NISSAN dealer. You do not need to have your vehicle towed to the dealer.



#### CAUTION:

Continuing vehicle operation without proper servicing of the engine control system could lead to poor driveability, reduced fuel economy, and damage to the engine control system, which may affect the vehicle's warranty coverage.



Master warning light

When the ignition switch is in the "ON" position, the master warning light illuminates if any of the following are displayed on the vehicle information display.

- Steering lock release malfunction indicator (if equipped)
- No Key detected warning (if equipped)
- Key ID incorrect warning (if equipped)
- Shift to Park warning (Continuously Variable Transmission (CVT) models)

Instruments and controls 2-15

- Door/back door open warning
  - Low fuel warning
  - Release parking brake warning
  - Engine start operation indicator (for Continuously Variable Transmission (CVT) models)
  - Key System Fault warning (if equipped)
  - Low Tyre Pressure warning (if equipped)
  - Tyre pressure system fault (if equipped)
  - CVT System Fault warning (for Continuously Variable Transmission (CVT) models)
  - Low oil pressure Stop vehicle warning (if equipped)
  - 4WD system fault warning (if equipped)
  - 4WD High Temp. Stop vehicle warning (if equipped)
  - Tyre size incorrect warning (if equipped)
  - Key battery low warning (if equipped)
  - Battery Voltage Low Charge Battery warning
  - Headlight system fault warning (if equipped)
  - Chassis control system fault warning (if equipped)
  - Second row seat belt warning (if equipped)
  - Other warning
- See "Vehicle information display" (P.2-20).

### Seat belt warning light

#### **Type A:**

The light illuminates whenever the ignition switch is placed in the "ON" or "START" position, and will remain illuminated until the driver's seat belt is fastened. At the same time, the chime will sound for about 6 seconds unless the driver's seat belt is securely fastened.

#### **Type B:**

When the ignition switch is in the "ON" position, the front seat belt warning light on the meter illuminates. The light will continue to illuminate until the driver's and/or passenger's seat belt are fastened. (See "Seat belts" (P.1-9).)

When the vehicle speed exceeds 15 km/h (10 MPH), the light will blink and the chime will sound unless the front seat belt is securely fastened. The chime will continue to sound for about 95 seconds until the seat belt is fastened. (See "Seat belts" (P.1-9).)

For second row seats, see "Vehicle information display warnings and indicators" (P.2-28).

### Speed [120 km/h (75 MPH)] warning light (if equipped)

This light blinks when the vehicle speed goes over approximately 120 km/h (75 MPH). Be sure to observe the speed limit in the area where you are driving.

### Supplemental Restraint System (SRS) air bag warning light

When the ignition switch is in the "ON" position, the Supplemental Restraint System (SRS) air bag warning light illuminates for about 7 seconds and then turns off. This indicates the SRS air bag system is operational.

If any of the following conditions occur, the SRS air bag system and/or pre-tensioner seat belt need servicing. Have the system checked, and if necessary repaired, by a NISSAN dealer promptly.

- The SRS air bag warning light remains illuminated after about 7 seconds.
- The SRS air bag warning light flashes intermittently.

- The SRS air bag warning light does not come on at all.

Unless checked and repaired, the SRS air bag system and/or pre-tensioner seat belt may not function properly. (See "Supplemental Restraint System (SRS)" (P.1-27).)

### Vehicle Dynamic Control (VDC) warning light (except for Europe)/Electronic Stability Program (ESP) warning light (for Europe)

When the ignition switch is in the "ON" position, the Vehicle Dynamic Control (VDC)/Electronic Stability Program (ESP) warning light illuminates and then turns off.

The warning light blinks when the VDC/ESP system is operating.

When the warning light blinks while driving, the driving condition is slippery and the vehicle's traction limit is about to be exceeded.

If the VDC/ESP warning light illuminates while the engine is running or while driving, it may indicate that the VDC/ESP system is not functioning properly and may need servicing. Have the system checked, and if necessary repaired, by a NISSAN dealer promptly. If a malfunction occurs, the VDC/ESP function is turned off, but the vehicle is still drivable. (See "Vehicle Dynamic Control (VDC)/Electronic Stability Program (ESP) system" (P.5-26).)

## 2-16 Instruments and controls



Water-in-fuel-filter warning light (diesel engine model)

If the water-in-fuel-filter warning light illuminates while the engine is running, contact a NISSAN dealer as soon as possible.



### CAUTION:

**Continuing vehicle operation without properly draining could cause serious damage to the engine.**

## INDICATOR LIGHTS



Dipped beam indicator light (if equipped)

The dipped beam indicator light illuminates when the headlight low beam is on. (See "Headlight and turn signal switch" (P.2-39).)



Door lock indicator light (if equipped)

The door lock indicator light, located on the instrument panel, illuminates when all the doors are locked.

- With the ignition switch in the "ON" position, the door lock indicator light will illuminate and stay on when the doors are locked using the power door lock switch.
- With the ignition switch in the "OFF" or "LOCK" position, the door lock indicator light will operate as follows:
  - When the doors are locked with the power door lock switch, the door lock indicator light will illuminate for 30 minutes.

- When the doors are locked by pushing the "LOCK" button (on the remote controller or Intelligent Key) or the request switch (Intelligent Key system equipped models), the door lock indicator light will illuminate for 1 minute.

The door lock indicator light turns off when any door is unlocked.

For locking or unlocking doors, see "Door locks" (P.3-4).



ECO mode system indicator light (if equipped)

The ECO mode indicator light illuminates when the ECO mode system is turned on.

(See "ECO mode system" (P.5-47).)



Four-Wheel Drive (4WD) AUTO indicator light (4WD model)

When the ignition switch is in the "ON" position, the Four-Wheel Drive (4WD) AUTO indicator light illuminates and then turns off.

When selecting 4WD AUTO mode while the engine is running, the 4WD AUTO indicator light illuminates. (See "Four-Wheel Drive (4WD)" (P.5-22).)



Four-Wheel Drive (4WD) LOCK indicator light (4WD model)

When the ignition switch is in the "ON" position, the Four-Wheel Drive (4WD) LOCK indicator light illuminates and then turns off.

When selecting 4WD LOCK mode while the engine is running, the 4WD LOCK indicator light illuminates simultaneously with the 4WD AUTO indicator light illuminating. (See "Four-Wheel Drive (4WD)" (P.5-

22).)



### CAUTION:

**Do not drive on dry hard surface roads in the LOCK mode.**



Front fog lights indicator light (if equipped)

The front fog lights indicator light illuminates when the front fog lights are on. (See "Fog light switch" (P.2-45).)



Front passenger air bag status light (if equipped)

The front passenger air bag status light ( ) located on the instrument panel will illuminate when the front passenger air bag is turned off with the front passenger air bag switch. When the front passenger air bag is turned on, the front passenger air bag status light ( ) will illuminate.

For more details, see "Supplemental front-impact air bag system" (P.1-33).



Glow plug indicator light (diesel engine model)

When the ignition switch is in the "ON" position, the glow plug indicator light illuminates and turns off after the glow plugs have warmed up.

If the glow plugs have already warmed up, the glow plug indicator flashes briefly and then turns off.

 High beam assist indicator light (if equipped)

The indicator light illuminates when the headlights come on while the headlight switch is in the "AUTO" position with the high beam selected. This indicates that the high beam assist system is operational. (See "Headlight and turn signal switch" (P.2-39).)

 High beam indicator light

The high beam indicator light illuminates when the headlight high beam is on. The indicator turns off when the low beam is selected. (See "Headlight and turn signal switch" (P.2-39).)

 Hill descent control system on indicator light (if equipped)

When the ignition switch is placed in the "ON" position the hill descent control system on indicator light illuminates briefly and then turns off. This indicates that the hill descent control system is operational.

The light illuminates when the hill descent control system is activated.

If the hill descent control switch is on and the indicator light blinks, the system is not engaged.

If the indicator light does not illuminate or blink when the hill descent control switch is on, the system may not be functioning properly. Have the system checked by a NISSAN dealer.

For additional information, see "Hill descent control system" (P.5-30).

 Hill Start Assist system on indicator light (if equipped)

The light illuminates when the conditions of the hill start assist system are satisfied when the vehicle is stopped on a hill.

Then, the light blinks when the brake pedal is released, which indicates that the hill start assist system is activated.

For additional information, see "Hill Start Assist system" (P.5-30).

 Malfunction Indicator Light (MIL)



**CAUTION:**

- **Continuing vehicle operation without proper servicing of the engine control system and/or Continuously Variable Transmission (CVT) could lead to poor driveability, reduced fuel economy, and damage to the engine control system and/or CVT system, which may affect the vehicle's warranty coverage.**
- **Incorrect setting of the engine control system may lead to non-compliance of local and national emission laws and regulations.**

When the ignition switch is in the "ON" position, the Malfunction Indicator Light (MIL) illuminates. After starting the engine, the MIL turns off. This indicates that the engine control system and/or CVT system is operational.

If the MIL illuminates while the engine is running, it may indicate that the engine control system is not functioning properly and may need servicing. Have the vehicle checked, and if necessary repaired, by a NISSAN dealer promptly.

If the MIL blinks (if equipped) while the engine is running, it may indicate a potential malfunction in the emission control system. In this case, the emission control system may not function properly and may need servicing. Have the system checked, and if necessary repaired, by a NISSAN dealer promptly.

**Precautions:**

To reduce or avoid possible damage to the engine control system when the MIL blinks:

- Avoid driving at speeds above 70 km/h (43 MPH).
- Avoid sudden acceleration or deceleration.
- Avoid going up steep uphill grades.
- Avoid carrying or towing unnecessary loads.

 Rear fog light indicator light (if equipped)

The rear fog light indicator light illuminates when the rear fog light is on. (See "Fog light switch" (P.2-45).)

 Security indicator light

The security indicator light blinks when the ignition switch is in the "LOCK", "OFF" position. This function indicates the security system\* equipped on the vehicle is operational. (\* immobilizer)

If security system is malfunctioning, this light will remain on while the ignition switch is in the "ON" position. (See "Security system" (P.3-20) for additional information.)

## 2-18 Instruments and controls

 Small light indicator light

The light illuminates when the headlight switch is turned to the  position.

 SPORT mode indicator light (if equipped)

The SPORT mode indicator light illuminates when the SPORT mode is turned "ON". (See "Driving with Continuously Variable Transmission (CVT)" (P.5-13) for the use of the SPORT mode switch.)

 Trailer direction indicator light (if equipped)

The light will illuminate whenever an additional electrical load is detected by the direction indicator system.

For additional information, see "Trailer towing (for Australia, New Zealand, South Africa and Europe)" (P.5-52).

 Turn signals/hazard indicator lights

The turn signals/hazard indicator lights blink when the turn signal switch or hazard indicator flasher switch is turned on. (See "Headlight and turn signal switch" (P.2-39) or "Hazard indicator flasher switch" (P.6-2).)

 Vehicle Dynamic Control (VDC) off indicator light (except for Europe)/Electronic Stability Program (ESP) off indicator light (for Europe)

When the ignition switch is in the "ON" position, the Vehicle Dynamic Control (VDC)/Electronic Stability Program (ESP) off indicator light illuminates and then turns off.

The VDC/ESP off indicator light illuminates when the VDC/ESP off switch is pushed to the "OFF" position. When the VDC/ESP off switch is pushed to the "OFF" position, the VDC/ESP system is turned off.

For details, see "Vehicle Dynamic Control (VDC)/Electronic Stability Program (ESP) system" (P.5-26).

## AUDIBLE REMINDERS

### Brake pad wear warning

The disc brake pads have audible wear warnings. When a brake pad requires replacement, it will make a high pitched scraping sound when the vehicle is in motion. This scraping sound will first occur only when the brake pedal is depressed. After more wear of the brake pad, the sound will always be heard even if the brake pedal is not depressed. Have the brakes checked as soon as possible if the wear warning sound is heard.

Have the system checked, and if necessary repaired, by a NISSAN dealer promptly. (See "Brakes" (P.8-15).)



### Intelligent Key buzzer (if equipped)

The Intelligent Key buzzer sounds if any one of the following improper operations is found.

- The ignition switch is not returned to the "LOCK" position when locking the doors.
- The Intelligent Key is left inside the vehicle when locking the doors.
- Any doors are not closed securely when locking the doors.

When the buzzer sounds, be sure to check both the vehicle and the Intelligent Key. (See "Intelligent Key system" (P.3-10).)

### Light reminder chime

The chime will sound if the driver's side door is opened while the headlight switch is in either the  or  position and the ignition switch is in the "OFF" or "LOCK" position.

Be sure to turn the light switch to the "OFF" or "AUTO" (if equipped) position when you leave the vehicle.

### Parking brake reminder chime

The chime will sound if the vehicle is driven at more than 7 km/h (4 MPH) (models not equipped with electronic parking brake) or 4 km/h (2 MPH) (models equipped with electronic parking brake) with the parking brake applied. Stop the vehicle and release the parking brake.

## VEHICLE INFORMATION DISPLAY

### Stop/Start System or Idling Stop System reminder buzzer (if equipped)

The engine will shift to the normal stopped state if any of the following operations is made during Stop/Start System or Idling Stop System activation, and the Stop/Start System or Idling Stop System buzzer will sound if:

- The driver's seat belt is unfastened and the driver's door is open (MT models).
- The vehicle engine hood is open.

Close the hood or the driver's door, or fasten the seat belt then restart the engine using the ignition switch.

For more information, see "Stop/Start System or Idling Stop System" (P.5-18).

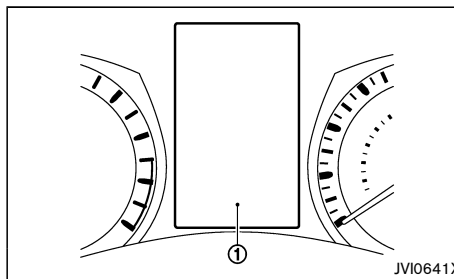

The vehicle information display ① is located between the tachometer and the speedometer. It displays such items as:

- Vehicle settings
- Trip computer information
- Driver Assistance (if equipped)
- Speed limiter information (if equipped)
- Cruise control system information (if equipped)
- Intelligent Key operation information (if equipped)
- Audio information (if equipped)
- Navigation - turn by turn (if equipped)
- Indicators and warnings
- Tyre pressure information (if equipped)
- Chassis Control
- Other information

Please note that the information used in this manual is written in UK English. There are a few differences in the information for the UK and U.S. English versions of the system.



For language settings, see "Language" (P.2-26).

### HOW TO USE THE VEHICLE INFORMATION DISPLAY

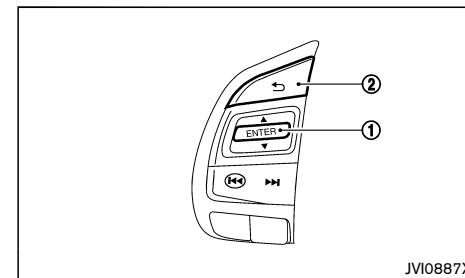
#### Type A:





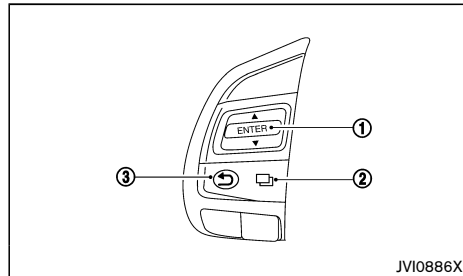

The vehicle information display can be changed using the switches  and ENTER ① located on the steering wheel.

- ①  - navigate through the items in vehicle information display
- select/enter the Vehicle information menu items or to change from one display screen to the next (i.e. trip, Fuel economy)
- ENTER - change or select an item in the vehicle information display
- ②  - go back to the previous menu



**Type B:**

The vehicle information display can be changed using the switches  (2) and ENTER (1) located on the steering wheel.

- ①  - navigate through the items in vehicle information display  
ENTER - change or select an item in the vehicle information display
- ②  - select/enter the Vehicle information menu items or to change from one display screen to the next (i.e. trip, Fuel economy)
- ③  - go back to the previous menu

The  switch (1) also controls audio and control panel functions. For additional information, see "Steering wheel mounted controls for audio (Type B)" (P.4-76).

**STARTUP DISPLAY**

When the ignition switch is placed in the "ON" position, the screens that display in the vehicle information display include:

- Trip computer
- Fuel economy
- Warnings

Warnings will only display if there are any present, for more information on warnings and indicators, see "Vehicle information display warnings and indicators" (P.2-28).

To control what items display in the vehicle information display, see "Settings" (P.2-21).

**SETTINGS**

The setting mode allows you to change the information displayed in the vehicle information display:

- Driver Assistance (if equipped)
- Clock
- Display Settings
- Vehicle Settings
- Maintenance
- Alert
- Tyre Pressures (if equipped)
- Units
- Language (if equipped)
- Factory Reset

**Driver Assistance (if equipped)**

To change the status, warnings or turn on or off any of the systems/warnings displayed in the "Driver Assistance" menu, use the  switch (1) to select and the ENTER (1) to change a menu item:

- Driving Aids
- Driver Attention
- Traffic Sign
- Parking Aids
- Chassis Control

**Driving Aids:**

To change the status, warnings or turn on or off any of the systems/warnings displayed in the "Driving Aids" menu, use the  switch (1) to select and the ENTER (1) to change a menu item:

- Lane
  - Lane Departure Warning (LDW) ON/OFF
- Blind Spot
  - Blind Spot Warning (BSW) ON/OFF
- Emergency Brake
  - Emergency Brake ON/OFF

**Driver Attention:**

Driver Attention ON/OFF

**Traffic Sign:**

Traffic Sign ON/OFF



**Parking Aids:**

To change the status or turn on or off any of the systems displayed in the "Parking Aids" menu, use the  switch (1) to select and the ENTER (1) to change a menu item:

- Moving Object
  - Moving Object Detection (MOD) ON/OFF
- Front Sensor
  - Front parking sensor ON/OFF
- Rear Sensor
  - Rear parking sensor ON/OFF
- Display
  - Parking sensor display ON/OFF
- Volume
  - Parking sensor buzzer volume Low/Med./High
- Range
  - Parking sensor detection range Far/Mid./Near

For additional information, see “Around view monitor” (P.4-10).

#### Chassis Control:

To change the status, warnings or turn on or off any of the systems/warnings displayed in the “Chassis Control” menu, use the  switch  to select and the ENTER  to change a menu item:



- Trace Control
  - See “Active Trace Control” (P.5-28) for more information.
- Engine Brake (if equipped)
  - See “Active Engine Brake (Continuously Variable Transmission (CVT) models)” (P.5-28) for more information.

#### Clock



To set the clock, see “Clock” (P.4-6) or “Audio settings” (P.4-58) in this manual or the separate Navigation Owner’s Manual.

#### Display Settings

The meter settings allows the customer to choose from the various meter selections.







The meter settings can be changed using the   and the ENTER  buttons.

#### Contents Selection:

The items that display when the ignition switch is placed in the “ON” position can be enabled/disabled. To change the items that are displayed, use the   to scroll and the ENTER  to select a menu item.



#### Body Colour:

The color of the vehicle that displays in the vehicle information display when the ignition switch is placed in the “ON” position can be changed.

1. Use the  switch  until “Body Colour” is selected, and press ENTER .
2. Select the body color using the  switch  and press ENTER .



#### ECO Mode Settings (if equipped):

This setting allows the customer to change the ECO mode system settings.

Use the  switch  until “ECO Mode Settings” is selected, and press ENTER .

#### ECO Glow:



This setting allows the customer to enable/disable the ambient ECO indicator in the vehicle information display.

1. Use the  switch  to select “ECO Glow”.
2. Press the ENTER  to turn ON/OFF the ambient ECO in the vehicle information display.

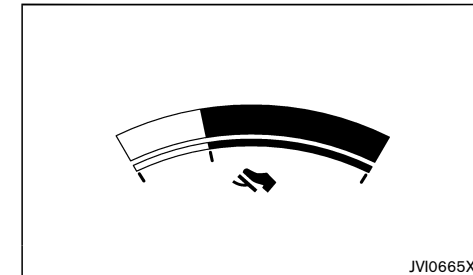
#### Display:





This setting allows the customer to enable/disable the ECO pedal guide function.

1. Use the  switch  to select “Display”.
2. Press the ENTER  to select “Pedal Guide” or “Fuel econ.”.



For detailed information, see “ECO mode system” (P.5-47).

## 2-22 Instruments and controls

**Stop/Start (if equipped):**

To change the status, warnings or turn on or off any of the systems/warnings displayed in the “Stop/Start” menu, use the  switch  to select and the ENTER  to change a menu item:

- Display
  - Stop/Start display ON/OFF
- Trip CO2 saving
 

The “Trip CO2 saving” and engine stop time mode shows the CO2 saving and engine stop time since the last reset. The CO2 saving and engine stop time can be reset by pushing the ENTER  (Type A) or   (Type B).
- Total CO2 saving
 

The “Total CO2 saving” and engine stop time mode shows:



  - The estimated CO2 exhaust emissions prevented.
  - The engine stop time that the engine has been stopped by the “Stop/Start or Idling Stop” System.

**NOTE:**

**The “Total CO2 saving” and engine stop time values cannot be reset and show accumulated “Stop/Start or Idling Stop” System information since the vehicle was built.**

**ECO Drive Report (if equipped):****Display:**

This setting allows the customer to enable/disable the ECO Drive Report in the vehicle information display.

1. Use the  switch  to select “ECO Drive Report”.

2. Press the ENTER  to turn ON/OFF the ECO management display in the vehicle information display.







**View History:**

This setting allows the customer to reset the past history of the fuel economy and the best fuel economy.

**Welcome Effect:**

You can choose whether or not to display the welcome screen when the ignition switch is placed in the “ACC” or “ON” position. You can also choose the following items to define how the welcome screen looks:



- Dial and Pointer
- Display Effect

Select “Welcome Effects” using the  switch  and press the ENTER  to select this menu. Use the  switch  to navigate between the menu options and press the ENTER  to turn each function ON/OFF.

**Vehicle Settings**

The vehicle settings allows the customer to change settings for the following settings.

- Lighting
- Turn Indicator
- Unlocking
- Wipers

The vehicle settings can be changed using the  , and the ENTER  switches.

**Lighting:**

The “Lighting” menu has the following options:



- Welcome Light
 

The welcome lighting can be set to be ON or OFF. From the “Lighting” menu, select “Welcome Light”. Use the ENTER  to turn this feature

ON or OFF.

- Int. Lamp Timer
 

The internal light timer can be set to be ON or OFF. From the “Lighting” menu, select “Int. Lamp Timer”. Use the ENTER  to turn this feature ON or OFF.
- Auto Lights
 

The sensitivity of the automatic lighting can be adjusted. From the “Lighting” menu, select “Auto Lights”. Use the  switch  and the ENTER  to select the required sensitivity. The following options are available:

  - On Earliest
  - On Earlier
  - Standard
  - On Later
- Headlight Off delay (if equipped)
 

The duration of the automatic headlights can be changed from 0 to 180 seconds. From the “Lighting” menu, select “Headlight Off delay”. Use the ENTER  to change the duration.

**Turn Indicator:**

The “3 Flash On” overtaking feature can be set to be ON or OFF. From the “Turn Indicator” menu, select “3 Flash On”. Use the ENTER  to turn this feature ON or OFF.

**Unlocking:**

There are the following options in the “Unlocking” menu:

- I-Key Door Lock
 

When this item is turned on, the request switch on the door is activated. From the “Unlocking” menu, select “I-Key Door Lock”. Use the ENTER button to activate or deactivate this function.

- Selective Unlock

When this item is turned on, and the door handle request switch on the driver's or front passenger's side door is pushed, only the corresponding door is unlocked. All the doors can be unlocked if the door handle request switch is pushed again within 1 minute. When this item is turned off, all the doors will be unlocked when the door handle request switch is pushed once. From the "Unlocking" menu, select "Selective Unlock". Use the ENTER button to activate or deactivate this function.

- Answer Bk. Horn (if equipped)

When the answer back horn is on the horn will chirp and the hazard indicators will flash once when locking the vehicle with the Intelligent Key or remote keyless entry function.

### Wipers:

- Speed Dependent (if equipped)

The "Speed Dependent" feature can be activated or deactivated. From the "Wipers" menu, select "Speed Dependent". Use the ENTER  to turn this feature ON or OFF.

- Rain Sensor (if equipped)

The "Rain sensor" feature can be activated or deactivated. From the "Wipers" menu, select "Rain Sensor". Use the ENTER  to turn this feature ON or OFF.

- Reverse Link

The "Reverse Link" wiper feature can be set to be ON or OFF. From the "Wipers" menu, select "Reverse Link". Use the ENTER  to turn this feature ON or OFF.

- Drip Wipe

The "Drip Wipe" feature can be set to be ON or OFF. From the "Wipers" menu, select "Drip Wipe".

## 2-24 Instruments and controls

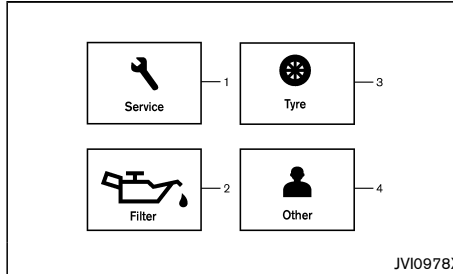

Use the ENTER  to turn this feature ON or OFF.

### Maintenance



1. Service
2. Filter (if equipped)
3. Tyre
4. Other

The maintenance mode allows you to set alerts for the reminding of maintenance intervals. To change an item:

Select "Maintenance" using the  switch  and press ENTER .

#### Service:

This indicator appears when the customer set distance comes for changing the engine oil and filter. You can set or reset the distance for checking or replacing these items. For scheduled maintenance items and intervals, see a separate maintenance booklet.

#### Filter (if equipped):

This indicator appears when the customer set distance comes for changing the oil filter. You can set or reset the distance for checking or replacing these items. For scheduled maintenance items and intervals, see a separate maintenance booklet.

#### Tyre:

This indicator appears when the customer set distance comes for replacing tires. You can set or reset the distance for replacing tires.



#### WARNING:



**The tire replacement indicator is not a substitute for regular tire checks, including tire pressure checks. See "Changing tires and wheels" (P.8-37). Many factors including tire inflation, alignment, driving habits and road conditions affect tire wear and when tires should be replaced. Setting the tire replacement indicator for a certain driving distance does not mean your tires will last that long. Use the tire replacement indicator as a guide only and always perform regular tire checks. Failure to perform regular tire checks, including tire pressure checks could result in tire failure. Serious vehicle damage could occur and may lead to a collision, which could result in serious personal injury or death.**

#### Other:

This indicator appears when the customer set distance comes for checking or replacing maintenance items other than the engine oil, oil filter and tires. Other maintenance items can include such things as air filter or tire rotation. You can set or reset the distance for checking or replacing the items.



**Alert**

This setting allows the customer to set alarms.

Select "Alert" using the  switch  and press ENTER .







**Outside Temp. (if equipped):**

This setting allows the customer to enable/disable the alert for outside temperature in the vehicle information display.

1. Use the  switch  to select "Outside Temp."
2. Press the ENTER  to turn ON/OFF the alert.



**Timer:**

This setting allows the customer to set an alert to notify the driver that the set time has been reached.

1. Use the  switch  to select "Timer".
2. Press the ENTER .
3. To change the timer amount, use the  switch  and the ENTER  to save the selected time amount.



**Navigation (if equipped):**

This setting allows the customer to enable/disable the alert for navigation in the vehicle information display.

1. Use the  switch  to select "Navigation".
2. Press the ENTER  to turn ON/OFF the alert.



**Phone (if equipped):**

This setting allows the customer to enable/disable the alert for navigation in the vehicle information display.

1. Use the  switch  to select "Phone".
2. Press the ENTER  to turn ON/OFF the alert.

**Mail (if equipped):**

This setting allows the customer to enable/disable the alert for navigation in the vehicle information display.

1. Use the  switch  to select "Mail".
2. Press the ENTER  to turn ON/OFF the alert.



**Tyre pressures (if equipped)**

The settings in the "Tyre pressures" menu are all related to the Tyre pressure monitoring system TPMS (See "Tire Pressure Monitoring System (TPMS)" (P.6-2), "Tire Pressure Monitoring System (TPMS)" (P.5-4) and "Tire Pressure Monitoring System (TPMS)" (P.8-36)).

- Target Front
- Target Rear
- Tyre Pressure Unit
- Calibrate



**Target Front:**

The "Target Front" tyre pressure is the pressure specified for the front tyres on the tyre placard (See , "Tire Pressure Monitoring System (TPMS)" (P.5-4) and "Tire placard" (P.9-9)).

Use the   and the ENTER  buttons to select and change the value for the "Target Front/Target front" tyre pressure.

**Target Rear:**



The "Target Rear" tyre pressure is the pressure specified for the rear tyres on the tyre placard (see , "Tire Pressure Monitoring System (TPMS)" (P.5-4) and "Tire placard" (P.9-9)).

Use the   and the ENTER  buttons to select and change the value for the "Target Rear" tyre pressure.

**Tyre Pressure Unit:**

The unit for tyre pressure that displays in the vehicle information display can be changed to:

- kPa
- psi
- bar
- Kg/cm<sup>2</sup>

Use the   and the ENTER  buttons to select and change the unit.

If necessary, refer to the following table to convert between units.



kPa	200	210	220	230	240	250	260	270	280	290	300	310	320	330	340
psi	29	30	32	33	35	36	38	39	41	42	44	45	46	48	49
bar	2.0	2.1	2.2	2.3	2.4	2.5	2.6	2.7	2.8	2.9	3.0	3.1	3.2	3.3	3.4
kgf/cm <sup>2</sup>	2.0	2.1	2.2	2.3	2.4	2.5	2.6	2.7	2.8	2.9	3.0	3.1	3.2	3.3	3.4

JV10938X

**Calibrate:**

The tyre pressure is affected by the temperature of the tyre; the tyre temperature increases when the car is driven. To be able to accurately monitor the tyre air leakage and to prevent false TPMS warnings due to changes in temperature, the TPMS system uses temperature sensors in the tyres to perform temperature compensation calculations.



On rare occasions it may be necessary to recalibrate the TPMS system reference temperature. This operation should only be performed when the actual tyre pressure has been adjusted, whilst the current ambient temperature is significantly different to the current calibration temperature. (See "Tire Pressure Monitoring System (TPMS)" (P.5-4).)

Use the  , and the ENTER  switches to start or cancel the calibration process. While the calibration process is active, the message: "Resetting tyre pressure system" will be displayed.

**Units (if equipped)**

The units that are shown in the vehicle information display can be changed:



- Distance/Fuel
- Temperature

Use the  , and the ENTER  switches to select and change the units of the vehicle information display.

**Distance/Fuel:**

The unit for the mileage that displays in the vehicle information display can be changed to:

- km, l/100km
- km, km/l
- miles, MPG (UK)
- miles, MPG (US)

Use the  , and the ENTER  switches to select and change the unit.

**Temperature:**

The temperature that displays in the vehicle information display can be changed from:

- °C (Celsius)

- °F (Fahrenheit)

Use the ENTER  to toggle choices.

**Language (if equipped)**

The language of the vehicle information display can be changed to:

**Type A:**



- English
- French
- German
- Italian
- Portuguese
- Dutch
- Spanish
- Turkish
- Russian

**Type B:**

- English
- French
- Spanish

**Type C:**





- English (U.S.)
- English (UK)

Use the  , and the ENTER  switches to select and change the language of the vehicle information display. The language of the center display/navigation can be changed independently of the vehicle information display. For models with navigation system, see "Vehicle information and settings (models with navigation system)" (P.4-5). For models without navigation system, see "Audio system" (P.4-35)

**2-26 Instruments and controls**

## Factory Reset

The settings in the vehicle information display can be reset back to the factory default. To reset the vehicle information display:

1. Select "Factory Reset" using the  switch  and press the ENTER .
2. Select "YES" to return all settings back to default by pressing the ENTER .

### VEHICLE INFORMATION DISPLAY WARNINGS AND INDICATORS

BRAKE	Low fuel level	4WD system fault	Time for a driver break?	Not available Clean Rear Camera	Not available High cabin temperature
CLUTCH	11	4WD High Temp. Stop vehicle	Low outside temperature	Not available Clean Rear Camera	Parking Sensor System Fault
3	12	Tyre size incorrect	Chassis control system fault	CVT System Fault	
No Key detected	Key System Fault	Battery Voltage Low Charge Battery	LIMIT ON	300 m	
Shift to Park	Low tyre pressure	Shipping Mode On Push Storage Fuse	CRUISE ON	Stop / Start AUTO ON	
Key battery low	Tyre pressure system fault	Headlight system fault	35	DAA System fault	
Key ID incorrect	Low oil pressure Stop vehicle	Power will turn off to save the battery	36	System fault	
Release parking brake	Engine Oil	Power turned off to save the battery	System fault	System fault	
	Oil Level Low	Turn off headlights	System fault	System Fault	
	Engine Oil Sensor Error Visit Dealer	Press brake pedal	System fault	Not available Front Radar Obstruction	
		Time for a driver break?	System fault		

JVI0987X

### 2-28 Instruments and controls



### 1. Engine start operation indicator (for Continuously Variable Transmission (CVT) models)

This indicator appears when the shift lever is in the "P" (Park) position.

This indicator means that the engine will start by pushing the ignition switch with the brake pedal depressed. You can start the engine directly in any position of the ignition switch.

### 2. Engine start operation indicator (for Manual Transmission (MT) models)

This indicator means that the engine will start by pushing the ignition switch with the clutch pedal depressed. You can start the engine directly in any position of the ignition switch.

You can also start the engine by pushing the ignition switch with the brake pedal depressed when the shift lever is in the "N" (Neutral) position.

### 3. Steering lock release malfunction indicator (if equipped)

This indicator appears when the steering lock cannot be released.

If this indicator appears, push or turn the ignition switch while lightly turning the steering wheel right and left.

See "Steering lock" (P.5-10).

### 4. No Key detected warning (if equipped)

This warning appears when the door is closed with the Intelligent Key left outside the vehicle and the ignition switch in the "ON" position. Make sure that the Intelligent Key is inside the vehicle.

See "Intelligent Key system" (P.3-10) for more details.

### 5. Shift to Park warning (Continuously Variable Transmission (CVT) models)

This warning appears when the ignition switch is pushed to stop the engine with the shift lever in any position except the "P" (Park) position.

If this warning appears, move the shift lever to the "P" (Park) position or place the ignition switch in the "ON" position.

An inside warning chime will also sound. (See "Intelligent Key system" (P.3-10).)

### 6. Key battery low warning (if equipped)

This indicator appears when the Intelligent Key battery is running out of power.

If this indicator appears, replace the battery with a new one. See "Intelligent Key battery" (P.8-22).

### 7. Engine start operation for Intelligent Key system indicator (if equipped)

This indicator appears when the Intelligent Key battery is running out of power and when the Intelligent Key system and vehicle are not communicating normally.

If this indicator appears, touch the ignition switch with the Intelligent Key while depressing the brake pedal. (See "Intelligent Key battery discharge" (P.5-11).)

### 8. Key ID incorrect warning (if equipped)

This warning appears when the ignition switch is placed from the "LOCK" position and the Intelligent Key cannot be recognized by the system. You cannot start the engine with an unregistered key. Use the registered Intelligent Key.

See "Intelligent Key system" (P.3-10).

### 9. Release parking brake warning

This warning appears when the vehicle speed is above 7 km/h (4 MPH) (models not equipped with electronic parking brake) or 4 km/h (2 MPH) (models equipped with electronic parking brake) and the parking brake is applied. Stop the vehicle and release the parking brake.

### 10. Low fuel level warning

This warning appears when the fuel level in the fuel tank is getting low. Refuel as soon as it is convenient, preferably before the fuel gauge reaches 0 (Empty). There will be a small reserve of fuel in the tank when the fuel gauge needle reaches 0 (Empty).

### 11. Door/back door open warning

This warning appears if any of the doors and/or the back door are open or not closed securely. The vehicle icon indicates which door or the back door is open on the display.

### 12. Second row seat belt warning (if equipped)

This second row seat belt warning appears after starting the engine. If any of the second row seat passenger seat belts is not fastened, a chime will sound and the seat icon illuminates in red to show which seat belt is not fastened. The seat icon illuminates in red until the corresponding second row

seat passenger's seat belt is fastened. The warning will automatically turn off after approximately 35 seconds. For precautions on seat belt usage, see "Seat belts" (P.1-9).

### 13. Key System Fault warning (if equipped)

This warning appears if there is a malfunction in the Intelligent Key system.

If this warning appears while the engine is stopped, the engine cannot be started. If this warning appears while the engine is running, the vehicle can be driven. However, contact a NISSAN dealer for repair as soon as possible.

### 14. Low tyre pressure warning (if equipped)

This warning ("Low tyre pressure" and a vehicle icon - if equipped) appears when the low tyre pressure warning light in the meter illuminates and low tyre pressure is detected. The warning appears each time the ignition switch is placed in the "ON" position as long as the low tyre pressure warning light remains illuminated. If this warning appears, stop the vehicle and adjust the pressure to the recommended COLD tyre pressure shown on the tyre placard. (See "Low tyre pressure warning light" (P.2-14), "Tire Pressure Monitoring System (TPMS)" (P.6-2).), "Tire Pressure Monitoring System (TPMS)" (P.5-4) and "Tire Pressure Monitoring System (TPMS)" (P.8-36).

### 15. Tyre pressure system fault warning (if equipped)

This warning illuminates when there is a problem with the Tyre Pressure Monitoring System (TPMS).

If this warning comes on, have the system checked by a NISSAN dealer. See "Low tyre pressure warning light" (P.2-14), "Tire Pressure Monitoring System (TPMS)" (P.6-2).), "Tire Pressure Monitoring System (TPMS)"

(P.5-4) and "Tire Pressure Monitoring System (TPMS)" (P.8-36).

### 16. Low oil pressure Stop vehicle warning (if equipped)

This warning appears if low engine oil pressure is detected. If the warning appears during normal driving, pull off the road in a safe area, stop the engine immediately and call a NISSAN dealer.

The low oil pressure warning is not designed to indicate a low oil level. Use the dipstick to check the oil level. (See "Engine oil" (P.8-10).)



#### CAUTION:

**Running the engine with the engine oil pressure warning displayed could cause serious damage to the engine.**

### 17. Oil Level Low indicator (for diesel engine model)

If the low level indicator is displayed, the engine oil level is low. If the low level reminder is displayed, check the level using the engine oil dipstick. (See "Engine oil" (P.8-10).)



#### CAUTION:

**The oil level should be checked regularly using the engine oil dipstick. Operating with an insufficient amount of oil can damage the engine and such damage is not covered by the warranty.**

### 18. Oil level sensor warning (for diesel engine model)

If the oil sensor warning is displayed, the engine oil level sensor may be malfunctioning. Contact a NISSAN dealer immediately. For more details, see "Oil control system (for diesel engine model)" (P.2-33).

### 19. 4WD system fault warning (if equipped)

This warning appears when the four-wheel drive (4WD) system is not functioning properly while the engine is running. Reduce vehicle speed and have your vehicle checked by a NISSAN dealer. See "4WD warning" (P.5-24).

### 20. 4WD High Temp. Stop vehicle warning (if equipped)

This warning may appear while trying to free a stuck vehicle due to increased oil temperature. The driving mode may change to Two-Wheel Drive (2WD). If this warning is displayed, stop the vehicle with the engine idling, as soon as it is safe to do so. Then if the warning turns off, you can continue driving. See "4WD warning" (P.5-24).

### 21. Tyre size incorrect warning (if equipped)

This warning may appear if there is a large difference between the diameters of the front and rear wheels and tires. Pull off the road in a safe area, with the engine idling. Check that all the tyre sizes are the same, that the tyre pressure is correct and that the tyres are not excessively worn. See "4WD warning" (P.5-24).

## 2-30 Instruments and controls

**22. Battery Voltage Low Charge Battery warning**

This warning appears when the battery voltage is low and the battery needs to be charged.

**23. Shipping Mode On Push Storage Fuse warning**

This warning may appear if the extended storage fuse switch is not pushed in (switched on). When this warning appears, push in (switch on) the extended storage fuse switch to turn off the warning. For more information, see "Extended storage fuse switch" (P.8-26).

**24. Headlight system fault warning (if equipped)**

This warning appears if the LED headlights are malfunctioning. Have the system checked by a NISSAN dealer.

**25. Power will turn off to save the battery warning**

This warning appears after a period of time if the shift lever has not moved from the "P" (Park) position while the ignition is in the ON position for a certain period of time.

**26. Power turned off to save the battery warning**

This warning appears after the ignition switch is automatically turned OFF to save the battery.

**27. Turn off headlights warning**

This warning appears when the driver side door is opened with the headlight switch is left ON and the ignition switch is placed in the "OFF" or "LOCK" position. Place the headlight switch in "OFF" or "AUTO" (if equipped) position. For additional information, see "Headlight and turn signal switch" (P.2-39).

**28. Press brake pedal warning (for electronic parking brake equipped models)**

This indicator appears in the following situations:

- The driver tries to release the electronic parking brake manually without depressing the brake pedal.
- The vehicle is stopped on a steep hill and there is a possibility of moving backward, even if the electronic parking brake is applied.

**29-30. Time for a driver break? indicator**

This indicator appears when the set "Time for a driver break?" indicator activates. You can set the time for up to 6 hours.

**31. Low outside temperature warning (if equipped)**

This warning appears if the outside temperature is below 3°C (37°F). The warning can be set not to be displayed.

**32. Chassis control system fault warning**

This warning appears if the chassis control module detects an error in the chassis control system. Have the system checked by a NISSAN dealer. (See "Chassis control" (P.5-28).)

**33. Speed limiter indicator (if equipped)**

This indicator shows the speed limiter system status. The status is shown by the color.

For more details, see "Speed limiter" (P.5-41).

**34. Cruise indicator (if equipped)**

This indicator shows the cruise control system status. The status is shown by the color.

See "Cruise control" (P.5-43) for details.

**35. Continuously Variable Transmission (CVT) position indicator (Continuously Variable Transmission (CVT) models)**

This indicator shows the automatic shift position.

In the manual shift mode, when the transmission does not shift to the selected gear due to a transmission protection mode, the CVT position indicator will blink and a chime will sound.

See "Driving with Continuously Variable Transmission (CVT)" (P.5-13) for further details.

**36. ECO mode system indicator (if equipped)**

The ECO mode indicator appears when the ECO mode system is turned on.

(See "ECO mode system" (P.5-47).)

**37. System fault warning (if equipped)**

This warning appears when the Blind Spot Warning/Lane Departure Warning systems are not functioning properly. (See "Blind Spot Warning (BSW)/Lane Departure Warning (LDW) systems" (P.5-31), "Blind Spot Warning (BSW) system (if equipped for Europe)" (P.5-36) or "Lane Departure Warning (LDW) system (if equipped for Europe)" (P.5-39).)

**38. System fault warning (if equipped)**

This warning appears when the Lane Departure Warning system is not functioning properly. (See "Lane Departure Warning (LDW) system (if equipped for Europe)" (P.5-39).)

**39. System fault warning (if equipped)**

This warning appears when the Blind Spot Warning system is not functioning properly. (See "Blind Spot Warning (BSW) system (if equipped for Europe) " (P.5-36).)

**40. Not available Clean Rear Camera warning (if equipped)**

This warning appears if dirt, rain or snow accumulates on the rear camera and cannot be removed by the automatic washer and blower. See "Blind Spot Warning (BSW)/Lane Departure Warning (LDW) systems" (P.5-31).

**41. Not available Clean Rear Camera warning (if equipped)**

This warning appears if dirt, rain or snow accumulates on the rear camera and cannot be removed by the automatic washer and blower. See "Blind Spot Warning (BSW) system (if equipped for Europe) " (P.5-36).

**42. CVT System Fault warning (for Continuously Variable Transmission (CVT) models)**

This warning appears when there is a malfunction with the CVT system. If this warning comes on, have the system checked by a NISSAN dealer.

**43. Navigation indicator (if equipped)**

This indicator appears when a corner point is coming.

**44. Stop/Start System or Idling Stop System indicator (if equipped)**

This indicator shows the Stop/Start System or Idling Stop System status. See "Stop/Start System or Idling Stop System" (P.5-18).

**45. System fault warning (if equipped)**

This warning appears when the Driver Attention Alert system malfunctions.

For more details, see "Driver Attention Alert" (P.2-36).

**46. System fault warning (if equipped)**

This warning appears when the Traffic Sign Recognition system malfunctions.

For more details, see "Traffic Sign Recognition" (P.2-37).

**47. System fault warning (if equipped)**

This warning appears when the forward emergency braking system malfunctions.

For more details, see "Forward emergency braking system" (P.5-45).

**48. Not Available Front Radar Obstruction warning (if equipped)**

If the sensor area of the front bumper is covered with dirt or obstructed, making it impossible to detect a vehicle ahead, the forward emergency braking system is automatically turned off. The forward emergency braking system warning light (orange) will illuminate and the [Not Available Front Radar Obstruction] warning message will appear in the vehicle information display. If the [Not Available Front Radar Obstruction] warning message appears, park the vehicle in a safe

location and turn the engine off.

Check to see if the sensor area of the front bumper is blocked. If the sensor area of the front bumper is blocked, remove the blocking material. Restart the engine. If the warning light continues to illuminate, have the forward emergency braking system checked by a NISSAN dealer.

**49. Not available High cabin temperature warning (if equipped)**

This warning appears if the interior temperature of the vehicle has reached such a high temperature that the sensor for the Traffic Sign Recognition and Lane Departure warning systems can no longer function reliably. Once the interior temperature has reached normal levels, the warning should disappear.

If the warning continues to display, have the system checked by a NISSAN dealer.

**50. Parking Sensor System Fault warning (if equipped)**

This warning illuminates when there is a problem with the parking sensor system. If this warning comes on, have the system checked by a NISSAN dealer.

**2-32 Instruments and controls**

## OIL CONTROL SYSTEM (for diesel engine model)

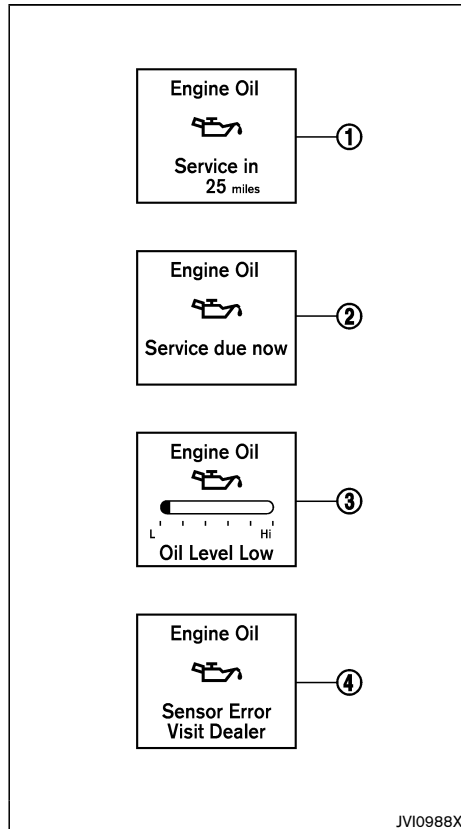

When the ignition switch is in the "ON" position, engine oil information is displayed.

Engine oil information informs the distance to oil change, oil level indication and malfunction of oil level sensor.

### 1. Distance to oil change

The distance to oil change is displayed if the distance to oil change is less than 1,500 km (930 miles).

### 2. Oil replacement indicator

When the set mileage approaches, the engine oil replacement indicator will appear on the display. After the oil is changed, reset the distance to oil change. The oil replacement indicator will not be reset automatically. To reset this indicator, see "Settings" (P.2-21).

The distance to oil change interval cannot be adjusted manually. The distance to oil change interval is set automatically.

### CAUTION:

**If the oil replacement indicator is displayed, change the engine oil as soon as possible. Operating your vehicle with deteriorated oil can damage the engine.**

### 3. Low level reminder

If the low level indicator is displayed, the engine oil level is low. If the low level reminder is displayed, check the level using the engine oil dipstick. (See "Engine oil" (P.8-10).)

### CAUTION:

**The oil level should be checked regularly using the engine oil dipstick. Operating with an insufficient amount of oil can damage the**

**engine and such damage is not covered by the warranty.**

### 4. Oil level sensor warning

If the oil sensor warning is displayed, the engine oil level sensor may be malfunctioning. Contact a NISSAN dealer immediately.

### TRIP COMPUTER

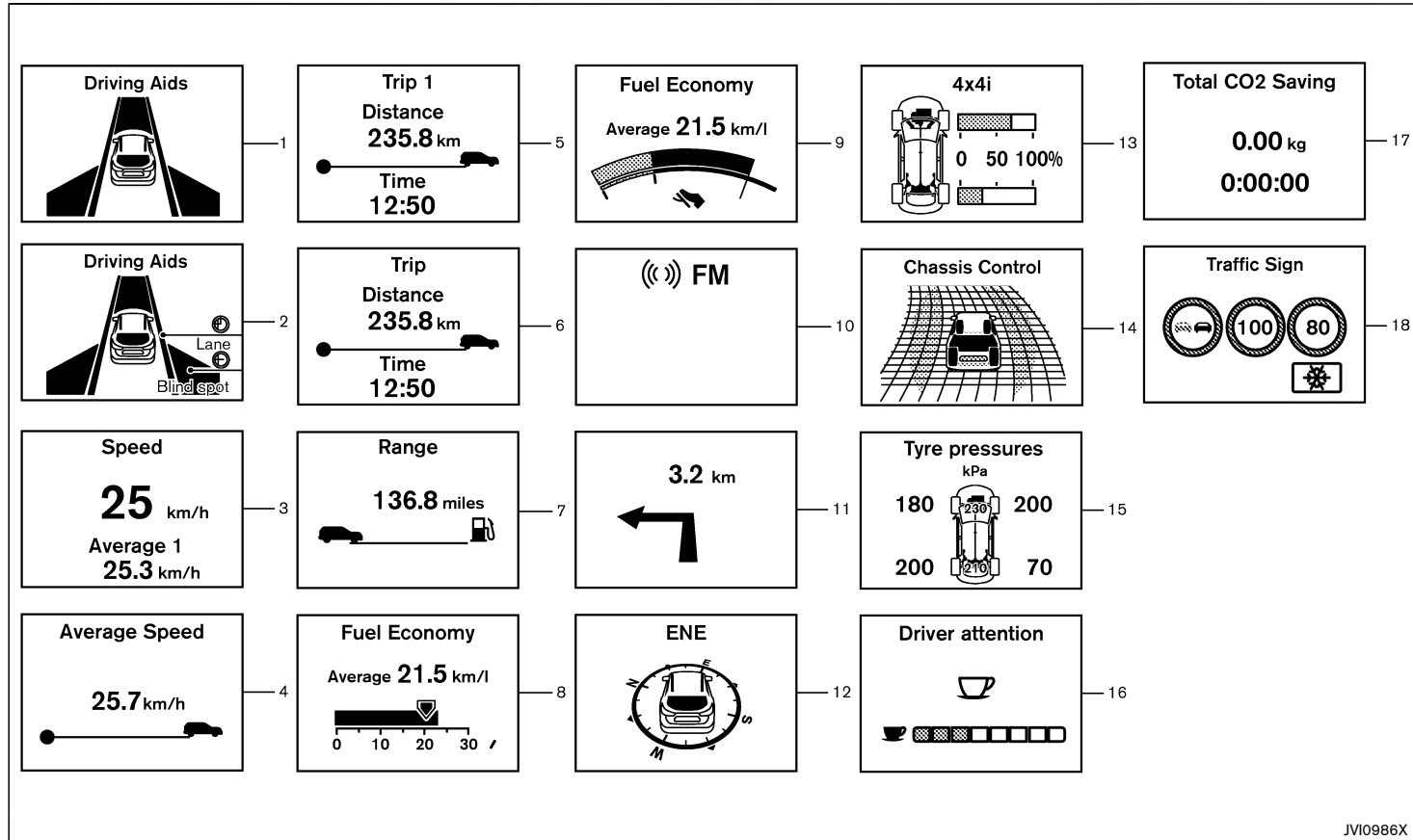

JVI0986X

### 2-34 Instruments and controls

## 1-2. Driving aids (if equipped)

The driving aids mode shows the operating condition for the following systems.

- Lane Departure Warning (LDW)
- Blind Spot Warning (BSW)
- Forward Emergency Braking (if equipped)

For more details, see “Blind Spot Warning (BSW)/ Lane Departure Warning (LDW) systems” (P.5-31), “Forward emergency braking system” (P.5-45), “Blind Spot Warning (BSW) system (if equipped for Europe)” (P.5-36) or “Lane Departure Warning (LDW) system (if equipped for Europe)” (P.5-39).

## 3. Speed and Average speed (km/h or MPH)

The (digital) speed shows the current speed at which the vehicle is travelling.

The average speed mode shows the average vehicle speed since the last reset. Resetting is done by pushing the ENTER ① (Type A) or  ② (Type B) switch for longer than 1 second.

The display is updated every 30 seconds. The first 30 seconds after a reset, the display shows “—”.

## 4. Average speed (km/h or MPH)

The average speed mode shows the average vehicle speed since the last reset. Resetting is done by pushing the ENTER ① (Type A) or  ② (Type B) switch for longer than 1 second.

The display is updated every 30 seconds. The first 30 seconds after a reset, the display shows “—”.

## 5-6. Elapsed time and trip odometer (km or mile)

### Elapsed time:

The elapsed time mode shows the time since the last reset. The displayed time can be reset by pushing the ENTER ① (Type A) or  ② (Type B) switch for longer than 1 second. (The trip odometer is also reset at the same time.)

### Trip odometer:

The trip odometer mode shows the total distance the vehicle has been driven since the last reset. Resetting is done by pushing the ENTER ① (Type A) or  ② (Type B) switch for longer than 1 second. (The elapsed time is also reset at the same time.)

## 7. Distance to empty (dte — km or mile)

The distance to empty (dte) mode provides you with an estimation of the distance that can be driven before refueling. The dte is constantly being calculated, based on the amount of fuel in the fuel tank and the actual fuel consumption.

The display is updated every 30 seconds.

The dte mode includes a low range warning feature. If the fuel level is low, the warning is displayed on the screen.

When the fuel level drops even lower, the dte display will change to “—”.

- If the amount of fuel added is small, the display just before the ignition switch is placed in the “OFF” position may continue to be displayed.
- When driving uphill or rounding curves, the fuel in the tank shifts, which may momentarily change the display.

## 8-9. Fuel economy (l (litre)/100 km, km/l(litre) or MPG)

### Current fuel consumption:

The current fuel consumption mode shows the current fuel consumption.

### Average fuel consumption:

The average fuel consumption mode shows the average fuel consumption since the last reset. Resetting is done by pushing the ENTER ① (Type A) or  ② (Type B) switch for longer than 1 second.

The display is updated every 30 seconds. For about the first 500 m (1/3 mile) after a reset, the display shows “—”.

## 10. Audio (if equipped)

The audio mode shows the status of audio information.

## 11. Navigation (if equipped)

When the route guidance is set in the navigation system, this item shows the navigation route information.

## 12. Compass (if equipped)

This display indicates the heading direction of the vehicle.

## 13. “4x4-i” display (if equipped)

When the “4x4-i” display is selected, you can view the distribution ratio of the transmission torque to the front and rear wheels during driving.

## 14. Chassis control

When Active Trace Control, Active Engine Brake or Active Ride Control system is operated, it shows the operating condition. It also shows operating condition of Hill Start Assist or the Hill Descent Control. See "Active Trace Control" (P.5-28), "Active Engine Brake (Continuously Variable Transmission (CVT) models)" (P.5-28), "Active Ride Control" (P.5-29), "Hill Start Assist system" (P.5-30) or "Hill descent control system" (P.5-30) for more details.

## 15. Tyre Pressures (if equipped)

The tire pressure mode shows the pressure of all four tyres while the vehicle is driven.

When the Low Tyre Pressure warning appears, the display can be switched to the tire pressure mode by pushing the ENTER switch ① to reveal additional details on the displayed warning.

## 16. Driver Attention Alert system (if equipped)

When the "Driver Attention Alert" display is selected, you can view your attention level as detected by the system. For more information see "Driver Attention Alert" (P.2-36).

## 17. Stop/Start System or Idling Stop System (if equipped)

The Stop/Start System or Idling Stop System mode shows the CO<sub>2</sub> or fuel savings and the engine stop time. (See "Stop/Start System or Idling Stop System" (P.5-18).)

### Trip CO<sub>2</sub> or fuel saving and engine stop time:

The trip CO<sub>2</sub> or fuel saving and engine stop time mode shows amount of CO<sub>2</sub> or fuel saved and the engine stop time since the last reset.

The CO<sub>2</sub> or fuel saving and engine stop time can be

reset by pushing the ENTER switch ① (Type A) or  ② (Type B) in the "Stop/Start" menu. For more information, see "Display Settings" (P.2-22).

### Total CO<sub>2</sub> or fuel saving and engine stop time:

The total CO<sub>2</sub> or fuel saving and engine stop time mode shows:

- The estimated CO<sub>2</sub> exhaust emissions prevented. (for Europe and South Africa)
- The estimated quantity of saved fuel. (for Australia and New Zealand)
- The time that the engine has been stopped for by the Stop/Start System or Idling Stop System.

### NOTE:

**The Total CO<sub>2</sub> or fuel saving and engine stop time values cannot be reset and show accumulated Stop/Start System or Idling Stop System information since the vehicle was built.**

## 18. Traffic Sign Recognition (if equipped)

The Traffic Sign Recognition (TSR) system provides the driver with information about the most recently detected speed limit. For more details, see "Traffic Sign Recognition" (P.2-37).

## CLOCK AND OUTSIDE AIR TEMPERATURE

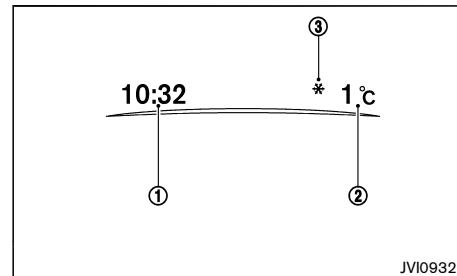

The clock ① and outside air temperature ② are displayed on the upper side of the vehicle information display.

### Clock

For clock adjustment, see "Clock" (P.4-6) or "Audio settings" (P.4-58).

### Outside air temperature (°C or °F)

The outside air temperature is displayed in °C or °F in the range of -40 to 60°C (-40 to 140°F).

The outside air temperature mode includes a low temperature warning feature. If the outside air temperature is below 3°C (37°F), the warning ③ is displayed on the screen (if equipped).

The outside temperature sensor is located in front of the radiator. The sensor may be affected by road or engine heat, wind directions and other driving conditions. The display may differ from the actual outside temperature or the temperature displayed on various signs or billboards.

### DRIVER ATTENTION ALERT (if equipped)

The [Driver Attention] option can be used to activate or deactivate the Driver Attention Support feature. This system is able to detect whether the driver is displaying a lack of attention, or is distracted.

It does this by monitoring driving style, and steering behavior, and it notes deviations from the normal pattern. If the system detects that driver attention is decreasing, the system uses an audible and visual warning to suggest that the driver take a break.



### WARNING:

**This system is not designed to assist driving impaired due to fatigue, or other causes. Be attentive at all times, and avoid driving when**



tired. Failure to do so could cause you to lose control of the vehicle, resulting in a serious accident.

#### System operation



If the system detects that driver attention is decreasing, the message “Time for a driver break?” appears in the vehicle information display and a buzzer sounds when the vehicle is driven at speeds above 60 km/h (37 MPH).

#### Attention level indicator:

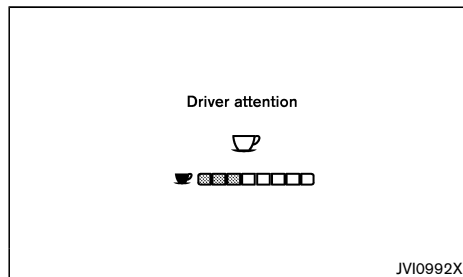

When the “Driver attention” display is selected, you can view your attention level as detected by the

system.

For more information see “Settings” (P.2-21).

#### NOTE:

- The attention level indicator consists of eight levels.
- When stopping the engine, the system is reset.

Turning the Driver Attention Alert system on and off

To activate or deactivate this function, see “Settings” (P.2-21).

#### NOTE:

**The setting will be retained even if the engine is restarted.**

#### System Malfunction

If the Driver Attention Alert system malfunctions, the system warning message will appear in the vehicle information display and the function will be stopped automatically.

#### Action to take:

Stop the vehicle in a safe location, and then turn off and restart the engine. If the system warning message continues to appear, have the system checked by a NISSAN dealer.

#### TRAFFIC SIGN RECOGNITION (if equipped)

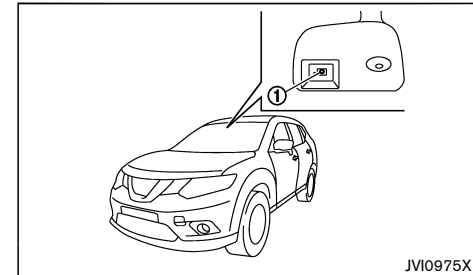

The Traffic Sign Recognition (TSR) system provides the driver with information about the most recently detected speed limit. The system captures the road sign information with the multi-sensing front camera unit ① located on the windshield in front of the inside rearview mirror and displays the detected signs in the vehicle information display. For vehicles equipped with navigation system, the speed limit displayed is based on a combination of navigation system data and live camera recognition. TSR information is always displayed at the top of the vehicle information display, and optionally in the main central area of the display screen.



#### WARNING:

**The TSR system is only intended to be a support device to provide the driver with information. It is not a replacement for the driver's attention to traffic conditions or responsibility to drive safely. It cannot prevent accidents due to carelessness. It is the driver's responsibility to stay alert and drive safely at all times.**

## System operation

The traffic recognition system displays the following types of road sign:

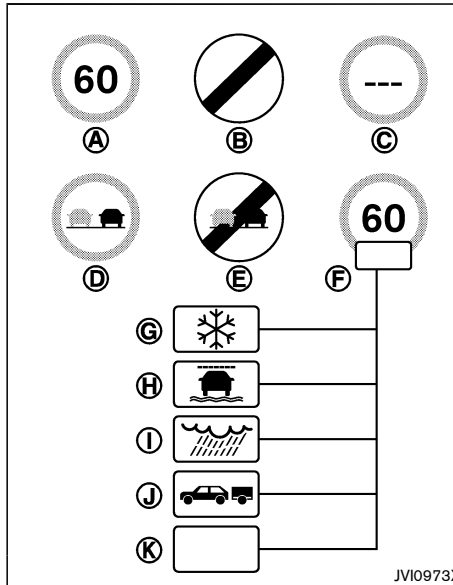
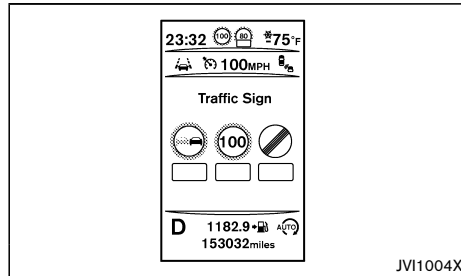

- (A) Latest detected speed limit.
- (B) National speed limit
- (C) No speed limit information.
- (D) No-overtaking zone.
- (E) End of no-overtaking zone.
- (F) Conditional speed limit, with the following available conditions:
- (G) Snow
- (H) Slip (rain 1)
- (I) Rain (rain 2)
- (J) Towing

(K) Generic

### **CAUTION:**

- The Traffic Sign Recognition (TSR) system is intended as an aid to careful driving. It is the driver's responsibility to stay alert, drive safely, and observe all road regulations that currently apply, including looking out for road signs.
- The Traffic Sign Recognition (TSR) system may not function properly under the following conditions:
  - When rain, snow or dirt adheres to the windshield in front of the TSR camera unit.
  - When the headlights are not bright due to dirt on the lens or if the aiming is not adjusted properly.
  - When strong light enters the camera unit. (For example, the light directly shines on the front of the vehicle at sunrise or sunset.)
  - When a sudden change in brightness occurs. (For example, when the vehicle enters or exits a tunnel or under a bridge.)
  - In areas not covered by the navigation system.
  - If there are deviations in relation to the navigation, for example due to changes in the road routing.
  - When overtaking buses or trucks with speed stickers.

### Turning the TSR system on and off

Turning the LDW system on or off is done using the [Settings] menu in the vehicle information display. For details, see "Vehicle information display" (P.2-20).

Perform the following steps to enable or disable the TSR system:

1. In the [Settings] menu, select the [Driver Assistance] key.
2. Touch [Traffic Sign] to turn the system ON/OFF.

### System temporarily unavailable

If the vehicle is parked in direct sunlight under high temperature conditions (over approximately 40°C (104°F) ) and then started, the TSR system may be deactivated automatically. The [Not available high cabin temperature] warning message will appear in the vehicle information display.

#### Action to take:

When the interior temperature is reduced, the TSR system will resume operating automatically.

### System Malfunction

If the TSR system malfunctions it will be turned off automatically and the system [Malfunction]/[System error] warning message will appear in the vehicle information display.

#### Action to take:

If the TSR [Malfunction]/[System error] message appears, pull off the road at a safe location and stop the vehicle. Turn the engine off and restart the engine. If the TSR [Malfunction]/[System error] message continues to appear, have the system checked by a NISSAN dealer.

### Maintenance

The TSR uses the same multi-sensing front camera unit that is used by the Lane Departure Warning (LDW) system, located in front of the interior rearview mirror. For maintenance of the camera, see "Multi-sensing camera unit maintenance" (P.5-41).

## HEADLIGHT AND TURN SIGNAL SWITCH

### HEADLIGHT SWITCH

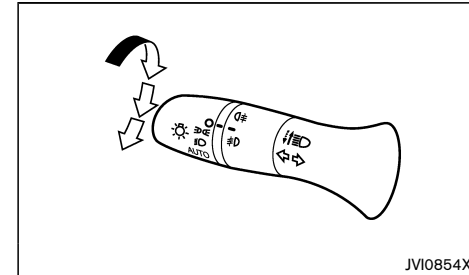

Type A

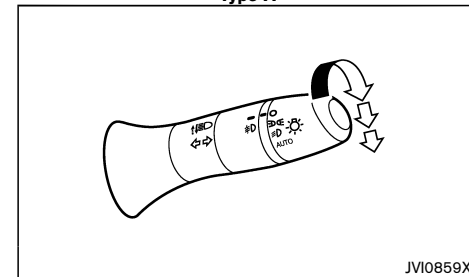

Type B

NISSAN recommends that you consult the local regulations concerning the use of lights.

#### ☞☞ position

The ☞☞ position turns on the front clearance, tail, license plate and instrument panel lights.

### position

The  position turns on the headlights in addition to the other lights.

### AUTO position (if equipped)

When the ignition switch is in the "ON" position and the headlight switch is in the "AUTO" position, the headlights, front clearance lights, instrument panel lights, rear combination lights and other lights turn on automatically depending on the brightness of the surroundings.

The headlights will turn on automatically at twilight or in rainy weather (when the windshield wiper is operated continuously).

When the ignition switch is placed in the "LOCK" or "OFF" position, the lights will turn off automatically.

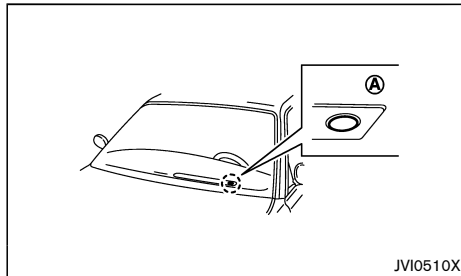

### CAUTION:

**Do not place any objects on top of the sensor  . The sensor senses the brightness level and controls the autolight function. If the sensor is covered, it reacts as if it is dark, and the headlights will illuminate.**

## 2-40 Instruments and controls

### Headlight beam

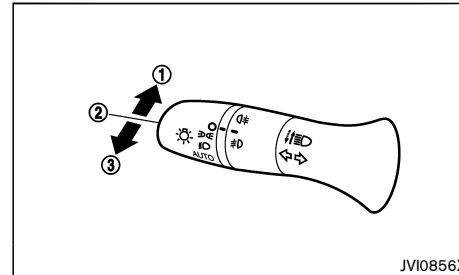

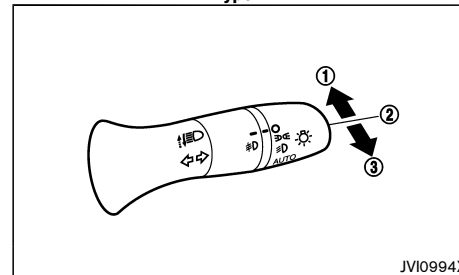

Type A



Type B

To turn on the high beam, push the lever towards the front position  .

To turn off the high beam, return the lever to the neutral position  .

To flash the headlights, pull the lever towards the rearmost position  . The headlights can be flashed even when the headlights are not on.

If equipped, when the lever is pulled towards the rearmost position  after the ignition switch is placed in the "OFF" or "LOCK" position, the headlight will turn on and stay on for 30 seconds. The lever can

be pulled 4 times for up to 2 minutes.

### High beam assist (if equipped)

The high beam assist system will operate when the vehicle is driven at speeds of approximately 40 km/h (25 MPH) and above. If an oncoming vehicle or leading vehicle appears in front of your vehicle when the headlight high beam is on, the headlight will be switched to the low beam automatically.

### Precautions on high beam assist:



### WARNING:

- **The high beam assist system is a convenience but it is not a substitute for safe driving operation. The driver should remain alert at all times, ensure safe driving practices and switch the high beam and low beam manually when necessary.**
- **The high beam or low beam may not switch automatically under the following conditions. Switch the high beam and low beam manually.**
  - **During bad weather (rain, fog, snow, wind, etc.).**
  - **When a light source similar to a headlight or tail light is in the vicinity of the vehicle.**
  - **When the headlights of the oncoming vehicle or the leading vehicle are turned off, when the color of the light is affected due to foreign materials on the lights, or when the light beam is out of position.**

- When there is a sudden, continuous change in brightness.
- When driving on a road that passes over rolling hills, or a road that has level differences.
- When driving on a road with many curves.
- When a sign or mirror-like surface is reflecting intense light towards the front of the vehicle.
- When the container, etc. being towed by a leading vehicle is reflecting intense light.
- When a headlight on your vehicle is damaged or dirty.
- When the vehicle is leaning at an angle due to a punctured tire, being towed, etc.
- The timing of switching the low beam and high beam may change under the following situations.
  - The brightness of the headlights of the oncoming vehicle or leading vehicle.
  - The movement and direction of the oncoming vehicle and the leading vehicle.
  - When only one light on the oncoming vehicle or the leading vehicle is illuminated.
  - When the oncoming vehicle or the leading vehicle is a two-wheeled vehicle.

- Road conditions (incline, curve, the road surface, etc.).
- The number of passengers and the amount of luggage.

#### High beam assist operations:

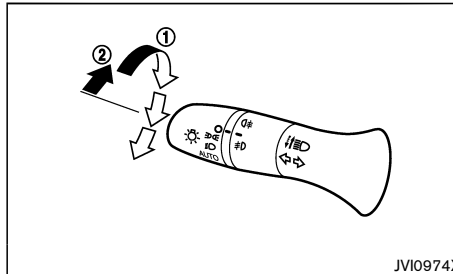

Type A

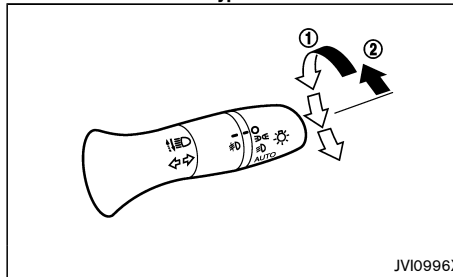

Type B

To activate the high beam assist system, turn the headlight switch to the "AUTO" position ① and push the lever forward ② (high beam position). The high beam assist indicator light in the meter will illuminate while the headlights are turned on.

If the high beam assist indicator light does not

illuminate in the above condition, it may indicate that the system is not functioning properly. Have the system checked by a NISSAN dealer.

When the vehicle speed lowers to less than approximately 25 km/h (16 MPH), the headlight remains the low beam.

To turn off the high beam assist system, turn the headlight switch to the  position or select the low beam position by placing the lever in the neutral position.

#### Ambient image sensor maintenance:

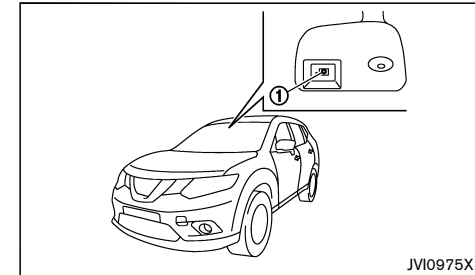

The ambient image sensor ① for the high beam assist system is located in front of the inside rearview mirror. To keep the proper operation of the high beam assist system and prevent a system malfunction, be sure to observe the following:

- Always keep the windshield clean.
- Do not attach a sticker (including transparent material) or install an accessory near the ambient image sensor.
- Do not strike or damage the areas around the ambient image sensor. Do not touch the sensor lens that is located on the ambient image sensor.

If the ambient image sensor is damaged due to an

#### Instruments and controls 2-41

accident, contact a NISSAN dealer.

### Daytime running light system

Even if the headlight switch is  $\bigcirc$  position, the daytime running lights will come on after starting the engine.

When the light switch is turned to the  $\text{EDGE}$  position, the daytime running light will turn off.

### HEADLIGHT AIMING CONTROL

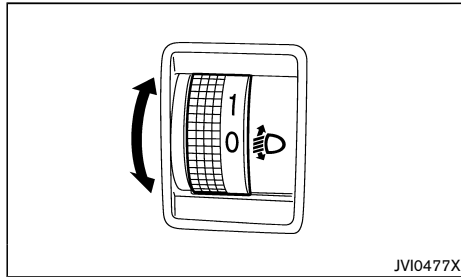

#### Manual type

The headlight aiming control operates when the ignition switch is in the "ON" position and the headlight is on to allow the headlight axis to be adjusted according to the driving condition.

When driving with no heavy load/luggage or driving on a flat road, select the normal position "0".

If the number of occupants and load/luggage in the vehicle changes, the headlight axis may become higher than normal.

If the vehicle is traveling on a hilly road, the headlights may directly shine on the rearview and outside mirrors of a vehicle ahead or the windshield of an oncoming vehicle, which may obscure other drivers' vision.

To adjust to the proper aiming height, turn the switch

accordingly. The higher the number, designated on the switch, the lower the headlight axis.

Select the switch position by referring to the following samples.

## 2-42 Instruments and controls

**Two-row model**

Switch position	Number of front seat occupants	Number of rear seat occupants	Weight of load in luggage compartment [APPROX. kg ( lb )]											
			2WD						4WD					
			MR20			QR25		R9M		MR20		QR25		R9M
			MT	M-CVT	CVT	M-CVT	CVT	MT	M-CVT	M-CVT	CVT	M-CVT	CVT	MT
0	1 or 2	No occupants	No load											
1	2	3												
2	2	3	102 kg (225 lb)	111 kg (245 lb)	65 kg (143 lb)	120 kg (265 lb)	64 kg (141 lb)	170 kg (375 lb)	178 kg (392 lb)	117 kg (258 lb)	75 kg (165 lb)	152 kg (335 lb)	123 kg (271 lb)	252 kg (556 lb)
3	1	No occupants	305 kg (673 lb)	318 kg (701 lb)	251 kg (553 lb)	318 kg (701 lb)	266 kg (587 lb)	365 kg (805 lb)	371 kg (818 lb)	322 kg (710 lb)	269 kg (593 lb)	359 kg (792 lb)	332 kg (732 lb)	436 kg (961 lb)



**Three-row model**

Switch position	Number of front seat occupants	Number of second row seat occupants	Number of third row seat occupants	Weight of load in luggage compartment [APPROX. kg ( lb )]									
				2WD						4WD			
				MR20			QR25		R9M		QR25	R9M	
				MT	M-CVT	CVT	M-CVT	CVT	MT	M-CVT	M-CVT	MT	
0	1 or 2	No occupants	No occupants	No load									
1	2	No occupants or 3	2										
2	2	3	2	95 kg (209 lb)	62 kg (137 lb)	61 kg (135 lb)	134 kg (295 lb)	57 kg (126 lb)	137 kg (302 lb)	142 kg (313 lb)	30 kg (66 lb)	141 kg (311 lb)	
3	1	No occupants	No occupants	472 kg (1041 lb)	438 kg (966 lb)	428 kg (944 lb)	509 kg (1122 lb)	420 kg (926 lb)	524 kg (1155 lb)	515 kg (1136 lb)	474 kg (1045 lb)	525 kg (1158 lb)	



### Automatic type

The headlights are equipped with the automatic leveling system. Headlight axis is controlled automatically.



### BATTERY SAVER SYSTEM

The light reminder chime will sound if the headlight switch is in either the  or  position and when the driver's door is opened with the ignition switch in the "OFF" or "LOCK" position.

#### Type A:

If the ignition switch is placed in "OFF" or "LOCK" position while the headlight switch is in the  or  position, the battery saver function will turn off the lights after a period of time to prevent the battery from being discharged. The lights will turn on when the doors are being opened.

#### Type B:

If the ignition switch is placed in "OFF" or "LOCK" position while the headlight switch is in the  or  position, the battery saver function will turn off the lights after opening the driver's side door.

### HEADLIGHT CLEANER (if equipped)

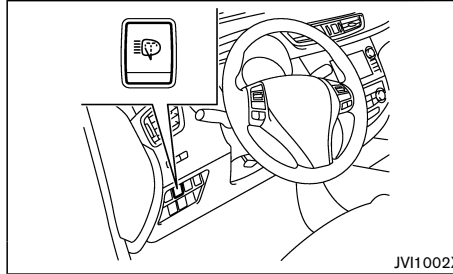

#### Headlight cleaner switch (if equipped)

The headlight cleaner operates when the headlight is on and the ignition switch is in the "ON" position.

To operate the headlight cleaner:

- Push the headlight cleaner switch (if equipped)
- Pull the windshield washer switch toward you.
  - The headlight cleaner operates with the windshield washer operation. This operation activates once each time either the ignition switch or the headlight switch is turned off and on.
  - After the first operation, the headlight cleaner operates once at every fifth operation of the windshield washer.

See "Wiper and washer switch" (P.2-47).



#### CAUTION:

- Do not operate the washer if the window washer fluid reservoir is empty.

### TURN SIGNAL SWITCH

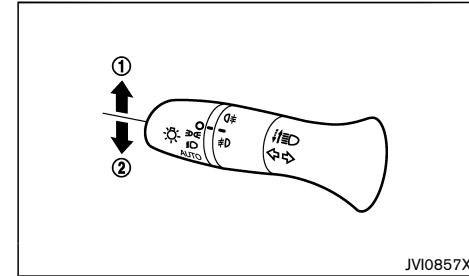

#### Type A

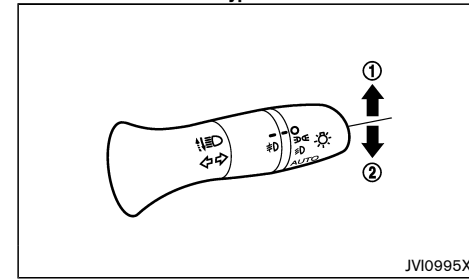

#### Type B



#### CAUTION:

The turn signal switch will not be cancelled automatically if the steering wheel turning angle does not exceed the preset amount. After the turn or lane change, make sure that the turn signal switch is returned to its original position.



### FOG LIGHT SWITCH

#### Turn signal

To turn on the turn signals, move the lever up ① or down ② to the point where the lever latches. When the turn is completed, the turn signal cancels automatically.

#### Lane change signal

To turn on the lane change signals, move the lever up ① or down ② to the point where the light begins to flash.

If the lever is moved back right after moving up ① or down ②, the light will flash 3 times.

To cancel the flashing, move the lever to the opposite direction.

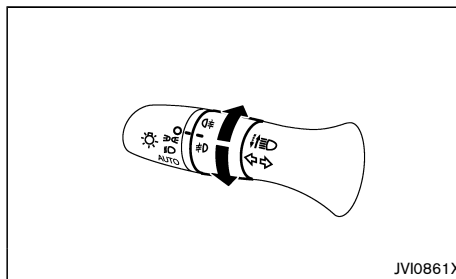

Type A

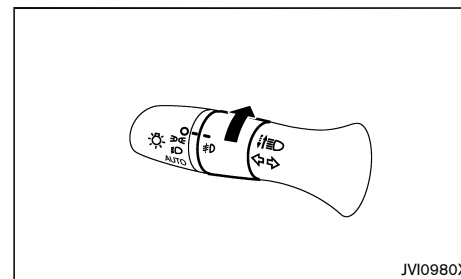

Type C

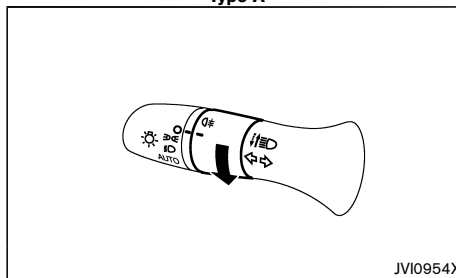

Type B

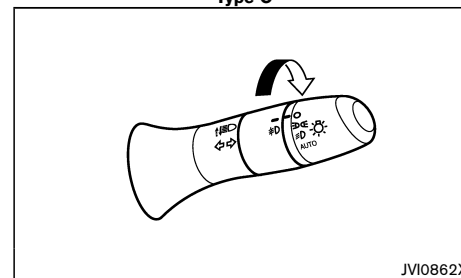

Type D

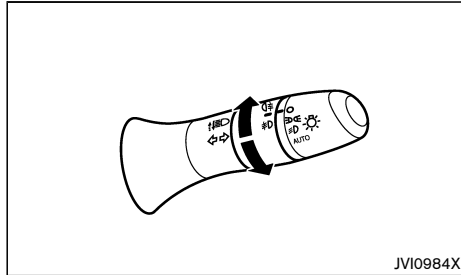

Type E

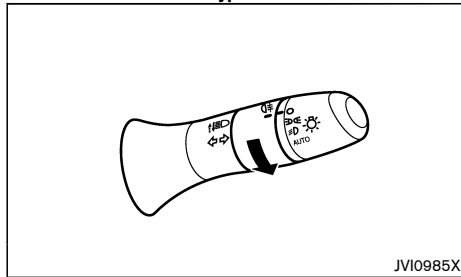

Type F

## FRONT FOG LIGHTS (if equipped)

### For models with rear fog light:

To turn on the front fog lights, turn the headlight switch to the  $\text{HID}$  or  $\text{F}$  or AUTO (if equipped) position, then turn the fog light switch to the  $\text{F}$  position. The front fog lights and  $\text{F}$  indicator light on the meter illuminate. The fog light switch will return to the  $\text{OFF}$  position automatically.

To turn the front fog lights off, turn the fog light switch to the  $\text{OFF}$  position again.

### For models without rear fog light:

To turn on the front fog lights, turn the headlight switch to the  $\text{HID}$  or  $\text{F}$  or AUTO (if equipped) position, then turn the fog light switch to the  $\text{F}$  position. The front fog lights and  $\text{F}$  indicator light on the meter illuminate.

To turn the front fog lights off, turn the fog light switch to the  $\text{OFF}$  position.

### NOTE:

- If the headlight switch is turned to the  $\text{OFF}$  position, the front fog lights will turn off automatically.

## REAR FOG LIGHT (if equipped)

The rear fog light should be used only when visibility is seriously reduced [generally, to less than 100 m (328 ft)].

### For Europe and South Africa

To turn on the rear fog light, turn the headlight switch to the  $\text{F}$  or AUTO (if equipped) position, then turn the fog light switch to the  $\text{R}$  position. The rear fog light and  $\text{R}$  indicator light on the meter illuminate. The fog light switch will return to the  $\text{OFF}$  position automatically.

If the front fog lights (if equipped) are already turned on with the headlight switch in the  $\text{F}$  position, you can turn on the rear fog light without first turning the headlight switch to the  $\text{F}$  or AUTO (if equipped) position.

To turn the rear fog light off, turn the fog light switch to the  $\text{OFF}$  position again.

### Except for Europe and South Africa

To turn on the rear fog light, turn the headlight switch to the  $\text{F}$  position, then turn the fog light switch to the  $\text{R}$  position. The rear fog light and  $\text{R}$  indicator

light on the meter illuminate. The fog light switch will return to the  $\text{OFF}$  position automatically.

If the front fog lights (if equipped) are already turned on with the headlight switch in the  $\text{F}$  position, you can turn on the rear fog light without first turning the headlight switch to the  $\text{F}$  position.

To turn the rear fog light off, turn the fog light switch to the  $\text{OFF}$  position again.

### NOTE:

- If the headlight switch is turned to the  $\text{OFF}$  position, the rear fog light will turn off automatically.

## WIPER AND WASHER SWITCH

### **! WARNING:**

In freezing temperatures, the washer fluid may freeze on the windshield and obscure your vision. Warm the windshield with the defogger before you wash the windshield.

### **! CAUTION:**

- Do not operate the washer continuously for longer than 30 seconds.
- Do not operate the washer if the window washer reservoir is empty.

### WINDSHIELD WIPER AND WASHER SWITCH

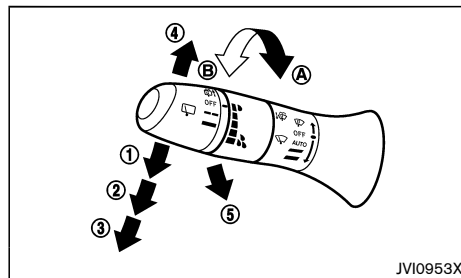

Type A

JVI0953X

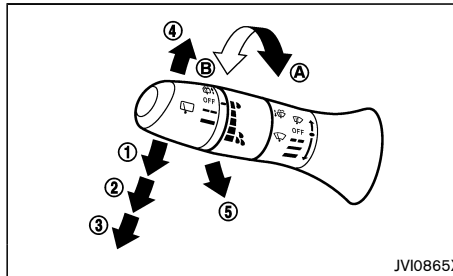

Type B

JVI0865X

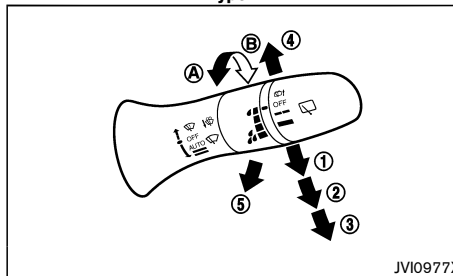

Type C

JVI0977X

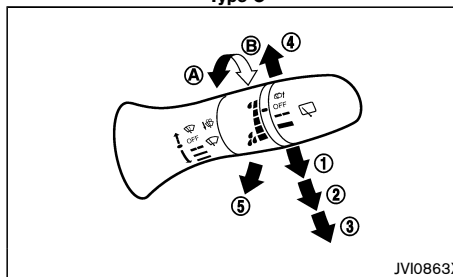

Type D

JVI0863X

The windshield wiper and washer operate when the

ignition switch is in the "ON" position.

### Wiper operation

The lever position "AUTO" (Type A/Type C) ① operates the rain-sensing auto wiper system (if equipped). (See "Rain-sensing auto wiper system" (P.2-48).)

The lever position "INT" (INT) ① (Type B/Type D) operates the wiper intermittently.

- The intermittent operation can be adjusted by turning the adjustment control knob, (longer) (A) or (shorter) (B).
- The speed of the intermittent operation varies depending on the vehicle speed. (if equipped).

The lever position ② operates the wiper at low speed.

The lever position ③ operates the wiper at high speed.

To stop the wiper operation, move the lever up to the "OFF" position.

The lever position ④ operates the wiper one sweep. The lever automatically returns to its original position.

**If the windshield wiper operation is interrupted by snow or ice, the wiper may stop moving to protect its motor. If this occurs, turn the wiper switch to the "OFF" position and remove the snow or ice on and around the wiper arms. In approximately 1 minute, turn the switch on again to operate the wiper.**

### Pulling up the wiper arm:

The wiper arm should be in the up position when replacing the wiper.

To pull up the wiper arm, push the lever ④ up twice (within 0.5 seconds) when the ignition switch is in the "OFF" position within 1 minute. The wiper operation

**Instruments and controls 2-47**

stops in mid-operation.

To replace the wiper arm, place the wiper arm in the down position and then push the lever ④ up once.

**CAUTION:**

- **This function can be operated even if the ignition switch is in the “ON” position. However, to prevent an accident or damage when pulling up the wiper arm, be sure to observe the following precautions.**
  - **Make sure the shift lever is in the P (Park) position (Continuously Variable Transmission models).**
  - **Make sure the shift lever is in the N (Neutral) position, with the parking brake fully applied (Manual Transmission models).**
  - **Never allow the passengers to operate the windshield wiper switch inadvertently.**
- **Do not operate the windshield wiper while the wiper arm is pulled up. The wiper arm may be damaged.**

### Washer operation

To operate the washer, pull the lever toward the rear of the vehicle ⑤ until the desired amount of washer fluid is spread on the windshield.

The headlight cleaner (if equipped) will also operate with operation of the windshield washer. See “Headlight cleaner” (P.2-44).

## 2-48 Instruments and controls

### Wiper drip wipe system:

The wiper will also operate once about 3 seconds after the washer and wiper are operated. This operation is to wipe washer fluid that has dripped on the windshield.

To activate or deactivate this function, see “Settings” (P.2-21).

### RAIN-SENSING AUTO WIPER SYSTEM (if equipped)

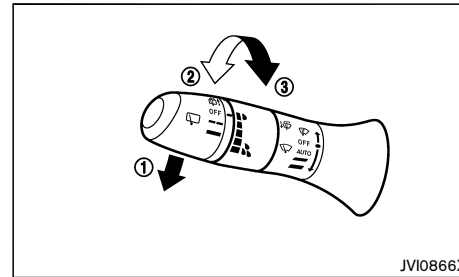

Type A

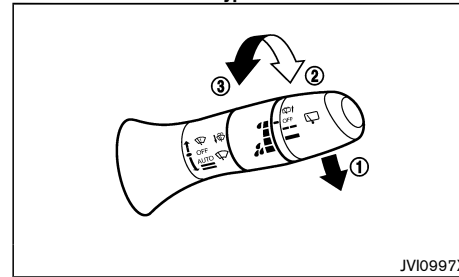

Type B

The rain-sensing auto wiper system can automatically turn on the wipers and adjust the wiper speed depending on the rainfall and the vehicle speed by using the rain sensor located on the upper part of the

windshield.

To set the rain-sensing auto wiper system, push the lever down to the AUTO position ①. The wiper will sweep once while the ignition switch is in the “ON” position.

The rain sensor sensitivity level can be adjusted by turning the knob toward the front ② (High) or toward the rear ③ (Low).

- High — High sensitive operation
- Low — Low sensitive operation

To turn the rain-sensing auto wiper system off, push up the lever to the “OFF” position, or pull down the lever to the other.

**CAUTION:**

- **Do not touch the rain sensor and around it when the wiper switch is in the AUTO position and the ignition switch is in the “ON” position. The wipers may operate unexpectedly and cause to an injury or a wiper damage.**
- **When the windshield glass is coated with water repellent, the speed of the rain-sensing auto wipers may be higher even though the amount of the rainfall is small.**
- **Be sure to turn off the rain-sensing auto wiper system when you use a car wash.**
- **The rain-sensing auto wipers may not operate if rain does not hit the rain sensor even if it is raining.**
- **Using genuine wiper blades is recommended for proper operation of the rain-sensing auto wiper system. (See “Wiper blades” (P.8-18) for wiper blade replace-**

ment.)  
REAR WINDOW WIPER AND WASHER SWITCH

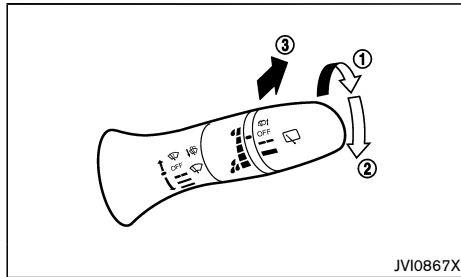

Type A

JVI0867X

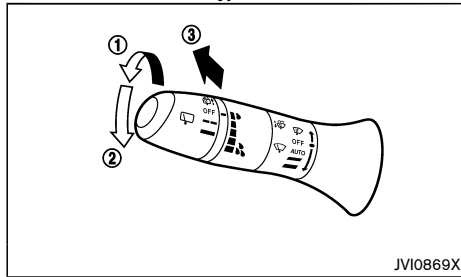

Type B

JVI0869X

The rear window wiper and washer operates when the ignition switch is in the "ON" position.

Wiper operation

The switch position ① operates the wiper intermittently.

The switch position ② operates the wiper at low speed.

**If the rear window wiper operation is interrupted by snow or ice, the wiper may stop moving to protect its motor. If this occurs, turn the wiper switch to the "OFF" position and remove the snow or ice on and around the wiper arms. In approximately 1 minute, turn the switch on again to operate the wiper.**

**Reverse synchronization function:**

When the windshield wiper switch is on, moving the shift lever to the "R" (Reverse) position will operate the rear window wiper.

To activate or deactivate this function, see "Settings" (P.2-21).

Washer operation

To operate the washer, push the lever toward the front of the vehicle ③ until the desired amount of washer fluid is spread on the windshield. The wiper will automatically operate several times.

**DEFOGGER SWITCH**

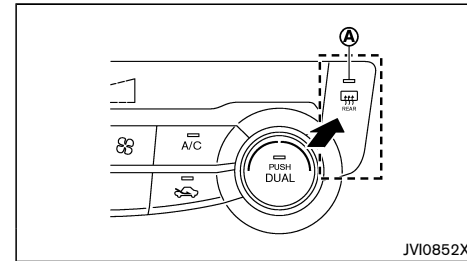

Type A (Example)

JVI0852X

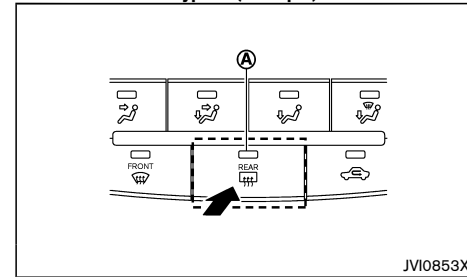

Type B

JVI0853X

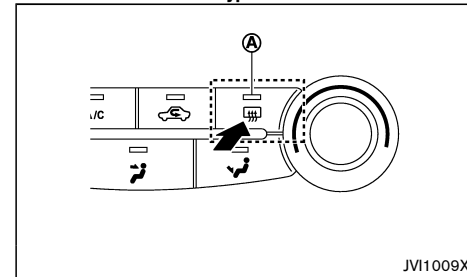

Type C

JVI1009X

The defogger switch operates when the ignition switch is in the "ON" position.

## HORN

The defogger is used to reduce the moisture, fog or frost on the rear window and outside door mirror (if equipped) surface to improve the rear view.

When the defogger switch is pushed, the indicator light **A** illuminates and the rear window defogger operates for approximately 15 minutes. After the preset time has passed, the defogger will turn off automatically.

To turn off manually, push the defogger switch again.



### CAUTION:

- **When operating the defogger continuously, be sure to start the engine. Otherwise, it may cause the battery to discharge.**
- **When cleaning the inner side of the window, be careful not to scratch or damage the electrical conductors on the surface of the window.**

### NOTE:

**When the rear defogger is turned on, the Stop/Start System or Idling Stop System (if equipped) will not be activated.**

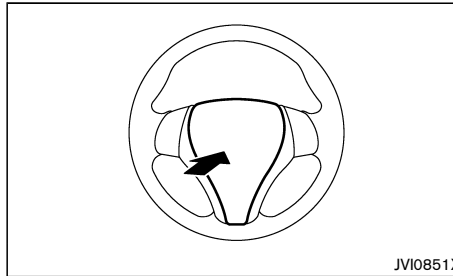

The horn switch operates regardless of the ignition switch position except when the battery is discharged.

When the horn switch is pushed and held, the horn will sound. Releasing the horn switch will cease the horn sound.

## WINDOWS

### POWER WINDOWS



### WARNING:

- **Make sure that all passengers have their hands, etc. inside the vehicle before operating the power windows.**
- **Never leave children or adults who would normally require the support of others alone in the vehicle. They could unknowingly activate switches or controls and inadvertently become involved in an accident.**

The power windows operate when the ignition switch is in the "ON" position.

To open a window, push down the power window switch.

To close a window, pull up the power window switch.

### Driver's window switch

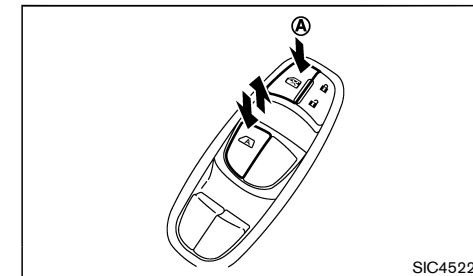

The driver's switch, the main switch, can control all windows.

**Locking passenger's windows:**

When the lock button **(A)** is pushed in, the passenger's windows cannot be operated.

To cancel the passenger's windows lock, push the lock button **(A)** again.

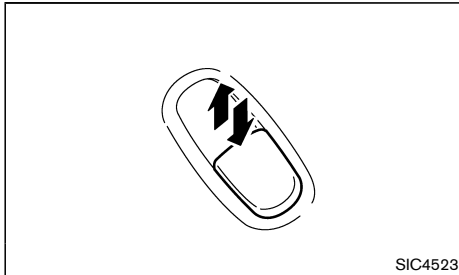
**Passenger's window switch (if equipped)**

SIC4523

The passenger's switch can control its corresponding window.

When the passenger's windows lock button on the driver's switch is pushed in, the passenger's switch cannot be operated.

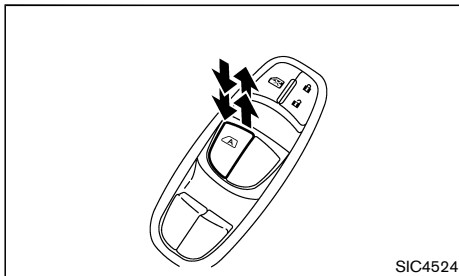
**Automatic function**

SIC4524

The automatic function is available for the switch that has an **(A)** mark on its surface.

The automatic function enables a window to fully open or close without holding the switch down or up.

To fully open the window, push the power window switch down to the second detent and release the switch. To fully close the window, pull the power window switch up to the second detent and release the switch. The switch does not have to be held during window operation.

To stop the window open/close operation during the automatic function, push down or pull up the switch in opposite directions.

**Auto-reverse function:****WARNING:**

**There is a small distance just before the closed position which cannot be detected. Make sure that all passengers have their hands, etc. inside the vehicle before closing the windows.**

The auto-reverse function enables a window to automatically reverse when something is caught in the window as it is closing by the automatic function. When the control unit detects an obstacle, the window will be lowered immediately.

Depending on the environment or driving conditions, the auto-reverse function may activate if an impact or load similar to something being caught in the window occurs.

**If the window does not close automatically**

If the power window automatic function (closing only) does not operate properly, perform the following procedure to initialize the power window system.

1. Place the ignition switch in the "ON" position.
2. Close the door.
3. Open the window completely by operating the power window switch.
4. Pull the power window switch and hold it to close the window, and then hold the switch more than 3 seconds after the window is closed completely.
5. Release the power window switch. Operate the window by the automatic function to confirm the initialization is complete.

If the power window automatic function does not operate properly after performing the procedure above, have your vehicle checked by a NISSAN dealer.

## SUNROOF (if equipped)

### WARNING:

- In an accident you could be thrown from the vehicle through an open sunroof. Adults should always use seat belts and children should always use seat belts or child restraint systems.
- Never allow anyone to stand up or extend any portion of their body out of the opening while the vehicle is in motion or while the sunroof is closing.

### CAUTION:

- Remove water drops, snow, ice or sand from the sunroof before opening.
- Do not place any heavy objects on the sunroof or surrounding area.
- Do not push or pull on the sunshade. Doing so can damage the sunshade.

### AUTOMATIC SUNROOF AND SUNSHADE

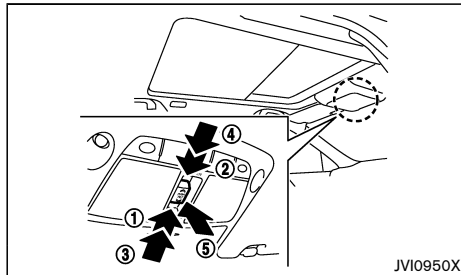

### Sliding sunshade and sunroof

When the sunroof switch is pushed to the OPEN position ①, the sunshade opens fully. When a switch is pushed again, the sunroof opens to the comfort mode position. When the switch is pushed again, the sunroof opens fully.

When the sunroof switch is pushed to the CLOSE position ②, the sunroof will automatically close. Push the switch again, and the sunshade will close.

When the sunroof switch is pushed to the OPEN position ③ to the second detent, the sunshade opens fully, and the sunroof opens to the comfort mode position. When the switch is pushed again, the sunroof opens fully. When the sunroof switch is pushed to the CLOSE position ④ to the second detent, both the sunshade and sunroof close.

To stop the sunshade or sunroof during the operation, push the sunroof switch to either of the OPEN ①, CLOSE ② or UP ⑤ position.

### Tilting sunroof

To tilt up the sunroof, push the sunroof switch to the up position ⑤.

To tilt down the sunroof, push the switch to the up position ⑤ or push the switch to the CLOSE position ②.

When the sunroof is tilted up, push the switch to the CLOSE position to the second detent ④. The sunroof will tilt down and the sunshade will close.

### Comfort mode

This is the position used when driving with the sunroof open. When driving with the sunroof fully open, wind noise may be very loud. Use the comfort mode position when driving.

### Auto-reverse function

### WARNING:

**There are some small distances just before the closed position which cannot be detected. Make sure that all passengers have their hands, etc. inside the vehicle before closing the sunroof and sunshade.**

The auto-reverse function enables the sunroof and sunshade to automatically reverse when something is caught in the sunroof and sunshade as it is closing. When the control unit detects an obstacle, the sunroof and sunshade will open immediately.

Depending on the environment or driving conditions, the auto-reverse function may activate if an impact or load similar to something being caught in the sunroof and sunshade occurs.

If the auto-reverse function activates consecutively or the battery is discharged, the sunroof and sunshade may not close properly. In this case, push and hold the switch to the CLOSE position ② to close the sunroof.



## POWER OUTLETS

### If sunroof does not operate

If the sunroof and sunshade do not operate properly, perform the following procedure to initialize the operation system.

1. If the sunroof and sunshade are open, close them fully by repeatedly pushing the sunroof switch to the CLOSE ② position.
2. Push and hold the sunroof switch to the CLOSE ② position for 10 seconds.
3. After the sunroof and sunshade move slightly to the closed position and then move back a little, release the sunroof switch.
4. Push and hold the sunroof switch to the CLOSE ② position for over 6 seconds.
5. Release the sunroof switch. The sunroof and sunshade will fully open and then fully close.
6. Check if the sunroof switch operates normally.

If the sunroof does not operate properly after performing the procedure above, have your vehicle checked by a NISSAN dealer.

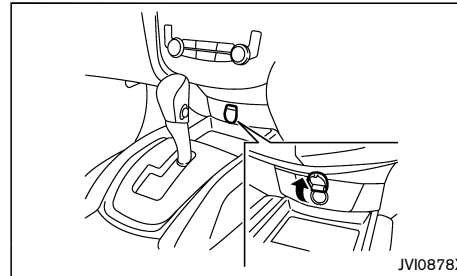

Instrument panel (if equipped)

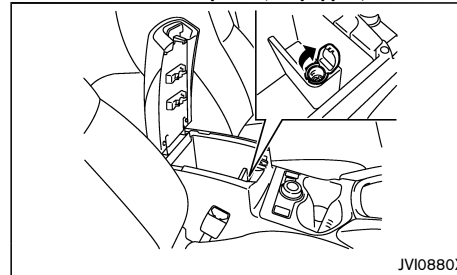

Console box

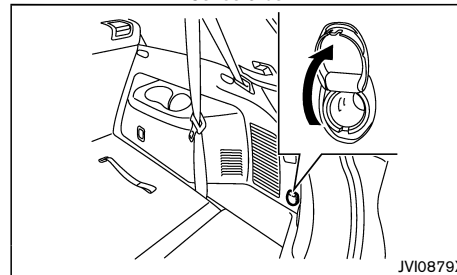

Cargo area

To use the power outlet, pull the cover as illustrated.

### ⚠ CAUTION:

- The outlet and plug may be hot during or immediately after use.
- This power outlet is not designed for use with a cigarette lighter unit.
- Do not use with accessories that exceed a 12 volt, 120W (10A) power draw. Do not use double adapters or more than one electrical accessory.
- Use this power outlet with the engine running to avoid discharging the vehicle battery.
- Avoid using when the air conditioner, headlights or rear window defogger is on.
- Push the plug in as far as it will go. If good contact is not made, the plug may overheat or the internal temperature fuse may blow.
- Before inserting or disconnecting a plug, be sure that the electrical accessory being used is turned OFF.
- When not in use, be sure to close the cap. Do not allow water or any liquid to contact the outlet.

## ASHTRAYS AND CIGARETTE LIGHTER (if equipped)

### ASHTRAY

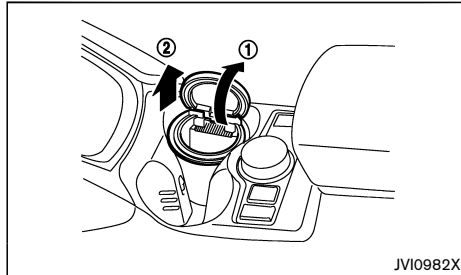

#### WARNING:

Do not use the ashtray in any other position than the front side of the front center cup holder.



#### CAUTION:

When using the cooling function, close the cup holder ventilator or take care to prevent the ash from being dropped in the cup holder due to the airflow coming from the drink holder ventilator.

To open the ashtray, pull up the lid ①.

To take out the ashtray, pull out ②.

### CIGARETTE LIGHTER

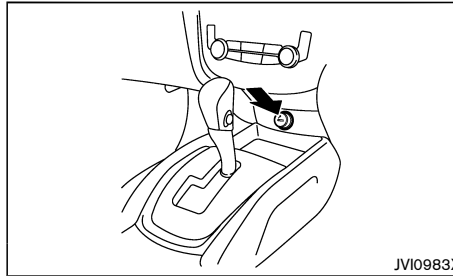

#### WARNING:

The cigarette lighter should not be used while driving so that full attention may be given to vehicle operation.

The cigarette lighter operates when the ignition switch is in the "ACC" or "ON" position.

To heat the cigarette lighter, push in until it latches. When the lighter is heated, it will spring out automatically.

Return the cigarette lighter to its original position after use.

## STORAGES



#### WARNING:

- The storages should not be used while driving so that the full attention may be given to vehicle operation.
- Keep the storage lids closed while driving to help prevent injury in an accident or sudden stop.

### GLOVE BOX

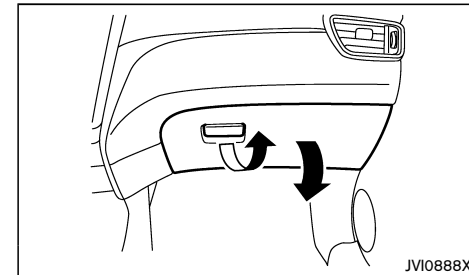

#### Type A

Open the glove box by pulling the handle.

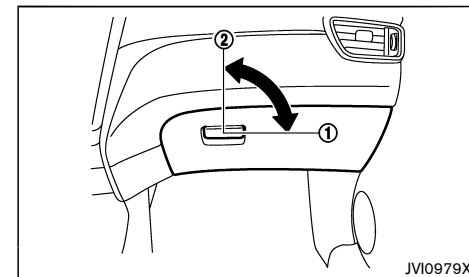

#### Type B

Open the glove box by pulling the handle. Use the

mechanical key when locking ① or unlocking ② the glove box.

### CONSOLE BOX

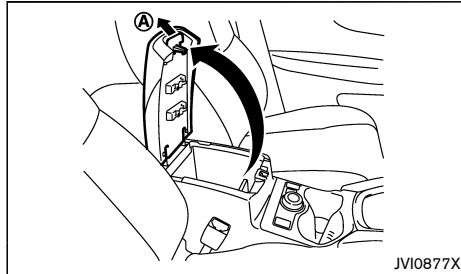

To open the console box lid, push up the knob **A** and pull up the lid.

To close, push the lid down until the lock latches.

### SUNGLASSES HOLDER

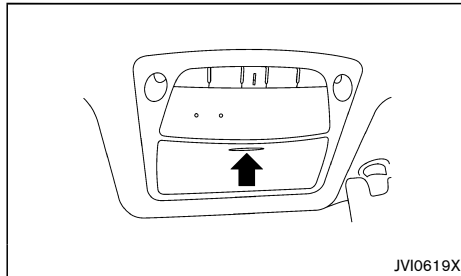

#### **WARNING:**

**Keep the sunglasses holder closed while driving to prevent an accident.**

#### **CAUTION:**

- Do not use for anything other than sunglasses.
- Do not leave sunglasses in the sunglasses holder while parking in direct sunlight. The heat may damage the sunglasses.

To open the sunglasses holder, push and release. Only store one pair of sunglasses in the holder.

### CUP HOLDERS

#### **WARNING:**

**The driver must not remove or insert cups into the cup holder while driving so that full attention may be given to vehicle operation.**

#### **CAUTION:**

**Avoid abrupt starting and braking especially when the cup holder is being used to prevent spilling the contents. If the contents are hot, they could scald you or your passengers.**

Front

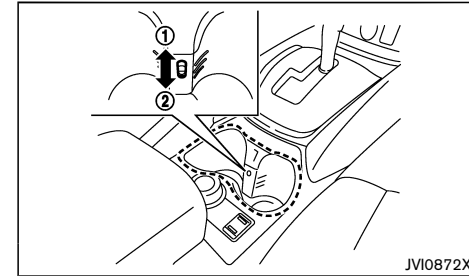

Front side

To keep a drink cold or warm,

1. Place the drink in the cup holder.
  2. Choose the “ ” or “ ” mode by operating the heater or air conditioner.
  3. Open the cup holder ventilator by pulling the knob up ① .
- The airflow coming from the drink holder ventilator is the same temperature as the air conditioner. The temperature cannot be set independently.
  - When the heater or the air conditioner is working in high temperature, the cooling function will not work even if the cup holder ventilator is opened.
- When the cooling or warming function is not necessary, close the cup holder ventilator by pushing the knob down ② .

### Second row seat

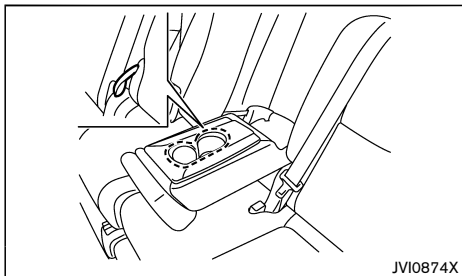

The second row seat cup holders are located in the rear fold-down armrest.

### SOFT BOTTLE HOLDERS

#### **CAUTION:**

- Do not use bottle holder for any other objects that could be thrown about in the vehicle and possibly injure people during sudden braking or an accident.
- Do not use bottle holder for open liquid containers.

### Front and second row seat

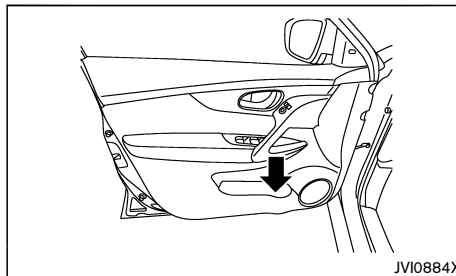

The front and second row seat soft bottle holders are located on the doors.

### Third row seat (if equipped)

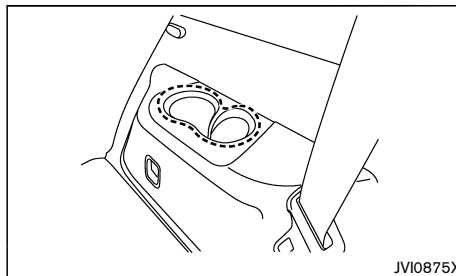

### CARD HOLDER

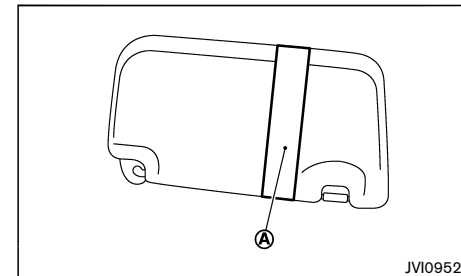

**Type A**

Slide a card in the card holder **A**.

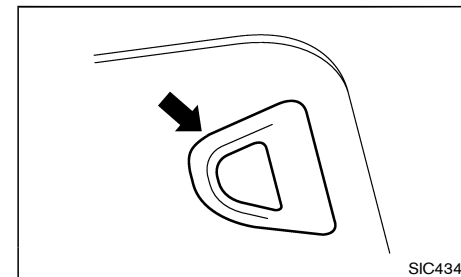

**Type B**

Slide the card in the card holder.

## LUGGAGE HOOKS

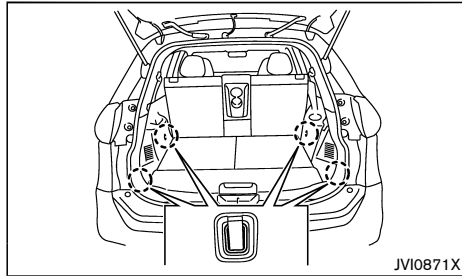

Luggage room



### WARNING:

- Always make sure that the luggage is properly secured. Use the suitable ropes and hooks.
- Unsecured luggage can become dangerous in an accident or sudden stop.
- Do not apply a total load of more than 10 kg (22 lb) to a single hook.

## LUGGAGE COMPARTMENT

You can use the luggage compartment in diverse ways using the flexible luggage board.



### WARNING:

**Do not put objects heavier than 75 kg (165 lbs) on the load floor while in the mid position. In the upper position, objects heavier than 20 kg (10 lbs) should not be placed on the load floor.**



### CAUTION:

- Do not push the front edge of the luggage board forcibly. Doing so may cause the luggage board to be tilted, resulting in personal injury.
- Do not handle the luggage board forcibly as this may deform it.
- While in the upper position, do not recline the seatbacks.
- Do not place cargo higher than the seatbacks. In a sudden stop or collision, unsecured cargo could cause personal injury.

### NOTE:

The diversity of the luggage compartment may be restricted depending on the equipment of each vehicle.

### Three-stage mode

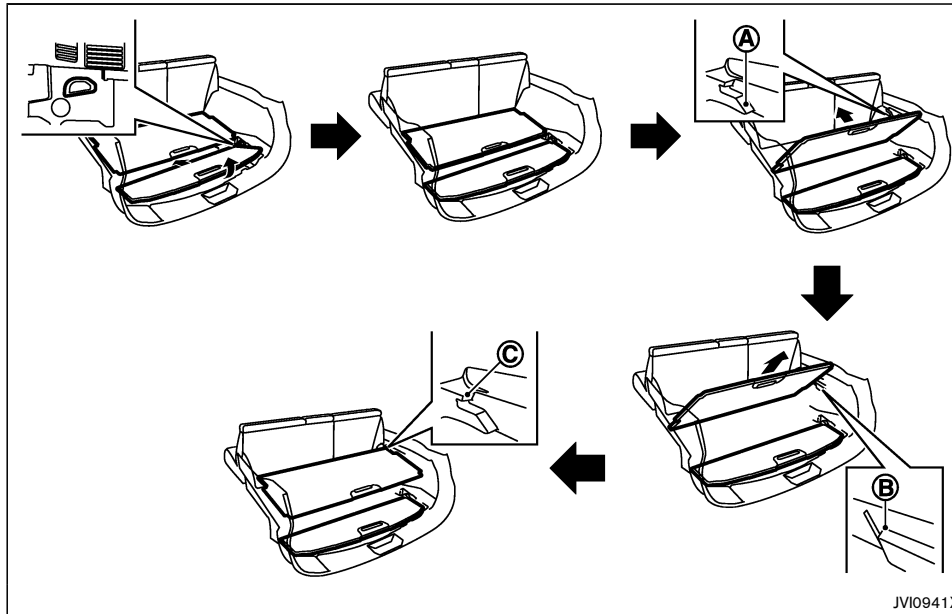

1. Pull the outer board upward to about 30°.
2. Pull the outer board toward the rear of the vehicle and then push it into the bottom of the luggage under space.
3. Pull the inner board upward until it stops at position **(A)**.
4. Pull off the inner board toward the rear of the vehicle from **(B)**.
5. Push the inner board into **(C)**.

### Vertical mode

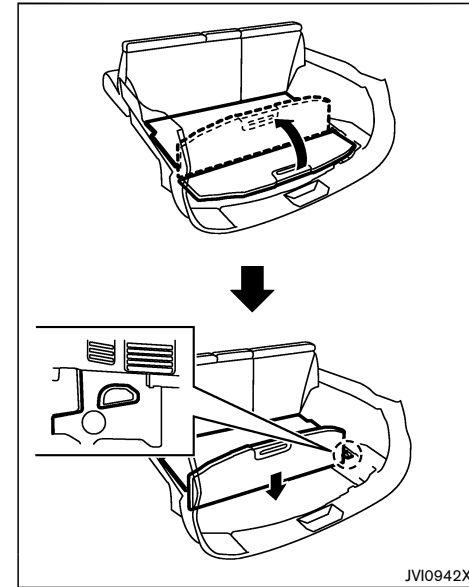

1. Pull the outer board upward to 90°.
2. Push down the board until it stops.

## 2-58 Instruments and controls

## Separation mode

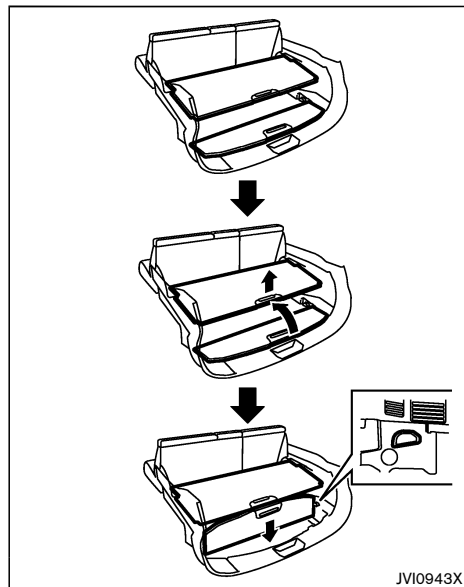

1. Place the inner board on the upper position. (See "Three-stage mode" (P.2-58).)
2. Pull the inner board upward about 10 cm (4 in) and pull up the outer board to 90°.
3. Push down the board until it stops.

## Luggage under space (if equipped)

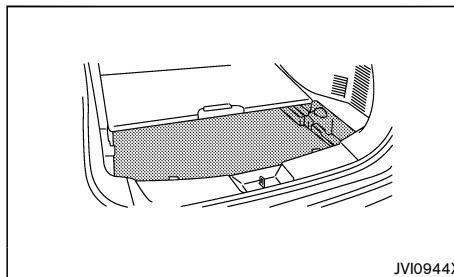
**Two row model**

To use the luggage under space, pull off the outer board.

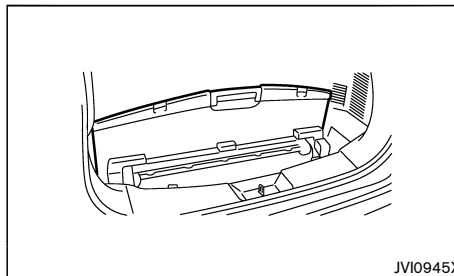
**Three row model**

To use the luggage under space, pull off the board.

## COAT HOOK

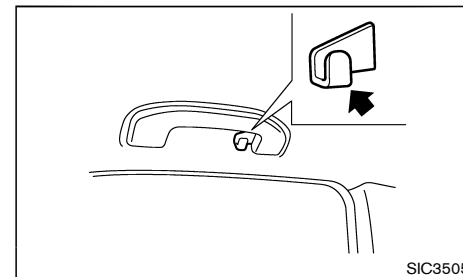

The coat hook is located above the rear side window (on the driver's side).

**CAUTION:**

**Do not apply a total load of more than 1 kg (2 lb) to the hook.**

### TONNEAU COVER (if equipped)

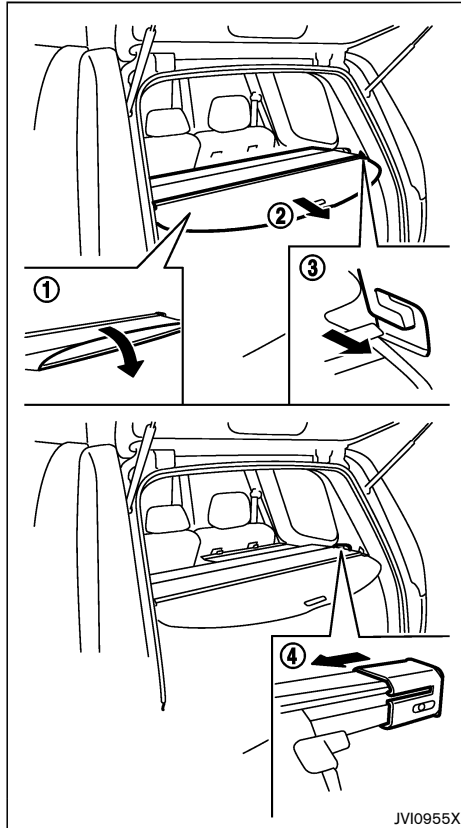

The tonneau cover keeps the luggage compartment

contents hidden from the outside.

To use the tonneau cover, open the flap ①, pull it out ② and insert both sides to the guide ③.

To remove the tonneau cover, stow the cover and pull the holder ④.

#### **⚠ WARNING:**

- **Never put anything on the tonneau cover, no matter how small. Any object on it could cause an injury in an accident or sudden stop.**
- **Do not leave the tonneau cover in the vehicle with it disengaged from the holder.**
- **The child restraint top tether strap may be damaged by contact with the tonneau cover or items in the luggage area. Remove the tonneau cover from the vehicle or secure it in the luggage area. Also secure any items in the luggage area. Your child could be seriously injured or killed in a collision if the top tether strap is damaged.**

### ROOF RAIL (if equipped)

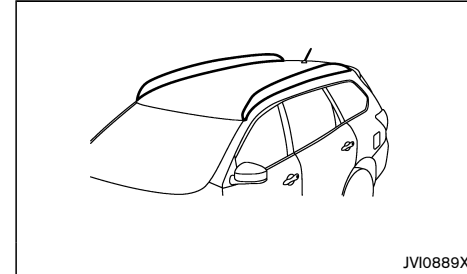

Luggage can be carried on the roof by securing crossbars to the roof rail. Follow all crossbar manufacturers instructions for installing and use of the crossbars. The roof rail is designed to carry loads (luggage plus crossbars) below 100 kg (221 lb). Overloading may cause damage to the vehicle.

#### **⚠ CAUTION:**

- **Do not put or hang anything on or around side pipes or plastic covers.**
- **For crossbar installation on a roof rail with driving lights, contact a NISSAN dealer.**

### 2-60 Instruments and controls



## SUN VISORS

TYPE A

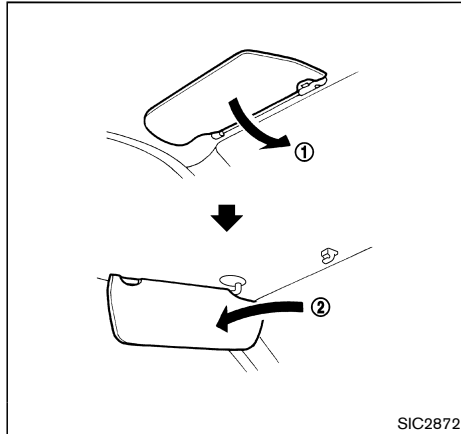

1. To block out glare from the front, swing down the sun visor ①.
2. To block glare from the side, remove the sun visor from the center mount and swing it to the side ②.

TYPE B

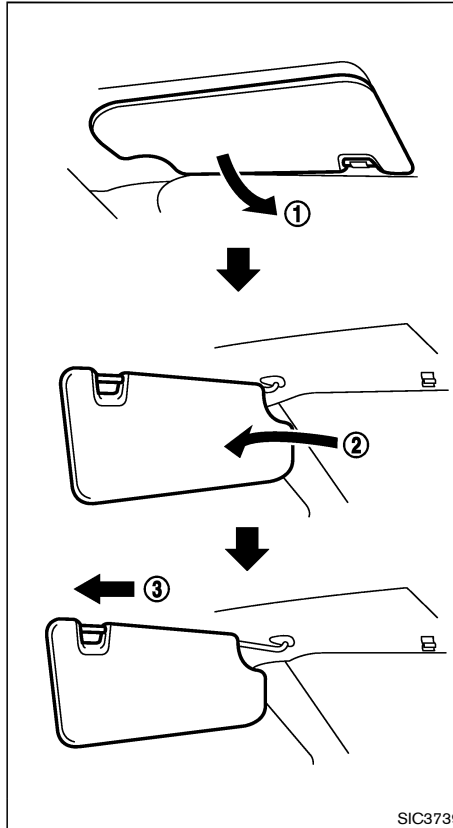

1. To block glare from the front, swing down the main sun visor ①.
2. To block glare from the side, remove the main sun visor from the center mount and swing it to the side ②.
3. Slide the sun visor ③ in or out as needed.

## INTERIOR LIGHTS

### CAUTION:

- Do not leave the light switch on when the engine is not running for extended periods of time to prevent the battery from being discharged.
- Turn off the lights when you leave the vehicle.

### INTERIOR LIGHT SWITCH

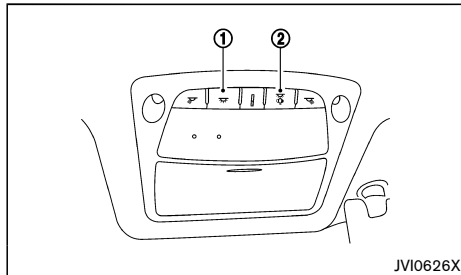

- The interior light can be turned ON regardless of door position. The light will go off after a period of time unless the ignition switch is placed in the "ON" position when any door is opened.
- The interior lights can be set to operate when the doors are opened. To turn off the interior lights when a door open, push the switch, the interior lights will not illuminate, regardless of door position. The lights will go off when the ignition switch is placed in the "ON" position, or the driver's door is closed and locked. The lights will also go off after a period of time when the doors are open.

### CONSOLE LIGHT

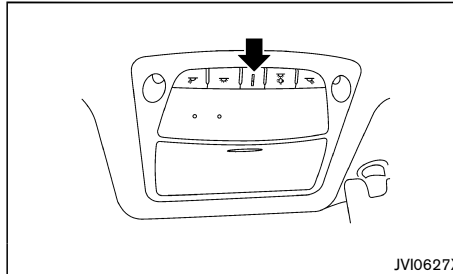

The console light will turn on whenever the clearance lights or headlights are illuminated.

### MAP LIGHTS

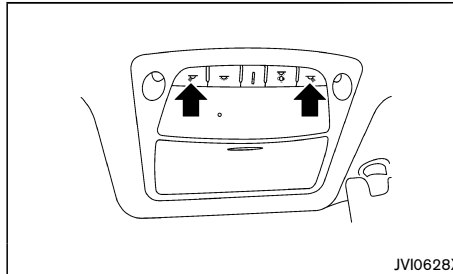

Push the button to turn the map lights on. To turn them off, push the button again.

### ROOM LIGHT (if equipped)

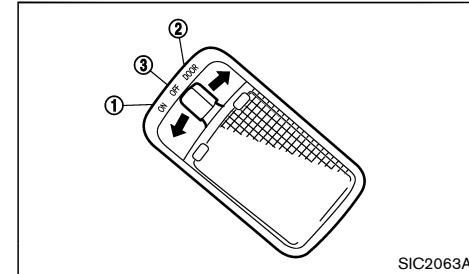

The room light has a three-position switch.

When the switch is in the "ON" position ①, the room light illuminates.

When the switch is in the "DOOR" position ②, the room light illuminates when a door is opened.

The interior light timer will keep the room light on for approximately 15 seconds when:

- The key is removed from the ignition switch with the driver's door closed. (model without Intelligent Key system)
- The ignition switch is placed in the "OFF" position. (model with Intelligent Key system)
- The doors are unlocked by pushing the "UN-LOCK" button (on the remote controller or Intelligent Key) or the request switch (Intelligent Key system equipped models), with the ignition switch in the "LOCK" position.
- Any door is opened and then closed with the ignition switch in the "LOCK" position.

The interior light timer will be cancelled when:

- The driver's door is locked.

- The ignition switch is placed in the "ON" position. When the switch is in the "OFF" position (3), the room light does not illuminate, regardless of any condition.

#### REAR PERSONAL LIGHTS (if equipped)

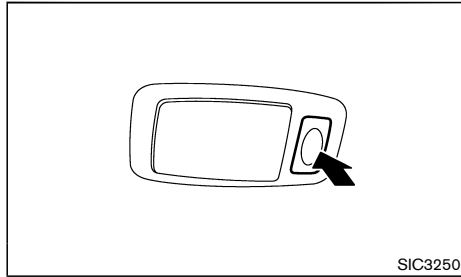

To turn the rear personal lights on, push the switch. To turn them off, push the switch again.

#### VANITY MIRROR LIGHT

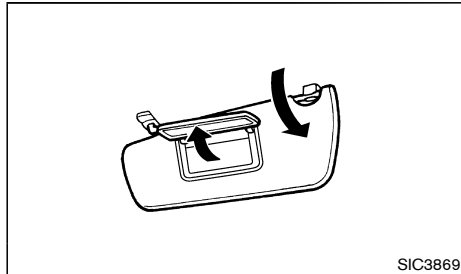

To access the vanity mirror, pull the sun visor down and flip open the mirror cover.

The vanity mirror light illuminates when the vanity mirror cover is opened. When the cover is closed, the light

will turn off.

#### LUGGAGE ROOM LIGHT

The luggage room light illuminates when the back door is opened. When the back door is closed, the light will turn off.

#### BATTERY SAVER SYSTEM

**When the interior light stays on, it will automatically turn off after a period of time when the ignition switch has been placed in the "OFF" position. To turn on the light again, place the ignition switch in the "ON" position.**

The interior light will automatically turn off within a period of time after the latest operation of the following with the ignition switch in the "OFF" position:

- Opening or closing any door
- Locking or unlocking with a key, the power door lock switch, or using the Intelligent Key system
- Pushing the ignition switch

The light will turn on again when any of the above operations is performed after the light has turned off automatically.

### HomeLink® UNIVERSAL TRANSCEIVER (if equipped)

The HomeLink® Universal Transceiver provides a convenient way to consolidate the functions of up to three individual hand-held transmitters into one built-in device.

HomeLink® Universal Transceiver:

- Will operate most Radio Frequency (RF) devices such as garage doors, gates, home and office lighting, entry door locks and security systems.
- Is powered by your vehicle's battery. No separate batteries are required. If the vehicle's battery is discharged or is disconnected, HomeLink® will retain all programming.

**When the HomeLink® Universal Transceiver is programmed, retain the original transmitter for future programming procedures (Example: new vehicle purchases). Upon sale of the vehicle, the programmed HomeLink® Universal Transceiver buttons should be erased for security purposes. For additional information, refer to "Programming HomeLink®" (P.2-64).**



#### WARNING:

- **During the programming procedure your garage door or security gate will open and close (if the transmitter is within range). Make sure that people or objects are clear of the garage door, gate, etc. that you are programming.**
- **Your vehicle's engine should be turned off while programming the HomeLink® Universal Transceiver. Do not breathe exhaust gases; they contain colorless and odorless carbon monoxide. Carbon monoxide is dangerous. It can cause unconsciousness or death.**

## PROGRAMMING HomeLink®

If you have any questions or are having difficulty programming your HomeLink® buttons, refer to the HomeLink® web site at: [www.homelink.com](http://www.homelink.com).

### NOTE:

**It is also recommended that a new battery be placed in the hand-held transmitter of the device being programmed to HomeLink® for quicker programming and accurate transmission of the radio-frequency.**

1. Position the end of your hand-held transmitter 26 - 76 mm (1 - 3 in) away from the HomeLink® surface, keeping the HomeLink® indicator light ① in view.

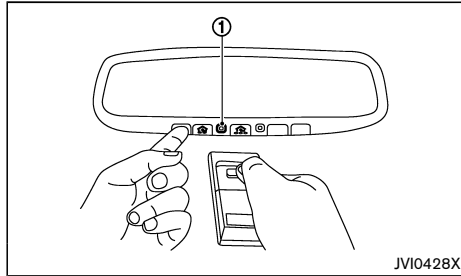

2. Using both hands, simultaneously press and hold the desired HomeLink® button and handheld transmitter button. DO NOT release until the HomeLink® indicator light ① flashes slowly and then rapidly. When the indicator light flashes rapidly, both buttons may be released. (The rapid flashing indicates successful programming.)

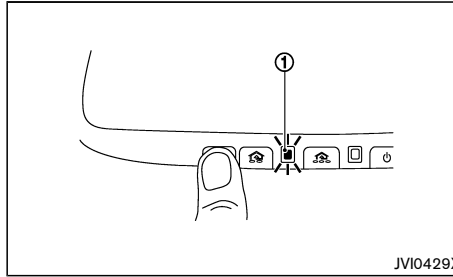

3. Press and hold the programmed HomeLink® button and observe the indicator light.
  - If the indicator light ① is solid/continuous, programming is complete and your device should activate when the HomeLink® button is pressed and released.
  - If the indicator light ① blinks rapidly for two seconds and then turns to a solid/continuous light, continue with Steps 4-6 for a rolling code device. A second person may make the following steps easier. Use a ladder or other device. Do not stand on your vehicle to perform the next steps.
4. At the receiver located on the garage door opener motor in the garage, locate the “learn” or “smart” button (the name and color of the button may vary by manufacturer but it is usually located near where the hanging antenna wire is attached to the unit). If there is difficulty locating the button, reference the garage door opener’s manual.
5. Press and release the “learn” or “smart” button.

### NOTE:

**Once the button is pressed, you have approximately 30 seconds to initiate the next step.**

6. Return to the vehicle and firmly press and hold the programmed HomeLink® button for two seconds and release. Repeat the “press/hold/release” sequence up to 3 times to complete the programming process. HomeLink® should now activate your rolling code equipped device.
7. If you have any questions or are having difficulty programming your HomeLink® buttons, refer to the HomeLink® web site at: [www.homelink.com](http://www.homelink.com).

## OPERATING THE HomeLink® UNIVERSAL TRANSCEIVER

The HomeLink® Universal Transceiver, after it is programmed, can be used to activate the programmed device. To operate, simply press and release the appropriate programmed HomeLink® Universal Transceiver button. The amber indicator light will illuminate while the signal is being transmitted.

For convenience, the hand-held transmitter of the device may also be used at any time.

## PROGRAMMING TROUBLESHOOTING

If the HomeLink® does not quickly learn the hand-held transmitter information:

- replace the hand-held transmitter batteries with new batteries.
- position the hand-held transmitter with its battery area facing away from the HomeLink® surface.
- press and hold both the HomeLink® and hand-held transmitter buttons without interruption.
- position the hand-held transmitter 26 to 76 mm (1 to 3 in) away from the HomeLink® surface. Hold

the transmitter in that position for up to 15 seconds. If HomeLink® is not programmed within that time, try holding the transmitter in another position - keeping the indicator light in view at all times.

If you have any questions or are having difficulty programming your HomeLink® buttons, refer to the HomeLink® web site at: [www.homelink.com](http://www.homelink.com).

### CLEARING THE PROGRAMMED INFORMATION

The following procedure clears the programmed information from both buttons. Individual buttons cannot be cleared. However, individual buttons can be reprogrammed, see "Reprogramming a single HomeLink® button" (P.2-65).

To clear all programming

1. Press and hold the two outer HomeLink® buttons until the indicator light begins to flash in approximately 10 seconds. Do not hold for longer than 20 seconds.
2. Release both buttons.

HomeLink® is now in the programming mode and can be programmed at any time beginning with "Programming HomeLink®" - Step 1.

### REPROGRAMMING A SINGLE HomeLink® BUTTON

To reprogram a HomeLink® Universal Transceiver button, complete the following.

1. Press and hold the desired HomeLink® button. **Do not** release the button.
2. The indicator light will begin to flash after 20 seconds. Without releasing the HomeLink® button, proceed with "Programming HomeLink®" - Step 1.

For questions or comments, contact HomeLink® at: [www.homelink.com](http://www.homelink.com).

The HomeLink® Universal Transceiver button has now been reprogrammed. The new device can be activated by pushing the HomeLink® button that was just programmed. This procedure will not affect any other programmed HomeLink® buttons.

### IF YOUR VEHICLE IS STOLEN

If your vehicle is stolen, you should change the codes of any non-rolling code device that has been programmed into HomeLink®. Consult the Owner's Manual of each device or call the manufacturer or dealer of those devices for additional information.

**When your vehicle is recovered, you will need to reprogram the HomeLink® Universal Transceiver with your new transmitter information.**

**MEMO**

**2-66 Instruments and controls**

Condition: 'Except for China'

[ Edit: 2014/ 11/ 7 Model: T32-A ]

## 3 Pre-driving checks and adjustments

Keys .....	3-2	Security system .....	3-20
NISSAN Anti-Theft System (NATS) key (if equipped) .....	3-2	Theft warning system (if equipped) .....	3-20
Intelligent Key (if equipped) .....	3-2	NISSAN Anti-Theft System (NATS) .....	3-21
Door locks .....	3-4	Hood .....	3-22
Super lock system (if equipped) .....	3-4	Opening hood .....	3-23
Locking with key .....	3-4	Closing hood .....	3-23
Locking with inside lock knob .....	3-5	Back door .....	3-23
Locking with power door lock switch .....	3-6	Operating manual back door .....	3-23
Vehicle speed sensing door lock mechanism (if equipped) ....	3-6	Operating power back door (if equipped) .....	3-24
Auto door lock releasing mechanism (if equipped) .....	3-7	Auto closure (if equipped) .....	3-26
Impact sensing door lock releasing mechanism (if equipped) .....	3-7	Back door release lever .....	3-26
Child safety rear door lock .....	3-7	Garage mode system .....	3-27
Remote keyless entry system (if equipped) .....	3-7	Fuel filler lid .....	3-27
Using remote keyless entry system .....	3-8	Opening fuel filler lid .....	3-27
Hazard indicator operation .....	3-9	Fuel filler cap .....	3-27
Intelligent Key system (if equipped) .....	3-10	Steering wheel .....	3-28
Operating range .....	3-13	Mirrors .....	3-28
Using Intelligent Key system .....	3-13	Inside rearview mirror .....	3-28
Warning signals .....	3-15	Outside rearview mirrors .....	3-29
Troubleshooting guide .....	3-16	Vanity mirror .....	3-29
Using remote keyless entry function .....	3-17	Parking brake .....	3-30
Hazard indicator and horn operation .....	3-18	Pedal type .....	3-30
		Switch type (models with electronic parking brake system) .....	3-30



## KEYS

Your vehicle can only be driven with the keys specific to your vehicle. A key number plate is supplied with your key. Record the key number and keep the key number plate in a safe place, except in the vehicle, in case of the need to duplicate the keys.

The key can only be duplicated using an original key or the original key number. The key number is required when you have lost all of the keys and do not have the original key to duplicate from. If the key is lost, or you need extra keys, provide an original key or the key number to a NISSAN dealer.



### CAUTION:

**Do not leave the keys inside the vehicle when leaving the vehicle.**

### NISSAN ANTI-THEFT SYSTEM (NATS\*) KEY (if equipped)

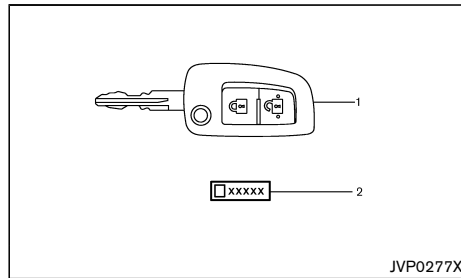

Type A

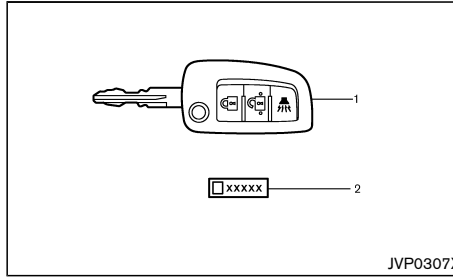

Type B

1. NATS key (2)
2. Key number plate (1)

Your vehicle can only be driven with the NATS keys, which are registered to your vehicle's NATS components. As many as 4 NATS keys can be registered and used with one vehicle. The new keys must be registered by a NISSAN dealer prior to use with the NATS of your vehicle. Since the registration process requires erasing all memory in the NATS components when registering new keys, be sure to take all NATS keys that you have to the NISSAN dealer.

\*: Immobilizer



### CAUTION:

**Do not allow the NATS key, which contains an electrical transponder, to come into contact with water or salt water. This could affect the system function.**

### Mechanical key

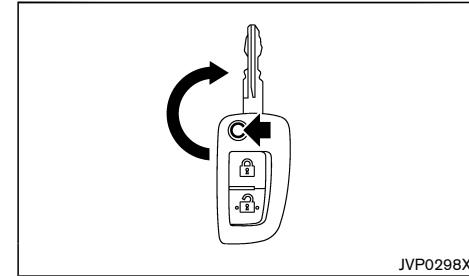

To unfold the key from the fob, press the release button.

When storing the key press the release button and push key to fold the key back into fob slot.

### INTELLIGENT KEY (if equipped)

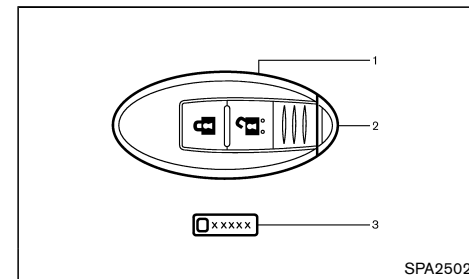

Type A

## 3-2 Pre-driving checks and adjustments



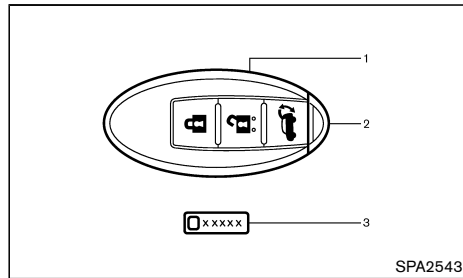

Type B (example)

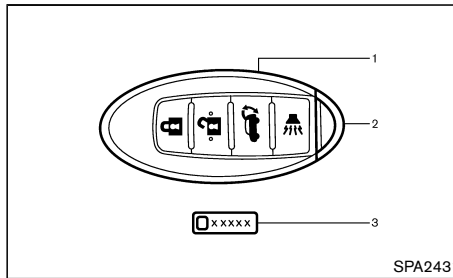

Type D

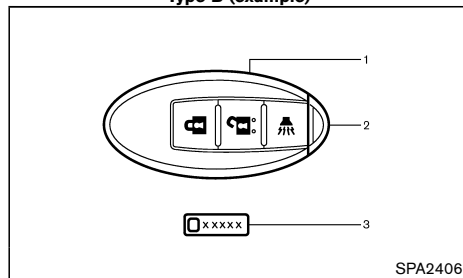

Type C

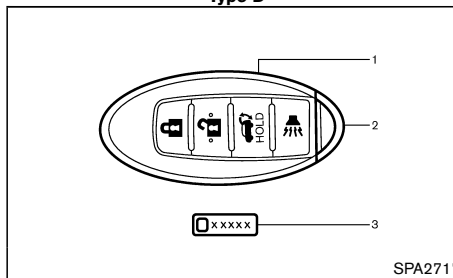

Type E

1. Intelligent Key (2)
2. Mechanical key (in the Intelligent Key) (2)
3. Key number plate (1)

Your vehicle can only be driven with the Intelligent Keys, which are registered to your vehicle's Intelligent Key system components and NISSAN Anti-Theft System (NATS\*) components. As many as 4 Intelligent Keys can be registered and used with one vehicle. The new keys must be registered by a NISSAN dealer prior to use with the Intelligent Key system and NATS of your vehicle. Since the registration process requires erasing all memory in the Intelligent Key components when registering new keys, be sure to take all Intelligent Keys

that you have to the NISSAN dealer.

\*: Immobilizer



#### CAUTION:

- **Be sure to carry the Intelligent Key with you. Do not leave the vehicle with the Intelligent Key inside.**
- **Be sure to carry the Intelligent Key with you when driving. The Intelligent Key is a precision device with a built-in transmitter. To avoid damaging it, please note the following.**
  - **The Intelligent Key is water resistant; however, wetting may damage the Intelligent Key. If the Intelligent Key gets wet, immediately wipe until it is completely dry.**
  - **Do not bend, drop or strike it against another object.**
  - **If the outside temperature is below -10°C (14°F) degrees, the battery of the Intelligent Key may not function properly.**
  - **Do not place the Intelligent Key for an extended period in a place where temperatures exceed 60°C (140°F).**
  - **Do not change or modify the Intelligent Key.**
  - **Do not use a magnet key holder.**
  - **Do not place the Intelligent Key near equipment that produces a magnetic field such as a TV, audio equipment, personal computers and cellular telephone.**

Pre-driving checks and adjustments 3-3

— **Do not allow the Intelligent Key to come into contact with water or salt water, and do not wash it in a washing machine. This could affect the system function.**

- **If an Intelligent Key is lost or stolen, NISSAN recommends erasing the ID code of that Intelligent Key. This will prevent the Intelligent Key from unauthorized use to unlock the vehicle. For information regarding the erasing procedure, please contact a NISSAN dealer.**

#### Mechanical key

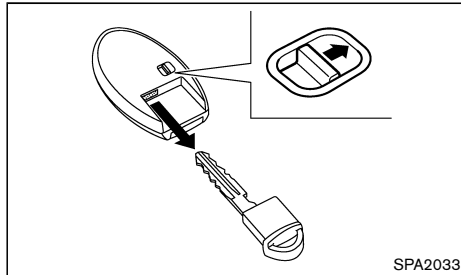

To remove the mechanical key, release the lock knob at the back of the Intelligent Key.

To install the mechanical key, firmly insert it into the Intelligent Key until the lock knob returns to the lock position.

Use the mechanical key to lock or unlock the doors and glove box (if equipped). (See "Door locks" (P.3-4) and "Storages" (P.2-54).)

### 3-4 Pre-driving checks and adjustments

## DOOR LOCKS

### WARNING:

- **Always look before opening any doors, to avoid an accident with oncoming traffic.**
- **Never leave children or adults who would normally require the support of others alone in the vehicle. They could unknowingly activate switches or controls and inadvertently become involved in a serious accident.**

### SUPER LOCK SYSTEM (if equipped)

### WARNING:

**For Super Lock System equipped models, failure to follow the precautions below may lead to hazardous situations. Make sure the Super Lock System activation is always safely conducted.**

- **When the vehicle is occupied, never lock the doors with the remote controller or the Intelligent Key (if equipped). Doing so will trap the occupants, since the Super Lock System prevents the doors from being opened from the inside of the vehicle.**
- **Only operate the remote controller or the Intelligent Key (if equipped) lock button when there is a clear view of the vehicle. This is to prevent anybody from being trapped inside the vehicle through the Super Lock System activation.**

Locking the doors with the remote controller, the Intelligent Key (if equipped) or the key will lock all doors including the back door and activate the Super Lock System.

This means that none of the doors can be opened from the inside in order to prevent theft.

The system will be released when the door is unlocked with the remote controller, Intelligent Key (if equipped) or key.

The Super Lock System will not activate when the doors are locked with the power door lock switch.

### Emergency situations

If the Super Lock System is activated due to a traffic accident or other unexpected circumstances while you are in the vehicle:

- Place the ignition switch in the "ON" position, the Super Lock System will be released and all the doors can be unlocked with the power door lock switch. You can then open the doors.
- Remove the key from the ignition switch and unlock the door using the remote controller or the Intelligent Key (if equipped). The Super Lock System will be released and you can open the door.

### LOCKING WITH KEY

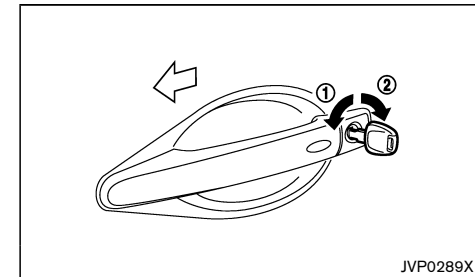

## Model without Super Lock System

### Type A:

To lock the door, insert the key to the door key cylinder and turn the key to the front side of the vehicle ①.

All doors including the back door will lock.

To unlock the door insert the key to the door key cylinder and turn the key to the rear side of the vehicle ②.

All doors including the back door will unlock. In the selective door unlock mode, only the driver's side door will unlock.

### Type B:

To lock the door, insert the key to the door key cylinder and turn the key to the front side of the vehicle ①.

The driver's side door will lock.

To unlock the door turn the key to the rear side of the vehicle ②.

The driver's side door will unlock.

### Type C:

To lock the door, insert the key to the door key cylinder and turn the key to the rear side of the vehicle ②.

The driver's side door will lock.

To unlock the door turn the key to the front side of the vehicle ①.

The driver's side door will unlock.

### Type D:

To lock the door, insert the key to the door key cylinder and turn the key to the rear side of the vehicle ②.

All doors including the back door will lock.

To unlock the door insert the key to the door key cylinder and turn the key to the front side of the vehicle ①.

All doors including the back door will unlock. In the selective door unlock mode, only the driver's side door will unlock.

## Model with Super Lock System

To lock the door, insert the key to the door key cylinder and turn the key to the front side of the vehicle ①.

All doors including the back door will lock and the Super Lock System will activate.

To unlock the door insert the key to the door key cylinder and turn the key to the rear side of the vehicle ②.

All doors including the back door will unlock and the Super Lock System will deactivate.

In the selective door unlock mode, only the driver's side door will unlock and Super Lock System will deactivate for all doors.

When the key is in the ignition switch or the ignition switch is pushed in (Intelligent key equipped model), turning the key cannot lock the doors.

## LOCKING WITH INSIDE LOCK KNOB



### CAUTION:

**When locking the doors using the inside lock knob, be sure not to leave the key in the vehicle.**

## Type A (for models without Super Lock System)

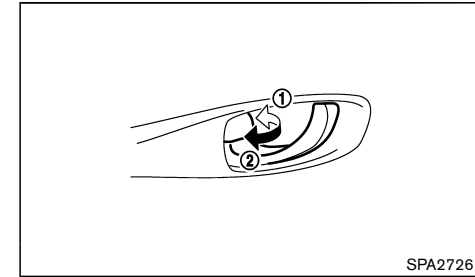

To lock the front doors, push the inside lock knob to the lock position ①, and then close the door while pulling the door handle.

To lock the rear doors, push the inside lock knob to the lock position ① and then close the door.

Operating the driver's side lock knob will lock or unlock all the doors (if equipped).

To unlock, pull the inside lock knob to the unlock position ②.

When the driver's door is locked, you do not need to operate the inside lock knob. Just pull the inside door handle to open the driver's door.

### Type B (for models with Super Lock System)

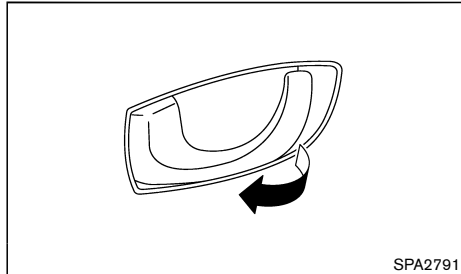

To unlock and open the door, pull the inside door handle as illustrated.

The doors cannot be opened by using the inside door handle when the Super Lock System is activated.

### LOCKING WITH POWER DOOR LOCK SWITCH

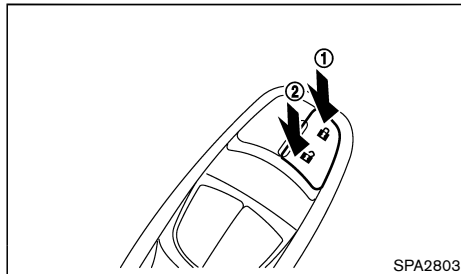

Driver's armrest

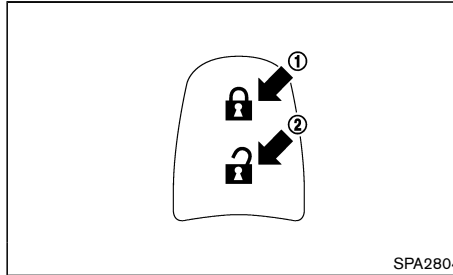

Passenger's armrest (if equipped)

Operating the power door lock switch (located on the driver's and front passenger's doors - if equipped) will lock or unlock all the doors.

To lock the doors, push the power door lock switch to the lock position ①.

To lock the doors, push the power door lock switch to the lock position ① with the driver's door open, then close the door while pulling the door handle. All doors will lock (except for South Africa and Europe).

#### **CAUTION:**

- **When locking the doors using the power door lock switch, be sure not to leave the key in the vehicle.**
- **When the Intelligent Key is left in the vehicle, and you try to lock the door using the power door lock switch after getting out of the vehicle, all the doors will unlock automatically after the door is closed.**

To unlock, push the power door lock switch to the unlock position ②.

With the ignition switch in the "ON" position, the door lock indicator light  (located on the instrument

panel) (if equipped) will illuminate and stay on. With the ignition switch in the "OFF" or "LOCK" position, the door lock indicator light  will illuminate for 30 minutes.

### VEHICLE SPEED SENSING DOOR LOCK MECHANISM (if equipped)

All doors will be locked automatically when the vehicle speed reaches 10 km/h (6 MPH). Once the lock has been unlocked, while driving, the vehicle speed sensing door lock mechanism will not lock the door again unless one of the following is performed.

- Opening any doors.
- Placing the ignition switch in the "LOCK" position.

#### To activate vehicle speed sensing door lock mechanism

1. Place the ignition switch in the "ON" position.
2. Within 20 seconds, push and hold the power door lock switch to the "LOCK" position for 5 seconds.
3. A buzzer will sound if activation was successful.

To deactivate:

1. Place the ignition switch in the "ON" position.
2. Within 20 seconds, push and hold the power door lock switch to the "UNLOCK" position for 5 seconds.
3. A buzzer will sound if deactivation was successful.

## 3-6 Pre-driving checks and adjustments

### AUTO DOOR LOCK RELEASING MECHANISM (if equipped)

All doors will be unlocked automatically when the following conditions:

- When the ignition switch is moved from "ON" to "OFF" position (Model with Intelligent Key system).
- When the key is removed from the ignition switch (Model without Intelligent Key system).

#### To activate or deactivate auto door lock releasing mechanism

To activate or deactivate the auto door lock releasing mechanism, perform the following procedures.

1. Place the ignition switch in the "ON" position.
2. Within 20 seconds, push and hold the power door lock switch to the "UNLOCK" position for 5 seconds.
3. The hazard indicator light will flash as follows if the switching operation is successful:
  - Twice - activated
  - Once - deactivated

### IMPACT SENSING DOOR LOCK RELEASING MECHANISM (if equipped)

All doors will be unlocked automatically when the impact sensors sense an impact while the ignition switch is in the "ON" position.

### CHILD SAFETY REAR DOOR LOCK

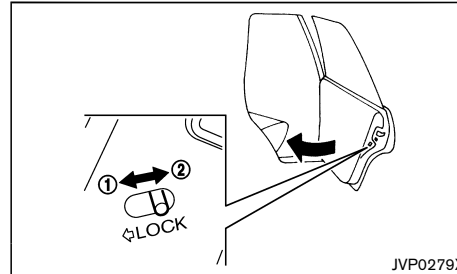

The child safety rear door locks help prevent rear doors from being opened accidentally, especially when small children are in the vehicle.

When the levers are in the lock position ①, the child safety rear door locks engage and the rear doors can only be opened by the outside door handles.

To disengage, move the levers to the unlock position ②.

### REMOTE KEYLESS ENTRY SYSTEM (if equipped)

The remote keyless entry system can operate all door locks (including the back door) using the remote controller. The remote controller can operate at a distance of approximately 1 m (3.3 ft) away from the vehicle. The operating distance depends upon the conditions around the vehicle.

As many as 4 remote controllers can be used with one vehicle. For information about the purchase and use of additional remote controllers, contact a NISSAN dealer.

The remote controller will not function under the following conditions:

- When the distance between the remote controller and vehicle is more than approximately 1 m (3.3 ft).
- When the remote controller battery is discharged.
- When the key is in the ignition switch.



#### CAUTION:

- **When locking the doors using the remote controller, be sure not to leave the key in the vehicle.**
- **Do not allow the remote controller, which contains electrical components, to come into contact with water or salt water. This could affect the system function.**
- **Do not drop the remote controller.**
- **Do not strike the remote controller sharply against another object.**
- **Do not place the remote controller for an extended period in an area where temperatures exceed 60°C (140°F).**

If a remote controller is lost or stolen, NISSAN recommends erasing the ID code of that remote

**Pre-driving checks and adjustments 3-7**

controller from the vehicle. This may prevent the unauthorized use of the remote controller to unlock the vehicle. For information regarding the erasing procedure, contact a NISSAN dealer.

For information regarding the replacement of a battery, see "Battery" (P.8-20).

### USING REMOTE KEYLESS ENTRY SYSTEM

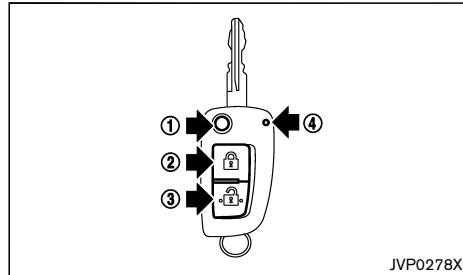

#### Type A (without panic alarm)

- ① Jackknife type key release button
- ② LOCK button
- ③ UNLOCK button
- ④ Battery indicator light

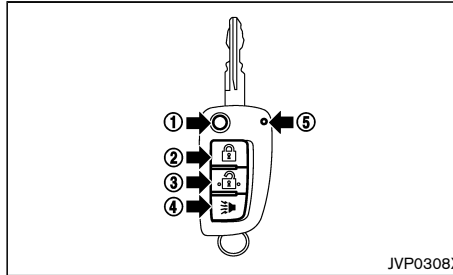

#### Type B (with panic alarm)

- ① Jackknife type key release button
- ② LOCK button
- ③ UNLOCK button
- ④ PANIC button
- ⑤ Battery indicator light

### Locking doors

1. Remove the ignition key.
2. Close all doors.
3. Push the "LOCK" button ② on the remote controller.
4. All doors will be locked. The door lock indicator light (located on the instrument panel) will illuminate for 1 minutes (if equipped).
5. Operate door handles to confirm that the doors have been securely locked.



#### CAUTION:

**After locking the doors using the remote controller, be sure that the doors have been securely locked by operating the door handles.**

### Unlocking doors

1. Push the "UNLOCK" button ③ on the remote controller.
2. All doors will be unlocked.

All doors will be locked automatically unless one of the following operations is performed within 30 seconds or 1 minute after pushing the "UNLOCK" button ③.

- Opening any doors.
- Inserting the key into the ignition switch.

#### Selective door unlock mode (if equipped) (Type A):

1. Push the "UNLOCK" button ③ on the remote controller.
2. The driver's door unlock.
3. Push the "UNLOCK" button ③ on the remote controller again.
4. All doors will be unlocked.

#### Selective door unlock mode (if equipped) (Type B):

When you first receive the vehicle, the door unlock mode is set to unlock all the doors with one push of the "UNLOCK" button ③. The door unlock mode can be switched to the selective door unlock mode, which unlocks the passenger's doors at the second push of the "UNLOCK" button ③.





Selective door unlock mode:

1. Push the "UNLOCK" button ③ on the remote controller.
2. The driver's door unlock.

## 3-8 Pre-driving checks and adjustments

3. Push the "UNLOCK"  button  on the remote controller again.
4. All doors will be unlocked.

To switch to the selective door unlock mode, perform the following procedure.

Push the "LOCK"   and "UNLOCK"  buttons  simultaneously for more than 5 seconds.

Perform the same procedure to deactivate the selective door unlock mode.

#### Interior light timer (if equipped):



The interior light timer activates and the interior lights illuminate for 15 seconds when a door is unlocked and the interior light switch is in the "DOOR" position.

The interior lights can be turned off without waiting for 15 seconds by performing one of the following operations.



- Turning the ignition switch to the "ON" position.
- Locking the doors with the remote controller.
- Switching the interior light switch to the "OFF" position.

#### Using panic alarm (if equipped)

If you are near your vehicle and feel threatened, you may activate the alarm to call attention as follows:

1. Push the "PANIC"  button  on the remote controller for **more than 0.5 second**.
2. The theft warning alarm will stay on for 25 seconds.
3. The panic alarm stops when:
  - It has run for 25 seconds, or
  - Any of the buttons on the remote controller are pushed. (Note: Panic button should be pushed for more than 0.5 second.)

#### Battery indicator light

The battery indicator light  (Type A) or  (Type B) illuminates when you push any button. If the light does not illuminate, the battery is weak or needs replacement. For information regarding replacement of a battery, see "Remote controller battery" (P.8-21).

#### HAZARD INDICATOR OPERATION

When you lock or unlock the doors, the hazard indicator will flash as a confirmation.

- "LOCK": The hazard indicator flashes once.
- "UNLOCK": The hazard indicator flashes twice.

#### Hazard indicator mode (for South Africa and Europe)

	DOOR LOCK	DOOR UNLOCK
Remote keyless entry system	HAZARD - <b>once</b>	HAZARD - <b>twice</b>

#### Hazard indicator mode (except for South Africa and Europe)

	DOOR LOCK	DOOR UNLOCK
Remote keyless entry system	HAZARD - <b>twice</b>	HAZARD - <b>none</b>

### Hazard indicator and horn mode (except for South Africa and Europe)

	DOOR LOCK	DOOR UNLOCK
<b>Remote keyless entry system</b>	HAZARD - <b>twice</b> HORN - <b>once</b>	HAZARD - <b>once</b> HORN - <b>none</b>

#### Switching procedure (if equipped)

You can switch the hazard indicator and horn operation with the following procedures.

Push the "LOCK" ② and "UNLOCK" ③ buttons simultaneously for more than 2.5 seconds to switch the mode from one to the other.

When pushing the buttons to set the hazard indicator mode, the hazard indicator flashes 3 times.

When pushing the buttons to set the hazard indicator and horn mode, the hazard indicator flashes once and the horn chirps once.

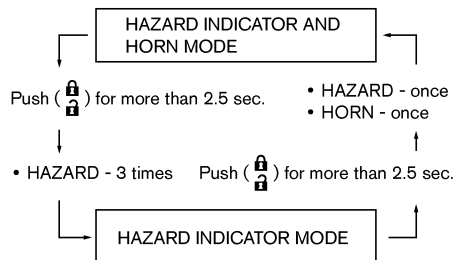

### INTELLIGENT KEY SYSTEM (if equipped)

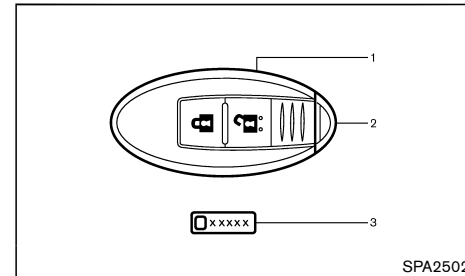

Type A

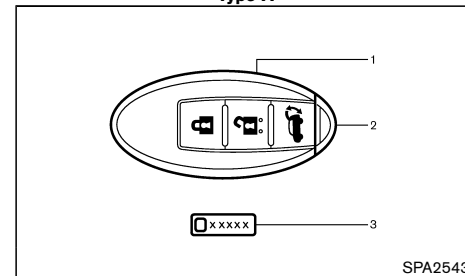

Type B (example)

### 3-10 Pre-driving checks and adjustments



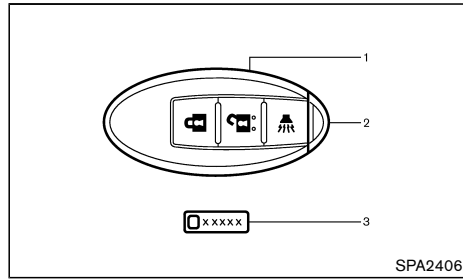

Type C

SPA2406

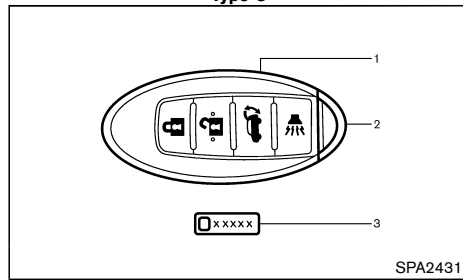

Type D

SPA2431

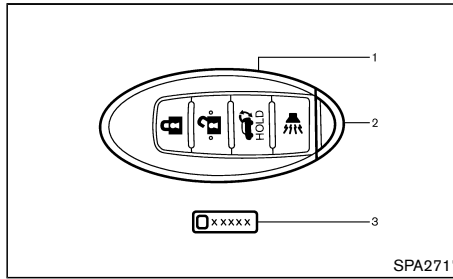

Type E

SPA2717

1. Intelligent Key (2)
2. Mechanical key (in the Intelligent Key) (2)
3. Key number plate (1)

**WARNING:**

- **Radio waves could adversely affect electric medical equipment. Those who use a pacemaker should contact the electric medical equipment manufacturer for the possible influences before use.**
- **The Intelligent Key transmits radio waves when the buttons are pushed. The radio waves may affect aircraft navigation and communication systems. Do not operate the Intelligent Key while on an airplane. Make sure the buttons are not operated unintentionally when the unit is stored during a flight.**

The Intelligent Key system can operate all the door and the back door using the remote controller function or pushing the request switch on the vehicle without taking the key out from a pocket or purse. The operating environment and/or conditions may affect the Intelligent Key system operation.

Be sure to read the following before using the Intelligent Key system.

**CAUTION:**

- **Be sure to carry the Intelligent Key with you when operating the vehicle.**
- **Never leave the Intelligent Key in the vehicle when you leave the vehicle.**
- **When the outside temperature is extremely low, the Intelligent Key system may not function properly.**

The Intelligent Key is always communicating with the vehicle as it receives radio waves. The Intelligent Key system transmits weak radio waves. Environmental conditions may interfere with the operation of the Intelligent Key system under the following operating conditions.

- When operating near a location where strong radio waves are transmitted, such as a TV tower, power station and broadcasting station.
- When in possession of wireless equipment, such as a cellular telephone, transceiver, and CB radio.
- When the Intelligent Key is in contact with or covered by metallic materials.
- When any type of radio wave remote control is used nearby.
- When the Intelligent Key is placed near an electric appliance such as a personal computer.
- When the vehicle is parked near a parking meter.

In such cases, correct the operating conditions before using the Intelligent Key function or use the mechanical key.

Although the life of the battery varies depending on the operating conditions, the battery's life is approximately 2 years. If the battery is discharged, replace it with a

**Pre-driving checks and adjustments 3-11**

new one.

For information regarding replacement of a battery, see "Intelligent Key battery" (P.8-22).

Since the Intelligent Key is continuously receiving radio waves, if the key is left near equipment which transmits strong radio waves, such as signals from a TV and personal computer, the battery life may become shorter.

Because the steering wheel is locked electrically (if equipped), unlocking the steering wheel with the ignition switch in the "LOCK" position is impossible when the vehicle battery is completely discharged. Pay special attention that the vehicle battery is not completely discharged.

As many as 4 Intelligent Keys can be used with one vehicle. For information about the purchase and use of additional Intelligent Keys, contact a NISSAN dealer.



#### **CAUTION:**

- **Do not allow the Intelligent Key, which contains electrical components, to come into contact with water or salt water. This could affect the system function.**
- **Do not drop the Intelligent Key.**
- **Do not strike the Intelligent Key sharply against another object.**
- **Do not change or modify the Intelligent Key.**
- **Wetting may damage the Intelligent Key. If the Intelligent Key gets wet, immediately wipe until it is completely dry.**
- **Do not place the Intelligent Key for an extended period in an area where temperatures exceed 60°C (140°F).**

- **If the outside temperature is below -10°C (14°F), the battery of the Intelligent Key may not function properly.**
- **Do not attach the Intelligent Key with a key holder that contains a magnet.**
- **Do not place the Intelligent Key near equipment that produces a magnetic field, such as a TV, audio equipment and personal computers.**

If an Intelligent Key is lost or stolen, NISSAN recommends erasing the ID code of that Intelligent Key from the vehicle. This may prevent the unauthorized use of the Intelligent Key to operate the vehicle. For information regarding the erasing procedure, contact a NISSAN dealer.

For information regarding replacement of a battery, see "Battery" (P.8-20).

The Intelligent Key function can be disabled. For information about disabling the Intelligent Key function, contact a NISSAN dealer.

### 3-12 Pre-driving checks and adjustments

## OPERATING RANGE

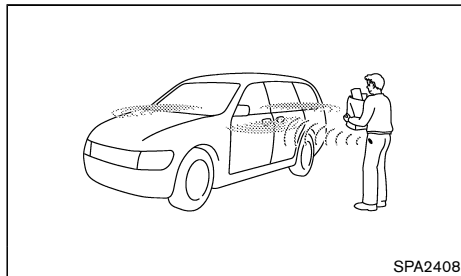
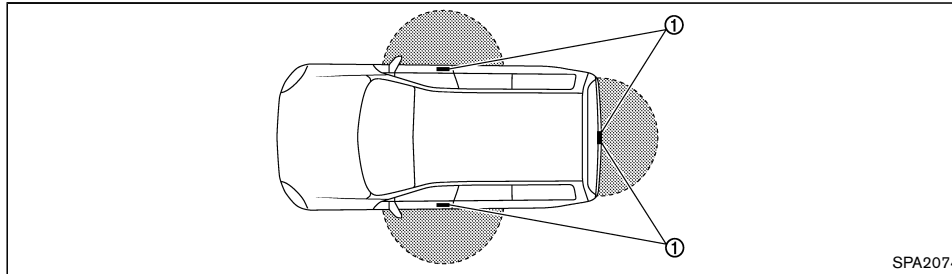

The Intelligent Key functions can only be used when the Intelligent Key is within the specified operating range from the request switch ①.

When the Intelligent Key battery is discharged or strong radio waves are present near the operating location, the Intelligent Key system's operating range becomes narrower, and the Intelligent Key may not function properly.

The operating range is within 80 cm (31.50 in) from each request switch ①.

If the Intelligent Key is too close to the door glass,

handle or rear bumper the request switches may not function.

When the Intelligent Key is within the operating range, it is possible for anyone, even someone who does not carry the Intelligent Key, to push the request switch and lock/unlock the doors.

## USING INTELLIGENT KEY SYSTEM

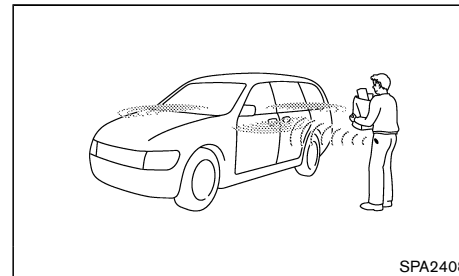

The request switch will not function under the following conditions:

- When the Intelligent Key is left inside the vehicle
- When the Intelligent Key is not within the operational range
- When any door is open or not closed securely
- When the Intelligent Key battery is discharged
- When the ignition switch is in the "ON" position

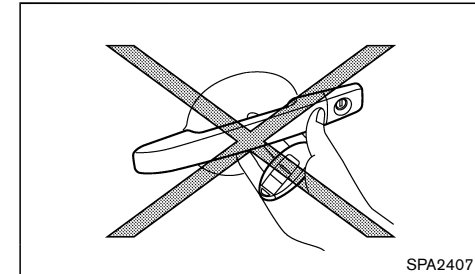

- Do not push the door handle request switch with the Intelligent Key held in your hand as illustrated. The close distance to the door handle will cause the Intelligent Key system to have difficulty recognizing that the Intelligent Key is outside the vehicle.
- After locking the doors using the door handle request switch, make sure that the doors have been securely locked by operating the door handles.
- When locking the doors using the door handle request switch, make sure to have the Intelligent Key in your possession before operating the door handle request switch to prevent the Intelligent Key from being left in the vehicle.
- The door handle request switch is operational only when the Intelligent Key has been detected by the Intelligent Key system.

## Pre-driving checks and adjustments 3-13

- Do not pull the door handle before pushing the door handle request switch. The door will be unlocked but will not open. Release the door handle once and pull it again to open the door.

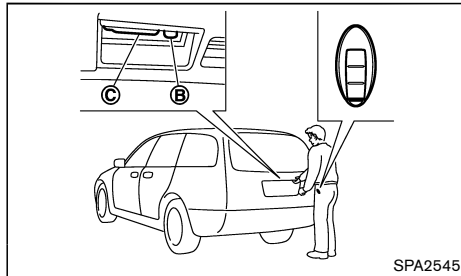
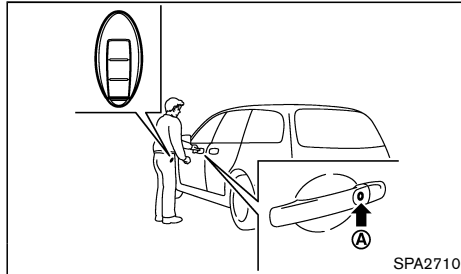

When you carry the Intelligent Key with you, you can lock or unlock all doors by pushing the door handle request switch (driver's or front passenger's) **(A)** or back door request switch **(B)** within the range of operation.

When you lock or unlock the doors or open the back door, the hazard indicator will flash and the outside chime will sound (if equipped) as a confirmation. For details, see "Hazard indicator and horn operation"

### 3-14 Pre-driving checks and adjustments

(P.3-18).

#### Welcome light and farewell light function (if equipped)

When you lock or unlock the doors including the back door, the clearance lights, tail lights and the license plate light will illuminate for a period of time. The welcome light and farewell light function can be disabled. For information about disabling the welcome light and farewell light function, contact a NISSAN dealer.

#### Locking doors

- Place the ignition switch in the "OFF" position.
- Carry the Intelligent Key with you.
- Close all doors.
- Push the door handle request switch **(A)** (driver's or front passenger's) or the back door request switch **(B)**.
- All doors and the back door will be locked. The door lock indicator light  (located on the instrument panel) will illuminate for 1 minutes (if equipped).
- Operate door handles to confirm that the doors have been securely locked.

#### Lockout protection (if equipped):

To prevent the Intelligent Key from being accidentally locked in the vehicle, lockout protection is equipped with the Intelligent Key system.

- When the Intelligent Key is left in the vehicle and you try to lock the door using the driver's inside lock knob after getting out of the vehicle, all the doors will unlock automatically and a chime will sound after the door is closed.

- When the Intelligent Key is left in the vehicle while the driver's door is opened and you try to lock the door using the power door lock switch after getting out of the vehicle, an inside warning chime will sound after the power door lock switch or the driver's inside lock knob is operated.



#### CAUTION:

**The lockout protection may not function under the following conditions:**

- When the Intelligent Key is placed on top of the instrument panel.**
- When the Intelligent Key is placed on the tonneau cover (if equipped).**
- When the Intelligent Key is placed inside of the glove box.**
- When the Intelligent Key is placed inside of the door pockets.**
- When the Intelligent Key is placed on or under the spare tire area.**
- When the Intelligent Key is placed inside or near metallic materials.**

**The lockout protection may function when the Intelligent Key is outside the vehicle but is too close to the vehicle.**

#### Unlocking doors

##### Switching door unlock mode (if equipped):

To switch the door unlock mode from one to another, see "Using remote keyless entry function" (P.3-17).

**Selective door unlock mode (if equipped):**

1. Carry the Intelligent Key with you.
2. Push the door handle request switch **(A)** or the back door request switch **(B)**.
3. Driver's door handle or back door request switch:  
Only the corresponding door will be unlocked.  
Front passenger's door handle request switch:  
All doors (including the back door) will be unlocked. (Selective door unlock mode is not available.)
4. Push the door handle request switch again within 1 minute or 5 seconds.
5. All doors will be unlocked.
6. Operate the door handles to open the doors.

**All door unlock mode:**

1. Carry the Intelligent Key with you.
2. Push the door handle request switch **(A)** or back door request switch **(B)**.
3. All doors and the back door will be unlocked.

If a door handle is pulled while unlocking the doors, that door may not be unlocked. Returning the door handle to its original position will unlock the door. If the door does not unlock, after returning the door handle, push the door handle request switch to unlock the door.

All doors will be locked automatically unless one of the following operations is performed within 1 minute or 30 seconds after pushing the request switch while the doors are locked.

- Opening any doors.
- Pushing the ignition switch.

If during the preset time period the "UNLOCK"  button on the Intelligent Key is pushed, all doors will be

locked automatically after the next preset time.

**Opening power back door (if equipped)**

1. Carry the Intelligent Key.
2. Push the power back door opener switch **(C)**.
3. The back door will unlock and automatically open.

The hazard indicator flashes 4 times and the outside chime sounds.

To close the back door, push the power back door button on the Intelligent Key, the power back door switch on the instrument panel or the lower part of the back door. (See "Back door" (P.3-23).)

**WARNING SIGNALS**

The Intelligent Key system is equipped with a function that is designed to minimize improper operations and to help prevent the vehicle from being stolen. The warning buzzer sounds and the warning light illuminates or the warning display appears on the vehicle information display when improper operations are detected.

**CAUTION:**

**When the buzzer sounds and the warning light illuminates or the warning display appears, be sure to check both the vehicle and the Intelligent Key.**

## TROUBLESHOOTING GUIDE

Symptom		Possible cause	Action to take
When pushing the ignition switch to stop the engine	The Shift to Park warning appears on the vehicle information display and the inside warning chime sounds continuously or for a few seconds. (Continuously Variable Transmission models)	The shift lever is not in the "P" (Park) position.	Shift the shift lever to the "P" (Park) position.
When opening the driver's door to get out of the vehicle	The inside warning chime sounds continuously.	The ignition switch is in the "OFF" position.	Close the door securely.
When closing the door after getting out of the vehicle	The Key System Fault warning in the meter blinks in yellow, the outside chime sounds 3 times and the inside warning chime sounds for a few seconds.	The ignition switch is in the "ON" position.	Place the ignition switch in the "OFF" position.
	The Shift to Park warning appears on the vehicle information display and the outside chime sounds continuously. (Continuously Variable Transmission models)	The ignition switch is in the "OFF" position and the shift lever is not in the "P" (Park) position.	Move the shift lever to the "P" (Park) position and place the ignition switch in the "OFF" position.
When pushing the request switch or the "LOCK"  button on the Intelligent Key to lock the door	The outside chime sounds for a few seconds and all the doors unlock.	The Intelligent Key is inside the vehicle.	Carry the Intelligent Key with you.
When closing the door with the inside lock knob turned to "LOCK"	The outside chime sounds for a few seconds and all the doors unlock.	The Intelligent Key is inside the vehicle or luggage room.	Carry the Intelligent Key with you.
When pushing the door handle request switch to lock the door	The outside chime sounds for a few seconds.	The Intelligent Key is inside the vehicle or luggage room.	Carry the Intelligent Key with you.
		A door is not closed securely.	Close the door securely.
When pushing the ignition switch to start the engine	The door handle request switch is pushed before the door is closed.	The door handle request switch is pushed before the door is closed.	Push the door handle request switch after the door is closed.
	The Key System Fault warning in the meter blinks in green.	The battery charge is low.	Replace the battery with a new one. (See "Battery" (P.8-20).)
When pushing the ignition switch to start the engine	The Key System Fault warning in the meter blinks in yellow and the inside warning chime sounds for a few seconds.	The Intelligent Key is not in the vehicle.	Carry the Intelligent Key with you.
	The Key System Fault warning in the meter illuminates in yellow.	It warns of a malfunction with the electrical steering lock system or the Intelligent Key system.	Contact a NISSAN dealer.

## 3-16 Pre-driving checks and adjustments

## USING REMOTE KEYLESS ENTRY FUNCTION

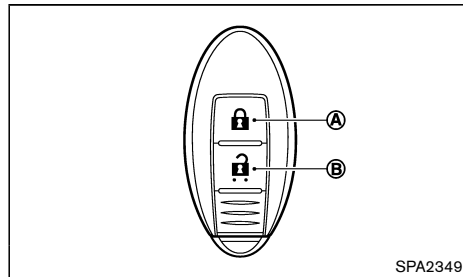

**Type A**

SPA2349

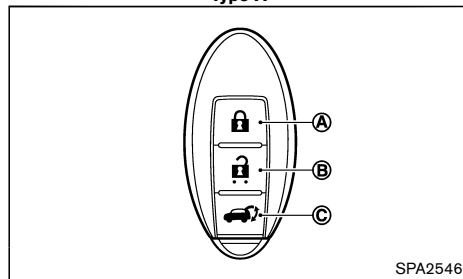

**Type B (example)**

SPA2546

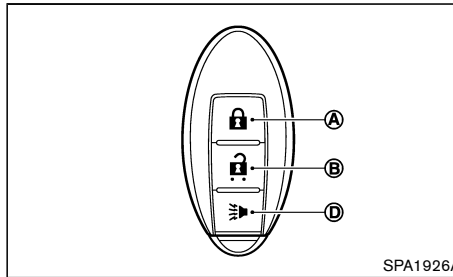

**Type C**

SPA1926A

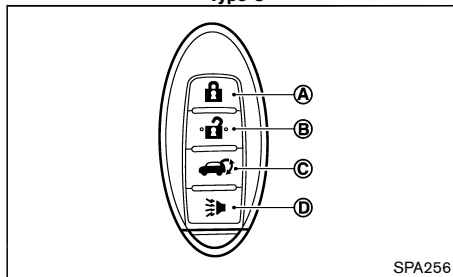

**Type D**

SPA2561

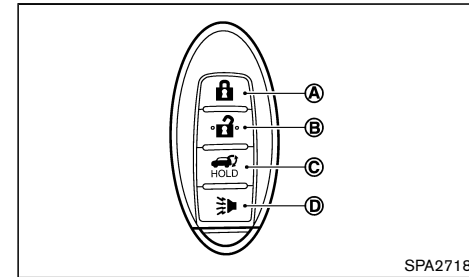

**Type E**

SPA2718

- (A) LOCK button
- (B) UNLOCK button
- (C) Power back door button (if equipped)
- (D) PANIC button (if equipped)

### Operating range

It is possible to lock/unlock all doors including the back door using the remote keyless entry system. The operating distance depends upon the conditions around the vehicle. To securely operate the lock and unlock buttons, approach the vehicle to about 1 m (3.3 ft) from the door.

The remote keyless entry system will not function under the following conditions:

- When the Intelligent Key is not within the operational range.
- When the Intelligent Key battery is discharged.

For information regarding the replacement of a battery, see "Battery" (P.8-20).

### Locking doors

1. Place the ignition switch in the "OFF" position and carry the Intelligent Key.
2. Close all doors (including the back door).
3. Push the "LOCK" button **(A)** on the Intelligent Key.
4. All doors will be locked. The door lock indicator light  (located on the instrument panel) will illuminate for 1 minutes (if equipped).
5. Operate the door handles to confirm that the doors have been securely locked.



#### CAUTION:

**After locking the doors using the Intelligent Key, be sure that the doors have been securely locked by operating the door handles.**

### Unlocking doors

When you first receive the vehicle, the door unlock mode is set to unlock all the doors with one push of the "UNLOCK" button **(B)**. The door unlock mode can be switched to the selective door unlock mode (if equipped).

To change the door unlock mode from one to another, see "Vehicle information display" (P.2-20).

All door unlock mode:

1. Push the "UNLOCK" button **(B)** on the Intelligent Key.
2. All doors (including the back door) will be unlocked.

Selective door unlock mode (if equipped):

1. Push the "UNLOCK" button **(B)** on the Intelligent Key.

## 3-18 Pre-driving checks and adjustments

2. The driver's door will be unlocked.
3. Push the "UNLOCK" button **(B)** on the Intelligent Key again.
4. All doors (including the back door) will be unlocked.

#### Automatic relock:

All doors will be locked automatically unless one of the following operations is performed within 30 seconds or 1 minute after pushing the "UNLOCK" button **(B)** on the Intelligent Key while the doors are locked. If during this 30 seconds or 1 minute time period, the "UNLOCK" button **(B)** on the Intelligent Key is pushed, all doors will be locked automatically after another 30 seconds or 1 minute.

- Opening any door or back door.
- Pushing the ignition switch.

### Opening or closing back door (if equipped)

#### Opening:

1. Push the power back door button  **(C)** for more than 1 second.
2. The back door will automatically open.

The hazard indicator flashes 4 times and the outside chime sounds.

#### Closing:

1. Push the power back door button  **(C)**.
2. The back door will automatically close.

The hazard indicator flashes 4 times and the outside chime sounds.

If the button  **(C)** is pushed while the back door is being opened or closed, the back door will reverse.

### Using panic alarm (if equipped)

If you are near your vehicle and feel threatened, you may activate the alarm to call attention as follows:

1. Push the "PANIC"  button **(D)** on the Intelligent Key for **more than 1 second**.
2. The theft warning alarm and headlights (if equipped) will stay on for 25 seconds.
3. The panic alarm stops when:
  - It has run for 25 seconds, or
  - Any of the buttons on the Intelligent Key are pushed. (Note: Panic button should be pushed for more than 1 second.)



### HAZARD INDICATOR AND HORN OPERATION

When you lock or unlock the doors or the back door with the request switch or the remote keyless entry function, the hazard indicator will flash and the horn or the outside chime will sound as a confirmation.



The following descriptions show how the hazard indicator and outside chime will activate when locking or unlocking the doors or back door.





Hazard indicator mode (for South Africa and Europe)

Operation	DOOR LOCK	DOOR UNLOCK
Intelligent Key system (using door handle or back door request switch)	HAZARD - <b>once</b>	HAZARD - <b>twice</b>
Remote keyless entry system (using  or  button)	HAZARD - <b>once</b>	HAZARD - <b>twice</b>



Hazard indicator mode (except for South Africa and Europe)

Operation	DOOR LOCK	DOOR UNLOCK
Intelligent Key system (using door handle or back door request switch)	HAZARD - <b>twice</b>	HAZARD - <b>none</b>
Remote keyless entry system (using  or  button)	HAZARD - <b>twice</b>	HAZARD - <b>none</b>

Hazard indicator and horn mode (except for South Africa and Europe)

Operation	DOOR LOCK	DOOR UNLOCK
Intelligent Key system (using door handle or back door request switch)	HAZARD - <b>twice</b> OUTSIDE CHIME - <b>twice</b>	HAZARD - <b>once</b> OUTSIDE CHIME - <b>once</b>
Remote keyless entry system (using  or  button)	HAZARD - <b>twice</b> HORN - <b>once</b>	HAZARD - <b>once</b> HORN - <b>none</b>

Switching procedure (if equipped)

To switch the hazard indicator and horn (chime) operation, push the LOCK  and UNLOCK  buttons on the Intelligent Key simultaneously for more than 2.5 seconds.

- When the hazard indicator and horn mode are set, the hazard indicator flashes once and the horn chirps once.
- When the hazard indicator mode is set, the hazard indicator flashes 3 times.

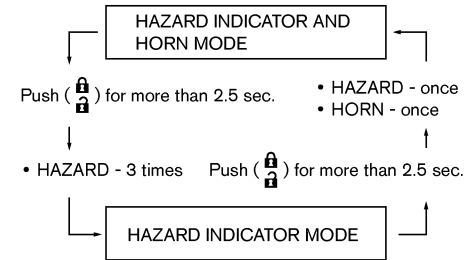

## SECURITY SYSTEM

Your vehicle has either or both of the following security systems:

- Theft warning
- NISSAN Anti-theft System (NATS)\*

The security condition will be shown by the security indicator light.

(\* immobilizer)

### THEFT WARNING SYSTEM (if equipped)

The theft warning system provides visual and audio alarm signals if parts of the vehicle are disturbed.

#### Security indicator light

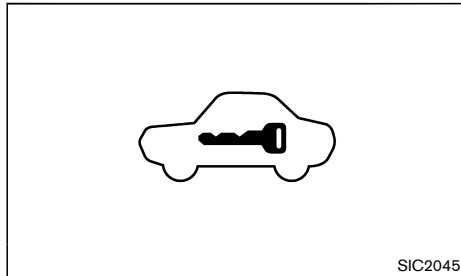

The security indicator light, located on the meter panel, operates whenever the ignition switch is in the "LOCK" or "OFF" position. This is normal.

For models with ultrasonic sensor

#### How to activate system:

1. Close all windows and sunroof (if equipped).
2. Place the ignition switch in the "OFF" position.
3. Carry the remote controller or the Intelligent Key with you and get out of the vehicle.
4. Make sure the hood and the back door are closed. Close and lock all doors with the remote controller, the Intelligent Key or the request switch. If a door or the hood is open, the buzzer will sound. The buzzer will stop when the door is correctly closed.
5. Confirm that the security indicator light comes on. The security indicator light blinks rapidly for approximately 20 seconds and then blinks slowly. The system is now activated. If, during this 20-second time period, the door is unlocked by the remote controller, the Intelligent Key or the request switch, or the ignition switch is placed in the "ON" position, the system will not activate.

**Even when the driver and/or passengers are in the vehicle, the system will activate with all doors locked and the ignition switch off. Place the ignition switch in the "ON" position to turn the system off.**

**If the system malfunctions, the short beep sounds 5 times when the system is activated. Have the system checked by a NISSAN dealer.**

#### Theft warning system operation:

The warning system will give the following alarm:

- The hazard indicator blinks and the alarm sounds intermittently for approximately 30 seconds. (The alarm will repeat 8 times.)

- The alarm automatically turns off after approximately 30 seconds. However, the alarm reactivates if the vehicle is tampered with again.

The alarm is activated when:

- operating the door or the back door without using the remote controller, the Intelligent Key or the request switch.
- opening the hood (if equipped).
- the volumetric sensing system (ultrasonic sensors) is triggered (when it is activated).
- the power supply is disconnected.

#### How to stop alarm:

- The alarm will stop by unlocking a door with the request switch (if equipped) or the "UNLOCK"  button on the Intelligent Key.
- The alarm will stop if the ignition switch is placed in the "ON" position.

#### Cancel switch for ultrasonic sensor:

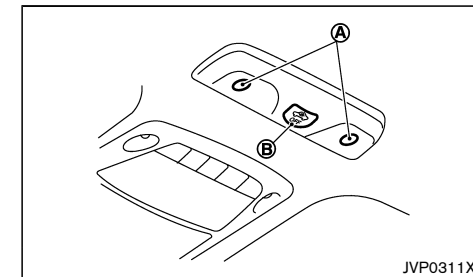

The ultrasonic sensors  (volumetric sensing), located on the ceiling, detect movement in the passenger's compartment. When the theft warning system is set to the armed position, it will automatically

## 3-20 Pre-driving checks and adjustments

switch on the ultrasonic sensor.

It is possible to exclude the ultrasonic (for example, when leaving pets inside the car or transporting the vehicle on a ferry).

To exclude the ultrasonic:

1. Close all the windows.
2. Place the ignition switch in the "OFF" position.
3. Push the cancel switch **(B)** located on the ceiling. The security indicator light will start flashing rapidly.
4. Close the doors, hood and back door. Lock them using the remote controller, the Intelligent Key or the request switch. The security indicator light will start flashing faster and a buzzer will sound once.

The ultrasonic sensor is now excluded from the theft warning system. All other functions of the system remain activated until the theft warning system is disarmed again.

For models without ultrasonic sensor

#### How to activate system:

1. Close all windows and sunroof (if equipped).

**The system can be armed even if the windows are open.**

2. Place the ignition switch in the "OFF" position.
3. Remove remote controller or the Intelligent Key from the vehicle.
4. Close all doors, hood and back door. Lock all doors. The doors can be locked with remote controller or the Intelligent Key, door handle request switch, power door lock switch or mechanical key.

5. Confirm that the security indicator light comes on. The security indicator light stays on for about 30 seconds. The vehicle security system is now pre-armed. After about 30 seconds the vehicle security system automatically shifts into the armed phase. The security light begins to flash once every approximately 3 seconds. If, during this 30 seconds pre-arm time period, the door is unlocked, or the ignition switch is placed in "ON", the system will not alarm.

**Even when the driver and/or passengers are in the vehicle, the system will activate with all doors, hood, and back door locked with the ignition switch in the "LOCK" position. When placing the ignition switch in the "ON" position, the system will be released.**

#### Theft warning system operation:

The vehicle security system will give the following alarm:

- The hazard indicator or headlight blinks and the horn sounds intermittently.
- The alarm automatically turns off after approximately 30 or 50 seconds. However, the alarm reactivates if the vehicle is tampered with again.

The alarm is activated by:

- Unlocking the door or opening the back door without using the button on the remote controller or the Intelligent Key, the door handle request switch or the mechanical key. (Even if the door is opened by releasing the door inside lock knob, the alarm will activate.)
- Opening the hood.

#### How to stop alarm:

- The alarm will stop only by unlocking a door by pushing the "UNLOCK" button on the remote controller or the Intelligent Key.
- The alarm will not stop if the ignition switch is placed in the "ON" position.

#### NISSAN ANTI-THEFT SYSTEM (NATS)

The NISSAN Anti-Theft System (NATS) will not allow the engine to start without the use of the registered NATS key.

If the engine does not start using the registered NATS key, it may be due to interference caused by:

- Another NATS key.
- Automated toll road device.
- Automated payment device.
- Other devices that transmit similar signals.

Start the engine using the following procedure:

1. Remove any items that may be causing the interference away from the NATS key.
2. Leave the ignition switch in the "ON" position for approximately 5 seconds.
3. Place the ignition switch in the "OFF" or "LOCK" position, and wait approximately 10 seconds.
4. Repeat steps 2 and 3 again.
5. Start the engine.
6. Repeat the steps above until all possible interferences are eliminated.

If this procedure allows the engine to start, NISSAN recommends placing the registered NATS key separate from other devices to avoid interference.

**FCC Notice:****For USA:**

**This device complies with Part 15 of the FCC Rules. Operation is subject to the following two conditions: (1) This device may not cause harmful interference, and (2) this device must accept any interference received, including interference that may cause undesired operation.**

**Note: Changes or modifications not expressly approved by the party responsible for compliance could void the user's authority to operate the equipment.**

**For Canada:**

**This device complies with Industry Canada licence-exempt RSS standard(s). Operation is subject to the following two conditions: (1) this device may not cause interference, and (2) this device must accept any interference, including interference that may cause undesired operation of the device.**

## Security indicator light

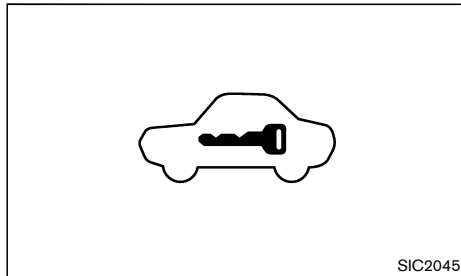

The security indicator light is located on the meter panel. It indicates the status of NATS.

**3-22 Pre-driving checks and adjustments**

The light operates whenever the ignition switch is in the "LOCK", "OFF" or "ACC" position. The security indicator light indicates that the security systems on the vehicle are operational.

If NATS is malfunctioning, this light will remain on while the ignition switch is in the "ON" position.

**If the light remains on and/or the engine does not start, contact a NISSAN dealer for NATS service as soon as possible. Be sure to bring all NATS keys that you have when visiting a NISSAN dealer for service.**

**HOOD****WARNING:**

- **The hood must be closed and latched securely before driving. Failure to do so could cause the hood to fly open and result in an accident.**
- **Never open the hood if steam or smoke is coming from the engine compartment to avoid injury.**

## OPENING HOOD

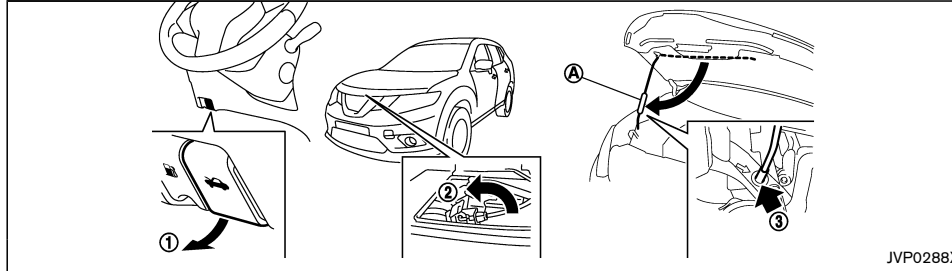

1. Pull the hood lock release handle ① located below the instrument panel until the hood springs up.
2. Locate the lever ② in between the hood and grille, and push the lever sideways with your fingertips.
3. Raise the hood.
4. Remove the support rod and insert it into the slot ③.

**Hold the coated parts ④ when removing or resetting the support rod. Avoid direct contact with the metal parts, as they may be hot immediately after the engine has been stopped.**

## CLOSING HOOD

1. While supporting the hood, return the support rod to its original position.
2. Slowly lower the hood to about 20 to 30 cm (8 to 12 in) above the hood lock, then let it drop.
3. Make sure it is securely latched.

## BACK DOOR



### WARNING:

- Always be sure the back door has been closed securely to prevent it from opening while driving.
- Do not drive with the back door open. This could allow dangerous exhaust gases to be drawn into the vehicle. See "Precautions when starting and driving" (P.5-3) for exhaust gas.
- Do not leave children unattended inside the vehicle. They could unknowingly activate switches or controls. Unattended children could become involved in serious accidents.
- Always be sure that hands and feet are clear of the door frame to avoid injury while closing the back door.

## OPERATING MANUAL BACK DOOR

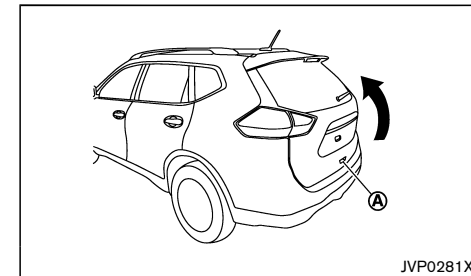

To open the back door, unlock it and push the opener switch ④. Pull up the back door to open.

The back door can be unlocked by:

## Pre-driving checks and adjustments 3-23

- pushing the "UNLOCK"  button on the key.
- pushing the back door request switch (if equipped).
- pushing the door handle request switch (if equipped).
- pushing the power door lock switch to the unlock position.

To close the back door, pull down until it securely locks.

### OPERATING POWER BACK DOOR (if equipped)

To operate the power back door, the shift lever must be in the P (Park) position.

The power back door will not operate if the battery voltage is low.

#### Power back door main switch

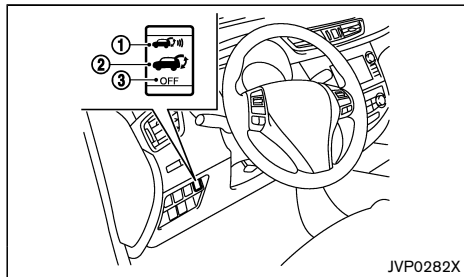

**Type A**

- ① Power open (hands-free operation)
- ② Power open/close (switch operation)
- ③ Manual operation

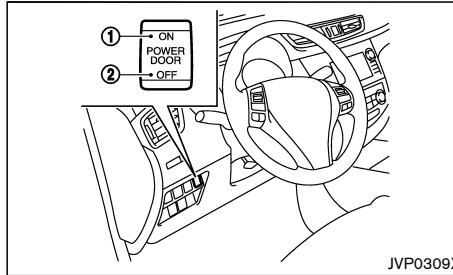

**Type B**

- ① Power open/close (switch operation)
- ② Manual operation

The power back door operation can be turned on or off with the power back door main switch on the instrument panel.

When the power door main switch is pushed to the "OFF" position ③ (Type A) or ② (Type B), power operation is available by using the power back door button on the Intelligent Key.

#### Power open (switch operation)

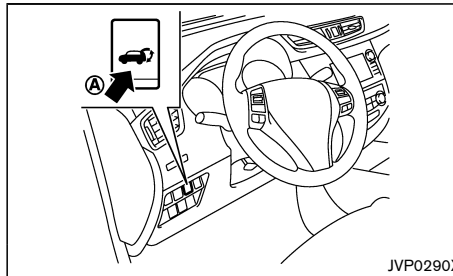

**Power back door switch — Instrument panel**

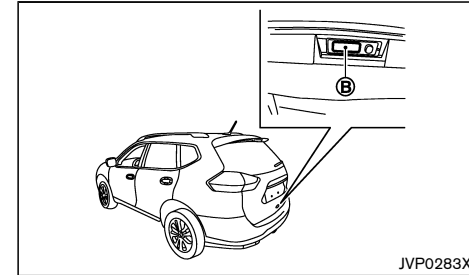

**Back door opener switch**

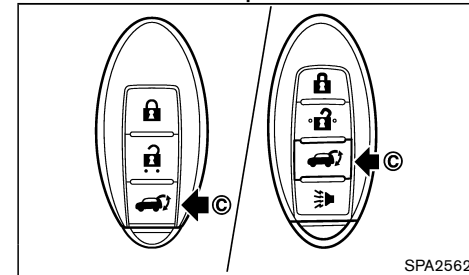

**Power back door button - Key**

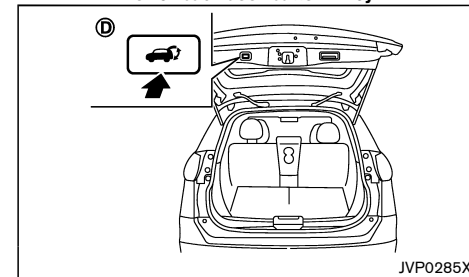

**Power back door switch — Back door**

When the back door is fully closed, the back door will

## 3-24 Pre-driving checks and adjustments

fully open automatically by:

- pushing the power back door switch **(A)** on the instrument panel for more than 1 second
- pushing the back door opener switch **(B)**
- pushing the power back door button **(C)** on the key for more than 1 second

The hazard flashes 4 times and the outside chime sounds when the back door starts opening.

#### NOTE:

**The back door can be opened by the power back door switch **(A)** or the power back door button **(C)** even if the back door is locked. The back door can be unlocked and opened independently of the other doors, even when they are locked.**

Power open (hands-free operation)

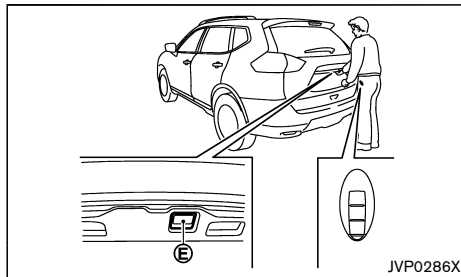

When the back door is fully closed, the back door will fully open automatically by hands-free operation.

1. Carry the Intelligent Key.
2. Put your hand or luggage near the hands-free sensor **(E)**, as illustrated, for about 1 second.

3. The back door will unlock and automatically open. The back door will open regardless of the lock status.

The hands-free sensor will not function under the following conditions:

- When the Intelligent Key is not carried with you.
- When the back door is open.
- When automatic operation of the back door is being performed.

The hazard flashes 4 times and the outside chime sounds when the back door starts opening.

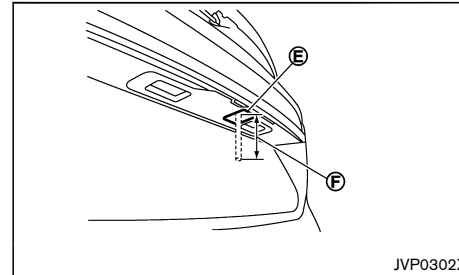

#### NOTE:

- The back door cannot be closed automatically by using the hands-free sensor **(E)**.
- All doors will lock while the hands-free sensor is being used.
- If dirt attaches to the surface of the hands-free sensor, the sensor may not function. Wipe the sensor using a clean cloth.
- If water is splashed to the area around the hands-free sensor, it may cause a malfunction.

- The operating range **(F)** of the hands-free sensor is within 80 mm (3.1 in) of the center of the sensor.



#### CAUTION:

- The back door may open even if something other than your hand or luggage enters the operating range of the hands-free sensor when the Intelligent Key is carried with you.
- Even if the Intelligent Key is carried with you, the back door cannot be opened when something such as leather gloves absorb the light is put to the hands-free sensor.
- The back door may not open, if the headlights, sunlight or another light source shines directly on the sensor, or an accessory such as a frame is attached to the license plate, even if your hand or luggage enters the operating range of the hands-free sensor when the Intelligent Key is carried with you.
- When washing, waxing or maintaining your vehicle, placing or replacing the body cover, or splashing water to the area around the hands-free sensor, place the power back door main switch to the **(2)** position or **(3)** position.
- The hands-free sensor detects objects by infrared light. Never move the sensor. If the location of the sensor, angle of the sensor or direction of light irradiation change, it may lead to non-operation, incorrect detection or other operating malfunctions.
- If the automatic open/close operation is performed consecutively, the safety mode activates and the operation cannot be performed.

Pre-driving checks and adjustments 3-25

**formed for a certain period of time. In this case, wait for a while and then perform the operation.**

### Power close

When the back door is fully opened, the back door will fully close automatically by:

- pushing the power back door switch **(A)** on the instrument panel
- pushing the power back door switch **(D)** on the lower part of the back door
- pushing the power back door button **(C)** on the key for more than 1 second

The hazard flashes 4 times and the outside chime sounds when the back door starts closing.

### Reverse function

The power back door will reverse immediately if one of the following actions is performed during power open or power close.

- pushing the power back door switch **(A)** on the instrument panel
- pushing the power back door switch **(D)** on the lower part of the back door
- pushing the power back door button  **(C)** on the key.

The outside chime sounds when the back door starts to reverse.

### Auto reverse function

The auto-reverse function enables the back door to automatically reverse when something is caught in the back door as it is opening or closing. When the control unit detects an obstacle, the back door will reverse and return to the full open or full close position.

If a second obstacle is detected, the back door motion will stop. The back door will enter the manual mode.

A pinch sensor is mounted on each side of the back door. If an obstacle is detected by the pinch sensor during power close, the back door will reverse and return to the full open position immediately.

#### NOTE:

**If the pinch sensor is damaged or removed, the power close function will not operate.**



#### WARNING:

**There is a small distance immediately before the closed position that cannot be detected. Make sure that all passengers keep their hands, etc., clear from the back door opening before closing the back door.**

### Manual mode

If power operation is not available, the back door can be operated manually. Power operation may not be available if multiple obstacles have been detected in a single power cycle or if the battery voltage is low. When the power back door main switch is in the OFF position, the back door can be opened manually by pushing the back door opener switch. If the power back door opener switch is pushed during power open or close, the power operation will be canceled and the back door can be operated manually.

### AUTO CLOSURE (if equipped)

If the back door is pulled down to a partly open position, the back door will pull itself to the closed position.

**Do not apply excessive force when the auto closure is operating. Excessive force applied may cause the mechanism to malfunction.**



#### CAUTION:

- **The back door will automatically close from a partly open position. To avoid pinching, keep hands and fingers away from back door opening.**
- **Do not let children operate the back door.**

### BACK DOOR RELEASE LEVER

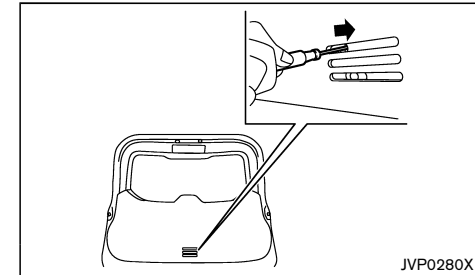

If the back door cannot be opened with the power door lock switch due to a discharged battery, follow these steps.

1. Fold the rear seats down. See "Seats" (P.1-2).
2. Insert a suitable tool in the access opening. Move the release lever to the right. The back door will be unlatched.

## 3-26 Pre-driving checks and adjustments



3. Push the back door up to open.

Contact a NISSAN dealer as soon as possible for repair.

### GARAGE MODE SYSTEM

The back door can be set to open to a specific height by performing the following:

1. Open the back door using the request switch or the Intelligent Key.
2. Pull the back door down to the desired position and hold the back door (the back door will have some resistance when being manually adjusted).
3. While holding the back door in position, press and hold the back door switch **(D)** located on the back door for approximately 3 seconds or until 2 beeps are heard.

The back door will open to the selected position setting. To change the position of the back door, repeat steps 1-3 for setting the position of the back door.

### **CAUTION:**

**Do not set the height of the back door below approximately 1/3 of the way to the floor using garage mode. Even if you set the height below approximately 1/3 of the way to the floor, the height will automatically be set to approximately 1/3 of the way to the floor.**

## FUEL FILLER LID

### **WARNING:**

- **Fuel is extremely flammable and highly explosive under certain conditions. You could be burned or seriously injured if it is misused or mishandled. Always stop the engine and do not smoke or allow open flames or sparks near the vehicle when refueling.**
- **Fuel may be under pressure. Turn the cap a half of a turn, and wait for any "hissing" sound to stop to prevent fuel from spraying out and possibly causing personal injury. Then remove the cap.**
- **Use only an original equipment type fuel filler cap as a replacement. It has a built-in safety valve needed for proper operation of the fuel system and emission control system. An incorrect cap can result in a serious malfunction and possible injury.**

### OPENING FUEL FILLER LID

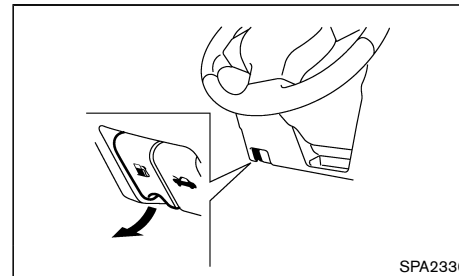

To open the fuel filler lid, pull the fuel filler lid release handle.

### FUEL FILLER CAP

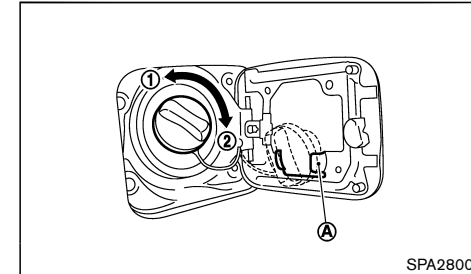

The fuel filler cap is a ratcheting type. Turn the cap counterclockwise **(1)** to remove. Tighten the cap clockwise **(2)** until ratchet clicks, more than twice, after refueling.

Put the fuel filler cap on the cap holder **(A)** while refueling.

### **CAUTION:**

**If fuel is spilled on the vehicle body, flush it away with water to avoid paint damage.**

## STEERING WHEEL

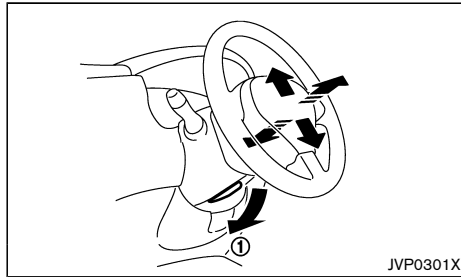

JVP0301X



### WARNING:

**Never adjust the steering wheel while driving so that full attention may be given to vehicle operation.**

Pull the lock lever ① down and adjust the steering wheel up, down, forward or rearward to the desired position. Push the lock lever up securely to lock the steering wheel in place.

## MIRRORS



### WARNING:

**Adjust the position of all mirrors before driving. Do not adjust the mirror positions while driving so that full attention may be given to vehicle operation.**

### INSIDE REARVIEW MIRROR

While holding the inside rearview mirror, adjust the mirror angles until the desired position is achieved.

### Manual anti-glare type

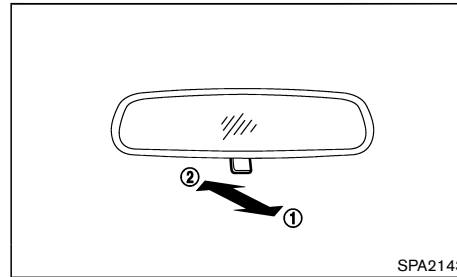

SPA2143

Pull the adjusting lever ① when the glare from the headlights of the vehicle behind you obstructs your vision at night.

Push the adjusting lever ② during the day for the best rearward visibility.

### Automatic anti-glare type

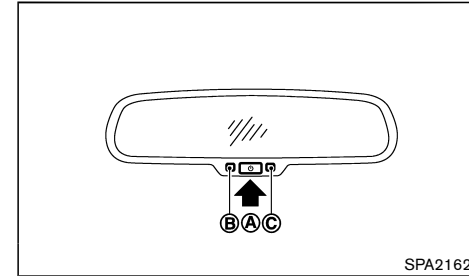

SPA2162

The inside rearview mirror is designed so that it automatically changes reflection according to the intensity of the headlights of the vehicle following you.

The anti-glare system will be automatically turned on when you place the ignition switch in the "ON" position.

When the system is turned on, the indicator light (B) will illuminate and excessive glare from the headlights of the vehicle behind you will be reduced.

Push the (A) switch for 3 seconds to make the inside rearview mirror operate normally and the indicator light will turn off. Push the (A) switch again for 3 seconds to turn the system on.

**Do not hang any objects on the mirror or apply glass cleaner. Doing so will reduce the sensitivity of the sensor (C), resulting in improper operation.**

## 3-28 Pre-driving checks and adjustments

## OUTSIDE REARVIEW MIRRORS

### **WARNING:**

- **Never touch the outside rearview mirrors while they are in motion. Doing so may pinch your fingers or damage the mirror.**
- **Never drive the vehicle with the outside rearview mirrors folded. This reduces rear view visibility and may lead to an accident.**
- **Objects viewed in the outside mirror are closer than they appear (if equipped).**
- **The picture dimensions and distance in the outside mirrors are not real.**

### Adjusting

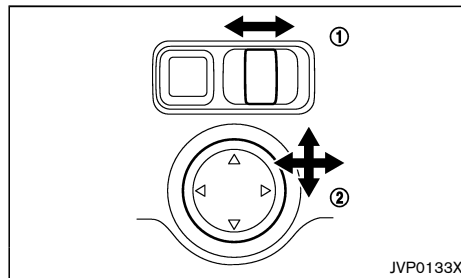

The outside rearview mirror remote control operates when the ignition switch is in the "ACC" or "ON" position.

1. Turn the switch to select the left or right mirror ①.
2. Adjust each mirror by pushing the switch until the desired position is achieved ②.

### Defogging (if equipped)

The outside rearview mirrors will be heated when the rear window defogger switch is operated.

### Folding

#### Remote control type:

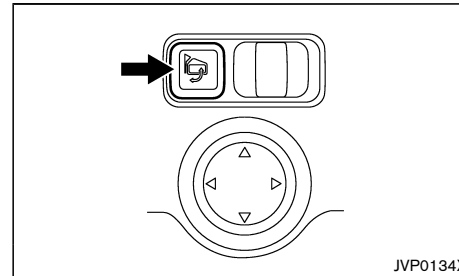

The outside rearview mirror remote control operates when the ignition switch is in the "ACC" or "ON" position.

The outside rearview mirrors automatically fold when the outside rearview mirror folding switch is pushed in. To unfold, push to the switch again.

### **CAUTION:**

**Continuously performing the fold/unfold operation of the outside rearview mirror may cause the switch to stop the operation.**

#### Manual control type:

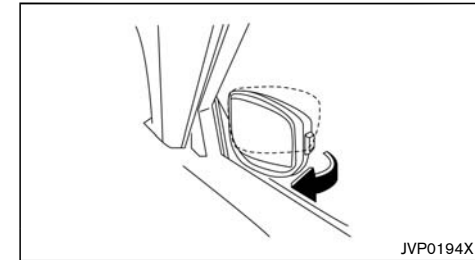

Fold the outside rearview mirror by pushing it toward the rear of the vehicle.

## VANITY MIRROR

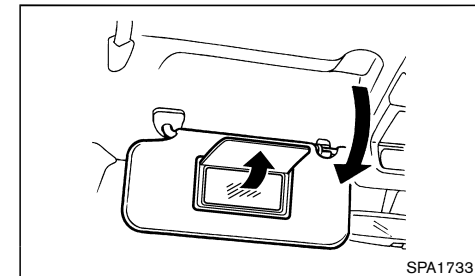

To use the front vanity mirror, pull down the sun visor and pull up the cover.

## PARKING BRAKE

### WARNING:

- Never drive the vehicle with the parking brake applied. The brake will overheat and fail to operate and will lead to an accident.
- Never release the parking brake from outside the vehicle. If the vehicle moves, it will be impossible to push the foot brake pedal and will lead to an accident.
- Never use the shift lever in place of the parking brake. When parking, be sure the parking brake is fully applied.
- Never leave children or adults who would normally require the support of others alone in your vehicle. They could unknowingly release the parking brake and inadvertently become involved in a serious accident.

### PEDAL TYPE

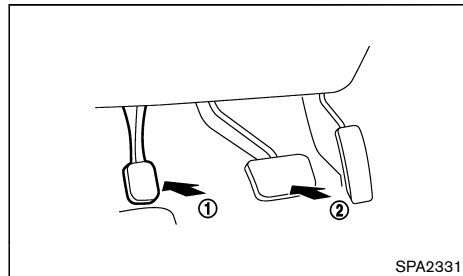

To apply the parking brake, firmly depress the parking brake pedal ①.

To release the parking brake, depress and hold the foot brake ② and then fully depress and release the parking brake pedal ①.

### 3-30 Pre-driving checks and adjustments

Before driving, be sure that the brake warning light has turned off.

SWITCH TYPE (models with electronic parking brake system)

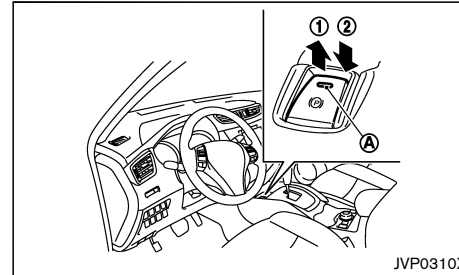

The electronic parking brake can be applied or released automatically or by operating the parking brake switch.

### Automatic operation

The electronic parking brake is automatically applied when the engine is turned off with the ignition switch (for MT model).

The electronic parking brake is automatically released as soon as the vehicle starts while the accelerator pedal is depressed.

For CVT model, the driver's seat belt needs to be fastened.

### WARNING:

- The electronic parking brake will not be automatically applied if the engine is stopped without using the ignition switch (for example, by engine stalling).

- Before leaving the vehicle, move the shift lever to the "1" (1st) or "R" (Reverse) position (for MT model) or "P" (Park) position (CVT model) and check that the electronic parking brake warning light  is illuminated to confirm that the electronic parking brake is applied. The electronic parking brake warning light will remain on for a period of time after the driver's door is locked.

### CAUTION:

When parking in an area where the outside temperature is below 0 °C (32 °F), do not apply the parking brake to prevent it from freezing.

For safe parking, place the shift lever in the "1" (1st) or "R" (Reverse) position (for MT model) or "P" (Park) position (CVT model) and securely block the wheels.

### NOTE:

- To keep the electronic parking brake released after the engine is turned off, place the ignition switch in the "OFF" position, depress the brake pedal and push down the parking brake switch before opening the driver's door.
- If a malfunction occurs in the electric parking brake system (for example, due to battery discharge), contact a NISSAN dealer.

### Manual operation

The electronic parking brake will not be automatically applied if the engine is stopped without using the ignition switch (for example, by engine stalling). In such a case, you have to apply the parking brake manually.

**To apply:** Pull the switch up ①. The indicator light ④ will illuminate.

**To release:** With the ignition switch in the "ON" position, depress the brake pedal and push the switch down ②. The indicator light ④ will turn off.

Before driving, check that the electronic parking brake warning light ⑤ goes out. For additional information, see "Warning/indicator lights and audible reminders" (P.2-12).

#### NOTE:

- **A buzzer will sound if the vehicle is driven without releasing the parking brake. See "Audible reminders" (P.2-19).**
  - **While the electronic parking brake is applied or released, an operating sound is heard from the lower side of the rear seat. This is normal and does not indicate a malfunction.**
  - **When the electronic parking brake is frequently applied and released in a short period of time, the parking brake may not operate in order to prevent the parking brake system from overheating. If this occurs, operate the electronic parking brake switch again after waiting approximately 1 minute.**
  - **If the electronic parking brake must be applied while driving in an emergency, pull up and hold the parking brake switch. When you release the parking brake switch, the parking brake will be released.**
- **While pulling up the electronic parking brake switch during driving, the parking brake is applied and a chime sounds. The electronic parking brake warning light in the meter and in the parking brake switch illuminate. This does not indicate a malfunction. The electronic parking brake warning light in the meter and in the parking brake switch turn off when the parking brake is released.**
  - **When pulling the electronic parking brake switch up with the ignition switch in the "OFF" or "ACC" position, the parking brake switch indicator light will continue to illuminate for a short period of time.**

When towing a trailer (for Australia, New Zealand, South Africa and Europe)

Depending on the weight of the vehicle and trailer and the steepness of the slope, there may be a tendency for the vehicle to move backwards when starting from a standstill. When this occurs, you can use the parking brake switch in the same way as a conventional lever type parking brake.

Before starting on sloping roads when towing a trailer, be sure to read the following to prevent the vehicle from moving backward unintentionally.

1. Pull and hold the parking brake switch while depressing the accelerator pedal and engaging the clutch (MT models).
2. Release the parking brake switch as soon as the engine is delivering enough torque to the wheels.

**MEMO**

**3-32 Pre-driving checks and adjustments**

Condition: 'Except for China'

[ Edit: 2014/ 11/ 7 Model: T32-A ]

## 4 Display screen, heater and air conditioner, and audio system

Safety precautions .....	4-3	Manual air conditioner and heater (Type B) .....	4-30
Center multi-function control panel (models with navigation system) .....	4-3	Automatic air conditioner and heater (Type A) .....	4-32
How to use touch screen display .....	4-4	Automatic air conditioner and heater (Type B) .....	4-34
How to use brightness control/display on-off button .....	4-4	Servicing air conditioner .....	4-35
How to use ENTER/Scroll dial .....	4-4	Audio system (if equipped) .....	4-35
How to use BACK button .....	4-4	Audio operation precautions .....	4-35
Vehicle information and settings (models with navigation system) .....	4-5	Antenna .....	4-43
How to use INFO button .....	4-5	CD player/Radio (Type A) .....	4-44
How to use SETUP button .....	4-5	CD player/Radio (Type B) .....	4-52
RearView Monitor (if equipped) .....	4-7	CD player/Radio (Type C) .....	4-57
How to read displayed lines .....	4-7	CD player/Radio (Type D) .....	4-63
Difference between predictive and actual distances .....	4-8	CD player/Radio (Type E) .....	4-69
How to adjust the screen .....	4-9	NissanConnect App smartphone integration (if equipped) .....	4-74
Operating tips .....	4-10	USB (Universal Serial Bus) connection port .....	4-75
Around view monitor (if equipped) .....	4-10	AUX (auxiliary) input jack .....	4-75
Available views .....	4-11	Steering wheel mounted controls for audio (Type A) (if equipped) .....	4-76
Difference between predictive and actual distances .....	4-13	Steering wheel mounted controls for audio (Type B) (if equipped) .....	4-76
How to switch the display .....	4-14	Disc/USB memory care and cleaning .....	4-77
Camera aiding corner sensor function (if equipped) .....	4-15	Car phone or CB radio .....	4-77
Moving Object Detection (MOD) function (if equipped) .....	4-15	Bluetooth® Hands-Free Phone System (Type A) .....	4-78
Park Assist (PA) (if equipped) .....	4-17	Regulatory information .....	4-78
How to adjust the screen .....	4-24	Control buttons and microphone .....	4-78
Operating tips .....	4-25	Bluetooth® settings .....	4-79
Ventilators .....	4-25	Using the system .....	4-80
Center ventilators .....	4-25	General settings .....	4-83
Side ventilators .....	4-26	Bluetooth® Hands-Free Phone System (Type B) .....	4-84
Rear ventilators (if equipped) .....	4-26	Regulatory information .....	4-84
Heater and air conditioner .....	4-26	Using the system .....	4-84
Operating tips (for automatic air conditioner) .....	4-27	Bluetooth® settings .....	4-87
Manual air conditioner and heater (Type A) .....	4-28		

Bluetooth® Hands-Free Phone System (Type C) .....	4-87	Receiving a call .....	4-96
Regulatory information .....	4-88	During a call .....	4-96
Using the system .....	4-89	Ending a call .....	4-96
Bluetooth® settings .....	4-93	Text messaging (for Mexico) .....	4-96
Bluetooth® Hands-Free Phone System (Type D) .....	4-94	Bluetooth® settings .....	4-97
Regulatory information .....	4-95	Telephone setup .....	4-98
Control buttons and microphone .....	4-95	Voice Recognition system (if equipped) .....	4-98
Voice Commands (for Mexico) .....	4-95	Control buttons and microphone .....	4-98
Pairing procedure .....	4-96	Using the system .....	4-99
Phonebook .....	4-96	System features .....	4-99
Making a call .....	4-96	Voice commands .....	4-100
		Troubleshooting guide .....	4-101



## SAFETY PRECAUTIONS



### WARNING:

- Do not adjust the display controls, heater and air conditioner controls or audio controls while driving so that full attention may be given to vehicle operation.
- If you noticed any foreign objects entering the system hardware, spilled liquid on the system, or noticed smoke or fumes coming out from the system, or any other unusual operation is observed, stop using the system immediately and contact the nearest NISSAN dealer. Ignoring such conditions may lead to an accident, fire or electric shock.
- Do not disassemble or modify this system. If you do, it may lead to an accident, fire, or electric shock.



### CAUTION:

Do not use the system when the engine is not running for extended periods of time to prevent battery discharge.

## CENTER MULTI-FUNCTION CONTROL PANEL (models with navigation system)

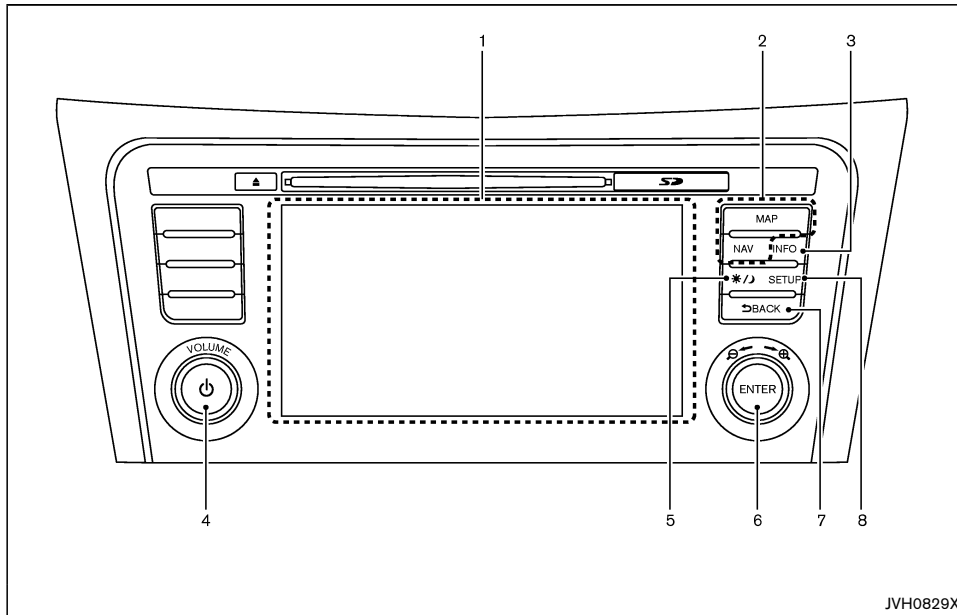

JVH0829X

1. Display screen (P.4-4)
2. For navigation system control buttons refer to the separate Navigation System Owner's Manual.
3. INFO button (P.4-5)
4. Power/VOLUME dial (P.4-70)
5. Brightness control/display on-off button (P.4-4)
6. ENTER/Scroll dial (P.4-4)
7. BACK button (P.4-4)
8. SETUP button (P.4-5)

Display screen, heater and air conditioner, and audio system 4-3

## HOW TO USE TOUCH SCREEN DISPLAY

### **WARNING:**

- **The glass display screen may break if it is hit with a hard or sharp object. If the glass screen breaks, do not touch it. Doing so could result in an injury.**
- **To clean the display, never use a rough cloth, alcohol, benzine, thinner or any kind of solvent or paper towel with a chemical cleaning agent. They will scratch or deteriorate the panel.**
- **Do not splash any liquid such as water or car fragrance on the display. Contact with liquid will cause the system to malfunction.**

To help ensure safe driving, some functions cannot be operated while driving.

The on-screen functions that are not available while driving will be “grayed out” or muted.

Park the vehicle in a safe location and then operate the navigation system.

### **CAUTION:**

- **ALWAYS give your full attention to driving.**
- **Avoid using vehicle features that could distract you. If distracted, you could lose control of your vehicle and cause an accident.**

## Touch screen operation

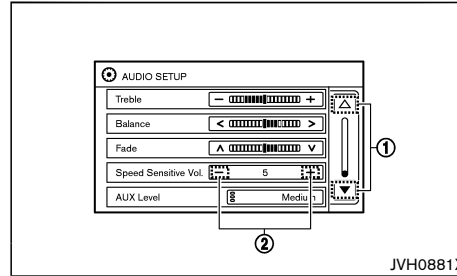

### Selecting items:

Touch an item to select. For example, to select the “Treble” key, touch the “Treble” key on the screen. Touch up/down arrow ① on the screen to display the previous or the next page.

### Adjusting items:

Touch the “+” or “-” ② key to adjust the settings of an item.

### Entering characters:

Touch the letter or number key on the keyboard screen. Options below are available when inputting characters.

- **123/ABC:**  
Changes the keyboard between numbers and alphabets.
- **Space:**  
Inserts a space.
- **Delete:**  
Deletes the last entered character with one touch. Touch and hold the “Delete” key to delete all of the characters.

### • **OK:**

Completes the character input.

### Touch screen maintenance

To clean the display screen, use a dry, soft cloth. If additional cleaning is necessary, use a small amount of neutral detergent with a soft cloth. Never spray the screen with water or detergent. Dampen the cloth first and then wipe the screen.

## HOW TO USE BRIGHTNESS CONTROL/ DISPLAY ON-OFF BUTTON

Push the brightness control/display on-off “☀/🌙” button to change the display brightness between day mode and night mode. While the mode is being displayed, the brightness can be adjusted using the scrolling dial.

Push and hold the brightness control/display on-off “☀/🌙” button for more than 2 seconds to turn the display off. Push the button again to turn the display on.

## HOW TO USE ENTER/SCROLL DIAL

Turn the ENTER/Scroll dial to select items on the screen and to adjust the levels of setting items. Push the dial to confirm the selected item or setting.

## HOW TO USE BACK BUTTON

Push the BACK button to return to the previous screen.

## 4-4 Display screen, heater and air conditioner, and audio system

## VEHICLE INFORMATION AND SETTINGS (models with navigation system)

Vehicle information can be checked and various settings can be adjusted on the display.

Designs and items displayed on the screen may vary depending on the models and specifications.

### HOW TO USE INFO BUTTON

Push the INFO button to display the following information on the display screen.

#### Available items:

- My Apps
- Traffic Messages (if equipped)
- Eco Score

#### My Apps

Some application services can be used with this system when linked to your smartphone. For details, see "NissanConnect App smartphone integration" (P.4-74).

#### Traffic Messages (if equipped)

Traffic Messages can be displayed on the display screen when available. Refer to the separate Navigation System Owner's Manual for details.

#### Eco Score

The Eco Score feature analyzes driving behavior and provides an overall score.

### HOW TO USE SETUP BUTTON

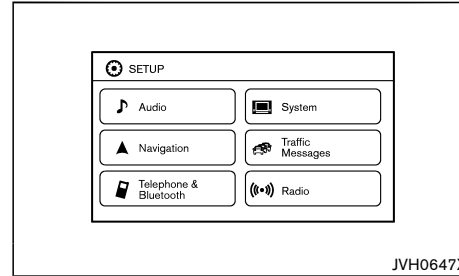

Example

Push the SETUP button to view and adjust the following setting items.

#### Available items:

- Audio
- Navigation
- Telephone & Bluetooth
- System
  - Display
  - Clock
  - Language
  - Camera Display Settings (if equipped)
  - Temperature Unit
  - Touch Click
  - Beep Tones
  - Factory Settings
  - Software Licenses (if equipped)
- Traffic Messages (if equipped)
- Radio (if equipped)

#### Audio settings

Audio settings can be adjusted from the audio setup screen.

1. Push the SETUP button.
2. Select the "Audio" key.
3. Select the item you wish to adjust.

#### Bass/Treble/Balance/Fade:

Touch the adjustment bar next to the corresponding keys on the display to adjust the tone quality and speaker balance.

The levels of these features can also be adjusted with the ENTER/Scroll dial. See "CD player/Radio (Type E)" (P.4-69) for audio operations.

#### Speed Sensitive Vol.:

Speed sensitive volume function increases the volume of the audio system as the speed of the vehicle increases. Choose the desired effect level from 0 (OFF) to 5. The higher the setting, the more the volume increases in relation to vehicle speed.

#### AUX Level:

This feature controls the volume level of incoming sound when an auxiliary device is connected to the system. Select the level from "Low (Quiet)", "Medium", and "High (Loud)".

#### Navigation settings

Navigation settings can be changed. See Navigation System Owner's Manual for details.

## Telephone & Bluetooth settings

Telephone & Bluetooth settings can be changed. See “Bluetooth® Hands-Free Phone System (Type D)” (P.4-94) for details.

## System settings

Various system settings can be adjusted from the system settings.

1. Push the SETUP button.
2. Select the “System” key.
3. Select the item you wish to adjust.

### Display:

Select the corresponding keys to adjust the settings.

- **Brightness:**  
Adjusts the brightness of the display.
- **Display Mode:**  
Adjusts to fit the level of lighting in the vehicle. Touch the “Display Mode” key to cycle through options of the mode (Day, Night and Auto).
- **Scroll Direction:**  
Adjusts the direction of the menu scroll. Choose either the up arrow or the down arrow.

### Clock:

Select the corresponding keys to adjust the settings.

- **Time Format:**  
The time setting can be selected from 12 hour and 24 hour formats.
- **Date Format:**  
The day, month and year display can be selected from five formats.
- **Clock Mode:**  
Select the clock mode from Manual, Time Zone and Auto.

When “Manual” is selected, you can set the clock mode manually from the “Set Clock Manually” screen.

Select “Auto” to automatically maintain the time using GPS.

- **Set Clock Manually:**  
Mode (AM/PM) (if equipped), Hours, Minutes, Day, Month and Year can be set manually if “Manual” is selected in the Clock Mode setting.
- **Daylight Savings Time:**  
Turns the daylight savings time on or off.
- **Time Zone:**  
Select the applicable time zone from the list.

### Language:

Select a language to be displayed on the screen.

### Camera Display Settings (if equipped):

See “Adjusting screen (for models with navigation system)” (P.4-9) or “How to adjust the screen” (P.4-24) for details.

### Temperature Unit:

Select the temperature unit from °C and °F.

### Touch Click:

Turns the touchscreen click feature on or off. When turned on, a click sound will be heard every time a key on the screen is touched.

### Beep Tones:

Turns the beep tones feature on or off. When turned on, a beep sound will be heard as a pop-up message appears on the screen.

### Factory Settings:

Select this key to return all settings to default.

### Software Licenses (if equipped):

Select this key to view software license information.

### Traffic Messages settings (if equipped)

Traffic information guidance, announcement and warning settings can be adjusted.

Traffic Announcement (TA) information can be received only in the area where the service is available.

### Radio settings (if equipped)

RDS (if equipped) and Traffic Announcement (TA) related settings can be turned on or off. When this item is turned on, the received traffic announcement information will be tuned to automatically when received.

Traffic Announcement (TA) information can be received only in the area where the service is available.

## 4-6 Display screen, heater and air conditioner, and audio system

## REARVIEW MONITOR (if equipped)

When the shift lever is shifted into the "R" (Reverse) position, the monitor display shows the view to the rear of the vehicle.

The system is designed as an aid to the driver in detecting large stationary objects to help avoid damaging the vehicle. The system will not detect small objects below the bumper and may not detect objects close to the bumper or on the ground.



### WARNING:

Failure to follow the warnings and instructions for proper use of the RearView Monitor could result in serious injury or death.

- The RearView Monitor is a convenience but it is not a substitute for proper backing. Always turn and look out the windows, and check mirrors to be sure that it is safe to move before operating the vehicle. Always back up slowly.
- The system is designed as an aid to the driver in showing large stationary objects directly behind the vehicle, to help avoid damaging the vehicle.
- The system cannot completely eliminate blind spots and may not show every object.
- Underneath the bumper and the corner areas of the bumper cannot be viewed on the RearView Monitor because of its monitoring range limitation. The system will not show small objects below the bumper, and may not show objects close to the bumper or on the ground.
- Objects viewed in the RearView Monitor differ from actual distance because a wide-angle lens is used.

- **Objects in the RearView Monitor will appear visually opposite than when viewed in the rear view and outside mirrors.**
- **Make sure that the back door is securely closed when backing up.**
- **Do not put anything on the rearview camera.**
- **When washing the vehicle with high pressure water, be sure not to spray it around the camera. Otherwise, water may enter the camera unit causing water condensation on the lens, a malfunction, fire or an electric shock.**
- **Do not strike the camera. It is a precision instrument. Otherwise, it may malfunction or cause damage resulting in a fire or an electric shock.**



### CAUTION:

Do not scratch the camera lens when cleaning dirt or snow from the lens.

### HOW TO READ DISPLAYED LINES

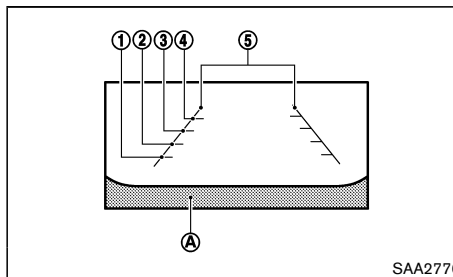

Guiding lines which indicate the vehicle width and

distances to objects with reference to the bumper line (A) are displayed on the monitor.

### Distance guide lines:

Indicate distances from the bumper.

- Red line ① : approx. 0.5 m (1.5 ft)
- Yellow line ② : approx. 1 m (3 ft)
- Green line ③ : approx. 2 m (7 ft)
- Green line ④ : approx. 3 m (10 ft)

### Vehicle width guide lines ⑤ :

Indicate the vehicle width when backing up.

### DIFFERENCE BETWEEN PREDICTIVE AND ACTUAL DISTANCES

#### Backing up on a steep uphill

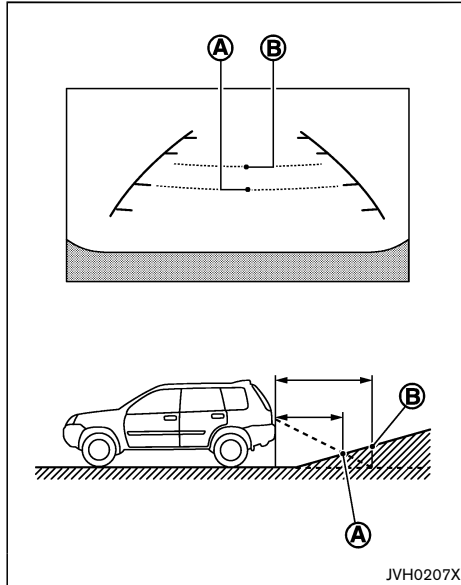

When backing up the vehicle up a hill, the distance guide lines and the vehicle width guide lines are shown closer than the actual distance. For example, the display shows 1 m (3 ft) to the place **(A)**, but the actual 1 m (3 ft) distance on the hill is the place **(B)**. Note that any object on the hill is further than it appears on the monitor.

#### Backing up on a steep downhill

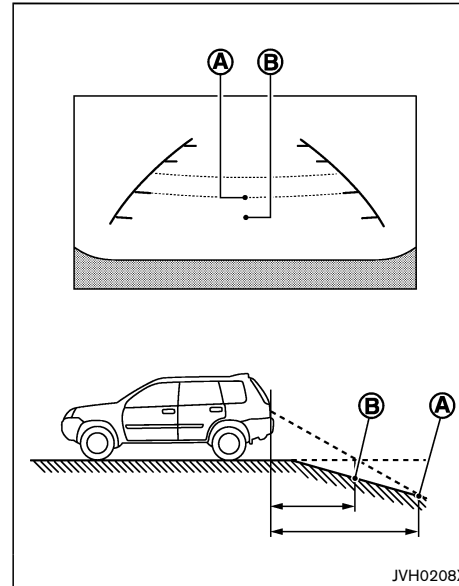

When backing up the vehicle down a hill, the distance guide lines and the vehicle width guide lines are shown further than the actual distance. For example, the display shows 1 m (3 ft) to the place **(A)**, but the actual 1 m (3 ft) distance on the hill is the place **(B)**. Note that any object on the hill is closer than it appears on the monitor.

#### Backing up near a projecting object

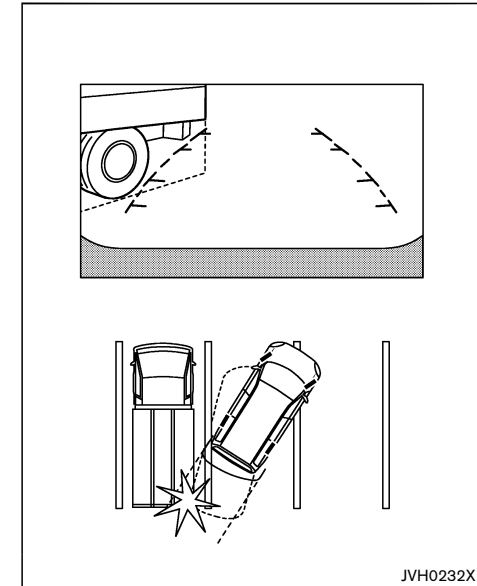

The vehicle may seem to nearly clear the object in the display. However, the vehicle may hit the object if it projects over the actual backing up course.

### 4-8 Display screen, heater and air conditioner, and audio system

### Backing up behind a projecting object

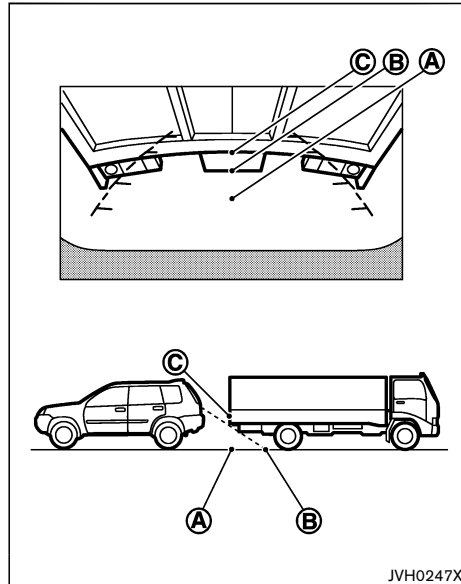

JVH0247X

The position **C** is shown further than the position **B** in the display. However, the position **C** is actually at the same distance as the position **A**. The vehicle may hit the object when backing up to the position **A** if the object projects over the actual backing up course.

### HOW TO ADJUST THE SCREEN

Adjusting screen (for models with navigation system)

#### Operation with touch screen:

1. Push the SETUP button.
2. Select the "System" key.
3. Select the "Camera Display Settings" key.
4. Select the item you wish to adjust.

#### • Display Mode:

Adjusts to fit the level of lighting in the vehicle. Touch the "Display Mode" key to cycle through options of the mode (Day, Night and Auto).

#### • Brightness:

Adjusts the brightness of the display.

#### • Contrast:

Adjusts the level of contrast.

#### • Color:

Adjusts the level of the color.

#### Operation with buttons:

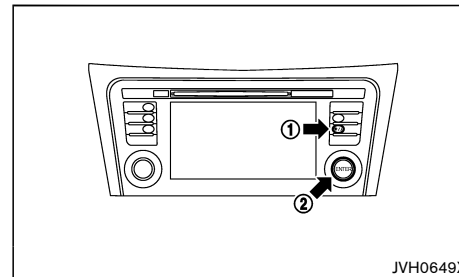

JVH0649X

To adjust the screen brightness when the RearView Monitor is displayed, push the brightness control/

display on-off  button **1**.

Adjust brightness to the preferred setting using the ENTER/Scroll dial **2**.

Adjusting screen (for models without navigation system)

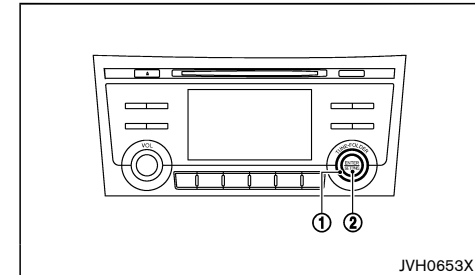

JVH0653X

1. Push the ENTER/SETTING button **2**.
2. Turn the TUNE-FOLDER dial **1** to highlight the "Brightness" or the "Contrast" key.
3. Push the ENTER/SETTING button **2**.
4. Adjust the level using the TUNE-FOLDER dial **1** and then push the ENTER/SETTING button **2** to apply the adjustment.

#### NOTE:

**Do not adjust the Brightness or Contrast of the RearView Monitor while the vehicle is moving.**

## AROUND VIEW MONITOR (if equipped)

### OPERATING TIPS

- When the shift lever is shifted to the "R" (Reverse) position, the monitor screen automatically changes to the RearView Monitor mode.
- When the view is switched, the display images on the screen may be displayed with some delay.
- When the temperature is extremely high or low, the screen may not clearly display objects. This is not a malfunction.
- When strong light is directly coming on the camera, objects may not be displayed clearly. This is not a malfunction.
- Vertical lines may be seen in objects on the screen. This is due to strong reflected light from the bumper. This is not a malfunction.
- The screen may flicker under fluorescent light. This is not a malfunction.
- The colors of objects on the RearView Monitor may differ somewhat from the actual color of objects. This is not a malfunction.
- Objects on the monitor may not be clear in a dark environment. This is not a malfunction.
- If dirt, rain or snow accumulates on the camera, the RearView Monitor may not display object clearly. Clean the camera.
- Do not use alcohol, benzene, or thinner to clean the camera. This will cause discoloration. To clean the camera, wipe with a cloth dampened with diluted mild cleaning agent and then wipe with a dry cloth.
- Do not damage the camera as the monitor screen may be adversely affected.
- Do not use wax on the camera window. Wipe off any wax with a clean cloth dampened with mild detergent diluted with water.

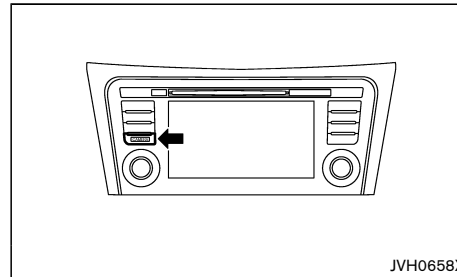

Models with navigation system

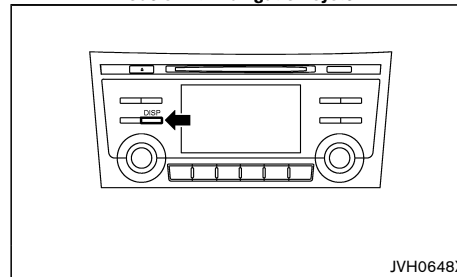

Models without navigation system

With the ignition switch in the ON position, push the CAMERA button (models with navigation system)/DISP button (models without navigation system) or move the shift lever to the "R" (Reverse) position to operate the Around View Monitor. The monitor displays various views of the position of the vehicle.

#### Available views:

- Bird's-eye View  
The surrounding view of the vehicle.
- Front-side View  
The view around and ahead of the front passenger's side wheel.

- Front View  
The view to the front of the vehicle.
- Rear View  
The view to the rear of the vehicle.

The system is designed as an aid to the driver in situations such as slot parking or parallel parking.

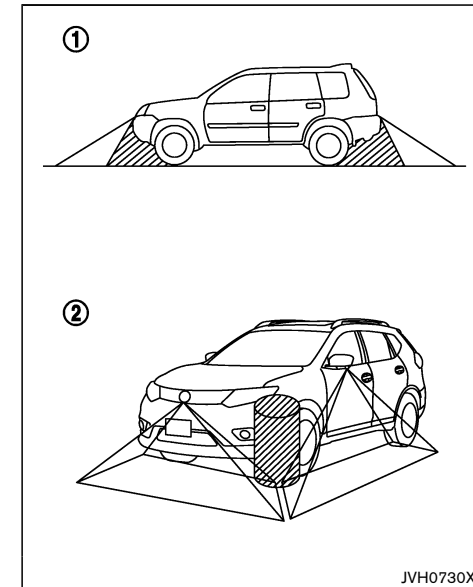

There are some areas where the system will not display objects. When in the front or the rear view display, an object below the bumper or on the ground may not be displayed ①. When in the bird's-eye view, a tall object near the seam of the camera detecting areas will not appear in the monitor ②.

## 4-10 Display screen, heater and air conditioner, and audio system



**WARNING:**

- The Around View Monitor is a convenient feature but it is not a substitute for proper vehicle operation because it has areas where objects cannot be viewed. Always look out the windows and check mirrors to be sure that it is safe to move.
- The driver is always responsible for safety during parking and other maneuvers.
- Do not use the Around View Monitor with the outside mirror in the stored position, and make sure that the back door is securely closed when operating the vehicle using the Around View Monitor.
- The distance between objects viewed on the Around View Monitor differs from the actual distance.
- The cameras are installed above the front grille, the outside mirrors and above the rear license plate. Do not put anything on the cameras.
- When washing the vehicle with high-pressure water, be sure not to spray it around the cameras. Otherwise, water may enter the camera unit causing water condensation on the lens, a malfunction, fire or an electric shock.
- Do not strike the cameras. They are precision instruments. Doing so could cause a malfunction or cause damage resulting in a fire or an electric shock.

**CAUTION:**

Clean the camera lens with soft cloth to keep it free from dirt, snow, etc. Do not scratch the lens when cleaning.

AVAILABLE VIEWS

**WARNING:**

- The distance guide line and the vehicle width line should be used as a reference only when the vehicle is on a paved, level surface. The distance viewed on the monitor is for reference only and may be different than the actual distance between the vehicle and displayed objects.
- Use the displayed lines and the bird's-eye view as a reference. The lines and the bird's-eye view are greatly affected by the number of occupants, fuel level, vehicle position, road condition and road grade.
- If the tires are replaced with different sized tires, the predictive course line and the bird's-eye view may be displayed incorrectly.
- When driving the vehicle up a hill, objects viewed in the monitor are further than they appear. When driving the vehicle down a hill, objects viewed in the monitor are closer than they appear.
- Use the mirrors or actually look to properly judge distances to other objects.
- The vehicle width and predictive course lines are wider than the actual width and course.

Front and rear view

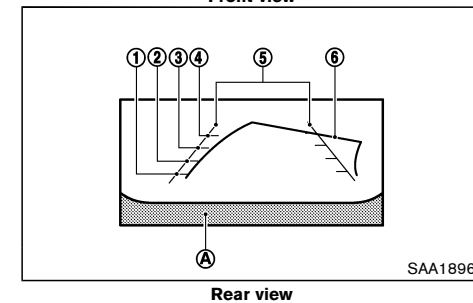
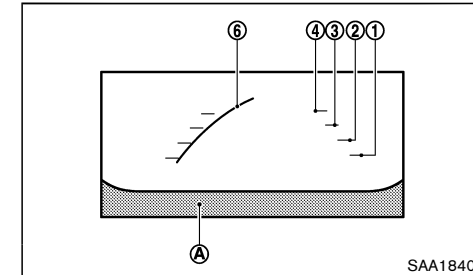

Guiding lines, which indicate the vehicle width and distances to objects with reference to the vehicle body line (A), are displayed on the monitor.

**Distance guide lines:**

Indicate distances from the vehicle body.

- Red line ① : approx. 0.5 m (1.5 ft)
- Yellow line ② : approx. 1 m (3 ft)
- Green line ③ : approx. 2 m (7 ft)
- Green line ④ : approx. 3 m (10 ft)

**Vehicle width guide lines ⑤ :**

Indicate the vehicle width when backing up.

**Predictive course lines ⑥ :**

Indicate the predictive course when operating the vehicle. The predictive course lines will be displayed on the monitor when the steering wheel is turned. The predictive course lines will move depending on how much the steering wheel is turned and will not be displayed while the steering wheel is in the straight ahead position.

The front view will not be displayed when the vehicle speed is above 10 km/h (6 MPH).

**WARNING:**

- **The distance between objects viewed in the rear view may differ from the actual distance. Objects in the rear view will appear visually opposite from those viewed in the inside and outside mirrors.**
- **On a snow-covered or slippery road, there may be a difference between the predictive course line and the actual course line.**
- **The displayed lines on the rear view will appear slightly off to the right because the rear view camera is not installed in the rear center of the vehicle.**

**NOTE:**

**When the monitor displays the front view and the steering wheel turns about 90 degrees or less from the neutral position, both the right and left predictive course lines ⑥ are displayed. When the steering wheel turns about 90 degrees or more, a predictive course line is displayed only on the opposite side of the turn.**

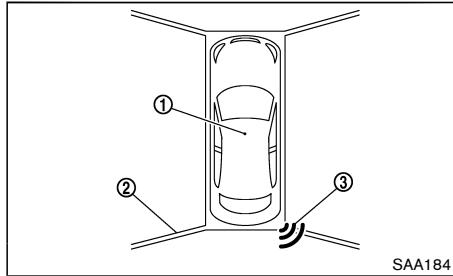
**4-12 Display screen, heater and air conditioner, and audio system****Bird's-eye view**

The bird's-eye view shows the overhead view of the vehicle which helps confirm the vehicle position and the predicted course to a parking space.

The vehicle icon ① shows the position of the vehicle. Note that the distance between objects viewed in the bird's-eye view differs from the actual distance.

The areas that the cameras cannot cover ② are indicated in black.

After the ignition switch is placed in the "ON" position, the nonviewable area ② is highlighted in yellow for 3 seconds after the bird's-eye view is displayed.

When the corner of the vehicle moves closer to an object, the corner sensor (sonar) indicators ③ (if equipped) appear. See "Parking sensor (sonar) system" (P.5-50) for more information.

**WARNING:**

- **Objects in the bird's-eye view will appear further than the actual distance because the bird's-eye view is a pseudo view that is processed by combining the views from the cameras on the outside mirrors, the front and the rear of the vehicle.**

- **Tall objects, such as a curb or vehicle, may be misaligned or not displayed at the seam of the views.**
- **Objects that are above the camera cannot be displayed.**
- **The view for the bird's-eye view may be misaligned when the camera position alters.**
- **A line on the ground may be misaligned and is not seen as being straight at the seam of the views. The misalignment will increase as the line proceeds away from the vehicle.**

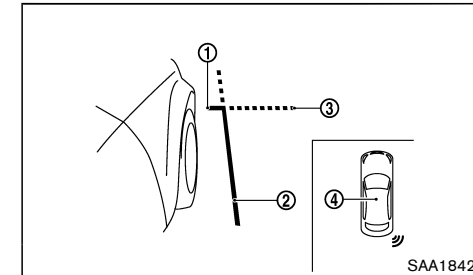
**Front-side view****Guiding lines:**

Guiding lines that indicate the width and the front end of the vehicle are displayed on the monitor.

The front-of-vehicle line ① shows the front part of the vehicle.

The side-of-vehicle line ② shows the vehicle width including the outside mirrors.

The extensions ③ of both the front ① and side ② lines are shown with a green dotted line.

The corner sensor (sonar) indicator ④ (if equipped)

will appear when a corner of the vehicle moves closer to an object. The corner sensor (sonar) indicator ④ (if equipped) can be turned off when the Front Sensor setting is turned off on the vehicle information display. See "Driver Assistance" (P.2-21).

**CAUTION:**

- Do not scratch the camera lens when cleaning dirt or snow.
- The turn signal light may overlap with the side-of-vehicle line. This is not a malfunction.

**DIFFERENCE BETWEEN PREDICTIVE AND ACTUAL DISTANCES**

**Backing up on a steep uphill**

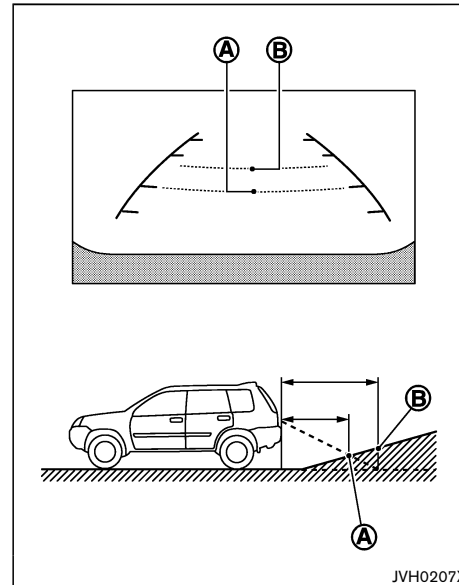

When backing up the vehicle up a hill, the distance guide lines and the vehicle width guide lines are shown closer than the actual distance. For example, the display shows 1 m (3 ft) to the place ①, but the actual 1 m (3 ft) distance on the hill is the place ②. Note that any object on the hill is viewed in the monitor further than it appears.

**Backing up on a steep downhill**

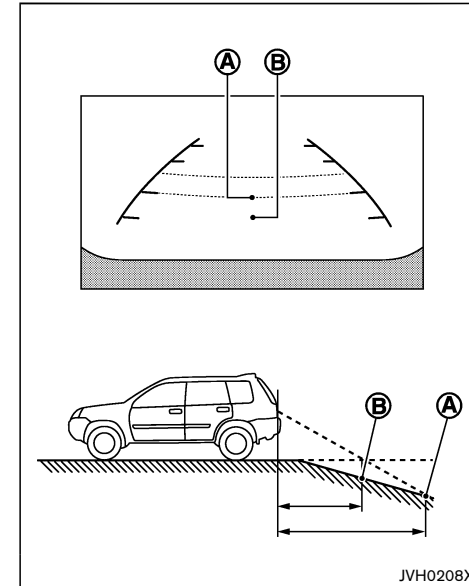

When backing up the vehicle down a hill, the distance guide lines and the vehicle width guide lines are shown further than the actual distance. For example, the display shows 1 m (3 ft) to the place ①, but the actual 1 m (3 ft) distance on the hill is the place ②. Note that any object on the hill is viewed in the monitor closer than it appears.

### Backing up near a projecting object

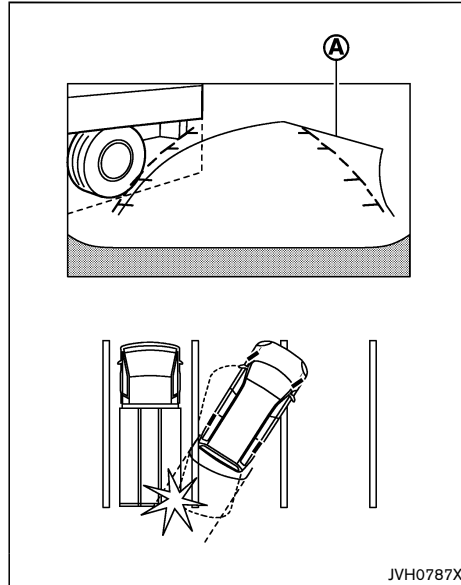

The predictive course lines (A) do not touch the object on the display. However, the vehicle may hit the object if it projects over the actual moving course.

### Backing up behind a projecting object

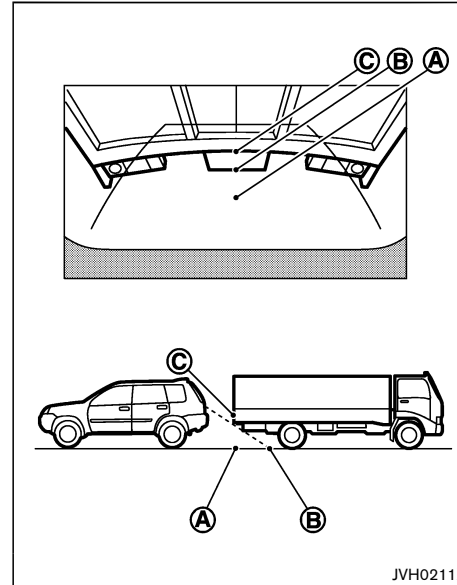

The position (C) is shown further than the position (B) in the display. However, the position (C) is actually at the same distance as the position (A). The vehicle may hit the object when backing up to the position (A) if the object projects over the actual moving course.

### HOW TO SWITCH THE DISPLAY

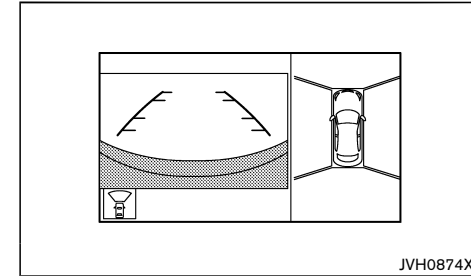

With the ignition switch in the "ON" position, push the CAMERA/DISP button or move the shift lever to the "R" (Reverse) position to operate the Around View Monitor.

The Around View Monitor can display two split views. If the shift lever is not in the "R" (Reverse) position, the available views are:

- Front view/bird's-eye view split screen
- Front view/front-side view split screen

If the shift lever is in the "R" (Reverse) position, the available views are:

- Rear view/bird's-eye view split screen
- Rear view/front-side view split screen
- Rear view (if equipped)

The display automatically changes to the Around View Monitor displaying front view/bird's-eye view when:

- The shift lever is in the "D" (Drive) position (CVT model) or the shift lever is out of the "R" (Reverse) position (MT model), and the parking sensor (sonar) (if equipped) detects that the vehicle is approaching an object.

The display will switch back to the previously displayed

## 4-14 Display screen, heater and air conditioner, and audio system

screen from the Around View Monitor screen when:

- The shift lever is in the “D” (Drive) position (CVT model) or the shift lever is out of the “R” (Reverse) position (MT model), and the vehicle speed increases above approximately 10 km/h (6 MPH).
- A different screen is selected.

### CAMERA AIDING CORNER SENSOR FUNCTION (if equipped)

When the corner of the vehicle moves closer to the object while the Around View Monitor is displayed, an indicator is displayed and a tone is sounded by the corner sensor function to warn the driver.

The color of the corner sensor indicator and the pattern of the tone vary according to the distance to the object.

Keep the corner sensors (located on the front and rear bumper fascia) free from snow, ice and large accumulations of dirt. Do not clean the sensors with sharp objects. If the sensors are covered, the accuracy of the corner sensor function will be diminished.

The tone sound and the sensor indicator display can be turn on/off, and the volume of the tone sound and the sensor detection range can be adjusted. (See “Driver Assistance” (P.2-21).)



#### WARNING:

- **The corner sensor function is not designed to prevent the object.**
- **The colors of the corner sensor indicator and the distance guide lines in the front/rear view indicate different distances to the object.**
- **Inclement weather may affect the function of the corner sensor system; this may include**

**reduced performance or a false activation.**

- **This function is designed as an aid to the driver in detecting large stationary objects to help avoid damaging the vehicle. The system will not detect small objects below the bumper, and may not detect objects that are too close to the bumper or on the ground.**
- **If your vehicle sustains damage to the bumper fascia, leaving it misaligned or bent, the sensing zone may be altered causing inaccurate measurement of obstacles or false alarms.**



#### CAUTION:

**Keep the interior of the vehicle as quiet as possible to hear the tone clearly.**

### MOVING OBJECT DETECTION (MOD) FUNCTION (if equipped)

The Moving Object Detection (MOD) system can inform the driver of moving objects when driving out of garages, maneuvering into parking lots and in other such instances.

The MOD system detects moving objects by using image processing technology on the image shown on the display. The rear view camera is equipped with the automatic washer function using window washer fluid.

The MOD system operates in the following conditions when the camera view is displayed:

- When the shift lever is in the “P” (Park) or “N” (Neutral) position (CVT model) or the shift lever is out of the “R” (Reverse) position (MT model) and the vehicle is stopped, the MOD system detects the moving objects in the bird’s-eye view. The

MOD system will not operate if the outside mirror is moving in or out or if either door is opened.

- When the shift lever is in the “D” (Drive) position (CVT model) or the shift lever is out of the “R” (Reverse) position (MT model), and the vehicle speed is below approximately 8 km/h (5 MPH), the MOD system detects moving objects in the front view.
- When the shift lever is in the “R” (Reverse) position and the vehicle speed is below approximately 8 km/h (5 MPH), the MOD system detects moving objects in the rear view. The MOD system will not operate if the back door is open.

The MOD system does not detect moving objects in the front-side view. The MOD icon is not displayed on the screen when in this view.



#### WARNING:

- **The MOD system is not a substitute for proper vehicle operation and does not prevent contact with the objects surrounding the vehicle. When maneuvering, always use the outside mirror and inside rearview mirror and turn and look to check the surroundings to make sure it is safe to maneuver.**
- **The system is deactivated at speeds above 10 km/h (6 MPH). It is reactivated at lower speeds.**
- **The system is not designed to prevent contact with all objects.**
- **The MOD system is not designed to detect surrounding stationary objects.**

When the MOD system detects a moving object surrounding the vehicle, the yellow frame will be displayed on the view where the objects are detected

Display screen, heater and air conditioner, and audio system 4-15

and a chime will sound once. While the MOD system continues to detect moving objects, the yellow frame continues to be displayed.

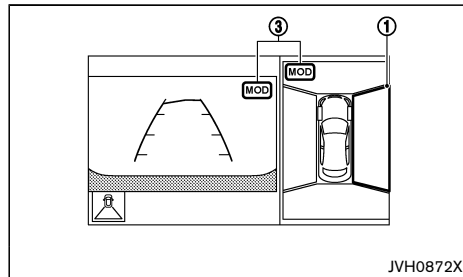

bird's-eye view

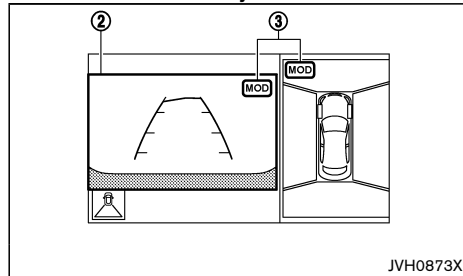

front view / rear view

In the bird's-eye view, the yellow frame ① is displayed on each camera image (front, rear, right, left) depending on where moving objects are detected.

The yellow frame ② is displayed on view in the front view or rear view modes.

While the sensor is beeping, the MOD system does not chime.

The MOD icon ③ is displayed in blue in the view where the MOD system is operative. The MOD icon

③ is displayed in gray in the view where the MOD system is not operative.

If the MOD system is turned off, the MOD icon ③ is not displayed.

The MOD system will activate automatically under the following conditions:

- When the shift lever is in the "R" (Reverse) position.
- When the CAMERA/DISP button is pushed to switch from a different screen to the camera view on the display.
- When vehicle speed decreases below approximately 8 km/h (5 MPH).
- When the ignition switch is placed in the "OFF" position and then back to the "ON" position.

The MOD system can be set to remain inactive in the vehicle information display. (See "Driver Assistance" (P.2-21).)

**WARNING:**

- **Excessive noise (for example, audio system volume or open vehicle window) will interfere with the chime sound, and it may not be heard.**
- **The MOD system performance will be limited according to environmental conditions and surrounding objects such as:**
  - When there is low contrast between background and the moving objects.
  - When there is blinking source of light.
  - When strong light such as another vehicle's headlight or sunlight is present.

– When there is dirt, water drops or snow on the camera lens.

– When the position of the moving objects in the display is not changed.

- The MOD system might detect flowing water droplets on the camera lens, white smoke from the muffler, moving shadows, etc.
- The MOD system may not function properly depending on the speed, direction, distance or shape of the moving objects.
- If your vehicle sustains damage to the parts where the camera is installed, leaving it misaligned or bent, the sensing zone may be altered and the MOD system may not detect objects properly.
- When the temperature is extremely high or low, the screen may not display objects clearly. This is not a malfunction.

Turning the MOD system on or off

The MOD system is turned on or off using the vehicle information display. See "Driver Assistance" (P.2-21).

MOD malfunction

When the orange MOD icon is displayed in the view, the system is not functioning properly. This will not hinder normal driving operation but the system should be inspected by a NISSAN dealer.

#### 4-16 Display screen, heater and air conditioner, and audio system

### Camera maintenance

If dirt, rain or snow accumulates on the camera, the MOD system may not operate properly. Clean the camera.

The camera washer operates automatically when dirt is detected on the camera during driving. The washer then stops operation after a period of time.

### PARK ASSIST (PA) (if equipped)

Park Assist (PA) is designed to assist drivers with parallel and perpendicular parking.

This system will operate the steering wheel to park the vehicle in the parking space set by the driver on the bird's-eye view screen (perpendicular mode), or measured by parking sensors (sonar) in the left/right side of the front bumper (parallel mode). Screen guidance for the shift lever operation is also provided during the parking maneuvers.



#### WARNING:

- **PA is designed to support the driver's steering wheel operation in a parking lot. It does not automatically lower the vehicle speed or avoid contact with objects. As when performing ordinary parking maneuvers, always look out the windows and check with your own eyes to be sure that the surrounding and road conditions are safe for the maneuvers before operating the vehicle. Operate the vehicle slowly during the parking maneuvers. If the vehicle gets close to people or objects near the vehicle, avoid making contact by using the brakes and performing other maneuvers.**
- **Do not touch the spoke of the steering wheel while the PA is operating. It could**

**cause injuries to hands or fingers. Keep neckties, scarves, etc. away from the steering wheel since they may get entangled and cause unexpected accidents.**

### Parallel parking

#### Displayed keys and icons:

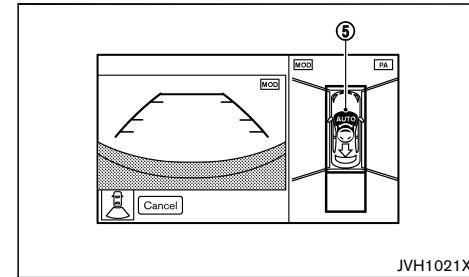
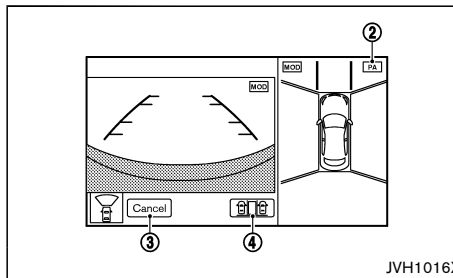
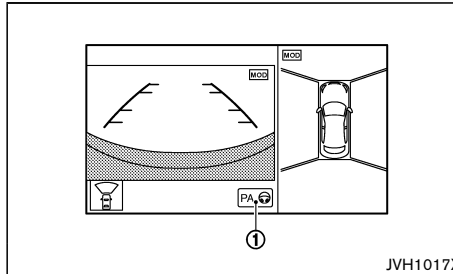

- ① **PA** :  
Touch this key to activate the PA system.
- ② **PA** :  
The green PA icon indicates that the PA is operating.
- ③ **Cancel** :  
Touch this key to cancel the PA operation.
- ④ :  
Touch this key to select perpendicular mode.
- ⑤ :  
Indicates that an automated steering control is operating.

### Parallel parking operation

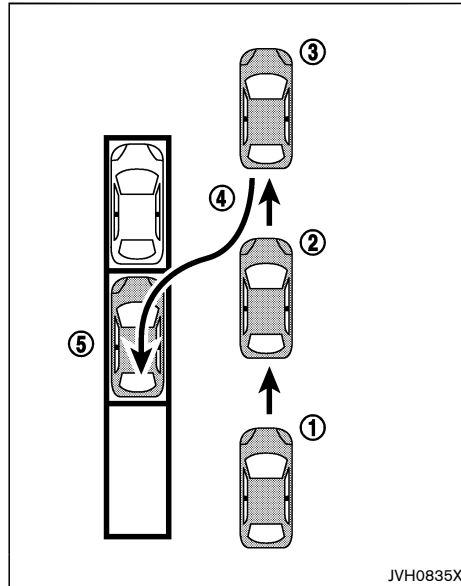

#### ① Starting the system:

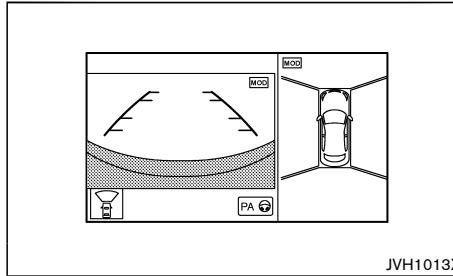

- Drive forward at reduced speed.
- Push the CAMERA button, and touch **PA** on the display.

#### NOTE:

- **At a vehicle speed over 30 km/h (19 MPH), the system will close and the display will disappear.**
- **If the bird's-eye view is not displayed on the front passenger side of the screen, push the CAMERA button until the bird's-eye view is displayed.**
- **At a vehicle speed over 10 km/h (6 MPH), the camera view will not display.**
- **Parallel parking mode is selected by default.**

#### ② Finding a parking space:

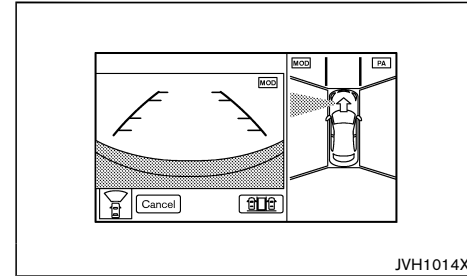

- Slowly move the vehicle forward, and the system will search for a parking space.
- The system will indicate that a parking space has been found.

#### NOTE:

- **Use the turn signal switch to select the preferred side for parking.**
- **The system cannot detect a parking space that is not bordered by objects such as vehicles.**

#### ③ Moving the vehicle forward:

Slowly move the vehicle forward further to the position for backing up, and then stop the vehicle completely. The system will provide guidance using chime, indicating that the vehicle has reached the proper position for starting the automatic steering operation.

### 4-18 Display screen, heater and air conditioner, and audio system



#### ④ Moving the vehicle backward:

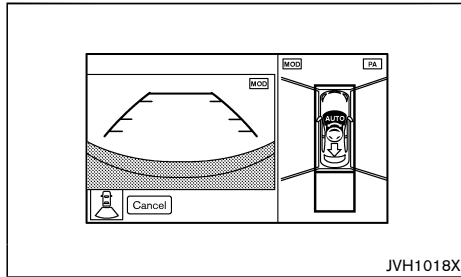

- Place the shift lever in the "R" (Reverse) position.
- Gently place hands on the steering wheel (the steering wheel will be operated automatically) and slowly move the vehicle in reverse into the parking space by moderating the amount of pressure you apply to the brake.
- Stop the vehicle completely when the vehicle reaches the proper position to change the movement direction. Then change the shift lever for forward or rearward movement. Repetitions of this operation may be required for aligning the vehicle straight.

#### NOTE:

- **The system will guide the vehicle to a position where a direction change is required.**
- **A warning chime will sound when the vehicle speed exceeds the speed limit for the PA operation.**

#### ⑤ Finishing the parking operation:

When the vehicle is positioned in the parking space, depress the brake and stop the vehicle. Touch the "Cancel" key to terminate the PA system.

#### NOTE:

- **Make any necessary adjustments manually and make turns in reverse as required. Depending on the situation, shift lever operations may be required several times for maneuvering the vehicle into the parking space.**
- **If the vehicle reaches the approximate area of the target parking space found, a chime will sound. A message indicating that the PA operation is finishing will appear on the display and the PA operation will terminate automatically.**

#### Deactivation of PA:





The PA will deactivate under the following conditions.

- When the steering wheel is operated manually.
- When the shift lever is placed in the "P" (Park) position (CVT model).
- When 5 seconds have passed since the shift lever was placed and kept in the "N" (Neutral) position.
- When the system judges that the conditions (such as worn out or low pressure tires, road conditions, etc.) are not suitable for correct course predictions.
- When the vehicle speed exceeds approximately 7 km/h (4 MPH).
- When the parking operation by the driver deviates from the PA guidance to some extent.

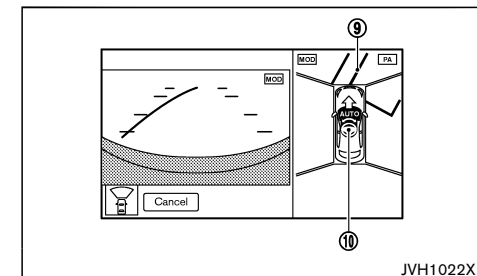
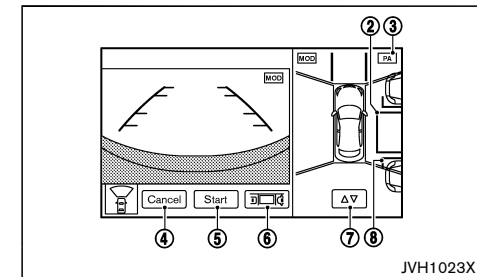
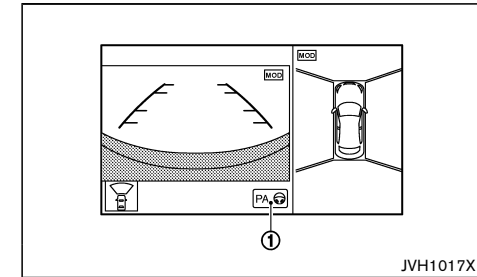
#### Perpendicular parking

#### Displayed keys and icons:



- ① : Touch this key to activate the PA system.
- ② Target parking rectangle (blue): Indicates the target parking position.
- ③ : The green PA icon indicates that the PA is operating.
- ④ Cancel: Touch this key to cancel the PA operation.
- ⑤ Start: Touch this key to start the PA operation.
- ⑥ : Touch this key to select the parallel mode.
- ⑦ : Touch this key to adjust the location of the target parking rectangle.
- ⑧ Clearance guidelines (red): Indicates an approximate space required for parking.
- ⑨ Reverse starting position rectangle (green): Indicates a position at which to make a turn in reverse.
- ⑩ : Indicates that an automated steering control is operating.

### Perpendicular parking operation

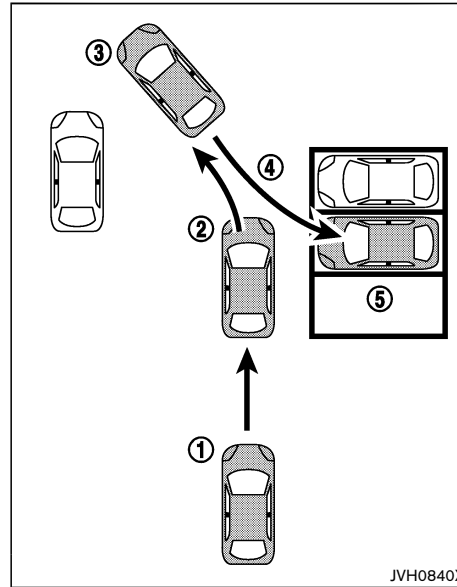

#### ① Starting the system and selecting parking mode:

1. Stop the vehicle near the space where you wish to park.
2. Push the CAMERA button and touch  on the display.

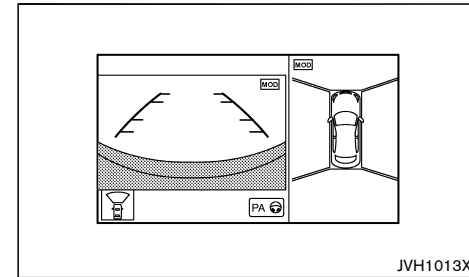

#### NOTE:

If the bird's-eye view is not displayed on the front passenger side of the screen, push the CAMERA button until the bird's-eye view is displayed.

3. Touch  to select the perpendicular parking mode.

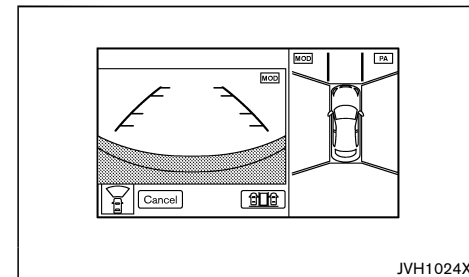

## 4-20 Display screen, heater and air conditioner, and audio system

## ② Setting the target parking position and starting the operation:

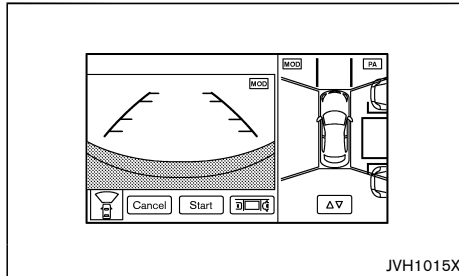

1. Slowly move the vehicle forward and stop approximately 1 m (3 ft) beside the parking space. Adjust the target parking rectangle (blue) position by touching  $\Delta V$ .

### NOTE:

- Use the turn signal switch to select a preferred side for parking.
- The target parking rectangle needs to be positioned near the actual parking space before fine adjustments can be made by touching  $\Delta V$ . The instructions for vehicle movement during the adjustment are as follows.
  - Check the position of the lines and rectangles with the actual parking space on the screen while the vehicle is not in motion.
  - Move the vehicle at a low speed while checking the surroundings for safety with your own eyes.

— Stop the vehicle again to make sure that the vehicle position is in the right place.

- Make sure that any objects are located outside the clearance guidelines (red). Otherwise, the vehicle may hit the objects during the maneuvers. Refer to the following examples.

### Example of perpendicular parking:

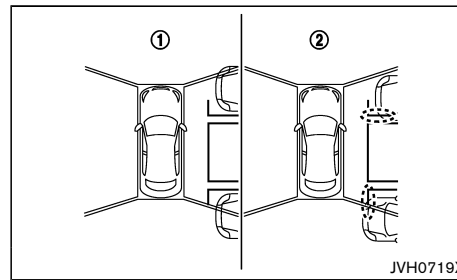

- ① : Good example  
② : Bad example

2. Touch the "Start" key on the screen.

The PA operation can be started when the following conditions are met.

- The vehicle is completely stopped.
- The steering wheel is in the straight position.
- The shift lever is in the positions for forward movement, such as "D" (Drive) position (CVT model) or "1" (1st) position (MT model).

## ③ Moving the vehicle forward:

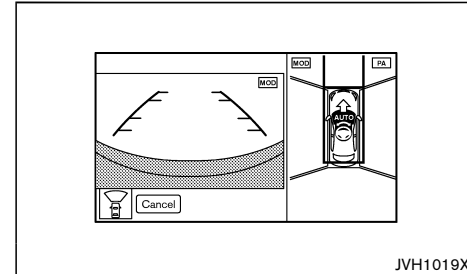

- Gently place hands on the steering wheel (the steering wheel will be operated automatically) and slowly move the vehicle forward to the reverse starting position rectangle (green) by moderating the amount of pressure you apply to the brake.
- Stop the vehicle completely when the vehicle reaches the reverse starting position rectangle (green).
- Depress the brake pedal and stop the vehicle completely when it approaches another vehicle or object, or when the vehicle reaches the reverse starting position.

### NOTE:

**A warning chime will sound when the vehicle speed exceeds the speed limit for the PA operation.**

#### ④ Moving the vehicle backward:

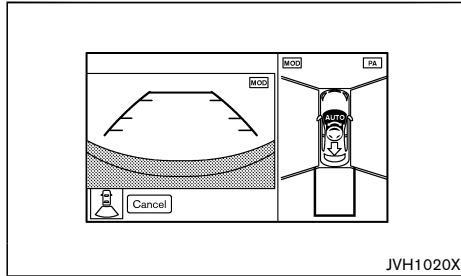

- Place the shift lever in the “R” (Reverse) position.
- Gently place hands on the steering wheel (the steering wheel will be operated automatically) and slowly move the vehicle in reverse into the parking space by moderating the amount of pressure you apply to the brake.

#### ⑤ Finishing the parking operation:

When the vehicle is positioned in the parking space, depress on the brake and stop the vehicle. Touch the “Cancel” key to terminate the PA system.

#### NOTE:

- **Make any necessary adjustments manually and make turns in reverse as required. Depending on the situation, shift lever operations may be required several times for maneuvering the vehicle into the parking space.**
- **If the vehicle reaches the approximate area of the target parking space, a chime will sound. A message indicating that the PA operation is ending will appear on the display and the system will terminate automatically.**

### 4-22 Display screen, heater and air conditioner, and audio system

#### Adjusting the target parking position:

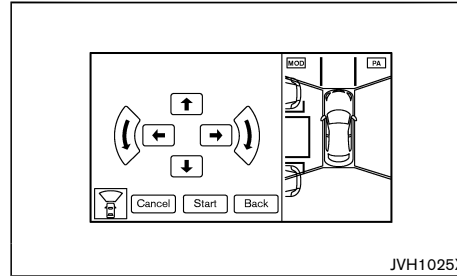

When setting a target parking position, you can make a fine adjustment of the target parking rectangle (blue) position.

1. Touch on the screen.

At parking lots with parking lines on the ground, the PA system will search for the lines and make fine adjustments automatically.

2. Touch the arrow on the screen for fine adjustments of the target parking rectangle (blue) position.

Fine adjustments may be required at parking lots without parking lines or when the automatic fine adjustments using the parking lines do not work.

Make sure that any objects are located outside the clearance guidelines (red).

#### Operating tips:

- When the target parking rectangle (blue) does not fit in the actual parking space following the correct procedure, check the surroundings and adjust the location of your vehicle.
- Up to approximately 70 cm (27 in) of fine adjustments can be made.

#### Deactivation of PA:

The PA will deactivate under the following conditions.

- When the steering wheel is operated manually.
- When the shift lever is placed in the “P” (Park) position (CVT model).
- When 5 seconds have passed since the shift lever was placed and kept in the “N” (Neutral) position.
- When reverse operations are conducted more than 10 times for steering corrections.
- When the system judges that the conditions (such as worn out or low pressure tires, road conditions, etc.) are not suitable for correct course predictions.
- When the vehicle backs up to a position behind the place from which PA operation started.
- When the vehicle passes the reverse starting position by over 2 m (7 ft).
- When the vehicle speed exceeds approximately 7 km/h (4 MPH).
- When the parking operation by the driver deviates from the PA guidance to some extent.

#### Safety notes



#### WARNING:

- **Do not drive looking only at the screen. It could cause unexpected accidents or cause the vehicle to contact surrounding objects.**
- **When assistance from the PA is no longer necessary, turn off the PA by touching the Cancel key on the screen. If the PA remains on, the steering wheel may operate automatically and may cause unexpected accidents.**

- Make sure that there is enough space for parking maneuvers before starting to use the PA.
- Keep in mind that the front of the vehicle may swing out towards oncoming traffic while the PA functions.



#### CAUTION:

Do not use the PA under the following conditions.

- On unpaved roads.
- On slippery roads such as snow-covered or frozen roads.
- On uneven roads with slants, bumps, curbstones, wheel tracks, etc.
- On curved roads.
- At mechanical parking facilities.
- Where parking or stopping is prohibited.
- When tire chains or a spare tire are installed.
- When the vehicle is being towed.
- When the doors (including the back door) are not closed.
- When transporting a load that protrudes from your vehicle.
- When the vehicle is laden with heavy loads.

#### NOTE:

- Under the conditions listed below, there may be instances in which surrounding objects or vehicles cut into the vehicle pathway, or when the vehicle cannot be parked in the correct spot following the PA operation, etc.

- When the shift lever is operated while driving.
- When sudden start, sudden stop or sudden operation of the shift lever occurs.
- When the tire pressure is too low or the tire is worn out.
- When tires are installed that are of a different size from the ones that were equipped at the time of factory shipment.
- When using the parallel parking mode, it is not always possible for the system to find an appropriate parking space and may indicate parking spaces that are not suitable for parking. Following are example conditions for which the system may not find a parking space correctly.
  - Parking spaces with objects located above the height range of parking sensors (sonars) (i.e., overhanging loads, tail sections or loading ramps of goods vehicles).
  - Parking spaces that are partially occupied by trailer drawbars.
  - Parking spaces that are littered or overgrown.
  - Parking spaces where a curb exists (causing damage of the wheels and tires).
  - Parking spaces that are blocked by foliage, grass, paving, blocks, etc.
  - Parking spaces bordered by an obstacle (i.e., a tree, a post or a trailer).
  - Parking spaces with objects that absorb ultrasonic waves such as fabric and snow.

- During snowfall or heavy rain.
- Near objects that emits ultrasonic waves such as horns of other vehicle, noise from a motorcycle engine and large automobile air brake, or sensors of surrounding vehicles.
- When the conditions surrounding the parking space change (i.e., another vehicle enters the target parking space after you pass it).

#### Operating tips:

- The parking sensor (sonar) will automatically turn on when the PA is activated. When the PA operation ends, the status of the parking sensor (sonar) will return to the mode that it was in before the PA was activated.
- Depending on the situation, the shift lever operations may be required several times.

#### Malfunction:

A warning message will be displayed and the system will terminate operation when a malfunction is detected in the PA.

When the warning message is displayed during the PA operation, park the vehicle in a safe place and restart the engine.

If the warning message is shown on the display repeatedly or if the PA cannot be operated after restarting the engine, this may indicate a system malfunction. It should not hinder normal driving, but the vehicle should be inspected by a NISSAN dealer.

## Maintenance

Refer to "Around view monitor" (P.4-10) for maintenance of the camera lens.

Blockages like dirt, ice, and objects such as stickers and accessories installed within the detection range of the parking sensor (sonar) may cause incorrect function of the PA. Clean the sensors regularly with care, and do not scratch or damage them.

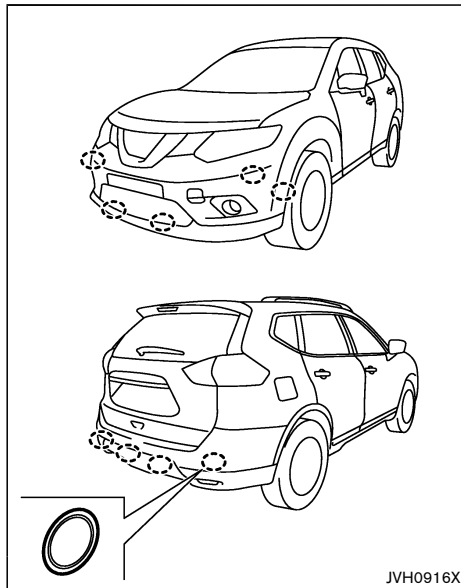

Parking sensors (sonar) are located on the bumpers: 6 on the front bumper and 4 on the rear bumper.

## HOW TO ADJUST THE SCREEN

Adjusting screen (for models with navigation system)

### Operation with touch screen:

1. Push the SETUP button.
2. Select the "System" key.
3. Select the "Camera Display Settings" key.
4. Select the item you wish to adjust.

### • Display Mode:

Adjusts to fit the level of lighting in the vehicle. Touch the "Display Mode" key to cycle through options of the mode (Day, Night and Auto).

### • Brightness:

Adjusts the brightness of the display.

### • Contrast:

Adjusts the level of contrast.

### • Color:

Adjusts the level of the color.

### Operation with buttons:

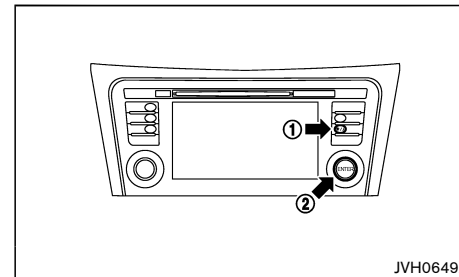

To adjust the screen brightness when the Around View Monitor is displayed, push the display control/display

on-off "☀/🌙" button ①.

Adjust brightness to the preferred setting using the ENTER/Scroll dial ②.

Adjust screen (for models without navigation system)

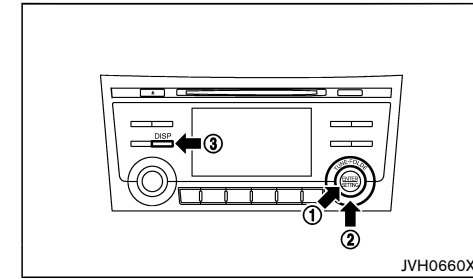

To set up the Around View Monitor to your preferred settings, push the ENTER/SETTING button ① while the Around View Monitor screen is displayed. Each time the ENTER/SETTING button ① is pushed, the next setting item is selected. Turn the TUNE-FOLDER dial ② to adjust each item.

Available setting items:

- Brightness
- Contrast

The setting items will disappear and the display will return to the original screen if ENTER/SETTING button ① is pushed when the last setting item is selected or if the screen is not operated for some time.

Choosing a language:

The warning message on the camera screen flashes when the DISP button ③ is pushed and held for more than 6 seconds. The language of the warning message changes when the DISP button ③ is pushed again

## 4-24 Display screen, heater and air conditioner, and audio system

while the warning message is flashing. When more than 6 seconds have elapsed with no operation, the warning message stops flashing and displays normally and the language is set.

## OPERATING TIPS



### CAUTION:

- **Do not use alcohol, benzine or thinner to clean the camera. This will cause discoloration. To clean the camera, wipe with a cloth dampened with a diluted mild cleaning agent and then wipe with a dry cloth.**
  - **Do not damage the camera as the monitor screen may be adversely affected.**
  - The screen displayed on the Around View Monitor will automatically return to the previous screen when no operation takes place for 3 minutes after the CAMERA button (models with navigation system)/DISP button (models without navigation system) has been pushed while the shift lever is in a position other than the "R" (Reverse) position.
  - The display of images on the screen may be delayed after screens are switched. Objects in the Around View Monitor may be distorted momentarily until the Around View Monitor screen is displayed completely.
  - When the temperature is extremely high or low, the screen may not display objects clearly. This is not a malfunction.
  - When strong light directly shines on the camera, objects may not be displayed clearly. This is not a malfunction.
  - The screen may flicker under fluorescent light. This is not a malfunction.
- The colors of objects on the Around View Monitor may differ somewhat from those of the actual object.
  - Objects on the monitor may not be clear and the color of the object may differ in a dark location or at night. This is not a malfunction.
  - There may be differences in clearness between each camera view of the bird's eye view.
  - If dirt, rain or snow attaches to the camera, the Around View Monitor may not display objects clearly. Clean the camera.
  - Do not use wax on the camera window. Wipe off any wax with a clean cloth that has been dampened with a mild detergent diluted with water.

## VENTILATORS

### CENTER VENTILATORS

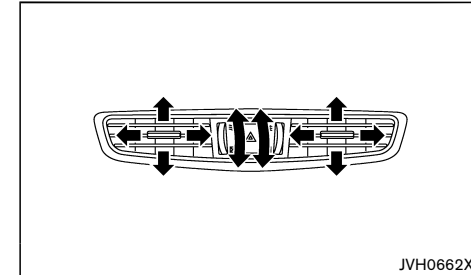

Open/close the vents by moving the control to either direction.

- ☰ : This symbol indicates that the vents are open. Moving the control to this direction will open the vents.
- ☒ : This symbol indicates that the vents are closed. Moving the control to this direction will close the vents.

Adjust the air flow direction of the ventilators by moving the center knob (up/down, left/right) until the desired position is achieved.

## SIDE VENTILATORS

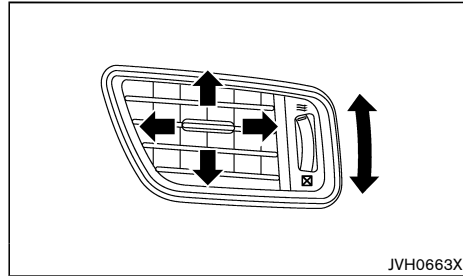

Open/close the vents by moving the control to either direction.

- ☰ : This symbol indicates that the vents are open. Moving the control to this direction will open the vents.
- ☒ : This symbol indicates that the vents are closed. Moving the control to this direction will close the vents.

Adjust the air flow direction of the ventilators by moving the center knob (up/down, left/right) until the desired position is achieved.

## REAR VENTILATORS (if equipped)

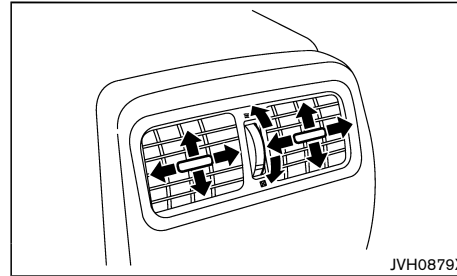

Open/close the vents by moving the control to either direction.

- ☰ : This symbol indicates that the vents are open. Moving the side control to this direction will open the vents.
- ☒ : This symbol indicates that the vents are closed. Moving the side control to this direction will close the vents.

Adjust the air flow direction of the ventilators by moving the center knob (up/down, left/right) until the desired position is achieved.

## HEATER AND AIR CONDITIONER

**WARNING:**

- The heater and air conditioner operate only when the engine is running.
- Never leave children or adults who would normally require the support of others alone in the vehicle. Pets should not be left alone either. They could unknowingly activate switches or controls and inadvertently become involved in a serious accident and injure themselves. On hot, sunny days, temperatures in a closed vehicle could quickly become high enough to cause severe or possibly fatal injuries to people or animals.
- Do not use the recirculation mode for long periods as it may cause the interior air to become stale and the windows to fog up.
- Do not adjust the heating and air conditioning controls while driving so that full attention may be given to vehicle operation.

The heater and air conditioner operate when the engine is running. The air blower will operate even if the engine is turned off and the ignition switch is placed in the "ON" position.

**NOTE:**

- Odors from inside and outside the vehicle can build up in the air conditioner unit. Odor can enter the passenger compartment through the vents.
- When parking, set the heater and air conditioner controls to turn off air recirculation to allow fresh air into the passenger compartment. This should help reduce odors inside the vehicle.

## 4-26 Display screen, heater and air conditioner, and audio system



**For models with Stop/Start System or Idling Stop System:**

While the engine is stopped by the Stop/Start System or the Idling Stop System, switching the airflow to the front defogger will cause the engine to automatically restart.

While the engine is running, selecting airflow to the front defogger will prevent the Stop/Start System or Idling Stop System from automatically stopping the engine.

When the engine is stopped by the Stop/Start System or Idling Stop System, heater and air conditioner performance may be reduced. To keep full heater and air conditioner performance, restart the engine by pushing the Stop/Start System OFF switch or the Idling Stop System OFF switch, or by placing the ignition switch in the "ON" position. For more details see "Stop/Start System or Idling Stop System" (P.5-18).

**OPERATING TIPS (for automatic air conditioner)**

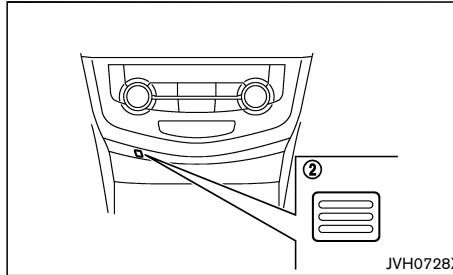
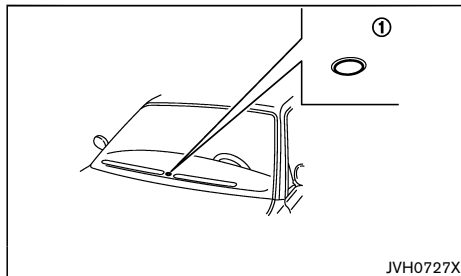

When the engine coolant temperature and outside air temperature are low, the air flow from the foot outlets may not operate. However, this is not a malfunction. After the coolant temperature warms up, the air flow from the foot outlets will operate normally.

The sensors ① and ②, located on the instrument panel, help maintain a constant temperature. Do not put anything on or around the sensors.

## MANUAL AIR CONDITIONER AND HEATER (Type A)

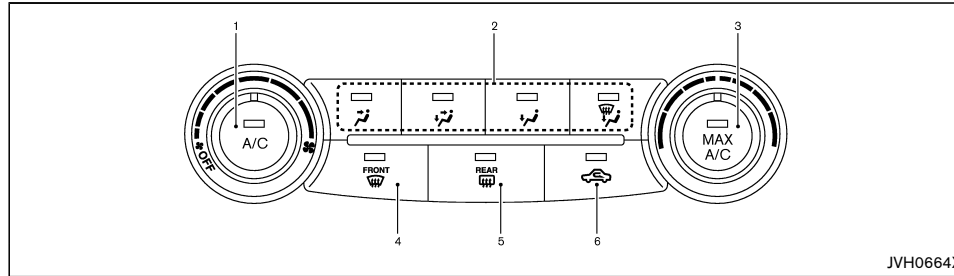

1. "A/C" button/Fan speed control " " dial
2. Air flow control buttons
3. "MAX A/C" button/Temperature control dial
4. Front defogger " " button
5. Rear defogger " " button (See "Defogger switch" (P.2-49).)
6. Air recirculation " " button

For models with Stop/Start System or Idling Stop System:

The Stop/Start System or Idling Stop System will not activate when the front defogger is turned on.

### Controls

#### Turning system on/off:

To turn on the system, turn the fan speed control " " dial out of the OFF position. Turn the dial counterclockwise to the OFF position to turn off the system.

#### Fan speed control:

Turn the fan speed control " " dial clockwise to increase the fan speed.

Turn the fan speed control " " dial counterclockwise to decrease the fan speed.

#### Temperature control:

Turn the temperature control dial to set the desired temperature. Turn the dial between the middle and the right position to select the hot temperature. Turn the dial between the middle and the left position to select the cool temperature.

#### Air flow control:

Push one of the air flow control buttons to select the air flow outlets.

- Air flows mainly from center and side ventilators.
- Air flows mainly from center and side ventilators and foot outlets.
- Air flows mainly from the foot outlet and partly from the defogger.
- Air flows mainly from the defogger and foot outlets.

#### Outside air circulation:

Push the air recirculation " " button. (The indicator light will turn off.) The air flow is drawn from outside the vehicle.

Select the outside air circulation mode for normal heating or air conditioning operation.

#### Air recirculation:

Push the air recirculation " " button on. (The indicator light will illuminate.)

The air will recirculate inside the vehicle.

#### A/C (Air Conditioner) operation:

Push the "A/C" button to turn on or off the air conditioner. When the air conditioner is on, the "A/C" indicator light on the button illuminates.

#### MAX A/C (Quick Air Conditioning) operation:

Push the "MAX A/C" button for quick cooling and dehumidifying.

When the MAX A/C mode is turned on, the air flow mode indicator will turn off with the air flow mode fixed at " ".

At the same time, the indicator light on the "A/C" button and the air recirculation mode will turn on.

## 4-28 Display screen, heater and air conditioner, and audio system

Push the "MAX A/C" button again to turn off the MAX A/C mode. When the MAX A/C mode is turned off, most of the settings will return to the previous state, while the indicator light on the "A/C" button will stay on.

### Heater operation

#### Heating:

This mode is used to direct heated air from the foot outlets.

1. Push the air recirculation "↻" button for normal heating. (The indicator light will turn off.)
2. Push the "🔥" button. (The indicator light will turn on.)
3. Turn the fan speed control "🌀" dial to the desired position.
4. Turn the temperature control dial to the desired position between the middle and the hot (right) position.

#### Ventilation:

This mode directs outside air from the side and center ventilators.

1. Push the air recirculation "↻" button. (The indicator light will turn off.)
2. Push the "🌬️" button. (The indicator light will turn on.)
3. Turn the fan speed control "🌀" dial to the desired position.
4. Turn the temperature control dial to the desired position.

#### Defrosting or defogging:

This mode directs the air to the defogger outlets to defrost/defog the windows.

1. Turn the fan speed control "🌀" dial to the desired position.
2. Push the air recirculation "↻" button. (The indicator light will turn off.)
3. Push the front defogger "🌫️" button. (The indicator light will turn on.)
4. Turn the temperature control dial to the desired position between the middle and the hot (right) position.

To remove frost from the windshield quickly, turn the temperature control dial to the maximum hot (right) position and the fan speed control "🌀" dial to the maximum position.

#### Heating and defogging:

This mode heats the interior and defogs the windows.

1. Push the air recirculation "↻" button. (The indicator light will turn off.)
2. Push the "🔥" button. (The indicator light will turn on.)
3. Turn the fan speed control "🌀" dial to the desired position.
4. Turn the temperature control dial to the maximum hot (right) position.

### Air conditioner operation

The air conditioner system should be operated for approximately 10 minutes at least once a month. This helps prevent damage to the air conditioner system due to the lack of lubrication.

#### Cooling:

This mode is used to cool and dehumidify the air.

1. Push the air recirculation "↻" button. (The indicator light will turn off.)
2. Push the "❄️" button. (The indicator light will turn on.)
3. Turn the fan speed control "🌀" dial to the desired position.
4. Push the "A/C" button. (The indicator light will turn on.)
5. Turn the temperature control dial to the desired position between the middle and the cool (left) position.

A visible mist may be seen coming from the ventilators in hot, humid conditions as the air is cooled rapidly. This does not indicate a malfunction.

#### Dehumidified heating:





This mode is used to heat and dehumidify the air.

1. Push the air recirculation "↻" button. (The indicator light will turn off.)
2. Push the "🔥" button. (The indicator light will turn on.)
3. Turn the fan speed control "🌀" dial to the desired position.
4. Push the "A/C" button. (The indicator light will turn on.)

- Turn the temperature control dial to the desired position between the middle and the hot (right) position.





#### Dehumidified defogging:

This mode is used to defog the windows and dehumidify the air.

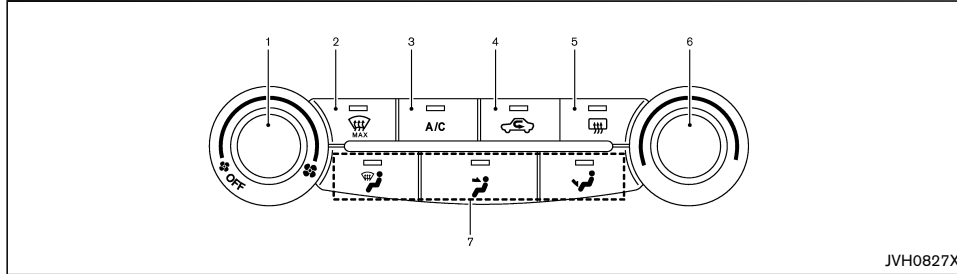
- Push the air recirculation “” button. (The indicator light will turn off.)
- Push the front defogger “” button. (The indicator light on the front defogger “” button will turn on.)
- Turn the fan speed control “” dial to the desired position.
- Turn the temperature control dial to the desired position.

#### MANUAL AIR CONDITIONER AND HEATER (Type B)



- Fan speed control “” dial
- Front defogger “ MAX” button
- “A/C” button
- Air recirculation “” button
- Rear window defogger “” button (See “Defogger switch” (P.2-49).)
- Temperature control dial
- Air flow control buttons

For models with Stop/Start System or Idling Stop System:

The Stop/Start System or Idling Stop System will not activate when the front defogger is turned on.

#### Controls

##### Turning system on/off:

To turn on the system, turn the fan speed control “” dial out of the OFF position. Turn the dial counterclockwise to the OFF position to turn off the system.

##### Fan speed control:

Turn the fan speed control “” dial clockwise to increase the fan speed.

Turn the fan speed control “” dial counterclockwise to decrease the fan speed.



##### Temperature control:

Turn the temperature control dial to set the desired temperature. Turn the dial between the middle and the right position to select the hot temperature. Turn the dial between the middle and the left position to select the cool temperature.



#### 4-30 Display screen, heater and air conditioner, and audio system

**Air flow control:**

Push the air flow control buttons to select the air flow outlets. More than one air flow control button can be selected at a time.

-  — Air flows mainly from center and side ventilators.
-  — Air flows mainly from the foot outlet.
-  — Air flows mainly from the front defogger.

**MAX defogging/defrosting:**

Push the front defogger “ MAX” button to turn on the MAX defogging/defrosting mode and quickly defog/defrost the windshield. When this mode is turned on, the “A/C” indicator light will turn on and the air circulation will be fixed at the outside air circulation mode. The “ ” indicator light will also turn on. For the best performance, turn the temperature control dial to the maximum hot position and set the fan speed at its maximum.

**Outside air circulation:**

Push the air recirculation “ ” button. (The indicator light will turn off.) The air flow is drawn from outside the vehicle.

Select the outside air circulation mode for normal heating or air conditioning operation.

**Air recirculation:**

Push the air recirculation “ ” button. (The indicator light will illuminate.)



The air will recirculate inside the vehicle.

**A/C (Air Conditioner) operation:**

Push the “A/C” button to turn on or off the air conditioner. When the air conditioner is on, the “A/C” indicator light on the button illuminates.



**Heater operation****Heating:**

This mode is used to direct heated air from the foot outlets.

1. Push the air recirculation “ ” button for normal heating. (The indicator light will turn off.)
2. Push the “ ” button. (The indicator light will turn on.)
3. Turn the fan speed control “ ” dial to the desired position.
4. Turn the temperature control dial to the desired position between the middle and the hot (right) position.



**Ventilation:**

This mode directs outside air from the side and center ventilators.

1. Push the air recirculation “ ” button. (The indicator light will turn off.)
2. Push the “ ” button. (The indicator light will turn on.)
3. Turn the fan speed control “ ” dial to the desired position.
4. Turn the temperature control dial to the desired position between the middle and the hot (right) position.

**Heating and defogging:**

This mode heats the interior and defogs the windows.

1. Push the air recirculation “ ” button. (The indicator light will turn off.)
2. Push the “ ” and “ ” buttons. (The indicator lights will turn on.)



3. Turn the fan speed control “ ” dial to the desired position.
4. Turn the temperature control dial to the desired position between the middle and the hot (right) position.

**Air conditioner operation**

The air conditioner system should be operated for approximately 10 minutes at least once a month. This helps prevent damage to the air conditioner system due to the lack of lubrication.

**Cooling:**



This mode is used to cool and dehumidify the air.

1. Push the air recirculation “ ” button. (The indicator light will turn off.)
2. Push the “ ” button. (The indicator light will turn on.)
3. Turn the fan speed control “ ” dial to the desired position.
4. Push the “A/C” button. (The indicator light will turn on.)
5. Turn the temperature control dial to the desired position between the middle and the cool (left) position.

A visible mist may be seen coming from the ventilators in hot, humid conditions as the air is cooled rapidly. This does not indicate a malfunction.

**Dehumidified heating:**





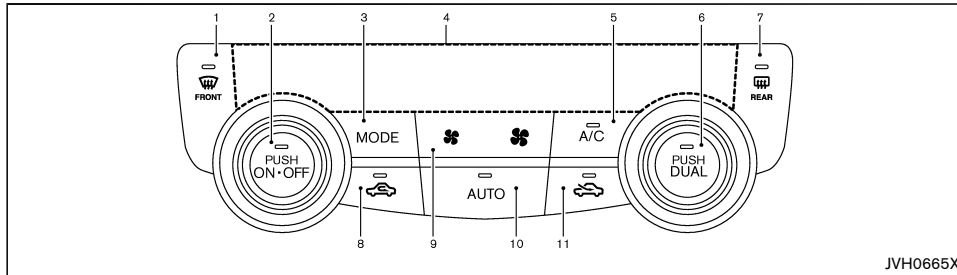

This mode is used to heat and dehumidify the air.

1. Push the air recirculation “ ” button. (The indicator light will turn off.)
2. Push the “ ” button. (The indicator light will turn on.)

3. Turn the fan speed control “” dial to the desired position.
4. Push the “A/C” button. (The indicator light will turn on.)
5. Turn the temperature control dial to the desired position between the middle and the hot (right) position.

### AUTOMATIC AIR CONDITIONER AND HEATER (Type A)



1. Front defogger “” button
2. “ON-OFF” button/Temperature control dial (for left side seat)
3. “MODE” button
4. Display screen
5. “A/C” (Air Conditioner) button
6. “DUAL” button/Temperature control dial (for right side seat)
7. Rear defogger “” button (See “Defogger switch” (P.2-49).)
8. Air recirculation “” button
9. Fan speed control “ ” button
10. “AUTO” button
11. Outside air circulation “” button

For models with Stop/Start System or Idling Stop System:

The Stop/Start System or Idling Stop System will not activate when the front defogger is turned on.

#### Turning the system on/off

Push the “ON-OFF” button to turn on and off the system.

#### Automatic operation (AUTO)

The AUTO mode may be used year-round as the system automatically controls the air conditioner to a constant temperature, air flow distribution and fan speed after the desired temperature is set manually.

#### Cooling and dehumidified heating:

1. Push the “AUTO” button (the indicator light will turn on).
2. Turn the temperature control dial to set the desired temperature.
  - When the DUAL indicator light is not illuminated, pushing the “DUAL” button (the indicator light will turn on) allows the user to independently change the driver and passenger side temperatures with the corresponding temperature control dial.
  - To cancel the separate temperature setting, push the “DUAL” button (the indicator light will

## 4-32 Display screen, heater and air conditioner, and audio system

turn off) and the driver's side temperature setting will be applied to both the driver and passenger sides.

3. Push and hold either the outside air circulation "↻" button or the air recirculation "↻" button to switch to the automatic air intake control mode.

A visible mist may be seen coming from the ventilators in hot, humid conditions as the air is cooled rapidly. This does not indicate a malfunction.

#### Dehumidified defrosting/defogging:

1. Push the front defogger "☁" button (The indicator light on the front defogger "☁" button will illuminate).
2. Turn the temperature control dial to set the desired temperature.
  - To quickly remove frost from the outside surface of the windshield, set the temperature control and the fan speed to the maximum levels.
  - After the windshield is cleared, push the "AUTO" button again (the AUTO indicator light will turn on).
  - When the front defogger "☁" button is pushed, the air conditioner will turn on when the outside air temperature is above approximately  $-2^{\circ}\text{C}$  ( $28^{\circ}\text{F}$ ) to defog the windshield. The air recirculation mode will automatically turn off. The outside air circulation mode "↻" will be selected to improve the defogging performance.

Do not set the temperature too low when the front defogger mode is on (the "☁" indicator light is illuminated), because doing so may fog up the windshield.

#### Manual operation

The manual mode can be used to control the heater and air conditioner to your desired settings.

To turn off the heater and air conditioner, push the "ON-OFF" button.

#### Fan speed control:

Push the fan speed control button ("☼" side or "☼" side) to manually control the fan speed.

Push the "AUTO" button to change the fan speed to the automatic mode.

#### Air flow control:

Push the "MODE" button to select the desired mode:

- ☼ — Air flows mainly from the center and side ventilators.
- ☼ — Air flows mainly from the center and side ventilators and foot outlets.
- ☼ — Air flows mainly from the foot outlet and partly from the defogger.
- ☼ — Air flows mainly from the front defogger outlets and foot outlets.

#### Temperature control:

Turn the temperature control dial to set the desired temperature.

- When the DUAL indicator light is not illuminated, pushing the "DUAL" button (the indicator light will turn on) allows the user to independently change the driver and passenger side temperatures with the corresponding temperature control dial.
- To cancel the separate temperature setting, push the "DUAL" button (the indicator light will turn off) and the driver's side temperature setting will be applied to both the driver and passenger sides.

#### Outside air circulation:

Push the outside air circulation "↻" button to draw the air flow from outside the vehicle. (The indicator light will turn on.)

#### Air recirculation:

Push the air recirculation "↻" button to circulate the air flow inside the vehicle. (The indicator light will turn on.)

#### Automatic air intake control:

Push and hold either the outside air circulation "↻" or the air recirculation "↻" button. The air intake will then be controlled automatically. When the automatic control is set, the system automatically alternates between the outside air circulation "↻" and the air recirculation "↻" modes. (The indicator light of the active mode will turn on.)

## AUTOMATIC AIR CONDITIONER AND HEATER (Type B)

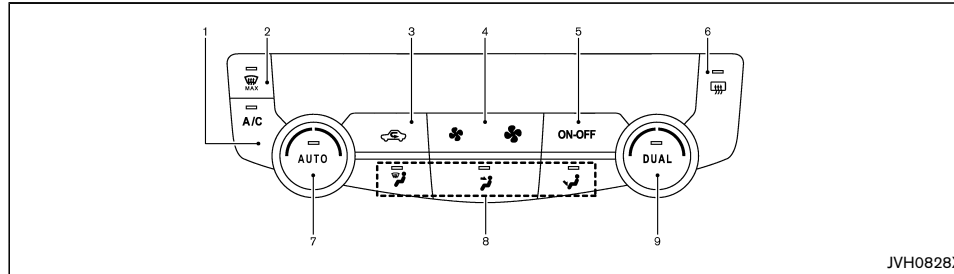

1. "A/C" (Air Conditioner) button
2. Front defogger "MAX" button
3. Air recirculation button
4. Fan speed control " " button
5. "ON-OFF" button
6. Rear defogger " " button (See "Defogger switch" (P.2-49).)
7. "AUTO" button/Temperature control dial (for left side seat)
8. Air flow control buttons
9. "DUAL" button/Temperature control dial (for right side seat)

For models with Stop/Start System or Idling Stop System:

The Stop/Start System or Idling Stop System will not activate when the front defogger is turned on.

### Turning the system on/off

Push the "ON-OFF" button to turn on and off the system.

### Automatic operation (AUTO)

The AUTO mode may be used year-round as the system automatically controls the air conditioner to a constant temperature, air flow distribution and fan speed after the desired temperature is set manually.

### Cooling and dehumidified heating:

1. Push the "AUTO" button (the indicator light will turn on).
2. Turn the temperature control dial to set the desired temperature.
  - When the DUAL indicator light is not illuminated, pushing the "DUAL" button (the indicator light will turn on) allows the user to independently change the driver and passenger side temperatures with the corresponding temperature control dial.
  - To cancel the separate temperature setting, push the "DUAL" button (the indicator light will

turn off) and the driver's side temperature setting will be applied to both the driver and passenger sides.

A visible mist may be seen coming from the ventilators in hot, humid conditions as the air is cooled rapidly. This does not indicate a malfunction.

### MAX defrosting/defogging:

Push the front defogger "MAX" button to turn on the MAX defogging/defrosting mode and quickly defog/defrost the windshield. When this mode is turned on, the fan will be at its maximum speed, the "A/C" indicator light will turn on, and the air circulation will be fixed at the outside air circulation mode.

Do not set the temperature too low when the front defogger mode is on (the "MAX" indicator light is illuminated), because doing so may fog up the windshield.

### Manual operation

The manual mode can be used to control the heater and air conditioner to your desired settings.

### Fan speed control:

Push the fan speed control button (" " side or " " side) to manually control the fan speed.

### Air flow control:

Push one of the air flow control buttons to select or deselect the air flow outlets. More than one air flow control button can be selected at a time.

- Air flows mainly from the center and side ventilators.
- Air flows mainly from the foot outlet and partly from the defogger.
- Air flows mainly from the front defogger outlets.

## 4-34 Display screen, heater and air conditioner, and audio system



**Temperature control:**

Turn the temperature control dial to set the desired temperature.

- When the DUAL indicator light is not illuminated, pushing the "DUAL" button (the indicator light will turn on) allows the user to independently change the driver and passenger side temperatures with the corresponding temperature control dial.
- To cancel the separate temperature setting, push the "DUAL" button (the indicator light will turn off) and the driver's side temperature setting will be applied to both the driver and passenger sides.

**Outside air circulation:**

To turn on the outside air circulation mode, push the air recirculation "↻" button. (The indicator light will turn off.) The air flow is drawn from outside the vehicle.

Select the outside air circulation mode for normal heating or air conditioning operation.

**Air recirculation:**

Push the air recirculation "↻" button to circulate the air flow inside the vehicle. (The indicator light will turn on.)

**SERVICING AIR CONDITIONER****WARNING:**

**The air conditioner system contains refrigerant under high pressure. To avoid personal injury, any air conditioner service should be done only by an experienced technician with the proper equipment.**

The air conditioner system in your vehicle is charged with a refrigerant designed with the environment in mind.

**This refrigerant will not harm the earth's ozone layer.** However, it may contribute in a small part to global warming.

Special charging equipment and lubricant are required when servicing your vehicle's air conditioner. Using improper refrigerants or lubricants will cause severe damage to the air conditioner system. (See "Air conditioner system refrigerant and lubricant" (P.9-5).)

A NISSAN dealer will be able to service your environmentally friendly air conditioner system.

**Air conditioner filter**

The air conditioner system is equipped with an air conditioner filter. To make sure the air conditioner heats, defogs, and ventilates efficiently, replace the filter according to the specified maintenance intervals listed in a separate maintenance booklet. To replace the filter, contact a NISSAN dealer.

The filter should be replaced if the air flow decreases significantly or if windows fog up easily when operating the heater or air conditioner.

**AUDIO SYSTEM (if equipped)****AUDIO OPERATION PRECAUTIONS****WARNING:**

**Do not adjust the audio system while driving so that full attention may be given to vehicle operation.**

**Radio**

- Radio reception is affected by station signal strength, distance from radio transmitter, buildings, bridges, mountains and other external influences. Intermittent changes in reception quality normally are caused by these external influences.
- Using a cellular phone in or near the vehicle may influence radio reception quality.
- Some cellular phones or other devices may cause interference or a buzzing noise to come from the audio system speakers. Storing the device in a different location may reduce or eliminate the noise.

**Compact Disc (CD) player**

- During cold weather or rainy days, the player may malfunction due to the humidity. If this occurs, remove the CD from CD player and dehumidify or ventilate the player completely.
- The player may skip while driving on rough roads.
- The CD player sometimes may not function when the passenger compartment temperature is extremely high. Lower the temperature before use.
- Do not expose the CD to direct sunlight.
- CDs that are of poor quality, or are dirty, scratched, covered with fingerprints, or that have pin holes may not work properly.

- The following CDs may not work properly.
  - Copy control compact discs (CCCD)
  - Recordable compact discs (CD-R)
  - Rewritable compact discs (CD-RW)

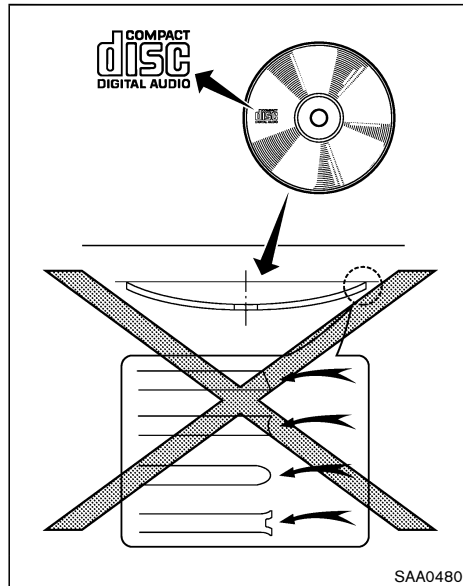

- Do not use the following CDs as they may cause the CD player to malfunction.
  - 8 cm (3.1 in) discs
  - CDs that are not round
  - CDs with a paper label
  - CDs that are warped, scratched or have unusual edges.

- This audio system can only play prerecorded CDs. It has no capabilities to record or burn CDs.

#### USB (Universal Serial Bus) connection port

#### **WARNING:**

**Do not connect, disconnect or operate the USB device while driving. Doing so can be a distraction. If distracted you could lose control of your vehicle and cause an accident or serious injury.**

#### **CAUTION:**

- **Do not force the USB device into the USB port. Inserting the USB device tilted or upside-down into the port may damage the port. Make sure that the USB device is connected correctly into the USB port (Some USB devices come with a  mark as a guide. Make sure that the mark is facing the correct direction before inserting the device.)**
- **Do not grab the USB port cover (if equipped) when pulling the USB device out of the port. This could damage the port and the cover.**
- **Do not leave the USB cable in a place where it can be pulled unintentionally. Pulling the cable may damage the port.**

The vehicle is not equipped with a USB device. USB devices should be purchased separately as necessary.

This system cannot be used to format USB devices. To format a USB device, use a personal computer.

In some states/area, the USB device for the front seats plays only sound without images for regulatory reasons, even when the vehicle is parked.

This system supports various USB memory devices,

USB hard drives and iPod players. Some USB devices may not be supported by this system.

- Partitioned USB devices may not be played correctly.
- Some characters used in other languages (Chinese, Japanese, etc.) are not displayed properly on display. Using English language characters with a USB device is recommended.

#### **General notes for USB use:**

Refer to your device manufacturer's owner information regarding the proper use and care of the device.

#### **Notes for iPod use:**

iPod is a trademark of Apple Inc., registered in the U.S. and other countries.

- Improperly plugging in the iPod may cause a checkmark to be displayed on and off (flickering). Always make sure that the iPod is connected properly.
- An iPod nano (1st Generation) may remain in fast forward or rewind mode if it is connected during a seek operation. In this case, please manually reset the iPod.
- An iPod nano (2nd Generation) will continue to fast-forward or rewind if it is disconnected during a seek operation.
- An incorrect song title may appear when the Play Mode is changed while using an iPod nano (2nd Generation)
- Audiobooks may not play in the same order as they appear on an iPod.
- Large video files cause slow responses in an iPod. The vehicle center display may momentarily black out, but will soon recover.

## 4-36 Display screen, heater and air conditioner, and audio system

- If an iPod automatically selects large video files while in the shuffle mode, the vehicle center display may momentarily black out, but will soon recover.

### Bluetooth® Audio player (if equipped)

- Some Bluetooth® audio devices may not be used with this system. For detailed information about Bluetooth® audio devices that are available for use with this system, contact a NISSAN dealer.
- Before using a Bluetooth® audio system, the initial registration process for the audio device is necessary.
- Operation of the Bluetooth® audio system may vary depending on the audio device that is connected. Confirm the operation procedure before use.
- The playback of Bluetooth® audio will be paused under the following conditions. The playback will be resumed after the following conditions are completed.
  - while using a hands-free phone
  - while checking a connection with a cell phone
- The in-vehicle antenna for Bluetooth® communication is built in the system. Do not place the Bluetooth® audio device in an area surrounded by metal, far away from the system or in a narrow space where the device closely contacts the body or the seat. Otherwise, sound degradation or connection interference may occur.
- While a Bluetooth® audio device is connected through the Bluetooth® wireless connection, the battery power of the device may discharge quicker than usual.
- This system is compatible with the Bluetooth® AV profile (A2DP and AVRCP).



Bluetooth® is a trademark owned by Bluetooth SIG, Inc. and licensed to Visteon Corporation and Bosch.

### Compact Disc (CD)/USB device with MP3/WMA

#### Terms:

- **MP3** — MP3 is short for Moving Pictures Experts Group Audio Layer 3. MP3 is the most well known compressed digital audio file format. This format allows for near “CD quality” sound, but at a fraction of the size of normal audio files. MP3 conversion of an audio track from CD can reduce the file size by approximately 10:1 ratio (Sampling: 44.1 kHz, Bit rate: 128 kbps) with virtually no perceptible loss in quality. MP3 compression removes the redundant and irrelevant parts of a sound signal that the human ear doesn't hear.
- **WMA** — Windows Media Audio (WMA) is a compressed audio format created by Microsoft as an alternative to MP3. The WMA codec offers greater file compression than the MP3 codec, enabling storage of more digital audio tracks in the same amount of space when compared to MP3s at the same level of quality.
- **Bit rate** — Bit rate denotes the number of bits per second used by a digital music files. The size and quality of a compressed digital audio file is determined by the bit rate used when encoding the file.
- **Sampling frequency** — Sampling frequency is the rate at which the samples of a signal are converted from analog to digital (A/D conversion) per second.
- **Multisession** — Multisession is one of the methods for writing data to media. Writing data once to the

media is called a single session, and writing more than once is called a multisession.

- **ID3/WMA Tag** — The ID3/WMA tag is the part of the encoded MP3 or WMA file that contains information about the digital music file such as song title, artist, album title, encoding bit rate, track time duration, etc. ID3 tag information is displayed on the Album/Artist/Track title line on the display.

\* Windows® and Windows Media® are registered trademarks and/or trademarks of Microsoft Corporation in the United States of America and/or other countries.

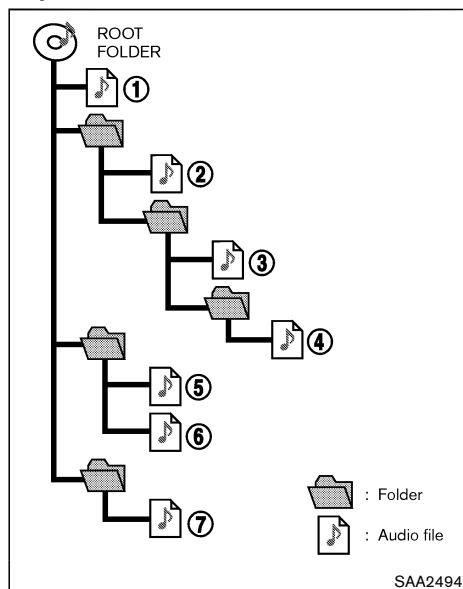
**Playback order:**

Music playback order of the CD with MP3/WMA is as illustrated above.

- The folder names of folders not containing MP3/WMA files are not shown in the display.
- If there is a file in the top level of the disc, "Root Folder" is displayed.
- The playback order is the order in which the files were written by the writing software, so the files might not play in the desired order.

#### 4-38 Display screen, heater and air conditioner, and audio system

**Specification chart (for CD player/Radio Type A and B):**

Supported media		CD, CD-R, CD-RW, USB2.0	
Supported file systems		ISO9660 LEVEL1, ISO9660 LEVEL2, Romeo, Joliet * ISO9660 Level 3 (packet writing) is not supported. * Files saved using the Live File System Component (on a Windows Vista-based computer) are not supported.	
Supported versions*1	MP3	Version	MPEG1, MPEG2, MPEG2.5
		Sampling frequency	8 kHz - 48 kHz
		Bit rate	32 kbps - 320 kbps, VBR*4
	WMA*3	Version	WMA7, WMA8, WMA9 (except WMA9 Pro, WMA9 Lossless, WMA9 Voice)
		Sampling frequency	32 kHz - 48 kHz
		Bit rate	32 kbps - 192 kbps, VBR*4
Tag information (Song title and Artist name)		ID3 tag VER1.0, VER1.1, VER2.2, VER2.3, VER2.4 (MP3 only) WMA tag (WMA only)	
Folder levels		Folder levels: 8, Folders:255 (including root folder), files: 512	
Displayable character codes*2		01: ASCII, 02: ISO-8859-1, 03: UNICODE (UTF-16 BOM Big Endian), 04: UNICODE (UTF-16 Non-BOM Big Endian), 05: UNICODE (UTF-8), 06: UNICODE (Non-UTF-16 BOM Little Endian)	

\*1 Files created with a combination of 48 kHz sampling frequency and 64 kbps bit rate cannot be played.

\*2 Available codes depend on what kind of media, versions and information are going to be displayed.

\*3 Protected WMA files (DRM) cannot be played.

\*4 When VBR files are played, the playback time may not be displayed correctly. WMA7 and WMA8 are not applied to VBR.

**Specification chart (for CD player/Radio Type C and D):**

Supported media			CD, CD-R, CD-RW, USB2.0
Supported file systems			CD, CD-R, CD-RW: ISO9660 LEVEL1, ISO9660 LEVEL2, Romeo, Joliet * ISO9660 Level 3 (packet writing) is not supported. * Files saved using the Live File System component (on a Windows Vista-based computer) are not supported.
			USB memory: FAT16, FAT32
Supported versions*1	MP3	Version	MPEG1 Audio Layer 3
		Sampling frequency	32 kHz - 48 kHz
		Bit rate	32 kbps - 320 kbps, VBR*4
	WMA*2	Version	WMA7, WMA8, WMA9
		Sampling frequency	32 kHz - 48 kHz
		Bit rate	32 kbps - 192 kbps, VBR4, 32 kbps - 320 kbps (WMA9 only)
Tag information (Song title and Artist name)			ID3 tag VER1.0, VER1.1, VER2.2, VER2.3, VER2.4 (MP3 only)
			WMA tag (WMA only)
Folder levels		CD, CD-R, CD-RW	Folder levels: 8, Folders: 255, Files: 999 (Max. 255 files for one folder)
		USB	Folder levels: 8, Folders 255, Files: 2500 (Max. 255 files for one folder) Memory size: 4GB
Displayable character codes*3			01: ASCII, 02: ISO-8859-1, 03: UNICODE (UTF-16 BOM Big Endian), 04: UNICODE (UTF-16 Non-BOM Big Endian), 05: UNICODE (UTF-8)

\*1 Files created with a combination of 48 kHz sampling frequency and 64 kbps bit rate cannot be played.

\*2 Protected WMA files (DRM) cannot be played.

\*3 Available codes depend on what kind of media, versions and information are going to be displayed.

\*4 When VBR files are played, the playback time may not be displayed correctly.

**4-40 Display screen, heater and air conditioner, and audio system**

**Specification chart (for CD player/Radio Type E):**

Supported media		CD, CD-R, CD-RW, USB2.0	
Supported file systems		ISO9660 LEVEL 1, ISO9660 LEVEL2, Apple ISO, Romeo, Joliet *ISO9660 LEVEL 3 (packet writing) is not supported.	
Supported versions*1	MP3	Version	MPEG1, MPEG2, MPEG2.5
		Sampling frequency	8 kHz - 48 kHz
		Bit rate	8 kbps - 320 kbps, VBR
	WMA*2	Version	WMA7, WMA8, WMA9
		Sampling frequency	32 kHz - 48 kHz
		Bit rate	48 kbps - 192 kbps, VBR
Tag information		ID3 tag VER1.0, VER1.1, VER2.2, VER2.3 (MP3 only)	
Folder levels		Folder levels: 8, Max folders: 255 (including root folder), Files: 512 (Max. 255 files for one folder)	
Displayable character codes*2		01: ASCII, 02: ISO-8859-1, 03: UNICODE (UTF-16 BOM Big Endian), 04: UNICODE (UTF-16 Non-BOM Big Endian), 05: UNICODE (UTF-8), 06: UNICODE (Non-UTF-16 BOM Little Endian)	

\*1 Files created with a combination of 48 kHz sampling frequency and 64 kbps bit rate cannot be played.

\*2 Available codes depend on what kind of media, versions and information are going to be displayed.

**Troubleshooting guide:**

Symptom	Cause and Countermeasure
Cannot play	Check if the disc was inserted correctly.
	Check if the disc is scratched or dirty.
	Check if there is condensation inside the player, and if there is, wait until the condensation is gone (about 1 hour) before using the player.
	If there is a temperature increase error, the CD player will play correctly after it returns to the normal temperature.
	If there is a mixture of music CD files (CD-DA data) and MP3/WMA files on a CD, only the music CD files (CD-DA data) will be played.
	Files with extensions other than ".MP3", ".WMA", ".mp3" or ".wma" cannot be played. In addition, the character codes and number of characters for folder names and file names should be in compliance with the specifications.
	Check if the disc or the file is generated in an irregular format. This may occur depending on the variation or the setting of MP3/WMA writing applications or other text editing applications.
	Check if the finalization process, such as session close and disc close, is done for the disc.
Poor sound quality	Check if the disc is scratched or dirty or if the bit rate may be too low.
It takes a relatively long time before the music starts playing.	If there are many folder or file levels on the MP3/WMA disc or if it is a multisession disc, some time may be required before the music starts playing.
Music cuts off or skips	The writing software and hardware combination might not match, or the writing speed, writing depth, writing width, etc., might not match the specifications. Try using the slowest writing speed.
Skipping with high bit rate files	Skipping may occur with large quantities of data, such as for high bit rate data.
Move immediately to the next song when playing.	When a non-MP3/WMA file has been given an extension of ".MP3", ".WMA", ".mp3" or ".wma", or when play is prohibited by copyright protection, the player will skip to the next song.
The songs do not play back in the desired order.	The playback order is the order in which the files were written by the writing software, so the files might not play in the desired order.

**4-42 Display screen, heater and air conditioner, and audio system**



## ANTENNA

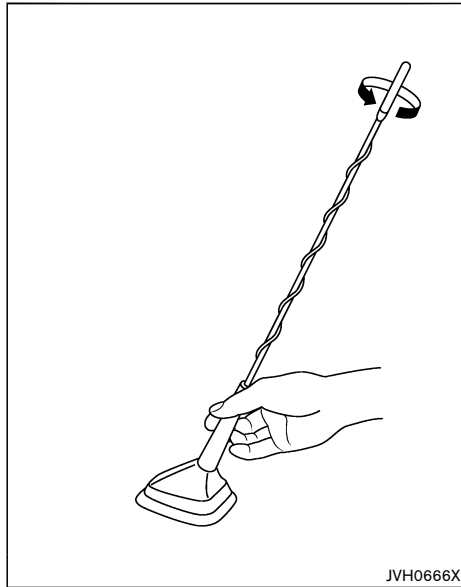

Type A

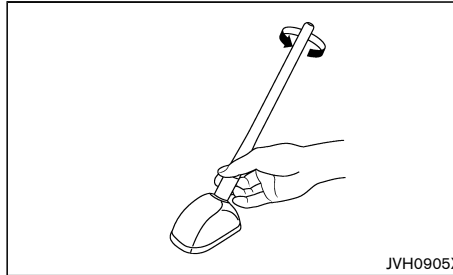

Type B

The antenna can be removed if necessary.

Hold the bottom of the antenna and remove by turning counterclockwise.

To install the antenna, turn the antenna clockwise and tighten.

**CAUTION:**

**To avoid damaging or deforming the antenna, be sure to remove the antenna under the following conditions.**

- **The vehicle enters an automatic car wash.**
- **The vehicle enters a garage with a low ceiling.**
- **The vehicle is covered with a car cover.**

### CD PLAYER/RADIO (Type A)

17. MENU/ENTER dial

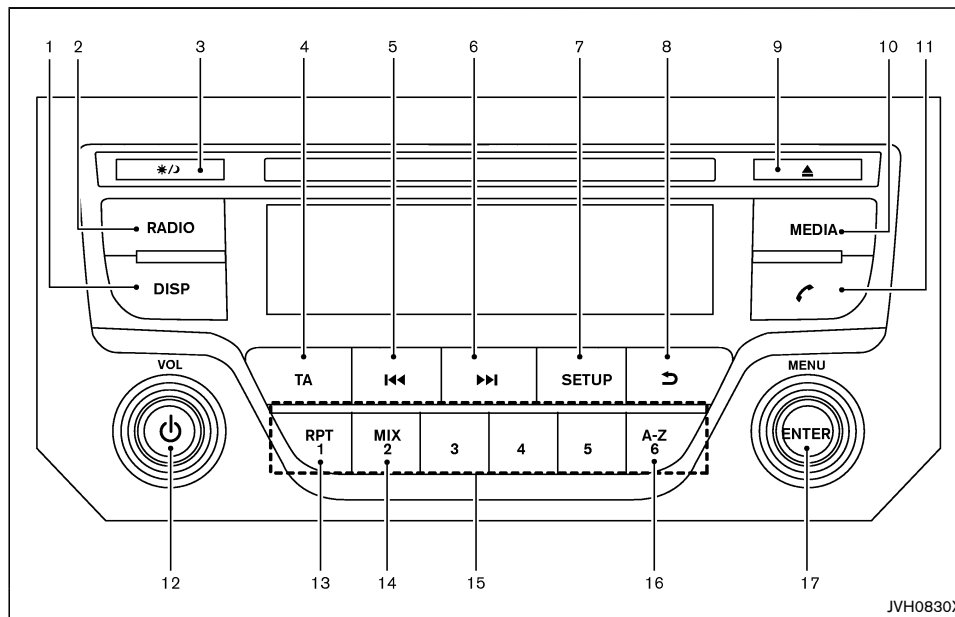

#### Models with TA button

- |                                     |                             |
|-------------------------------------|-----------------------------|
| 1. DISP (Display) button            | 9. CD eject button          |
| 2. RADIO button                     | 10. MEDIA button            |
| 3. Day/Night button                 | 11. Phone button            |
| 4. TA button                        | 12. Power/VOL (Volume) dial |
| 5. Seek/track (rewind) button       | 13. RPT (repeat) button     |
| 6. Seek/track (fast forward) button | 14. MIX button              |
| 7. SETUP button                     | 15. Station memory buttons  |
| 8. Back button                      | 16. A-Z button              |

### 4-44 Display screen, heater and air conditioner, and audio system

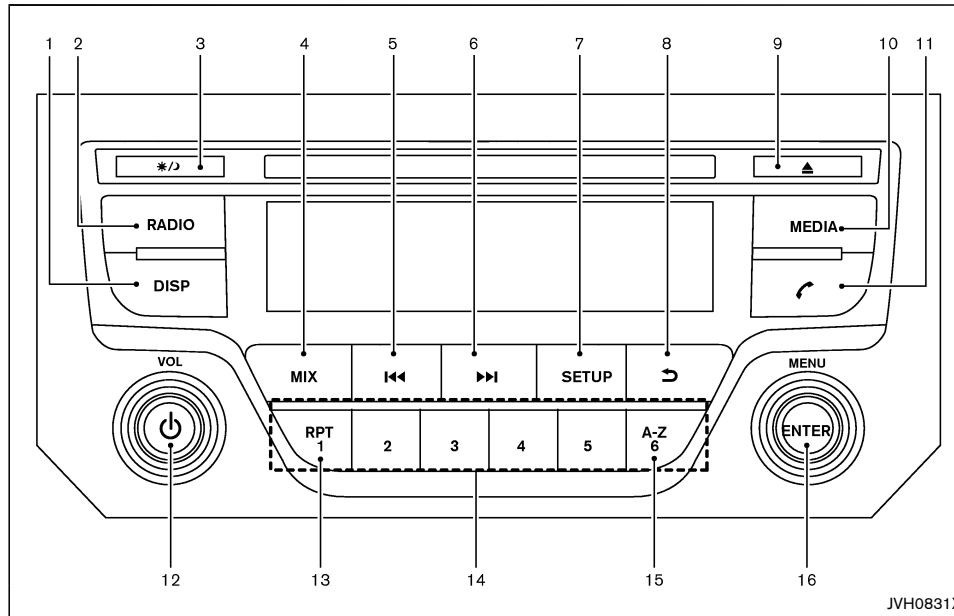

JVH0831X

**Models without TA button**

- |                                     |                             |
|-------------------------------------|-----------------------------|
| 1. DISP (Display) button            | 10. MEDIA button            |
| 2. RADIO button                     | 11. Phone button            |
| 3. Day/Night button                 | 12. Power/VOL (Volume) dial |
| 4. MIX button                       | 13. RPT (repeat) button     |
| 5. Seek/track (rewind) button       | 14. Station memory buttons  |
| 6. Seek/track (fast forward) button | 15. A-Z button              |
| 7. SETUP button                     | 16. MENU/ENTER dial         |
| 8. Back button                      |                             |
| 9. CD eject button                  |                             |

**Anti-theft system (if equipped)**

Use of a 4-digit radio PIN (Personal Identification Number) code, known only to the vehicle owner, effectively reduces the possibility of the audio unit being stolen. Without the PIN code the audio unit cannot be activated.

If force is used to try and remove the audio unit, the Anti-theft system activates and the audio unit is locked. The only way to unlock the audio unit is to enter the radio code number shown on an identification card supplied with the vehicle documentation.

**NOTE:**

- **The 4 digit radio code is shown on a card that you received with your vehicle documentation.**
- **Contact a NISSAN dealer if you do lose the 4 digit radio code of the audio unit.**

**Unlocking the unit:**

If the battery supply to the vehicle is interrupted, the audio unit will lock.

When the power is restored and the unit switched on, the display will show "Radio Code" and it will be unlocked when the codes have been entered correctly.

**Unlocking procedure:**

Read this section very carefully. It is important that the instructions are followed precisely.

To unlock the audio unit, proceed as follows:

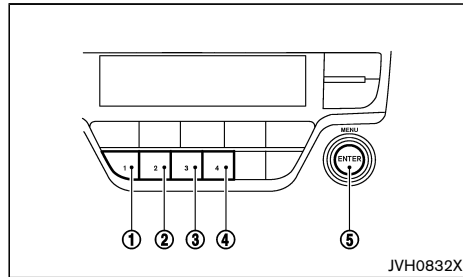

1. Place the ignition switch in the "ACC" or "ON" position.
2. "Radio Code" is displayed along with four numerical zero digits.
3. Push preset ① the number of times corresponding with the first digit of the radio code.  
For example, if the radio code is 5169: for the first digit, "5", push the preset ① five times.
4. The second, third, and fourth digits of the radio code must be entered in the same way, only now using preset ②, ③, and ④.  
For example, push ② once, ③ six times, and ④ nine times.
5. Push the MENU/ENTER dial ⑤ to confirm the code. If you entered the code correctly the unit will switch on.
6. If the code is entered incorrectly a notification message "Incorrect Pin", "Please re-enter Pin" and the number of attempts left [Remaining Tries: xx] will be shown.

After reading the message, push the MENU/ENTER dial ⑤ to return to the entry screen and enter the correct radio code.

#### 4-46 Display screen, heater and air conditioner, and audio system

- If the wrong code is entered after the third attempt, the audio unit will lock for 60 minutes. The display will show a count down timer from 60 to 0 (minutes). After 60 minutes enter the correct radio code.
- If the wrong code is entered after eight sets of three entries, the audio unit will lock permanently. Contact a NISSAN dealer for further details.

#### Audio main operation

The audio system operates when the ignition switch is placed in the "ON" or "ACC" position.

#### Power/VOL dial:

##### Power ON/OFF:

To turn on the audio system, push the Power/VOL dial.

The system will turn on in the mode, which was used immediately before the system was turned off.

To turn off the audio system, push the Power/VOL dial.

##### Volume control:

To control the volume, turn the Power/VOL dial.

Turn the Power/VOL dial clockwise to make the sound louder.

Turn the Power/VOL dial counterclockwise to make the sound quieter.

#### SETUP button:

To configure Audio, Clock, Radio, or Language settings, perform the following procedure:

1. Push the SETUP button.
2. Turn the MENU/ENTER dial, the display will appear in the following order:

Audio → Clock → Radio → Language

3. Push the MENU/ENTER dial.

After the desired levels have been set, push the Back button repeatedly or push the SETUP button.

#### Audio adjustments:

Turn the MENU/ENTER dial until the Audio is displayed, and push the MENU/ENTER dial.

Each time the MENU/ENTER dial is pushed, the mode will change as follows:

Sound → AUX In → Speed Vol. → Bass Boost → Audio Default

Turn the MENU/ENTER dial clockwise or counterclockwise to adjust the following items and push MENU/ENTER dial to confirm.

#### • Sound menu

Bass:

Use this control to enhance or attenuate bass response sound.

Treble:

Use this control to enhance or attenuate the treble.

Bal. (Balance) :

Use this control to adjust the balance of the volume between the left and right speakers.

Fade:

Use this control to adjust the balance of the volume between the front and the rear speakers.

#### • AUX In menu

Use this control to adjust the volume output from the auxiliary source.

#### • Speed Vol. (Volume) menu

This mode controls the volume output from the speakers automatically in relation to vehicle speed. Adjusting the setting to 0 (zero) turns off the speed volume feature.

- **Bass Boost menu**

Turn on or off the Bass Boost feature which emphasizes the lower audio frequencies.

- **Audio Default menu**

The audio unit has a saved preset settings as a factory default. Select "Yes" to change all settings back to the factory preset settings. Select "No" to exit the menu keeping the current settings.

**Clock setting:**

Turn the MENU/ENTER dial until the Clock is displayed, and push the MENU/ENTER dial.

Turn the MENU/ENTER dial, the mode will change as follows:

Set Time → ON/OFF → Format

- **Set Time**

Select "Set Time" then adjust the clock as follows:

The hour display will start flashing. Turn the MENU/ENTER dial to adjust the hour and push the MENU/ENTER dial. The minute display will start flashing. Turn the MENU/ENTER dial to adjust the minute and push the MENU/ENTER dial to finish the clock adjustment.

- **ON/OFF**

The clock display can be turned on and off. When "ON" is selected, the clock will be displayed. (The clock will keep being displayed even after the power of the audio unit is turned off). When "OFF" is selected, the clock will not be displayed.

- **Format**

Switch the clock display between 24-hour mode and 12-hour clock mode.

**Radio setting:**

Turn the MENU/ENTER dial until the Radio is displayed, and push the MENU/ENTER dial.

The FM station which can be received will be updated.

**Language setting:**

Turn the MENU/ENTER dial until the Language is displayed, and push the MENU/ENTER dial.

Select the appropriate language and push the MENU/ENTER dial. Upon completion, the screen will automatically adapt the language setting.



**Day/Night button:**

Push the Day/Night button to switch the display brightness between the daytime and nighttime modes.

The switches on the audio unit will also illuminate in the nighttime mode.



**Phone button:**

For operation on how to use phone button, see "Bluetooth® Hands-Free Phone System (Type A)" (P.4-78).



**MEDIA button:**

Push the MEDIA button to play a compatible device when it is connected.

Each time the MEDIA button is pushed, the audio source will change as follows:

CD → USB (iPod) → AUX → CD → Bluetooth

The source that are not available will be skipped.

**Radio operation**

**Frequency range and step change:**

To change the frequency range and step specification of the radio, perform the following operations.

1. Turn on the audio system.
2. Push the RADIO button and select AM or FM mode.
3. Push and hold the SETUP button for more than 3 seconds.
4. After the 3 seconds, keep holding the SETUP button and turn the MENU/ENTER dial counterclockwise until you hear 3 clicks, clockwise until you hear 3 clicks, and then counterclockwise until you hear 3 clicks.
5. Turn the MENU/ENTER dial until "Region" is highlighted, and push the MENU/ENTER dial.
6. Select an appropriate region from the following options:
  - EUR
  - GOM Pacific
  - GOM S. America
7. To apply the setting, turn off the audio system, place the ignition switch in the "OFF" position, and then place the ignition switch back in the "ON" position.



**RADIO button:**

When the RADIO button is pushed while the audio system is off, the audio system will turn on and the radio will turn on.



When the RADIO button is pushed while another audio source is playing, the other audio source will turn off and the radio will turn on.



To change the radio bands, push the RADIO button until the desired band appears.

FM 1 → FM 2 → AM → FM 1

When the RADIO button is pushed for more than 1.5 seconds, the six stations with the strongest signals are stored in the preset (1 to 6) buttons of the band. During the search, a notification message appears on the display and the sound is muted until the operation is complete. Once completed, the radio selects preset button.

#### **Seek/track buttons:**

Push  or  button briefly to manually change the frequency.



To adjust the broadcasting station frequency automatically, push and hold the  or  button. When the system detects a broadcasting station, it will stop at the station.

#### **Station memory buttons:**

During radio reception, pushing the station memory button for less than 2 seconds will select the stored radio station.

The audio system can store up to 12 FM station frequencies (6 in each of FM 1 and FM 2 ) and 6 AM station frequencies.

To store the station frequency manually:

1. Tune to the desired broadcasting station frequency by using the Seek/track buttons.
2. Push and hold a station memory button -  until a beep sounds. (The radio mutes when the memory button is pushed.)
3. The channel indicator will display and the radio mute disengages, indicating that the memory is

stored properly.

4. Perform steps 1 - 3 for all other memory buttons.

If the battery cable is disconnected, or if the audio fuse blows, the station memory will be erased. In such a case, reset the desired stations.

#### **Radio Data System (RDS) operation (if equipped):**

The RDS is a system through which encoded digital information is transmitted by FM radio stations in addition to the normal FM radio broadcasting. The RDS provides information services such as station name, traffic information, or news.

#### **NOTE:**

**In some countries or regions, some of these services may not be available.**

#### **Alternative Frequency (AF) mode**

The AF mode operates in the FM (radio) mode.

- The AF mode operates in the FM (radio), AUX or CD mode (if FM was previously selected in the radio mode).
- The AF function compares signal strengths and selects the station with the optimum reception conditions for the currently tuned-in station.

#### **RDS functions**

When an RDS station is tuned in with seek or manual tuning, the RDS data is received and the Programme Service (PS) name is displayed.

#### **TA (Traffic announcement) button (if equipped):**

The TA functions are available in the mode of Radio (FM) or any other audio source.

- Pushing the TA button selects the TA mode. The TA indicator is displayed while TA mode is on.
- When TA button is pushed again. The mode will be switched off and the TA indicator will disappear from the display.

#### **Traffic announcement interrupt function**

When a traffic announcement is received, the announcement is tuned in and the display shows a notification message with the radio station name.

Once the traffic announcement has finished, the unit returns to the source that was active before the traffic announcement started.

If TA button is pushed during a traffic announcement, the traffic announcement interrupt mode is cancelled. The TA mode returns to the standby mode and the audio unit returns to the previous source.

#### **CD player operation**

##### **Loading:**

Insert a CD into the slot with the label side facing up. The CD will be guided automatically into the slot and will start playing. After loading the CD, the number of tracks and the playtime will appear on the display.



#### **CAUTION:**

**Do not force the CD into the slot. This could damage the player.**

## 4-48 Display screen, heater and air conditioner, and audio system

**NOTE:**

- **The CD player accepts normal audio CDs or CDs containing MP3/WMA files.**
- **The audio unit will automatically detect if a CD containing MP3/WMA files is inserted, and "MP3CD" will be indicated.**
- **An error notification message will be displayed when inserting an incompatible disc type (e.g. DVD), or if the player cannot read the CD. Eject the disc and insert another disc.**

**MEDIA MEDIA button:**

To change to the CD mode, push the MEDIA button with a CD inserted until the CD mode is selected.

**List view:**

While the track is being played, push the MENU/ENTER dial to display the available tracks in a listed view mode. To select a track from the list, or a track to start listening to, turn the MENU/ENTER dial then push MENU/ENTER dial.

**Quick search:**

In the list view mode, a quick search can be performed to find a track from the list. Push the A-Z button, turn the MENU/ENTER dial to the first alphabetic letter of the song title and then push the MENU/ENTER dial. When found, a list of the available songs will be displayed. Select, and push the MENU/ENTER dial to play the preferred track.

**Seek/track button:**

Push and hold the Seek/track button to fast forward or rewind through the track. When the button is released,

the track will play at normal playing speed.

Track up/down:

Pushing the Seek/track button once, the track will skip forward to the next track or backward to the beginning of the current track. Push the Seek/track button more than once to skip through the tracks.

**Folder browsing:**

If the recorded media contains folders with music files, pushing the Seek/track button will play in sequence the tracks of each folder.

To select a preferred folder:

1. Push the MENU/ENTER dial or the Back button and a list of tracks in the current folder is displayed.
2. Push the Back button.
3. Turn the MENU/ENTER dial for the preferred folder.
4. Push the MENU/ENTER dial to access the folder. Push the MENU/ENTER dial again to start playing the first track or turn the MENU/ENTER dial, and push the MENU/ENTER dial to select another track.

If the current selected folder contains sub folders, push the MENU/ENTER dial, a new screen with a list of sub folders will be displayed. Turn the MENU/ENTER dial for the sub folder then push the MENU/ENTER dial to select. Select the root folder item when songs are recorded additionally in the root folder.

To return to the previous folder screen, push the Back button.

**RPT RPT button:**

Push the RPT button and the current track will be played continuously.

**MIX MIX button:**

Push the MIX button and all the tracks will be played in a random order.

**DISP DISP button:**

While a CD with recorded music information tags (CD-text/ID3-text tags) is being played, the title of the played track is displayed when available.

When the DISP button is pushed repeatedly, further information about the track can be displayed along with the track title as follows:

Track time → Artist name → Album title → Track time

Track details:

Pushing and holding the DISP button will turn the display into a detailed overview. Push the Back button to return to the previous screen.

**CD eject button:**

When the CD eject button is pushed while the ignition switch is placed in the "ON" or "ACC" position, the CD will be ejected.

If a CD is ejected by pushing the CD eject button, and it is not taken out from the loading slot within 20 seconds, the CD will automatically be reloaded to the slot to protect the CD.

## USB device player operation

### USB device main operation:

The USB port is located on the lower part of the instrument panel. See "USB (Universal Serial Bus) connection port" (P.4-75). Connect a USB memory device into the connector. The USB memory device will be activated automatically.

Refer to your device manufacturer's owner information regarding the proper use and care of the device.

If the system has been turned off while the USB memory device was playing, pushing the Power/VOL dial will start the USB memory device.

The following operations are identical to the audio main operation of the Compact Disc (CD) operation. For details, see "CD player operation" (P.4-48).

- List view
- Quick search
-  (Seek/track)
- MIX (Random play)
- RPT (Repeat track)
- Folder browsing

### **MEDIA** MEDIA button:

To operate the USB memory device, push the MEDIA button repeatedly until the USB mode is selected.

### **DISP** DISP button:

While a track with recorded music information tags (ID3-tags) is being played, the title of the played track is displayed.

When the DISP button is pushed repeatedly, further information about the track can be displayed along with the track title as follows:

Track time → Artist → Album → Track time

Track details:

Pushing and holding the DISP button will turn the display into a detailed overview. Push the Back button to return to the display for the main display mode.

## iPod player operation

### Connecting iPod:

The USB port is located on the lower part of the instrument panel. See "USB (Universal Serial Bus) connection port" (P.4-75).

When the iPod is connected to the vehicle, the iPod music library can only be operated by the vehicle audio controls.

\* iPod and iPhone are a trademark of Apple Inc., registered in the U.S. and other countries.

### Compatibility:

The system unit shall be compatible with all devices (past and future) supporting Apple Accessory Protocol on USB link.

It includes (and not limited to):

- iPod Generation 5 devices
- iPod Classic I and II (Generation 6 and 7)
- iTunes Generation OS 1, 2, 3, 4 and next
- iPhone Generation OS 1, 2, 3, 4 and next
- iPod Nano (1G, 2G, 3G)
- iPad 1, 2 and 3

### NOTE:

**This audio system do not support iPad charging.**

### **MEDIA** MEDIA button:

To operate the iPod, push the MEDIA button repeatedly until the USB (iPod) mode is selected and then push the MENU/ENTER dial.

### iPod main operation:

Interface:

The interface for iPod operation shown on the audio system display is similar to the iPod interface. Use the MENU/ENTER dial to play a track on the iPod.

The following items can be chosen from the menu list screen.

- Playlists
- Artists
- Albums
- Tracks
- More

For further information about each item, see the iPod owner's manual.

The following operations are identical to the audio main operation of the Compact Disc (CD) operation. For details, see "CD player operation" (P.4-48).

- List view
- Quick search
-  (Seek/track)
- MIX (Random play)
- RPT (Repeat track)
- Folder browsing

## 4-50 Display screen, heater and air conditioner, and audio system



**DISP DISP button:**

While a track with recorded music information tags (ID3-tags) is being played, the title of the played track is displayed.

When the DISP button is pushed repeatedly, further information about the track can be displayed along with the track title as follows:

Track time → Artist → Album → Track time

Track details:

Pushing and holding the DISP button will turn the display into a detailed overview. To return to the main display, push the Back button.

**Bluetooth® audio player operation****Regulatory information:**

Bluetooth® is a trademark owned by Bluetooth SIG, Inc. and licensed to Visteon Corporation.

**CE statement:**

Hereby Visteon Corp. declares that this system is in compliance with the essential requirements and other relevant provisions of Directive 1999/5/EC.

**NOTE:**

**The audio system only supports Bluetooth® devices with AVRCP (Audio Video Remote Control Profile) version 1.3, or 1.0 or earlier.**

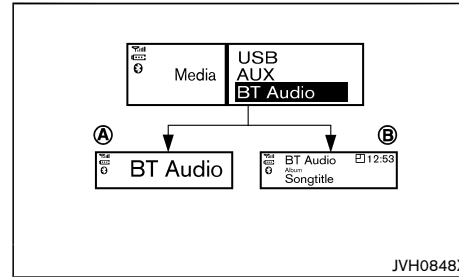
**Bluetooth® audio player main operation:**

To play Bluetooth® audio, the Bluetooth® audio device needs to be paired to the in-vehicle system. For the pairing operation, see “Pairing device” (P.4-79).

**MEDIA MEDIA button:**

To operate the Bluetooth® audio streaming use the following method:

Push MEDIA button repeatedly until “BT Audio” is shown.

The type of display, (A) or (B), shown on the audio system can vary depending on the Bluetooth® version of the device.

**Fast Forward (Cue), Fast Reverse (Review) buttons:**

When (Cue) or (Review) button is pushed continuously, the track will be played at high speed. When the button is released, the track will be played at normal playing speed.

**Track up/down buttons:**

Pushing (Cue) or (Review) button once, the track will be skipped forward to the next track or backward to the beginning of the current played track. Push (Cue) or (Review) button more than once to skip through the tracks.

**DISP DISP button:**

If the song contains music information tags (ID3-tags), the title of the played song will be displayed. If tags are not provided then the display will not show any messages.

When the DISP button is pushed repeatedly further information about the song can be displayed along with the song title.

A long push on DISP will turn the display into a detailed overview which after a few seconds returns to the main display; or push DISP briefly.

**AUX device player operation**

The AUX jack is located on lower part of the instrument panel. (See “AUX (auxiliary) input jack” (P.4-75).) The AUX input jack accepts any standard analog audio input such as from a portable cassette tape/CD player, MP3 player or laptop computer.

NISSAN strongly recommends using a stereo mini plug cable when connecting your music device to the audio system. Music may not play properly when a monaural cable is used.

**MEDIA MEDIA button:**

To switch to the AUX mode, push the MEDIA button repeatedly until the AUX mode is selected.

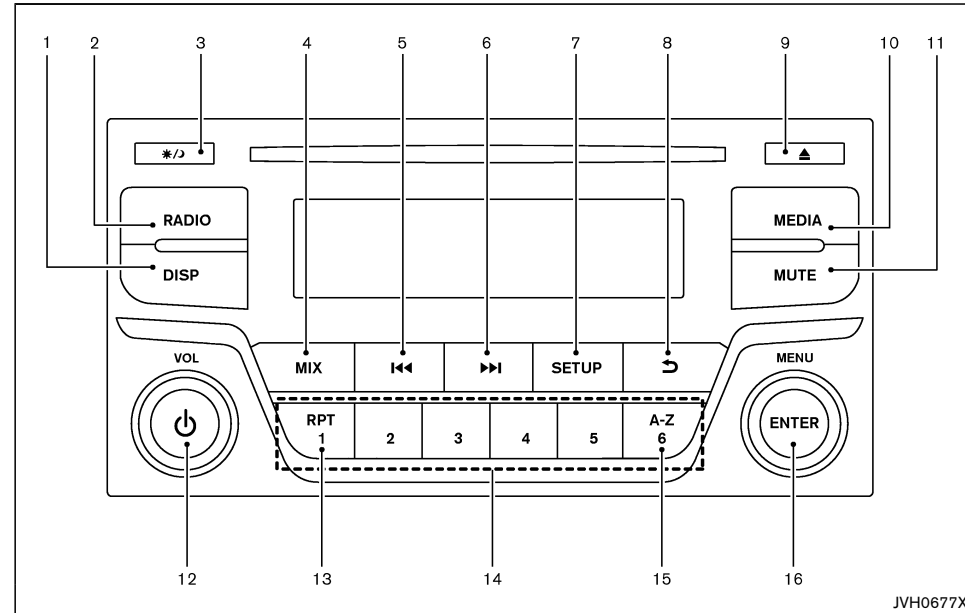
**CD PLAYER/RADIO (Type B)**

- |                                     |                             |
|-------------------------------------|-----------------------------|
| 1. DISP (Display) button            | 9. CD eject button          |
| 2. RADIO button                     | 10. MEDIA button            |
| 3. Day/Night button                 | 11. MUTE button             |
| 4. MIX button                       | 12. Power/VOL (Volume) dial |
| 5. Seek/track (rewind) button       | 13. RPT (repeat) button     |
| 6. Seek/track (fast forward) button | 14. Station memory buttons  |
| 7. SETUP button                     | 15. A-Z button              |
| 8. Back button                      | 16. MENU/ENTER dial         |

**4-52 Display screen, heater and air conditioner, and audio system**

## Audio main operation

The audio system operates when the ignition switch is placed in the "ON" or "ACC" position.



### Power/VOL dial:

#### Power ON/OFF:

To turn on the audio system, push the Power/VOL dial.

The system will turn on in the mode, which was used immediately before the system was turned off.

To turn off the audio system, push the Power/VOL dial.

#### Volume control:

To control the volume, turn the Power/VOL dial.

Turn the Power/VOL dial clockwise to make the sound louder.

Turn the Power/VOL dial counterclockwise to make the sound quieter.



### SETUP button:

To configure Audio, Clock, Radio or Language settings, perform the following procedure:

1. Push the SETUP button.
2. Turn the MENU/ENTER dial, the display will appear in the following order:  
Audio → Clock → Radio → Language
3. Push the MENU/ENTER dial.

After the desired levels have been set, push the Back button repeatedly or push the SETUP button.

#### Audio adjustments:

Turn the MENU/ENTER dial until the Audio is displayed, and push the MENU/ENTER dial.

Each time the MENU/ENTER dial is pushed, the mode will change as follows:

Sound → AUX In → Speed Vol. → Bass Boost → Audio Default

Turn the MENU/ENTER dial clockwise or counterclockwise to adjust the following items and push MENU/ENTER dial to confirm.

- **Sound menu**

Bass:

Use this control to enhance or attenuate bass response sound.

Treble:

Use this control to enhance or attenuate the treble.

Bal.:

Use this control to adjust the balance of the volume between the left and right speakers.

Fade:

Use this control to adjust the balance of the volume between the front and the rear speakers.

- **AUX In menu**

Use this control to adjust the volume output from the auxiliary source.

- **Speed Vol. menu**

This mode controls the volume output from the speakers automatically in relation to vehicle speed. Adjusting the setting to 0 (zero) turns off the speed volume feature.

- **Bass Boost menu**

Turn on or off the Bass Boost feature which emphasizes the lower audio frequencies.

- **Audio Default menu**

The audio unit has a saved preset settings as a factory default. Select "Yes" to change all settings back to the factory preset settings. Select "No" to exit the menu keeping the current settings.

#### Clock setting:

Turn the MENU/ENTER dial until the Clock is displayed, and push the MENU/ENTER dial.

Turn the MENU/ENTER dial, the mode will change as follows:

Set Time → ON/OFF → Format

- **Set Time**

Select "Set Time" then adjust the clock as follows:

The hour display will start flashing. Turn the MENU/ENTER dial to adjust the hour and push the MENU/ENTER dial. The minute display will start flashing. Turn the MENU/ENTER dial to adjust the minute and push the MENU/ENTER dial to finish the clock adjustment.

- **ON/OFF**

The clock display can be turned on and off. When "ON" is selected, the clock will be displayed. (The clock will keep being displayed even after the power of the audio unit is turned off). When "OFF" is selected, the clock will not be displayed.

- **Format**

Switch the clock display between 24-hour mode and 12-hour clock mode.

#### Radio setting:

Turn the MENU/ENTER dial until the Radio is displayed, and push the MENU/ENTER dial.

The FM station which can be received will be updated.

#### Language setting:

Turn the MENU/ENTER dial until the Language is displayed, and push the MENU/ENTER dial.

Select the appropriate language and push the MENU/ENTER dial. Upon completion, the screen will automatically adapt the language setting.

### **Day/Night button:**

Push the Day/Night button to switch the display brightness between the daytime and nighttime modes.

The switches on the audio unit will also illuminate in the nighttime mode.

### **MUTE button:**

Push the MUTE button to mute the audio system. Push the button again to unmute.

### **MEDIA button:**

Push the MEDIA button to play a compatible device when it is connected.

Each time the MEDIA button is pushed, the audio source will change as follows:

CD → USB/iPod → AUX → CD

The source that are not available will be skipped.

### **Radio operation**

The audio system operates when the ignition switch is placed in the "ON" or "ACC" position.

### **RADIO button:**

When the RADIO button is pushed while the audio system is off, the audio system will turn on and the radio will turn on.



When the RADIO button is pushed while another audio source is playing, the other audio source will turn off and the radio will turn on.



To change the radio bands, push the RADIO button until the desired band appears.

FM 1 → FM 2 → AM → FM 1

When the RADIO button is pushed for more than 1.5 seconds, the six stations with the strongest signals are stored in the preset (1 to 6) buttons of the band. During the search, a notification message appears on the display and the sound is muted until the operation is complete. Once completed, the radio selects preset button.

### **Seek/track buttons:**

Push  or  button briefly to manually change the frequency.



To adjust the broadcasting station frequency automatically, push and hold the  or  button. When the system detects a broadcasting station, it will stop at the station.

### **Station memory buttons:**

During radio reception, pushing the station memory button for less than 2 seconds will select the stored radio station.

The audio system can store up to 12 FM station frequencies (6 in each of FM 1 and FM 2 ) and 6 AM station frequencies.

To store the station frequency manually:

1. Tune to the desired broadcasting station frequency by using the Seek/track buttons.
2. Push and hold a station memory button  -  until a beep sounds. (The radio mutes when the memory button is pushed.)
3. The channel indicator will display and the radio mute disengages, indicating that the memory is stored properly.
4. Perform steps 1 - 3 for all other memory buttons.

If the battery cable is disconnected, or if the audio fuse

blows, the station memory will be erased. In such a case, reset the desired stations.

### **CD player operation**

The audio system operates when the ignition switch is placed in the "ON" or "ACC" position.

#### **Loading:**

Insert a CD into the slot with the label side facing up. The CD will be guided automatically into the slot and will start playing. After loading the CD, the number of tracks and the playtime will appear on the display.



#### **CAUTION:**

**Do not force the CD into the slot. This could damage the player.**

#### **NOTE:**

- **The CD player accepts normal audio CDs or CDs containing MP3/WMA files.**
- **The audio unit will automatically detect if a CD containing MP3/WMA files is inserted, and "MP3CD" will be indicated.**
- **An error notification message will be displayed when inserting an incompatible disc type (e.g. DVD), or if the player cannot read the CD. Eject the disc and insert another disc.**

### **MEDIA button:**

To change to the CD mode, push the MEDIA button with a CD inserted until the CD mode is selected.

## 4-54 Display screen, heater and air conditioner, and audio system

**List view:**

While the track is being played, push the MENU/ENTER dial to display the available tracks in a listed view mode. To select a track from the list, or a track to start listening to, turn the MENU/ENTER dial then push MENU/ENTER dial.

**Quick search:**

In the list view mode, a quick search can be performed to find a track from the list. Push the A-Z button, turn the MENU/ENTER dial to the first alphabetic letter of the song title and then push the MENU/ENTER dial. When found, a list of the available songs will be displayed. Select, and push the MENU/ENTER dial to play the preferred track.

 **Seek/track button:**

Push and hold the Seek/track button to fast forward or rewind through the track. When the button is released, the track will play at normal playing speed.

Track up/down:

Pushing the Seek/track button once, the track will skip forward to the next track or backward to the beginning of the current track. Push the Seek/track button more than once to skip through the tracks.

**Folder browsing:**

If the recorded media contains folders with music files, pushing the Seek/track button will play in sequence the tracks of each folder.

To select a preferred folder:

1. Push the MENU/ENTER dial or the Back button and a list of tracks in the current folder is displayed.

2. Push the Back button.
3. Turn the MENU/ENTER dial for the preferred folder.
4. Push the MENU/ENTER dial to access the folder. Push the MENU/ENTER dial again to start playing the first track or turn the MENU/ENTER dial, and push the MENU/ENTER dial to select another track.

If the current selected folder contains sub folders, push the MENU/ENTER dial, a new screen with a list of sub folders will be displayed. Turn the MENU/ENTER dial for the sub folder then push the MENU/ENTER dial to select. Select the root folder item when songs are recorded additionally in the root folder.

To return to the previous folder screen, push the Back button.

 **RPT button:**

Push the RPT button and the current track will be played continuously.

 **MIX button:**

Push the MIX button and all the tracks will be played in a random order.

 **DISP button:**

While a CD with recorded music information tags (CD-text/ID3-text tags) is being played, the title of the played track is displayed when available.

When the DISP button is pushed repeatedly, further information about the track can be displayed along with the track title as follows:

Track time → Artist → Album → Track time

Track details:

Pushing and holding the DISP button will turn the display into a detailed overview. Push the Back button to return to the previous screen.

 **CD eject button:**

When the CD eject button is pushed while the ignition switch is placed in the "ON" or "ACC" position, the CD will be ejected.

If a CD is ejected by pushing the CD eject button, and it is not taken out from the loading slot within 20 seconds, the CD will automatically be reloaded to the slot to protect the CD.

**USB device player operation****USB device main operation:**

The USB outlet connector is located on the lower part of the instrument panel. See "USB (Universal Serial Bus) connection port" (P.4-75). Connect a USB memory device into the connector. The USB memory device will be activated automatically.

Refer to your device manufacturer's owner information regarding the proper use and care of the device.

If the system has been turned off while the USB memory device was playing, pushing the Power/VOL dial will start the USB memory device.

The following operations are identical to the audio main operation of the Compact Disc (CD) operation. For details, see "CD player operation" (P.4-54).

- List view
- Quick search
-  (Seek/track)

- MIX (Random play)
- RPT (Repeat track)
- Folder browsing

#### **MEDIA** MEDIA button:

To operate the USB memory device, push the MEDIA button repeatedly until the USB mode is selected.

#### **DISP** DISP button:

While a track with recorded music information tags (ID3-tags) is being played, the title of the played track is displayed.

When the DISP button is pushed repeatedly, further information about the track can be displayed along with the track title as follows:

Track time → Artist → Album → Track time

Track details:

Pushing and holding the DISP button will turn the display into a detailed overview. Push the Back button to return to the display for the main display mode.

#### iPod player operation

##### **Connecting iPod:**

The USB outlet connector is located on the lower part of the instrument panel. See "USB (Universal Serial Bus) connection port" (P.4-75).

When the iPod is connected to the vehicle, the iPod music library can only be operated by the vehicle audio controls.

\* iPod and iPhone are a trademark of Apple Inc., registered in the U.S. and other countries.

#### **Compatibility:**

The system unit shall be compatible with all devices (past and future) supporting Apple Accessory Protocol on USB link.

It includes (and not limited to):

- iPod Generation 5 devices
- iPod Classic I and II (Generation 6 and 7)
- iTouch Generaion OS 1, 2, 3, 4 and next
- iPhone Generation OS 1, 2, 3, 4 and next
- iPod Nano (1G, 2G, 3G)
- iPad 1, 2 and 3

#### **NOTE:**

**This audio system do not support iPad charging.**

#### **MEDIA** MEDIA button:

To operate the iPod, push the MEDIA button repeatedly until the USB/iPod mode is selected and then push the MENU/ENTER dial.

#### **iPod main operation:**

Interface:



The interface for iPod operation shown on the audio system display is similar to the iPod interface. Use the MENU/ENTER dial to play a track on the iPod.

The following items can be chosen from the menu list screen.

- Playlists
- Artists
- Albums
- Tracks
- More

For further information about each item, see the iPod owner's manual.

The following operations are identical to the audio main operation of the Compact Disc (CD) operation. For details, see "CD player operation" (P.4-54).

- List view
- Quick search
-   (Seek/track)
- MIX (Random play)
- RPT (Repeat track)
- Folder browsing

#### **DISP** DISP button:

While a track with recorded music information tags (ID3-tags) is being played, the title of the played track is displayed.

When the DIPS button is pushed repeatedly, further information about the track can be displayed along with the track title as follows:

Track time → Artist → Album → Track time

Track details:

Pushing and holding the DISP button will turn the display into a detailed overview. To return to the main display, push the Back button.

#### **AUX device player operation**

The AUX jack is located on lower part of the instrument panel. (See "AUX (auxiliary) input jack" (P.4-75).) The AUX input jack accepts any standard analog audio input such as from a portable cassette tape/CD player, MP3 player or laptop computer.

NISSAN strongly recommends using a stereo mini plug cable when connecting your music device to the audio system. Music may not play properly when a monaural cable is used.

## 4-56 Display screen, heater and air conditioner, and audio system

**MEDIA MEDIA button:**

To switch to the AUX mode, push the MEDIA button repeatedly until the AUX mode is selected.

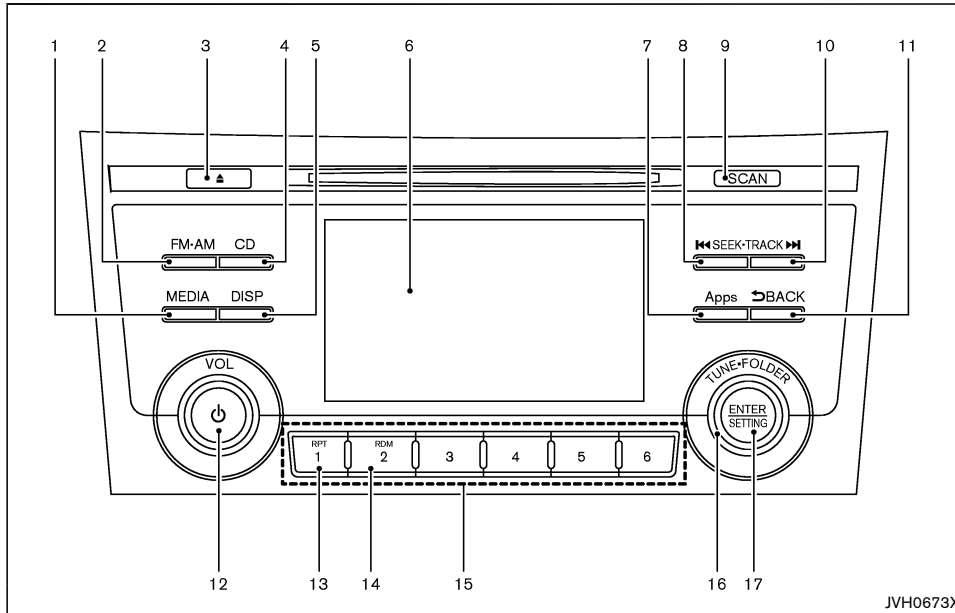
**CD PLAYER/RADIO (Type C)**

JVH0673X

- |                               |   |
|-------------------------------|---|
| 1. MEDIA button               | 9. SCAN tuning button                   |
| 2. FM-AM button               | 10. SEEK-TRACK (fast forward) button    |
| 3. CD eject button            | 11. BACK button                         |
| 4. CD button                  | 12. Power/VOL (volume) dial             |
| 5. DISP (display) button      | 13. RPT (repeat) button                 |
| 6. Color display              | 14. RDM (random) button                 |
| 7. Apps button                | 15. Radio station preset select buttons |
| 8. SEEK-TRACK (rewind) button | 16. TUNE-FOLDER dial                    |

**Display screen, heater and air conditioner, and audio system 4-57**

## 17. ENTER/SETTING button

### Audio main operation

The audio system operates when the ignition switch is placed in the "ON" or "ACC" position.

#### Head unit:

The auto loudness circuit enhances the low and high frequency ranges automatically in both radio reception and CD playback.

#### Power/VOL dial:

Push Power/VOL dial to turn on and off the audio system.

Turn the Power/VOL dial to adjust the volume.

#### Audio settings:

The settings screen will appear when pushing the ENTER/SETTING button.

The following items are available in the settings screen.

- **Bluetooth**  
It is possible to set the Bluetooth® settings. For details of the Bluetooth® settings, see "Bluetooth® audio player operation" (P.4-61).
- **Bass, Treble, Balance and Fade**  
Controls the sound of the audio system. Balance adjusts the sound between the left and right speakers. Fade adjusts the sound between the front and rear speakers.  
Select the "Bass", "Treble", "Balance" or "Fade" using the TUNE-FOLDER dial and then push the ENTER/SETTING button. Turn the TUNE-FOLDER dial to adjust the Bass, Treble, balance and Fade of the screen to the preferred level.
- **Brightness and Contrast**  
Adjust the brightness and contrast of the screen. Select the "brightness" or "contrast" using the

TUNE-FOLDER dial and then push the ENTER/SETTING button. Turn the TUNE-FOLDER dial to adjust the brightness and contrast of the screen to the preferred level.

- **Clock Adjust**  
Adjust the clock according to the following procedure.

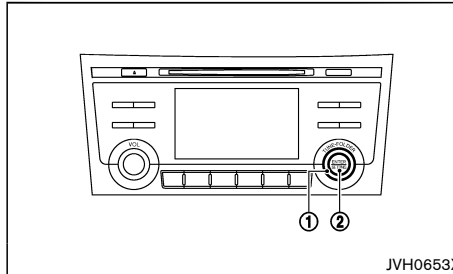

- 1) Select "Clock Adjust" using the TUNE-FOLDER dial ① and then push the ENTER/SETTING button ②.
- 2) Adjust the hour with the TUNE-FOLDER dial ① and then push the ENTER/SETTING button ②.
- 3) Adjust the minute with the TUNE-FOLDER dial ① and then push the ENTER/SETTING button ②.

24 hour clock is not available.

- **On-Screen Clock**  
When this item is turned on, a clock is always displayed in the upper right corner of the screen. Select the "On-Screen Clock" using the TUNE-FOLDER dial and then push the ENTER/SETTING button. You can toggle between ON and OFF using the TUNE-FOLDER dial.

- **RDS Display (if equipped)**  
RDS (radio data system) information can be shown on the display. Select "RDS Display" using the TUNE-FOLDER dial and then push the ENTER/SETTING button. You can toggle between ON and OFF using the TUNE-FOLDER dial.
- **Speed Sensitive Vol.**  
To change the Speed Sensitive Volume (Speed Sens Vol.) level from off (0) to 5, turn the TUNE-FOLDER dial.
- **AUX Vol.**  
Controls the volume level of incoming sound when an auxiliary device is connected to the system. Choose a setting between 1 and 3 or choose 0 to disable the feature entirely.
- **Language Select**  
The language settings can be changed. Select "Language Select" using the TUNE-FOLDER dial and then push the ENTER/SETTING button. Use the TUNE-FOLDER dial to select the preferred language.

#### **DISP** DISP button:

Display of the screen can be canceled by pushing the DISP button. You can then listen to music that is being played back. If you want to display the screen again, either push the DISP button once more or push the FM-AM, CD, Apps or MEDIA button.

#### **MEDIA** MEDIA button:

Pushing the MEDIA button will switch the audio source as follows:

USB/iPod → Bluetooth → AUX → USB/iPod

## 4-58 Display screen, heater and air conditioner, and audio system



**Apps** **Apps button:**

The Apps button launches the Smartphone Integration mode. See "NissanConnect App smartphone integration" (P.4-74).

**Radio operation****FM•AM** **FM-AM button:**

Push the FM-AM button to change the band as follows:

AM → FM1 → FM2 → AM

**TUNE (Tuning):**

Turn the radio TUNE-FOLDER dial for manual tuning.

**Radio Data System (RDS) (if equipped):**

RDS stands for Radio Data System, and is a data information service transmitted by some radio stations on the FM band (not AM band) encoded within a regular radio broadcast. Currently, most RDS stations are in large cities, but many stations are now considering broadcasting RDS data.

RDS can display:

- Station name, such as "The Groove".
- Music or programming type such as "Classical", "Country" or "Rock".

**SEEK tuning:**

Push the SEEK-TRACK (rewind) or SEEK-TRACK (fast forward) button to tune from low to high or high to low frequencies and to stop at the next broadcasting station.

**SCAN** **SCAN tuning:**

Push the SCAN tuning button to tune from low to high frequencies and stop at each broadcasting station for 5 seconds. Pushing the button again during this 5 seconds period will stop SCAN tuning and the radio will remain tuned to that station.

If the SCAN tuning button is not pushed within 5 seconds, SCAN tuning moves to the next station.

**1 to 6** **Station memory operations:**

12 stations can be set for the FM band (6 each for FM1 and FM2) and 6 stations can be set for the AM band.

1. Choose the radio band using the FM-AM button.
2. Tune to the desired station using the SEEK-TRACK, SCAN button or the TUNE-FOLDER dial.
3. Push and hold the desired station preset button **1** to **6** until the radio mutes.
4. The station indicator will then come on and the sound will resume. Memorizing is now complete.
5. Other buttons can be set in the same manner.

If the battery cable is disconnected, or if the fuse opens, the station memory will be erased. In that case, reset the desired stations.

**CD player operation**

Place the ignition switch in the "ON" or "ACC" position, and insert the Compact Disc (CD) into the slot with the label side facing up. The CD will be guided automatically into the slot and start playing.

After loading the CD, the number of tracks on the CD and the play time will appear on the display.

If the radio is already operating, it will automatically turn off and the CD will play.

If the system has been turned off while the CD was playing, pushing the Power/VOL dial will start the CD.

**CD** **PLAY:**

When the CD button is pushed with the system off and the CD loaded, the system will turn on and the CD will start to play.

When the CD button is pushed with the CD loaded and the radio playing, the radio will automatically be turned off and the CD will start to play.

**SEEK/TRACK button:**

When the SEEK-TRACK (rewind) or SEEK-TRACK (fast forward) button is pushed for more than 1.5 seconds while the CD is being played, the CD will play while fast forwarding or rewinding. When the button is released, the CD will return to normal play speed.

When the SEEK-TRACK (rewind) or SEEK-TRACK (fast forward) button is pushed for less than 1.5 seconds while the CD is being played, the next track or the beginning of the current track on the CD will be played.

**RPT** **REPEAT (RPT):**

When the RPT button is pushed while the CD is played, the play pattern can be changed as follows:

(CD)

(Normal) ↔ 1 Track Repeat

(CD with compressed audio files)

(Normal) → 1 Folder Repeat → 1 Track Repeat → (Normal)

**RDM RANDOM (RDM):**

When the RDM button is pushed while a CD is being played, the play pattern can be changed as follows:  
(CD)

(Normal) ⇔ 1 Disc Random

(CD with compressed audio files)

(Normal) → 1 Disc Random → 1 Folder Random → (Normal)

**CD eject:**

When the CD eject button is pushed with the CD loaded, the CD will be ejected.

When this button is pushed while the CD is being played, the CD will be ejected.

**If the CD comes out and is not removed, it will be pulled back into the slot to protect it.**

**USB device player operation****USB main operation:**

The USB port is located on the lower part of the instrument panel. See "USB (Universal Serial Bus) connection port" (P.4-75). Connect a USB memory device into the connector. The USB memory device will be activated automatically.

If the system has been turned off while the USB memory device was playing, pushing the Power/VOL dial will start the USB memory device.

Refer to your device manufacturer's owner information regarding the proper use and care of the device.

**MEDIA PLAY:**

When the MEDIA button is pushed with the system off and the USB memory device inserted, the system will turn on.

If another audio source is playing and a USB memory device is inserted, push the MEDIA button repeatedly until the color display changes to the USB memory device mode.

**Previous/Next File and Fast Rewind/Forward:**

When the SEEK-TRACK (rewind) or SEEK-TRACK (fast forward) button is pushed for more than 1.5 seconds while a USB memory device is being played, the USB memory device will play while forwarding or rewinding. When the button is released, the USB memory device will return to normal play speed.

When the SEEK-TRACK (rewind) or SEEK-TRACK (fast forward) button is pushed for less than 1.5 seconds while the USB memory device is being played, the next track or the beginning of the current track on the USB memory device will be played.

**Folder selection:**

To change to another folder in the USB memory device, turn the TUNE-FOLDER dial.

**RPT REPEAT (RPT):**

When the RPT button is pushed while the USB memory device is played, the play pattern can be change as follows.

To change the play mode, push the RPT button repeatedly and the mode will change as follows.

(Normal) → 1 Folder Repeat → 1 Track Repeat →

(Normal)

**RDM RANDOM (RDM):**

When the RDM button is pushed while a USB memory device is being played, the play pattern can be changed as follows.

To change the play mode, push the RDM button repeatedly, and the mode will change as follows.

(Normal) → All Random → 1 Folder Random → (Normal)

**iPod player operation****Connecting iPod:**

USB port is located on the lower part of the instrument panel. Connect the iPod with a USB port using the cable. See "USB (Universal Serial Bus) connection port" (P.4-75). The battery of the iPod is charged while the cable is connected to the vehicle.

Depending on the version of the iPod, the display on the iPod shows a NISSAN or Accessory Attached screen when the connection is completed. When the iPod is connected to the vehicle, the iPod music library can only be operated by the vehicle audio controls.

\* iPod and iPhone are a trademark of Apple Inc., registered in the U.S. and other countries.

Refer to your device manufacturer's owner information regarding the proper use and care of the device.

**Compatibility:**

The following models are compatible:

- iPod nano 1G (Firmware version 1.3.1 -)
- iPod nano 2G (Firmware version 1.1.3 -)
- iPod nano 3G (Firmware version 1.0.0 -)

**4-60 Display screen, heater and air conditioner, and audio system**

- iPod nano 4G (Firmware version 1.0.2 -)
- iPod nano 5G (Firmware version 1.0.1 -)
- iPod nano 6G (Firmware version 1.0 -)
- iPod nano 7G (Firmware version 1.0.0 -)
- iPod 5G (Firmware version 1.2.1 -)
- iPod classic (Firmware version 1.0.0 -)
- iPod Touch (iOS 1.1 -)
- iPod Touch 2G (iOS 2.1.1 -)
- iPod Touch 3G (iOS 3.1 -)
- iPod Touch 4G (iOS 4.1 -)
- iPod Touch 5G (iOS 6.0.0 -)
- iPhone (iOS 1.0.0 - 2.2.1)
- iPhone 3G (iOS 2.1 -)
- iPhone 3GS (iOS 3.0 -)
- iPhone 4/4S (iOS 4.0 -)
- iPhone 5 (iOS 6.0.0 -)

Operations attributable to firmware update by Apple are not guaranteed.

#### **MEDIA MEDIA:**

To switch to the iPod mode, push the MEDIA button until the USB/iPod mode is selected while the ignition switch is placed in the "ON" or "ACC" position.

If another audio source is playing and the iPod is connected, pushing the MEDIA button changes to the iPod mode.

If the system has been turned off while the iPod was playing, pushing the Power/VOL dial button will start the iPod.

When the MEDIA button is pushed while the iPod is connected, the interface for iPod operation is shown on the audio display. The items on the menu list can be scrolled by pushing the SEEK-TRACK (rewind) or SEEK-TRACK (fast forward) button while the iPod is

operational. To select an item, push ENTER/SETTING button. Items in the iPod menu appear on the display in the following order.

- Now playing
- Playlists
- Artists
- Albums
- Songs
- Podcasts
- Genres
- Composers
- Audiobooks
- Shuffle Songs

Push the BACK button to return to the previous screen.

For more information about each item, see the iPod Owner's Manual.



#### **Previous/Next Track and Fast Re-wind/Forward:**

When the SEEK-TRACK (rewind) or SEEK-TRACK (fast forward) button is pushed for more than 1.5 seconds while the iPod is playing, the iPod will play while fast forwarding or rewinding. When the button is released, the iPod will return to the normal play speed.

When the SEEK-TRACK (rewind) or SEEK-TRACK (fast forward) button is pushed for less than 1.5 seconds while the iPod is playing, the next track or the beginning of the current track on the iPod will be played.

#### **RPT REPEAT (RPT):**

When the RPT button is pushed while a track is being played, the play pattern can be changed as follows:

Repeat Off → 1 Track Repeat → All Repeat → Repeat Off

#### **RDM RANDOM (RDM):**

When the RDM button is pushed while a track is being played, the play pattern can be changed as follows:

Shuffle Off → Track Shuffle → Shuffle Off

#### **Bluetooth® audio player operation**

If you have a compatible Bluetooth® audio device that is capable of playing audio files, the device can be connected to the vehicle's audio system so that the audio files on the device play through the vehicle's speakers.

#### **Regulatory information:**

##### **Bluetooth® trademark:**



Bluetooth® is a trademark owned by Bluetooth SIG, Inc. and licensed to Visteon Corporation.

##### **Connecting Bluetooth® device:**

To connect your Bluetooth® device to the vehicle, follow the procedure below:

1. Push the ENTER/SETTING button.

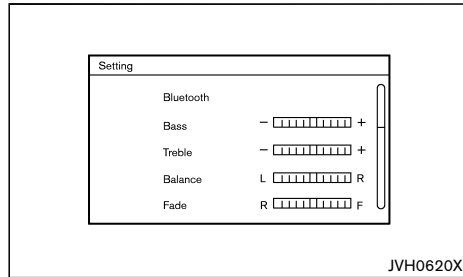

2. Select the "Bluetooth" key.
3. Select the "Add Phone or Device" key. This same screen can be accessed to remove, replace or select a different Bluetooth® device.
4. The system acknowledges the command and asks you to initiate connecting from the Bluetooth® device. The connecting procedure of the Bluetooth® device varies according to each cellular phone model. See the Owner's manual of the Bluetooth® device for details.

#### Bluetooth® audio main operation:

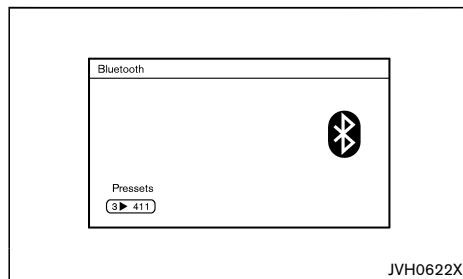

To switch to the Bluetooth® audio mode, push the MEDIA button repeatedly until the Bluetooth® audio

mode is displayed on the screen.

The controls for the Bluetooth® audio are displayed on the screen. Use the Preset 3 button to play and use the Preset 4 button to pause.

#### AUX device player operation

The AUX input jack is located on the lower part of the instrument panel. (See "AUX (auxiliary) input jack" (P.4-75).) The AUX audio input jack accepts any standard analog audio input such as from a portable cassette tape/CD player, MP3 player or laptop computer.

NISSAN strongly recommends using a stereo mini plug cable when connecting your music device to the audio system. Music may not play properly when a monaural cable is used.

#### **MEDIA MEDIA:**

To switch to the AUX mode, push the MEDIA button until the AUX mode is selected while the ignition switch is placed in the "ON" or "ACC" position.

## 4-62 Display screen, heater and air conditioner, and audio system

## CD PLAYER/RADIO (Type D)

17. ENTER/SETTING button

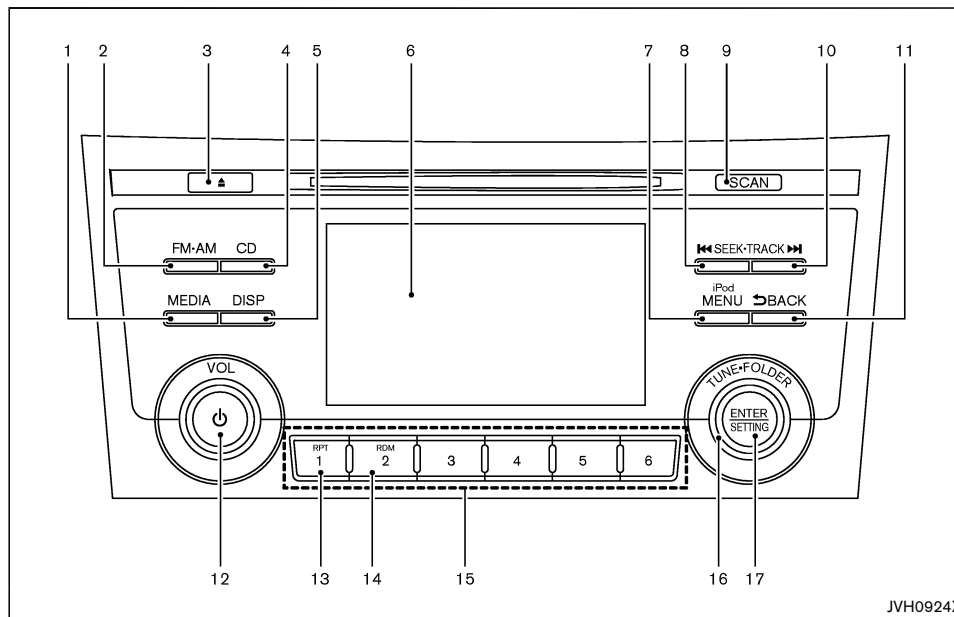

- |                               |   |
|-------------------------------|---|
| 1. MEDIA button               | 9. SCAN tuning button                   |
| 2. FM-AM button               | 10. SEEK-TRACK (fast forward) button    |
| 3. CD eject button            | 11. BACK button                         |
| 4. CD button                  | 12. Power/VOL (volume) dial             |
| 5. DISP (display) button      | 13. RPT (repeat) button                 |
| 6. Color display              | 14. RDM (random) button                 |
| 7. iPod MENU button           | 15. Radio station preset select buttons |
| 8. SEEK-TRACK (rewind) button | 16. TUNE-FOLDER dial                    |

Display screen, heater and air conditioner, and audio system 4-63

## Audio main operation

The audio system operates when the ignition switch is placed in the "ON" or "ACC" position.

### Head unit:

The auto loudness circuit enhances the low and high frequency ranges automatically in both radio reception and CD playback.

### Power/VOL dial:

Push Power/VOL dial to turn on and off the audio system.

Turn the Power/VOL dial to adjust the volume.

### Audio settings:

The settings screen will appear when pushing the ENTER/SETTING button.

The following items are available in the settings screen.

- Bluetooth (if equipped)  
It is possible to set the Bluetooth® settings. For details of the Bluetooth® settings, see "Bluetooth® audio player operation" (P.4-67).
- Bass, Treble, Balance and Fade  
Controls the sound of the audio system. Balance adjusts the sound between the left and right speakers. Fade adjusts the sound between the front and rear speakers.  
Select the "Bass", "Treble", "Balance" or "Fade" using the TUNE-FOLDER dial and then push the ENTER/SETTING button. Turn the TUNE-FOLDER dial to adjust the Bass, Treble, balance and Fade of the screen to the preferred level.
- Brightness and Contrast  
Adjust the brightness and contrast of the screen.  
Select the "Brightness" or "Contrast" using the TUNE-FOLDER dial and then push the ENTER/SETTING button. Turn the TUNE-FOLDER dial to

adjust the brightness and contrast of the screen to the preferred level.

- Clock Adjust  
Adjust the clock according to the following procedure.

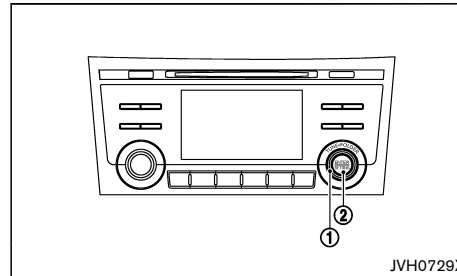

- 1) Select "Clock Adjust" using the TUNE-FOLDER dial ① and then push the ENTER/SETTING button ②.
  - 2) Adjust the hour with the TUNE-FOLDER dial ① and then push the ENTER/SETTING button ②.
  - 3) Adjust the minute with the TUNE-FOLDER dial ① and then push the ENTER/SETTING button ②.
- 24 hour clock is not available.

- On-Screen Clock  
When this item is turned on, a clock is always displayed in the upper right corner of the screen. Select the "On-Screen Clock" using the TUNE-FOLDER dial and then push the ENTER/SETTING button. You can toggle between ON and OFF using the TUNE-FOLDER dial.
- Radio frequency range and step  
See "Radio operation" (P.4-65).

- RDS Display (if equipped)  
RDS (radio data system) information can be shown on the display. Select "RDS Display" using the TUNE-FOLDER dial and then push the ENTER/SETTING button. You can toggle between ON and OFF using the TUNE-FOLDER dial.
- Speed Sensitive Vol.  
To change the Speed Sensitive Volume (Speed Sensitive Vol.) level from off (0) to 5, turn the TUNE-FOLDER dial.
- AUX Vol.  
Controls the volume level of incoming sound when an auxiliary device is connected to the system. Choose a setting between 1 and 3 or choose 0 to disable the feature entirely.
- Language Select  
The language settings can be changed.  
Select "Language Select" using the TUNE-FOLDER dial and then push the ENTER/SETTING button. Use the TUNE-FOLDER dial knob to select the preferred language.

### DISP button:

Display of the screen can be turned off without disrupting the music by pushing the DISP button. To turn the screen back on, either push the DISP button once more or push the FM-AM, CD, iPod MENU or the MEDIA button.

### MEDIA button:

Pushing the MEDIA button will switch the audio source as follows:

USB/iPod → Bluetooth (if equipped) → AUX → USB/iPod

## 4-64 Display screen, heater and air conditioner, and audio system

## Radio operation

### Frequency range and step change:

To change the frequency range and step specification of the radio, perform the following operations.

1. Push ENTER/SETTING button while the audio system is turned off.
2. Turn the TUNE-FOLDER dial until "Radio frequency range and step" is highlighted, and push the ENTER/SETTING button.
3. Turn the TUNE-FOLDER dial until the preferred region (Latin America, China, or Other) is displayed, and push the ENTER/SETTING button.
4. The system will restart automatically applying the frequency specification of the selected region.

FM•AM

### radio (FM•AM) band select:

Pushing the FM•AM button will change the band as follows:

AM → FM1 → FM2 → AM

### TUNE (Tuning):

Turn the radio TUNE-FOLDER dial for manual tuning.

### Radio Data System (RDS) (if equipped):

RDS stands for Radio Data System, and is a data information service transmitted by some radio stations on the FM band (not AM band) encoded within a regular radio broadcast. Currently, most RDS stations are in large cities, but many stations are now considering broadcasting RDS data.

RDS can display:

- Station name, such as "The Groove".
- Music or programming type such as "Classical", "Country" or "Rock".



### SEEK tuning:

Push the SEEK-TRACK (rewind) or SEEK-TRACK (fast forward) button to tune from low to high or high to low frequencies and to stop at the next broadcasting station.



### SCAN tuning:

Push the SCAN tuning button to tune from low to high frequencies and stop at each broadcasting station for 5 seconds. Pushing the button again during this 5 seconds period will stop SCAN tuning and the radio will remain tuned to that station.

If the SCAN tuning button is not pushed within 5 seconds, SCAN tuning moves to the next station.



### Station memory operations:

12 stations can be set for the FM band (6 each for FM1 and FM2) and 6 stations can be set for the AM band.

1. Choose the radio band using the FM•AM button.
2. Tune to the desired station using the SEEK-TRACK, SCAN button or the TUNE-FOLDER dial.
3. Push and hold the desired station preset button to .
4. The station indicator will then come on. Memorizing is now complete.
5. Other buttons can be set in the same manner.

If the battery cable is disconnected, or if the fuse opens, the station memory will be erased. In that case, reset the desired stations.

## CD player operation

Place the ignition switch in the "ON" or "ACC" position. Insert the Compact Disc (CD) into the slot with the label side facing up. The CD will be guided automatically into the slot and start playing.

After loading the CD, the number of tracks on the CD and the play time will appear on the display.

If the radio is already operating, it will automatically turn off and the CD will play.

If the system has been turned off while the CD was playing, pushing the Power/VOL dial will start the CD.



### CD PLAY:

When the CD button is pushed with the system off and the CD loaded, the system will turn on and the CD will start to play.

When the CD button is pushed with the CD loaded and the radio playing, the radio will automatically be turned off and the CD will start to play.



### SEEK/TRACK:

When the SEEK-TRACK (rewind) or SEEK-TRACK (fast forward) button is pushed for more than 1.5 seconds while the CD is being played, the CD will play while fast forwarding or rewinding. When the button is released, the CD will return to normal play speed.

When the SEEK-TRACK (rewind) or SEEK-TRACK (fast forward) button is pushed for less than 1.5 seconds while the CD is being played, the next track or the beginning of the current track on the CD will be played.

**RPT REPEAT (RPT):**

When the RPT button is pushed while the CD is played, the play pattern can be changed as follows:

(CD)

(Normal) ⇔ 1 Track Repeat

(CD with compressed audio files)

(Normal) → 1 Folder Repeat → 1 Track Repeat → (Normal)

**RDM RANDOM (RDM):**

When the RDM button is pushed while a CD is being played, the play pattern can be changed as follows:

(CD)

(Normal) ⇔ 1 Disc Random

(CD with compressed audio files)

(Normal) → 1 Disc Random → 1 Folder Random → (Normal)

**CD eject:**

When the CD eject button is pushed with the CD loaded, the CD will be ejected.

When this button is pushed while the CD is being played, the CD will be ejected.

**If the CD comes out and is not removed, it will be pulled back into the slot to protect it.**

**USB device player operation****USB main operation:**

The USB port is located on the lower part of the instrument panel. See "USB (Universal Serial Bus) connection port" (P.4-75). Connect a USB memory device into the connector. The USB memory device will be activated automatically.

If the system has been turned off while the USB memory device was playing, pushing the Power/VOL dial will start the USB memory device.

Refer to your device manufacturer's owner information regarding the proper use and care of the device.

**Play:**

When the MEDIA button is pushed with the system turned off and the USB device inserted, the system will turn on.

If another audio source is playing and a USB device is inserted, push the MEDIA button repeatedly until the color display changes to the USB device mode.

**⏮ ⏭ Previous/Next File and Fast Rewind/Forward:**

When the SEEK-TRACK (rewind) or SEEK-TRACK (fast forward) button is pushed for more than 1.5 seconds while a USB device is being played, the USB device will play while forwarding or rewinding. When the button is released, the USB device will return to normal play speed.

When the SEEK-TRACK (rewind) or SEEK-TRACK (fast forward) button is pushed for less than 1.5 seconds while the USB device is being played, the next track or the beginning of the current track on the USB device will be played.

**Folder selection:**

To change to another folder in the USB device, turn the TUNE-FOLDER dial.

**RPT REPEAT (RPT):**

When the RPT button is pushed while the USB device is played, the play pattern can be change as follows.

To change the play mode, push the RPT button repeatedly and the mode will change as follows.

(Normal) → 1 Folder Repeat → 1 Track Repeat → (Normal)

**RDM RANDOM (RDM):**

When the RDM button is pushed while a USB device is being played, the play pattern can be changed as follows.

To change the play mode, push the RDM button repeatedly, and the mode will change as follows.

(Normal) → All Random → 1 Folder Random → (Normal)

**iPod player operation****Connecting iPod:**

The USB port is located on the lower part of the instrument panel. See "USB (Universal Serial Bus) connection port" (P.4-75).

Connect the iPod cable to the USB port. The battery of the iPod is charged while the cable is connected to the vehicle.

Depending on the version of the iPod, the display on the iPod shows a NISSAN or Accessory Attached screen when the connection is completed. When the iPod is connected to the vehicle, the iPod music library can only be operated by the vehicle audio controls.

**4-66 Display screen, heater and air conditioner, and audio system**



\* iPod and iPhone are a trademark of Apple Inc., registered in the U.S. and other countries.

Refer to your device manufacturer's owner information regarding the proper use and care of the device.

#### Compatibility:

The following models are compatible:

- iPod nano 1G (Firmware version 1.3.1 -)
- iPod nano 2G (Firmware version 1.1.3 -)
- iPod nano 3G (Firmware version 1.0.0 -)
- iPod nano 4G (Firmware version 1.0.2 -)
- iPod nano 5G (Firmware version 1.0.1 -)
- iPod nano 6G (Firmware version 1.0 -)
- iPod nano 7G (Firmware version 1.0.0 -)
- iPod 5G (Firmware version 1.2.1 -)
- iPod classic (Firmware version 1.0.0 -)
- iPod Touch (iOS 1.1 -)
- iPod Touch 2G (iOS 2.1.1 -)
- iPod Touch 3G (iOS 3.1 -)
- iPod Touch 4G (iOS 4.1 -)
- iPod Touch 5G (iOS 6.0.0 -)
- iPhone (iOS 1.0.0 - 2.2.1)
- iPhone 3G (iOS 2.1 -)
- iPhone 3GS (iOS 3.0 -)
- iPhone 4/4S (iOS 4.0 -)
- iPhone 5 (iOS 6.0.0 -)

Operations attributable to firmware update by Apple are not guaranteed.

#### iPod main operation:

The system operates when the ignition switch is in the "ON" or "ACC" position. Push the MEDIA button repeatedly or push the iPod MENU button to switch to the iPod mode.

If the system has been turned off while the iPod was

playing, pushing the Power/VOL dial will start the iPod. If another audio source is playing and the iPod is connected, pushing the iPod MENU button or the MEDIA button repeatedly will change to the iPod mode.

When the iPod MENU button is pushed while the iPod is connected, the interface for iPod operation is shown on the audio display. The items on the menu list can be scrolled by turning the TUNE-FOLDER dial while the iPod is operating. To select an item, push ENTER/SETTING button. Items in the iPod menu appear on the display in the following order.

- Now playing
- Playlists
- Artists
- Albums
- Songs
- Podcasts
- Genres
- Composers
- Audiobooks
- Shuffle Songs

Push the BACK button to return to the previous screen.

For more information about each item, see the iPod Owner's Manual.



#### Previous/Next Track and Fast Re-wind/Forward:

When the SEEK-TRACK (rewind) or SEEK-TRACK (fast forward) button is pushed for more than 1.5 seconds while the iPod is playing, the iPod will play while fast forwarding or rewinding. When the button is released, the iPod will return to the normal play speed.

When the SEEK-TRACK (rewind) or SEEK-TRACK (fast forward) button is pushed for less than 1.5 seconds while the iPod is playing, the next track or the beginning of the current track on the iPod will be played.

#### RPT REPEAT (RPT):

When the RPT button is pushed while a track is being played, the play pattern can be changed as follows:

(Repeat off) → 1 Track Repeat → All Repeat → (Repeat off)

#### RDM RANDOM (RDM):

When the RDM button is pushed while a track is being played, the play pattern can be changed as follows:

(Shuffle off) → Track Shuffle → (Shuffle off)

#### Bluetooth® audio player operation (if equipped)

If you have a compatible Bluetooth® audio device that is capable of playing audio files, the device can be connected to the vehicle's audio system so that the audio files on the device play through the vehicle's speakers.

**Regulatory information:****Bluetooth® trademark:**

Bluetooth® is a trademark owned by Bluetooth SIG, Inc. and licensed to Visteon Corporation.

**Connecting Bluetooth® device:**

To connect your Bluetooth® device to the vehicle, follow the procedure below:

1. Push the ENTER/SETTING button.

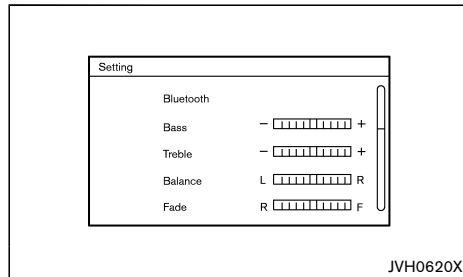

2. Select the "Bluetooth" key.
3. Select the "Add Phone or Device" key. This same screen can be accessed to remove, replace or select a different Bluetooth® device.
4. The system acknowledges the command and asks you to initiate connecting from the Bluetooth® device. The connecting procedure of the Bluetooth® device varies according to each cellular phone model. See the Owner's manual of the Bluetooth® device for details.

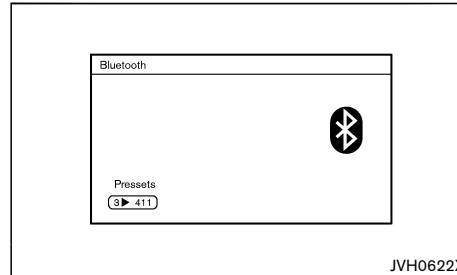
**Bluetooth® audio main operation:**

To switch to the Bluetooth® audio mode, push the MEDIA button repeatedly until the Bluetooth® audio mode is displayed on the screen.

The controls for the Bluetooth® audio are displayed on the screen. Use the Preset 3 button to play and use the Preset 4 button to pause.

**AUX device player operation**

The AUX input jack is located on the lower part of the instrument panel. (See "AUX (auxiliary) input jack" (P.4-75).) The AUX audio input jack accepts any standard analog audio input such as from a portable cassette tape/CD player, MP3 player or laptop computer.

NISSAN strongly recommends using a stereo mini plug cable when connecting your music device to the audio system. Music may not play properly when a monaural cable is used.

**MEDIA MEDIA button:**

To switch to the AUX mode, push the MEDIA button until the AUX mode is selected while the ignition switch is placed in the "ON" or "ACC" position.

**4-68 Display screen, heater and air conditioner, and audio system**

### CD PLAYER/RADIO (Type E)

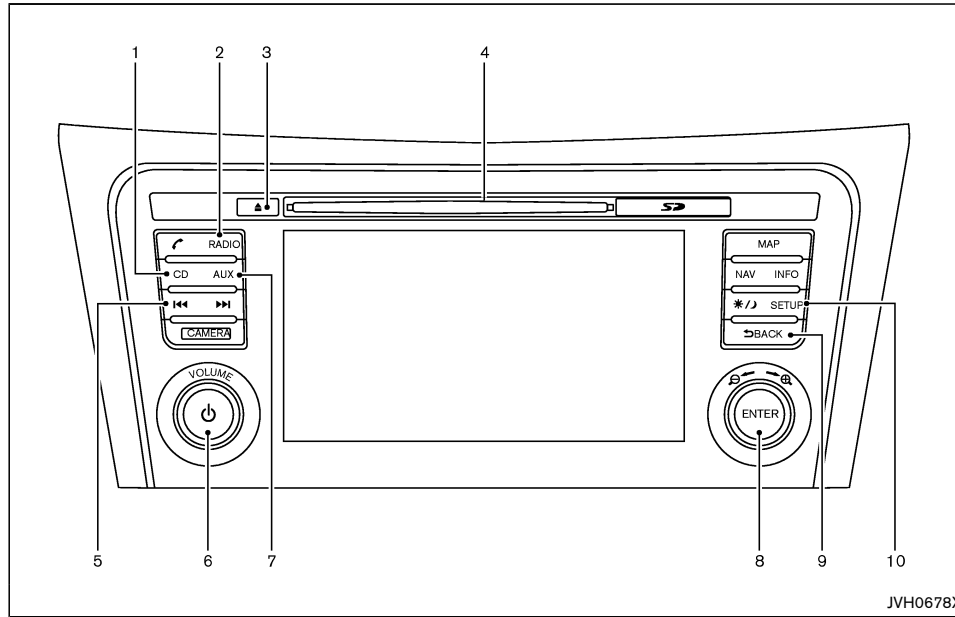

Models with RADIO button

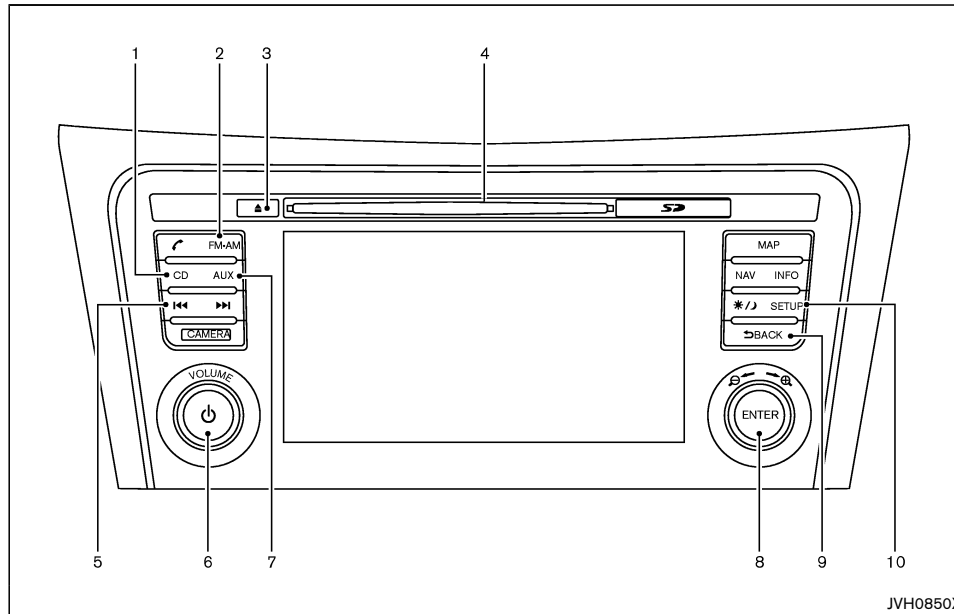

Models with FM-AM button

1. CD button
2. RADIO/FM-AM button
3. Disc eject button
4. Disc insert slot
5. Seek/Track buttons
6. Power/VOLUME dial
7. AUX (auxiliary) button
8. ENTER/Scroll dial
9. BACK button
10. SETUP button

#### Audio main operation

The audio system operates when the ignition switch is placed in the "ON" or "ACC" position.

#### Power/VOLUME dial:

Push Power/VOLUME dial to turn on and off the audio system.

Turn the Power/VOLUME dial to adjust the volume.

This vehicle may be equipped with Speed Sensitive Volume (SSV) function for audio. When this function is turned on, the audio volume will be adjusted auto-

matically as the vehicle speed changes. For operations to turn on and off the SSV function, see "Audio settings" (P.4-5).

#### Audio settings:

For the operations to adjust the audio settings, see "Audio settings" (P.4-5).

#### Traffic Announcement (if equipped):

Touch "TA" on the audio screen to turn on or off the Traffic Information setting. When it is turned on, the Traffic Information will interrupt the music that was playing and informs the driver of the received traffic information.

#### Radio operation

The audio system operates when the ignition switch is placed in the "ON" or "ACC" position.

#### Radio band select button:

Push the Radio band select button to change the band as follows:

#### For Australia, New Zealand and Europe:

AM → DAB → FM → AM

#### For Mexico:

AM → FM1 → FM2 → AM

#### Except for Australia, New Zealand, Europe and Mexico:

AM → FM → AM

If another audio source is playing when the RADIO/FM-AM button is pushed, the audio source playing will automatically be turned off and the last radio station played will begin playing.

## 4-70 Display screen, heater and air conditioner, and audio system

**Radio tuning:**

When in radio mode, the radio can be tuned using the touchscreen. To bring up the visual tuner, touch the "Tune" key on the lower part of the screen. A screen appears with a bar running from low frequencies on the left to high frequencies on the right.

One of the following operations can be used for tuning.

- Touching the bar on the screen
- Touching "◀"/"▶" on the screen
- Turning ENTER/Scroll dial

To return to the regular radio display screen, touch the "OK" key.

**Station List:**

When in FM or DAB (if equipped) mode, touch "FM List" or "DAB List" to display the station lists.

**Seek/Track buttons:**

When in radio mode, push the Seek/Track buttons to tune from low to high or high to low frequencies and to stop at the next broadcasting station.

**Station memory keys:**

Up to six stations can be stored for AM band, and up to twelve stations can be stored for each of the other bands.

1. Choose the radio band using the Radio band select button.
2. Tune to the desired station using manual or seek tuning. Touch and hold any of the desired station memory keys until a beep sound is heard.

For FM and DAB (if equipped), touch the "7-12" key to display the 7 - 12 memory keys.

3. The channel indicator will then come on and the sound will resume. Programming is now complete.

**DAB operation (if equipped):**

In the DAB mode, the following operation keys and information are available.

- DAB List:  
Touch to display the available station list.
- TA:  
Touch this key to turn on and off the TA (Traffic Announcement) mode. When turned on, received TA will interrupt the audio source that is playing.
- Extra chan.:  
The "Extra chan." key will allow access to extra stations transmitted within the group of the currently selected station. If extra stations are not available within the group, the key will not operate.
- Radio text:  
Radio text is shown on the DAB main screen underneath the DAB station name. This displays radio program and song information as determined by the DAB station.

EAS in EAS test (displayed on the screen as a PTY name) is an abbreviation of Emergency Alert System.

Occasionally, in areas of poor DAB signal strength, the full station name in the DAB List and DAB main screen might be distorted. In this situation it may still be possible to listen to the particular radio station, at a reduced level of sound quality, but this is not always possible. This may also be shown in the vehicle information display.

**CD player operation****Loading disc:**

Insert a CD into the slot with the label side facing up. The CD will be guided automatically into the slot and will start playing. If the radio is already playing, it will automatically turn off, and the CD will start playing.

**CAUTION:**

**Do not force the compact disc into the slot. This could damage the player.**

**CD button:**

When the CD button is pushed with the system off and the CD loaded, the system will turn on and the CD will start to play.

When the CD button is pushed with a CD loaded while the radio playing, the radio will turned off and the CD will start to play.

**Seek/Track button:**

When the Seek/Track (rewind/fast forward) button is pushed for more than 1.5 seconds while the CD is being played, the CD will play while fast forwarding or rewinding. When the button is released, the CD will return to normal play speed.

When the Seek/Track (rewind) or Seek/Track (fast forward) button is pushed for less than 1.5 seconds while the CD is being played, the next track or the beginning of the current track on the CD will be played. Push the button several times to skip through the tracks on the CD. If the last track on a CD is skipped, the first track on the disc will play. If the last track in a folder of an MP3 CD is skipped, the first track of the next folder will play.

**CD/MP3/WMA display mode:**

While listening to a CD or an MP3/WMA CD, certain text may be displayed (when a CD encoded with text is being used). Depending on how the CD or MP3/WMA CD is encoded, the text is displayed listing the artist, album and song title. Operation keys are also displayed on the screen.

**Mix:**

Touching the “Mix” key while an CD or MP3 CD is playing will alternate the random play pattern as follows:

(CD)

(Normal) → Mix → (Normal)

(CD with compressed audio files)

(Normal) → Random Folder → Random All → (Normal)

**Repeat:**

Touching the “Repeat” key while an CD or MP3 CD is playing will alternate the repeat play pattern as follows:

(CD)

(Normal) → Repeat → (Normal)

(CD with compressed audio files)

(Normal) → Repeat Track → Repeat Folder → (Normal)

**Browse:**

Touch the “Browse” key to display the titles on the CD in list format. Touch the title of a song in the list to begin playing that song. If an MP3 CD is playing, touching the “Browse” key will also list the folders on the disc. Touch the “Folder Up” key to view the lists in the upper layer. Follow the procedure for selecting a song with the touchscreen to choose a folder.

**Disc eject button:**

When the Disc eject button is pushed while a CD is loaded, the CD will be ejected.

If the CD is not removed within 10 seconds, the CD will be reloaded.

**USB device operation**

The audio system operates when the ignition switch is placed in the “ON” or “ACC” position.

The USB port is located on the lower part of the instrument panel. See “USB (Universal Serial Bus) connection port” (P.4-75). Connect a USB memory device into the connector. The USB memory device will be activated automatically.

Refer to your device manufacturer’s owner information regarding the proper use and care of the device.

**USB main operation:**

If another audio source is playing and a USB memory device is inserted, push the AUX button until the screen on the display changes to the USB memory mode.

If the system has been turned off while the USB memory device was playing, push the Power/VOLUME dial to restart the USB memory device.

Touch the name of a song on the screen to begin playing that song.

**USB screen operation:**

While files on a USB memory device are playing, the play pattern can be altered so that songs are repeated or played randomly.

**Mix:**

Touching the “Mix” key on the screen while an USB memory device is playing will alternate the random play pattern as follows:

(Normal) → Random Folder → Random All → (Normal)

**Repeat:**

Touching the “Repeat” key on the screen while an USB memory device is playing will alternate the repeat play pattern as follows:

(Normal) → Repeat Track → Repeat Folder → (Normal)

**Browse:**

Touch “Browse” key to display USB interface. Select the songs you wish to play by touching the item on the screen.

**Seek/Track buttons:**

Push the Seek/Track (rewind) button while an audio file on the USB memory device is playing to return to the beginning of the current track. Push the button several times to skip backward several tracks.

Push the Seek/Track (fast forward) button while an audio file on the USB memory device is playing to advance one track. Push the button several times to skip forward several tracks. If the last track on the USB memory device is skipped, the first track of the next folder is played.

**4-72 Display screen, heater and air conditioner, and audio system**

## iPod player operation

### Connecting iPod:

The USB port is located on the lower part of the instrument panel. See "USB (Universal Serial Bus) connection port" (P.4-75).

If your iPod supports charging via a USB connection, its battery will be charged while connected to the vehicle with the ignition switch placed in the "ON" or "ACC" position.

### Compatibility:

The following models are compatible:

- iPod 5th Generation (firmware version 1.2.3 or later)
- iPod Classic (firmware version 1.1.1 or later)
- iPod Touch (firmware version 2.0.0 or later)\*
- iPod nano - 1st generation (firmware version 1.3.1 or later)
- iPod nano - 2nd generation (firmware version 1.1.3 or later)
- iPod nano - 3rd generation (firmware version 1.1.3 or later)
- iPod nano - 4th generation (firmware version 1.0.4 or later)
- iPod nano - 5th generation (firmware version 1.0.1 or later)

\* Some features of this iPod may not be fully functional.

Make sure that your iPod firmware is updated to the version indicated above.

### iPod main operation:

If the system has been turned off while the iPod was playing, pushing the Power/VOLUME dial will start the iPod.

If another audio source is playing and a iPod is

connected, push the AUX button until the screen on the display changes to the iPod mode.

Refer to your device manufacturer's owner information regarding the proper use and care of the device.

### Interface operation:

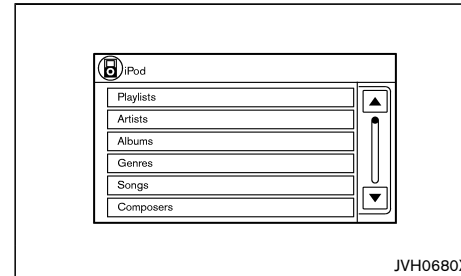

The interface for iPod operation shown on the vehicle's audio system display screen is similar to the iPod interface. Use the touchscreen, BACK button or the ENTER/Scroll dial to navigate the menus on the screen.

When the iPod is playing, touch the "Menu" key to bring up the iPod interface.

Depending on the iPod model, the following items may be available on the menu list screen. For further information about each item, see the iPod Owner's Manual.

- Playlists
- Artists
- Albums
- Genres
- Songs

- Composers
- Audiobooks
- Podcasts

### Scrolling menus:

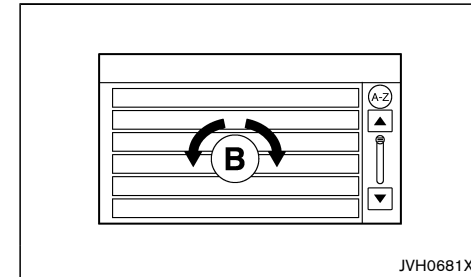

While navigating long lists of artists, albums or songs in the music menu, it is possible to scroll the list by the first character in the name. To activate character indexing, touch the "A-Z" key in the upper right corner of the screen. Turn the ENTER/Scroll dial to choose the number or letter to jump to in the list and then push the ENTER/Scroll dial.

If no character is selected after thirty seconds, the display returns to normal.

### Random and repeat play mode:

While the iPod is playing, the play pattern can be altered so that songs are repeated or played randomly.

#### Mix:

Touching the "Mix" key on the screen while an iPod is playing will alternate the random play pattern as follows:

(Normal) → Shuffle Songs → (Normal)

**Repeat:**

Touching the "Repeat" key on the screen while an iPod is playing will alternate the repeat play pattern as follows:

(Normal) → Repeat Song → (Normal)

**Seek/Track buttons:**

Push the Seek/Track (rewind) or Seek/Track (fast forward) button to skip backward or forward one track.

Push and hold the Seek/Track (rewind) or Seek/Track (fast forward) button for 1.5 seconds while a track is playing to reverse or fast forward the track being played. The track plays at an increased speed while reversing or fast forwarding. When the button is released, the track returns to normal play speed.

**Bluetooth® audio player operation**

If you have a compatible Bluetooth® audio device that is capable of playing audio files, the device can be connected to the vehicle's audio system so that the audio files on the device play through the vehicle's speakers

**Bluetooth® trademark:**

Bluetooth® is a trademark owned by Bluetooth SIG, Inc. and licensed to Bosch.

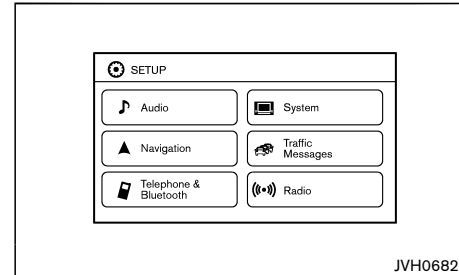
**Connecting Bluetooth® audio:****Example**

To connect your Bluetooth® audio device to the vehicle, follow the procedure below:

1. Push the SETUP button.
2. Select the "Telephone & Bluetooth" key.
3. Select the "Pair New Device" key.
4. The system acknowledges the command and asks you to initiate connecting from the phone handset. The connecting procedure of the cellular phone varies according to each cellular phone model. See the Bluetooth® device Owner's Manual for details.

**Bluetooth® audio player main operation:**

To switch to the Bluetooth® audio mode, push the AUX button repeatedly until the Bluetooth® audio mode is displayed on the screen.

The controls for the Bluetooth® audio are displayed on the screen.

**AUX device player operation**

The AUX input jack is located on the lower part of the instrument panel. (See "AUX (auxiliary) input jack" (P.4-75).) The AUX audio input jack accepts any standard analog audio input such as from a portable cassette tape/CD player, MP3 player or laptop computer.

NISSAN strongly recommends using a stereo mini plug cable when connecting your music device to the audio system. Music may not play properly when a monaural cable is used.

**AUX button:**

To switch to the AUX mode, push the AUX button until the AUX mode is selected while the ignition switch is placed in the "ON" or "ACC" position.

**NISSANCONNECT APP SMARTPHONE INTEGRATION (if equipped)**

This vehicle is equipped with Smartphone Integration technology. This allows many compatible Smartphone applications to be displayed and easily controlled through the vehicle's touchscreen.

**NOTE:**

**A compatible smartphone and registration is required to use mobile applications or to access connected features of certain vehicle applications.**

**Registering with NissanConnect App**

To use the Smartphone Integration feature, it is necessary for the user to register. In order to register, visit the NissanConnect website for more information and to sign up. Once registered, download the NissanConnect Mobile App from your compatible phone's application download source and then log



into the application.

For Mexico:

For more information about this technology, visit the website [www.nissan.com.mx/connect](http://www.nissan.com.mx/connect) or [www.nissan-connect.com.mx](http://www.nissan-connect.com.mx) or contact NISSAN Customer Service 01 800 964 77 26 (01 800 9 NISSAN).

### Connecting phone

To use this feature, a compatible smartphone must be connected via Bluetooth® or USB to the vehicle. For the Bluetooth® connecting procedure, see “Bluetooth® Hands-Free Phone System (Type D)” (P.4-94) or “Bluetooth® Hands-Free Phone System (Type B)” (P.4-84).

#### NOTE:

- For Apple iPhones, NissanConnect Apps **REQUIRES** the phone to be plugged in via USB.
- For Vehicles without Navigation, Apple iPhones must be paired via Bluetooth® for NissanConnect Apps to function.
- For Android phones, NissanConnect Apps **REQUIRES** the phone to be paired via Bluetooth®.

### Application download

Once connected, the NissanConnect Mobile App will search your phone to determine which compatible applications are currently installed. The vehicle will then download the in-vehicle interface for each of these compatible applications. Once downloaded, the user can access many smartphone Applications through the vehicle touchscreen by pushing the INFO button followed by touching the “My Apps” key. For more information on application availability visit the

NissanConnect website.

For Mexico:

For more information on application availability visit the NissanConnect™ website [www.nissanconnect.com.mx](http://www.nissanconnect.com.mx) or [www.nissan.com.mx/connect](http://www.nissan.com.mx/connect) or contact NISSAN Customer Service 01 800 9 64 77 26 (01 800 9 NISSAN).

### USB (Universal Serial Bus) CONNECTION PORT



#### WARNING:

**Do not connect, disconnect or operate the USB device while driving. Doing so can be a distraction. If distracted you could lose control of your vehicle and cause an accident or serious injury.**



#### CAUTION:

- Do not force the USB device into the USB port. Inserting the USB device tilted or upside-down into the port may damage the port. Make sure that the USB device is connected correctly into the USB port.
- Do not grab the USB port cover (if equipped) when pulling the USB device out of the port. This could damage the port and the cover.
- Do not leave the USB cable in a place where it can be pulled unintentionally. Pulling the cable may damage the port.

Refer to your device manufacturer's owner information regarding the proper use and care of the device.

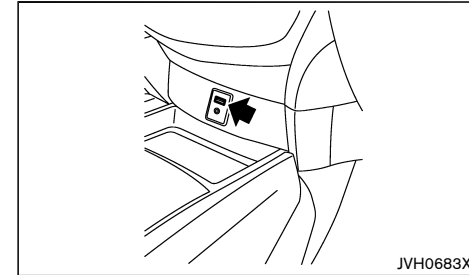

The USB port is located on the lower part of the instrument panel. Insert USB devices or iPod connectors into this port.

### AUX (auxiliary) INPUT JACK

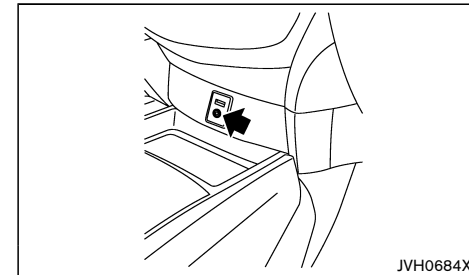

The AUX input jack is located on the lower part of the instrument panel. Compatible audio devices, such as some MP3 players, can be connected to the system through the AUX input jack.

Before connecting a device to a jack, turn off the power of the portable device.

With a compatible device connected to the jack, push the corresponding button (depends on the audio

system) repeatedly until the display switches to the AUX mode.

NISSAN strongly recommends using a stereo mini plug cable when connecting your music device to the audio system. Music may not play properly when a monaural cable is used.

### STEERING WHEEL MOUNTED CONTROLS FOR AUDIO (Type A) (if equipped)

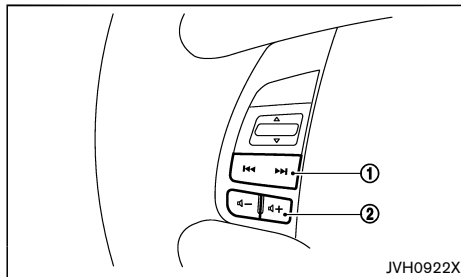

1. Tuning button
2. Volume control button

#### Tuning button

##### Radio:

- Push the tuning button for less than 1.5 seconds to change the next or previous radio preset.
- Push the tuning button for more than 1.5 seconds to seek the next or previous radio station.

##### CD:

- Push the tuning button for less than 1.5 seconds to shift to the next track or the beginning of the current track (the previous track if the button is pushed immediately after the current track starts playing).

## 4-76 Display screen, heater and air conditioner, and audio system

- Push the tuning button for more than 1.5 seconds to forward or rewind the track.

### CD with MP3, iPod, USB memory or Bluetooth® Audio:

- Push the tuning button for less than 1.5 seconds to shift to the next track or the beginning of the current track (the previous track if the button is pushed immediately after the current track starts playing).
- CD Player/Radio (Type A, B and E):  
Push the tuning button for more than 1.5 seconds to forward or rewind the track.
- CD Player/Radio (Type C and D):  
Push the tuning button for more than 1.5 seconds to shift to the next or the previous folder (When the last folder is playing, the first folder will be selected).

#### Volume control button

Push the + or - button to increase or decrease the volume.

### STEERING WHEEL MOUNTED CONTROLS FOR AUDIO (Type B) (if equipped)

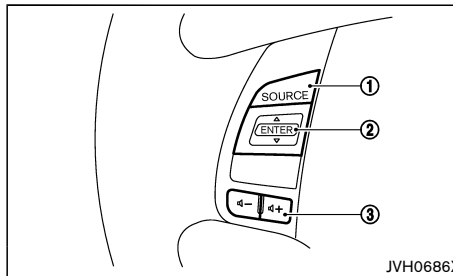

1. SOURCE select button
2. Tuning button
3. Volume control button

#### SOURCE select button

Push the source select button to change the mode to available audio source.

#### Tuning button

Push the button upward or downward to select a channel, track, CD or folder when they are listed on the display.

Depending on the status of the vehicle information display, the tuning button cannot be used for audio control.

##### RADIO:

- Pushing DOWN ▼ /UP ▲ shorter  
Next or previous preset channel
- Pushing DOWN ▼ /UP ▲ longer  
Next or previous station/channel

##### CD:



- Pushing DOWN ▼ /UP ▲ shorter  
Next track or the beginning of the current track (the previous track if the button is pushed immediately after the current track starts playing)
- Pushing DOWN ▼ /UP ▲ longer  
Forward or rewind

### CD with MP3/WMA/iPod (if equipped), USB device (if equipped) or Bluetooth® audio (if equipped):

- Pushing DOWN ▼ /UP ▲ shorter  
Next track or the beginning of the current track (the previous track if the button is pushed immediately after the current track starts playing)

- Pushing DOWN ▼ /UP ▲ longer  
Folder change (When the last folder is changed,  
the next disc will be selected.)

#### Volume control button

Push the  + or  - button to increase or decrease the volume.

#### DISC/USB MEMORY CARE AND CLEANING

##### Disc

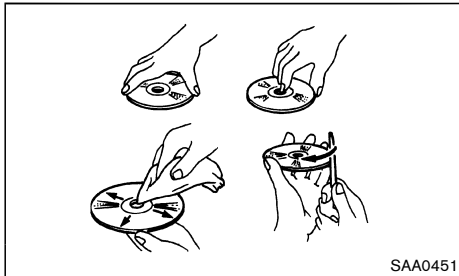

- Handle a disc by its edges. Never touch the surface of the disc. Do not bend the disc.
- Always place the discs in the storage case when they are not being used.
- To clean a disc, wipe the surface from the center to the outer edge using a clean, soft cloth. Do not wipe the disc using a circular motion.  
Do not use a conventional record cleaner or alcohol intended for industrial use.
- A new disc may be rough on the inner and outer edges. Remove the rough edges by rubbing the inner and outer edges with the side of a pen or pencil as illustrated.

#### USB memory

- Do not touch the terminal portion of the USB memory.
- Do not place heavy objects on the USB memory.
- Do not store the USB memory in highly humid locations.
- Do not expose the USB memory to direct sunlight.
- Do not spill any liquids on the USB memory.

Refer to the USB memory Owner's Manual for the details.

## CAR PHONE OR CB RADIO

When installing a CB, ham radio or a car phone in your vehicle, be sure to observe the following cautions, otherwise the new equipment may adversely affect the Engine Control System and other electronic parts.



#### CAUTION:

- **Keep the antenna as far away as possible from the Electronic Control Module.**
- **Keep the antenna wire at least 20 cm (8 in) away from the Engine Control harnesses. Do not route the antenna wire next to any harnesses.**
- **Adjust the antenna standing wave ratio as recommended by the manufacturer.**
- **Connect the ground wire from the radio chassis to the body.**
- **For details, consult a NISSAN dealer.**

## Bluetooth® HANDS-FREE PHONE SYSTEM (Type A)

**\*Type A is for models without navigation system (without color display).**

### **WARNING:**

- **Use a phone after stopping your vehicle in a safe location. If you have to use a phone while driving, exercise extreme caution at all times so full attention may be given to vehicle operation.**
- **If you find yourself unable to devote full attention to vehicle operation while using the phone, pull off the road to a safe location and stop your vehicle before doing so.**

### **CAUTION:**

**To avoid draining the vehicle battery, use a phone after starting the engine.**

Bluetooth® is a wireless radio communication standard. This system offers a hands-free facility for your cellular phone to enhance driving comfort.

To use the Bluetooth® Hands-Free Phone System, your cellular phone must first be setup. For details, see "Bluetooth® settings" (P.4-79). Once it has been setup, the hands-free mode is automatically activated on the registered cellular phone (via Bluetooth®) when it comes into range.

A notification message appears on the audio display when the phone is connected, when an incoming call is being received, as well as when a call is initiated.

When a call is active, the audio system, microphone, and steering wheel mounted control buttons enable hands-free communication.

If the audio system is in use at the time, the radio, CD,

iPod, USB audio, Bluetooth® audio or AUX source mode will be muted and will stay muted until the active call has ended.

The Bluetooth® system may not be able to connect with your cellular phone for the following reasons:

- The cellular phone is too far away from the vehicle.
- The Bluetooth® mode on your cellular phone has not been activated.
- Your cellular phone has not been paired with the Bluetooth® system of the audio unit.
- The mobile phone does not support Bluetooth® technology.

### **NOTE:**

- **For details, see your cellular phone's Owner's Manual.**
- **For assistance with your cellular phone integration, please visit your local NISSAN dealer.**

## REGULATORY INFORMATION

### Bluetooth® trademark



Bluetooth® is a trademark owned by Bluetooth SIG, Inc. and licensed to Visteon Corporation.

### CE statement

Hereby Visteon Corp. declares that this system is in compliance with the essential requirements and other relevant provisions of Directive 1999/5/EC.





### **NOTE:**

**The audio system only supports Bluetooth® devices with AVRCP (Audio Video Remote Control Profile) version 1.3, or 1.0 or earlier.**

## CONTROL BUTTONS AND MICROPHONE

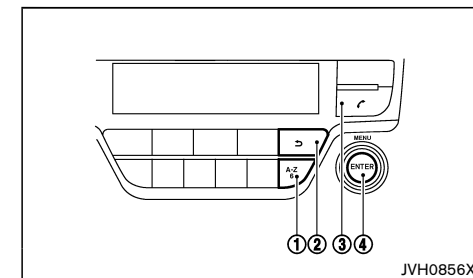
### Instrument panel:



1. Phonebook quick search button
2. Back  button

## 4-78 Display screen, heater and air conditioner, and audio system

3. Phone  button
4. MENU/ENTER dial



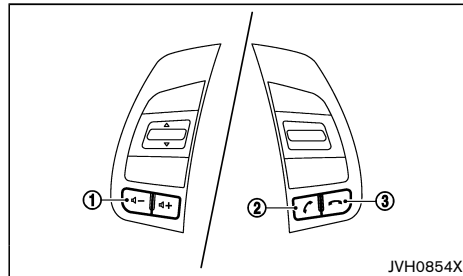

#### Steering wheel mounted control:

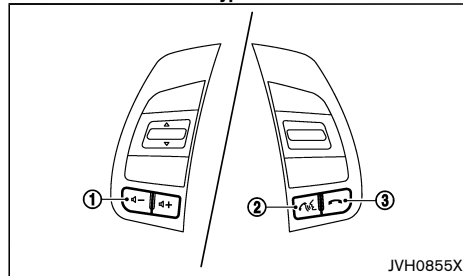

**Type A**



**Type B**

1. Volume control  -/  + buttons  
Push the buttons to increase or decrease the volume of the speakers.
2. Phone send  /  button
  - Accept an incoming call by pushing once.
  - Redial the last outgoing call by pushing the button for more than 2 seconds.

3. Phone end  button
  - Reject an incoming call by pushing the button during an incoming call.
  - End an active call by pushing the button once.

#### Microphone:



Microphone is located near the map lights.

#### Bluetooth® SETTINGS

##### Pairing device

Enter the phone setup menu via the  button on the instrument panel, select the "Bluetooth" key, and then check if the Bluetooth® is set to on. (If not push the MENU/ENTER dial to turn it on.)

To setup the Bluetooth® system to pair (connect or register) your preferred cellular phone, follow the following procedure.

1. To pair a device, select the "Scan device" key or the "Pair device" key on the display.
  2. A notification message will be displayed when the phone is successfully paired.
  3. The display will return to the current audio source status after the connection is complete.
- While the Bluetooth® connection is active, the following icons will appear on the display.
    - : Signal strength indicator
    - : Battery status indicator\*
    - : Bluetooth® connection ON indicator
  - \*: If low battery is indicated, the Bluetooth® device must be recharged soon.
  - Up to 5 different Bluetooth® devices can be connected. However, only one device can be used at a time. If 5 different Bluetooth® devices are registered, a new device can only replace one of the 5 existing paired devices.

- The pairing procedure and operation may vary according to device type and compatibility. See the Bluetooth® device Owner's Manual for further details.

#### Setting items

To set up the Bluetooth® system with a device, the following items are available:

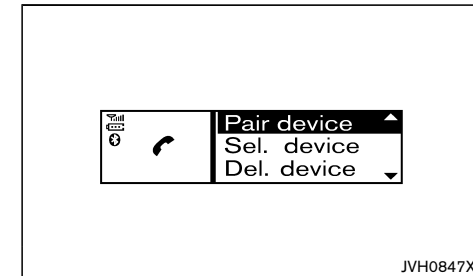

- Scan devices  
Shows all available visible Bluetooth® devices and initializes Bluetooth® connection from the audio unit.
- Pair device  
Initializes Bluetooth® connection from the mobile device.
- Sel. device  
Paired Bluetooth® devices are listed and can be selected for connection.
- Del. device  
A registered Bluetooth® device can be deleted.
- Bluetooth  
If this setting is turned off, the connection between the Bluetooth® devices and the in-vehicle Bluetooth® module will be cancelled.

#### Display screen, heater and air conditioner, and audio system 4-79

**Scan device:**

1. Push the  button on the instrument panel. Select "Scan device" key. The audio unit searches for the Bluetooth® devices and shows all devices that were found.

Make sure your Bluetooth® device is available at this time.

2. Select the device to be paired using the MENU/ENTER dial.
3. The pairing procedure depends on the device to be connected:

- a. Device without PIN code:

The Bluetooth® connection will be automatically connected without any further input.

- b. Device with PIN code:

Two different ways of pairing are possible depending on the device:

- Type A:

The message "To pair" and "Enter Pin" 0000 will be displayed.

Confirm the PIN code on the device. The Bluetooth® connection will be made.

- Type B:

The message "Pairing request" and "Confirm password" together with a 6 digit code will be displayed. The unique and identical code should be displayed on the device. If the code is identical confirm on the device.

The Bluetooth® connection will be made.

**Pair device:**

- Turn on the Bluetooth® on the audio unit. See "Bluetooth" (P.4-80).

- Use the audio unit to pair:

Push the  button on the instrument panel. Select the "Pair Device" key.

The pairing procedure depends on the Bluetooth® device to be connected:

- 1) Device without PIN code:

The Bluetooth® connection will be automatically connected without any further input.

- 2) Device with PIN code:

Two different ways of pairing are possible depending on the device. For the correct procedure details, see "Scan device" (P.4-80).

- Use the Bluetooth® audio/cellular phone device to pair:

- 1) Switch on the search mode for Bluetooth® devices.

If the search mode finds the audio unit it will be shown on the device display.

- 2) Select the unit device shown as "My Car".



- 3) Enter the number code shown on the relevant device with the device's own keypad, and push the confirmation key on the Bluetooth® device.

Refer to the relevant Bluetooth® device Owner's Manual for further details.

**Sel. device:**

The paired device list shows which Bluetooth® audio or cellular phone devices have been paired or registered to the system. Select the appropriate device to connect to the system.

The following icons (if equipped) indicate the capability of the registered device:

-  : Cellular phone integration
-  : Audio streaming (A2DP – Advanced Audio Distribution Profile)

**Del. device:**

A registered device can be removed from Bluetooth® system registration. Select a registered device and push the MENU/ENTER dial to confirm to deletion.

**Bluetooth:**

If Bluetooth® signal has been turned off, a notification message "ON/OFF" appears when you select "Bluetooth" from the phone menu. (Push the  button to display the phone menu.) To turn the Bluetooth® signal on, push the MENU/ENTER dial and a follow up screen will appear. Select "ON" and push the MENU/ENTER dial to display the Bluetooth® settings menu screen.

**USING THE SYSTEM**

The hands-free mode can be operated using the  button on the instrument panel.

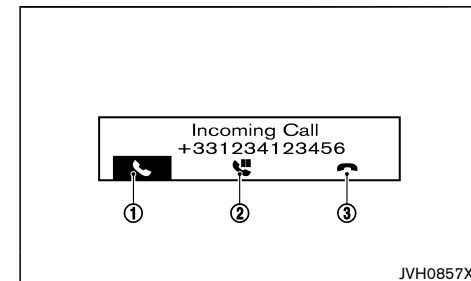

**Receiving a call**

When receiving an incoming call, the display on the audio unit will show the caller's phone number (or a notification message that the caller's phone number





**4-80 Display screen, heater and air conditioner, and audio system**

cannot be shown) and three operation icons as illustrated. To highlight different icons, turn the MENU/ENTER dial. Push the MENU/ENTER dial to select the highlighted icon.



### ① Answering and during a call:

Answer the call by selecting  on the display or by pushing  /  on the steering wheel.



During the call, the following icons are available:

-  :  
Select this item to end the call.
-  :  
Select this item to put the call on hold.
-  :  
Select this item to transfer the call from the hands-free phone system to your cellular phone.
-  :  
Select this item to transfer the call back to the hands-free phone system from the cellular phone.
- #123:  
Select this item to enter numbers during a call. For example, use this function when directed by an automated phone system to dial an extension number.

### ② Putting a call on hold:

To put a call on hold, select . Select  to return to the call. To reject the call select .

### ③ Rejecting a call:

To reject an incoming call, select  or by pushing  on the steering wheel.

## Making a call



### WARNING:

**Park the vehicle in a safe location, and apply the parking brake before making a call.**



A call can be initiated using one of the following methods:

- Making a call from the phonebook
- Manually dialing a phone number
- Redialing
- Using call history (Call List menu)
  - Dialed
  - Received
  - Missed

## Making a call from the phonebook:

Once the Bluetooth® connection has been made between the registered cellular phone and the hands-free phone system, phonebook data will be transferred automatically to the hands-free phone system. The transfer may take a while before completion.



### NOTE:

#### Phone book data will be erased when:

- **Switching to another registered cellular phone.**
- **Cellular phone is disconnected.**
- **The registered cellular phone is deleted from the audio system.**

1. Push the  button on instrument panel.
2. Turn the MENU/ENTER dial to highlight "Phone Book" and push the MENU/ENTER dial.
3. Scroll down through the list, select the appropriate contact name (highlighted), and push the MENU/ENTER dial.
4. The screen will show the number to be dialed. Push the MENU/ENTER dial to dial the number.

If more than one number is registered, select an appropriate icon.

-  : Home
-  : Cellular phone
-  : Office

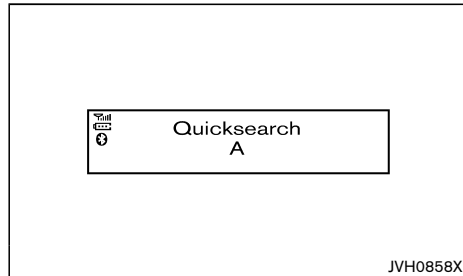
**Quick searching the phonebook:**

The quick search mode can be used as follows:

1. Push the A-Z button.
2. Turn the MENU/ENTER dial for the first alphabetic or numerical letter of the contact name. Once highlighted, push the MENU/ENTER dial to select the letter.
3. The display will show the corresponding contact name(s). Where necessary, use the MENU/ENTER dial to scroll further for the appropriate contact name to call.
4. The screen will show the number to be dialed. Push the MENU/ENTER dial to dial the number.

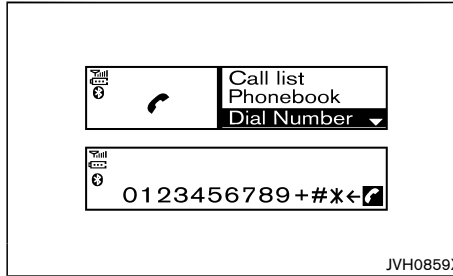
**Manually dialing a phone number:**

To dial a phone number manually, perform the following operation:

1. Push the button on the instrument panel and turn the MENU/ENTER dial to highlight "Dial Number".
2. Push the MENU/ENTER dial to select "Dial Number".
3. Turn the MENU/ENTER dial to scroll along and highlight each number of the phone number. Push the MENU/ENTER dial to select the highlighted number.  
To delete the last number entered, scroll to the "←" (Backspace symbol) and once highlighted, push the MENU/ENTER dial. The last number will be deleted. Pushing the MENU/ENTER dial repeatedly will delete each subsequent number.
4. After entering the last number, highlight the icon and push the MENU/ENTER dial to dial the number.

**Redial:**

To redial or call the last number dialed, push and hold the button on the instrument panel or the steering wheel for more than 2 seconds.

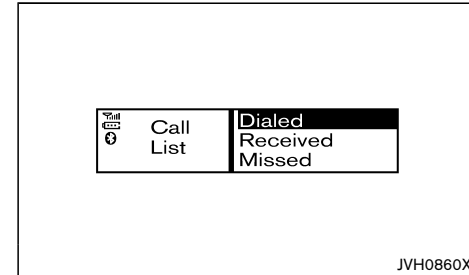
**Using call history (Call list menu):**

A number from the dialed, received, or missed call lists can also be used to make a call.

1. Push the button on the instrument panel and select "Call List" on the display.
2. Turn the MENU/ENTER dial and scroll to an item, and push the MENU/ENTER dial to select an item.

**Available items:**

- Dialed  
Use the dialed call mode to make a call which is based on the list of outgoing (dialed) calls.
- Received  
Use the received call mode to make a call which is based on the list of received calls.
- Missed  
Use the missed call mode to make a call which is based on the list of missed calls.

**4-82 Display screen, heater and air conditioner, and audio system**



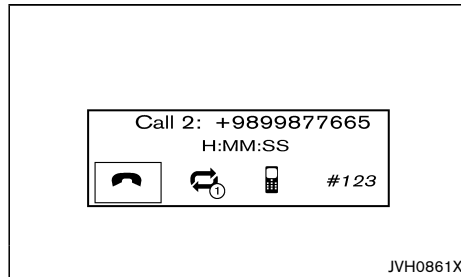

3. Scroll to the preferred phone number and push the MENU/ENTER dial or the  button on the instrument panel.

### Second incoming call





Whenever there is a second incoming call is shown in the display. By selecting the  icon the call is accepted and the current call is put on hold.

Selecting the  icon using the MENU/ENTER dial rejects the second incoming call. When this is done during the conversation it ends the call.

Selecting the  icon using the MENU/ENTER dial switches the call on line between the first and the second call.

### Ending a call

To end an active call, highlight the  icon and push the ENTER/MENU dial or push the  button on the steering wheel.

### GENERAL SETTINGS

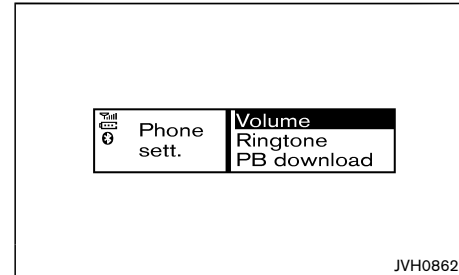

Using the MENU/ENTER dial, highlight "Settings" from the phone menu and push the MENU/ENTER dial.

Volume settings and manually downloading the phonebook can be done using this menu.

#### Menu operation:

Turn the MENU/ENTER dial to change the highlighted item and to change the volume settings.

Push the MENU/ENTER dial to select the highlighted item and to apply the setting.

#### Menu items:

- Volume
  - Ring
    - Set the phone ringing volume.
  - Call
    - Set the volume of the conversation during a call.
- Ringtone
  - Car
    - Switch the ringtone to ring from the vehicle or the cellular phone.

- Phone
  - Switch the phone ringing volume on or off.
- PB download
  - Download the phonebook of the mobile device to the audio unit manually.

## Bluetooth® HANDS-FREE PHONE SYSTEM (Type B)

\*Type B is for models without navigation system (with color display except for Mexico).

### WARNING:

- Use a phone after stopping your vehicle in a safe location. If you have to use a phone while driving, exercise extreme caution at all times so full attention may be given to vehicle operation.
- If you find yourself unable to devote full attention to vehicle operation while talking on the phone, pull off the road to a safe location and stop your vehicle before doing so.

### CAUTION:

To avoid draining the vehicle battery, use a phone after starting the engine.

Your NISSAN is equipped with the Bluetooth® Hands-Free Phone System. If you have a compatible Bluetooth® enabled cellular phone, you can set up the wireless connection between your cellular phone and the in-vehicle phone module. With Bluetooth® wireless technology, you can make or receive a hands-free telephone call with your cellular phone in the vehicle.

Once your cellular phone is connected to the in-vehicle phone module, no other phone connecting procedure is required. Your phone is automatically connected with the in-vehicle phone module when the ignition switch is placed in the "ON" position with the previously connected cellular phone turned on and carried in the vehicle.

### NOTE:

Some devices require the user to accept connections to other Bluetooth® devices. If your phone does not connect automatically to the system, consult the phone's Owner's Manual for details on device operation.

You can connect up to 5 different Bluetooth® cellular phones to the in-vehicle phone module. However, you can talk on only one cellular phone at a time.

Before using the Bluetooth® Hands-Free Phone System, refer to the following notes.

- Set up the wireless connection between a compatible cellular phone and the in-vehicle phone module before using the hands-free phone system.
- Some Bluetooth® enabled cellular phones may not be recognized or work properly. For details, consult a NISSAN dealer.
- You will not be able to use a hands-free phone under the following conditions:
  - Your vehicle is outside of the cellular service area.
  - Your vehicle is in an area where it is difficult to receive a cellular signal; such as in a tunnel, in an underground parking garage, near a tall building or in a mountainous area.
  - Your cellular phone is locked to prevent it from being dialed.
- When the radio wave condition is not ideal or ambient sound is too loud, it may be difficult to hear the other person's voice during a call.
- Do not place the cellular phone in an area surrounded by metal or far away from the in-vehicle phone module to prevent tone quality degradation and wireless connection disruption.

- While a cellular phone is connected through the Bluetooth® wireless connection, the battery power of the cellular phone may discharge quicker than usual. The Bluetooth® Hands-Free Phone System cannot charge cellular phones.
- Some cellular phones or other devices may cause interference or a buzzing noise to come from the audio system speakers. Storing the device in a different location may reduce or eliminate the noise.
- Refer to the cellular phone Owner's Manual regarding the telephone charges, cellular phone antenna and body, etc.

## REGULATORY INFORMATION

Bluetooth® trademark



Bluetooth® is a trademark owned by Bluetooth SIG, Inc. and licensed to Visteon Corporation.

## USING THE SYSTEM

Control buttons:

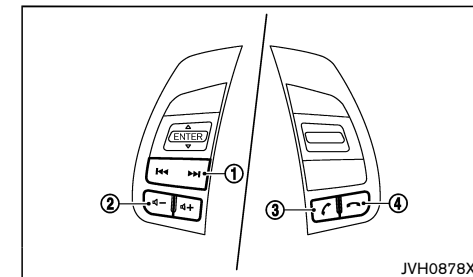

## 4-84 Display screen, heater and air conditioner, and audio system

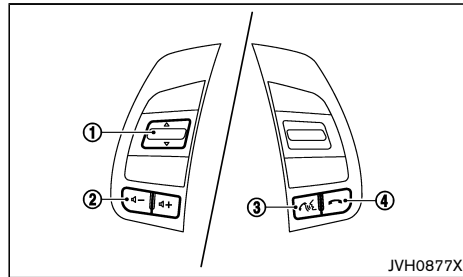

1. buttons:

While using the hands-free phone system, tilt the tuning switch up or down to manually control the phone system.

2. Volume control buttons

3. Phone send button:

Push the or button to initiate a phone session or answer an incoming call.

4. Phone end button:

Push the button to end a phone call or to stop the system from providing voice prompts.

#### Microphone:

Microphone is located near the map lights.

#### Choosing a language

You can interact with the Bluetooth® Hands-Free Phone System using several languages that are available. For operations to change the language, see “CD player/Radio (Type C)” (P.4-57) or “CD player/Radio (Type D)” (P.4-63).

#### Changing voice feedback volume

If you want to adjust the volume of the voice feedback, push the volume control switches ( + or -) on the steering wheel while being provided with feedback. You can also use the Power/VOL dial on the audio unit.

#### Initialization

When the ignition switch is placed in the “ON” position, the Bluetooth® Hands-Free Phone System is initialized which takes a few seconds. If the button is pushed before the initialization completes, the system will announce that the hands-free phone system is not ready.

#### Connecting procedure:

You can register up to 5 different Bluetooth® cellular phones in the in-vehicle phone module. However, you can talk on only one cellular phone at a time.

To connect a phone to the Bluetooth® Hands-Free Phone System;

1. Push the ENTER/SETTING button.
2. Use the TUNE-FOLDER dial to select “Bluetooth” and then push the ENTER/SETTING button.
3. Select “Add Phone or Device” and then push the ENTER/SETTING button.
4. When a message with a PIN appears on the screen, operate the Bluetooth® phone to enter the PIN.

The connecting procedure varies according to each phone. See the phone’s Owner’s Manual for details.

#### List of commands

Commands can be used to operate the Bluetooth® Hands-Free Phone System. Push the button to bring up the phone command menu. The available options are:

- Phonebook
- Record Name (if equipped)
- Recent Calls
- Show Applications (if equipped)
- Select Phone

#### Phonebook:

The following commands are available under “Phonebook”.

#### NOTE:

**Each phone has its own separate phonebook. You cannot access Phone A’s phonebook if you are currently connected with Phone B.**

- List Names  
Select this command to have the system list the names in the phonebook one by one in alphabetical order. Select “Dial” to dial the number of the currently selected name. Push the button to move through the list and select the person you wish to call. Select “Record Name” to record a name for the current phonebook entry. Select “Delete Recording” to delete a recorded name for the current phonebook entry.
- Delete Entry  
Select this command to delete an entry in the phonebook. Choose an entry to delete.

**Record Name (if equipped):**

The system allows you to record custom voice tags for contact names in the phonebook. Up to 40 voice tags can be recorded to the system.

**Recent Calls:**

The following commands are available under "Recent Calls":

- **Incoming Calls**  
Select this command to list the last five incoming calls to the vehicle. If the call is from an entry in the phonebook, the name will be displayed. Otherwise, the phone number of the incoming call will be displayed.  
Select "Dial" to call the number. Select "Next Entry" or "Previous Entry" to move through the list of incoming calls.
- **Missed Calls**  
Select this command to list the last five missed calls to the vehicle. If the call is from an entry in the phonebook, the name will be displayed. Otherwise, the phone number of the missed call will be displayed. Select "Dial" to call the number. Select "Next Entry" or "Previous Entry" to move through the list of missed calls.
- **Outgoing Calls**  
Select this command to list the last five outgoing calls from the vehicle. If the call was to an entry in the phonebook, the name will be displayed. Otherwise, the phone number of the outgoing call will be displayed. Select "Dial" to call the number. Select "Next Entry" or "Previous Entry" to move through the list of outgoing calls.
- **Redial**  
Select this command to call the last number dialed.

- **Call Back**

Select this command to call the number of the last incoming call to the vehicle.

**Show Applications (if equipped):**

Select this command to display list of smartphone apps available.













**NOTE:**

**Compatible smartphone and registration are necessary to access the applications. See "NissanConnect App smartphone integration" (P.4-74) for more information.**









**Select Phone:**

Select this command to select a phone to use from a list of those phones connected to the vehicle.

**Making a call from the phonebook**



1. Push the  /  button on the steering wheel and push the   /  button to select the "Phonebook" menu.
2. Push the   /  button on the steering wheel to select the "List Names" menu.
3. Push the   /  button to select the person you wish to call.
4. Push the  /  button to accept the selection. The system acknowledges the selection and starts dialing.

**Redialing**



1. Push the  /  button on the steering wheel and push the   /  button to select "Call".
2. Push the   /  button and select "Redial" to call the last number dialed.



**Receiving a call**



When a call is received by the phone connected to the vehicle's Bluetooth® Hands-Free Phone System, the call information is displayed on either the vehicle information display or both the vehicle information display and the control panel display.



Push the  /  button to accept the call. Push the  button to reject the call.

**During a call**

While a call is active, push the  /  button to access additional options. Select one of the following commands:

- "Mute On" / "Mute Off"  
Select the command to mute or unmute the system.
- "Transfer Call"  
Select this command to transfer the call to the handset. To transfer the call back from the handset to the Bluetooth® Hands-Free Phone System, push the  /  button and confirm when prompted.

If supported by the phone, the Bluetooth® Hands-Free Phone System allows for call waiting functionality. If a call is received while another call is already active, a message will be displayed on the screen. Push the  /  button to hold the active call and switch to the second call. Push the  button to reject the second call.



While the second call is active, pushing the  /  button will allow the same commands that are available during any call as well as two additional commands:

- "Switch Call"  
Select this command to hold the second call and switch back to the original call.

**4-86 Display screen, heater and air conditioner, and audio system**

- “End Other Call”

Select this command to stay with the second call and end the original call.

Push the  /  button to accept the call. Push the  button to reject the call.

### Ending a call

To end an active call, push the  button.

### Bluetooth® SETTINGS

To access and adjust the settings for the Bluetooth® Hands-Free Phone System;

1. Push the ENTER/SETTING button.
2. Use the TUNE-FOLDER dial to select “Bluetooth” and then push the ENTER/SETTING button.

#### Available setting items:

- Bluetooth  
Select “On” or “Off” to turn the vehicle’s Bluetooth® system on or off.
- Add Phone or Device  
For operation to connect a phone to the system, see “CD player/Radio (Type C)” (P.4-57) or “CD player/Radio (Type D)” (P.4-63).
- Delete Phone or Device  
Select to delete a phone from the displayed list. The system will ask to confirm before deleting the phone.

#### NOTE:

**When you delete a phone, the associated phonebook for the phone will also be deleted.**

- Replace Phone  
Select to replace a phone from the displayed list. When a selection is made, the system will ask to

confirm before proceeding. The recorded phonebook for the phone being deleted will be saved as long as the new phone’s phonebook is the same as the old phone’s phonebook.

- Select Phone or Device  
Select to connect to a previously connected phone from the displayed list.
- Phonebook Download  
Select to turn on or off the automatic download of a connected phone’s phonebook.
- Show Incoming Calls  
Select “Driver Only” to have incoming call information displayed only in the vehicle information display. Select “Both” to have incoming call information displayed in both the vehicle information display and the center display screen.

## Bluetooth® HANDS-FREE PHONE SYSTEM (Type C)

**\* Type C is for models without navigation system (with color display for Mexico).**



#### WARNING:

- **Use a phone after stopping your vehicle in a safe location. If you have to use a phone while driving, exercise extreme caution at all times so full attention may be given to vehicle operation.**
- **If you are unable to devote full attention to vehicle operation while talking on the phone, pull off the road to a safe location and stop your vehicle.**



#### CAUTION:

**To avoid draining the vehicle battery, use a phone after starting the engine.**

Your NISSAN is equipped with the Bluetooth® Hands-Free Phone System. If you have a compatible Bluetooth® enabled cellular phone, you can set up the wireless connection between your cellular phone and the in-vehicle phone module. With Bluetooth® wireless technology, you can make or receive a hands-free telephone call with your cellular phone in the vehicle.

Once your cellular phone is connected to the in-vehicle phone module, no other phone connecting procedure is required. Your phone is automatically connected with the in-vehicle phone module when the ignition switch is placed in the “ON” position with the previously connected cellular phone turned on and carried in the vehicle.

**NOTE:**

**Some devices require the user to accept connections to other Bluetooth® devices. If your phone does not connect automatically to the system, consult the phone's Owner's Manual for details on device operation.**

You can connect up to 5 different Bluetooth® cellular phones to the in-vehicle phone module. However, you can talk on only one cellular phone at a time.

Before using the Bluetooth® Hands-Free Phone System, refer to the following notes.

- Set up the wireless connection between a compatible cellular phone and the in-vehicle phone module before using the hands-free phone system.
- Some Bluetooth® enabled cellular phones may not be recognized or work properly. For information about Bluetooth® devices that are available for use with this system, contact a NISSAN dealer.
- You will not be able to use a hands-free phone under the following conditions:
  - Your vehicle is outside of the cellular service area.
  - Your vehicle is in an area where it is difficult to receive a cellular signal; such as in a tunnel, in an underground parking garage, near a tall building or in a mountainous area.
- When the radio wave condition is not ideal or ambient sound is too loud, it may be difficult to hear the other person's voice during a call.
- Do not place the cellular phone in an area surrounded by metal or far away from the in-vehicle phone module to prevent tone quality degradation and wireless connection disruption.

- While a cellular phone is connected through the Bluetooth® wireless connection, the battery power of the cellular phone may discharge quicker than usual. The Bluetooth® Hands-Free Phone System cannot charge cellular phones.
- If the hands-free phone system seems to be malfunctioning, see "Troubleshooting guide" in this section. You can also visit [www.nissanusa.com/bluetooth](http://www.nissanusa.com/bluetooth) for troubleshooting help.
- Some cellular phones or other devices may cause interference or a buzzing noise to come from the audio system speakers. Storing the device in a different location may reduce or eliminate the noise.
- Refer to the cellular phone Owner's Manual regarding the telephone charges, cellular phone antenna and body, etc.

**REGULATORY INFORMATION****FCC Regulatory information**

- **CAUTION:** To maintain compliance with FCC's RF exposure guidelines, use only the supplied antenna. Unauthorized antenna, modification, or attachments could damage the transmitter and may violate FCC regulations.
- Operation is subject to the following two conditions:
  - 1) this device may not cause interference and
  - 2) this device must accept any interference, including interference that may cause undesired operation of the device.

**IC Regulatory information**

- Operation is subject to the following two conditions:
  - 1) this device may not cause interference, and
  - 2) this device must accept any interference, including interference that may cause undesired operation of the device.
- This Class B digital apparatus meets all requirements of the Canadian Interference-Causing Equipment Regulations.

**Bluetooth® trademark**

Bluetooth® is a trademark owned by Bluetooth SIG, Inc. and licensed to Visteon.

**4-88 Display screen, heater and air conditioner, and audio system**

## USING THE SYSTEM

The voice recognition system allows hands-free operation of the Bluetooth® Phone System.

If the vehicle is in motion, some commands may not be available so full attention may be given to vehicle operation.

### Control buttons and microphone

#### Control buttons

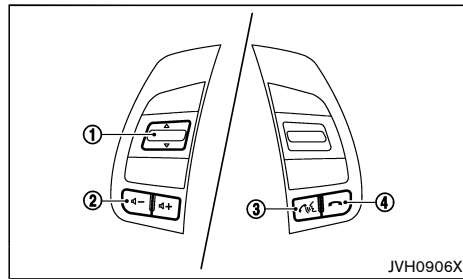

1. Tuning  $\blacktriangle$  switch:

While using the voice recognition system, tilt the tuning switch up or down to manually control the phone system.

2. Volume control  $\square$  -/  $\square$  + buttons:

3. Phone send  $\hookrightarrow$  button:

Push the  $\hookrightarrow$  button to initiate a VR session or answer an incoming call.

You can also use the  $\hookrightarrow$  button to interrupt the system feedback and give a command at once. See "List of voice commands" and "During a call" in this section for more information.

4. Phone end  $\curvearrowright$  button:

While the voice recognition system is active, push and hold the  $\curvearrowright$  button for 5 seconds to quit the voice recognition system at any time.

#### Microphone:

Microphone is located near the map lights.

#### MANUAL CONTROL:

While using the Voice Recognition system, it is possible to select menu options by using the steering wheel controls instead of speaking voice commands. To activate manual control mode, push the  $\hookrightarrow$  button on the steering wheel to access the phone menu and then push either up or down the  $\blacktriangle$  switch.

The manual control mode does not allow dialing a phone number by digits. The user may select an entry from the Phonebook or Recent Calls lists. To reactivate Voice Recognition, exit the manual control mode by pushing and holding the  $\curvearrowright$  button. At that time, pushing the  $\hookrightarrow$  button will start the Hands Free Phone System.

#### Choosing a language

You can interact with the Bluetooth® Hands-Free Phone System using several languages that are available. For operations to change the language, see "Audio main operation" (P.4-58).

#### Changing voice feedback volume

If you want to adjust the volume of the voice feedback, push the ( $\square$  -/  $\square$  +) button on the steering wheel while being provided with feedback. You can also use the Power/VOL dial on the audio unit.

#### Initialization

When the ignition switch is placed in the ON position, voice recognition is initialized, which takes a few seconds. If the  $\hookrightarrow$  button is pushed before the initialization completes, the system will announce "Hands-free phone system not ready" and will not react to voice commands.

#### Connecting procedure:

##### NOTE:

**The connecting procedure must be performed when the vehicle is stationary. If the vehicle starts moving during the procedure, the procedure will be cancelled.**

You can register up to 5 different Bluetooth® cellular phones in the in-vehicle phone module. However, you can talk on only one cellular phone at a time.

To connect a phone to the Bluetooth® Hands-Free Phone System;



1. Push the ENTER/SETTING button.
2. Use the TUNE-FOLDER dial to select "Bluetooth" and then push the ENTER/SETTING button.
3. Select "Add Phone or Device" and then push the ENTER/SETTING button.
4. When a message with a PIN appears on the screen, operate the Bluetooth® phone to enter the PIN.

The connecting procedure varies according to each phone. See the phone's Owner's Manual for details.

### Giving voice commands

To operate voice recognition, push and release the  button located on the steering wheel. After the tone sounds, speak a command.

The command given is picked up by the microphone, and voice feedback is given when the command is accepted.

- If you need to hear the available commands for the current menu again, say "Help" and the system will repeat them.
- If a command is not recognized, the system announces, "Command not recognized. Please try again." Make sure the command is said exactly as prompted by the system and repeat the command in a clear voice.
- If you want to go back to the previous command, you can say "Go back" or "Correction" any time the system is waiting for a response.
- You can cancel a command when the system is waiting for a response by saying, "Cancel" or "Quit." The system announces "Cancel" and ends the VR session. You can also push and hold the  button on the steering wheel for 5 seconds at any time to end the VR session. Whenever the VR session is cancelled, a double beep is played to indicate you have exited the system.
- If you want to adjust the volume of the voice feedback, push the (  - or  +) button on the steering wheel while being provided with feedback. You can also use the radio volume control knob.

### Voice Prompt Interrupt:

In most cases you can interrupt the voice feedback to speak the next command by pushing the  button on the steering wheel. After interrupting the system, wait for a beep before speaking your command.

### One Shot Call:

To use the system faster, you may speak the second level commands with the main menu command on the main menu. For example, push the  button and after the tone say, "Call Redial".

### Operating tips:

To get the best performance out of the voice recognition system, observe the following:

- Keep the interior of the vehicle as quiet as possible. Close the windows to eliminate surrounding noises (traffic noises, vibration sounds, etc.), which may prevent the system from recognizing voice commands correctly.
- Wait until the tone sounds before speaking a command. Otherwise, the command will not be received properly.
- Start speaking a command within 5 seconds after the tone sounds.
- Speak in a natural voice without pausing between words.

### Voice commands

Voice commands can be used to operate the Bluetooth® Hands-Free Phone System. Push the  button and say "Phone" to bring up the phone command menu. The available options are:

- Call
- Phonebook

- Recent Calls
- Messaging (if equipped)
- Show Applications (if equipped)
- Select Phone

### Call:

For more information on the "Call" command, see "Making a call" (P.4-91).

### Phonebook:

The following commands are available under "Phonebook":

- (a name)  
Say a name in the phonebook to bring up a list of options for that phonebook entry. The system will say the name it interpreted based on the voice command provided. If the name is incorrect, say "Correction" to hear another name.  
Once the correct phonebook entry is identified, say "Dial" to dial the number or "Send Text" to send a text message to that number. Say "Record Name" to record a name for the phonebook entry. Say "Delete Recording" to delete a recorded name for the phonebook entry.
- List Names  
Speak this command to have the system list the names in the phonebook one by one alphabetically. Say "Dial" to dial the number of the current name or "Send Text" to send a text message to that number. Say "Next Entry" or "Previous Entry" to move through the list alphabetically. Say "Record Name" to record a name for the current phonebook entry. Say "Delete Recording" to delete a recorded name for the current phonebook entry.

## 4-90 Display screen, heater and air conditioner, and audio system



- **Transfer Entry**

This command can be used to transfer multiple contacts at a time. To enable manual contact transfer capability, set "Phonebook Download" to "Off" in the Setting menu. The ability to transfer contacts via the OPP Bluetooth® profile depends on your mobile phone. See your phone's Owner's Manual for details and instructions.

- **Delete Entry**

Speak this command to delete an entry in the phonebook. Choose an entry to delete by speaking the desired name or say "List Names".

#### **Recent Calls:**

The following commands are available under "Recent Calls":

- **Incoming Calls**

Speak this command to list the last five incoming calls to the vehicle. If the call is from an entry in the phonebook, the name will be displayed. Otherwise, the phone number of the incoming call will be displayed.

Say "Dial" to call the number or "Send Text" to send a text message to that number. Say "Next Entry" or "Previous Entry" to move through the list of incoming calls.

- **Missed Calls**

Speak this command to list the last five missed calls to the vehicle. If the call is from an entry in the phonebook, the name will be displayed. Otherwise, the phone number of the missed call will be displayed.

Say "Dial" to call the number or "Send Text" to send a text message to that number. Say "Next Entry" or "Previous Entry" to move through the list of missed calls.

- **Outgoing Calls**

Speak this command to list the last five outgoing calls from the vehicle. If the call was to an entry in the phonebook, the name will be displayed. Otherwise, the phone number of the outgoing call will be displayed.

Say "Dial" to call the number or "Send Text" to send a text message to that number. Say "Next Entry" or "Previous Entry" to move through the list of outgoing calls.

- **Redial**

Speak this command to call the last number dialed.

- **Call Back**

Speak this command to call the number of the last incoming call to the vehicle.

#### **Messaging (if equipped):**

Speak this command to access text messaging functions. For more information on these commands, see "Text messaging" (P.4-92).

#### **Show Applications (if equipped):**

Speak this command to display list of smartphone apps available.

#### **NOTE:**

**Compatible smartphone and registration necessary to access applications. See "NissanConnect App smartphone integration" (P.4-74) for more information.**

#### **Select Phone or Device:**

Speak this command to select a phone to use from a list of those phones connected to the vehicle.

#### **Making a call**

To make a call from a phone connected to the vehicle's Bluetooth® Hands-Free Phone System:

1. Push the  button.
2. The system will prompt you for a command. Say "Call".
3. Select one of the available voice commands to continue:

- **(a name)**

Speak the name of a phonebook entry to place a call to that entry. The system will respond with the name it interpreted from your command and will prompt you to confirm that the name is correct. Say "Yes" to initiate the call or "No" to hear another name from the phonebook.

- **Number**

Speak this command to place a call by inputting numbers.

For 7- and 10-digit phone numbers, speak the numbers. When finished, say "Dial" to initiate the call. Say "Correction" at any time in the process to correct a misspoken or misinterpreted number.

For phone numbers with more digits or special characters, say "Special Number", then speak the digits. Up to 24 digits can be entered. Available special characters are "star", "pound", "plus" and "pause". When finished, say "Dial" to initiate the call. Say "Correction" at any time in the process to correct a misspoken or misinterpreted number or character.

- **Redial**

Speak this command to dial the number of the last outgoing call. The system will display

**Display screen, heater and air conditioner, and audio system 4-91**



“Redialing (name/number)”. The name of the phonebook entry will be displayed if it available, otherwise the number being redialed will be displayed.

- Call Back

Speak this command to dial the number of the last incoming call. The system will display “Calling back (name/number)”. The name of the phonebook entry will be displayed if it available, otherwise the number being called back will be displayed.

#### Receiving a call

When a call is received by the phone connected to the vehicle's Bluetooth® Hands-Free Phone System, the call information is displayed on either the vehicle information display or both the vehicle information display and the control panel display.



Push the  button to accept the call. Push the  button to reject the call.

#### During a call

While a call is active, push the  button to access additional options. Speak one of the following commands:



- Send  
Speak this command followed by the digits to enter digits during the phone call.
- Mute On or Mute Off  
Speak the command to mute or unmute the system.
- Transfer Call  
Speak this command to transfer the call to the handset. To transfer the call back from the handset to the Bluetooth® Hands-Free Phone System, push the  button and confirm when prompted.

#### 4-92 Display screen, heater and air conditioner, and audio system

If supported by the phone, the Bluetooth® Hands-Free Phone System allows for call waiting functionality. If a call is received while another call is already active, a message will be displayed on the screen. Push the  button to hold the active call and switch to the second call. Push the  button to reject the second call.

While the second call is active, pushing the  button will allow the same commands that available during any call as well as two additional commands:

- Switch Call  
Speak this command to hold the second call and switch back to the original call.
- End Other Call  
Speak this command to stay with the second call and end the original call.

Push the  button to accept the call. Push the  button to reject the call.

#### Ending a call

To end an active call, push the  button.

#### Text messaging



#### WARNING:

- **Laws in some jurisdictions may restrict the use of some of the applications and features, such as social networking and texting.**
- **Laws in some jurisdictions may restrict the use of “Text-to-Speech”. Check local regulations before using this feature.**
- **Use the text messaging feature after stopping your vehicle in a safe location. If you**

**have to use the feature while driving, exercise extreme caution at all times so full attention may be given to vehicle operation.**

- **If you are unable to devote full attention to vehicle operation while using the text messaging feature, pull off the road to a safe location and stop your vehicle.**

#### NOTE:

**This feature is automatically disabled if the connected device does not support the Message Access Profile (MAP). See the phone's Owner's Manual for details and instructions.**

The system allows for the sending and receiving of text messages through the vehicle interface.

#### Sending a text message:

1. Push the  button.
2. Say “Messaging”.
3. Say “Send Text”.
4. The system will provide a list of available commands in order to determine the recipient of the text message. Choose from the following:
  - (A name)
  - Number
  - Incoming Calls
  - Outgoing Calls
  - Missed Calls

If “Incoming Calls”, “Outgoing Calls”, or “Missed Calls” is selected, the following additional commands will be displayed:

  - Send Text

- Next Entry
- Previous Entry



For more information about these options, see "Voice commands" (P.4-90).

- Once a recipient is chosen, the system prompts for which message to send. Five predefined messages are available as well as three custom messages. To choose one of the predefined messages, speak one of the following:
  - "Driving, can't text"
  - "Call me"
  - "On my way"
  - "Running late"
  - "Okay"

To send one of the custom messages, say "Custom Message". If more than one custom message is stored, the system will prompt for the number of the desired custom message. For more information on setting and managing custom text messages, see "Bluetooth® settings" (P.4-93).

#### Reading a received text message:

- Push the  button.
- Say "Messaging".
- Say "Read Text".

The text message, sender and delivery time are shown on the screen. Use the tuning switch on the steering wheel to scroll through all text messages if more than one are available. Push the  button to exit the text message screen. Push the  button to access the following options for replying to the text message:

- Call Back  
Speak this command to call the sender of the text message using the Bluetooth® Hands-Free Phone System.

- Send Text  
Speak this command to send a text message response to the sender of the text message.
- Read Text  
Speak this command to read the text message again.
- Previous Text  
Speak this command to move to the previous text message (if available).
- Next Text  
Speak this command to move to the next text message (if available).

#### NOTE:

**Text messages are only displayed if the vehicle speed is less than 8 km/h (5 MPH).**

#### Bluetooth® SETTINGS

To access and adjust the settings for the Bluetooth® Hands-Free Phone System:

- Push the SETTING button.
- Use the TUNE/FOLDER knob to select "Bluetooth" and then push the ENTER/SETTING button:
  - Bluetooth  
Select "On" or "Off" to turn the vehicle's Bluetooth® system on or off.
  - Add Phone or Device  
To connect a phone to the system, see "Connecting procedure" (P.4-89).
  - Delete Phone or Device  
Select to delete a phone from the displayed list. The system will ask to confirm before deleting the phone.

- Replace Phone  
Select to replace a phone from the displayed list. When a selection is made, the system will ask to confirm before proceeding. The recorded phonebook for the phone being deleted will be saved as long as the new phone's phonebook is the same as the old phone's phonebook.
- Select Phone or Device  
Select to connect to a previously connected phone from the displayed list.
- Phonebook Download  
Select to turn on or off the automatic download of a connected phone's phonebook.
- Show Incoming Calls  
Select "Driver Only" to have incoming call information displayed only in the vehicle information display. Select "Both" to have incoming call information displayed in both the vehicle information display and the center display screen.
- Text Message  
Select to turn on or off the vehicle's text messaging feature.
- New Text Sound  
Select to adjust the volume of the sound that plays when a new text is received by a phone connected to the Bluetooth® Hands-Free Phone System. The setting all the way to the left indicates that the new text sound will be muted.
- Show Incoming Text  
Select "Driver Only" to have incoming text messages displayed only in the vehicle in-

## Bluetooth® HANDS-FREE PHONE SYSTEM (Type D)

formation display. Select “Both” to have incoming text messages displayed in both the vehicle information display and the center display screen. Select “None” to have no display of incoming text messages.

- Edit Custom Messages

Select to set a custom message that will be available with the standard options when sending a text message. To set a custom message, send a text message to your own phone number while the phone is connected to the system. Three custom messages can be set. Custom messages can only be set while the vehicle is stationary.

- Auto Reply

Select to turn on or off the Auto Reply function. When enabled, the vehicle will automatically send a predefined text message to the sender when a text message is received while driving.

- Auto Reply Message

Select to choose the message that is sent when the Auto Reply function is enabled. Choose from “I’m Driving” or one of the three custom messages stored in the system.

- Vehicle Signature On/Off

Select to choose whether or not the vehicle signature is added to outgoing text messages from the vehicle. This message cannot be changed or customized.

**\*Type D is for models with navigation system.**

### WARNING:

- **Use a phone after stopping your vehicle in a safe location. If you have to use a phone while driving, exercise extreme caution at all times so full attention may be given to vehicle operation.**
- **If you are unable to devote full attention to vehicle operation while talking on the phone, pull off the road to a safe location and stop your vehicle.**

### CAUTION:

**To avoid discharging the vehicle battery, use a phone after starting the engine.**

Your NISSAN is equipped with the Bluetooth® Hands-Free Phone System. If you have a compatible Bluetooth® enabled cellular phone, you can set up the wireless connection between your cellular phone and the in-vehicle phone module. With Bluetooth® wireless technology, you can make or receive a hands-free telephone call with your cellular phone in the vehicle.

Once your cellular phone is connected to the in-vehicle phone module, no other phone connecting procedure is required. Your phone is automatically reconnected with the in-vehicle phone module when the ignition switch is placed in the ON position with the connected cellular phone turned on and carried in the vehicle.

You can register up to 5 different Bluetooth® cellular phones to the in-vehicle phone module. However, you can talk on only one cellular phone at a time.

Before using the Bluetooth® Hands-Free Phone System, refer to the following notes.

- Set up the wireless connection between a cellular phone and the in-vehicle phone module before using the Bluetooth® Hands-Free Phone System.
- Some Bluetooth® enabled cellular phones may not be recognized by the in-vehicle phone module.
- You will not be able to use a hands-free phone under the following conditions:
  - Your vehicle is outside of the cellular service area.
  - Your vehicle is in an area where it is difficult to receive cellular signal; such as in a tunnel, in an underground parking garage, near a tall building or in a mountainous area.
  - Your cellular phone is locked to prevent it from being dialed.
- When the radio wave condition is not ideal or ambient sound is too loud, it may be difficult to hear the other person’s voice during a call.
- Immediately after the ignition switch is placed in the ON position, it may be impossible to receive a call for a short period of time.
- Do not place the cellular phone in an area surrounded by metal or far away from the in-vehicle phone module to prevent tone quality degradation and wireless connection disruption.
- While a cellular phone is connected through the Bluetooth® wireless connection, the battery power of the cellular phone may discharge quicker than usual. The Bluetooth® Hands-Free Phone System cannot charge cellular phones.
- Some cellular phones or other devices may cause interference or a buzzing noise to come from the audio system speakers. Storing the device in a different location may reduce or eliminate the noise.

## 4-94 Display screen, heater and air conditioner, and audio system

- Refer to the cellular phone owner's manual regarding the telephone charges, cellular phone antenna and body, etc.
- The signal strength display on the monitor will not coincide with the signal strength display of some cellular phones.

### REGULATORY INFORMATION

#### For Mexico:

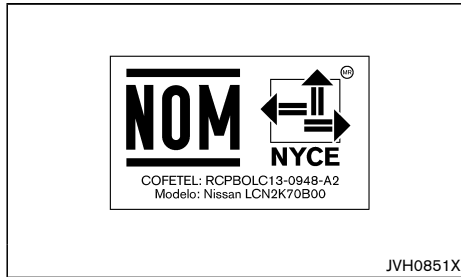

La operación de este equipo está sujeta a las siguientes dos condiciones: (1) es posible que este equipo o dispositivo no cause interferencia perjudicial y (2) este equipo o dispositivo debe aceptar cualquier interferencia, incluyendo la que pueda causar su operación no deseada.

Marca: BOSCH  
Modelo: Nissan LCN2K70B00  
Cofetel: RCPBOLC13-0948-A2  
NOM-121-SCT1-2009

JVH0870X

### Bluetooth® trademark



Bluetooth® is a trademark owned by Bluetooth SIG, Inc. and licensed to Bosch.

### CONTROL BUTTONS AND MICROPHONE

#### Steering wheel switch:

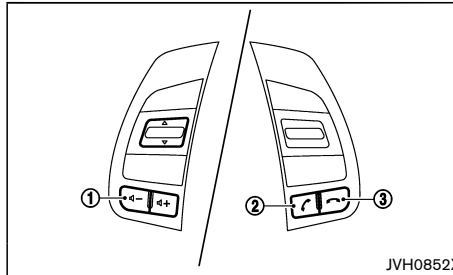

Type A

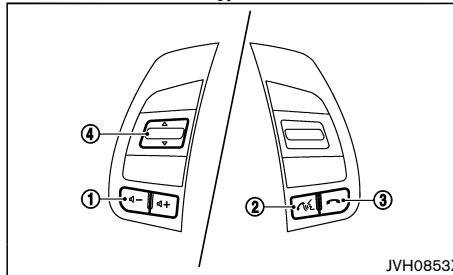

Type B

1. Volume control +/- - switch
2. Phone send / button
3. Phone end button

4. Tuning switch (for Mexico)

#### Instrument panel:

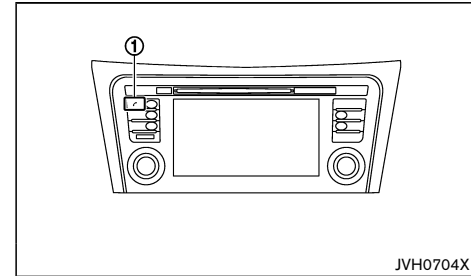

1. Phone button

#### Microphone:

Microphone is located near the map lights.

#### VOICE COMMANDS (for Mexico)

You can use voice commands to operate various Bluetooth® Hands-Free Phone System features using the Voice Recognition system. For more details, see "Voice Recognition system" (P.4-98).

While using the voice recognition system, tilt the switch up or down to manually control the phone system.

#### Voice prompt interrupt

While using the voice recognition system, the system voice can be interrupted to allow the user to speak commands. While the system is speaking, push the button on the steering wheel. The system voice will stop and a tone will be heard. After the tone, speak desired command (displayed on the touchscreen).

## One shot call

To use the system faster, you may speak the second level commands with the main menu command on the main menu. For example, push the  button and after the tone, say "Call Redial".

## PAIRING PROCEDURE

### NOTE:

**The connecting procedure must be performed when the vehicle is stationary. If the vehicle starts moving during the procedure, the procedure will be cancelled.**

1. Push the SETUP button on the control panel.
2. Select the "Telephone & Bluetooth" key.
3. Select the "Pair New Device" key.
4. Initiate the pairing process from the handset. The system will display the message asking if PIN is displayed on your Bluetooth® device. If the PIN is displayed on your Bluetooth® device, select "Yes" to complete the pairing process.

For more information, see the Bluetooth® device's Owner's Manual.

## PHONEBOOK

To access the vehicle phonebook:



1. Push the  button on the control panel.
2. Select the "Phonebook/Contacts" key.
3. Choose the desired entry from the displayed list.
4. The number of the entry will be displayed on the screen. Touch the number to initiate dialing.

### NOTE:

**To scroll quickly through the list, touch the "A-Z" key in the upper right corner of the screen. Turn the ENTER/Scroll dial to choose a letter or number and then push the ENTER/Scroll dial. The list will move to the first entry that begins with that number or letter.**

## MAKING A CALL





To make a call, follow the procedure below:

1. Push the  on the control panel. The "Phone" screen will appear on the display.
2. Select one of the following options to make a call:
  - "Contacts": Select the name from an entry stored in the vehicle phonebook.
  - "Call Lists": Select the name from the incoming, outgoing or missed.
  - "Redial": Dial the last outgoing call from the vehicle.
  - : Input the phone number manually using a keypad displayed on the screen. For information on how to use the touchscreen, see "How to use the touchscreen" in this section.

## RECEIVING A CALL

When a call is placed to the connected phone, the display will change to phone mode.

To accept the incoming call, take one of the following actions.

- Push the  /  button on the steering wheel.
- Touch the "  " or "  " icon on the screen.

To reject the incoming call, take one of the following actions.

- Push the  button on the steering wheel.

- Touch the red phone "  " icon on the screen.

## DURING A CALL

While a call is active, the following options are available on the screen:



- "Handset"
 

Select this option to switch control of the phone call over to the handset.
- "Mute Mic."
 

Select this option to mute the microphone. Select again to unmute the microphone.
- Red phone "  " icon
 

Select to end the phone call.

## ENDING A CALL

To end a phone call, select the red phone "  " icon on the screen or push the  button on the steering wheel.

## TEXT MESSAGING (for Mexico)



### WARNING:

- **Laws in some jurisdictions may restrict the use of "Text-to-Speech." Check local regulations before using this feature.**
- **Laws in some jurisdictions may restrict the use of some of the applications and features, such as social networking and texting. Check local regulations for any requirements.**
- **Use the text messaging feature after stopping your vehicle in a safe location. If you have to use the feature while driving, exercise extreme caution at all times so full attention may be given to vehicle operation.**

## 4-96 Display screen, heater and air conditioner, and audio system

- **If you are unable to devote full attention to vehicle operation while using the text messaging feature, pull off the road to a safe location and stop your vehicle.**

The system allows for the sending and receiving of text messages through the vehicle interface.

**NOTE:**

**Text messages are only displayed if the vehicle speed is less than 8 km/h (5 MPH).**

Sending a text message

1. Push the  button on the steering wheel.
2. Say "Phone" after the tone.
3. Say "Send Text" after the tone.
4. The system will provide a list of available commands in order to determine the recipient of the text message. Choose from the following:
  - To (a name)
  - Enter Number
  - Missed Calls
  - Incoming Calls
  - Outgoing Calls



For more information about these options, see "Voice commands" in this section.
5. Once a recipient is chosen, the system prompts for which message to send. Nine predefined messages are available as well as three custom messages. To choose one of the predefined messages, speak one of the following after the tone:
  - "Driving, can't text"
  - "Call me"

- "On my way"
- "Running late"
- "Okay"
- "Yes"
- "No"
- "Where are you?"
- "When?"

To send one of the custom messages, say "Custom Messages". If more than one custom message is stored, the system will prompt for the number of the desired custom message.

Reading a received text message

1. Push the  button on the steering wheel.
2. Say "Phone" after the tone.
3. Say "Read Text" after the tone.

The text message, sender and delivery time are shown on the screen. Use the tuning switch to scroll through all text messages if more than one are available. Push the  button to exit the text message screen. Push the  button to access the following options for replying to the text message:

- **Call Back**  
Speak this command to call the sender of the text message using the Bluetooth® Hands-Free Phone System.
- **Send Text**  
Speak this command to send a text message response to the sender of the text message.
- **Read Text**  
Speak this command to read the text message again.
- **Previous Text**  
Speak this command to move to the previous text

message (if available).

- **Next Text**  
Speak this command to move to the next text message (if available).

**NOTE:**

**Text messages are only displayed if the vehicle speed is less than 8 km/h (5 MPH).**

Bluetooth® SETTINGS

To access the Bluetooth® settings screen:

1. Push the SETUP button.
2. Touch the "Telephone & Bluetooth" key.

**Available setting items:**

- **Telephone Setup**  
See "Telephone setup" (P.4-98) for details.
- **Pair New Device**  
Select to pair a new Bluetooth® device to the Bluetooth® Hands-Free Phone System.
- **Select Paired Device**  
Select to choose a Bluetooth® device from a list of those devices paired to the Bluetooth® Hands-Free Phone System.
- **Delete Paired Device**  
Select to delete a Bluetooth® device from a list of those devices connected/paired to the Bluetooth® Hands-Free Phone System.
- **Bluetooth**  
Select to toggle Bluetooth® on and off.

## TELEPHONE SETUP

To access the phone settings screen:

1. Push the SETUP button.
2. Touch the "Telephone & Bluetooth" key.
3. Touch the "Telephone Setup" key.

### Available setting items:

- **Sort Phonebook By:**  
Select "First Name" or "Last Name" to choose how phonebook entries are alphabetically displayed on the screen.
- **From Phonebook/Use Phonebook from:**  
Select "Phone" to use the handset's phonebook. Select "SIM" to use the phonebook on the SIM card. Select "Both" to use both sources.
- **Download Phonebook Now:**  
Select to download the phonebook to the vehicle from the chosen source.
- **Record name for Phonebook Entry (Mexico only):**  
Select to record a name for a phonebook entry for use with the voice recognition system.
- **Phone Notifications (Mexico only):**  
Select "Driver" to have phone notifications shown in the vehicle information display. Select "Both" to have phone notifications shown in both the vehicle information display and the center display screen.
- **Text Messaging (Mexico only):**  
Select "On" or "Off" to activate or deactivate text messaging feature. See "Text messaging (for Mexico)" (P.4-96).
- **Show Incoming Text (Mexico only):**  
Select "Driver" to have incoming text notifications shown in the vehicle information display. Select "Both" to have text notifications shown in both the vehicle information display and the center display

screen. Select "Off" to turn off all text notifications.

- **Auto Reply (Mexico only):**  
Select "On" to have the system automatically reply to caller with a predetermined text message. Select "Off" to turn off auto reply function.
- **Auto Reply Message (Mexico only):**  
Select to indicate preferred message to be used when "Auto Reply" function is activated.
- **Use Vehicles's Signature (Mexico only):**  
Select "On" to have vehicle signature shown in outgoing text messages or "Off" to deactivate the function.
- **Custom Text Messages (Mexico only):**  
Select this option to select a custom message to edit. There are 4 customer message slots available.

## VOICE RECOGNITION SYSTEM (if equipped)



The Voice Recognition system allows hands-free operation of the systems equipped on this vehicle, such as the phone and navigation systems.

To operate the Voice Recognition system, push the  button located on the steering wheel. When prompted, speak the command for the system you wish to activate. The command given is picked up by the microphone and performed when it is properly recognized. The Voice Recognition will provide a voice response as well as a message in the center display to inform you of the command results.

## CONTROL BUTTONS AND MICROPHONE

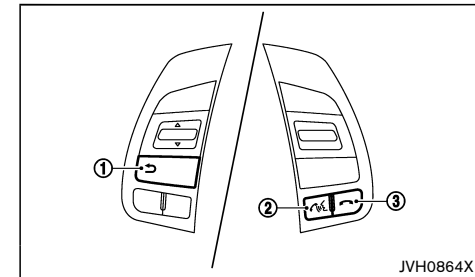
### Steering wheel mounted controls:



1. Back  button
2. Talk  button
3. Cancel  button

### Microphone:

Microphone is located near the map light.

## 4-98 Display screen, heater and air conditioner, and audio system







## USING THE SYSTEM

### Initialization

When the ignition switch is in the ON position, the Voice Recognition system is initialized, which takes a few seconds. When completed, the system is ready to accept voice commands. If the  button is pushed before the initialization completes, the system will announce that the system is not ready for voice recognition session.

### Giving voice commands

1. Push the  button.
2. The system announces and prompts you to speak a command. A list of available commands is then spoken by the system.
3. After the tone sounds and the face icon on the display changes, speak a command. Available commands are discussed later in this section.
4. Voice and display feedback are provided when the command is accepted.
  - Push the  button on the instrument panel to return to the previous screen.
  - If the command is not recognized, the system announces provides a list of available selections.
  - If you want to cancel the command or go back to the previous menu of commands, push the  button.
  - Push the  button to move back through the menus displayed on the screen.
  - If you want to adjust the volume of the voice feedback, use the volume control switches on the steering wheel or the Power/VOLUME dial on the control panel.

### Operation on the control panel display:

The voice command screen can also be accessed using the control panel display

1. Push the INFO button on the control panel.
2. Touch the “Voice Commands” key.

### Operating tips

To get the best performance out of the Voice Recognition system, observe the following:

- Keep the interior of the vehicle as quiet as possible. Close the windows to eliminate the surrounding noises (traffic noises, vibration sounds, etc.), which may prevent the system from recognizing the voice commands correctly.
- Wait until a tone sounds before speaking a command. Otherwise, the command will not be received properly.
- Start speaking a command within 3.5 seconds after the tone sounds.
- Speak in a natural voice without pausing between words.

## SYSTEM FEATURES

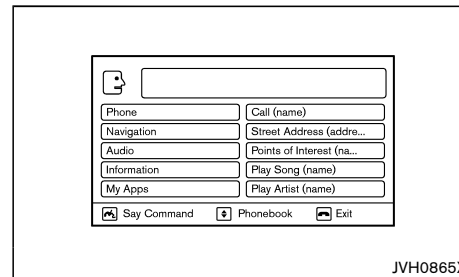

The Voice Recognition system can activate the

following systems:

- Bluetooth® Hands-Free Phone System
- Navigation
- Audio
- Information
- My Apps

For additional information on the navigation system, see the separate Navigation System Owner's Manual.

### How to say numbers

The Voice Recognition system requires a certain way to speak numbers in voice commands. Refer to the following examples.

General rule: Either “zero” or “oh” can be used for “0”.

### Phone numbers

Speak phone numbers according to the following example. For 1-800-662-6200, say dial number and then speak the phone number in any of the following formats:

- “one eight oh oh six six two six two oh oh”
- “one eight hundred six six two six two oh oh”
- “one eight zero zero six six two six two oh oh”

For the best voice recognition phone dialing results, say phone numbers as single digits. Also, full numbers can only be spoken for “800”. For example, you cannot say 555-6000 as “five five five six thousand”.

## VOICE COMMANDS

### Bluetooth® Hands-Free Phone System commands

To access the Bluetooth® Hands-Free Phone System voice commands:

1. Push the  button.
2. Say "Call" and then a name in the vehicle phonebook to call that entry. Otherwise, say "Phone" to access various phone commands.

If the Bluetooth® has been set to "Off", the system will ask if you wish to turn the Bluetooth® on.

If no phone is connected to the system and the vehicle is stationary, the system will ask if you wish to connect a phone. Say "Yes" to connect a phone. All further Bluetooth® Hands-Free Phone System voice commands are only available if a phone is connected.

If a phone is connected and Bluetooth® is set to "On", the following voice commands are available:

- **Call (a name)**  
Speak the name of the contact in which you are trying to call. System will confirm correct contact. Say "Dial" to initiate dialing.
- **Dial Number**  
Allows for up to 24 digits to be dialed. After the number is entered, say "Dial" to initiate dialing. Say "Correction" to correct the number entered. Say "Go Back" to return to the main menu.
- **List Phonebook**  
Starting with the first alphabetical entry in the vehicle phonebook, the system prompts for an additional command. Say "Dial" to call the number of the phonebook entry. Say "Send Text" to send a text message to the number of the phonebook entry. Say "Next Entry" to skip to the next

alphabetical entry in the vehicle phonebook, where the same options will then be available.

- **Recent Calls**  
The system prompts for an additional command. Say "Missed Calls", "Incoming Calls" or "Outgoing Calls" to display a list of such calls on the screen. Speak the number of the entry displayed on the screen to dial that number or say "Next Page" to view entries on the next page (if available).
  - **Redial**  
Redials the last called number.
  - **Read Text**  
Reads an incoming text message. For more information about text messaging with the Bluetooth® Hands-Free Phone System, see "Bluetooth® Hands-Free Phone System (Type D)" (P.4-94) "Bluetooth® Hands-Free Phone System with Navigation System" in this section.
  - **Send Text**  
Sends a text message. For more information about text messaging with the Bluetooth® Hands-Free Phone System, see "Bluetooth® Hands-Free Phone System with Navigation System" in this section.
  - **Select Phone**  
The system prompts you to use manual controls to continue. Use manual controls to change the active phone from among the listed phones connected to the vehicle.
- For more information about the Bluetooth® Hands-Free Phone System, see "Bluetooth® Hands-Free Phone System (Type D)" (P.4-94).

### Navigation commands

The following voice commands are available for the Navigation System:

- Street Address (address)
- Points of Interest (name)
- POI by Category
- Home
- Address Book
- Previous Destinations
- Enter Address in Steps
- Cancel Route

For more information about these commands, see the separate Navigation System Owner's Manual.

### Audio commands

To access the audio system voice commands:

1. Push the  button.
2. Say "Audio".
3. Speak a command from the following available commands:
  - **Play (AM, FM, etc.)**  
Allows user to select radio band
  - **Tune AM (number)**  
Allows user to tune directly to a desired AM frequency
  - **Tune FM (number)**  
Allows user to tune directly to a desired FM frequency
  - **CD Track (number)**  
Allows user to select track to be played
  - **Play Song (name)**  
Allows user to select song name to be played

## 4-100 Display screen, heater and air conditioner, and audio system

- Play Artist (name)  
Allows user to select artist to be played
- Play Album (name)  
Allows user to select album name to be played

For more information about the audio system, see "Audio system" (P.4-35).

### Information commands

The following voice commands are available for the information functions of the Navigation System:

- Traffic
- Fuel Prices
- Stocks
- Movie Listings
- Current Weather
- Weather Map
- 5 — day Forecast
- 6 — hour Forecast

For more information about these commands, see the separate Navigation System Owner's Manual.

### My Apps commands

Many Apps can be accessed using this voice command. See "NissanConnect App smartphone integration" (P.4-74) for more information.

### Help commands

The following voice commands can be spoken to have the system provide instructions and tips for using the Voice Recognition system.

- List Commands
- What Can I Say?
- General Help

- Quit
- Exit

### TROUBLESHOOTING GUIDE

The system should respond correctly to all voice commands without difficulty. If problems are encountered, follow the solutions given in this guide for the appropriate error. Where the solutions are listed by number, try each solution in turn, starting with number one, until the problem is resolved.

Symptom/error message	Solution
The system fails to recognize the command correctly.	<ol style="list-style-type: none"> <li>1. Ensure that the command format is valid. Use the "List Commands" or "What Can I Say?" command under the "Help" menu.</li> <li>2. Speak clearly without pausing between words and at a level appropriate to the ambient noise level.</li> <li>3. Ensure that the ambient noise level is not excessive (for example, with the windows open or the defogger turned on).</li> </ol> <p><b>NOTE:</b> If it is too noisy to use the phone, it is likely that voice commands will not be recognized.</p> <ol style="list-style-type: none"> <li>4. If optional words of the command have been omitted, then the command should be tried with these in place.</li> </ol>

(256,1)

**MEMO**

**4-102 Display screen, heater and air conditioner, and audio system**

Condition: 'Except for China'

[ Edit: 2014/ 11/ 7 Model: T32-A ]

## 5 Starting and driving

Break-in schedule .....	5-3	Stop/Start System or Idling Stop System (if equipped) .....	5-18
Before starting engine .....	5-3	Stop/Start System or Idling Stop System display .....	5-20
Precautions when starting and driving .....	5-3	Stop/Start or Idling Stop OFF switch .....	5-21
Exhaust gas (carbon monoxide) .....	5-4	Four-Wheel Drive (4WD) (if equipped) .....	5-22
Three-way catalyst (if equipped) .....	5-4	Four-Wheel Drive (4WD) mode switch operations .....	5-22
Tire Pressure Monitoring System (TPMS) (if equipped) .....	5-4	4WD warning .....	5-24
Diesel Particulate Filter (DPF) (if equipped) .....	5-6	4WD mode indicator lights .....	5-24
On-pavement and off-road driving precautions .....	5-7	Four-Wheel Drive (4WD) torque distribution indicator .....	5-25
Care when driving .....	5-7	Off-road driving safety precautions .....	5-25
Engine cold start period .....	5-7	Tires of 4WD model .....	5-26
Loading luggage .....	5-7	Vehicle Dynamic Control (VDC)/Electronic Stability Program (ESP) system .....	5-26
Driving in wet conditions .....	5-7	Vehicle Dynamic Control (VDC)/Electronic Stability Program (ESP) system OFF switch .....	5-27
Driving in winter conditions .....	5-7	Chassis control .....	5-28
Ignition switch (model without intelligent Key system) .....	5-7	Active Trace Control .....	5-28
Continuously Variable Transmission (CVT) .....	5-7	Active Engine Brake (Continuously Variable Transmission (CVT) models) .....	5-28
Manual Transmission (MT) .....	5-8	Active Ride Control .....	5-29
Steering lock (if equipped) .....	5-8	Hill Start Assist system .....	5-30
Key positions .....	5-8	Hill descent control system (if equipped) .....	5-30
Push-button ignition switch (model with Intelligent Key system) .....	5-9	Hill descent control switch .....	5-31
Precautions on push-button ignition switch operation .....	5-9	Blind Spot Warning (BSW)/Lane Departure Warning (LDW) systems (if equipped) .....	5-31
Intelligent Key system .....	5-9	BSW system operation .....	5-32
Steering lock (if equipped) .....	5-10	BSW driving situations .....	5-33
Ignition switch positions .....	5-10	LDW system operation .....	5-34
Intelligent Key battery discharge .....	5-11	BSW/LDW temporary disabled status .....	5-35
Starting engine (model without Intelligent Key system) .....	5-11	BSW/LDW automatic deactivation .....	5-35
Starting engine (model with Intelligent Key system) .....	5-12	BSW/LDW malfunction .....	5-35
Driving vehicle .....	5-13	Camera unit maintenance .....	5-35
Driving with Continuously Variable Transmission (CVT) .....	5-13		
Driving with Manual Transmission (MT) .....	5-17		
Gear Shift Indicator (if equipped) .....	5-18		

Blind Spot Warning (BSW) system (if equipped for Europe) ....	5-36	Trailer towing (except for Australia, New Zealand, South Africa and Europe) .....	5-52
BSW system operation .....	5-36	Trailer towing (for Australia, New Zealand, South Africa and Europe) .....	5-52
BSW driving situations .....	5-38	Operating precautions .....	5-52
BSW temporary disabled status .....	5-39	Maximum load limits (for Australia and New Zealand) .....	5-53
BSW automatic deactivation .....	5-39	Tire pressure .....	5-55
BSW malfunction .....	5-39	Safety chains .....	5-55
Camera unit maintenance .....	5-39	Trailer brakes .....	5-55
Lane Departure Warning (LDW) system (if equipped for Europe) .....	5-39	Trailer detection (if equipped) .....	5-55
LDW system operation .....	5-40	Coupling device installation (for Europe) .....	5-56
Temporary disabled status at high temperature .....	5-41	Electric power steering system .....	5-56
Multi-sensing camera unit maintenance .....	5-41	Brake system .....	5-57
Speed limiter (if equipped) .....	5-41	Brake precautions .....	5-57
Speed limiter operations .....	5-41	Brake assist .....	5-58
Cruise control (if equipped) .....	5-43	Anti-lock Braking System (ABS) .....	5-58
Precautions on cruise control .....	5-43	Vehicle security .....	5-59
Cruise control operations .....	5-44	Cold weather driving .....	5-59
Forward emergency braking system (if equipped) .....	5-45	Battery .....	5-59
System operation .....	5-45	Engine coolant .....	5-59
ECO mode system (if equipped) .....	5-47	Tire equipment .....	5-59
ECO Pedal Guide function .....	5-47	Special winter equipment .....	5-60
Ambient ECO .....	5-47	Parking brake .....	5-60
ECO Drive Report .....	5-48	Corrosion protection .....	5-60
Parking .....	5-48		
Parking sensor (sonar) system (if equipped) .....	5-50		
Parking sensor (sonar) system OFF switch (if equipped) ....	5-51		
Parking sensor (sonar) system setting .....	5-52		

## BREAK-IN SCHEDULE

During the first 1,600 km (1,000 miles), follow these recommendations to obtain maximum engine performance and ensure the future reliability and economy of your new vehicle. Failure to follow these recommendations may result in shortened engine life and reduced engine performance.

- Do not drive at a constant speed, either fast or slow, for long periods of time.
- Do not run the engine over 4,000 rpm (for gasoline engine models).
- Do not accelerate at full throttle in any gear.
- Do not start quickly.
- Do not brake hard as much as possible.
- Do not tow a trailer for at least the first 800 km (500 miles) (for Australia, New Zealand, South Africa and Europe).

## BEFORE STARTING ENGINE



### WARNING:

**The driving characteristics of your vehicle will change remarkably by any additional load and its distribution, as well as by adding optional equipment (trailer coupling, roof racks, etc.). Your driving style and speed must be adjusted according to the circumstances. Especially when carrying heavy loads, your speed must be reduced adequately.**

- Make sure the area around the vehicle is clear.
- Visually inspect tires for their appearance and condition. Measure and check the tire pressure for proper inflation.
- Check that all windows and lights are clean.
- Adjust the seat and head restraint positions.
- Adjust the inside and outside rearview mirror positions.
- Fasten your seat belt and ask all passengers to do the same.
- Check that all doors are closed.
- Check the operation of the warning lights when the ignition switch is placed in the "ON" position.
- Maintenance items in the "8. Maintenance and do-it-yourself" section should be checked periodically.

## PRECAUTIONS WHEN STARTING AND DRIVING



### WARNING:

- **Never leave children or adults who would normally require the support of others alone in your vehicle. Pets should not be left alone either. They could unknowingly activate switches or controls and inadvertently become involved in a serious accident and injure themselves. On hot, sunny days, temperatures in a closed vehicle could quickly become high enough to cause severe or possibly fatal illness to people or animals.**
- **Properly secure all luggage to help prevent it from sliding or shifting. Do not place luggage higher than the seatbacks. In a sudden stop or collision, unsecured luggage could cause personal injury.**

### NOTE:

**During the first few months after purchasing a new vehicle, if you smell strong odors of Volatile Organic Compounds (VOCs) inside the vehicle, ventilate the passenger compartment thoroughly. Open all the windows before entering or while in the vehicle. In addition, when the temperature in the passenger compartment rises, or when the vehicle is parked in direct sunlight for a period of time, turn off the air recirculation mode of the air conditioner and/or open the windows to allow sufficient fresh air into the passenger compartment.**

## EXHAUST GAS (carbon monoxide)

### **WARNING:**

- Do not breathe exhaust gas; it contains colorless and odorless carbon monoxide. Carbon monoxide is dangerous. It can cause unconsciousness or death.
- If you suspect that exhaust fumes are entering the vehicle, drive with all windows fully open, and have the vehicle inspected immediately.
- Do not run the engine in closed spaces such as a garage.
- Do not park the vehicle with the engine running for an extended period of time.
- Keep the back door closed while driving, otherwise exhaust gas could be drawn into the passenger compartment. If you must drive with the back door open, follow these precautions:
  - Open all the windows.
  - Turn the air recirculation mode off and set the fan speed control to the highest level to circulate the air.
- If electrical wiring or other cable connections must pass to a trailer through the seal of the back door or the body, follow the manufacturer's recommendation to prevent carbon monoxide entry into the vehicle.
- If a special body or other equipment is added for recreational or other usage, follow the manufacturer's recommendation to prevent carbon monoxide entry into the vehicle. (Some recreational vehicle appliances such as stoves, refrigerators, heaters, etc. may

also generate carbon monoxide.)

- The exhaust system and body should be inspected by a qualified mechanic whenever:
  - Your vehicle is raised while being serviced.
  - You suspect that exhaust fumes are entering into the passenger compartment.
  - You notice a change in the sound of the exhaust system.
  - You have had an accident involving damage to the exhaust system, underbody, or rear of the vehicle.

## THREE-WAY CATALYST (if equipped)

### **WARNING:**

- The exhaust gas and the exhaust system are very hot. Keep people, animals and flammable materials away from the exhaust system components.
- Do not stop or park the vehicle over flammable materials such as dry grass, wastepaper or rags. They may ignite and cause a fire.

The three-way catalyst is an emission control device installed in the exhaust system. Exhaust gas in the three-way catalyst is burned at high temperatures to help reduce pollutants.

### **CAUTION:**

- Do not use leaded gasoline. (See "Recommended Fluids/lubricants and capacities" (P.9-2).) Deposits from leaded gasoline ser-

iously reduce the ability of the three-way catalyst to help reduce exhaust pollutants and/or damage the three-way catalyst.

- Keep your engine tuned up. Malfunctions in the ignition, fuel injection, or electrical systems may cause overrich fuel to flow into the three-way catalyst, causing it to overheat. Do not keep driving if the engine misfires, or if noticeable loss of performance or other unusual operating conditions are detected. Have the vehicle inspected promptly by a NISSAN dealer.
- Avoid driving with an extremely low fuel level. Running out of fuel could cause the engine to misfire, damaging the three-way catalyst.
- Do not race the engine while warming it up.
- Do not push or tow your vehicle to start the engine.

## TIRE PRESSURE MONITORING SYSTEM (TPMS) (if equipped)

Each tire, including the spare (if provided), should be checked monthly when cold and inflated to the inflation pressure recommended by the vehicle manufacturer on the vehicle placard or tire inflation pressure label. (If your vehicle has tires of a different size than the size indicated on the vehicle placard or tire inflation pressure label, you should determine the proper tire inflation pressure for those tires.)

As an added safety feature, your vehicle has been equipped with a Tire Pressure Monitoring System (TPMS) that illuminates a low tire pressure telltale when one or more of your tires is significantly underinflated. Accordingly, when the low tire pressure telltale illuminates, you should stop and check your tires as

## 5-4 Starting and driving



soon as possible, and inflate them to the proper pressure. Driving on a significantly under-inflated tire causes the tire to overheat and can lead to tire failure. Under-inflation also reduces fuel efficiency and tire tread life, and may affect the vehicle's handling and stopping ability.

Please note that the TPMS is not a substitute for proper tire maintenance, and it is the driver's responsibility to maintain correct tire pressure, even if under-inflation has not reached the level to trigger illumination of the TPMS low tire pressure telltale.

Your vehicle has also been equipped with a TPMS malfunction indicator to indicate when the system is not operating properly. The TPMS malfunction indicator is combined with the low tire pressure telltale. When the system detects a malfunction, the telltale will flash for approximately one minute and then remain continuously illuminated. This sequence will continue upon subsequent vehicle start-ups as long as the malfunction exists. When the malfunction indicator is illuminated, the system may not be able to detect or signal low tire pressure as intended. TPMS malfunctions may occur for a variety of reasons, including the installation of replacement or alternate tires or wheels on the vehicle that prevent the TPMS from functioning properly. Always check the TPMS malfunction telltale after replacing one or more tires or wheels on your vehicle to ensure that the replacement or alternate tires and wheels allow the TPMS to continue to function properly.

#### Additional information

- The TPMS does not monitor the tire pressure of the spare tire.
- The TPMS will activate only when the vehicle is driven at speeds above 25 km/h (16 MPH). Also, this system may not detect a sudden drop in tire pressure (for example a flat tire while driving).
- The low tire pressure warning light may not automatically turn off when the tire pressure is adjusted. After the tire is inflated to the recommended pressure, reset the tire pressures registered in your vehicle and then drive the vehicle at speeds above 25 km/h (16 MPH) to activate the TPMS and turn off the low tire pressure warning light.
- Depending on a change in the outside temperature, the low tire pressure warning light may illuminate even if the tire pressure has been adjusted properly. Adjust the tire pressure to the recommended COLD tire pressure again when the tires are cold, and reset the TPMS.
- You can check the pressure of all tires in the vehicle information display. (See "Trip computer" (P.2-34).)

For additional information, see "Low tire pressure warning light" (P.2-14).

#### **WARNING:**

- **If the low tire pressure warning light illuminates while driving, avoid sudden steering maneuvers or abrupt braking, reduce vehicle speed, pull off the road to a safe location and stop the vehicle as soon as possible. Driving with under-inflated tires may permanently damage the tires and increase the likelihood of tire failure. Serious vehicle**

**damage could occur and may lead to an accident and could result in serious personal injury. Check the tire pressure for all four tires. Adjust the tire pressure to the recommended COLD tire pressure shown on the tire placard to turn the low tire pressure warning light off. If the light still illuminates while driving after adjusting the tire pressure, a tire may be flat. If you have a flat tire, replace it with a spare tire as soon as possible. (See "Flat tire" (P.6-2) for changing a flat tire.)**

- **After adjusting the tire pressure, be sure to reset the TPMS. Otherwise, the TPMS will not warn of low tire pressure.**
- **When a spare tire is mounted or a wheel is replaced, the TPMS will not function and the low tire pressure warning light will flash for approximately 1 minute. The light will remain on after the 1 minute. Contact a NISSAN dealer as soon as possible for tire replacement and/or system resetting.**
- **Replacing tires with those not originally specified by NISSAN could affect the proper operation of the TPMS.**
- **Do not inject any tire liquid or aerosol tire sealant into the tires, as this may cause a malfunction of the tire pressure sensors.**

#### **CAUTION:**

- **The TPMS may not function properly when the wheels are equipped with tire chains or the wheels are buried in snow.**
- **Do not place metalized film or any metal parts (antenna, etc.) on the windows. This may cause poor reception of the signals**

**Starting and driving 5-5**

**from the tire pressure sensors, and the TPMS will not function properly.**

Some devices and transmitters may temporarily interfere with the operation of the TPMS and cause the low tire pressure warning light to illuminate. Some examples are:

- Facilities or electric devices using similar radio frequencies are near the vehicle.
- If a transmitter set to similar frequencies is being used in or near the vehicle.
- If a computer (or similar equipment) or a DC/AC converter is being used in or near the vehicle.

**FCC Notice:**

**For USA:**

**This device complies with Part 15 of the FCC Rules. Operation is subject to the following two conditions: (1) This device may not cause harmful interference, and (2) this device must accept any interference received, including interference that may cause undesired operation.**

**Note: Changes or modifications not expressly approved by the party responsible for compliance could void the user's authority to operate the equipment.**

**For Canada:**

**This device complies with Industry Canada licence-exempt RSS standard(s). Operation is subject to the following two conditions: (1) this device may not cause interference, and (2) this device must accept any interference, including interference that may cause undesired operation of the device.**

**TPMS resetting**

To keep the TPMS functioning properly, the reset operation must be performed in the following cases.

- when the tire pressure is adjusted
- when a tire or a wheel is replaced
- when the tires are rotated

Perform the following procedures to reset the TPMS.

1. Park the vehicle in a safe and level place.
2. Apply the parking brake and place the shift lever in the "P" (Park) position.
3. Adjust the tire pressure on all four tires to the recommended COLD tire pressure shown on the tire placard. Use a tire pressure gauge to check the tire pressure.
4. Place the ignition switch in the "ON" position.

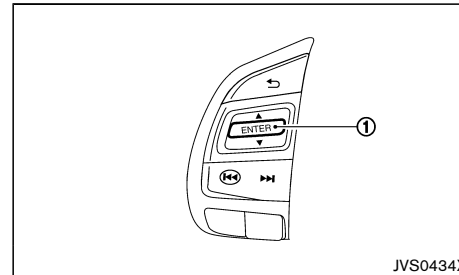

**Steering-wheel-mounted controls (left side)**

5. Use the switch **1** until "Settings" appears, and press ENTER **1**.
6. Use the switch **1** until "Tire Pressures" is selected, and press ENTER **1**.
7. Use the switch **1** until "Calibrate" is selected, and press ENTER **1**.

8. Use the switch **1** until "Start" is selected, and press ENTER **1** to reset the TPMS. When the TPMS resetting starts, the message "TPMS resetting" will be displayed.
9. After resetting the TPMS, drive the vehicle for several minutes at speeds above 25 km/h (16 MPH).

If the low tire pressure warning light illuminates after the resetting operation, it may indicate that the TPMS is not functioning properly. Have the system checked by a NISSAN dealer.

For information regarding the low tire pressure warning light, see "Low tire pressure warning light" (P.2-14).

**DIESEL PARTICULATE FILTER (DPF) (if equipped)**



**WARNING:**

- **Be careful not to burn yourself with exhaust gases.**
- **Do not park the vehicle over flammable materials such as dry grass, waste paper or rags, as they may burn easily.**
- **Use the specified engine oil for Diesel Particulate Filter (DPF) equipped models. For details, see "Recommended Fluids/lubricants and capacities" (P.9-2).**



**CAUTION:**

**The DPF becomes extremely hot after burning particulate matter.**

**5-6 Starting and driving**

## ON-PAVEMENT AND OFF-ROAD DRIVING PRECAUTIONS

**Utility vehicles have a significantly higher roll-over rate than other types of vehicles.**

They have higher ground clearance than passenger cars to make them capable of performing in a wide variety of on-pavement and off-road applications. This gives them a higher center of gravity than ordinary cars. An advantage of higher ground clearance is a better view of the road, allowing you to anticipate problems. However, they are not designed for cornering at the same speeds as conventional passenger cars any more than low-slung sports cars are designed to perform satisfactorily under off-road conditions. If at all possible, avoid sharp turns or abrupt maneuvers, particularly at high speeds. As with other vehicles of this type, failure to operate this vehicle correctly may result in loss of control or vehicle rollover.



### CAUTION:

- **Do not drive on dry hard surface roads in LOCK mode.**
- **Driving on dry hard surface roads in LOCK mode may cause unnecessary noise and tire wear. NISSAN recommends driving in the 2WD or AUTO mode under these conditions. (Four-Wheel Drive (4WD) model)**

See "Four-Wheel Drive (4WD)" (P.5-22) for more details.

## CARE WHEN DRIVING

Driving your vehicle to fit the circumstances is essential for your safety and comfort. As a driver, you should be the one who knows best how to drive in the given circumstances.

### ENGINE COLD START PERIOD

Due to the higher engine speeds, when the engine is cold, extra caution must be exercised when selecting a gear during the engine warm-up period after starting the engine.

### LOADING LUGGAGE

Loads and their distribution and the attachment of equipment (coupling devices, roof luggage carriers, etc.) will considerably change the driving characteristics of the vehicle. Your driving style and speed must be adjusted according to the circumstances.

### DRIVING IN WET CONDITIONS

- Avoid accelerating or stopping suddenly.
- Avoid sharp turning or lane changing suddenly.
- Avoid following too close to the vehicle in front.

When water covers the road surface with water puddles, small water streams, etc., reduce speed to prevent hydroplaning which can cause skidding and loss of control. Worn tires will increase this risk.

### DRIVING IN WINTER CONDITIONS

- Drive cautiously.
- Avoid accelerating or stopping suddenly.
- Avoid sharp turning or lane changing suddenly.
- Avoid sudden steering.
- Avoid following too close to the vehicle in front.

## IGNITION SWITCH (model without intelligent Key system)



### WARNING:

**Never remove the key or place the ignition switch in the "LOCK" position while driving. The steering wheel will lock and could cause the driver to lose control of the vehicle. This could result in serious vehicle damage or personal injury.**

### CONTINUOUSLY VARIABLE TRANSMISSION (CVT)

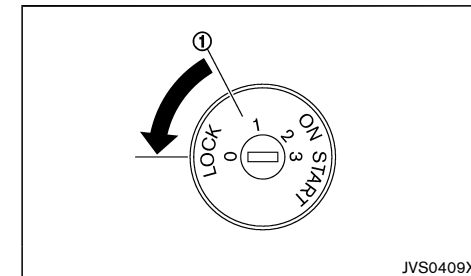

The ignition lock is designed so that the ignition switch cannot be turned to the "LOCK" position until the shift lever is moved to the "P" (Park) position. When moving the ignition switch to the "LOCK" position, to remove the key from the ignition switch, make sure the shift lever is in the "P" (Park) position.

When the ignition switch cannot be turned to the "LOCK" position:

1. Move the shift lever to the "P" (Park) position.
2. Turn the ignition switch slightly in the "ON" direction.

3. Place the ignition switch in the "LOCK" position.
4. Remove the key.

If the ignition switch is turned to the "LOCK" position, the shift lever cannot be moved from the "P" (Park) position. The shift lever can be moved if the ignition switch is in the "ON" position with the foot brake pedal depressed.

The "OFF" position ① is between the "LOCK" and "ON" positions, although it is not marked on the ignition switch.

### MANUAL TRANSMISSION (MT)

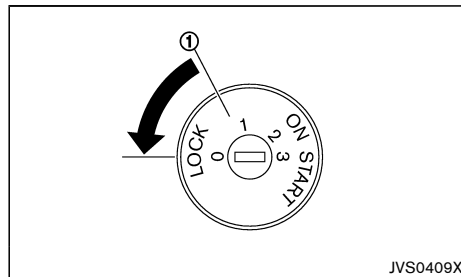

The ignition switch includes a device that helps prevent accidental removal of the key while driving.

The key can only be removed when the ignition switch is in the "LOCK" position.

1. Turn the ignition switch slightly in the "ON" direction.
2. Place the ignition switch in the "LOCK" position.
3. Remove the key.

The "OFF" position ① is between the "LOCK" and "ON" positions, although it is not marked on the ignition switch.

## 5-8 Starting and driving

### STEERING LOCK (if equipped)

#### To lock steering wheel

1. Place the ignition switch in the "LOCK" position.
2. Remove the key, if it is inserted in the ignition switch.
3. Turn the steering wheel 1/6 of a turn clockwise from the straight up position.

#### To unlock steering wheel

1. Insert the key into the ignition switch.
2. Gently turn the ignition switch while rotating the steering wheel slightly right and left.

### KEY POSITIONS

#### LOCK (OFF)/LOCK (ACC) (0)

- The ignition key can only be removed at this position.
- The steering lock (if equipped) can only be locked at this position.
- The electrical accessory power activates without the engine turned on. (ACC position)

#### OFF/OFF(ACC) (1)

- The engine is turned off with the steering wheel unlocked.
- The electrical accessory power activates without the engine turned on. (ACC position)

#### ON (2)

The ignition system and the electrical accessory power activate without the engine turned on.

#### START (3)

The engine starter activates and the engine will start. The ignition switch, when released, will automatically turn to the "ON" position.



#### CAUTION:

**As soon as the engine has started, release the ignition switch immediately.**

## PUSH-BUTTON IGNITION SWITCH (model with Intelligent Key system)

### PRECAUTIONS ON PUSH-BUTTON IGNITION SWITCH OPERATION



#### WARNING:

Do not operate the push-button ignition switch while driving the vehicle except in an emergency. (The engine will stop when the ignition switch is pushed 3 consecutive times or the ignition switch is pushed and held for more than 2 seconds.) The steering wheel will lock and could cause the driver to lose control of the vehicle. This could result in serious vehicle damage or personal injury.

Before operating the push-button ignition switch, be sure to move the shift lever to the "P" (Park) position (for Continuously Variable Transmission model) or the shift lever to the "N" (Neutral) position (for Manual Transmission model).

### INTELLIGENT KEY SYSTEM

The Intelligent Key system can operate the ignition switch without taking the key out from your pocket or bag. The operating environment and/or conditions may affect the Intelligent Key system operation. Some indicators and warnings for operation are displayed on the vehicle information display and/or in the meter. (See "Vehicle information display" (P.2-20) and "Warning/indicator lights and audible reminders" (P.2-12).)



#### CAUTION:

- Be sure to carry the Intelligent Key with you when operating the vehicle.
- Never leave the Intelligent Key inside the vehicle when you leave the vehicle.

- If the vehicle battery is discharged, the ignition switch cannot be switched from the "LOCK" position, and if the steering lock is engaged, the steering wheel cannot be moved. Charge the battery as soon as possible. (See "Jump starting" (P.6-8).)

### Operating range

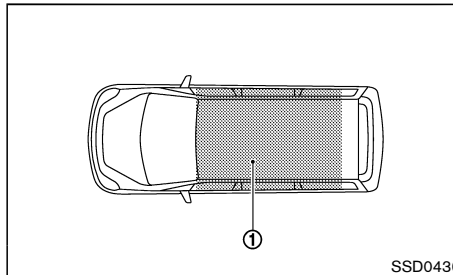

The Intelligent Key can only be used for starting the engine when the Intelligent Key is within the specified operating range ①.

When the Intelligent Key battery is almost discharged or strong radio waves are present near the operating location, the Intelligent Key system's operating range becomes narrower and may not function properly.

If the Intelligent Key is within the operating range, it is possible for anyone, even someone who does not carry the Intelligent Key, to push the ignition switch to start the engine.

- The luggage room area is not included in the operating range, but the Intelligent Key may function.
- If the Intelligent Key is placed on the instrument panel, inside the glove box, door pocket or the corner of the interior compartment, the Intelligent

Key may not function.

- If the Intelligent Key is placed near the door or window outside the vehicle, the Intelligent Key may function.

### Continuously Variable Transmission (CVT) model

The ignition lock is designed so that the ignition switch cannot be switched to the "LOCK" position until the shift lever is moved to the "P" (Park) position.

When the ignition switch cannot be switched to the "LOCK" position:

1. "Shift to Park" warning appears on the vehicle information display and a chime sounds.
2. Move the shift lever to the "P" (Park) position.
3. Push the ignition switch. The ignition switch is switched to the "OFF" position.
4. Open the door. The ignition switch turns to the "LOCK" position.

For warnings and indicators on the vehicle information display, see "Vehicle information display" (P.2-20).

If the ignition switch is switched to the "LOCK" position, the shift lever cannot be moved from the "P" (Park) position. The shift lever can be moved if the ignition switch is in the "ON" position with the foot brake pedal depressed.

## STEERING LOCK (if equipped)

The ignition switch is equipped with an anti-theft steering lock device.

### To lock steering wheel

1. Place the ignition switch in the "OFF" position where the ignition switch position indicator will not illuminate.
2. Open or close the door. The ignition switch turns to the "LOCK" position.
3. Turn the steering wheel 1/6 of a turn to the right or left from the straight up position.

### To unlock steering wheel

Push the ignition switch, and the steering wheel will be automatically unlocked.

#### **CAUTION:**

- If the battery of the vehicle is discharged, the push-button ignition switch cannot be switched from the "LOCK" position.
- If the steering lock release malfunction indicator appears on the vehicle information display, push the ignition switch again while rotating the steering wheel slightly to the right and left.

(See "Vehicle information display" (P.2-20).)

## IGNITION SWITCH POSITIONS

#### **WARNING:**

**Never place the ignition switch in the "OFF" position while driving. The steering wheel may lock and cause the driver to lose control of the vehicle, resulting in serious vehicle damage or personal injury.**

#### **CAUTION:**

- Do not leave the vehicle for extended periods of time when the ignition switch is in the "ON" position and the engine is not running. This can discharge the battery.
- Use electrical accessories with the engine running to avoid discharging the vehicle battery. If you must use accessories while the engine is not running, do not use them for extended periods of time and do not use multiple electrical accessories at the same time.

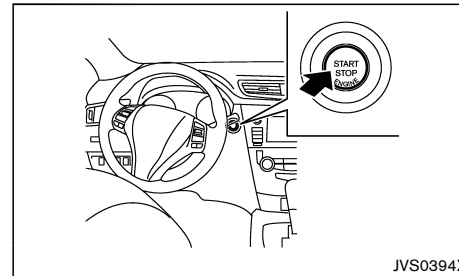

When the ignition switch is pushed without depressing the brake pedal (Continuously Variable Transmission

model) or the clutch pedal (Manual Transmission model), the ignition switch will illuminate.

Push the ignition switch center:

- once to change to "ON".
- two times to change to "OFF".

The ignition switch will automatically return to the "LOCK" position when any door is either opened or closed with the switch in the OFF position.

### LOCK position

The ignition switch and steering lock (if equipped) can only be locked at this position.

The ignition switch will lock when any door is opened or closed with the ignition switched off.

### ON position

The ignition system and the electrical accessory power activate at this position without the engine turned on.

The "ON" position has a battery saver feature that will place the ignition switch in the "OFF" position, if the vehicle is not running, after some time under the following conditions:

- all doors are closed.
- shift lever is in "P" (Park) position (CVT model) or "N" (Neutral) position (MT model).

The battery saver feature will be cancelled if any of the following occur:

- any door is opened.
- shift lever is moved out of the "P" (Park) position.
- ignition switch changes position.

## 5-10 Starting and driving

### OFF position

The engine is turned off in this position.

### Auto ACC position

With the vehicle in the "P" (Park) position, the Intelligent Key with you and the ignition placed from "ON" to "OFF", the radio can still be used for a period of time, or until the driver's door is opened. After a period of time, functions such as radio, navigation (if equipped), and Bluetooth® Hands-Free Phone System may be restarted by pressing the "POWER button/VOLUME control knob" (See "Display screen, heater and air conditioner, and audio system" (P.4-1) in this manual) or the "UNLOCK" button on the Intelligent Key up to a total of 30 minutes.

### INTELLIGENT KEY BATTERY DISCHARGE

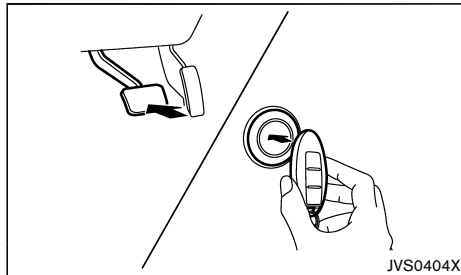

If the battery of the Intelligent Key is discharged, or environmental conditions interfere with the Intelligent Key operation, start the engine according to the following procedure:

#### 1. Continuously Variable Transmission (CVT) model:

Move the shift lever to the "P" (Park) or "N" (Neutral) position.

#### Manual Transmission (MT) model:

Move the shift lever to the "N" (Neutral) position.

2. Firmly depress the brake pedal.
3. Touch the ignition switch with the Intelligent Key as illustrated. (A chime will sound.)
4. Push the ignition switch while depressing the brake pedal (CVT model) or the clutch pedal (MT model) within 10 seconds after the chime sounds. The engine will start.

After step 3 is performed, when the ignition switch is pushed without depressing the brake pedal (CVT model) or the clutch pedal (MT model), the ignition switch position will change to "ON".

#### NOTE:

- When the ignition switch is placed in the "ON" position or the engine is started by the above procedures, the "Key battery low" warning appears (on the Vehicle information display) even if the Intelligent Key is inside the vehicle. This is not a malfunction. To turn off the warning, touch the ignition switch with the Intelligent Key again.
- If the "Key battery low" warning appears (on the Vehicle information display), replace the battery as soon as possible. (See "Battery" (P.8-20).)

### STARTING ENGINE (model without Intelligent Key system)

1. Apply the parking brake.
2. Depress the foot brake pedal.
3. Move the shift lever to the "N" (Neutral) position, and depress the clutch pedal to the floor while starting the engine.

**The starter is designed to not operate unless the clutch pedal is depressed.**

4. Crank the engine with your foot off the accelerator pedal by turning the ignition switch in the "START" position.

For diesel engine models: Wait until the glow indicator light  goes out.

5. Immediately release the ignition switch when the engine starts. If the engine starts, but fails to run, repeat the above procedures.

If the engine is very hard to start in extremely cold or hot weather, depress the accelerator pedal and hold it to help start the engine.



#### CAUTION:

- Do not operate the starter for more than 15 seconds at a time. If the engine does not start, place the ignition switch off and wait 10 seconds before cranking the engine again. Otherwise, the starter could be damaged.
  - If it becomes necessary to start the engine with a booster battery and jumper cables, the instructions and cautions contained in the "6. In case of emergency" section should be carefully followed.
6. Allow the engine to idle for at least 30 seconds after starting the engine to warm-up. Drive at moderate speeds for a short distance first,

Starting and driving 5-11

especially in cold weather.



**CAUTION:**

**Do not leave the vehicle unattended while the engine is warming up.**

## STARTING ENGINE (model with Intelligent Key system)

1. Apply the parking brake.
2. **Continuously Variable Transmission (CVT) model:**

Move the shift lever to the “P” (Park) or the “N” (Neutral) position.

**The starter is designed to operate only when the shift lever is in the proper position.**

**Manual Transmission (MT) model:**

Move the shift lever to the “N” (Neutral) position.

**The starter is designed to not operate unless the clutch pedal is fully depressed.**

**The Intelligent Key must be carried when operating the ignition switch.**

3. Place the ignition switch in the “ON” position. Depress the brake pedal (CVT model) or the clutch pedal (MT model) and push the ignition switch to start the engine.

For diesel engine models: Wait until the glow indicator light  goes out.

To start the engine immediately, push and release the ignition switch while depressing the brake pedal or clutch pedal with the ignition switch in any position.

4. Immediately release the ignition switch when the engine starts. If the engine starts, but fails to run, repeat the above procedures.

If the engine is very hard to start in extremely cold or hot weather, depress the accelerator pedal and hold it. Push the ignition switch for up to 15 seconds while holding. Release the accelerator pedal when the engine starts.



**CAUTION:**

- **As soon as the engine has started, release the ignition switch immediately.**
  - **Do not operate the starter for more than 15 seconds at a time. If the engine does not start, place the ignition switch in the “OFF” position and wait 10 seconds before cranking the engine again. Otherwise, the starter could be damaged.**
  - **If it becomes necessary to start the engine with a booster battery and jumper cables, the instructions and cautions contained in the “6. In case of emergency” section should be carefully followed.**
5. Allow the engine to idle for at least 30 seconds after starting the engine to warm-up. Drive at moderate speeds for a short distance first, especially in cold weather.



**CAUTION:**

**Do not leave the vehicle unattended while the engine is warming up.**

6. To stop the engine, move the shift lever to the “P” (Park) position (CVT model) or move the shift lever to the “N” (Neutral) position (MT model), apply the parking brake and place the ignition switch in the “OFF” position.



## DRIVING VEHICLE

### DRIVING WITH CONTINUOUSLY VARIABLE TRANSMISSION (CVT)

The Continuously Variable Transmission (CVT) in your vehicle is electronically controlled to produce maximum power and smooth operation.

The recommended operating procedures for this transmission are shown on the following pages. Follow these procedures for maximum vehicle performance and driving enjoyment.



#### WARNING:

**Do not downshift abruptly on slippery roads. This may cause a loss of control.**



#### CAUTION:

- The cold engine idle speed is high, so use caution when shifting the transmission into a forward or reverse position before the engine has warmed up.
- Avoid revving up the engine while the vehicle is stopped. This could cause unexpected vehicle movement.
- Never shift to either the "P" (Park) or "R" (Reverse) position while the vehicle is moving. This could cause serious damage to the transmission.
- Start the engine in either the "P" (Park) or "N" (Neutral) position. The engine will not start in any other position. If it does, have your vehicle checked by a NISSAN dealer.
- Except in an emergency, do not shift to the "N" (Neutral) position while driving. Coasting with the transmission in the "N" (Neutral) position may cause serious damage to the

transmission.

- Shift into the "P" (Park) position and apply the parking brake when at a standstill for longer than a short waiting period.
- Keep the engine at idling speed while shifting from the "N" (Neutral) position to any driving position.
- When stopping the vehicle on an uphill grade, do not hold the vehicle by depressing the accelerator pedal. The foot brake pedal should be depressed in this situation.

#### Starting vehicle

1. After starting the engine, fully depress the foot brake pedal before moving the shift lever out of the "P" (Park) position.
2. Keep the foot brake pedal depressed and move the shift lever to a driving position.
3. Release the parking brake, the foot brake pedal, and then gradually start the vehicle in motion.

The CVT is designed so the foot brake pedal **MUST** be depressed before shifting from the "P" (Park) position to any driving position while the ignition switch is in the "ON" position.

The shift lever cannot be moved out of the "P" (Park) position and into any of the other positions if the ignition switch is placed in the "LOCK", "OFF" or "ACC" position.



#### CAUTION:

- **DEPRESS THE FOOT BRAKE PEDAL** - Shifting the shift lever to "D", "Ds", "R", "L" or manual shift mode without depressing the foot brake pedal causes the vehicle to move slowly when the engine is running. Make

sure the foot brake pedal is depressed fully and the vehicle is stopped before shifting the shift lever.

- **MAKE SURE OF THE SHIFT LEVER POSITION** - Make sure the shift lever is in the desired position. "D", "Ds", "L" and manual shift mode are used to move forward and "R" to back up.
- **WARM UP THE ENGINE** - Due to the higher idle speeds when the engine is cold, extra caution must be exercised when shifting the shift lever into the driving position immediately after starting the engine.

#### Shifting

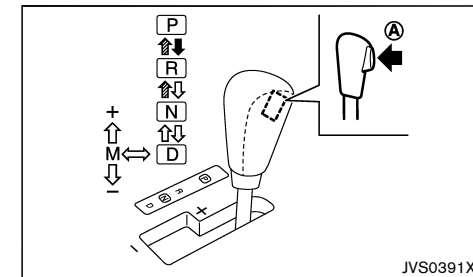

With manual shift mode (LHD model) (Type A)

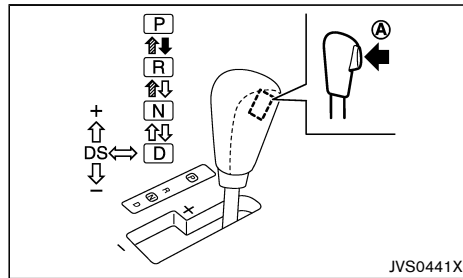

With manual shift mode (LHD model) (Type B)

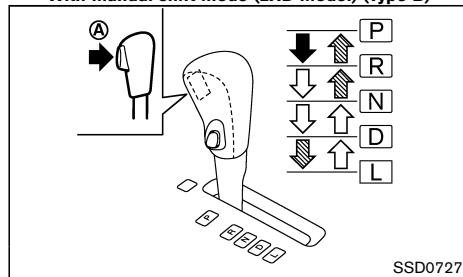

Without manual shift mode (LHD model)

- ➔: Push the button (A) while depressing the foot brake pedal.
- ▨➔: Push the button (A).
- ➔: Just move the shift lever.



**WARNING:**

- **Apply the parking brake if the shift lever is in any position while the engine is not running. Failure to do so could cause the vehicle to move unexpectedly or roll away and result in serious personal injury or property damage.**

5-14 Starting and driving

- **If the shift lever cannot be moved from the “P” (Park) position while the engine is running and the foot brake pedal is depressed, the stop lights may not work. Malfunctioning stop lights could cause an accident injuring yourself and others.**

After starting the engine, fully depress the foot brake pedal, push the shift lever button and move the shift lever out of the “P” (Park) position.

If the ignition switch is placed in the “OFF” or “ACC” position for any reason while the shift lever is in any positions other than the “P” (Park) position, the ignition switch cannot be placed in the “LOCK” position.

If the ignition switch cannot be placed in the “LOCK” position, perform the following steps:

1. Apply the parking brake.
2. Place the ignition switch in the “ON” position while depressing the foot brake pedal.
3. Move the shift lever to the “P” (Park) position.
4. Place the ignition switch in the “LOCK” position.

**P (Park):**

Use this position when the vehicle is parked or when starting the engine. **Make sure that the vehicle is completely stopped and move the shift lever into the “P” (Park) position.** Apply the parking brake. When parking on a hill, first depress the foot brake pedal, apply the parking brake, and then move the shift lever into the “P” (Park) position.

**R (Reverse):**

Use this position to back up. Make sure that the vehicle is completely stopped before selecting the “R” (Reverse) position.

**N (Neutral):**

Neither the forward nor reverse gear is engaged. The engine can be started in this position. You may shift to the “N” (Neutral) position and restart a stalled engine while the vehicle is moving.

**D (Drive):**

Use this position for all normal forward driving.

**Ds (Drive Sport) (if equipped):**

When the shift lever is shifted from the “D” (Drive) to “Ds” (Drive Sport) position, the transmission enters the Ds (Drive Sport) mode. Moving the shift lever to the “Ds” (Drive Sport) position allows you to enjoy “sporty” driving shift operation on a winding road and feel smooth acceleration or deceleration on a hilly road by moving in a lower gear automatically. Moving the shift lever forwards and backwards allows manual shifting. When canceling the Ds (Drive Sport) mode, return the shift lever to the “D” (Drive) position. The transmission returns to the normal driving mode.

**L (Low) (if equipped):**

Use this position when climbing steep hills slowly or driving slowly through deep snow, sand or mud, or for maximum engine braking on steep downhill grades.

Manual shift mode

When the shift lever is shifted from the “D” position to the manual shift gate with the vehicle stopped or while driving, the transmission enters the manual shift mode. Shift ranges can be selected manually.

In the manual shift mode, the shift range is displayed on the position indicator in the meter.

Shift ranges up or down one by one as follows:

M1 ← M2 → M3 ← M4 → M5 ← M6 → M7

- When shifting up, move the shift lever to the + (up) side. (Shifts to higher range.)
- When shifting down, move the shift lever to the - (down) side. (Shifts to lower range.)
- Moving the shift lever to the same side twice will shift the ranges in succession. However, if this motion is rapidly done, the second shifting may not be completed properly.

#### M7 (Seventh):

Use this position for all normal forward driving. However, you need to shift down the gears manually when accelerating or passing another vehicle.

#### M6 (Sixth) and M5 (Fifth):

Use these positions when driving up long slopes, or for engine braking when driving down long slopes.

#### M4 (Fourth), M3 (Third) and M2 (Second):

Use these positions for hill climbing or engine braking on downhill grades.

#### M1 (First):

Use this position when climbing steep hills slowly or driving slowly through deep snow, sand or mud or for maximum engine braking on steep downhill grades.

- Remember not to drive at high speeds for extended periods of time in lower than M7 range. This reduces fuel economy.
- **In the manual shift mode, the transmission automatically shifts down to M1 (First) before the vehicle comes to a stop. When accelerating again, it is necessary to shift up to the desired range.**
- **In the manual shift mode, the transmission may not shift to the selected gear. This helps**

**maintain driving performance and reduces the chance of vehicle damage or loss of control.**

- When canceling the manual shift mode, return the shift lever to the "D" position. The transmission returns to the normal driving mode.
- When the CVT fluid temperature is extremely low, the manual shift mode may not work and automatically shift as a drive mode. This is not a malfunction. In this case, return the shift lever to the "D" position and drive for a while and then shift to the manual shift mode.
- When the CVT fluid temperature is high, the shift range may upshift in lower rpm than usual. This is not a malfunction.

SPORT mode switch (if equipped)

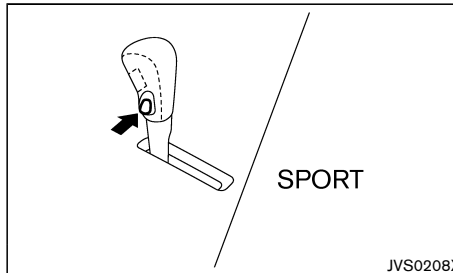

To select the SPORT mode, push the SPORT mode switch with the shift lever in the "D" (Drive) position. The SPORT mode indicator light SPORT in the meter panel illuminates. To turn off the SPORT mode, push the SPORT mode switch again. The SPORT mode indicator light will turn off. When the shift lever is shifted to any position other than "D" or "Ds", the SPORT mode will be automatically turned off.

#### "OFF" position:

For normal driving and fuel economy, use the "OFF" position.

#### "ON" position:

For driving up or down long slopes where engine braking is necessary, or for powerful acceleration, use the "ON" position. The transmission will automatically select a different gear ratio, allowing the engine to provide high output.

When driving conditions change, push the switch to turn the SPORT mode off.

Remember not to drive at high speeds for extended periods of time with the SPORT mode in the "ON" position. This reduces fuel economy.

Accelerator downshift - in the "D" position -

For passing or climbing hills, depress the accelerator pedal to the floor. This shifts the transmission down into a lower gear, depending on the vehicle speed.

#### Shift lock release

If the battery is discharged, the shift lever may not be moved from the "P" (Park) position even with the foot brake pedal depressed.

To release the shift lock, perform the following procedure:

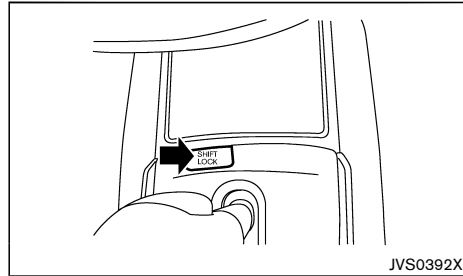
**Type A:****Example**

JVS0392X

1. Place the ignition switch in the "OFF" or "LOCK" position.
2. Apply the parking brake.
3. Remove the shift lock release cover (shown in the illustration above) using a suitable tool.
4. Insert the mechanical key and push down the shift lock release.
5. Press the shift lever button and move the shift lever to the "N" (Neutral) position while holding down the shift lock release. Replace the removed shift lock release cover after the operation.

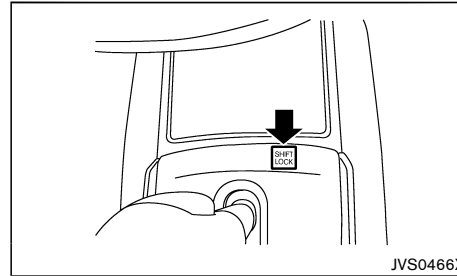
**Type B:**

JVS0466X

1. Place the ignition switch in the "OFF" or "LOCK" position.
2. Apply the parking brake.
3. Depress the shift lock release button.
4. Press the shift lever button and move the shift lever to the "N" (Neutral) position while holding down the shift lock release.

Place the ignition switch in the "ON" position to release the steering wheel lock.

The vehicle may be moved, by pushing, to the desired location.

If the shift lever cannot be moved out of the "P" (Park) position, have a NISSAN dealer check the CVT system as soon as possible.

**High fluid temperature protection mode**

This transmission has a high fluid temperature protection mode. If the fluid temperature becomes too high (for example, when climbing steep grades in high temperature with heavy loads), engine power and, under some conditions, vehicle speed will be decreased automatically to reduce the chance of transmission damage. Vehicle speed can be controlled

with the accelerator pedal, but engine and vehicle speed may be limited.

**Fail-safe**

When the fail-safe operation occurs, the CVT will not be shifted to the selected driving position.

**If the vehicle is driven under extreme conditions, such as excessive wheel spinning and subsequent hard braking, the fail-safe system may be activated. This will occur even if all electrical circuits are functioning properly. In this case, turn the ignition switch off and wait for 10 seconds. Then place the ignition switch back in the "ON" position. The vehicle should return to its normal operating condition. If it does not return to its normal operating condition, have a NISSAN dealer check the transmission and repair it if necessary.**

**WARNING:**

**When the fail-safe operation occurs, vehicle speed may be gradually reduced. The reduced speed may be lower than other traffic, which could increase the chance of a collision. Be especially careful when driving. If necessary, pull to the side of the road at a safe place and allow the transmission to return to normal operation, or have it repaired if necessary.**

**5-16 Starting and driving**

## DRIVING WITH MANUAL TRANSMISSION (MT)



### WARNING:

- Do not downshift abruptly on slippery roads. This may cause a loss of vehicle control.
- Do not over-rev the engine when shifting to a lower gear. This may cause a loss of vehicle control or engine damage.



### CAUTION:

- Do not rest your foot on the clutch pedal while driving. This may damage the clutch system.
- Fully depress the clutch pedal before shifting to help prevent transmission damage.
- Stop the vehicle completely before shifting into the "R" (Reverse) position.
- When the vehicle is stopped for a period of time, for example waiting at stoplights, shift to the "N" (Neutral) position and release the clutch pedal with the foot brake pedal depressed.
- Do not shift to the "N" (Neutral) position while driving. Coasting with the transmission in the "N" (Neutral) position may cause serious damage to the transmission.

## Starting vehicle

1. After starting the engine, depress the clutch pedal to the floor and move the shift lever to the "1" (1st) or "R" (Reverse) position.
2. Slowly depress the accelerator pedal, releasing the clutch pedal and parking brake at the same time.

## Shifting gear

To change gears, or when upshifting or downshifting, fully depress the clutch pedal, shift into the appropriate gear, then slowly and smoothly release the clutch pedal.

To ensure smooth gear changes, fully depress the clutch pedal before operating the shift lever. If the clutch pedal is not fully depressed before the transmission is shifted, a gear noise may be heard. Transmission damage could occur.

Start the vehicle in the "1" (1st) position and shift to the "2" (2nd), "3" (3rd), "4" (4th), "5" (5th) and "6" (6th) gear in sequence according to the vehicle speed.

If it is difficult to move the shift lever into the "R" (Reverse) or "1" (1st) position, shift to the "N" (Neutral) position, and then release the clutch pedal once. Fully depress the clutch pedal again and shift into "R" or "1".

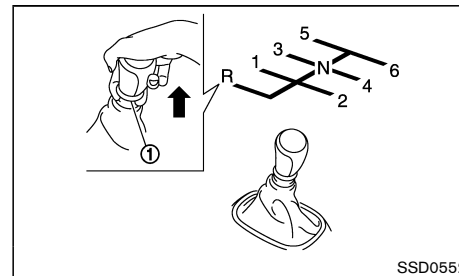

- To back up, stop the vehicle and move the shift lever into the "N" (Neutral) position, and then pull the ring ① upward to shift into the "R" (Reverse) position.
- The pull ring returns to its original position when the shift lever is moved to the "N" (Neutral) position.

## Suggested maximum speed in each gear

Downshift to a lower gear if the engine is not running smoothly, or if you need to accelerate.

Do not exceed the maximum suggested speed (shown below) in any gear. For level road driving, use the highest gear suggested for that speed. Always observe posted speed limits, and drive according to the road conditions which will ensure safe operation. Do not over-rev the engine when shifting to a lower gear as it may cause engine damage or loss of vehicle control.

### MR20DD engine model:

	km/h (MPH)
1st	45 (28)
2nd	79 (49)
3rd	110 (68)
4th	143 (89)
5th & 6th	— (—)

**R9M engine model :**

	km/h (MPH)
1st	35 (22)
2nd	63 (39)
3rd	98 (61)
4th	136 (85)
5th & 6th	— (—)

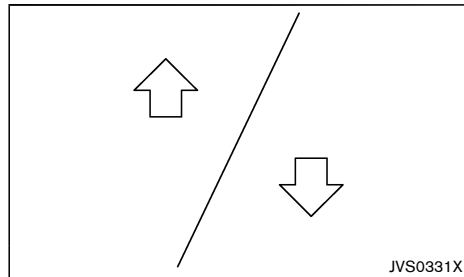
**GEAR SHIFT INDICATOR (if equipped)**

Gear Shift Indicator appears in the vehicle information display when the driver should shift into a higher or lower gear as indicated by the up or down arrow.

The use of Gear Shift Indicator will help to reduce fuel consumption.

When the up arrow appears, upshifting is recommended. When the down arrow appears, downshifting is recommended.

**CAUTION:**

**Gear Shift Indicator helps to reduce fuel consumption. It does not recommend the appropriate gear shift for all driving situations. In a certain situations, only the driver can select the**

**correct gear (for example, when overtaking, driving up a steep gradient or towing a trailer).**

**STOP/START SYSTEM OR IDLING STOP SYSTEM (if equipped)**

The Stop/Start System or Idling Stop System is designed to prevent unnecessary fuel consumption, exhaust emissions, and noise during a journey:

- When you stop the vehicle with the brake pedal depressed (CVT) or with the shift lever in “N” (Neutral) and clutch pedal released (MT), the engine is turned off automatically.
- When you release the brake pedal (CVT) or push the clutch pedal (MT), the engine is automatically turned on.

**CAUTION:**

**At the end of the journey the engine must be stopped and ignition turned off. Lock the vehicle as normal. Turning the ignition switch OFF will shut down all electrical systems. Failure to do this may result in a flat battery.**

**NOTE:**

**For model with Stop/Start System or Idling Stop System, use the special battery that is enhanced in regard to the charge-discharge capacity and life performance. Avoid using a non-special battery for the Stop/Start System or Idling Stop System, as this may cause early deterioration of the battery or a malfunction of the Stop/Start System or Idling Stop System. For the battery, it is recommended to use Genuine NISSAN parts. For more information, contact a NISSAN dealer.**

**NOTE:**

**The Stop/Start System or Idling Stop System will not activate under the following conditions:**

- when the engine is kept idling without any driving after the engine is turned on.

**5-18 Starting and driving**

- when the engine coolant temperature is low.
  - when the battery capacity is low.
  - when the battery temperature is low.
  - when the vehicle is moved.
  - when the vacuum in the brake servo decreases.
  - when the engine hood is opened with the engine running.
  - when the engine is turned on with the engine hood open.
  - when the driver's seat belt is not fastened.
  - when the driver's door is open.
  - when the steering wheel is operated (for CVT model).
  - when the Stop/Start or Idling Stop System indicator blinks at a low speed.
  - when the fan speed control is in any position other than "OFF" (0) while the air flow control is in the front defogger position.
  - when the front defogger switch is on.
  - when the temperature inside the vehicle is too high or low. (When the air conditioner is off, the Stop/Start System or Idling Stop System will operate.)
  - when the fan speed of the air conditioner is set to the maximum speed.
  - when the Stop/Start or Idling Stop OFF switch is turned on.
  - when the power consumption is large.
  - when the vehicle is traveling at altitudes higher than 2,000 m (6,562 ft) (for MT model).
  - when the vehicle is travelling at altitudes higher than 1500m (4922 ft) (R9M engine in combination with CVT models).
- For Manual Transmission (MT) models
    - when the shift lever is in any position except the "N" (Neutral) position.
    - when the clutch pedal is depressed.
    - when the Intelligent Key is not in the vehicle.
  - For Continuously Variable Transmission (CVT) models
    - when the accelerator pedal is depressed.
    - when the shift lever is in the "R" (Reverse) position.
    - when the brake pedal is not firmly depressed.
    - when stopping the vehicle on steep sloping roads.
  - when the electric power steering warning light, the Anti-lock Braking System (ABS) warning light, or the Vehicle Dynamic Control (VDC)/Electronic Stability Program (ESP) warning light illuminates.

**NOTE:**

The engine will not restart even if the brake pedal is released (CVT) or clutch pedal is pressed (MT) while the Stop/Start System or Idling Stop System is activated under the following condition:

- when the shift lever is in the "P" (Park) position (CVT model).
- when the engine hood is opened.
- when the driver seat belt is unfastened and the driver's door is opened (MT model).
- when the gear shift lever is not in the Neutral position (MT models).

**NOTE:**

It may take some time until the Stop/Start or Idling Stop System activates under the following conditions:

- when the battery is discharged.
- when the outside temperature is low or high.
- when the battery is replaced or the battery terminal is disconnected for extended periods and then reconnected.

**NOTE:**

When the Stop/Start System or Idling Stop indicator illuminates, the engine starts running automatically under at least one of the following conditions:

- the brake pedal is released with the shift lever in the "D" (Drive) or "N" (Neutral) position (for CVT model).
- the shift lever is placed in the "D" (Drive) or "R" (Reverse) position from the "N" (Neutral) or "P" (Park) position (for CVT model).
- the driver's seat belt is unfastened, or the driver's door is open (for CVT model).
- the battery voltage becomes low (due to electrical load from other vehicle systems like headlights, heaters, etc., or auxiliary devices connected to the 12 volt socket inside the vehicle).
- the vehicle speed is above about 2 km/h (1 MPH).
- the front defogger is operated.
- when the temperature inside the vehicle is too high or low. (When the air conditioner is off, the Stop/Start System or Idling Stop System will operate.)

- when the front defogger is turned on. (The engine may not start depending on the outside temperature.)
- when more than 3 minutes have elapsed since the Stop/Start System or Idling Stop System was active (for CVT model).
- when the accelerator pedal is depressed (for CVT model).
- when the steering wheel is operated. (The steering wheel operation may become heavy, but this is not a malfunction.) (for CVT model)
- when the battery capacity is low.
- when the power consumption is high.
- when the shift lever is placed in the "R" (Reverse) position (for CVT model).
- when the clutch pedal is depressed (for MT model).

**CAUTION:**

Only engage gear when the clutch pedal is fully depressed (for MT model).

**NOTE:**

The following conditions will prevent the Stop/Start System or Idling Stop System from automatically restarting the engine. Starting the engine with the ignition switch operation is then necessary:

- the driver's seat belt is unfastened, and driver's door is open (for MT model).
- the hood is open.

Use this system while waiting at stoplight, etc. When the vehicle is stopped for long periods of time, turn off the engine.

**5-20 Starting and driving**

When the engine is stopped by the Stop/Start System or Idling Stop System, heating, cooling and dehumidifying functions will be deactivated. To avoid the air conditioning functions from being deactivated, turn off the Idling Stop mode by pressing the Stop/Start or Idling Stop OFF switch.

**STOP/START SYSTEM OR IDLING STOP SYSTEM DISPLAY**

Engine stop

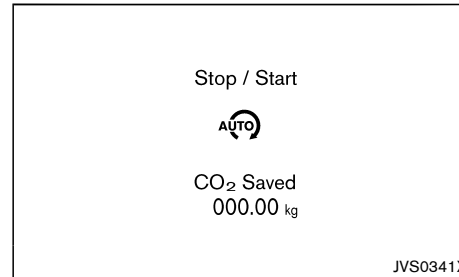

When the engine is stopped the information is displayed for a few seconds.

**Stop/Start system or Idling Stop System ON or OFF**

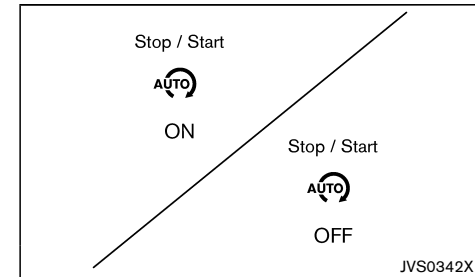

If the Stop/Start System or Idling Stop System is activated or deactivated using the Stop/Start System or Idling Stop System OFF switch, the message is shown.

**CO2 or fuel saved and engine stop time**

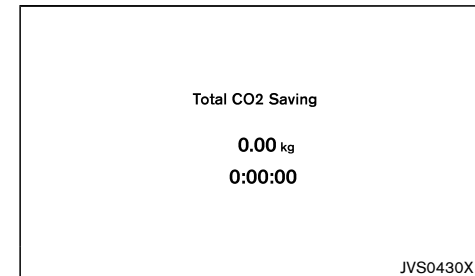

The CO2 or fuel saved and the engine stop time mode shows the following items:

- The CO2 saved shows the estimated quantity of CO2 exhaust emissions that were prevented by the Stop/Start System or Idling Stop System every



time the engine is automatically stopped. (for Europe and South Africa)

- The fuel saved shows the estimated quantity of fuel that were saved by the Idling Stop System every time the engine is automatically stopped. (for Australia and New Zealand)
- The engine stop time shows the time that the engine has been stopped for by the Stop/Start System or Idling Stop System.

For more information, see "Stop/Start System or Idling Stop System" (P.5-18).

#### Auto start deactivation

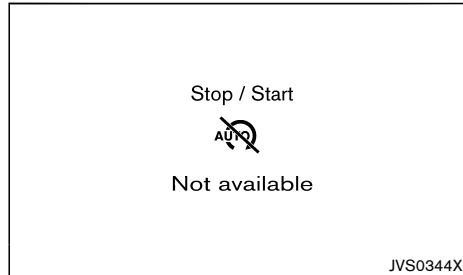

If the engine stops when the Stop/Start System or Idling Stop System is activated, and will not start automatically, the message is shown.

#### Key LOCK warning

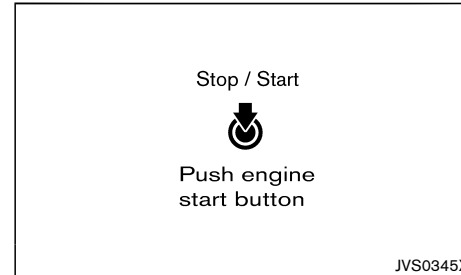

The information is displayed and a buzzer sounded to remind the driver to turn the ignition switch OFF to avoid a flat battery.

The message can only be cleared by turning or pushing the ignition switch OFF (or restarting the engine).

#### System fault

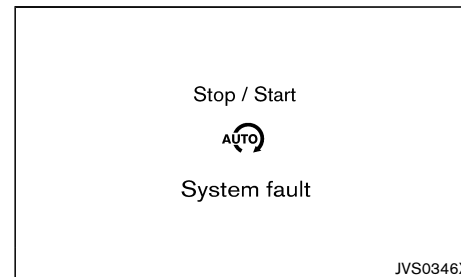

This message is displayed when the Stop/Start System or Idling Stop System is malfunctioning.

Have the system checked by a NISSAN dealer.

#### STOP/START OR IDLING STOP OFF SWITCH

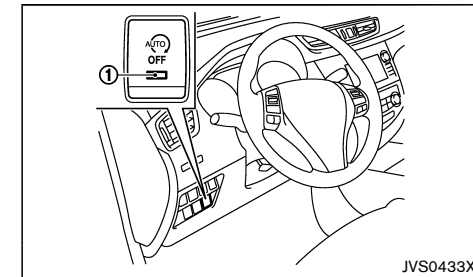

The system can be temporarily deactivated by pressing the Stop/Start or Idling Stop OFF switch. Pressing the switch again or restarting the engine by using the ignition switch will reactivate the Stop/Start System or Idling Stop System.

- When the Stop/Start System or Idling Stop System is deactivated while the engine is running, the engine is prevented from automatically stopping.
- When the Stop/Start System or Idling Stop System is deactivated after the engine has been automatically stopped by the Stop/Start System or Idling Stop System, the engine will immediately restart if suitable conditions are present. The engine will then be prevented from automatically stopping during the same journey.
- Whenever the Stop/Start System or Idling Stop System is deactivated the indicator light ① on the Stop/Start or Idling Stop OFF switch illuminates. In this condition the Stop/Start System or Idling Stop System cannot prevent unnecessary fuel consumption, exhaust emissions, or noise during your journey.

#### Starting and driving 5-21

## FOUR-WHEEL DRIVE (4WD) (if equipped)

- If the Stop/Start System or Idling Stop System is malfunctioning, the indicator light ① on the Stop/Start or Idling Stop OFF switch illuminates.

### NOTE:

The Stop/Start System ON or OFF messages displayed for a few seconds in the vehicle information display when the Stop/Start or Idling Stop OFF switch is pressed. See "Stop/Start system or Idling Stop System ON or OFF" (P.5-20).

### FOUR-WHEEL DRIVE (4WD) MODE SWITCH OPERATIONS

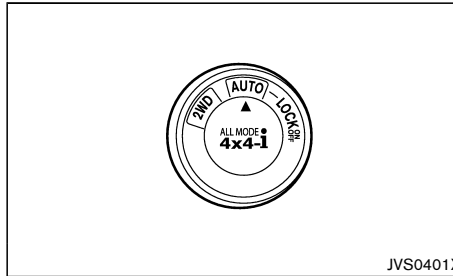

#### 4WD mode switch

The Four-Wheel Drive (4WD) system is used to select the 2WD (Two-Wheel Drive), AUTO or LOCK mode depending on the driving conditions.



Turn the 4WD mode switch, located on the center console, to select 2WD, AUTO or LOCK.

**AUTO:** Turn the 4WD mode switch to the neutral (AUTO) position. The Four-Wheel Drive (4WD) AUTO indicator light  in the meter illuminates.

**2WD:** Turn the 4WD mode switch clockwise to the 2WD position.

**LOCK:** To engage the LOCK mode, turn the 4WD mode switch counterclockwise to the LOCK position. The switch will return to the AUTO position automatically and the Four-Wheel Drive (4WD) LOCK indicator light  in the meter illuminates. To disengage the LOCK mode, turn the switch to the LOCK position again. The switch will return to the AUTO position automatically, and the 4WD LOCK indicator light turns off.

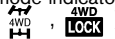
## 5-22 Starting and driving

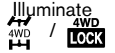
4WD mode	Wheels driven	4WD mode indicator light (  )	Use conditions
2WD	Front wheels: The wheel drive mode is in Two-Wheel Drive (2WD) when driving on a normal road. *1	Turn off	For driving on dry, paved roads
AUTO	Distribution of torque to the front and rear wheels changes automatically, depending on road conditions encountered [ratio; 100 : 0 (2WD) → 50 : 50 (4WD)]. This results in improved driving stability.	Illuminates 	For driving on paved or slippery roads
LOCK	Four-Wheel Drive (4WD) *2*3*	Illuminate 	For driving on rough roads

\*1: The 2WD mode may change to the 4WD mode automatically depending on the driving condition. The 4WD mode indicator light does not illuminate.

\*2: The LOCK mode will change to the AUTO mode automatically when the vehicle has been driven at a high speed. The 4WD LOCK indicator light turns off.

\*3: The LOCK mode will automatically be cancelled when the ignition switch is placed in the "OFF" position.

#### 4WD shift tips

- If the 4WD mode switch is operated while making a turn, accelerating or decelerating, or if the ignition switch is turned off while in the AUTO or LOCK mode, you may feel a jolt. This is normal.
- The oil temperature of power train parts will increase if the vehicle is continuously operated under conditions where the difference in rotation between the front and rear wheels is large (wheel slip), such as when driving the vehicle on rough roads through sand or mud or when freeing a stuck vehicle. In these cases, the "4WD High Temp. Stop vehicle" warning appears and the 4WD mode changes to the 2WD mode to protect the power train parts. If you stop driving with the engine idling in a safe place and wait until the "4WD High Temp. Stop vehicle" warning disappears, the 4WD returns to the mode previously selected.
- Brake distance in the 4WD mode is the same as 2WD.



#### CAUTION:

- **Depending on the driving condition, the 4WD mode may automatically change from 2WD to 4WD even when the 2WD mode is selected. If this occurs while driving, the 4WD mode indicator light will not illuminate.**
- **Do not start the engine with the 4WD mode switch in any mode in the following cases:**
  - when the vehicle is placed on a free-roller or jacking up the vehicle with the front tires raised and the rear tires on the ground.

— when towing the vehicle with the rear tires raised from the ground.

- Operate the 4WD mode switch only when driving straight. Do not operate the 4WD mode switch when making a turn or backing up.
- Do not operate the 4WD mode switch with the front wheel spinning.
- Engine idling speed is high while warming up the engine. Be especially careful when starting or driving on slippery surfaces with the 4WD mode switch set in the AUTO mode.

#### 4WD WARNING

If any malfunction occurs in the Four-Wheel Drive (4WD) system while the engine is running, warning messages appear in the vehicle information display.

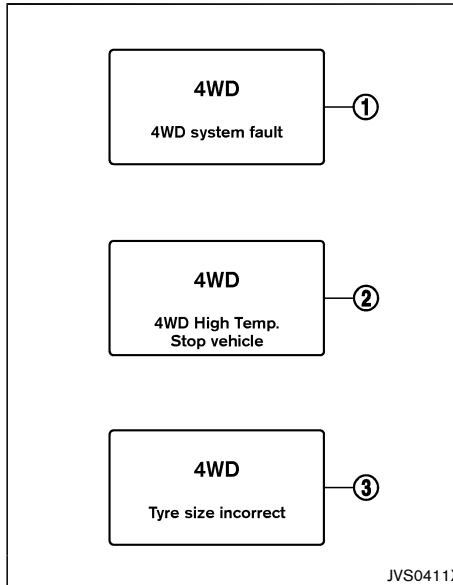

If the “4WD system fault” warning ① appears, there may be a malfunction in the 4WD system. Reduce vehicle speed and have your vehicle checked by a NISSAN dealer as soon as possible.

The “4WD High Temp. Stop vehicle” (high temperature) warning ② may appear while trying to free a stuck vehicle due to increased oil temperature. The driving mode may change to Two-Wheel Drive (2WD). If this warning is displayed, stop the vehicle with the engine idling, as soon as it is safe to do so. Then if the warning turns off, you can continue driving.

The “Tyre size incorrect” warning ③ may appear if

there is a large difference between the diameters of front and rear wheels. Pull off the road in a safe area, with the engine idling. Check that all tire sizes are the same, that the tire pressure is correct and that the tires are not excessively worn. Change the 4WD mode switch to the 2WD mode and do not drive fast.



If any warning message continues to be displayed, have your vehicle checked by a NISSAN dealer as soon as possible.





#### CAUTION:



- Do not operate the engine on a free roller when any of the wheels are raised.
- If the “4WD system fault” warning appears while driving, there may be a malfunction in the 4WD system. Reduce the vehicle speed and have your vehicle checked by a NISSAN dealer as soon as possible. Be especially careful when driving.
- The power train may be damaged if you continue driving with the “4WD system fault” warning on.

#### 4WD MODE INDICATOR LIGHTS

The 4WD mode indicator lights (  ,  ) are located in the meter.

The 4WD mode indicator lights (  ,  ) illuminate when the ignition switch is placed in the “ON” position. The indicator lights turn off within 1 second.

The 4WD mode indicator lights will display the mode selected by the 4WD mode switch while engine is running.

The 4WD LOCK indicator light  illuminates simultaneously along with the 4WD AUTO indicator light  when selecting the LOCK mode.

## 5-24 Starting and driving

The 4WD AUTO indicator light  illuminates when selecting the AUTO mode.

If the 4WD warning message appears in the vehicle information display, the 4WD mode indicator lights will turn off.

#### FOUR-WHEEL DRIVE (4WD) TORQUE DISTRIBUTION INDICATOR

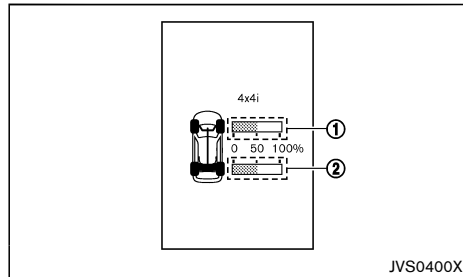

When the “4x4-i” display is selected, you can view the distribution ratio of the transmission torque to the front and rear wheels during driving. The “4x4-i” display is shown on the vehicle information display screen.

For more information, see “Trip computer” (P.2-34).

- ① Distribution ratio of front wheels
- ② Distribution ratio of rear wheels



#### **WARNING:**

**Do not watch the screen for prolonged periods of time while driving. Doing so could cause an accident.**



#### **CAUTION:**

**The display may not change when the change of torque distribution is small. This is not a malfunction.**

#### OFF-ROAD DRIVING SAFETY PRECAUTIONS

- Drive carefully when off the road and avoid dangerous areas. Always wear your seat belts to help keep you and your passengers in position when driving over rough terrain.
- Before driving up or down grades, check the road surface for bumps or potholes. Be sure to climb a gentle slope and descend a gentle slope.
- Do not drive across steep slopes. Instead drive either straight up or straight down the slopes. Off-road vehicles can tip over sideways much more easily than they can forward or backward.
- To prevent damage to the vehicle, do not drive on dry and hard surface roads in the LOCK mode.
- Many hills are too steep for any vehicle. If you drive up them, you may stall. If you drive down them, you may not be able to control your speed. If you drive across them, you may roll over.
- Do not shift gears while driving on downhill grades as this could cause loss of control of the vehicle.
- Be sure to use the engine brake. The foot brake performance may be reduced, resulting in a possible accident.
- Stay alert when driving to the top of a hill. At the top there could be a drop-off or other hazard that could cause an accident.
- If your engine stalls or you cannot make it to the top of a steep hill, never attempt to turn around. Your vehicle could tip or roll over. Always back

straight down in reverse gear. Never back down in the “N” (Neutral) position using only the brake, as this could cause loss of control.

- Heavy braking going down a hill could cause the brakes to overheat and fade, resulting in loss of control and an accident. Apply brakes lightly and use a low gear to control your speed.
- Unsecured luggage can be thrown around when driving over rough terrain. Properly secure it so that it will not be thrown forward and cause injury to you or your passengers.
- To avoid raising the center of gravity excessively, do not exceed the rated capacity of the roof rack/gear bin (if equipped) and evenly distribute the load. Secure heavy loads in the luggage area as far forward and as low as possible. Do not equip the vehicle with tires larger than specified. This could cause your vehicle to rollover.
- Do not grip the inside or spokes of the steering wheel when driving off-road. The steering wheel could jerk and injure your hands. Instead drive with your fingers and thumbs on the outside of the rim.
- Before operating vehicle, ensure that the driver and all passengers have their seat belts fastened.
- Always drive with the floor mats in place as the floor may become very hot. Particular care should be taken if you are barefoot.
- Lower your speed when encountering strong crosswinds. With its higher center of gravity, your vehicle is more affected by gusty side winds. Slower speeds ensure better vehicle control.
- **Do not drive beyond the performance of the tires even with 4WD.**

**Sudden acceleration, sharp steering maneuvers or sudden braking may cause loss of control.**

- Always use tires of the same type, size, brand, construction (bias, bias-belted or radial), and tread pattern on all four wheels. Install tire chains on the front wheels when driving on slippery roads and drive carefully.
- Be sure to check the brakes immediately after driving in mud or water. (See "Brake system" (P.5-57).)
- Whenever you drive off-road through sand, mud or water as deep as the wheel hub, more frequent maintenance may be required. For details, refer to "Maintenance for off-road driving" in a separate maintenance booklet.
- Avoid parking your vehicle on steep hills. If you get out of the vehicle and it rolls forward, backward or sideways, you could be injured.

#### TIRES OF 4WD MODEL

##### CAUTION:

- **Always use tires of the same size, brand, construction (bias, bias-belted or radial), and tread pattern on all four wheels. Failure to do so may result in a circumference difference between tires on the front and rear axles which will cause excessive tire wear and may damage the transmission, transfer case and rear differential gears.**
- **Only use spare tires specified for each 4WD model.**

If excessive tire wear is found, it is recommended that all four tires be replaced with tires of the same size, brand, construction and tread pattern. The tire pressure and wheel alignment should also be checked and corrected as necessary. Contact a NISSAN dealer.

#### 5-26 Starting and driving

##### Snow tires

If you install snow tires, they must also be the same size, brand, construction and tread pattern on all four wheels.

##### Tire inflation pressure

Check the pressures in all tires, including the spare, with a gauge periodically when at a service station. Adjust to the specified pressure if necessary. Tire pressures are shown on the tire placard.

##### Tire rotation

NISSAN recommends that tires be rotated every 5,000 km (3,000 miles). Do not include the spare tire in the tire rotation.

##### Tire chain

**Tire chains must be installed only on the front wheels and not on the rear wheels.**

Do not drive with tire chains on paved roads which are clear of snow. Driving with chains in such conditions can cause damage to the various mechanisms of the vehicle due to some overstress.



## VEHICLE DYNAMIC CONTROL (VDC)/ELECTRONIC STABILITY PROGRAM (ESP) SYSTEM

**Except for Europe: Vehicle Dynamic Control (VDC) system**



**For Europe: Electronic Stability Program (ESP) system**



##### WARNING:

- **The VDC/ESP system is designed to help the driver maintain stability but does not prevent accidents due to abrupt steering operation at high speeds or by careless or dangerous driving techniques. Reduce vehicle speed and be especially careful when driving and cornering on slippery surfaces and always drive carefully.**
- **Do not modify the vehicle's suspension. If suspension parts such as shock absorbers, struts, springs, stabilizer bars, bushings and wheels are not NISSAN recommended for your vehicle or are extremely deteriorated, the VDC/ESP system may not operate properly. This could adversely affect vehicle handling performance, and the VDC/ESP warning light  may illuminate.**
- **If brake related parts such as brake pads, rotors and calipers are not NISSAN recommended or are extremely deteriorated, the VDC/ESP system may not operate properly and the VDC/ESP warning light  may illuminate.**
- **If engine control related parts are not NISSAN recommended or are extremely deteriorated, the VDC/ESP warning light  may illuminate.**
- **When driving on extremely inclined surfaces such as higher banked corners, the VDC/ESP system may not operate properly and**

the VDC/ESP warning light  may illuminate. Do not drive on these types of roads.

- When driving on an unstable surface such as a turntable, ferry, elevator or ramp, the VDC/ESP warning light  may illuminate. This is not a malfunction. Restart the engine after driving onto a stable surface.
- If wheels or tires other than the NISSAN recommended ones are used, the VDC/ESP system may not operate properly and the VDC/ESP warning light  may illuminate.
- The VDC/ESP system is not a substitute for winter tires or tire chains on a snow covered road.

The Vehicle Dynamic Control (VDC)/Electronic Stability Program (ESP) system uses various sensors to monitor driver inputs and vehicle motion. Under certain driving conditions, the VDC/ESP system helps to perform the following functions.



- Controls brake pressure to reduce wheel slip on one slipping drive wheel so power is transferred to a non slipping drive wheel on the same axle.
- Controls brake pressure and engine output to reduce drive wheel slip based on vehicle speed (traction control function).
- Controls brake pressure at individual wheels and engine output to help the driver maintain control of the vehicle in the following conditions:
  - understeer (vehicle tends to not follow the steered path despite increased steering input)
  - oversteer (vehicle tends to spin due to certain road or driving conditions).

The VDC/ESP system can help the driver to maintain control of the vehicle, but it cannot prevent loss of vehicle control in all driving situations.

When the VDC/ESP system operates, the VDC/ESP warning light  in the meter flashes so note the following:

- The road may be slippery or the system may determine some action is required to help the vehicle on the steered path.
- You may feel a pulsation in the brake pedal and hear a noise or vibration from under the hood. This is normal and indicates that the VDC/ESP system is working properly.
- Adjust your speed and driving to the road conditions.

If a malfunction occurs in the system, the VDC/ESP warning light  illuminates in the meter. The VDC/ESP system automatically turns off.

The VDC/ESP OFF switch is used to turn off the VDC/ESP system. The VDC/ESP off indicator light  illuminates to indicate the VDC/ESP system is off. When the VDC/ESP OFF switch is used to turn off the system, the VDC/ESP system still operates to prevent one drive wheel from slipping by transferring power to a non slipping drive wheel. The VDC/ESP warning light  flashes if this occurs. All other VDC/ESP functions are off and the VDC/ESP warning light  will not flash. The VDC/ESP system is automatically reset to on when the ignition switch is placed in the "OFF" position then back to the "ON" position.

See "Vehicle Dynamic Control (VDC) warning light/Electronic Stability Program (ESP) warning light" (P.2-16) and "Vehicle Dynamic Control (VDC) off indicator light/Electronic Stability Program (ESP) off indicator light" (P.2-19).

The computer has a built-in diagnostic feature that tests the system each time you start the engine and move the vehicle forward or in reverse at a slow speed. When the self-test occurs, you may hear a "clunk"

noise and/or feel a pulsation in the brake pedal. This is normal and is not an indication of a malfunction.

#### VEHICLE DYNAMIC CONTROL (VDC)/ ELECTRONIC STABILITY PROGRAM (ESP) SYSTEM OFF SWITCH

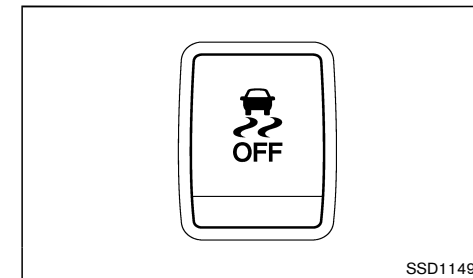

The vehicle should be driven with the Vehicle Dynamic Control (VDC)/Electronic Stability Program (ESP) system ON for most driving conditions.

When the vehicle is stuck in mud or snow, the VDC/ESP system reduces the engine output to reduce wheel spin. The engine speed will be reduced even if the accelerator is depressed to the floor. If maximum engine power is needed to free a stuck vehicle, turn the VDC/ESP system off.

To turn off the VDC/ESP system, push the VDC/ESP OFF switch. The VDC/ESP off indicator light  will illuminate.

Push the VDC/ESP OFF switch again or restart the engine to turn ON the system.

## CHASSIS CONTROL

The chassis control is an electric control module that includes the following functions:

- Active Trace Control
- Active Engine Brake
- Active Ride Control

### ACTIVE TRACE CONTROL

This system senses driving based on the driver's steering and acceleration/braking patterns, and controls brake pressure at individual wheels to aid tracing at corners and help smooth vehicle response.

The Active Trace Control can be set to ON (enabled) or OFF (disabled) through the Vehicle Information Display "Settings" page. See "Vehicle information display" (P.2-20) for more information.

When the Vehicle Dynamic Control (VDC)/Electronic Stability Program (ESP) OFF switch is used to turn off the VDC/ESP system, the Active Trace Control is also turned off.

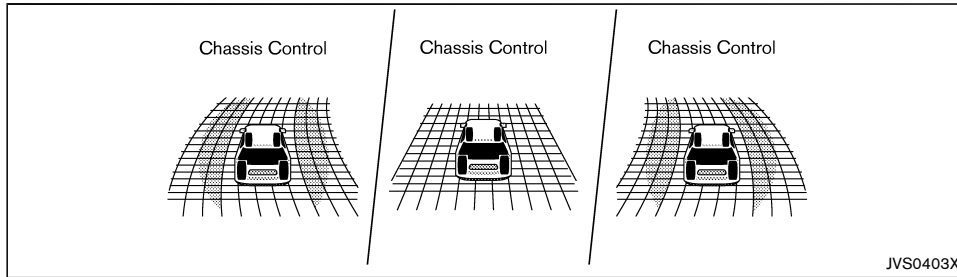

When the Active Trace Control is operated and the "Chassis Control" mode is selected in the trip computer, the Active Trace Control graphics are shown in the vehicle information display. (See "Trip computer" (P.2-34).)

If the chassis control warning message appears in the vehicle information display, it may indicate that the Active Trace Control is not functioning properly. Have the system checked by a NISSAN dealer as soon as possible. (See "Vehicle information display warnings and indicators" (P.2-28).)



#### **WARNING:**

**The Active Trace Control may not be effective depending on the driving condition. Always drive carefully and attentively.**

When the Active Trace Control is operating, you may feel a pulsation in the brake pedal and hear a noise. This is normal and indicates that the Active Trace Control is operating properly.

Even if the Active Trace Control is set to OFF, some functions will remain on to assist the driver (for example, avoidance scenes).

### ACTIVE ENGINE BRAKE (Continuously Variable Transmission (CVT) models)

The Active Engine Brake function adds subtle deceleration by controlling CVT gear ratio, depending on the cornering condition calculated from driver's steering input and plural sensors. This benefit to easier traceability and less workload of adjusting speed with braking at corners.

The Active Engine Brake also adds subtle deceleration with gear ratio control according to driver's brake pedal operation.

The Active Engine Brake can be set to ON (enabled) or OFF (disabled) through the Vehicle Information Display "Settings" page. See "Vehicle information display" (P.2-20) for more information.



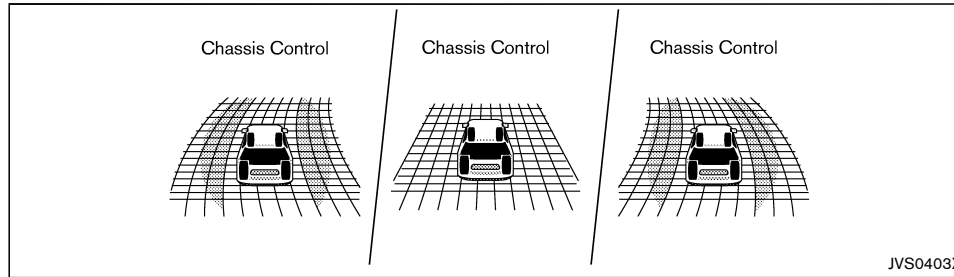

When the Active Engine Brake is operated at corners and the "Chassis Control" mode is selected in the trip computer, the Active Engine Brake graphics are shown in the vehicle information display. See "Trip computer" (P.2-34) for more information.

If the chassis control warning message appears in the vehicle information display, it may indicate that the Active Engine Brake is not functioning properly. Have the system checked by a NISSAN dealer as soon as possible.



**WARNING:**

**The Active Engine Brake may not be effective depending on the driving condition. Always drive carefully and attentively.**

When the Active Engine Brake is operating, the needle of the tachometer will rise up and you may hear an engine noise. This is normal and indicates that the Active Engine Brake is operating properly.

**ACTIVE RIDE CONTROL**

This system senses upper body motion based on wheel speed information and controls engine torque and four wheel brake pressure to enhance ride comfort in effort to restrain uncomfortable upper body movement. This system come into effect above 40 km/h (25 MPH). When the VDC/ESP OFF switch is used to turn off the VDC/ESP system, the Active Ride Control is also turned off. Engine torque control is available for MR20 and QR25 engines only.

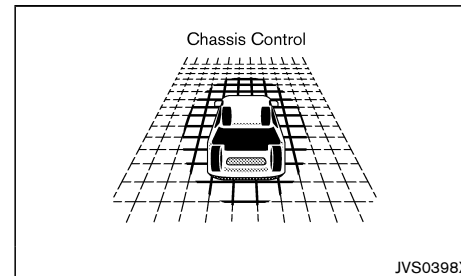

When the brake control of the Active Ride Control is operated and the "Chassis Control" mode is selected in the trip computer, the Active Ride Control graphics

are shown in the vehicle information display. See "Trip computer" (P.2-34) for more information.

If the chassis control warning message appears in the vehicle information display, it may indicate that the Active Ride Control is not functioning properly. Have the system checked by a NISSAN dealer as soon as possible.

When the Active Ride Control is operating, you may hear noise and sense slight deceleration. This is normal and indicates that the Active Ride Control is operating properly.

## HILL START ASSIST SYSTEM

### WARNING:

- **Never rely solely on the hill start assist system to prevent the vehicle from moving backward on a hill. Always drive carefully and attentively. Depress the brake pedal when the vehicle is stopped on a steep hill. Be especially careful when stopped on a hill on frozen or muddy roads. Failure to prevent the vehicle from rolling backwards may result in a loss of control of the vehicle and possible serious injury or death.**
- **The hill start assist system is not designed to hold the vehicle at a standstill on a hill. Depress the brake pedal when the vehicle is stopped on a steep hill. Failure to do so may cause the vehicle to roll backwards and may result in a collision or serious personal injury.**
- **The hill start assist system may not prevent the vehicle from rolling backwards on a hill under all load or road conditions. Always be prepared to depress the brake pedal to prevent the vehicle from rolling backwards. Failure to do so may result in a collision or serious personal injury.**

The hill start assist system automatically keeps the brakes applied to help prevent the vehicle from rolling backwards in the time it takes the driver to release the brake pedal and apply the accelerator when the vehicle is stopped on a hill.

The hill start assist system will operate automatically under the following conditions:

- The transmission is shifted to a forward or reverse gear.

### 5-30 Starting and driving

- The vehicle is stopped completely on a hill by applying the brake.

The maximum holding time is 2 seconds. After 2 seconds the vehicle will begin to roll back and the hill start assist system will stop operating completely.

The hill start assist system will not operate when the transmission is shifted to the "N" (Neutral) or "P" (Park) position or on a flat and level road.

When the Vehicle Dynamic Control (VDC)/Electronic Stability Program (ESP) warning light illuminates in the meter, the hill start assist system will not operate. (See "Vehicle Dynamic Control (VDC) warning light/Electronic Stability Program (ESP) warning light" (P.2-16).)

## HILL DESCENT CONTROL SYSTEM (if equipped)

### WARNING:

- **Never rely solely on the hill descent control system to control vehicle speed when driving on steep downhill grades. Always drive carefully when using the hill descent control system and decelerate the vehicle speed by depressing the brake pedal if necessary. Be especially careful when driving on frozen, muddy or extremely steep downhill roads. Failure to control vehicle speed may result in a loss of control of the vehicle and possible serious injury or death.**
- **The hill descent control system may not control the vehicle speed on a hill under all load or road conditions. Always be prepared to depress the brake pedal to control vehicle speed. Failure to do so may result in a collision or serious personal injury.**

### CAUTION:

**When the hill descent control system operates continuously for a long time, the temperature of the Vehicle Dynamic Control (VDC)/Electronic Stability Program (ESP) system actuator may increase and the hill descent control system may be temporarily disabled (the hill descent control system on indicator light will blink). If the indicator light does not come on continuously after blinking, stop using the system.**

When the hill descent control system is activated, it automatically applies smooth brakes to control speed on a steep and slippery descent or off the road without brake or accelerator operation.

The hill descent control system helps maintain vehicle speed when driving under 25 km/h (15 MPH) on a

steep descent that engine braking alone in Four-Wheel Drive (4WD) mode cannot control the speed.

When driving forward on the descent, the speed can be adjusted by the brake or accelerator operation. The system maintains the speed for reverse driving on the descent.

### HILL DESCENT CONTROL SWITCH

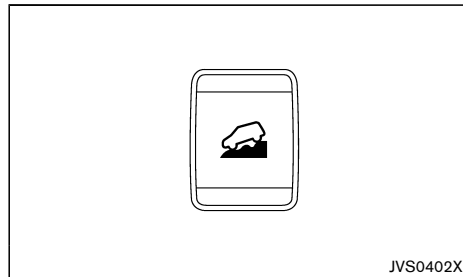

When additional braking is required on steep downhill roads, activate the hill descent control system by pushing the hill descent control switch on.

When the hill descent control system is activated, the hill descent control system on indicator light  will illuminate. (See "Hill descent control system on indicator light" (P.2-18).) Also, the stop/tail lights illuminate while the hill descent control system is applying the brakes to control the vehicle speed.

To activate the hill descent control system, satisfy all of the following conditions:

- Shift the transmission to the forward or reverse gear.
- Turn the 4WD mode switch to the LOCK mode and drive the vehicle at a speed under 25 km/h (15 MPH).

- Push the hill descent control switch to the "ON" position.

If the accelerator or brake pedal is depressed while the hill descent control system is on, the system will stop operating temporarily. As soon as the accelerator or brake pedal is released, the hill descent control system begins to function again if the hill descent control operating conditions are fulfilled.

The hill descent control system on indicator light blinks if the hill descent control switch is on and all conditions for system activation are not met, or if the system becomes disengaged for any reason.

When the vehicle speed exceeds 40 km/h (25 MPH), the 4WD mode indicator light changes from LOCK to AUTO. Once the speed decreases to 25 km/h (15 MPH), turn the 4WD mode switch to LOCK again to turn on the hill descent control system.

To turn off the hill descent control system, push the hill descent control switch to the OFF position.

## BLIND SPOT WARNING (BSW)/ LANE DEPARTURE WARNING (LDW) SYSTEMS (if equipped)

The Blind Spot Warning (BSW) system helps alert the driver of other vehicles in adjacent lanes when changing lanes.

The Lane Departure Warning (LDW) system helps alert the driver when the vehicle is traveling close to either the left or the right of a traveling lane.

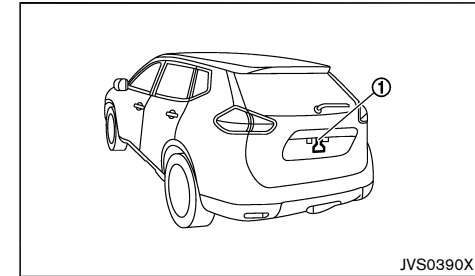

The BSW/LDW systems use the rearview camera unit  with automatic washer and blower.



### WARNING:

- **The BSW system is not a replacement for proper driving procedure and is not designed to prevent contact with vehicles or objects. When changing lanes, always use the side and rear mirrors and turn and look in the direction you will move to ensure it is safe to change lanes. Never rely solely on the BSW system.**
- **The LDW system is only a warning device to help inform the driver of a potential unintended lane departure. It will not steer the vehicle or prevent loss of control. It is the driver's responsibility to stay alert, drive safely, keep the vehicle in the traveling lane,**

Starting and driving 5-31

and be in control of the vehicle at all times.

- The camera unit may not function properly under the following conditions:
  - When towing a trailer (for Australia, New Zealand and South Africa).
  - When strong light enters the camera unit. (For example, light directly shines on the rear of the vehicle at sunrise or sunset.)
  - When ambient brightness changes suddenly. (For example, when the vehicle enters or exits a tunnel or passes under a bridge.)
- If the camera lens is excessively dirty, the automatic washer may not be able to completely clean the lens. This could result in the camera not detecting vehicles or lane markers.
- Excessive noise (for example, audio system volume, open vehicle window) will interfere with the chime sound, and it may not be heard.

#### BSW SYSTEM OPERATION

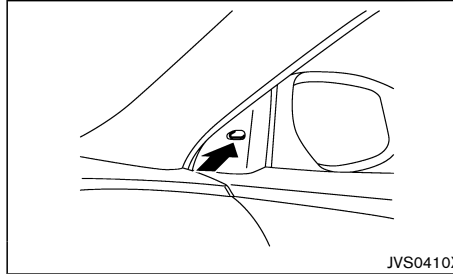

Blind Spot Indicator light

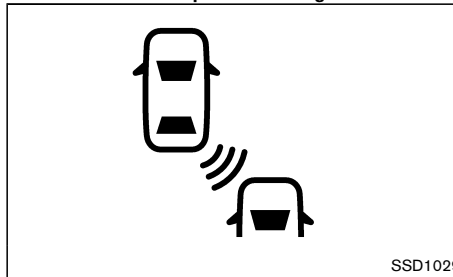

BSW indicator (in the Vehicle information display)

The BSW system operates above approximately 32 km/h (20 MPH).

When the camera unit detects vehicles in the detection zone, the Blind Spot Indicator light located inside the outside mirrors will illuminate. If the turn signal is then activated, the system chimes (twice) and the Blind Spot Indicator light flashes to alert the driver.

The Blind Spot Indicator light continues to flash until the detected vehicle(s) leave the detection zone.

#### Detection zone

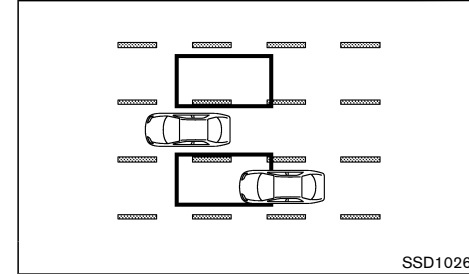

The camera unit can detect vehicles on either side of your vehicle when part of another vehicle is within the detection zone shown as illustrated.

This detection zone typically starts from the outside mirror of your vehicle and extends approximately 3 m (10 ft) behind the rear bumper, and approximately 3 m (10 ft) sideways.

#### NOTE:

**The Blind Spot Indicator light will illuminate for a few seconds when the ignition switch is placed in the "ON" position.**

The brightness of the Blind Spot Indicator lights is adjusted automatically depending on the brightness of the ambient light.

A chime sounds if the camera unit has already detected vehicles when the driver activates the turn signal. If a vehicle comes into the detection zone after the driver activates the turn signal, then only the Blind Spot Indicator light flashes and no chime sounds. (See "BSW driving situations" (P.5-33).)

## 5-32 Starting and driving

### Turning on or off the BSW system

The BSW system is turned on or off using the settings menu in the vehicle information display.



#### SYSTEM ON:

The BSW indicator (white) in the vehicle information display will appear.

#### SYSTEM OFF:

The BSW indicator (white) in the vehicle information display will off.

Perform the following steps to enable or disable the BSW system.

1. Use the  button until "Settings" displays in the vehicle information display. Use the  to select "Driver Assistance". Then press the ENTER button.
2. Select "Driving Aids", and press the ENTER button.
3. To set the BSW system to on or off, use the  buttons to navigate in the menu and use the ENTER button to select or change an item:
  - Select "Blind Spot" and press the ENTER button.
  - To turn on the warning, use the ENTER button to check box for "Warning (BSW)"



#### WARNING:

- **The camera unit may not be able to detect when certain objects are present such as:**
  - Pedestrians, bicycles, animals
  - Some types of small vehicles such as motorcycles and very short length vehicles

#### — Oncoming vehicles

- **A vehicle approaching rapidly from behind.** (See "BSW driving situations" (P.5-33).)
  - **A vehicle which your vehicle overtakes rapidly.** (See "BSW driving situations" (P.5-33).)
  - **A vehicle that merges or changes lanes rapidly directly next to your vehicle.**
- **The camera unit may not be able to detect properly when your vehicle travels beside the middle section of a vehicle with long wheelbase (for example, trailer truck, semi-trailer, tractor).**
  - **The camera detection zone is designed based on a standard lane width. When driving in a wider lane, the camera unit may not detect vehicles in an adjacent lane. When driving in a narrow lane, the camera unit may detect vehicles driving two lanes away.**
  - **The camera unit is designed to ignore most stationary objects, however objects such as guardrails, walls, foliage and parked vehicles may occasionally be detected. This is a normal operating condition.**
  - **The camera unit may detect the reflected image of vehicles or roadside objects that are not actually in the detection zone, especially when the road is wet.**

### BSW DRIVING SITUATIONS

Another vehicle approaching from behind

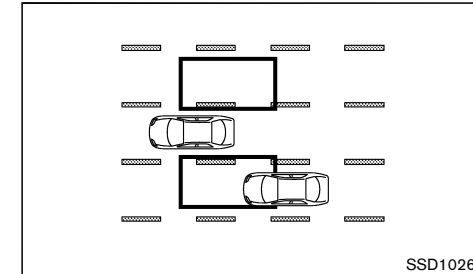

The Blind Spot Indicator light illuminates if a vehicle enters the detection zone from behind in an adjacent lane.

However, if the overtaking vehicle is traveling much faster than your vehicle, the indicator light may not illuminate before the detected vehicle is beside your vehicle. Always use the side and rear mirrors and turn and look in the direction your vehicle will move to ensure it is safe to change lanes.

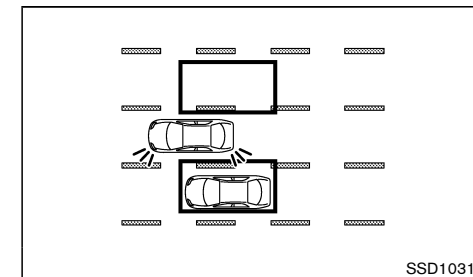

If the driver activates the turn signal, then the Blind

**Starting and driving 5-33**

Spot Indicator light flashes and a chime will sound twice.

**NOTE:**

**If the driver activates the turn signal before a vehicle enters the detection zone, the Blind Spot Indicator light will flash but no chime will sound when the other vehicle is detected.**

Overtaking other vehicles

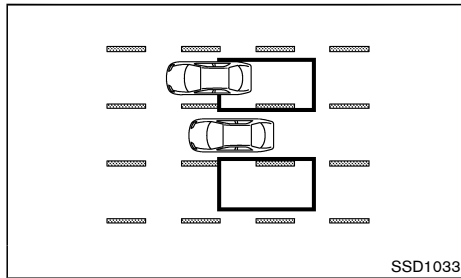

The Blind Spot Indicator light illuminates if you overtake a vehicle and that vehicle stays in the detection zone for approximately 3 seconds.

The camera unit may not detect slower moving vehicles if they are passed quickly.

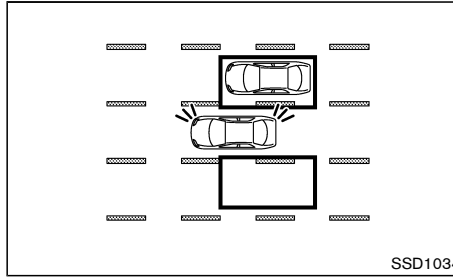

If the driver activates the turn signal while another vehicle is in the detection zone, then the Blind Spot Indicator light flashes and a chime will sound twice.

**LDW SYSTEM OPERATION**

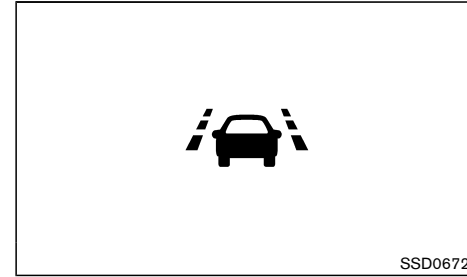
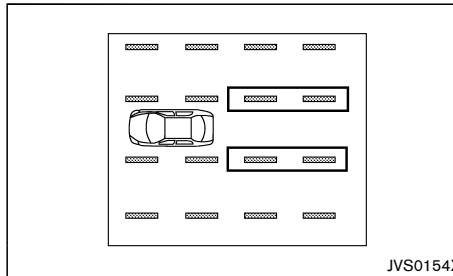

**LDW indicator (in the Vehicle information display)**

The LDW system operates above approximately 70 km/h (45 MPH).

When the vehicle approaches either the left or the right of the traveling lane, the LDW system will chime a sound and the LDW indicator (orange) on the meter will blink to alert the driver.

The LDW system is not designed to operate under the following conditions.

- When you operate the lane change signal and change traveling lanes in the direction of the signal. (The LDW system will become operable again approximately 2 seconds after the lane change signal is turned off.)
- When the vehicle speed is less than approximately 70 km/h (45 MPH).

**Turning on or off the LDW system**

The LDW system is turned on or off using the settings menu in the vehicle information display.



**SYSTEM ON:**

The LDW indicator (white) in the vehicle information display will appear.

**SYSTEM OFF:**

The LDW indicator (white) in the vehicle information display will off.

Perform the following steps to enable or disable the LDW system.

1. Use the  button until "Settings" displays in the vehicle information display. Use the  to select "Driver Assistance". Then press the ENTER button.
2. Select "Driving Aids", and press the ENTER button.
3. To set the LDW system to on or off, use the  buttons to navigate in the menu and use the ENTER button to select "Lane" and press the ENTER button.

**WARNING:**

- **The camera unit may not be able to detect properly under the following conditions:**
  - **On roads where there are multiple parallel lane markers; lane markers that are faded or not painted clearly; yellow painted lane markers; nonstandard lane markers; or lane markers covered with water, dirt, snow, etc.**
  - **On roads where the discontinued lane markers are still detectable.**
  - **On roads where there are sharp curves.**
  - **On roads where there are sharply contrasting objects, such as shadows, snow, water, wheel ruts, seams or lines**

**remaining after road repairs. (The LDW system could detect these items as lane markers.)**

- **On roads where the traveling lane merges or separates.**
- **When the vehicle's traveling direction does not align with the lane marker.**
- **When the road surface is very dark due to weak ambient light or impaired tail lamp.**
- **When driving on a curved road, warning will be late on the outside of the curve.**

**BSW/LDW TEMPORARY DISABLED STATUS**

Under the following condition, the BSW and/or LDW system is turned off temporarily, the BSW indicator (white) and/or LDW indicator (white) will blink, and the following message will appear in the vehicle information display:

- "Back Door Open"

When the above condition is corrected, the BSW and/or LDW system will resume automatically.

**BSW/LDW AUTOMATIC DEACTIVATION**

When dirt, rain or snow accumulates on the camera, the BSW and/or LDW system will be turned off automatically and cannot be removed by the automatic washer and blower. The BSW indicator (white) and/or LDW indicator (white) will blink, and the "Not available Clean Rear Camera" message will appear in the vehicle information display.

Action to take:

If the message appears, park the vehicle in a safe place, clean the camera unit with a soft cloth. Then turn

off and restart the engine.

**BSW/LDW MALFUNCTION**

When the BSW and/or LDW system malfunctions, they will be turned off automatically, the BSW indicator (orange) and/or LDW indicator (orange) will illuminate and the "System fault" message will appear in the vehicle information display.

Action to take:

Stop the vehicle in a safe location, turn off and restart the engine. If the BSW indicator (orange) and/or LDW indicator (orange) continues to illuminate, have the BSW and/or LDW system checked by a NISSAN dealer.

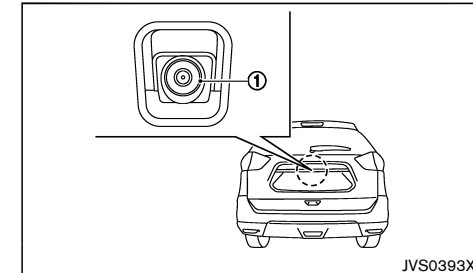
**CAMERA UNIT MAINTENANCE**

The rearview camera unit ① for the LDW/BSW systems is located above the rear licence plate. To maintain the proper operation of the LDW/BSW systems and help keep the system functioning, be sure to observe the following:

- Always keep the camera unit clean. Be careful not to damage the nozzle of automatic washer and blower.

## BLIND SPOT WARNING (BSW) SYSTEM (if equipped for Europe)

- Do not attach "licence plate accessories" that reflect light.
- Do not strike or damage the areas around the camera unit.

The Blind Spot Warning (BSW) system helps alert the driver of other vehicles in adjacent lanes when changing lanes.

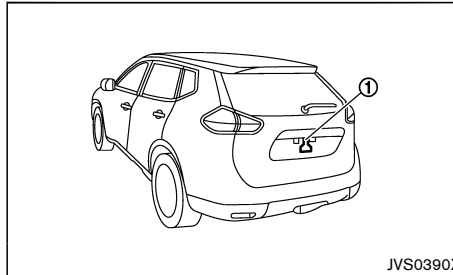

The BSW system uses the rearview camera unit (1) with automatic washer and blower.

### **⚠ WARNING:**

- **The BSW system is not a replacement for proper driving procedure and is not designed to prevent contact with vehicles or objects. When changing lanes, always use the side and rear mirrors and turn and look in the direction you will move to ensure it is safe to change lanes. Never rely solely on the BSW system.**
- **The camera unit may not function properly under the following conditions:**
  - When towing a trailer.
  - When strong light enters the camera unit. (For example, light directly shines on the rear of the vehicle at sunrise or sunset.)

– **When ambient brightness changes suddenly. (For example, when the vehicle enters or exits a tunnel or passes under a bridge.)**

- **If the camera lens is excessively dirty, the automatic washer may not be able to completely clean the lens. This could result in the camera not detecting vehicles or lane markers.**
- **Excessive noise (for example, audio system volume, open vehicle window) will interfere with the chime sound, and it may not be heard.**

## BSW SYSTEM OPERATION

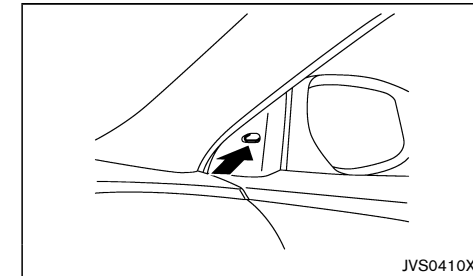

Blind Spot Indicator light



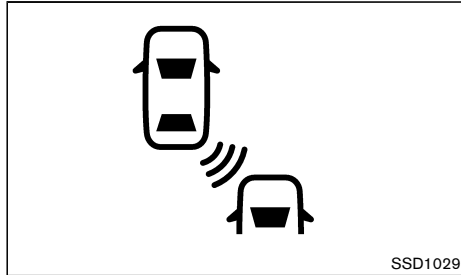

#### BSW indicator (in the Vehicle information display)

The BSW system operates above approximately 32 km/h (20 MPH).

The BSW light is shown in the vehicle information display if the Blind Spot Warning system is active. To switch the system on or off, see the description later in this section.

When the camera unit detects vehicles in the detection zone, the Blind Spot Indicator light located inside the outside mirrors will illuminate. If the turn signal is then activated, the system chimes (twice) and the Blind Spot Indicator light flashes to alert the driver.

The Blind Spot Indicator light continues to flash until the detected vehicle(s) leave the detection zone.

#### Detection zone

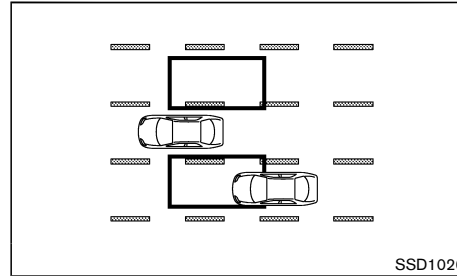

The camera unit can detect vehicles on either side of your vehicle when part of another vehicle is within the detection zone shown as illustrated.

This detection zone typically starts from the outside mirror of your vehicle and extends approximately 3 m (10 ft) behind the rear bumper, and approximately 3 m (10 ft) sideways.

The brightness of the Blind Spot Indicator lights is adjusted automatically depending on the brightness of the ambient light.

A chime sounds if the camera unit has already detected vehicles when the driver activates the turn signal. If a vehicle comes into the detection zone after the driver activates the turn signal, then only the Blind Spot Indicator light flashes and no chime sounds. (See "BSW driving situations" (P.5-33).)

#### Turning on or off the BSW system

The BSW system is turned on or off using the settings menu in the vehicle information display.



#### SYSTEM ON:

The BSW indicator (white) in the vehicle information display will appear.

#### SYSTEM OFF:

The BSW indicator in the vehicle information display will turn off.

Perform the following steps to enable or disable the BSW system.

1. Use the  button until "Settings" displays in the vehicle information display. Use the  to select "Driver Assistance". Then press the ENTER button.
2. Select "Driving Aids", and press the ENTER button.
3. To set the BSW system to on or off, use the  buttons to navigate in the menu and use the ENTER button to select "Blind Spot" and press the ENTER button.



#### WARNING:

- **The camera unit may not be able to detect when certain objects are present such as:**
  - Pedestrians, bicycles, animals
  - Some types of small vehicles such as motorcycles and very short length vehicles
  - Oncoming vehicles
  - A vehicle approaching rapidly from behind. (See "BSW driving situations" (P.5-33).)

Starting and driving 5-37

- A vehicle which your vehicle overtakes rapidly. (See “BSW driving situations” (P.5-33).)
- A vehicle that merges or changes lanes rapidly directly next to your vehicle.
- The camera unit may not be able to detect properly when your vehicle travels beside the middle section of a vehicle with long wheelbase (for example, trailer truck, semi-trailer, tractor).
- The camera detection zone is designed based on a standard lane width. When driving in a wider lane, the camera unit may not detect vehicles in an adjacent lane. When driving in a narrow lane, the camera unit may detect vehicles driving two lanes away.
- The camera unit is designed to ignore most stationary objects, however objects such as guardrails, walls, foliage and parked vehicles may occasionally be detected. This is a normal operating condition.
- The camera unit may detect the reflected image of vehicles or roadside objects that are not actually in the detection zone, especially when the road is wet.

## BSW DRIVING SITUATIONS

Another vehicle approaching from behind

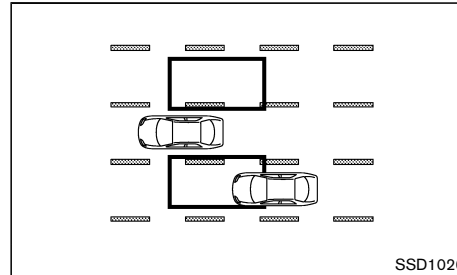

The Blind Spot Indicator light illuminates if a vehicle enters the detection zone from behind in an adjacent lane.

However, if the overtaking vehicle is traveling much faster than your vehicle, the indicator light may not illuminate before the detected vehicle is beside your vehicle. Always use the side and rear mirrors and turn and look in the direction your vehicle will move to ensure it is safe to change lanes.

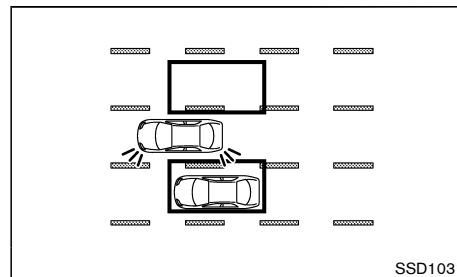

If the driver activates the turn signal, then the Blind

Spot Indicator light flashes and a chime will sound twice.

### NOTE:

**If the driver activates the turn signal before a vehicle enters the detection zone, the Blind Spot Indicator light will flash but no chime will sound when the other vehicle is detected.**

Overtaking other vehicles

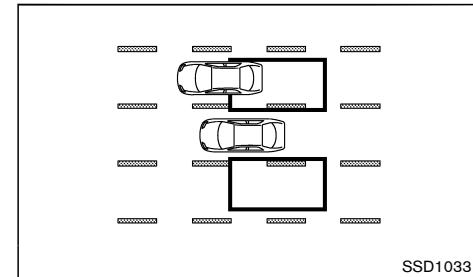

The Blind Spot Indicator light illuminates if you overtake a vehicle and that vehicle stays in the detection zone for approximately 3 seconds.

The camera unit may not detect slower moving vehicles if they are passed quickly.

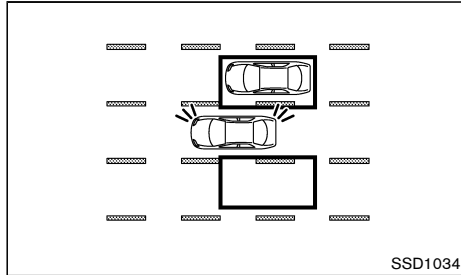

If the driver activates the turn signal while another vehicle is in the detection zone, then the Blind Spot Indicator light flashes and a chime will sound twice.

### BSW TEMPORARILY DISABLED STATUS

Under the following condition, the BSW system is turned off temporarily, the BSW indicator will blink, and the following message will appear in the vehicle information display:

- "Back Door Open"

When the above condition is corrected, the BSW system will resume automatically.

### BSW AUTOMATIC DEACTIVATION

When dirt, rain or snow accumulates on the camera, the BSW system will be turned off automatically and cannot be removed by the automatic washer and blower. The BSW indicator will blink and the "Not available Clean Rear Camera" message will appear in the vehicle information display.

Action to take:

If the message appears, park the vehicle in a safe place, clean the camera unit with a soft cloth. Then turn off and restart the engine.

### BSW MALFUNCTION

When the BSW system malfunctions, they will be turned off automatically, the BSW indicator will illuminate and the "System fault" message will appear in the vehicle information display.

Action to take:

Stop the vehicle in a safe location, turn off and restart the engine. If the BSW indicator continues to illuminate, have the BSW system checked by a NISSAN dealer.

### CAMERA UNIT MAINTENANCE

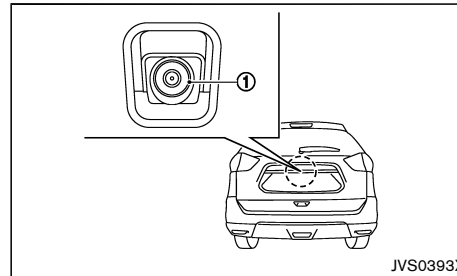

The rearview camera unit ① for the BSW system is located above the rear licence plate. To maintain the proper operation of the BSW system and help keep the system functioning, be sure to observe the following:

- Always keep the camera unit clean. Be careful not to damage the nozzle of automatic washer and blower.
- Do not attach "licence plate accessories" that reflect light.
- Do not strike or damage the areas around the camera unit.

## LANE DEPARTURE WARNING (LDW) SYSTEM (if equipped for Europe)

The Lane Departure Warning (LDW) system helps alert the driver when the vehicle is traveling close to either the left or the right of a traveling lane.

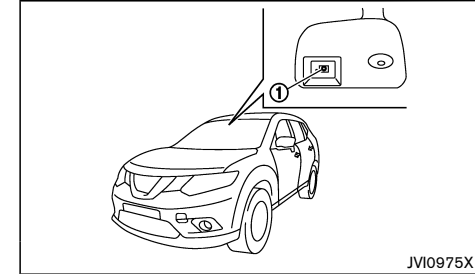

The LDW system uses the multi-sensing front camera unit situated on the windshield in front of the inside rearview mirror ①.



### WARNING:

- **This system is only a warning device to inform the driver of a potential unintended lane departure. It will not steer the vehicle or prevent loss of control. It is the driver's responsibility to stay alert, drive safely, keep the vehicle in the traveling lane, and be in control of the vehicle at all times.**
- **The system will not operate at speeds below approximately 60 km/h (37 MPH) or if it cannot detect lane markers.**
- **If the LDW system malfunctions, it will cancel automatically, and the LDW "System fault" message will appear in the vehicle information display.**
- **If the LDW "System fault" message appears, pull off the road to a safe location and stop**

Starting and driving 5-39

**the vehicle. Turn the engine off and restart the engine. If the LDW “System fault” message continues to appear, have the system checked by a NISSAN dealer.**

- **Excessive noise will interfere with the warning chime sound, and the chime may not be heard.**

The system may not function properly under the following conditions:

- On roads where there are multiple parallel lane markers; lane markers that are faded or not painted clearly; yellow painted lane markers; non-standard lane markers; or lane markers covered with water, dirt, snow, etc.
- On roads where the discontinued lane markers are still detectable.
- On roads where there are sharp curves.
- On roads where there are sharply contrasting objects, such as shadows, snow, water, wheel ruts, seams or lines remaining after road repairs. (The Lane Departure Warning (LDW) system could detect these items as lane markers.)
- On roads where the traveling lane merges or separates.
- When the vehicle’s traveling direction does not align with the lane marker.
- When traveling close to the vehicle in front of you, which obstructs the lane camera unit detection range.
- When rain, snow or dirt adheres to the windshield in front of the lane camera unit.
- When the headlights are not bright due to dirt on the lens or if the aiming is not adjusted properly.
- When strong light enters the lane camera unit. (For example, the light directly shines on the front

of the vehicle at sunrise or sunset.)

- When a sudden change in brightness occurs. (For example, when the vehicle enters or exits a tunnel or under a bridge.)

#### LDW SYSTEM OPERATION

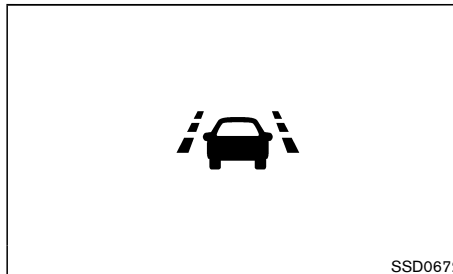
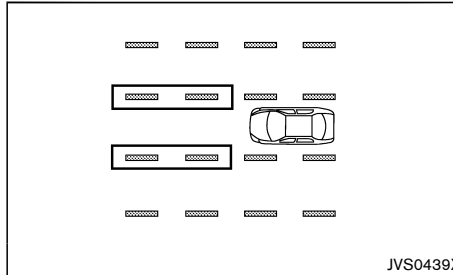

#### **LDW indicator (in the Vehicle information display)**

The LDW system provides a lane departure warning function when the vehicle is driven at speeds approximately 60 km/h (37 MPH) and above.

When the vehicle approaches either the left or the right side of the traveling lane, a warning chime will sound and the LDW indicator in the vehicle information display will blink to alert the driver.

The warning function will stop when the vehicle returns inside of the lane markers.

The LDW system is not designed to warn under the following conditions.

- When you operate the lane change signal and change traveling lanes in the direction of the signal. (The LDW system will become operable again approximately 2 seconds after the lane change signal is turned off.)
- When the vehicle speed lowers to less than approximately 60 km/h (37 MPH).

After the above conditions have finished and the necessary operating conditions are satisfied, the LDW functions will resume.

#### Turning on or off the LDW system

The LDW system is turned on or off using the settings menu in the vehicle information display.



#### **SYSTEM ON:**

The LDW indicator in the vehicle information display will appear.

#### **SYSTEM OFF:**

The LDW indicator in the vehicle information display will off.

Perform the following steps to enable or disable the LDW system.

1. Use the  button until “Settings” displays in the vehicle information display. Use the  to select “Driver Assistance”. Then press the ENTER button.
2. Select “Driving Aids”, and press the ENTER button.
3. To set the LDW system to on or off, use the  buttons to navigate in the menu and use the

## 5-40 Starting and driving

ENTER button to select "Lane" and press the ENTER button.

### TEMPORARY DISABLED STATUS AT HIGH TEMPERATURE

If the vehicle is parked in direct sunlight under high temperature conditions (over approximately 40°C (104°F) and then started, the LDW system may be deactivated automatically. The "High cabin temperature" warning message will appear in the vehicle information display.

When the interior temperature is reduced, the LDW system will resume operating automatically.

### MULTI-SENSING CAMERA UNIT MAINTENANCE

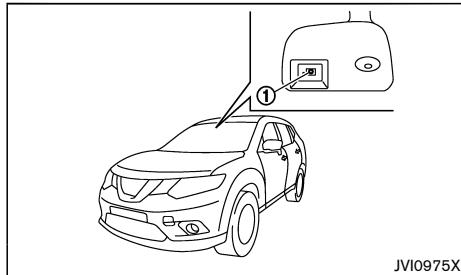

The multi-sensing camera unit (1) for the LDW system is located on the windshield in front of the inside rearview mirror. To maintain the proper operation of the LDW system and prevent a system malfunction be sure to observe the following:

- Always keep the windshield clean.
- Do not attach a sticker (including transparent material) or install an accessory near the multi-sensing lane camera unit.

- Do not place reflective materials, such as white paper or a mirror, on the instrument panel. The reflection of sunlight may adversely affect the multi-sensing camera unit's detection capability.
- Do not strike or damage the areas around the camera unit. Do not touch the camera lens or remove the screw located on the camera unit. If the camera unit is damaged due to an accident, contact a NISSAN dealer.

### SPEED LIMITER (if equipped)

The speed limiter allows you to set the desired vehicle speed limit. While the speed limiter is activated, the driver can perform normal braking and acceleration, but the vehicle will not exceed the set speed.



#### WARNING:

- **Always observe posted speed limits. Do not set the speed over them.**
- **Always confirm the setting status of the speed limiter on the vehicle information display.**

When the speed limiter is on, the cruise control system cannot be operated.

### SPEED LIMITER OPERATIONS

The speed limiter can be set at a speed between 30 to 200 km/h (20 to 124 MPH).

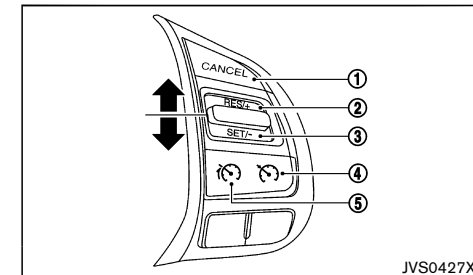

The speed limiter set switches are located on the steering wheel.

1. CANCEL switch
2. RES/+ switch
3. SET/- switch
4. Cruise control MAIN switch (For details, see "Cruise control" (P.5-43).)

### Starting and driving 5-41

#### 5. Speed limiter MAIN switch

(When this switch is pushed, the speed limiter enters the standby mode. If the cruise control system is on, the system will turn off and the speed limiter enters the standby mode.)

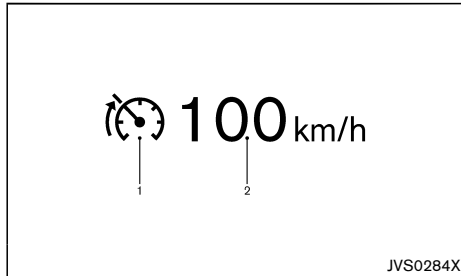

The speed limiter operating condition is shown on the vehicle information display.

1. Speed limiter indicator
2. Set speed indicator

The speed unit can be converted between "km/h" and "MPH". (See "Vehicle information display" (P.2-20).)

When the vehicle speed exceeds the set speed limit, the set speed indicator blinks and the accelerator pedal operation will not work until the vehicle speed slows down to the set speed limit.

**The speed limiter will not automatically reduce the vehicle speed to the set speed limit.**

#### Turning on speed limiter

Push the speed limiter MAIN switch. The speed limiter and the set speed indicators illuminate on the vehicle information display.

#### Setting speed limit

1. Push the SET/- switch.
  - When the vehicle is stopped, the speed will be set at 30 km/h or 20 MPH.
  - While driving, the speed limit will be set at the current speed.
2. When the speed limit is set, the SET and the set speed indicators illuminate on the vehicle information display.

#### Changing set speed limit:

Use either of the following operations to change the speed limit.

- Push and hold the RES/+ or SET/- switch. The set speed will increase or decrease by approximately 5 km/h or 5 MPH.
- Push, then quickly release the RES/+ or SET/- switch. Each time you do this, the set speed will increase or decrease by approximately 1 km/h or 1 MPH.

The new set speed limit value will be displayed in the vehicle information display.

When the actual vehicle speed exceeds the set speed, an audible warning will be heard a short time after the set speed is exceeded if driver intervention is not detected.

#### Canceling speed limit

To cancel the speed limiter, push the CANCEL switch. The speed limiter indicator and the set speed indicator on the vehicle information display will turn off.

It is also possible to override the speed limiter by fully depressing the accelerator pedal beyond the resistance point.



#### WARNING:

- **The vehicle may accelerate when the speed limiter cancels.**
- **When additional floor mats are used, be sure that they are correctly secured and that they cannot interfere with the accelerator pedal. Mats not adapted to the vehicle may prevent proper operation of the speed limiter.**

Fully depress the accelerator pedal beyond the resistance point. The speed limiter will be suspended to allow driving above the set speed. The set speed indicator will flash. The speed limiter will automatically resume when the vehicle speed drops below the set speed limit.

#### Resuming a previous set speed

If a set speed limit has been cancelled, the set speed will be stored in the speed limiter memory.

This speed limit can be reactivated by pressing the RES/+ switch upwards .

If the current vehicle speed is higher than the previous set speed, the accelerator pedal will not work and the set speed indicator will flash until the vehicle speed drops below the set speed limit.

When the actual vehicle speed exceeds the set speed, an audible warning will be heard a short time after the

## CRUISE CONTROL (if equipped)

set speed is exceeded and driver intervention is not detected.

### Turning the speed limiter off

The speed limiter system will be turned off when one of the following operations is performed:

- Push the speed limiter MAIN switch. The speed limiter indicator and the set speed indicator on the vehicle information display will be turned off.
- Push the cruise control MAIN switch. The speed limiter information on the vehicle information display will be replaced with the cruise control information. For details see "Cruise control" (P.5-43).
- When the vehicle is stopped and the ignition is placed to the off position.

Turning off the speed limiter will erase the set speed limit memory.

### Speed limiter malfunction

If the speed limiter malfunctions, the speed limiter on the vehicle information display will flash.

Turn the speed limiter MAIN switch off and have the system checked by a NISSAN dealer.

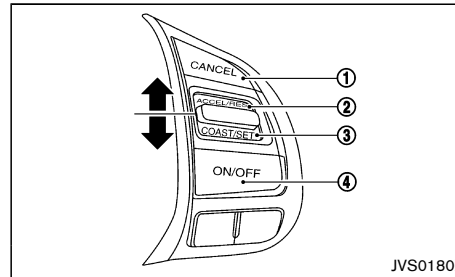

Models without speed limiter

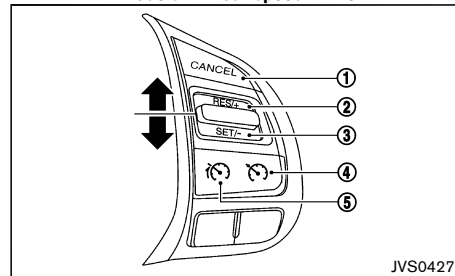

Models with speed limiter

1. CANCEL switch
2. ACCELERATE/RESUME switch
3. COAST/SET switch
4. Cruise control MAIN switch
5. Speed limiter MAIN switch

### WARNING:

- **Always observe the posted speed limits and do not set the speed over them.**
- **Do not use the cruise control when driving under the following conditions. Doing so could cause a loss of vehicle control and**

result in an accident.

- When it is not possible to keep the vehicle at a constant speed
- When driving in heavy traffic
- When driving in traffic that varies speed
- When driving in windy areas
- When driving on winding or hilly roads
- When driving on slippery (rain, snow, ice, etc.) roads



### CAUTION:

On manual Transmission (MT) model, do not shift to the "N" (Neutral) position without depressing the clutch pedal when the cruise control is operated. Should this occur, depress the clutch pedal and turn the cruise control MAIN switch off immediately. Failure to do so may cause engine damage.

### PRECAUTIONS ON CRUISE CONTROL

- If the cruise control system malfunctions, it will cancel automatically. The CRUISE indicator in the vehicle information display will then blink to warn the driver.
- If the CRUISE indicator blinks, turn the cruise control MAIN switch off and have the system checked by a NISSAN dealer.
- The CRUISE indicator may blink when the cruise control MAIN switch is turned ON while pushing the ACCELERATE/RESUME, COAST/SET or CANCEL switch. To properly set the cruise control system, perform the following procedures.

Starting and driving 5-43

## CRUISE CONTROL OPERATIONS

The cruise control allows driving at speeds above 40 km/h (25 MPH) without keeping your foot on the accelerator pedal.

For gasoline engine models, the cruise control will automatically be canceled if the vehicle slows down more than approximately 13 km/h (8 MPH) below the set speed.

For diesel engine models, the cruise control will automatically be canceled if the vehicle speed slows to less than approximately 35 km/h (22 MPH).

Moving the shift lever to the "N" (Neutral) position will cancel and the CRUISE indicator will off.

### Turning on cruise control

Push the MAIN switch. The CRUISE indicator in the vehicle information display will appear.

### Setting cruising speed

1. Accelerate to the desired speed.
2. Push the COAST/SET switch and release it.
3. Take your foot off the accelerator pedal.

The vehicle will maintain the set speed.

### Passing another vehicle:

Depress the accelerator pedal to accelerate. After releasing the accelerator pedal, the vehicle will return to the previously set speed.

The vehicle may not maintain the set speed when going up or down steep hills. In such cases, drive without the cruise control.

### Resetting to slower speed:

Use any one of the following methods to reset to a slower speed.

- Lightly tap the foot brake pedal. When the vehicle reaches the desired speed, push and release the COAST/SET switch.
- Push and hold the COAST/SET switch. When the vehicle reaches the desired speed, release the COAST/SET switch.
- Quickly push and release the COAST/SET switch. This will reduce the vehicle speed by about 1 km/h or 1 MPH.

### Resetting to faster speed:

Use any one of the following methods to reset to a faster speed.

- Depress the accelerator pedal. When the vehicle reaches the desired speed, push and release the COAST/SET switch.
- Push and hold the ACCELERATE/RESUME switch. When the vehicle reaches the desired speed, release the ACCELERATE/RESUME switch.
- Quickly push and release the ACCELERATE/RESUME switch. This will increase the vehicle speed by about 1 km/h or 1 MPH.

### Resuming at preset speed:

Push and release the ACCELERATE/RESUME switch.

The vehicle will resume the last set cruising speed when the vehicle speed is over 40 km/h (25 MPH).

### Cancelling cruising speed

Use any one of the following methods to cancel the set speed.

- Push the CANCEL switch.
- Tap the foot brake pedal.
- Push the cruise control MAIN switch. The CRUISE indicator will turn off.



## FORWARD EMERGENCY BRAKING SYSTEM (if equipped)

The forward emergency braking system can assist the driver when there is a risk of a forward collision with the vehicle ahead in the travelling lane.

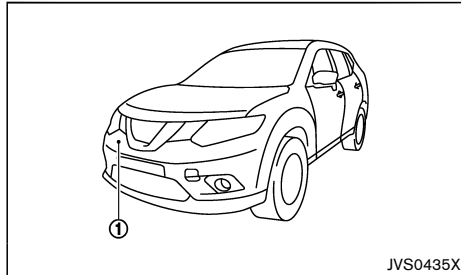

The forward emergency braking system uses a radar sensor ① located at the front of the vehicle to measure the distance to the vehicle ahead in the travelling lane.

The forward emergency braking system operates at speeds above approximately 5 km/h (3 MPH).



### WARNING:

- **The forward emergency braking system is a supplemental aid to the driver. It is not a replacement for the driver's attention to traffic conditions or responsibility to drive safely. It cannot prevent accidents due to carelessness or dangerous driving techniques.**
- **The forward emergency braking system does not function in all driving, traffic, weather and road conditions.**

## SYSTEM OPERATION

The forward emergency braking system will function when your vehicle is driven at speeds above approximately 5 km/h (3 MPH).

If a risk of a forward collision is detected, the forward emergency braking system will provide the first warning to the driver by flashing the forward emergency braking system warning light and providing an audible warning.

If the driver applies the brakes quickly and forcefully after the warning, and the forward emergency braking system detects that there is still the possibility of a forward collision, the system will automatically increase the braking force.

If the driver does not take action, the forward emergency braking system issues the second visual warning (red) and audible warning. If the driver releases the accelerator pedal, then the system applies partial braking.

If the risk of a collision becomes imminent, the forward emergency braking system applies harder braking automatically.

### NOTE:

**The vehicle's brake lights come on when braking is performed by the forward emergency braking system.**

Depending on vehicle speed and distance to the vehicle ahead, as well as driving and roadway conditions, the system may help the driver avoid a forward collision or may help mitigate the consequences if a collision should one be unavoidable.

If the driver is handling the steering wheel, accelerating or braking, the forward emergency braking system will function later or will not function.

The automatic braking will cease under the following

conditions:

- When the steering wheel is turned as far as necessary to avoid a collision.
- When the accelerator pedal is depressed.
- When there is no longer a vehicle detected ahead.

If the forward emergency braking system has stopped the vehicle, the vehicle will remain at a standstill for approximately 2 seconds before the brakes are released.





### WARNING:

- **The radar sensor does not detect the following objects:**
  - Pedestrians, animals or obstacles in the roadway
  - Oncoming vehicles
  - Crossing vehicles
- **The radar sensor has some performance limitations. If a stationary vehicle is in the vehicle's path, the forward emergency braking system will not function when the vehicle is driven at speeds over approximately 80 km/h (50 MPH).**
- **The radar sensor may not detect a vehicle ahead in the following conditions:**
  - Dirt, ice, snow or other material covering the radar sensor.
  - Interference by other radar sources.
  - Snow or road spray from travelling vehicles.
  - If the vehicle ahead is narrow (e.g. motorcycle).

- When driving on a steep downhill slope or roads with sharp curves.
- When towing a trailer.
- In some road or traffic conditions, the forward emergency braking system may unexpectedly push the accelerator pedal up or apply partial braking. When acceleration is necessary, continue to depress the accelerator pedal to override the system.
- Braking distances increase on slippery surfaces.
- Excessive noise will interfere with the warning chime sound, and the chime may not be heard.
- The system is designed to automatically check the sensor's functionality, within certain limitations. The system may not detect some forms of obstruction of the sensor area of the front bumper such as ice, snow, stickers, for example. In these cases, the system may not be able to warn the driver properly. Be sure that you check, clean and clear the sensor area of the front bumper regularly.

Turning the forward emergency braking system ON/OFF

Perform the following steps to turn the forward emergency braking system ON or OFF.

1. Using the  switches and the ENTER button on the left side of the steering wheel, select the Settings menu in the vehicle information display. (See "Settings" (P.2-21).)
2. Using the  switches and the ENTER button, navigate to the [Driver Assistance] menu, followed

## 5-46 Starting and driving

by the [Driving Aids] menu.

3. In the [Driving Aids] menu, highlight the [Emergency Brake] item and use the ENTER button to toggle between ON (enabled) or OFF (disabled).

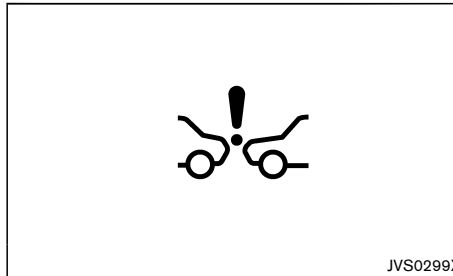

When the forward emergency braking system is turned off, the forward emergency braking system warning light (orange) will illuminate.

### System temporarily unavailable

#### Condition A:

When the radar sensor picks up interference from another radar source, making it impossible to detect a vehicle ahead, the forward emergency braking system is automatically turned off. The forward emergency braking system warning light (orange) and the driver assist system forward indicator (orange) will illuminate.

#### Action to take:

When the above conditions no longer exist, the forward emergency braking system will resume automatically.

#### Condition B:

When the sensor area of the front bumper is covered with dirt or obstructed, making it impossible to detect a vehicle ahead, the forward emergency braking system is automatically turned off. The forward emergency braking system warning light (orange) will illuminate and the "front radar obstruction" warning message will appear in the vehicle information display.

#### Action to take:

If the warning light (orange) comes on, park the vehicle in a safe location and turn the engine off. Check to see if the sensor area of the front bumper is blocked. If the sensor area of the front bumper is blocked, remove the blocking material. Restart the engine. If the warning light continues to illuminate, have the forward emergency braking system checked by a NISSAN dealer.

### System malfunction

If the forward emergency braking system malfunctions, it will be turned off automatically, a chime will sound, the forward emergency braking system warning light (orange) will illuminate and the warning message [Malfunction] will appear in the vehicle information display.

#### Action to take:

If the warning light (orange) comes on, park the vehicle in a safe location, turn the engine off and restart the engine. If the warning light continues to illuminate, have the forward emergency braking system checked by a NISSAN dealer.

## ECO MODE SYSTEM (if equipped)

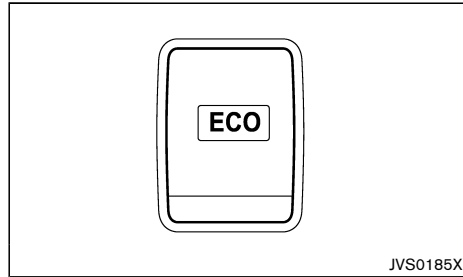

The ECO mode system helps to enhance the fuel economy by controlling the engine and CVT operation automatically to avoid rapid acceleration.

To turn on the ECO mode system, push the ECO switch. The ECO mode indicator appears on the meter.

To turn off the ECO mode, push the ECO switch again. The ECO mode indicator will turn off.

- The ECO mode system cannot be turned off while the accelerator pedal is depressed even if the ECO switch is pushed to OFF. Release the accelerator pedal to turn off the ECO mode system.
- The ECO mode system will turn off automatically if a malfunction occurs in the system.
- Turn off the ECO mode system when acceleration is required such as when:
  - driving with a heavy load of passengers or cargo in the vehicle
  - driving on a steep uphill slope

## ECO PEDAL GUIDE FUNCTION

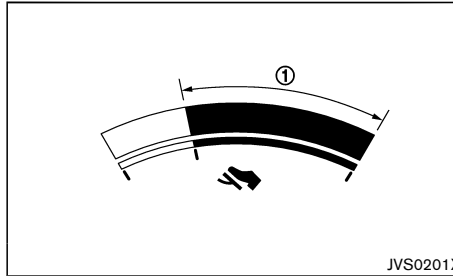

Use the ECO Pedal Guide function for improving fuel economy.

When the ECO Pedal Guide bar is in the green range ①, it indicates that the vehicle is driven within range of economy drive.

If the ECO Pedal Guide bar is out of the green range, it indicates that the accelerator pedal is depressed over the range of economy drive.

The ECO Pedal Guide bar is not displayed when:

- The cruise control system (if equipped) is operating.
- The vehicle speed is less than approximately 4 km/h (2 MPH).
- The shift lever is in the "P" (Park), "N" (Neutral) or "R" (Reverse) position.

To activate or deactivate the ECO Pedal Guide function, see "Settings" (P.2-21).

## AMBIENT ECO

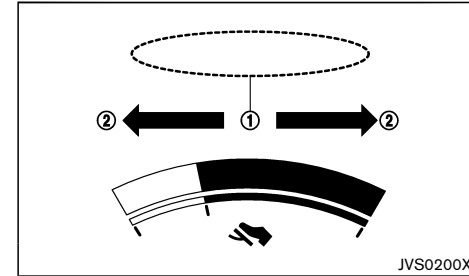

The ambient ECO ① is displayed according to the accelerator pedal operation, while driving the vehicle in ECO mode.

The ambient ECO will illuminate in the directions of ② as the driving pattern becomes more ECO friendly.

To activate or deactivate the ambient ECO, see "Settings" (P.2-21).

The ambient ECO is not displayed in the following conditions

- The vehicle speed is under 10 km/h (6 MPH).
- The shift lever is in the "P" (Park), "N" (Neutral) or "R" (Reverse) position.
- The cruise control system (if equipped) is operating.

## ECO DRIVE REPORT

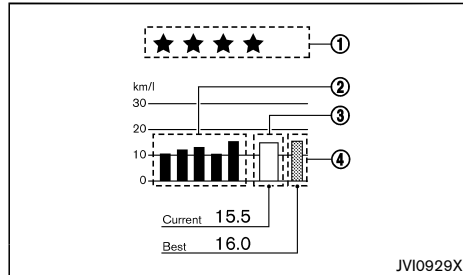

When the ignition switch is in the OFF position, ECO management display appears.

- ① ECO evaluation
- ② Previous 5 times (History)
- ③ Current fuel economy
- ④ Best fuel economy

The result of ECO evaluation is displayed when the vehicle is driven for about 10 minutes or more.

- ① : The more economically you drive, the more ★ appear.
- ② : The average fuel economy for the previous 5 times will be displayed.
- ③ : The average fuel economy since the last reset will be displayed.
- ④ : The best fuel economy of the past history will be displayed.

## 5-48 Starting and driving

## PARKING

### ⚠ WARNING:

- Do not stop or park the vehicle over flammable materials such as dry grass, waste paper or rags. They may ignite and cause a fire.
- Safe parking procedures require that both the parking brake be applied and the shift lever placed in the “P” (Park) position (Continuously Variable Transmission model) or the shift lever placed in an appropriate gear (Manual Transmission model). Failure to do so could cause the vehicle to move unexpectedly or roll away and result in an accident.
- When parking the vehicle, make sure the shift lever is moved to the “P” (Park) position. The shift lever cannot be moved out of the “P” (Park) position without depressing the foot brake pedal (Continuously Variable Transmission model).
- Never leave the engine running while the vehicle is unattended.
- When parking for an extended period of time with Stop/Start System or Idling Stop System (if equipped) activated, the engine will restart automatically. Never leave the vehicle with the ignition switch in the “ON” position.
- Never leave children or adults who would normally require the support of others alone in the vehicle. Pets should not be left alone either. They could unknowingly activate switches or controls and inadvertently become involved in a serious accident and injure themselves. On hot, sunny days,

temperatures in a closed vehicle could quickly become high enough to cause severe or possibly fatal illness to people and animals.

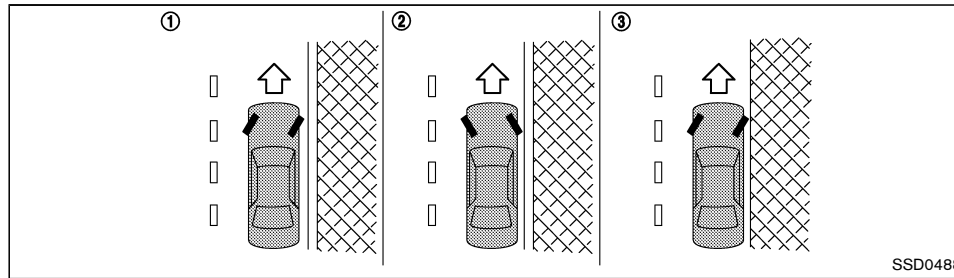

Left-Hand Drive (LHD) model

SSD0488

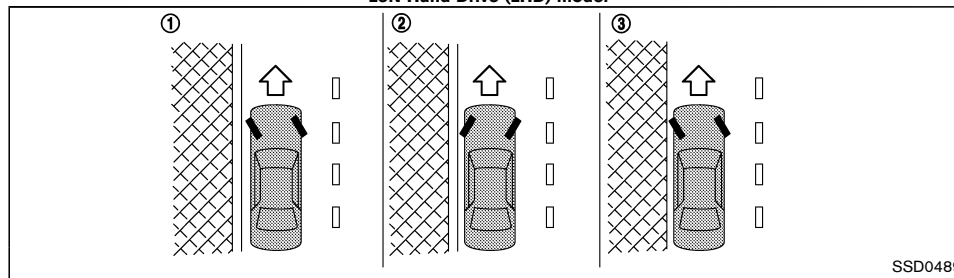

Right-Hand Drive (RHD) model

SSD0489

1. Firmly apply the parking brake.
2. Continuously Variable Transmission (CVT) model: Move the shift lever to the "P" (Park) position.  
Manual Transmission (MT) model: Move the shift lever to the "R" (Reverse) position. When parking on an uphill grade, move the shift lever to the "1" (1st) position.
3. To help prevent the vehicle from moving into traffic when parked on an incline, it is a good practice to turn the wheels as illustrated.  
**HEADED DOWNHILL WITH CURB ①**  
Turn the wheels towards the curb and move the

vehicle forward until the curb side wheel gently touches the curb. Then apply the parking brake.

**HEADED UPHILL WITH CURB ②**

Turn the wheels away from the curb and allow the vehicle to move back until the curb side wheel gently touches the curb. Then apply the parking brake.

**HEADED UPHILL OR DOWNHILL, WITHOUT CURB ③**

Turn the wheels toward the side of the road so the vehicle will move away from the center of the road if the vehicle moves. Then apply the parking brake.

**4. Model with Intelligent Key:**

Place the ignition switch in the "OFF" position.

**Model without Intelligent Key:**

Place the ignition switch in the "LOCK" position and remove the key.

**NOTE:****For Model with Stop/Start System or Idling Stop System:**

**Use this system when the vehicle is stopped for a period of time, for example waiting at stoplights.**

**Stop the engine with the ignition switch when parking, etc. for an extended period of time.**

## PARKING SENSOR (sonar) SYSTEM (if equipped)

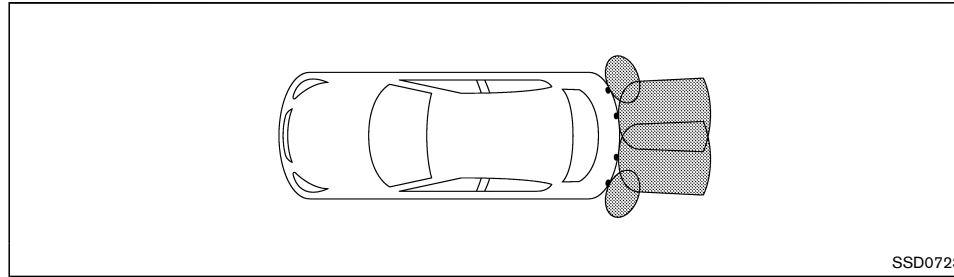

Type A

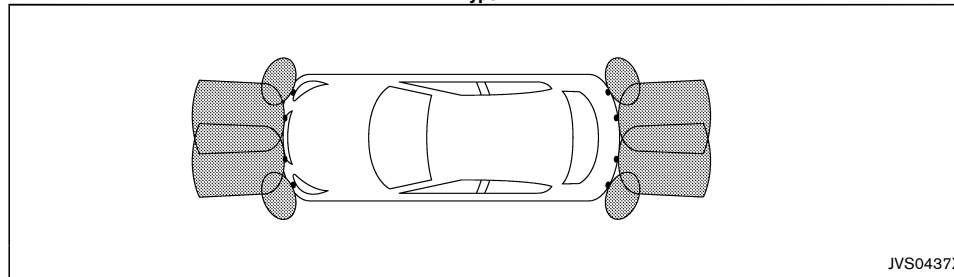

Type B

The parking sensor (sonar) system sounds a tone to inform the driver of obstacles near the bumper.

When the "Display" key is ON, the sensor view will automatically appear in the vehicle information display.



### WARNING:

- The parking sensor (sonar) system is a convenience but it is not a substitute for proper parking. The driver is always responsible for safety during parking and other manoeuvres. Always look around and check that it is safe to do so before parking.

### 5-50 Starting and driving

- Read and understand the limitations of the parking sensor (sonar) system as contained in this section. The colors of the corner sensor indicator and the distance guide lines in the front (if equipped)/rear view indicate different distances to the object. Inclement weather or ultrasonic sources such as an automatic car wash, a truck's compressed-air brakes or a pneumatic drill may affect the function of the system; this may include reduced performance or a false activation.

- This function is designed as an aid to the driver in detecting large stationary objects to help avoid damaging the vehicle. The system is not designed to prevent contact with small or moving objects. Always move slowly.
- The system will not detect small objects below the bumper, and may not detect objects close to the bumper or on the ground.
- The system may not detect the following objects.
  - Fluffy objects such as snow, cloth, cotton, glass-wool, etc.
  - Thin objects such as rope, wire and chain, etc.
  - Wedge-shaped objects
- If your vehicle sustains damage to the bumper fascia, leaving it misaligned or bent, the sensing zone may be altered causing inaccurate measurement of obstacles or false alarms.



### CAUTION:

- Keep the interior of the vehicle as quiet as possible to hear the tone clearly.
- Keep the sensors (located on the bumper fascia) free from snow, ice and large accumulations of dirt. Do not clean the sensors with sharp objects. If the sensors are covered, the accuracy of the sensor function will be diminished.

### For the vehicle equipped with rear sensor (Type A):

The system inform with visual and audible signal of rear obstacles when the shift lever is in the "R" (Reverse) position.

The system is deactivated at speeds above 10 km/h (6 MPH). It is reactivated at lower speeds.

The intermittent tone will stop after 3 seconds when an obstacle is detected by only the corner sensor and the distance does not change. The tone will stop when the obstacle get away from the vehicle.

### For the vehicle equipped with front and rear sensor (Type B):

The system inform with visual and audible signal of front obstacles when the shift lever is in the "D" (Drive) position and both front and rear obstacles when the shift lever is in the "R" (Reverse) position.

The system is deactivated at speeds above 10 km/h (6 MPH). It is reactivated at lower speeds.

The intermittent tone will stop after 3 seconds when an obstacle is detected by only the corner sensor and the distance does not change. The tone will stop when the obstacle get away from the vehicle.

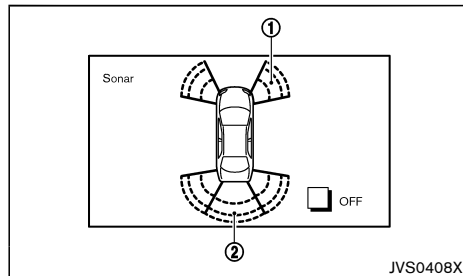

When the corner of the vehicle moves closer to an object, the corner sensor indicators ① appears (if equipped).

When the center of the vehicle moves close to an object, the center sonar indicator ② appears.

When the object is detected, the indicator (green) appears and blinks and the tone sounds intermittently. When the vehicle moves closer to the object, the color of the indicator turns yellow and the rate of the blinking increase. When the vehicle is very close to the object, the indicator stops blinking and turns red, and the tone sounds continuously.

### PARKING SENSOR (sonar) SYSTEM OFF SWITCH (if equipped)

#### Type A:

The ENTER button on the steering-wheel-mounted controls allows the driver to turn the parking sensor (sonar) system off.

The parking sensor (sonar) system will turn on automatically under the following conditions.

- When the ignition switch is placed from the "OFF" position to the "ON" position.
- When the shift lever is in the "R" (Reverse) position.
- When the vehicle speed decrease to 10 km/h (6 MPH).

The automatic turning on function can be turned on and off by "Sensor" key in the setting menu. See "Driver Assistance" (P.2-21).

#### Type B:

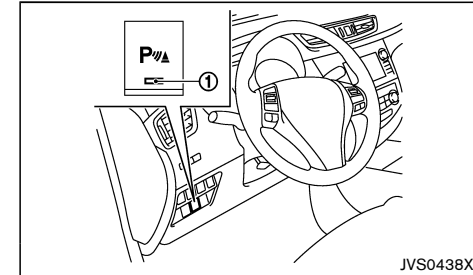

The sonar (parking sensor) system OFF switch on the instrument panel allows the driver to turn the sonar (parking sensor) system on and off. To turn the sonar (parking sensor) system on and off, the ignition switch must be in the "ON" position.

The indicator light ① on the switch will illuminate when the system is turned on.

If the indicator light flashes when the sonar (parking sensor) system is not turned off, it may indicate a malfunction in the sonar (parking sensor) system.

The sonar (parking sensor) system will be turned on automatically under the following conditions:

- When the ignition switch is switched from the "OFF" position to the "ON" position.
- When the shift lever is shifted into the "R" (Reverse) position.
- When the vehicle speed increases to 10 km/h (6 MPH) and decreases.

The automatic activation function can be turned on and off by pushing the switch for more than 4 seconds.

## PARKING SENSOR (sonar) SYSTEM SETTING

### Moving Object

Activate or deactivate the use of sensor.

ON (default) - OFF

### Front Sensor (if equipped)

Activate or deactivate the use of sensor.

ON (default) - OFF

### Rear Sensor

Activate or deactivate the use of sensor.

ON (default) - OFF

### Display (if equipped)

Automatically shows the sensor view on the vehicle information display when the sensor is activated.

ON (default) - OFF

### Volume

Adjust the volume of the tone.

High - Mid (default) - Low

### Range

Adjust the detection range of the sensor.

Far - Mid (default) - Near

## TRAILER TOWING (except for Australia, New Zealand, South Africa and Europe)

Your vehicle was designed to be used to carry passengers and luggage. NISSAN does not recommend trailer towing, because it places additional loads on your vehicle's engine, drivetrain, steering, braking, and other systems.



### CAUTION:

**Vehicle damage resulting from towing a trailer is not covered by the warranties.**

## TRAILER TOWING (for Australia, New Zealand, South Africa and Europe)

Your new vehicle was designed to be used primarily to carry passengers and luggage.

Towing a trailer will place additional loads on your vehicle's engine, drive train, steering, braking and other systems. The towing of a trailer will exaggerate other conditions such as sway caused by crosswinds, rough road surfaces or passing trucks.

Your driving style and speed must be adjusted according to the circumstances. Before towing a trailer, see a NISSAN dealer for an explanation about the proper use of towing equipment.

## OPERATING PRECAUTIONS

- Avoid towing a trailer during the break-in period.
- Before driving, make sure that the lighting system of the trailer works properly.
- Observe the legal maximum speeds for trailer operation.
- Avoid abrupt starts, accelerations and stops.
- Avoid sharp turns and lane changes.
- Always drive your vehicle at a moderate speed.
- Select the AUTO mode if your vehicle is equipped with the Four-Wheel Drive (4WD) system.
- Follow the trailer manufacturer's instructions.
- Choose proper coupling devices (trailer hitch, safety chain, roof carrier, etc.) for your vehicle and trailer. These devices are available from a NISSAN dealer where you can also obtain more detailed information about trailer towing.
- Never allow the total trailer load (trailer weight plus its cargo weight) to exceed the maximum set for the vehicle and the coupling device. See a NISSAN dealer for more information.
- The trailer must be loaded so that heavy goods are placed over the axle. The maximum allowable vertical load on the trailer hitch must not be



exceeded.

- Have your vehicle serviced more often than at the intervals specified in a separate maintenance booklet.
- Trailer towing requires more fuel than under normal circumstances because of a considerable increase in traction power and resistance.

**While towing a trailer, check the engine coolant temperature indicator to prevent the vehicle from overheating.**

#### MAXIMUM LOAD LIMITS (for Australia and New Zealand)

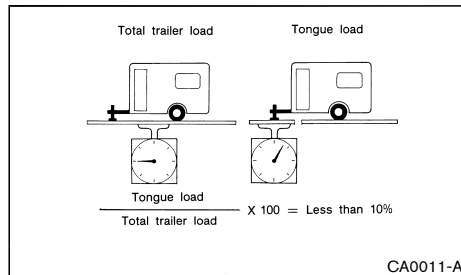

Maximum trailer loads (including tires and other loaded equipment):

1. Never allow the total trailer load to exceed:
  - The maximum 750 kg (1,654 lb) for a trailer without brakes.
  - The maximum 1,500 kg (3,308 lb) for a trailer with brakes (except for R9M engine models with MT).
  - The maximum 2,000 kg (4,410 lb) for a trailer with brakes (for R9M engine models with MT).

2. The total trailer load must be lower than the following three values even if it does not exceed the maximum permissible trailer loads.

- Towing capacity displayed on a tow-bar.
- Trailer's gross vehicle mass marked on a coupling body.
- Gross vehicle mass marked on a trailer data plate.

The maximum trailer load which can be towed by your vehicle depends on the towing equipment fitted to the vehicle. Therefore, it is important to not only have the correct equipment fitted but also to use it correctly. Towing loads greater than the value specified for your vehicle or using towing equipment which is not provided by NISSAN could seriously affect the handling and/or performance of your vehicle.

Vehicle damage resulting from improper towing procedures is not covered by NISSAN warranties. Information on trailer towing and the required equipment should be obtained from a NISSAN dealer.

#### Maximum tongue load

Never allow the tongue load to exceed 10% of the total trailer load. If the tongue load exceeds 10%, rearrange the cargo in the trailer.

#### Maximum rear gross axle weight

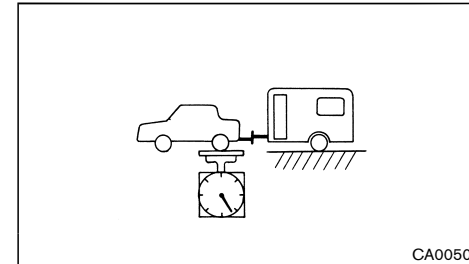

The rear gross axle weight must not exceed the Gross Axle Weight Rating (GAWR).

GAWR	2WD						4WD			
	MR20 + 6MT		QR25 + MCVT		R9M + MCVT		QR25 + MCVT		R9M + 6MT	
Second row [AP- PROX. kg ( lb )]	Front	Rear	Front	Rear	Front	Rear	Front	Rear	Front	Rear
		990 kg (2183 lb)	1020 kg (2249 lb)	1040 kg (2293 lb)	1030 kg (2271 lb)	1140 kg (2514 lb)	1080 kg (2381 lb)	1060 kg (2337 lb)	1100 kg (2426 lb)	1115 kg (2459 lb)
Third row [AP- PROX. kg ( lb )]	Front	Rear	Front	Rear	Front	Rear	Front	Rear	Front	Rear
	-	-	1040 kg (2293 lb)	1270 kg (2800 lb)	-	-	-	-	-	-

The trailer must be loaded so that heavy goods are placed over the axle.

## 5-54 Starting and driving

## TIRE PRESSURE

When towing a trailer, inflate the vehicle tires to the maximum recommended COLD tire pressure (for full loading) indicated on the tire placard.

Do not tow a trailer when the vehicle is installed with a temporary spare tire or a compact spare tire.

## SAFETY CHAINS

Always use a suitable chain between the vehicle and trailer. The chain should be crossed and should be attached to the hitch, not to the vehicle bumper or axle. Be sure to leave enough slack in the chain to permit turning corners.

## TRAILER BRAKES

Ensure that trailer brakes are installed as required by local regulations. Also check that all other trailer equipment conforms to local regulations.

Always block the wheels on both the vehicle and trailer when parking. Apply the hand brake on the trailer if equipped. Parking on a steep slope is not recommended.

If parking on a steep slope is unavoidable, place the shift lever in the "P" (Park) position (Continuously Variable Transmission model) or the shift lever in an appropriate gear (Manual Transmission model), and turn the front wheels towards the curb.

## TRAILER DETECTION (if equipped)

When towing a trailer with a genuine NISSAN tow bar electrical kit and the turn signal switch is used, the electrical system of the vehicle will detect the additional electrical load of the trailer lighting. As a result, the direction indicator tone will be different.

## COUPLING DEVICE INSTALLATION (for Europe)

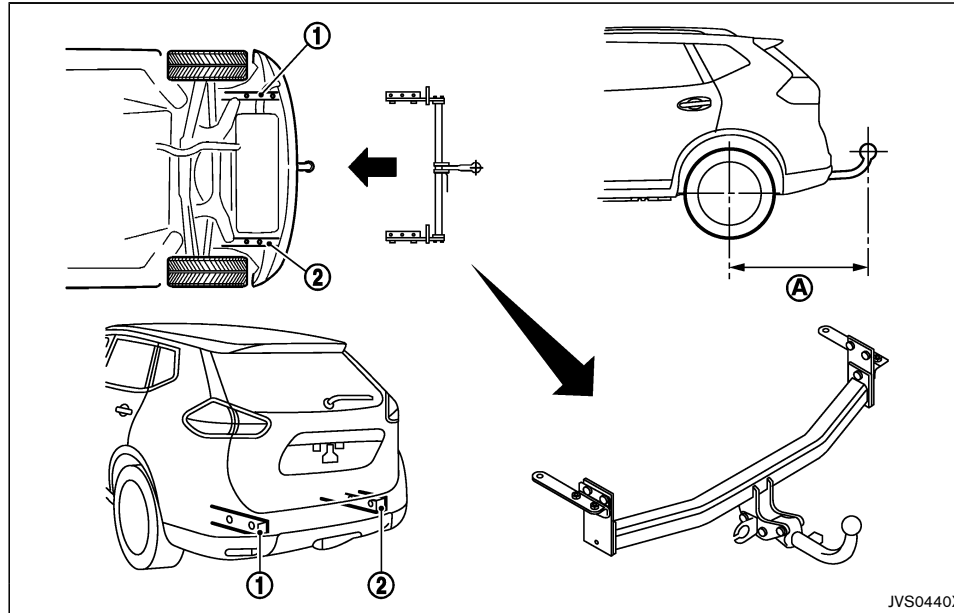

NISSAN recommends that the coupling device for trailer towing be installed under the following conditions:

- Maximum permissible vertical load on the coupling device: 981 N (100 kg, 221 lb)
- The coupling device, mounting points and installation parts on your vehicle: as shown as an example in the illustration.

- Rear overhang of coupling device: (A) 1,080 mm (42.5 in)

Follow all of the coupling device manufacturer's instructions for installation and use.

## ELECTRIC POWER STEERING SYSTEM

**WARNING:**

- If the engine is not running or is turned off while driving, the power assist for the steering will not work. Steering will be harder to operate.
- When the electric power steering warning light illuminates with the engine running, the power assist for the steering will cease operation. You will still have control of the vehicle, but the steering will be much harder to operate.

The electric power steering system is designed to provide power assist while driving to operate the steering wheel with light force.

When the steering wheel is operated repeatedly or continuously while parking or driving at a very low speed, the power assist for the steering wheel will be reduced. This is to prevent overheating of the electric power steering system and protect it from getting damaged. While the power assist is reduced, steering wheel operation will become heavy. When the temperature of the electric power steering system goes down, the power assist level will return to normal. Avoid repeating such steering wheel operations that could cause the electric power steering system to overheat.

You may hear a fricative sound when the steering wheel is operated quickly. However, this is not a malfunction.

If the electric power steering warning light  illuminates while the engine is running, it may indicate the electric power steering system is not functioning properly and may need servicing. Have the electric power steering system checked by a NISSAN dealer. (See "Electric power steering warning light" (P.2-14).)

## 5-56 Starting and driving

## BRAKE SYSTEM

When the electric power steering warning light illuminates with the engine running, the power assist for the steering will cease operation. You will still have control of the vehicle. However, greater steering effort is needed, especially in sharp turns and at low speeds.

The brake system has two separate hydraulic circuits. If one circuit malfunctions, you will still have braking ability at two wheels.

### BRAKE PRECAUTIONS

#### Vacuum assisted brakes

The brake booster aids braking by using engine vacuum. If the engine stops, you can stop the vehicle by depressing the foot brake pedal. However, greater foot pressure on the foot brake pedal will be required to stop the vehicle. The stopping distance will be longer.

If the engine is not running or is turned off while driving, the power assisted brakes will not function. Braking will be harder.



#### **WARNING:**

**Do not coast with the engine stopped.**

#### Using brakes

Avoid resting your foot on the foot brake pedal while driving. This will overheat the brakes, wear out the brake linings/pads faster, and increase fuel consumption.

To help reduce brake wear and to prevent the brakes from overheating, reduce speed and downshift to a lower gear before going down a slope or long grade. Overheated brakes may reduce braking performance and could result in loss of vehicle control.

While driving on a slippery surface, be careful when braking, accelerating or downshifting. Abrupt braking or acceleration could cause the wheels to skid and result in an accident.

#### Wet brakes

When the vehicle is washed or driven through water, the brakes may get wet. As a result, your braking distance will be longer and the vehicle may pull to one side during braking.

To dry the brakes, drive the vehicle at a safe speed while lightly depressing the brake pedal to heat up the brakes. Do this until the brakes return to normal. Avoid driving the vehicle at high speeds until the brakes function correctly.

#### Parking brake break-in

Break in the parking brake shoes whenever the stopping effect of the parking brake is weakened or whenever the parking brake shoes and/or drums/rotors are replaced, in order to assure the best braking performance.

This procedure is described in the vehicle service manual and can be performed by a NISSAN dealer.

#### Driving uphill

When starting on a steep grade, it is sometimes difficult to operate both the brake and clutch (for MT model). Apply the parking brake to hold the vehicle. Do not slip the clutch. When ready to start, slowly release the parking brake while depressing the accelerator pedal and releasing the clutch pedal.

#### Driving downhill

The engine braking action is effective for controlling the vehicle while descending hills. For Manual Transmission (MT) model, the shift lever should be placed in the lower speed position prior to descending. For Continuously Variable Transmission (CVT) model, the manual shift mode or the "L" position should be selected.

**Starting and driving 5-57**

## BRAKE ASSIST

When the force applied to the brake pedal exceeds a certain level, the Brake Assist is activated generating greater braking force than a conventional brake booster even with light pedal force.



### WARNING:

**The Brake Assist is only an aid to assist braking operation and is not a collision warning or avoidance device. It is the driver's responsibility to stay alert, drive safely and be in control of the vehicle at all times.**

## ANTI-LOCK BRAKING SYSTEM (ABS)



### WARNING:

- **The Anti-lock Braking System (ABS) is a sophisticated device, but it cannot prevent accidents resulting from careless or dangerous driving techniques. It can help maintain vehicle control during braking on slippery surfaces. Remember that stopping distances on slippery surfaces will be longer than on normal surfaces even with ABS. Stopping distances may also be longer on rough, gravel or snow covered roads, or if you are using tire chains. Always maintain a safe distance from the vehicle in front of you. Ultimately, the driver is responsible for safety.**
- **Tire type and condition may also affect braking effectiveness.**
  - **When replacing tires, install the specified size of tires on all four wheels.**

- **When installing a spare tire, make sure that it is the proper size and type as specified on the tire placard. (See "Tire placard" (P.9-9).)**
- **For detailed information, see "Tires and wheels" (P.8-36).**

The Anti-lock Braking System (ABS) controls the brakes so the wheels do not lock during hard braking or when braking on slippery surfaces. The system detects the rotation speed at each wheel and varies the brake fluid pressure to prevent each wheel from locking and sliding. By preventing each wheel from locking, the system helps the driver maintain steering control and helps to minimize swerving and spinning on slippery surfaces.

### Using system

Depress the brake pedal and hold it down. Depress the brake pedal with firm steady pressure, but do not pump the brakes. The ABS will operate to prevent the wheels from locking up. Steer the vehicle to avoid obstacles.



### WARNING:

**Do not pump the brake pedal. Doing so may result in increased stopping distances.**

### Self-test feature

The ABS includes electronic sensors, electric pumps, hydraulic solenoids and a computer. The computer has a built-in diagnostic feature that tests the system each time you start the engine and move the vehicle at a low speed in forward or reverse. When the self-test occurs, you may hear a "clunk" noise and/or feel a pulsation in the brake pedal. This is normal and does not indicate a malfunction. If the computer senses a

malfunction, it switches the ABS off and illuminates the ABS warning light on the meter. The brake system then operates normally, but without anti-lock assistance.

If the ABS warning light illuminates during the self-test or while driving, have the vehicle checked by a NISSAN dealer.

### Normal operation

The ABS operates at speeds above 5 to 10 km/h (3 to 6 MPH). The speed varies according to road conditions.

When the ABS senses that one or more wheels are close to locking up, the actuator rapidly applies and releases hydraulic pressure. This action is similar to pumping the brakes very quickly. You may feel a pulsation in the brake pedal and hear a noise from under the hood or feel a vibration from the actuator when it is operating. This is normal and indicates that the ABS is operating properly. However, the pulsation may indicate that road conditions are hazardous and extra care is required while driving.

## VEHICLE SECURITY

When leaving your vehicle unoccupied:

- Always take the key with you - even when leaving the vehicle in your own garage.
- Close all windows completely and lock all doors.
- Always park your vehicle where it can be seen. Park in a well lit area during the night.
- If the security system is equipped, use it - even for a short period.
- Never leave children or pets in the vehicle unattended.
- Never leave valuables inside the vehicle. Always take valuables with you.
- Never leave the vehicle documents in the vehicle.
- Never leave articles on a roof rack. Remove them from the rack and keep and lock them inside the vehicle.
- Never leave the spare key in the vehicle.

## COLD WEATHER DRIVING



### WARNING:

- **Whatever the condition, drive with caution. Accelerate and decelerate with great care. If accelerating or decelerating too fast, the drive wheels will lose even more traction.**
- **Allow more stopping distance in cold weather driving. Braking should be started sooner than on dry pavement.**
- **Keep at a greater distance from the vehicle in front of you on slippery roads.**
- **Wet ice (0°C, 32°F and freezing rain), very cold snow and ice can be slick and very difficult to drive on. The vehicle will have a lot less traction or grip under these conditions. Try to avoid driving on wet ice until the road is salted or sanded.**
- **Watch for slippery spots (glaring ice). These may appear on an otherwise clear road in shaded areas. If a patch of ice is seen ahead, brake before reaching it. Try not to brake while actually on the ice, and avoid any sudden steering maneuvers.**
- **Do not use cruise control on slippery roads.**
- **Snow can trap dangerous exhaust gas under your vehicle. Keep snow clear of the exhaust pipe and from around your vehicle.**

## BATTERY

If the battery is not fully charged during extremely cold weather conditions, the battery fluid may freeze and damage the battery. To maintain maximum efficiency, the battery should be checked regularly. For details, see "Battery" (P.8-20) of this manual.

## ENGINE COOLANT

If the vehicle is to be left outside without anti-freeze, drain the cooling system, including the engine block. Refill before operating the vehicle. For details, see "Changing engine coolant" (P.8-9) of this manual.

## TIRE EQUIPMENT

1. If you have snow tires installed on the front/rear wheels of your vehicle, they should be of the same size, loading range, construction and type (bias, bias-belted or radial) as the rear/front tires.
2. If the vehicle is to be operated in severe winter conditions, snow tires should be installed on all four wheels.
3. For additional traction on icy roads, studded tires may be used. However, some countries, provinces and states prohibit their use. Check local, state and provincial laws before installing studded tires.  
**Skid and traction capabilities of studded snow tires, on wet or dry surfaces, may be poorer than that of non-studded snow tires.**
4. Snow chains may be used if desired. Make sure they are the proper size for the tires on your vehicle and are installed according to the chain manufacturer's instructions. Use chain tensioners when recommended by the tire chain manufacturer to ensure a tight fit. Loose end links of the tire chains must be secured or removed to prevent the possibility of whipping action damage to the

**Starting and driving 5-59**

fenders or underbody. In addition, drive at a reduced speed, otherwise, your vehicle may be damaged and/or vehicle handling and performance may be adversely affected.

### SPECIAL WINTER EQUIPMENT

It is recommended that the following items be carried in the vehicle during the winter:

- A scraper and stiff-bristled brush to remove ice and snow from the windows.
- A sturdy, flat board to be placed under the jack to give it firm support.
- A shovel to dig the vehicle out of snowdrifts.

### PARKING BRAKE

When parking in an area where the outside temperature is below 0 °C (32 °F), do not apply the parking brake to prevent it from freezing. For safe parking:

- Place the shift lever in the "P" (Park) position (CVT model).
- Place the shift lever in the "1" (1st) or "R" (Reverse) gear (MT model).
- Securely block the wheels.

For models equipped with electronic parking brake system

To keep the electronic parking brake released after the engine is turned off, see "Parking brake" (P.3-30).

### CORROSION PROTECTION

Chemicals used for road surface deicing are extremely corrosive and will accelerate corrosion and the deterioration of underbody components such as the exhaust system, fuel and brake lines, brake cables, floor pan and fenders.

**In the winter, the underbody must be cleaned periodically. For additional information, see "Corrosion protection" (P.7-5) of this manual.**

For additional protection against rust and corrosion, which may be required in some areas, consult a NISSAN dealer.



# 6 In case of emergency

Hazard indicator flasher switch .....	6-2	Installing spare tire .....	6-7
Flat tire .....	6-2	Stowing damaged tire and tools .....	6-7
Tire Pressure Monitoring System (TPMS) (if equipped) .....	6-2	Jump starting .....	6-8
Stopping vehicle .....	6-2	Push starting .....	6-10
Preparing tools and spare tire (if equipped) .....	6-3	If your vehicle overheats .....	6-10
Blocking wheels .....	6-5	Towing your vehicle .....	6-11
Removing wheel cover (if equipped) .....	6-6	Towing precautions .....	6-11
Removing tire .....	6-6	Towing recommended by NISSAN .....	6-11



## HAZARD INDICATOR FLASHER SWITCH

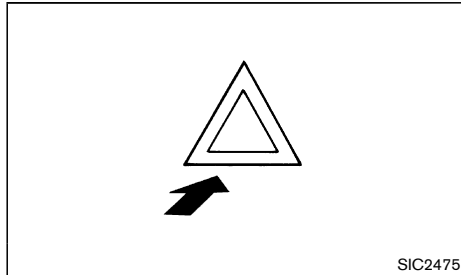

The hazard indicator flasher switch operates regardless of the ignition switch position except when the battery is discharged.

The hazard indicator flasher is used to warn other drivers when you have to stop or park under emergency conditions.

When the hazard indicator flasher switch is pushed, all turn signal lights will flash. To turn off the hazard indicator flasher, push the hazard indicator flasher switch again.

When an impact that could activate the supplemental air bags is detected, the hazard warning flasher lights blink automatically. If the hazard warning flasher switch is pushed, the hazard warning flashers will turn off.

### **WARNING:**

**Do not turn the hazard warning flasher switch to off until you can make sure that it is safe to do so. Also, the hazard flasher warning may not blink automatically depending on the force of impact.**

## 6-2 In case of emergency

## FLAT TIRE

If you have a flat tire, follow the instructions as follows.

### TIRE PRESSURE MONITORING SYSTEM (TPMS) (if equipped)

#### **WARNING:**

- **If the low tire pressure warning light illuminates while driving, avoid sudden steering maneuvers or abrupt braking, reduce vehicle speed, pull off the road to a safe location and stop the vehicle as soon as possible. Driving with under-inflated tires may permanently damage the tires and increase the likelihood of tire failure. Serious vehicle damage could occur and may lead to an accident and could result in serious personal injury. Check the tire pressure for all four tires. Adjust the tire pressure to the recommended COLD tire pressure shown on the tire placard to turn the low tire pressure warning light off. If the light still illuminates while driving after adjusting the tire pressure, a tire may be flat. If you have a flat tire, replace it with a spare tire (if equipped) as soon as possible.**
- **When a spare tire is mounted or a wheel is replaced, the TPMS will not function and the low tire pressure warning light will flash for approximately 1 minute. The light will remain on after the 1 minute. Contact a NISSAN dealer as soon as possible for tire replacement and/or system resetting.**
- **Replacing tires with those not originally specified by NISSAN could affect the proper operation of the TPMS.**

The Tire Pressure Monitoring System (TPMS) monitors tire pressure of all tires except the spare. When the low

tire pressure warning light is lit, one or more of your tires is significantly under-inflated. If the vehicle is being driven with low tire pressure, the TPMS will activate and warn you of it by the low tire pressure warning light (in the meter panel). This system will activate only when the vehicle is driven at speeds above 25 km/h (16 MPH).

For more details, see "Low tire pressure warning light" (P.2-14) and "Tire Pressure Monitoring System (TPMS)" (P.5-4).

### STOPPING VEHICLE

#### **WARNING:**

- **Be sure to apply the parking brake firmly.**
  - **Be sure to move the shift lever to the "P" (Park) position (Continuously Variable Transmission model) or the shift lever to the "R" (Reverse) position (Manual Transmission model).**
  - **Never change tires when the vehicle is on a slope, ice or slippery area. This is hazardous.**
  - **Never change tires when the oncoming traffic is close to your vehicle. Call for professional road assistance.**
1. Safely move the vehicle off the road away from traffic.
  2. Turn on the hazard indicator flasher lights.
  3. Park on a level surface.
  4. Apply the parking brake.
  5. Continuously Variable Transmission (CVT) model: Move the shift lever to the "P" (Park) position.  
Manual Transmission (MT) model: Move the shift lever to the "R" (Reverse) position.

6. Turn off the engine.
7. Open the hood and set up the triangle reflector (if equipped):
  - To warn other traffic.
  - To signal professional road assistance personnel that you need assistance.
8. Have all passengers get out from the vehicle and stand in a safe place, away from other traffic and clear of the vehicle.

### PREPARING TOOLS AND SPARE TIRE (if equipped)

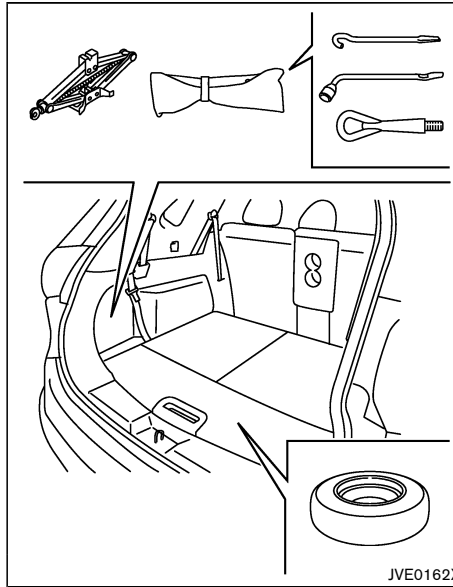

**Type A**

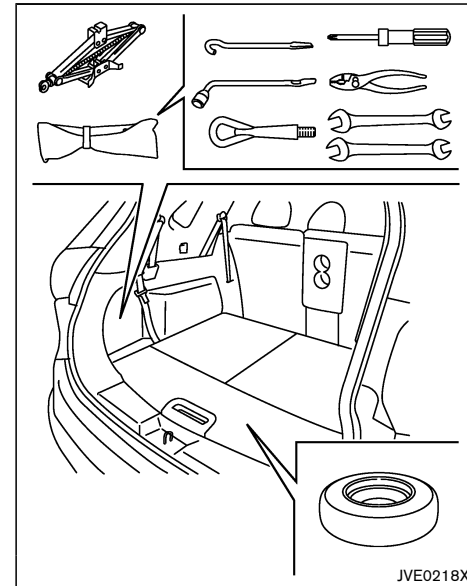

**Type B**

Remove the jack, necessary tools and the spare tire from the storage area.

**In case of emergency 6-3**

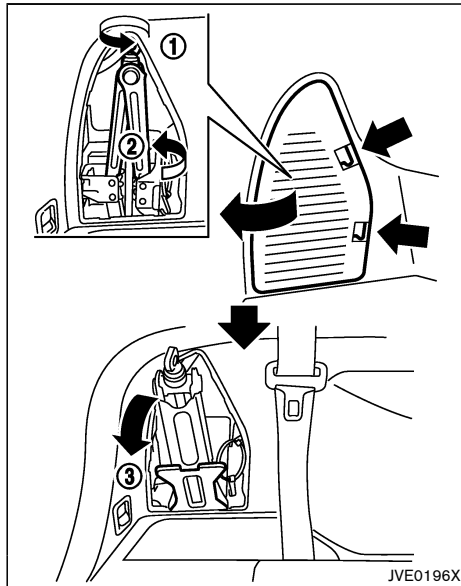

1. Remove the storage door by pressing the two release tabs simultaneously.
2. Unhook the clip restraining the jack and tool kit, and then remove the tool kit.
3. Loosen the jack by turning the jack lever ① as shown in the illustration.
4. Turn the bottom ② of the jack 90 degrees, tilt the top ③ of the jack towards you, and then remove the jack slowly. To store the jack, perform this in the reverse order and then tighten the jack lever so that it does not rattle.

**⚠ CAUTION:**

When removing the jack, be careful that your hands do not hit against the vehicle. Otherwise, this could result in personal injury.

**NOTE:**

- When storing the jack, do not overtighten the jack lever using a screw driver. Doing so could cause deformation of the installation area for the jack.
- Do not allow the jack to contact the interior parts. Doing so could cause damage to the vehicle.

Spare tire (Two row model)

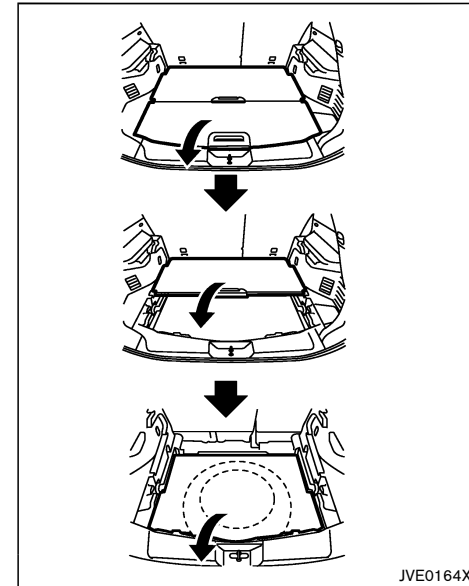

The spare tire is located under the luggage floorboards.

Remove the luggage floorboards.

**6-4 In case of emergency**

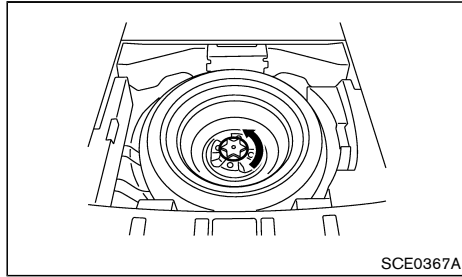

Remove the clamp holding the spare tire.

### Spare tire (Three row model)

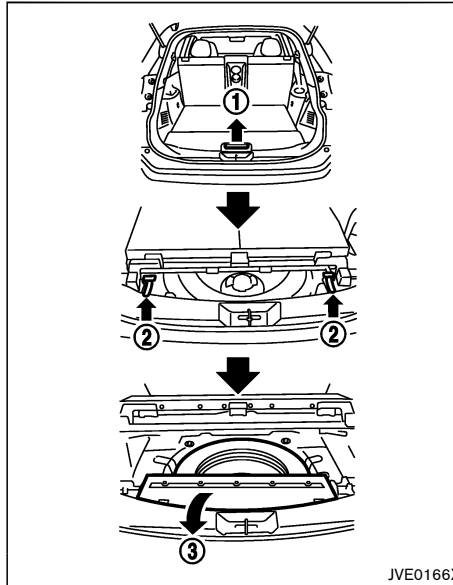

The spare tire is located under the luggage floorboards.

Fold the third row seats flat and then remove the luggage floorboard ① . For folding the third row seats, see "Third row seats" (P.1-6).

Pull the strap ② to raise the seat.

Remove the cover ③ .

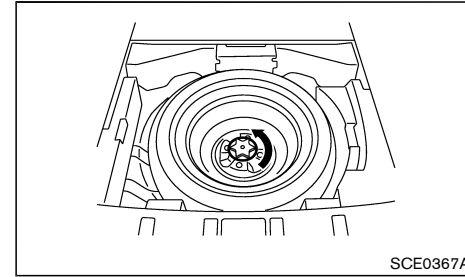

Remove the clamp holding the spare tire.

### BLOCKING WHEELS

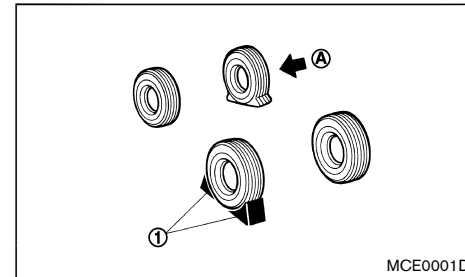

### WARNING:

**Be sure to block the appropriate wheel to prevent the vehicle from moving, which may cause personal injury.**

Place suitable blocks ① at both the front and back of the wheel diagonally opposite the flat tire ① to prevent the vehicle from moving when it is jacked up.

**In case of emergency 6-5**

### REMOVING WHEEL COVER (if equipped)

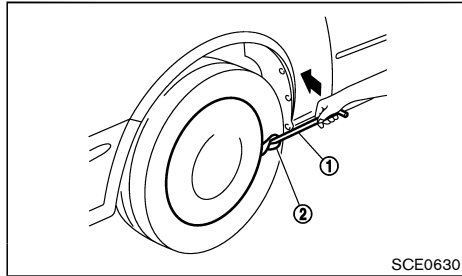

#### **WARNING:**

**Never use your hands to remove the wheel cover. This may cause personal injury.**

To remove the wheel cover, use the jack rod ① as illustrated.

Apply cloth ② between the wheel and jack rod to prevent damaging the wheel and wheel cover.

### REMOVING TIRE

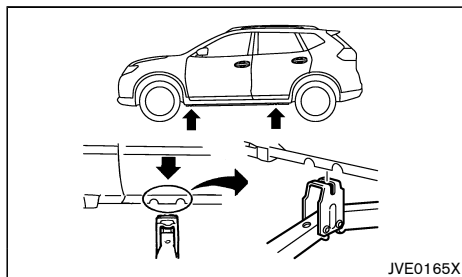

Jack-up points

### 6-6 In case of emergency

### Jacking up vehicle

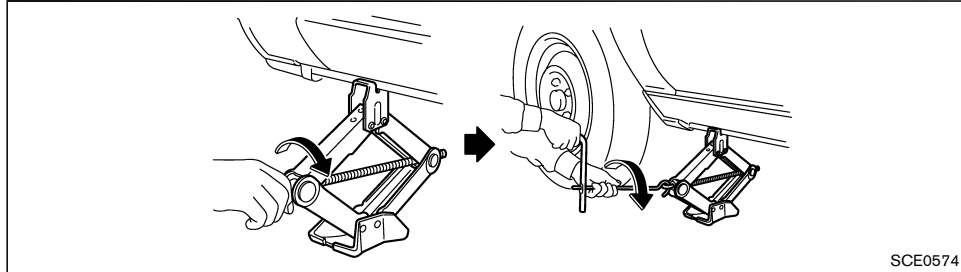

#### **WARNING:**

- **Be sure to read and follow the instructions in this section.**
- **DO NOT GET UNDER A VEHICLE THAT IS SUPPORTED BY A JACK.**
- **Never use a jack which is not provided with your vehicle.**
- **The jack, which is provided with your vehicle, is designed only to lift your vehicle during a tire change. Do not use the jack provided with your vehicle on other vehicles.**
- **Never jack up the vehicle at a location other than the jack-up point that is specified.**
- **Never lift the vehicle more than necessary.**
- **Never use blocks on or under the jack.**
- **Never start or run the engine while the vehicle is on the jack. The vehicle may move suddenly, and this may cause an accident.**
- **Never allow passengers to remain in the vehicle while the tire is off the ground.**

- **Be sure to read the caution label attached to the jack body before using.**

1. Place the jack directly under the jack-up point as illustrated so that the top of the jack contacts the vehicle at the jack-up point.

**The jack should be placed on firm level ground.**

2. Align the jack head between the two notches located at the jack-up point of either the front or the rear section.
3. Fit the groove of the jack head between the notches as shown.
4. Loosen each wheel nut, counterclockwise, one or two turns with the wheel nut wrench.

**Do not remove the wheel nuts until the tire is off the ground.**

5. Carefully raise the vehicle until the clearance between the tire and ground is achieved.
6. To lift the vehicle, securely hold the jack lever and rod with both hands and turn the jack lever.

## Removing tire

1. Remove the wheel nuts.
2. Remove the damaged tire.

### CAUTION:

**The tire is heavy. Be sure that your feet are clear from the tire and use gloves as necessary to avoid injury.**

## INSTALLING SPARE TIRE

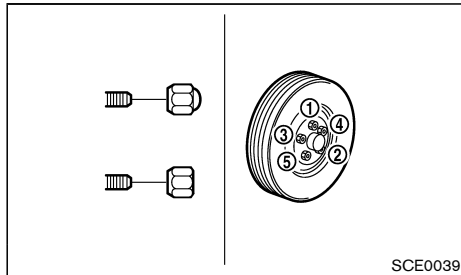

### WARNING:

- Never use wheel nuts which are not provided with your vehicle. Incorrect wheel nuts or improperly tightened wheel nuts may cause the wheel to become loose or come off. This could cause an accident.
- Never use oil or grease on the wheel studs or nuts. This may cause the wheel nuts to become loose.
- The T-type spare tire is designed for emergency use only.

1. Clean any mud or dirt from the surface between the wheel and hub.
2. Carefully put the spare tire on and tighten the wheel nuts with your fingers. Check that all the wheel nuts contact the wheel surface horizontally.
3. Tighten the wheel nuts alternately and evenly in the sequence illustrated (① - ⑤), more than 2 times with the wheel nut wrench, until they are tight.
4. Lower the vehicle slowly until the tire touches the ground.
5. Tighten the wheel nuts securely, with the wheel nut wrench, in the sequence illustrated.
6. Lower the vehicle completely.

**Tighten the wheel nuts to the specified torque with a torque wrench as soon as possible.**

**Wheel nut tightening torque:  
108 N·m (11 kg·m, 80 ft·lb)**

**The wheel nuts must be kept tightened to specification at all times. It is recommended that the wheel nuts be tightened to specification at each lubrication interval.**

### WARNING:

**Retighten the wheel nuts when the vehicle has been driven for 1,000 km (600 miles) (also in cases of a flat tire, etc.).**

## For models equipped with Tire Pressure Monitoring System (TPMS)

- After adjusting the tire pressure, the TPMS must be reset. See "Tire Pressure Monitoring System (TPMS)" (P.6-2), "Tire Pressure Monitoring System (TPMS)" (P.5-4) and "Tire Pressure Monitoring System (TPMS)" (P.8-36) for details about the resetting procedure.
- After adjusting tire pressure to the COLD tire pressure, the display of the tire pressures (if equipped in the vehicle information display) may show higher pressure than the COLD tire pressure after the vehicle has been driven more than 1.6 km (1 mile). This is because the tire pressurizes as the tire temperature rises. This does not indicate a system malfunction.

## STOWING DAMAGED TIRE AND TOOLS

### WARNING:

- Be sure that the tire, jack and tools used are properly stored after use. Such items can become dangerous projectiles in an accident or sudden stop.
  - The T-type spare tire is designed for emergency use only.
1. Securely store the damaged tire, jack and tools used in the storage area in the reverse order of removal. (See "Preparing tools and spare tire" (P.6-3).)
  2. Replace the luggage floorboards.
  3. Close the back door.

**In case of emergency 6-7**

## JUMP STARTING

### NOTE:

When stowing the jack and tools, bundle and fasten them using the band included with the tool bag, before storing them. Otherwise the tools may contact each other and produce noise.

### WARNING:

- Incorrect jump starting can lead to a battery explosion. The battery explosion may result in severe injury or death. It may also result in damage to the vehicle. Be sure to follow the instructions in this section.
- Explosive hydrogen gas is always present in the vicinity of the battery. Keep all sparks and flames away from the battery.
- Always wear suitable eye protection and remove rings, bracelets, and any other jewelry whenever working on or near a battery.
- Never lean over the battery while jump starting.
- Never allow battery fluid to come into contact with eyes, skin, clothes or the vehicle's painted surfaces. Battery fluid is a corrosive sulfuric acid which can cause severe burns. If the fluid comes into contact with anything, immediately flush the contacted area with plenty of water.
- Keep the battery out of the reach of children.
- The booster battery must be rated at 12 volts. Use of an incorrectly rated battery will damage your vehicle.
- Never attempt to jump start a frozen battery. It could explode and cause serious injury.

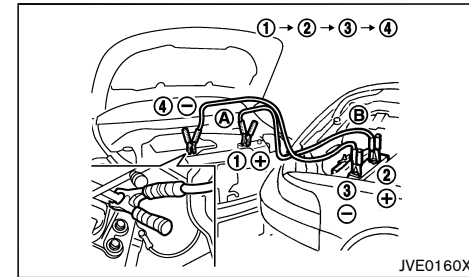

QR25 engine model

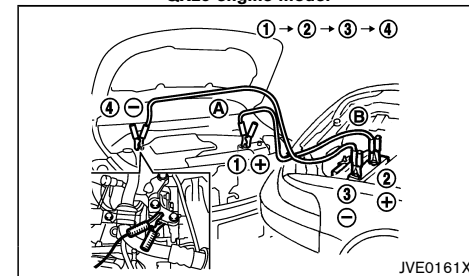

MR20 engine model

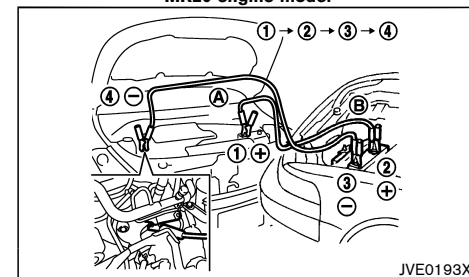

R9M engine model

### 6-8 In case of emergency



1. If the booster battery is in another vehicle (B), position the two vehicles (A) and (B) to bring the batteries into close proximity to each other.

**CAUTION:**

If the battery of vehicle (A) equipped with the Intelligent Key system is discharged, the ignition switch cannot be moved from the "LOCK" position and, if the steering lock is engaged, the steering wheel cannot be moved. Connect the jumper cables to the booster vehicle (B) before turning or pushing the ignition switch and disengaging the steering lock.

2. Apply the parking brake.
3. Continuously Variable Transmission (CVT) model:  
Move the shift lever to the "P" (Park) position.  
Manual Transmission (MT) model: Move the shift lever to the "N" (Neutral) position.
4. Switch off all unnecessary electrical systems (headlights, heater, air conditioner, etc.).
5. Place the ignition switch in the "LOCK" position.
6. Remove the vent caps, if equipped, on the battery.
7. Cover the battery with a firmly wrung out moist cloth to reduce the hazard of an explosion.
8. Connect the jumper cables in the sequence as illustrated (1, 2, 3, 4).

**CAUTION:**

- Always connect positive ⊕ to positive ⊕ and negative ⊖ to body ground, NOT to the battery's negative ⊖.
- Be sure that the jumper cables do not touch moving parts in the engine compartment.

- Be sure that the jumper cable's clamps do not contact any other metal.

9. Start the engine of the booster vehicle (B) and let it run for a few minutes.
10. Depress the accelerator pedal of the booster vehicle (B) at about 2,000 rpm.
11. Start the engine of the jumped vehicle (A) in the normal manner.

**CAUTION:**

Never keep the starter motor engaged for more than 10 seconds. If the engine does not start right away, place the ignition switch "OFF" and wait at least 10 seconds before trying again.

12. After the engine is started, carefully disconnect the jumper cables in the opposite sequence from that illustrated (4, 3, 2, 1).
13. Remove and dispose of the cloth as it may be contaminated with corrosive acid.
14. Replace the vent caps, if removed.

**NOTE:**

- For model with Stop/Start System or Idling Stop System, use the special battery that is enhanced in regard to the charge-discharge capacity and life performance. Avoid using a non-special battery for the Stop/Start System or Idling Stop System, as this may cause early deterioration of the battery or a malfunction of the Stop/Start System or Idling Stop System. For the battery, it is recommended to use Genuine NISSAN parts. For more information, contact a NISSAN dealer.

In case of emergency 6-9

## PUSH STARTING

Do not attempt to start the engine by pushing the vehicle.



### CAUTION:

- **Continuously Variable Transmission (CVT)/ Manual Transmission (MT) model cannot be started by pushing. Attempting to do so may cause damage to the transmission.**
- **Three-way catalyst equipped model should not be started by pushing. Attempting to do so may cause damage to the three-way catalyst.**
- **Never try to start the engine by towing. When the engine starts, the forward surge could cause the vehicle to collide with the towing vehicle.**
- **Stop/Start System or Idling Stop System equipped model cannot be started by pushing the vehicle.**

## IF YOUR VEHICLE OVERHEATS



### WARNING:

- **Never continue driving if your vehicle overheats. Doing so could cause a vehicle fire.**
- **Never open the hood if steam is coming out.**
- **Never remove the radiator or coolant reservoir cap while the engine is hot. If the radiator or coolant reservoir cap is removed when the engine is hot, pressurized hot water will spurt out and possibly cause burning, scalding or serious injury.**
- **If steam or coolant is coming from the engine, stand clear of the vehicle to prevent getting burned.**
- **The engine cooling fan can start at any time when the coolant temperature exceeds preset degrees.**
- **Be careful not to allow your hands, hair, jewelry or clothing to come into contact with, or to get caught in the cooling fan or drive belts.**

If your vehicle is overheating (indicated by the high temperature indicator), or if you feel a lack of engine power, detect unusual noise, etc., take the following steps:

1. Safely move the vehicle off the road away from traffic.
2. Turn on the hazard indicator flasher lights.
3. Apply the parking brake.
4. Continuously Variable Transmission (CVT) model: Move the shift lever to the "P" (Park) position.  
Manual Transmission (MT) model: Move the shift lever to the "N" (Neutral) position.

**DO NOT STOP THE ENGINE.**

5. Open all the windows.
6. Turn off the air conditioner. Move the temperature control to maximum hot and the fan control to high speed.
7. Get out from the vehicle.
8. Visually inspect and listen for steam or coolant escaping from the radiator before opening the hood. Wait until no steam or coolant can be seen before proceeding.
9. Open the engine hood.
10. Visually inspect if the cooling fan is running.
11. Visually inspect the radiator and radiator hoses for leakage.  
  
If the cooling fan is not running or the coolant is leaking, stop the engine.
12. After the engine cools down, check the coolant level in the reservoir with the engine running. **Do not open the radiator cap.**
13. Add coolant to the reservoir if necessary.

Have your vehicle inspected/repared at a NISSAN dealer.

6-10 In case of emergency

## TOWING YOUR VEHICLE

When towing your vehicle, local regulations for towing must be followed. Incorrect towing equipment could damage your vehicle. To assure proper towing and to prevent accidental damage to your vehicle, NISSAN recommends that you have professional road assistance personnel tow your vehicle. It is advisable to have the professional road assistant carefully read the following precautions.

### TOWING PRECAUTIONS

- Be sure that the transmission, steering system, and drivetrain are in working condition before towing. If any units are damaged, the vehicle must be towed using a dolly or flatbed tow truck. (Two-Wheel Drive (2WD) model)
- NISSAN recommends that your vehicle be towed with the driving (front) wheels off the ground. (Two-Wheel Drive (2WD) model)
- Always attach safety chains before towing.
- Never tow Four-Wheel Drive (4WD) model with any of the wheels on the ground as this may cause serious and expensive damage to the drivetrain.

### TOWING RECOMMENDED BY NISSAN

#### Towing Two-Wheel Drive (2WD) model

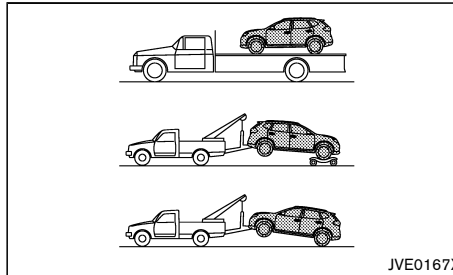

2WD model

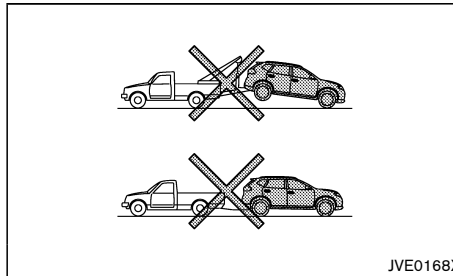

2WD model

#### Front wheels on the ground:

NISSAN recommends that towing dollies be used under the front wheels when towing your vehicle or the vehicle be placed on a flatbed tow truck as illustrated.



#### CAUTION:

**Never tow Continuously Variable Transmission (CVT) model with the front wheels on the ground. Doing so will cause serious and expensive damage to the drivetrain.**

#### ive damage to the drivetrain.

Manual Transmission (MT) model:

If you have to tow a MT vehicle with front wheel on the ground, perform the following procedures.

1. Place the ignition switch in the "OFF" position.
2. Secure the steering wheel in a straight-ahead position with rope or a similar device.
3. Move the shift lever to the "N" (Neutral) position.
4. Release the parking brake.
5. Attach the safety chains whenever towing.

#### Rear wheels on the ground:

1. Place the ignition switch in the "OFF" position.
2. Move the shift lever to the "N" (Neutral) position.
3. Release the parking brake.
4. Attach safety chains whenever towing.

#### All four wheels on the ground:

NISSAN recommends that the vehicle be placed on a flatbed tow truck as illustrated.



#### CAUTION:

**Never tow CVT model with all four wheels on the ground. Doing so will cause serious and expensive damage to the drivetrain.**

Manual Transmission (MT) model:

If you have to tow a MT vehicle with all four wheels on the ground, perform the following procedures.



#### CAUTION:

- **Never tow a manual transmission model backward with all four wheels on the ground.**

In case of emergency 6-11

1. Place the ignition switch in the "OFF" position.
2. Move the shift lever to the "N" (Neutral) position.
3. Release the parking brake.

#### Towing Four-Wheel Drive (4WD) model

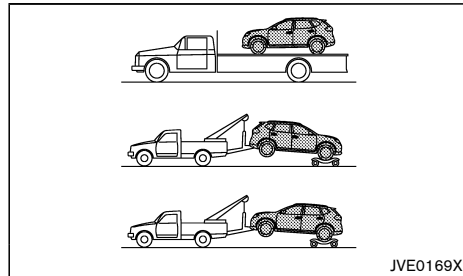

4WD model

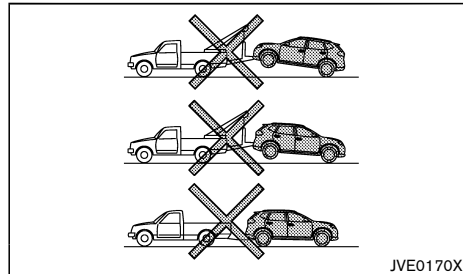

4WD model

NISSAN recommends that towing dollies be used under the front or rear wheels when towing your vehicle or the vehicle be placed on a flatbed tow truck as illustrated.

#### CAUTION:

**Never tow 4WD with any of the wheels on the ground. Doing so will cause serious and expensive damage to the drivetrain.**

#### Freeing trapped vehicle

#### WARNING:

- Never allow anyone to stand near the towing line during the pulling operation.
- Never spin the tires at high speed. This could cause them to explode and result in serious injury. Parts of the vehicle could also over-heat and be damaged.
- Do not pull the vehicle using the rear hook (except for Europe and Indonesia). The rear hook is not designed to pull the vehicle out in the event that the vehicle becomes trapped.

In the event that your vehicle's tires become trapped in sand, snow, or mud, and the vehicle is unable to free itself without being pulled, use the recovery hooks.

- Use the recovery hooks only. Do not attach the pulling device to any other part of the vehicle body. Otherwise, the vehicle body may be damaged.
- Use the recovery hooks to free a vehicle only.
- The recovery hooks are under tremendous stress when used to free a trapped vehicle. Always pull the pulling device straight out from the vehicle. Never pull on the recovery hooks at an angle.

#### Front:

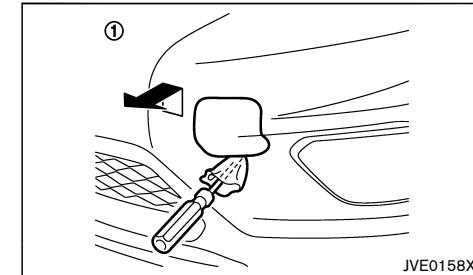

Front

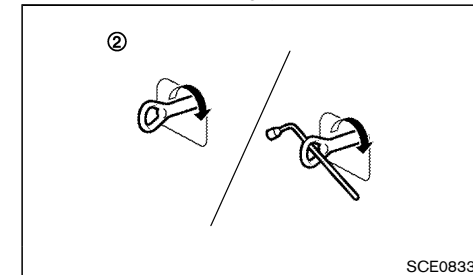

Front

- ① Remove the hook cover from the bumper with a suitable tool.
- ② Securely install the recovery hook as illustrated. (The hook is stored in the storage area.)

Make sure that the recovery hook is properly secured in its storage area after use.

## 6-12 In case of emergency

**Rear:**

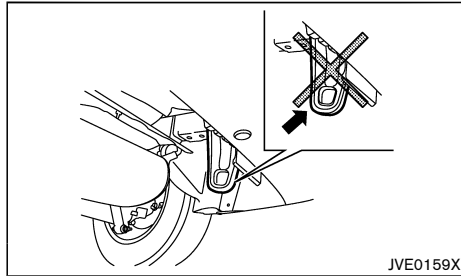

**Except for Europe and Indonesia**

Except for Europe and Indonesia: Do not use the rear hook to pull the vehicle.

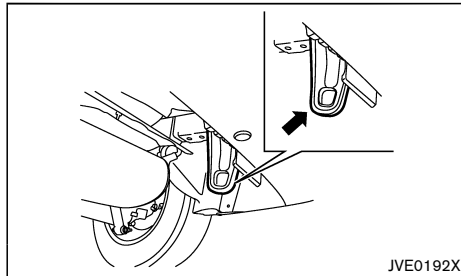

**For Europe and Indonesia**

The rear hook is designed as the recovery hook.

**MEMO**

**6-14 In case of emergency**

Condition: 'Except for China'

[ Edit: 2014/ 11/ 7 Model: T32-A ]

# 7 Appearance and care

Cleaning exterior .....	7-2	Cleaning interior .....	7-3
Washing .....	7-2	Air fresheners .....	7-4
Removing spots .....	7-2	Floor mats .....	7-4
Waxing .....	7-2	Glass .....	7-4
Glass .....	7-2	Seat belts .....	7-4
Underbody .....	7-3	Corrosion protection .....	7-5
Wheels .....	7-3	Most common factors contributing to vehicle corrosion .....	7-5
Aluminum alloy wheels .....	7-3	Environmental factors influence rate of corrosion .....	7-5
Chrome parts .....	7-3	To protect your vehicle from corrosion .....	7-5

## CLEANING EXTERIOR

In order to maintain the appearance of your vehicle, it is important to take proper care of it.

Whenever possible, park your vehicle inside a garage or in a covered area to minimize the chances of damaging the paint surface of your vehicle.

When it is necessary to park outside, park in a shady area or protect the vehicle with a body cover. **Be careful not to scratch the paint surface when putting on or removing the body cover.**

### WASHING

In the following instances, wash your vehicle as soon as possible to protect the paint surface:

- After a rainfall, which may cause the paint surface damage from acid rain.
  - After driving on coastal roads, which may cause rusting from the sea breeze.
  - When contaminants such as soot, bird droppings, tree sap, metal particles or bugs get on the paint surface.
  - When dust or mud builds up on the paint surface.
1. Wash the vehicle surface with a wet sponge and plenty of water.
  2. Clean the vehicle surface gently and thoroughly using a mild soap, a special vehicle soap or a general purpose dishwashing liquid mixed with clean, lukewarm (never hot) water.



#### CAUTION:

- **Do not wash the vehicle with strong household soap, strong chemical detergents, gasoline or solvents.**
- **Do not wash the vehicle in direct sunlight or while the vehicle body is hot, as the paint surface may become water-spotted.**

## 7-2 Appearance and care

- **Avoid using tight-napped or rough cloths, such as washing mitts. Care must be taken when removing caked-on dirt or other foreign substances so the paint surface is not scratched or damaged.**

3. Rinse the vehicle thoroughly with plenty of clean water.
4. Use a dampened chamois to dry the paint surface and avoid leaving water spots.

When washing the vehicle, take care of the following:

- Inside flanges, joints and folds on the doors, hatches and hood are particularly vulnerable to the effects of road salt. Therefore, these areas must be cleaned regularly.
- Be sure that the drain holes in the lower edge of the doors are not clogged.
- Spray water to the underbody and in the wheel wells to loosen the dirt and/or wash away road salt.

### REMOVING SPOTS

Remove tar and oil spots, industrial dust, insects, and tree sap as quickly as possible from the paint surface to avoid lasting damage or staining. Special cleaning products are available at a NISSAN dealer or any automotive accessory store.

### WAXING

Regular waxing protects the paint surface and helps maintain a new vehicle appearance.

After waxing, polishing is recommended to remove built-up residue and to avoid a weathered appearance.

A NISSAN dealer can assist you in choosing the appropriate waxing products.



#### CAUTION:

- **Wash your vehicle thoroughly and completely before applying wax to the paint surface.**
- **Always follow the manufacturer's instructions supplied with the wax.**
- **Do not use a wax containing any abrasives, cutting compounds or cleaners that may damage the vehicle finish.**

Machine compounding or aggressive polishing on a base coat/clear coat paint finish may dull the finish or leave swirl marks.

### GLASS

Use glass cleaner to remove smoke and dust film from the glass surfaces. It is normal for glass to become coated with a film after the vehicle is parked in the hot sun. Glass cleaner and a soft cloth will easily remove this film.



## UNDERBODY

In areas where road salt is used in the winter, it is necessary to clean the vehicle's underbody regularly in order to prevent dirt and salt from building up and causing the acceleration of corrosion on the underbody and suspension.

Before the winter and again in the spring, the underseal must be checked and, if necessary, re-treated.

## WHEELS

- Wash the wheels when washing the vehicle to maintain their appearance.
- Clean the inner side of the wheels when the wheel is changed or the underside of the vehicle is washed.
- Do not use abrasive cleaners when washing the wheels.
- Inspect wheel rims regularly for dents or corrosion. This may cause loss of pressure or damage the tire bead.
- NISSAN recommends that the road wheels be waxed to protect against road salt in areas where it is used during winter.

## ALUMINUM ALLOY WHEELS

Wash the wheels regularly with a sponge dampened in a mild soap solution, especially during winter in areas where road salt is used. The salt residue from road salt could discolor the wheels if it is not washed off regularly.



### CAUTION:

**Follow the directions below to avoid staining or discoloring the wheels:**

- **Do not use a cleaner that uses strong acid or alkali contents to clean the wheels.**
- **Do not apply wheel cleaners to the wheels when they are hot. The wheel temperature should be the same as ambient temperature.**
- **Rinse the wheel to completely remove the cleaner within 15 minutes after the cleaner is applied.**

## CHROME PARTS

Clean all chrome parts regularly with a nonabrasive chrome polish to maintain the finish.

## CLEANING INTERIOR

Occasionally remove loose dust from the interior trim, plastic parts and seats using a vacuum cleaner or soft bristled brush. Wipe the vinyl and leather surfaces with a clean, soft cloth dampened in mild soap solution, then wipe clean with a dry, soft cloth.

Regular care and cleaning is required in order to maintain the appearance of the leather.

Before using any fabric protector, read the manufacturer's recommendations. Some fabric protectors contain chemicals that may stain or bleach the seat material.

Use a soft cloth dampened only with water to clean the meter and gauge lens covers.



### CAUTION:

- **Never use benzine, thinner or any similar material.**
- **Small dirt particles can be abrasive and damaging to leather surfaces and should be removed promptly. Do not use saddle soap, car waxes, polishes, oils, cleaning fluids, solvents, detergents or ammonia-based cleaners as they damage the natural leather finish.**
- **Never use fabric protectors unless recommended by the manufacturer.**
- **Do not use glass or plastic cleaner on meter or gauge lens covers. It may damage the lens covers.**

## AIR FRESHENERS

Most air fresheners use a solvent that could affect the vehicle interior. If you use an air freshener, take the following precautions:

- Hanging-type air fresheners can cause permanent discoloration when they contact vehicle interior surfaces. Place the air freshener in a location that allows it to hang free and not contact an interior surface.
- Liquid-type air fresheners typically clip on the vents. These products can cause immediate damage and discoloration when spilled on interior surfaces.

Carefully read and follow the manufacturer's instructions before using air fresheners.

## FLOOR MATS

The use of genuine NISSAN floor mats (if equipped) can extend the life of your vehicle carpet and make it easier to clean the interior. Regardless of what mats are used, be sure they are fitted for your vehicle and are properly positioned in the foot well to prevent interference with pedal operation. Mats should be maintained with regular cleaning and replaced if they become excessively worn.

## Floor mat positioning aid

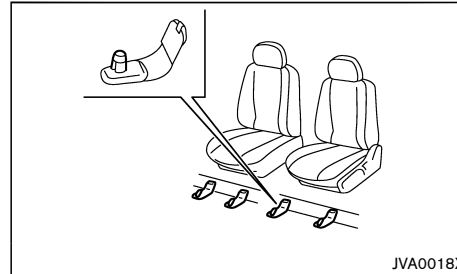

This vehicle includes front floor mat brackets to act as a floor mat positioning aid. NISSAN floor mats have been specially designed for your vehicle model.

Position the mat by placing the floor mat bracket hook through the floor mat grommet hole while centering the mat in the foot area.

Periodically check that the mats are properly positioned.

## GLASS

Use glass cleaner to remove smoke and dust film from the glass surfaces. It is normal for glass to become coated with a film after the vehicle is parked in the hot sun. Glass cleaner and a soft cloth will easily remove this film.



### CAUTION:

**When cleaning the inside of the windows, do not use sharp-edged tools, abrasive cleaners or chlorine-based disinfectant cleaners. They could damage the electrical conductors, such as rear window defogger elements.**

## SEAT BELTS



### WARNING:

- **Do not allow wet seat belts to roll up in the retractor.**
- **Never use bleach, dye or chemical solvents to clean the seat belts, since these materials may severely weaken the seat belt webbing.**

The seat belts can be cleaned by wiping them with a sponge dampened in a mild soap solution.

Allow the belts to dry completely in the shade before using them. (See "Seat belts" (P.1-9).)

## 7-4 Appearance and care

## CORROSION PROTECTION

### MOST COMMON FACTORS CONTRIBUTING TO VEHICLE CORROSION

- The accumulation of moisture-retaining dirt and debris in body panel sections, cavities, and other areas.
- Damage to the paint surface and other protective coatings caused by gravel and stone chips or minor traffic accidents.

### ENVIRONMENTAL FACTORS INFLUENCE RATE OF CORROSION

#### Moisture

The accumulation of sand, dirt and water on the inside floor of the vehicle can accelerate corrosion. Wet floor carpet/floor mats will not dry completely inside the vehicle. They should be removed and completely dried to avoid floor panel corrosion.

#### Relative humidity

Corrosion will be accelerated in areas of high relative humidity.

#### Temperature

High temperatures accelerate the rate of corrosion to those parts which are not well ventilated.

Corrosion will also be accelerated in areas where the temperatures stay above freezing.

#### Air pollution

Industrial pollution, the presence of salt in the air in coastal areas, or heavy road salt use accelerates the corrosion process. Road salt also accelerates the disintegration of paint surfaces.

### TO PROTECT YOUR VEHICLE FROM CORROSION

- Wash and wax your vehicle often to keep the vehicle clean.
- Always check for minor damage to the paint surface and if any exists, repair it as soon as possible.
- Keep the drain holes in the lower edge of the doors open to avoid water accumulation.
- Check the vehicle underbody for accumulation of sand, dirt or salt. If present, wash with water as soon as possible.



#### CAUTION:

- **Never remove dirt, sand or other debris from the passenger compartment by washing it out with a hose. Remove dirt with a vacuum cleaner.**
- **Never allow water or other liquids to come in contact with electronic components inside the vehicle as this may damage them.**

Chemicals used for road surface deicing are extremely corrosive. They accelerate corrosion and deterioration of underbody components such as the exhaust system, fuel and brake lines, brake cables, floor pan and fenders.

**In the winter, the underbody must be cleaned periodically.**

For additional protection against rust and corrosion, which may be required in some areas, consult a NISSAN dealer.

**MEMO**

**7-6 Appearance and care**

Condition: 'Except for China/'

[ Edit: 2014/ 11/ 7 Model: T32-A ]

## 8 Maintenance and do-it-yourself

Maintenance requirements .....	8-2	Wiper blades .....	8-18
Scheduled maintenance .....	8-2	Windshield wiper blades .....	8-18
General maintenance .....	8-2	Rear window wiper blade .....	8-19
Where to go for service .....	8-2	Window washer fluid .....	8-19
General maintenance .....	8-2	Battery .....	8-20
Explanation of general maintenance items .....	8-2	Vehicle battery .....	8-20
Maintenance precautions .....	8-4	Remote controller battery .....	8-21
Engine compartment check locations .....	8-5	Intelligent Key battery .....	8-22
QR25DE engine model .....	8-6	Variable voltage control system (if equipped) .....	8-23
MR20DD engine model .....	8-7	Fuses .....	8-24
R9M engine model .....	8-8	Engine compartment .....	8-24
Engine cooling system .....	8-8	Passenger compartment .....	8-24
Checking engine coolant level .....	8-9	Lights .....	8-27
Changing engine coolant .....	8-9	Headlights .....	8-27
Engine oil .....	8-10	Exterior lights .....	8-28
Checking engine oil level .....	8-10	Interior lights .....	8-29
Changing engine oil and oil filter .....	8-10	Light locations .....	8-30
Protect environment .....	8-13	Legal requirement to adjust headlight beam .....	8-33
Drive belt .....	8-14	Tires and wheels .....	8-36
Spark plugs (gasoline engine models) .....	8-14	Tire Pressure Monitoring System (TPMS) (if equipped) ....	8-36
Iridium-tipped spark plugs .....	8-14	Tire inflation pressure .....	8-36
Brakes .....	8-15	Types of tires .....	8-36
Checking parking brake .....	8-15	Tire chains .....	8-36
Checking foot brake pedal .....	8-15	Tire rotation .....	8-37
Brake booster .....	8-15	Tire wear and damage .....	8-37
Brake fluid .....	8-16	Tire age .....	8-37
Clutch fluid (if equipped) .....	8-17	Changing tires and wheels .....	8-37
Continuously Variable Transmission (CVT) fluid (if equipped) ....	8-17	Wheel balance .....	8-38
Air cleaner filter .....	8-17	Spare tire (if equipped) .....	8-38

## MAINTENANCE REQUIREMENTS

Some day-to-day and regular maintenance is essential to maintain your vehicle's good mechanical condition, as well as its emission and engine performance.

It is the owner's responsibility to make sure that the specified maintenance, as well as general maintenance, is performed.

As the vehicle owner, you are the only one who can ensure that your vehicle receives the proper maintenance care.

### SCHEDULED MAINTENANCE

For your convenience, the required scheduled maintenance items are described and listed in a separate Warranty Information and Maintenance booklet. You must refer to that booklet to ensure that necessary maintenance is performed on your vehicle at regular intervals.

### GENERAL MAINTENANCE

General maintenance includes those items which should be checked during normal day-to-day operation of the vehicle. They are essential if your vehicle is to continue to operate properly. It is your responsibility to perform these procedures regularly as prescribed.

Performing general maintenance checks requires minimal mechanical skill and only a few general automotive tools.

These checks and inspections can be done by yourself, a qualified technician, or if you prefer, a NISSAN dealer.

### WHERE TO GO FOR SERVICE

If maintenance service is required or your vehicle appears to malfunction, have the systems checked and tuned by an authorised NISSAN dealer.

## GENERAL MAINTENANCE

During normal day-to-day operation of the vehicle, general maintenance should be performed regularly as prescribed in this section. If you detect any unusual sounds, vibrations or smells, be sure to check for the cause or have a NISSAN dealer do it promptly. In addition, you should notify a NISSAN dealer if you think that repairs are required.

When performing any checks or maintenance work, closely observe "Maintenance precautions" (P.8-4).

### EXPLANATION OF GENERAL MAINTENANCE ITEMS

**Additional information on the following items with "\*" is found later in this section.**

#### Outside vehicle

The maintenance items listed here should be performed from time to time, unless otherwise specified.

#### Doors and hood:

Check that all doors and the hood operate smoothly as well as the back door, trunk lid and hatch. Also make sure that all latches lock securely. Lubricate if necessary. Make sure that the secondary latch keeps the hood from opening when the primary latch is released. When driving in areas using road salt or other corrosive materials, check lubrication frequently.

#### Lights\*:

Clean the headlights on a regular basis. Make sure that the headlights, stop lights, tail lights, turn signal lights, and other lights are all operating properly and installed securely. Also check the aim of the headlights.

## 8-2 Maintenance and do-it-yourself

**Tires\*:**

Check the pressure with a gauge often and always prior to long distance trips. Adjust the pressure in all tires, including the spare, to the pressure specified.

Check carefully for damage, cuts or excessive wear.

**Tire rotation\*:**

In the case that Two-Wheel Drive (2WD) and front & rear tires are same size; Tires should be rotated every 10,000 km (6,000 miles).

Tires marked with directional indicators can only be rotated between front and rear.

Make sure that the directional indicators point in the direction of wheel rotation after the tire rotation is completed.

In the case that Four-Wheel Drive (4WD) and front & rear tires are same size; Tires should be rotated every 5,000 km (3,000 miles).

Tires marked with directional indicators can only be rotated between front and rear.

Make sure that the directional indicators point in the direction of wheel rotation after the tire rotation is completed.

In the case that front tires are different size from rear tires; Tires cannot be rotated.

However, the timing for tire rotation may vary according to your driving habits and the road surface conditions.

**Tire Pressure Monitoring System (TPMS) transmitter components (if equipped):**

Replace the TPMS transmitter grommet seal, valve core and cap when the tires are replaced due to wear or age.

**Wheel alignment and balance:**

If the vehicle should pull to either side while driving on a straight and level road, or if you detect uneven or abnormal tire wear, there may be a need for wheel alignment. If the steering wheel or seat vibrates at normal highway speeds, wheel balancing may be needed.

**Windshield:**

Clean the windshield on a regular basis. Check the windshield at least every six months for cracks or other damage. Repair as necessary.

**Wiper blades\*:**

Check for cracks or wear if not functioning correctly. Replace as necessary.

**Inside vehicle**

The maintenance items listed here should be checked on a regular basis, such as when performing periodic maintenance, cleaning the vehicle, etc.

**Accelerator pedal:**

Check the pedal for smooth operation and make sure that the pedal does not catch or require uneven effort. Keep the floor mats away from the pedal.

**Brake pedal\*:**

Check the pedal for smooth operation and make sure that it is the proper distance from the floor mat when depressed fully. Check the brake booster function. Be sure to keep the floor mats away from the pedal.

**Parking brake\*:**

Check the parking brake operation regularly. Check that the lever (if equipped) or the pedal (if equipped) has the proper travel. Also make sure that the vehicle is held securely on a fairly steep hill when only the parking brake is applied.

**Seat belts:**

Check that all parts of the seat belt system (for example, buckles, anchors, adjusters and retractors) operate properly and smoothly, and are installed securely. Check the belt webbing for cuts, fraying, wear or damage.

**Steering wheel:**

Check for changes in the steering condition, such as excessive play, hard steering or strange noises.

**Warning lights and chimes:**

Make sure that all warning lights and chimes are operating properly.

**Windshield defogger:**

Check that the air comes out of the defogger outlets properly and in good quantity when operating the heater or air conditioner.

**Windshield wiper and washer\*:**

Check that the wipers and washer operate properly and that the wipers do not streak.

**Under hood and vehicle**

The maintenance items listed here should be checked periodically (for example, each time you check the engine oil or refuel).

**Battery\*:**

Except for maintenance free battery, check the fluid level in each cell. It should be between the "UPPER" and "LOWER" lines. Vehicles operated in high temperatures or under severe conditions require frequent checks of the battery fluid level.

**Brake and clutch fluid level(s)\*:**

For Manual Transmission (MT) model; make sure that the brake and clutch fluid levels are between the "MAX" and "MIN" lines on the reservoirs.

Except for Manual Transmission (MT) model; make sure that the brake fluid level is between the "MAX" and "MIN" lines on the reservoir.

**Coolant level\*:**

Check the coolant level when the coolant is cold. Make sure that the coolant level is between the "MAX" and "MIN" lines on the reservoir.

**Engine drive belts\*:**

Make sure that drive belt(s) is/are not frayed, worn, cracked or oily.

**Engine oil level\*:**

Check the level after parking the vehicle (on a level ground) and turning off the engine.

**Fluid leaks:**

Check under the vehicle for fuel, oil, water or other fluid leaks after the vehicle has been parked for a while. Water dripping from the air conditioner after use is normal. If you should notice any leaks or if fuel fumes are evident, check for cause and have it corrected immediately.

**Window washer fluid\*:**

Check that there is adequate fluid in the reservoir.

**MAINTENANCE PRECAUTIONS**

When performing any inspection or maintenance work on your vehicle, always take care to prevent serious accidental injury to yourself or damage to the vehicle. The following are general precautions which should be closely observed.

**⚠ WARNING:**

- **Park the vehicle on a level surface, apply the parking brake securely and block the wheels to prevent the vehicle from moving. Move the shift lever to the "P" (Park) position (Continuously Variable Transmission model) or the shift lever to the "N" (Neutral) position (Manual Transmission model).**
- **Be sure the ignition switch is in the "OFF" or "LOCK" position when performing any parts replacement or repairs.**
- **Do not work under the hood while the engine is hot. Always turn off the engine and wait until it cools down.**
- **If you must work with the engine running, keep your hands, clothing, hair and tools away from moving fans, belts and any other moving parts.**
- **It is advisable to secure or remove any loose clothing and any jewelry, such as rings, watches, etc. before working on your vehicle.**
- **If you must run the engine in an enclosed space such as a garage, be sure there is proper ventilation for exhaust gases to escape.**
- **Never get under the vehicle while it is supported by a jack.**

- **Keep smoking materials, flame and sparks away from fuel and the battery.**
- **Never connect or disconnect either the battery or any transistorized component connector while the ignition switch is in the "ON" position.**
- **On gasoline engine models with the Multi-port Fuel Injection (MFI) system, the fuel filter and fuel lines should be serviced by a NISSAN dealer because the fuel lines are under high pressure even when the engine is turned off.**
- **Your vehicle is equipped with an automatic engine cooling fan. It may come on at any time without warning, even if the ignition switch is in the "OFF" position and the engine is not running. To avoid injury, always disconnect the negative battery cable before working near the fan.**
- **Always wear eye protection whenever you work on your vehicle.**
- **Never leave the engine or transmission related component harness connector disconnected while the ignition switch is in the "ON" position.**
- **Avoid direct contact with used engine oil and coolant. Improperly disposed engine oil, engine coolant, and/or other vehicle fluids can hurt the environment. Always conform to local regulations for disposal of vehicle fluids.**

This "8. Maintenance and do-it-yourself" section provides instructions regarding only those items which are relatively easy for an owner to perform.

You should be aware that incomplete or improper

**8-4 Maintenance and do-it-yourself**



## ENGINE COMPARTMENT CHECK LOCATIONS

servicing may result in operating difficulties or excessive emissions, and could affect your warranty coverage. **If in doubt about any servicing, have it done by a NISSAN dealer.**

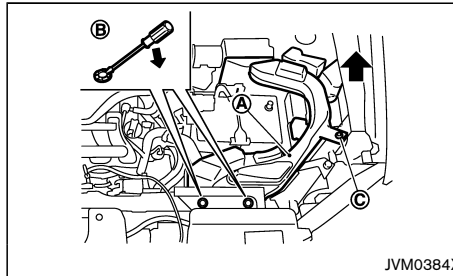

Remove the air duct if necessary.

To remove the air duct (A) :

1. Remove the clips (B) with a suitable tool.
2. Loosen the bolt (C) with a suitable tool.
3. Pull the air duct upward and then sideways.

To install the air duct, perform the installation procedure in reverse order.

## QR25DE ENGINE MODEL

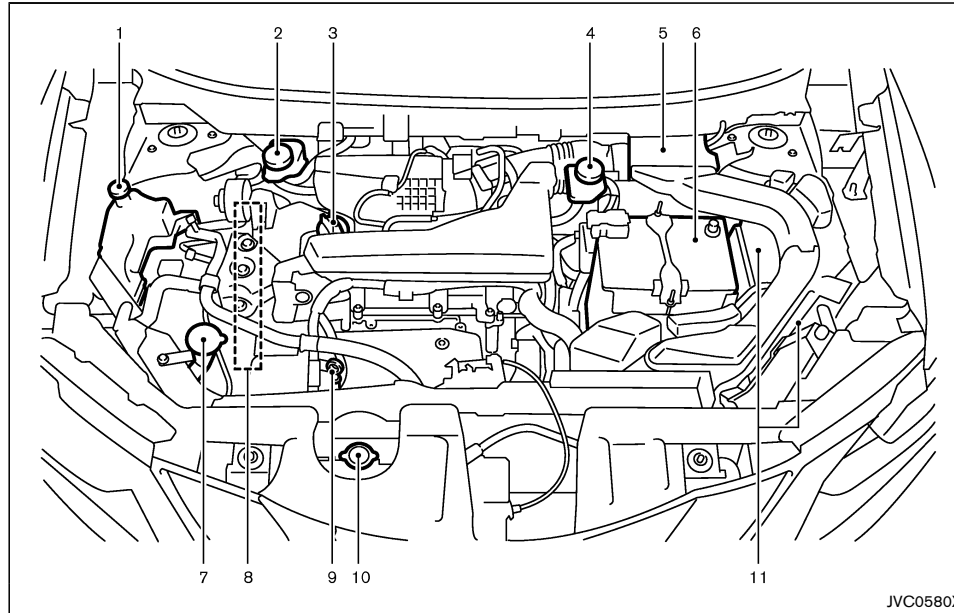

- |                                      |                           |
|--------------------------------------|---------------------------|
| 1. Engine coolant reservoir          | 9. Engine oil dipstick    |
| 2. Brake fluid reservoir — RHD model | 10. Radiator cap          |
| 3. Engine oil filler cap             | — Vehicle overheat        |
| 4. Brake fluid reservoir — LHD model | 11. Fuse/fusible link box |
| 5. Air cleaner                       |                           |
| 6. Battery                           |                           |
| 7. Window washer fluid reservoir     |                           |
| 8. Engine drive belts                |                           |

**8-6 Maintenance and do-it-yourself**

## MR20DD ENGINE MODEL

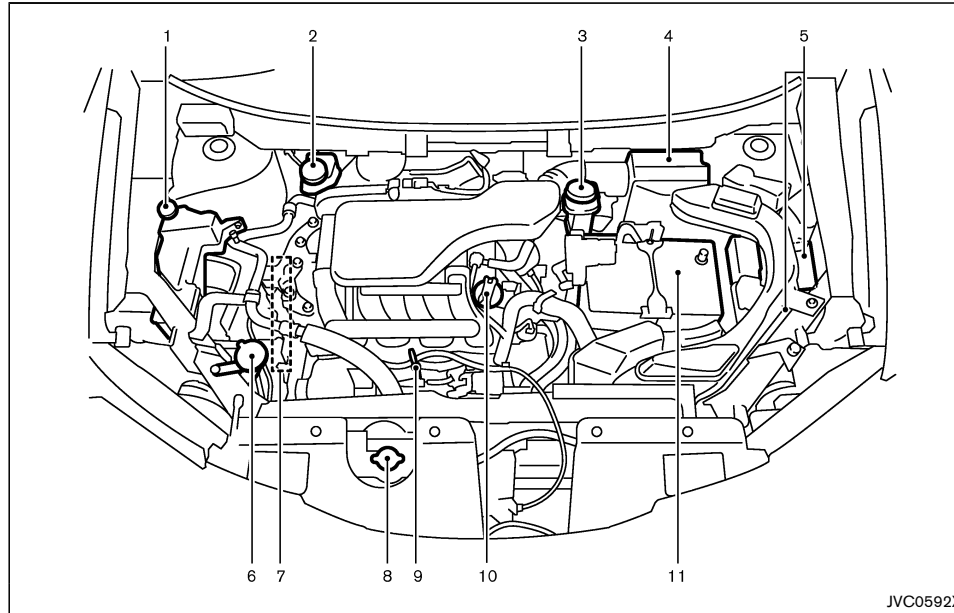

- |  |                                       |
|--|---------------------------------------|
| 1. Engine coolant reservoir                      | 9. Engine oil dipstick                |
| 2. Brake and clutch* fluid reservoir — RHD model | 10. Engine oil filler cap             |
| 3. Brake and clutch* fluid reservoir — LHD model | 11. Battery                           |
| 4. Air cleaner                                   | *: For Manual Transmission (MT) Model |
| 5. Fuse/fusible link box                         |                                       |
| 6. Window washer fluid reservoir                 |                                       |
| 7. Engine drive belts                            |                                       |
| 8. Radiator cap                                  |                                       |
| — Vehicle overheat                               |                                       |

## R9M ENGINE MODEL

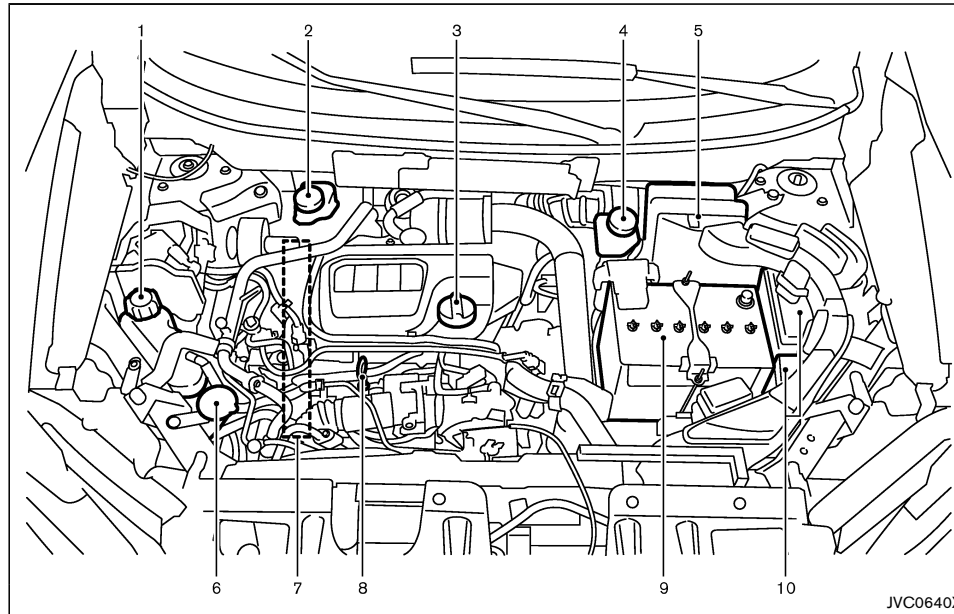

- |  |                                       |
|--|---------------------------------------|
| 1. Engine coolant reservoir                      | 9. Battery                            |
| 2. Brake and clutch* fluid reservoir — RHD model | 10. Fuse/fusible link box             |
| 3. Engine oil filler cap                         | *: For Manual Transmission (MT) Model |
| 4. Brake and clutch* fluid reservoir — LHD model |                                       |
| 5. Air cleaner                                   |                                       |
| 6. Window washer fluid reservoir                 |                                       |
| 7. Engine drive belts                            |                                       |
| 8. Engine oil dipstick                           |                                       |

## 8-8 Maintenance and do-it-yourself

## ENGINE COOLING SYSTEM

**WARNING:**

- **Never remove the radiator or coolant reservoir cap when the engine is hot. Serious burns could be caused by high-pressure fluid escaping from the radiator. Wait until the engine and radiator cool down.**
- **Engine coolant is poisonous and should be stored carefully in marked containers out of the reach of children.**

The engine cooling system is filled at the factory with a high-quality, year-round, anti-freeze coolant solution. The anti-freeze solution contains rust and corrosion inhibitors, therefore additional cooling system additives are not necessary.

**CAUTION:**

- **Never use any cooling system additives such as radiator sealer. Additives may clog the cooling system and cause damage to the engine, transmission and/or cooling system.**
- **When adding or replacing coolant, be sure to use only Genuine NISSAN Engine Coolant or equivalent in its quality with the proper mixture ratio. Examples of the mixture ratio of coolant and water are shown in the following table:**

Outside temperature down to		Engine coolant (concentrated)	Demineralized or distilled water
°C	°F		
-15	5	30%	70%
-35	-30	50%	50%

Use Genuine NISSAN Engine Coolant or equivalent in its quality. Genuine NISSAN Engine Coolant is a pre-mixed (mixture ratio 50%) type coolant.

The use of other types of coolant solutions may damage the engine cooling system.

The radiator is equipped with a pressure cap. To prevent engine damage, use only a Genuine NISSAN radiator cap or its equivalent when replacement is required.

### CHECKING ENGINE COOLANT LEVEL

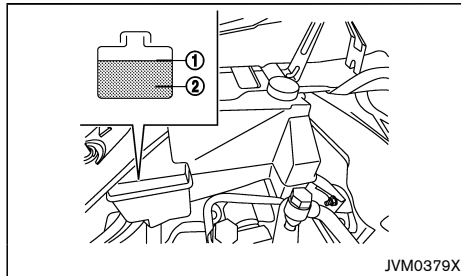

QR25 and MR20 engine

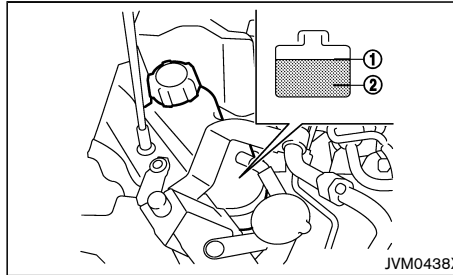

R9M engine

Check the coolant level in the reservoir tank when the engine is cold. If the coolant level is below the MIN level ②, add coolant up to the MAX level ①. If the reservoir tank is empty, check the coolant level in the radiator **when the engine is cold**. If there is insufficient coolant in the radiator, fill the radiator with coolant up to the filler opening and also add it to the reservoir tank up to the MAX level ①.

**If the cooling system frequently requires coolant, have it checked by a NISSAN dealer.**

### CHANGING ENGINE COOLANT

Contact a NISSAN dealer if replacement is required.

Major engine cooling system repair should be performed by a NISSAN dealer. The service procedures can be found in the appropriate NISSAN Service Manual.

Improper servicing can result in reduced heater performance and engine overheating.

### WARNING:

- **To avoid being scalded, never change the coolant when the engine is hot.**

- **Never remove the radiator or coolant reservoir cap when the engine is hot. Serious burns could be caused by high pressure fluid escaping from the radiator.**
- **Avoid direct skin contact with used coolant. If skin contact is made, wash thoroughly with soap or hand cleaner as soon as possible.**
- **Keep coolant out of the reach of children and pets.**

Engine coolant must be disposed of properly. Check your local regulations.

## ENGINE OIL

### CHECKING ENGINE OIL LEVEL

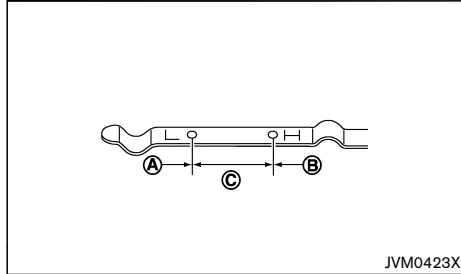

QR25 and MR20 engine

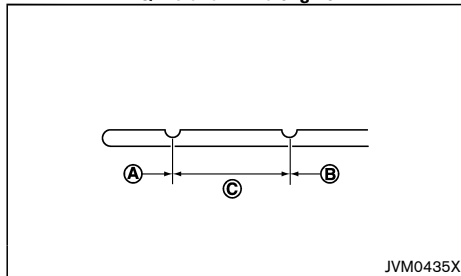

R9M engine

1. Park the vehicle on a level surface and apply the parking brake.
2. Start the engine and warm it up until the engine temperature reaches the normal operating temperature (approximately 5 minutes).
3. Stop the engine.
4. Wait at least 10 minutes for the engine oil to drain back to the oil pan.
5. Remove the dipstick and wipe it clean.

6. Reinsert the dipstick all the way.
7. Remove the dipstick and check the oil level. It should be within the range (C) .
8. If the oil level is below (A) , remove the oil filler cap and pour the recommended oil into the opening. Do not overfill (B) .

**When filling the engine oil, do not remove the dipstick.**

9. Recheck the oil level with the dipstick.

**It is normal to add some oil between oil maintenance intervals or during the break-in period, depending on the severity of operating conditions.**



#### CAUTION:

**The oil level should be checked regularly. Operating your vehicle with an insufficient amount of oil can damage the engine, and such damage is not covered by the warranty.**

### CHANGING ENGINE OIL AND OIL FILTER



#### WARNING:

- **Used oil must be disposed of properly. Never pour or dump oil into the ground, canals, rivers, etc. It should be disposed of at proper waste facilities. NISSAN recommends having your oil changed by a NISSAN dealer.**
- **Be careful not to burn yourself, as the engine oil may be hot.**
- **Prolonged and repeated contact with used engine oil may cause skin cancer.**
- **Avoid direct skin contact with used oil. If contacted, wash thoroughly with soap or**

**hand cleaner and plenty of water as soon as possible.**

- **Store used engine oil in marked containers out of the reach of children.**

#### Vehicle set-up

1. Park the vehicle on a level surface and apply the parking brake.
2. Start the engine and warm it up until the engine temperature reaches the normal operating temperature (approximately 5 minutes).
3. Stop the engine.
4. Wait at least 10 minutes for the engine oil to drain back to the oil pan.
5. Raise and support the vehicle using a suitable floor jack and safety jack stands.
  - Place the safety jack stands under the vehicle jack-up points.
  - A suitable adapter should be attached to the jack stand saddle.
6. Remove the plastic engine undercover (if equipped).
  - Remove the plastic clips from the undercover.

#### Engine oil and filter

#### QR25DE and MR20DD engine:

## 8-10 Maintenance and do-it-yourself

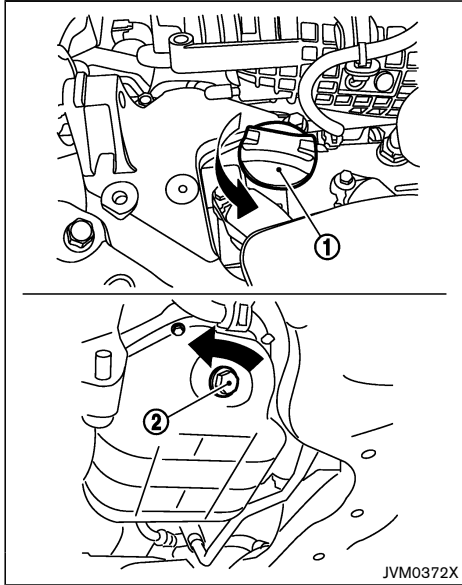

QR25DE engine

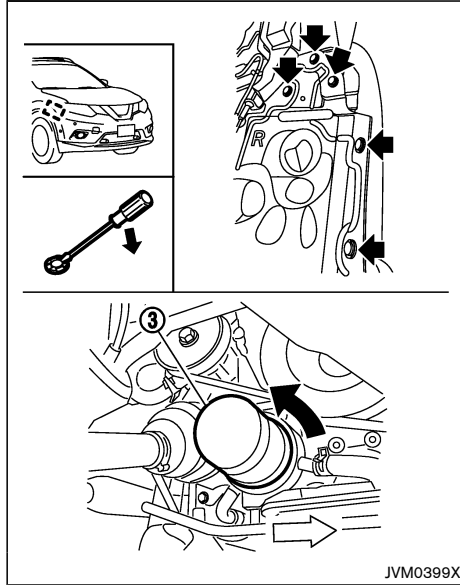

QR25DE engine

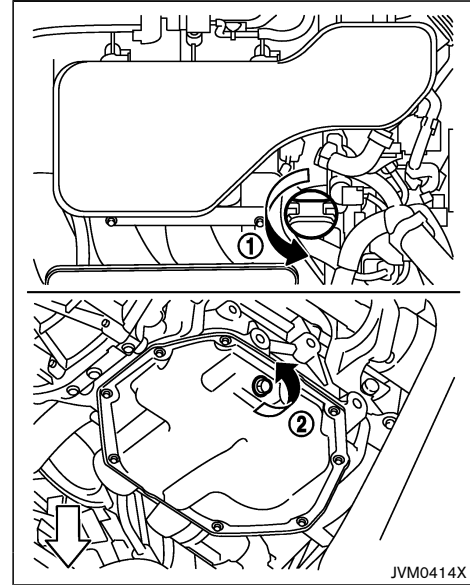

MR20DD engine

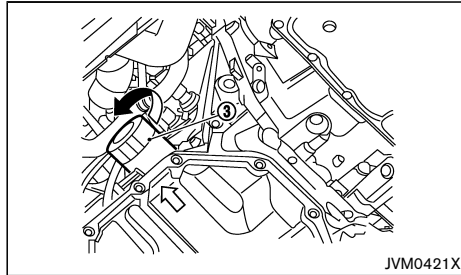
**MR20DD engine**

- ① Oil filler cap
- ② Oil drain plug
- ③ Oil filter

1. Place a large drain pan under the drain plug.
2. Remove the drain plug with a wrench.
3. Remove the oil filler cap and completely drain the oil.  
If the oil filter is to be changed, remove and replace it at this time.

**CAUTION:**

**Waste oil must be disposed of properly. Check your local regulations.**

4. Remove the plastic cover over the oil filter location by removing the small plastic clips as illustrated. (For QR25DE engine)
5. Loosen the oil filter with an oil filter wrench.
6. Remove the oil filter by turning it by hand.
7. Wipe the engine oil filter mounting surface with a clean cloth.

Be sure to remove any old gasket remaining on the mounting surface.

## 8-12 Maintenance and do-it-yourself

8. Apply new engine oil to the gasket of the new oil filter.
9. Screw in the oil filter until a slight resistance is felt and then tighten an additional 2/3 of a turn to secure the filter.

**Oil filter tightening torque:**

**15 to 20 N·m  
(1.5 to 2.0 kg·m, 11 to 15 ft·lb)**

10. Clean and reinstall the drain plug and new washer. Securely tighten the drain plug with a wrench. Do not use excessive force.

**Drain plug tightening torque:**

**29 to 39 N·m  
(3.0 to 4.0 kg·m, 22 to 29 ft·lb)**

11. Refill the recommended engine oil and quantity. (See "Recommended Fluids/Lubricants and capacities" (P.9-2).)

**When filling the engine oil, do not remove the dipstick.**

12. Securely install the oil filler cap.
13. Start the engine.
14. Check the drain plug for any sign of leakage.
15. Dispose of the used oil in the proper manner. Check your local regulations.
16. Check the engine oil level according to the proper procedure. (See "Checking engine oil level" (P.8-10).)

**R9M engine:**

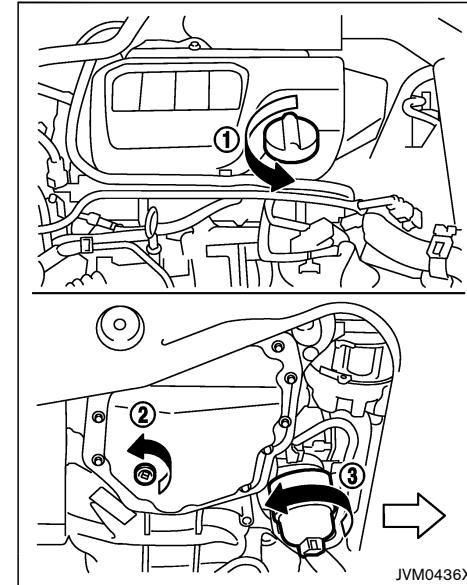

- ① Oil filler cap
- ② Oil drain plug
- ③ Oil filter



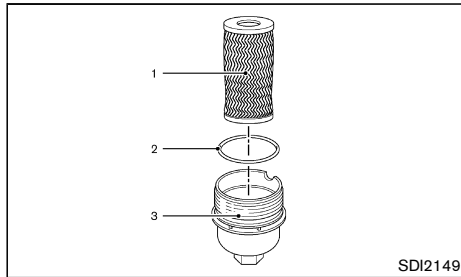

- 1 Oil filter element
- 2 O-ring
- 3 Oil filter cover

1. Place a large drain pan under the drain plug.
2. Remove the drain plug with a wrench.
3. Remove the oil filler cap and completely drain the oil.

If the oil filter is to be changed, remove and replace it at this time.



**CAUTION:**

**Waste oil must be disposed of properly. Check your local regulations.**

4. Loosen the oil filter cover with a wrench.
5. Remove the engine oil filter cover then the oil filter element.
6. Remove the rubber O-ring from the filter cover.
7. Wipe the entire oil filter cover with a clean cloth.  
Be sure to remove any old O-ring remaining on the mounting surface.

8. Apply new engine oil to the O-ring.  
Install the new O-ring on the new oil filter element.
9. Insert the oil filter element into the engine oil filter cover.
10. Screw in the oil filter cover until a slight resistance is felt, and then tighten the filter completely.

**Oil filter cover tightening torque:**

**25 N·m  
(2.6 kg·m, 18 ft·lb)**

11. Clean and reinstall the drain plug and new washer.  
Securely tighten the drain plug with a wrench. Do not use excessive force.

**Drain plug tightening torque:**

**50 N·m  
(5.1 kg·m, 36.9 ft·lb)**

12. Refill the recommended engine oil and quantity. (See "Recommended Fluids/lubricants and capacities" (P.9-2).)
13. Securely install the oil filler cap.
14. Start the engine.
15. Check the drain plug for any sign of leakage.
16. Dispose of the used oil in the proper manner. Check your local regulations.
17. Check the engine oil level according to the proper procedure. (See "Checking engine oil level" (P.8-10).)

**After operation**

1. Lower the vehicle carefully to the ground.
2. Dispose of waste oil and filter properly.

**PROTECT ENVIRONMENT**

It is illegal to pollute drains, watercourses and soil. Use authorized waste collection facilities, including civil amenity sites and garages providing facilities for disposal of used oil and used oil filters. If in doubt, contact your local authority for advice on disposal.

**The regulations concerning the pollution of the environment will vary from country to country.**

## DRIVE BELT

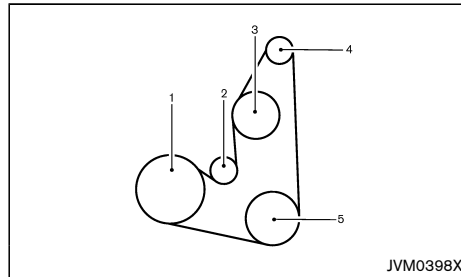

**QR25DE engine**

1. Crankshaft pulley
2. Drive belt auto-tensioner
3. Water pump
4. Alternator
5. Air conditioner compressor

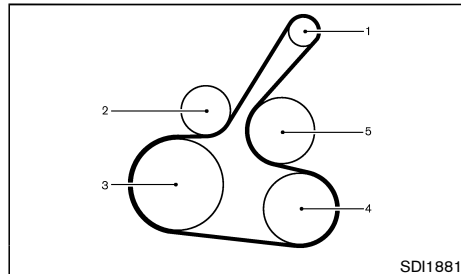

**MR20DD engine**

1. Alternator
2. Drive belt auto-tensioner
3. Crankshaft pulley
4. Air conditioner compressor
5. Water pump

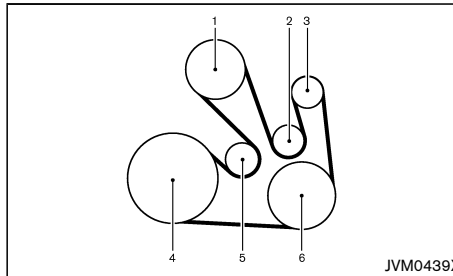

**R9M engine**

1. Water pump
2. Idler pulley
3. Alternator
4. Crankshaft pulley
5. Drive belt auto-tensioner
6. Air conditioner compressor

Be sure the ignition switch is in the "OFF" position.

Visually inspect the belt for signs of unusual wear, cuts, fraying or looseness. Check regularly for condition. If the belt is in poor condition or loose, have it replaced or adjusted by a NISSAN dealer.

## SPARK PLUGS (gasoline engine models)



### WARNING:

**Be sure the engine and ignition switch are off and that the parking brake is applied.**

Replace the spark plugs according to the maintenance log shown in a separate maintenance booklet.

If replacement is required, contact a NISSAN dealer.

### IRIDIUM-TIPPED SPARK PLUGS

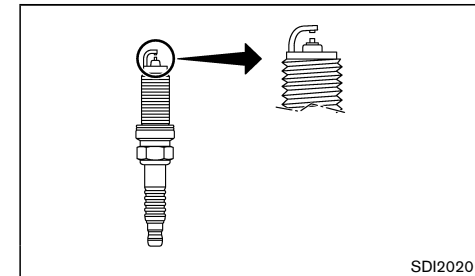

SDI2020

It is not necessary to replace the iridium-tipped spark plugs as frequently as the conventional type of spark plugs. These spark plugs are designed to last much longer than the conventional type of spark plugs.



### CAUTION:

- **Do not reuse the iridium-tipped spark plugs by cleaning or re-gapping.**
- **Always replace with the recommended iridium-tipped spark plugs.**

## 8-14 Maintenance and do-it-yourself

## BRAKES

### CHECKING PARKING BRAKE

#### Pedal type

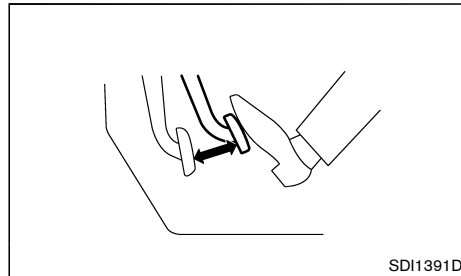

From the released position, depress the parking brake pedal slowly and firmly. If the number of clicks is out of the range listed, see a NISSAN dealer.

**6 to 7 clicks**

**Depressing force 196 N (20 kg, 44 lb)**

#### Switch type

Periodically check the holding ability of the parking brake by parking on a steep hill and restraining the vehicle by using only the parking brake. If it does not hold satisfactorily, see a NISSAN dealer.

### CHECKING FOOT BRAKE PEDAL

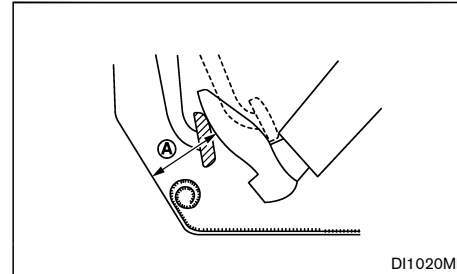

#### WARNING:

**See a NISSAN dealer for a brake system check if the foot brake pedal height does not return to normal.**

With the engine running, check the distance between the upper surface of the pedal and the metal floor. If it is out of the range listed, see a NISSAN dealer.

#### Depressing force

**490 N (50 kg, 110 lb)**

LHD model	RHD model
Ⓐ : 75 mm (3.0 in) or more	Ⓐ : 85 mm (3.3 in) or more

### Self-adjusting brakes

Your vehicle is equipped with self-adjusting brakes. The disc-type brakes self-adjust every time the foot brake pedal is applied.

### Brake pad wear warning

The disc brake pads have audible wear warnings. When a brake pad requires replacement, it will make a high pitched scraping sound when the vehicle is in motion. This scraping sound will first occur only when the brake pedal is depressed. After more wear of the brake pad, the sound will always be heard even if the brake pedal is not depressed. Have the brakes checked as soon as possible if the wear warning sound is heard.

Under some driving or climate conditions, occasional brake squeaks, squeals or other noises may be heard. Occasional brake noise during light to moderate stops is normal and does not affect the function or performance of the brake system.

Proper brake inspection intervals should be followed. For additional information, see a separate maintenance booklet.

### BRAKE BOOSTER

Check the brake booster function as follows:

1. With the engine off, depress and release the foot brake pedal several times. When the brake pedal movement (distance of travel) remains the same from one pedal application to the next, continue on to the next step.
2. While depressing the foot brake pedal, start the engine. The pedal height should drop a little.
3. With the foot brake pedal depressed, stop the engine. Keep the pedal depressed for about 30 seconds. The pedal height should not change.

**Maintenance and do-it-yourself 8-15**

## BRAKE FLUID

4. Run the engine for 1 minute without depressing the foot brake pedal, then turn it off. Depress the foot brake pedal several times. The pedal travel distance will decrease gradually with each depression as the vacuum is released from the booster.

If the brakes do not operate properly, have the brakes checked by a NISSAN dealer.

### WARNING:

- **Use only new fluid from a sealed container. Old, inferior, or contaminated fluid may damage the brake system. The use of improper fluids can damage the brake system and affect the vehicle's stopping ability.**
- **Clean the filler cap before removing.**
- **Brake fluid is poisonous and should be stored carefully in marked containers out of the reach of children.**

### CAUTION:

**Do not spill the fluid on painted surfaces. This will damage the paint. If fluid is spilled, wash it off with plenty of water immediately.**

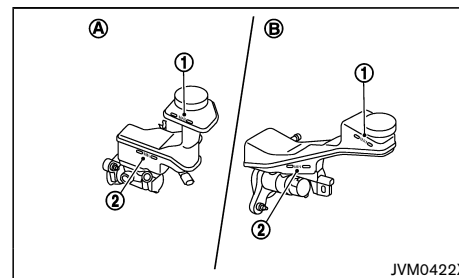

**A** LHD models

**B** RHD models

Check the fluid level in the reservoir. If the fluid is below the MIN line **2**, the brake warning light will illuminate. Add fluid up to the MAX line **1**. (See "Recommended Fluids/lubricants and capacities" (P.9-

2) for recommended types of fluid.)

If the fluid must be added frequently, the system should be thoroughly checked by a NISSAN dealer.

## 8-16 Maintenance and do-it-yourself

## CLUTCH FLUID (if equipped)

### **!** WARNING:

- Use only new fluid from a sealed container. Old, inferior, or contaminated fluid may damage the clutch system.
- Clean the filler cap before removing.
- Clutch fluid is poisonous and should be stored carefully in marked containers out of the reach of children.

### **!** CAUTION:

Do not spill the clutch fluid on painted surfaces. This will damage the paint. If clutch fluid is spilled, wash it off with plenty of water immediately.

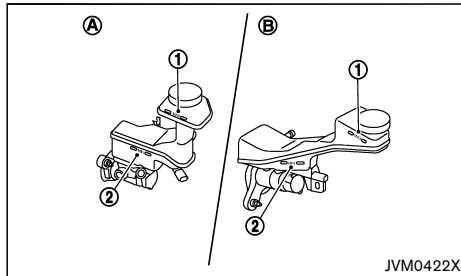

**A** LHD models

**B** RHD models

Check the fluid level in the reservoir. If the fluid is below the MIN line (2), add fluid up to the MAX line (1). (See "Recommended Fluids/lubricants and capacities" (P.9-2) for the recommended types of fluid.)

If the fluid must be added frequently, the clutch system should be thoroughly checked by a NISSAN dealer.

## CONTINUOUSLY VARIABLE TRANSMISSION (CVT) FLUID (if equipped)

Contact a NISSAN dealer if checking or replacement is required.

### **!** CAUTION:

- Use only Genuine NISSAN CVT Fluid NS-3. Do not mix with other fluids.
- Using transmission fluid other than Genuine NISSAN CVT Fluid NS-3 will damage the CVT, which is not covered by the warranty.

## AIR CLEANER FILTER

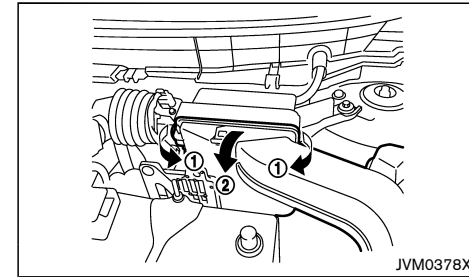

### **!** WARNING:

Operating the engine with the air cleaner filter off can cause you or others to be burned. The air cleaner filter not only cleans the intake air, it also stops flame if the engine backfires. If the air cleaner filter is not installed and the engine backfires, you could be burned. Never drive with the air cleaner filter off. Be cautious working on the engine when the air cleaner filter is off.

To remove the filter, unlatch the retaining clips (1), and pull the cover (2) upward.

The viscous paper type filter element should not be cleaned and reused. The dry paper type filter element may be cleaned and reused. Replace the air filter according to the maintenance log shown in a separate maintenance booklet.

When replacing the air filter, wipe the inside of the air cleaner housing and the cover with a damp cloth.

**Maintenance and do-it-yourself 8-17**

## WIPER BLADES

### WINDSHIELD WIPER BLADES

#### Cleaning

If the windshield does not become clear after using the windshield washer or if the wiper blades chatter when operating the windshield wipers, wax or other materials may be on the windshield and/or wiper blades.

Clean the outside of the windshield surface with a washer solution or mild detergent. Your windshield is clean if beads do not form when rinsing with water.

Clean the blade by wiping it with a cloth soaked in a washer solution or a mild detergent. Rinse the blade with water. If your windshield is still not clear after cleaning the blades and using the wipers, replace the blades.

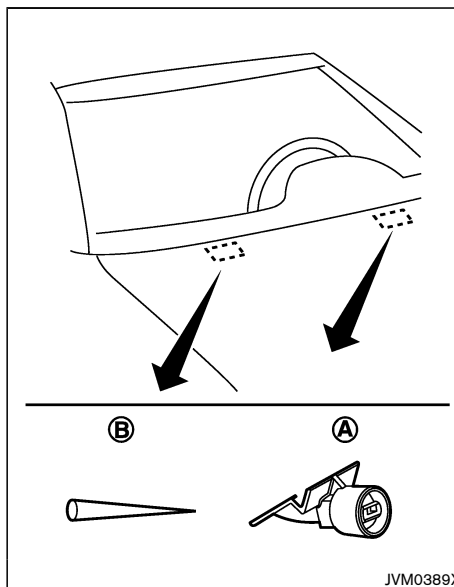

Be careful not to clog the washer nozzle (A). This may cause improper windshield washer operation. If the nozzle is clogged, remove any objects with a needle or small pin (B). Be careful not to damage the nozzle.

## 8-18 Maintenance and do-it-yourself

## Replacing

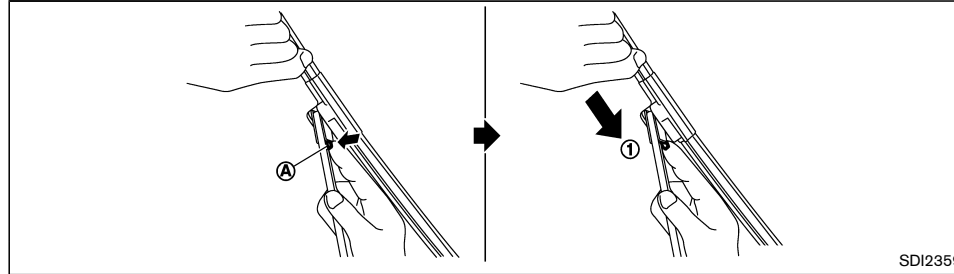

SDI2359

Replace the wiper blades if they are worn.

Before replacing the wiper blades, the wiper should be in the fully up position to avoid scratching the engine hood or damaging the wiper arm. To pull up the wiper arm, see "Wiper and washer switch" (P.2-47).

1. Lift the wiper arm away from the windshield.
2. Push and hold the release tab (A), and then move the wiper blade down the wiper arm to remove ①.
3. Remove the wiper blade.
4. Insert the new wiper blade onto the wiper arm until it clicks into place.

**CAUTION:**

- After wiper blade replacement, return the wiper arm to its original position. Otherwise the wiper arm or the engine hood may be scratched and may cause damage when the engine hood is opened.
- Worn wiper blades can damage the windshield and impair driver vision.

**REAR WINDOW WIPER BLADE**

Contact a NISSAN dealer if checking or replacement is required.

**WINDOW WASHER FLUID**

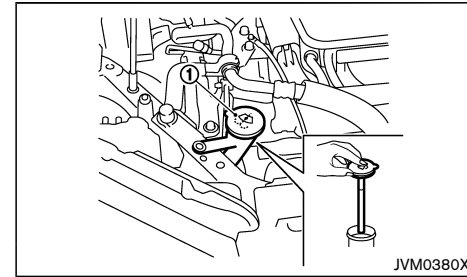

JVM0380X



**WARNING:**







**Anti-freeze is poisonous and should be stored carefully in marked containers out of the reach of children.**

To check the fluid level, use your finger to plug the center hole ① of the cap/tube assembly, then remove it from the reservoir.

If there is no fluid in the tube, add fluid.

Add a washer solvent to the water for better cleaning. In the winter season, add a windshield washer anti-freeze. Follow the manufacturer's instructions for the mixture ratio.

## BATTERY

Caution symbols for battery			⚠ WARNING
①		No smoking, No exposed flames, No sparks	Never smoke around battery. Never expose battery to open flames or electrical sparks.
②		Shield eyes	Handle the battery cautiously. Always wear eye protection glasses to protect against explosion or battery acid.
③		Keep away from children	Never allow children to handle battery. Keep the battery out of the reach of children.
④		Battery acid	Do not allow battery fluid to contact your skin, eyes, fabrics, or painted surfaces. After handling the battery or battery cap, immediately wash your hands thoroughly. If the battery fluid gets into your eyes, or onto your skin or clothing, flush with water immediately for at least 15 minutes and seek medical attention. Battery fluid is acid. If the battery fluid gets into your eyes or onto your skin, it could cause loss of your eyesight or burns.
⑤		Note operating instructions	Before handling the battery, read this instruction carefully to ensure correct and safe handling.
⑥		Explosive gas	Hydrogen gas, generated by battery fluid, is explosive.

SDI1573

## VEHICLE BATTERY



### WARNING:

**Do not operate the vehicle if the fluid in the battery is low. Low battery fluid can cause a higher load on the battery which can generate heat, reduce battery life, and in some cases lead to an explosion.**

## 8-20 Maintenance and do-it-yourself



### Checking battery fluid level

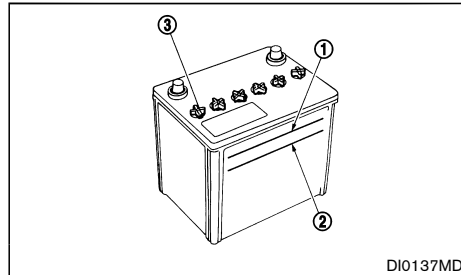

DI0137MD

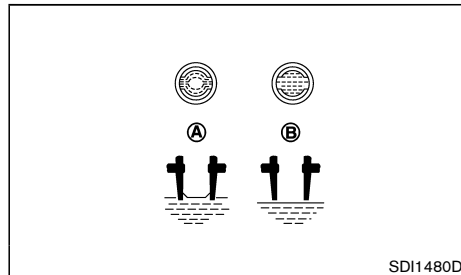

SDI1480D

Check the fluid level in each cell. The battery fluid level should be between the UPPER LEVEL ① and LOWER LEVEL ② lines.

If it is necessary to add fluid, add only demineralized/distilled water to bring the level to the indicator in each filler opening. Do not overfill.

1. Remove the cell plugs ③ (if equipped) using a suitable tool.
2. Add demineralized/distilled water up to the UPPER LEVEL ① line.

If the side of the battery is not clear, check the

distilled water level by looking directly above the cell; the condition ① indicates OK and the condition ② needs more to be added.

3. Replace and tighten the cell plugs.
- Vehicles operated in high temperatures or under severe conditions require frequent checks of the battery fluid level.
  - Keep the battery surface clean and dry. Clean the battery with a solution of baking soda and water.
  - Make certain the terminal connections are clean and securely tightened.
  - If the vehicle is not to be used for more than 30 days, disconnect the negative (-) battery terminal cable to prevent battery discharge.

### Jump starting

If jump starting is necessary, see "Jump starting" (P.6-8). If the engine does not start by jump starting or the battery does not charge, the battery may have to be replaced. Contact a NISSAN dealer for replacing the battery.

### REMOTE CONTROLLER BATTERY

#### Battery replacement



#### CAUTION:

- **Be careful not to allow children to swallow the battery and removed parts.**
- **An improperly disposed battery can harm the environment. Always confirm local regulations for battery disposal.**
- **When changing batteries, do not let dust or oil get on the components.**

- **There is danger of explosion if the lithium battery is incorrectly replaced. Replace only with the same or equivalent type.**

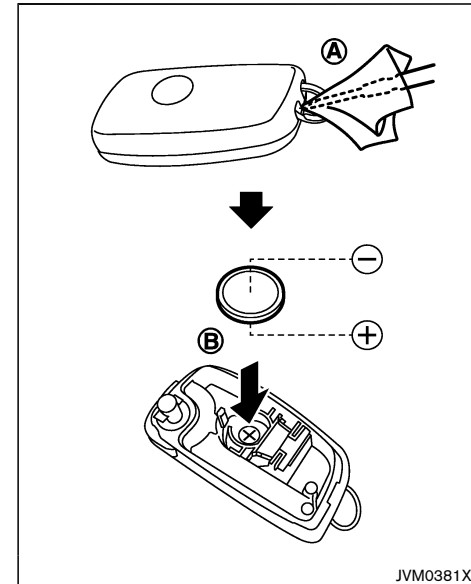

JVM0381X

To replace the battery:

1. Insert a small screwdriver into the slit ① to open the lid. Use a cloth to protect the casing.
2. Replace the battery with a new one.

Recommended battery: CR2032 or equivalent

- Do not touch the internal circuit and electric terminals as doing so could cause a malfunction.

**Maintenance and do-it-yourself 8-21**

- Make sure that the ⊕ side faces the bottom of the case ⊖.
3. Close the lid securely.
  4. Operate the buttons to check its operation.
- See a NISSAN dealer if you need assistance for replacement.

**FCC Notice:****For USA:**

**This device complies with Part 15 of the FCC Rules. Operation is subject to the following two conditions: (1) This device may not cause harmful interference, and (2) this device must accept any interference received, including interference that may cause undesired operation.**

**Note: Changes or modifications not expressly approved by the party responsible for compliance could void the user's authority to operate the equipment.**

**For Canada:**

**This device complies with Industry Canada licence-exempt RSS standard(s). Operation is subject to the following two conditions: (1) this device may not cause interference, and (2) this device must accept any interference, including interference that may cause undesired operation of the device.**

**INTELLIGENT KEY BATTERY****Battery replacement****CAUTION:**

- **Be careful not to allow children to swallow the battery and removed parts.**
- **An improperly disposed battery can harm the environment. Always confirm local regulations for battery disposal.**
- **When changing batteries, do not let dust or oil get on the components.**
- **There is danger of explosion if the lithium battery is incorrectly replaced. Replace only with the same or equivalent type.**

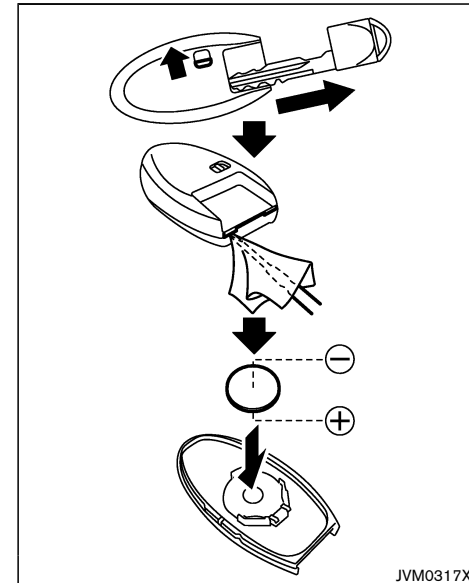

To replace the battery:

1. Release the lock knob at the back of the key and remove the mechanical key. (See "Mechanical key" (P.3-4).)
2. Insert a flat-blade screwdriver wrapped with a cloth into the slit of the corner and twist it to separate the upper part from the lower part.
3. Replace the battery with a new one.
  - Recommended battery: CR2032 or equivalent
  - Do not touch the internal circuit and electric terminals as doing so could cause a malfunction.

- Make sure that the ⊕ side faces the bottom of the case.

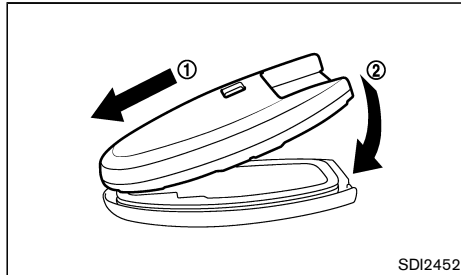

4. Align the tips of the upper and lower parts ①, and then push them together until it is securely closed ②.
5. Operate the buttons to check its operation.

See a NISSAN dealer if you need assistance for replacement.

#### FCC Notice:

##### For USA:

**This device complies with Part 15 of the FCC Rules. Operation is subject to the following two conditions: (1) This device may not cause harmful interference, and (2) this device must accept any interference received, including interference that may cause undesired operation.**

**Note: Changes or modifications not expressly approved by the party responsible for compliance could void the user's authority to operate the equipment.**

##### For Canada:

**This device complies with Industry Canada licence-exempt RSS standard(s). Operation is**

**subject to the following two conditions: (1) this device may not cause interference, and (2) this device must accept any interference, including interference that may cause undesired operation of the device.**

## VARIABLE VOLTAGE CONTROL SYSTEM (if equipped)

The variable voltage control system measures the amount of electrical discharge from the battery and controls voltage generated by the alternator.



#### CAUTION:

- **Do not ground accessories directly to the battery terminal. Doing so will bypass the variable voltage control system and the vehicle battery may not charge completely.**
- **Use electrical accessories with the engine running to avoid discharging the vehicle battery.**

## FUSES

### ENGINE COMPARTMENT

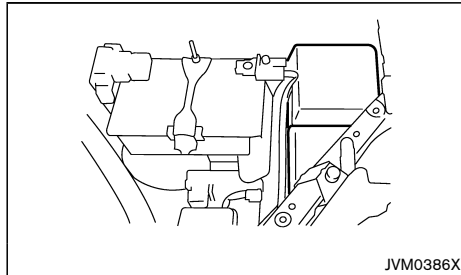

#### CAUTION:

**Never use a fuse of a higher or lower amperage rating than that specified on the fuse box cover. This could damage the electrical system or cause a fire.**

If any electrical equipment does not operate, check for an open fuse.

1. Be sure the ignition switch is in the "OFF" position.
2. Be sure the headlight switch is in the "OFF" position.
3. Open the engine hood.
4. Remove the air cleaner duct. (See "Engine compartment check locations" (P.8-5).)
5. Remove the fuse/fusible link box cover by using a suitable tool and pushing the tab.
6. Locate the fuse that needs to be replaced.

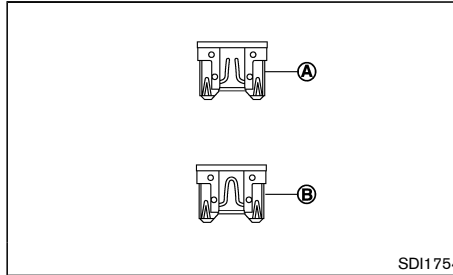

7. Remove the fuse using the fuse puller located in the passenger compartment.
8. If the fuse is open (A), replace it with a new fuse (B).

If the new fuse also opens, after installing, have the electrical system checked, and if necessary repaired, by a NISSAN dealer.

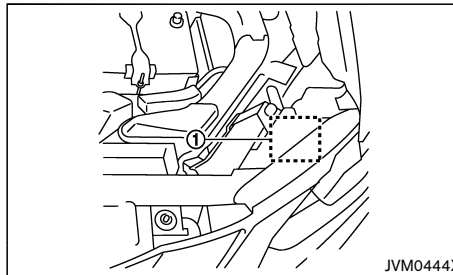

The holder ① also contains the fuses. For checking and/or replacing, see a NISSAN dealer.

### Fusible links

If any electrical equipment does not operate and the fuses are in good condition, check the fusible links. If any of these fusible links are melted, replace only with genuine NISSAN parts.

### PASSENGER COMPARTMENT



#### CAUTION:

**Never use a fuse of a higher or lower amperage rating than that specified on the fuse box cover. This could damage the electrical system or cause a fire.**

If any electrical equipment does not operate, check for an open fuse.

Outer side of the instrument panel

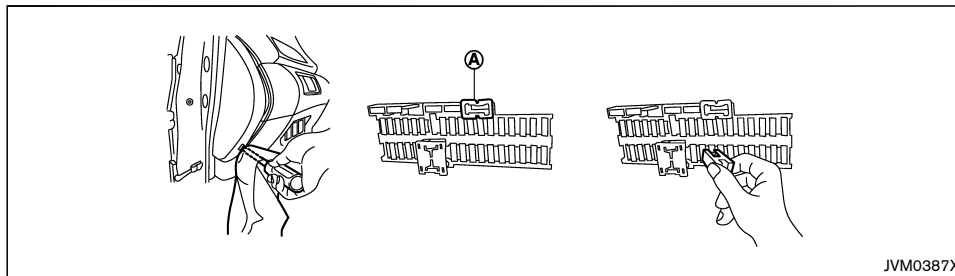

For all LHD model

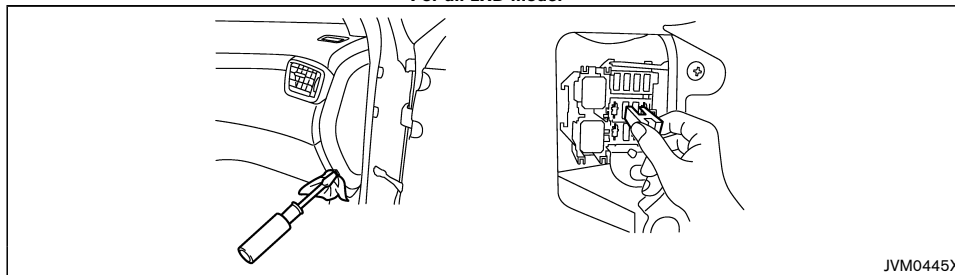

For Stop/Start System or Idling Stop System (if equipped)

1. Be sure the ignition switch is in the "OFF" position.
2. Be sure the headlight switch is in the "OFF" position.
3. Remove the fuse box cover.
4. Locate the fuse that needs to be replaced.
5. Remove the fuse using the fuse puller **A**.

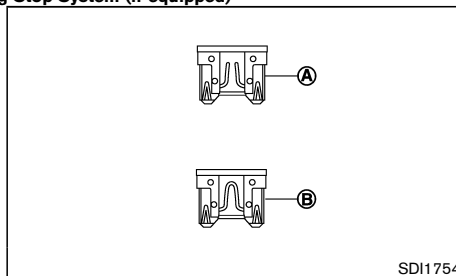

6. If the fuse is open **A**, replace it with a new fuse **B**.

If the new fuse also opens, after installing, have the electrical system checked, and if necessary repaired, by a NISSAN dealer.

## Glove box

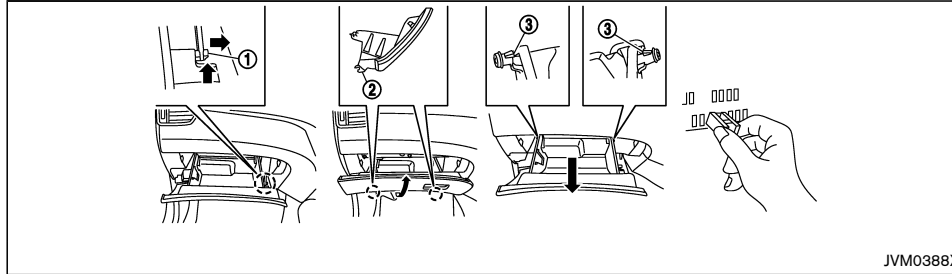

JVM0388X

### RHD model

1. Be sure the ignition switch is in the "OFF" position.
2. Be sure the headlight switch is in the "OFF" position.
3. Open the glove box and unlock the damper ①.
4. Hold the glove box lid so that the distance between the upper end of the lid and the dashboard is about 5 cm (2 in), and then pull off the hinges ② located on the underside of the lid.
5. Unlock the left and right stoppers ③ and remove the glove box lid.
6. Locate the fuse that needs to be replaced.
7. Remove the fuse using the fuse puller.

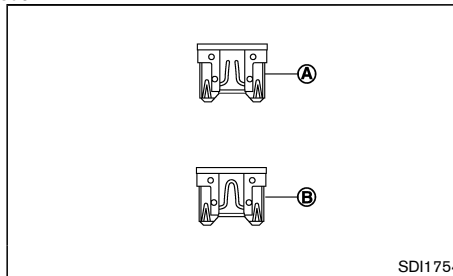

SDI1754

8. If the fuse is open (A), replace it with a new fuse (B).

If the new fuse also opens, after installing, have the electrical system checked, and if necessary repaired, by a NISSAN dealer.

## Extended storage fuse switch

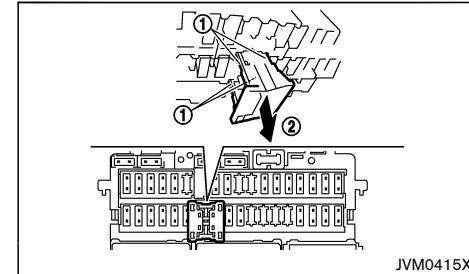

JVM0415X

### Example

To reduce battery drain, the extended storage fuse switch comes from the factory switched off. Prior to delivery of your vehicle, the switch is pushed in (switched on) and should always remain on.

If the extended storage fuse switch is not pushed in (switched on), the "Shipping Mode On Push Storage Fuse" warning may appear in the vehicle information display. See "Vehicle information display warnings and indicators" (P.2-28).

If any electrical equipment does not operate, remove the extended storage fuse switch and push it in again.

### NOTE:

**If the extended storage fuse switch malfunctions, see a NISSAN dealer.**

### How to remove the extended storage fuse switch:

1. To remove the extended storage fuse switch, be sure the ignition switch is in the "OFF" or "LOCK" position.
2. Be sure the headlight switch is in the "OFF" position.

## 8-26 Maintenance and do-it-yourself

3. Remove the fuse box cover.
4. Pinch the locking tabs ① found on each side of the extended storage fuse switch.
5. Pull the extended storage fuse switch straight out from the fuse box ②.

**How to remove the extended storage fuse switch:**

1. To remove the extended storage fuse switch, be sure the ignition switch is in the "OFF" or "LOCK" position.
2. Be sure the headlight switch is in the "OFF" position.
3. Remove the fuse box cover.
4. Pinch the locking tabs ① found on each side of the extended storage fuse switch.
5. Pull the extended storage fuse switch straight out from the fuse box ②.

## LIGHTS

### HEADLIGHTS

#### LED headlight bulb

If replacement is required, contact a NISSAN dealer.

#### Halogen headlight bulb

The halogen headlight is a semi-sealed beam type which uses replaceable headlight (halogen) bulbs. They can be replaced from inside the engine compartment without removing the headlight assembly.



**CAUTION:**

**High-pressure halogen gas is sealed inside the bulb. The bulb may break if the glass envelope is scratched or the bulb is dropped.**

#### Low-beam:

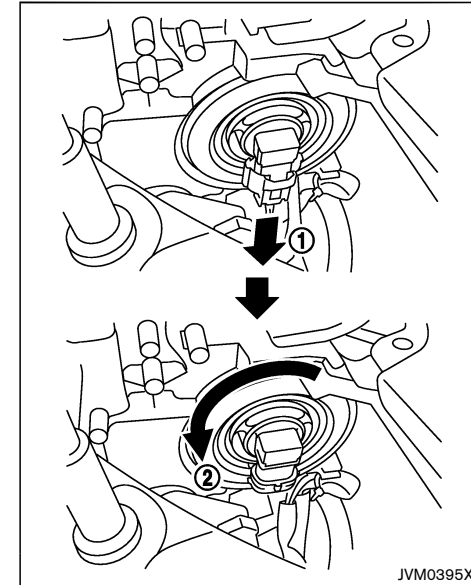

1. Disconnect the battery negative cable.
2. Disconnect the electrical connector ① from the rear end of the bulb.
3. Remove the headlight bulb ② by turning it counter clockwise. Do not shake or rotate the bulb when removing it.
4. Install the new bulb in the reverse order of removal.

**Maintenance and do-it-yourself 8-27**

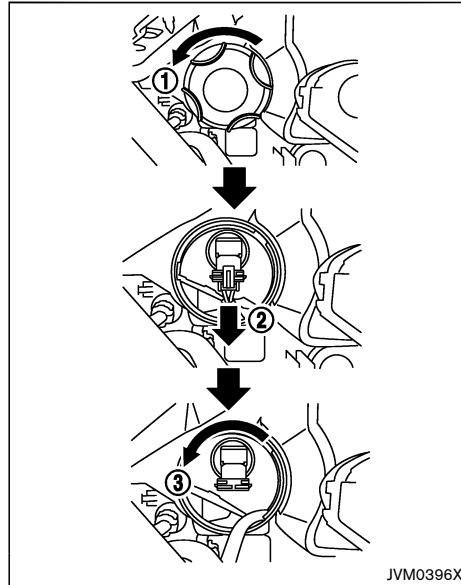
**High-beam:**

1. Disconnect the battery negative cable.
2. Turn the cover ① counter clockwise and remove the cover.
3. Disconnect the electrical connector ② from the rear end of the bulb.
4. Remove the headlight bulb ③ by turning it counter clockwise. Do not shake or rotate the bulb when removing it.
5. Install the new bulb in the reverse order of removal.

**CAUTION:**

- When handling the bulb, do not touch the glass envelope.
- Use the same number and wattage as originally installed:

**Halogen headlight model****High beam bulb: 65W (H9)****Low beam bulb: 55W (H11)**

- Do not leave the bulb out of the headlight reflector for a long period of time as dust, moisture and smoke may enter the headlight body and affect the performance of the headlight.

Aiming adjustment is not necessary if only the bulbs are replaced. When aiming adjustment is necessary, contact a NISSAN dealer.

Fog may temporarily form inside the lens of the exterior lights in the rain or in a car wash. A temperature difference between the inside and the outside of the lens causes the fog. This is not a malfunction. If large drops of water collect inside the lens, contact a NISSAN dealer.

**EXTERIOR LIGHTS**

Item	Wattage (W)
Front turn signal light	21
Front clearance light/Daytime running light*	LED
Front fog light (if equipped)	55
Side turn signal light*	LED
Rear combination light	
Turn signal	21
Stop	21
Tail light	5
Reverse light	16
Rear fog light (if equipped)	21
High-mounted stop light*	LED
License plate light	5

\*: See a NISSAN dealer for replacement.

**8-28 Maintenance and do-it-yourself**



### INTERIOR LIGHTS

Item	Wattage (W)
Map lights	LED
Vanity mirror light	1.8
Console light	LED
Room light (if equipped)	8
Rear personal light (if equipped)	8
Luggage room light	5

## LIGHT LOCATIONS

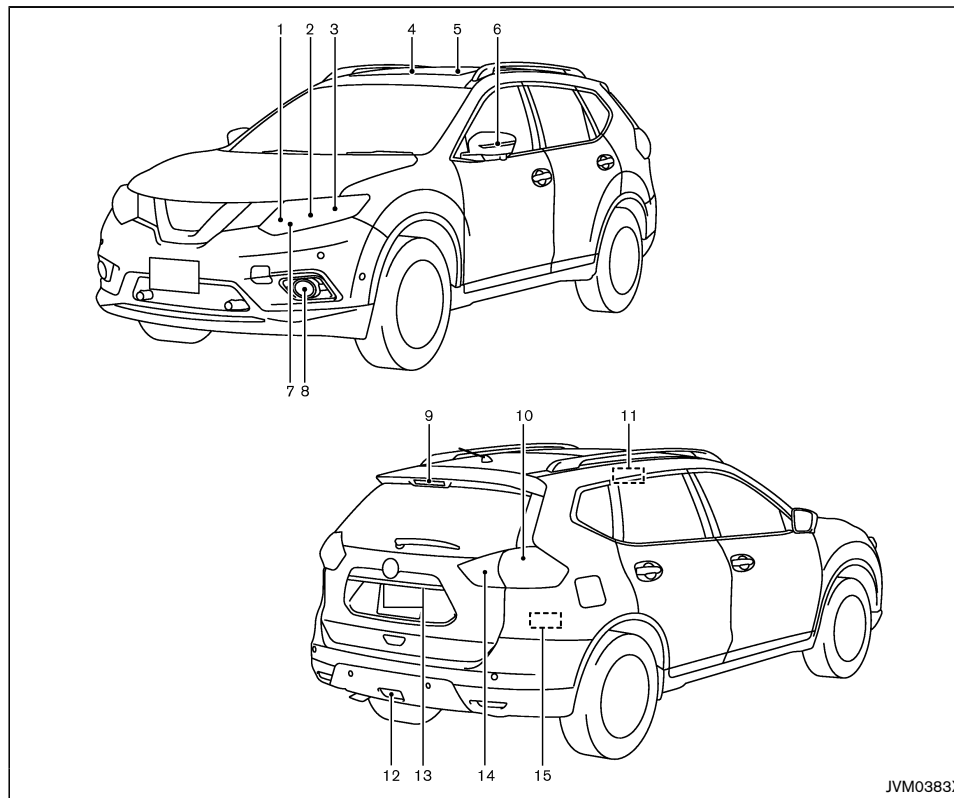

1. Front turn signal light
2. Headlight (high-beam)
3. Headlight (low-beam)
4. Front map light
5. Room light (if equipped)
6. Side turn signal light
7. Clearance light/Daytime running light
8. Front fog light (if equipped)
9. High-mounted stop light
10. Rear combination light (tail light, stop light, rear turn signal light)
11. Rear personal light (if equipped)
12. Rear fog light (if equipped)
13. License plate light
14. Reverse light/Tail light
15. Luggage room light

## 8-30 Maintenance and do-it-yourself

### Replacement procedures

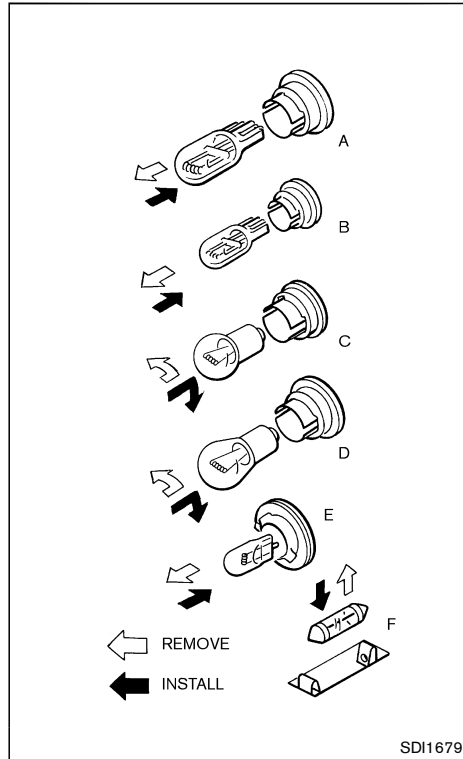

⇨: REMOVE  
 ⇦: INSTALL

All other lights are either type A, B, C, D, E or F. When replacing a bulb, first remove the lens and/or cover.

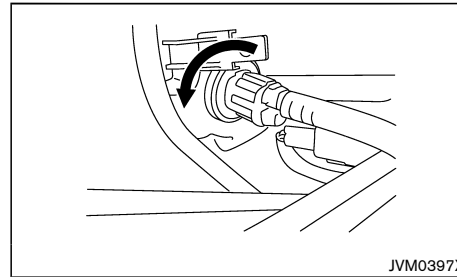

Front turn signal light

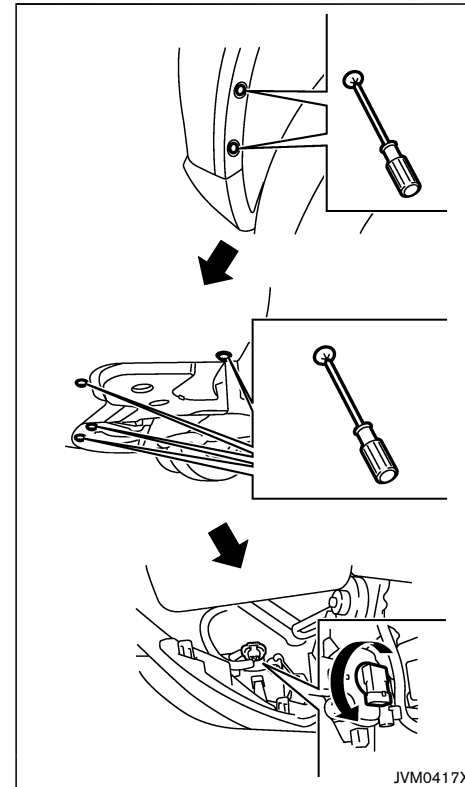

Front fog light (if equipped)

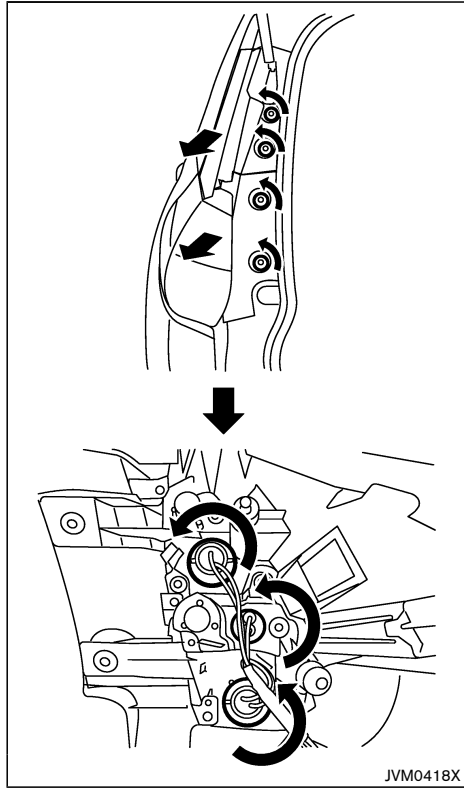

Rear combination light

JVM0418X

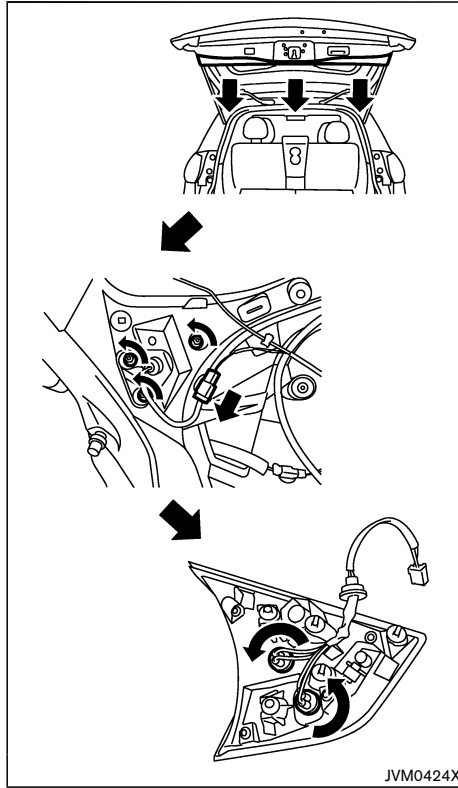

Reverse light/Tail light

JVM0424X

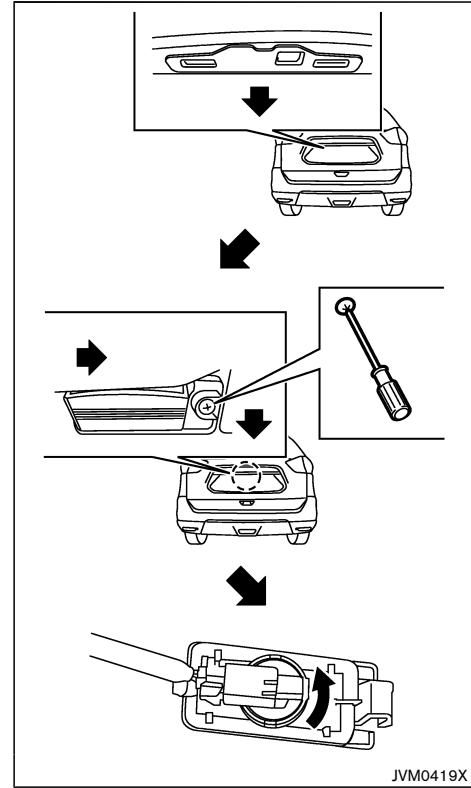

License plate light

JVM0419X

8-32 Maintenance and do-it-yourself

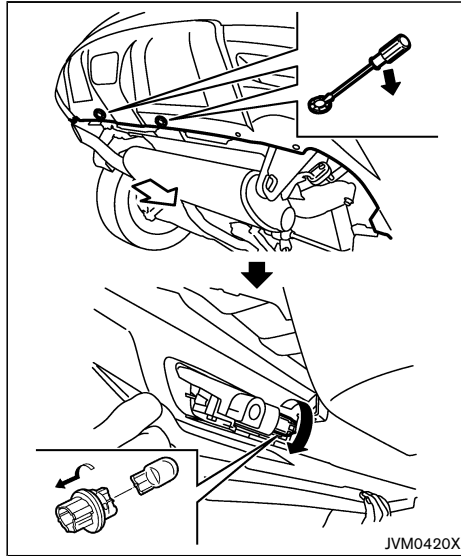

Rear fog light (if equipped)

JVM0420X

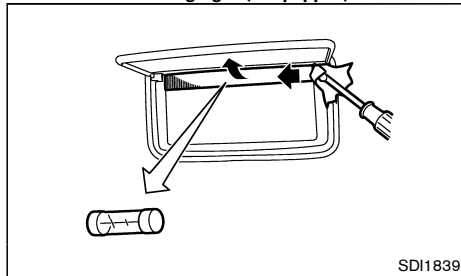

Vanity mirror light

SDI1839

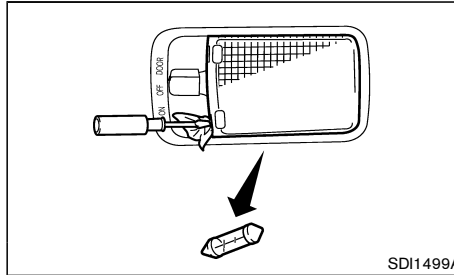

Room light (if equipped)

SDI1499A

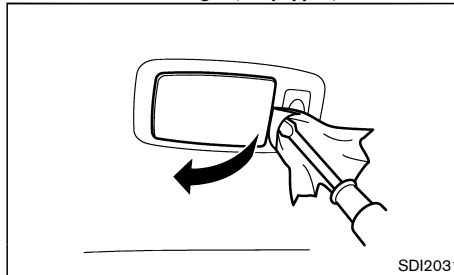

Rear personal light (if equipped)

SDI2031

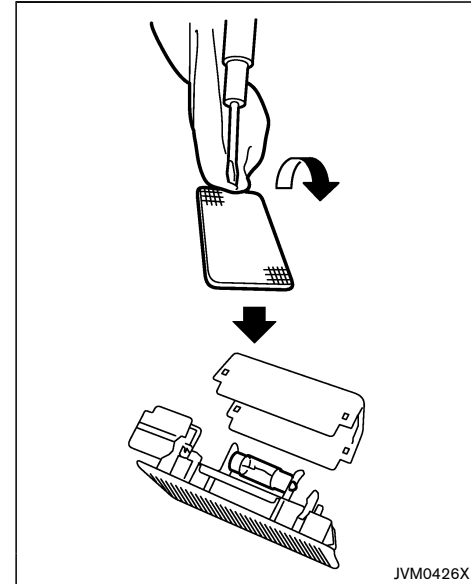

Luggage room light

JVM0426X

**LEGAL REQUIREMENT TO ADJUST HEADLIGHT BEAM**

When the vehicle is driven in a country where the driving lane is different to your home country, affix an opaque sticker on the headlight.

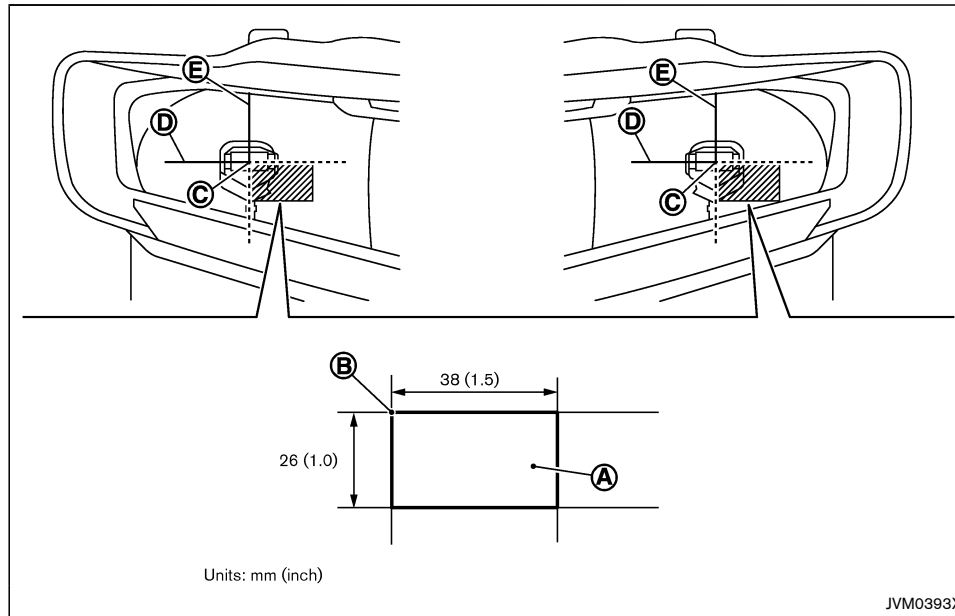

**Left-Hand Drive (LHD) model**

### 8-34 Maintenance and do-it-yourself

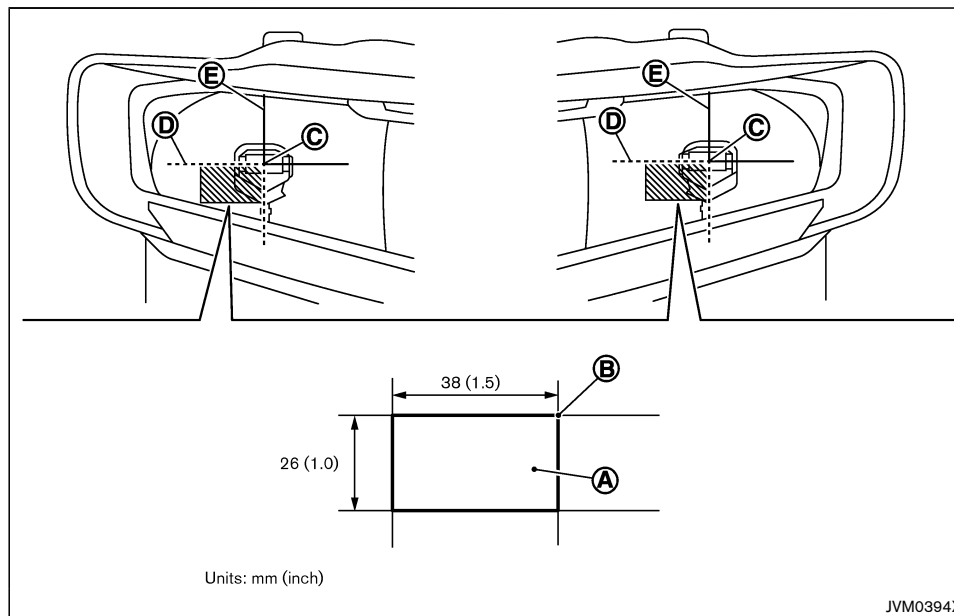
**NOTE:**

Align the mark **C** with the center mark  of the headlight bulb.

**Right-Hand Drive (RHD) model**

1. Place the ignition switch in the "OFF" position and wait until the headlights cool down.
2. Prepare the stickers referring to the figure. Make the stickers **A** that will be affixed to the surface of the right side headlight and the left side headlight.
3. Affix the sticker by aligning the corner **B** of the sticker with the position of the mark **C** that is located on the surface of the headlight seen from front.

- **Note that other transparent materials do not work effectively.**

**NOTE:**

- **Use an opaque material that prevents the light from passing through it.**

Affix the sticker as illustrated by aligning the mark **C** with dividing lines **D** and **E**.

## TIRES AND WHEELS

If you have a flat tire, see "Flat tire" (P.6-2).

### TIRE PRESSURE MONITORING SYSTEM (TPMS) (if equipped)

The Tire Pressure Monitoring System (TPMS) monitors tire pressure of all tires except the spare. When the low tire pressure warning light is lit, one or more of your tires is significantly under-inflated.

The TPMS will activate only when the vehicle is driven at speeds above 25 km/h (16 MPH). Also, this system may not detect a sudden drop in tire pressure (for example a flat tire while driving).

For more details about the TPMS, see "Tire Pressure Monitoring System (TPMS)" (P.6-2), "Tire Pressure Monitoring System (TPMS)" (P.5-4) and "Tire Pressure Monitoring System (TPMS)" (P.8-36).

For additional information, see "Low tire pressure warning light" (P.2-14).

### TIRE INFLATION PRESSURE

Periodically check the pressure of the tires, including the spare. An incorrect tire pressure may adversely affect tire life and vehicle handling. The tire pressure should be checked when tires are COLD. Tires are considered COLD after the vehicle has been parked for 3 or more hours, or driven less than 1.6 km (1 mile). COLD tire pressures are shown on the tire placard.

Insufficient pressure can lead to an overheating of the tire and subsequent internal damage. At high speeds, this could result in tread separation and even bursting of the tire.

### TYPES OF TIRES



#### CAUTION:

**When changing or replacing tires, be sure all four tires are of the same type (that is, summer, all season or snow) and construction. A NISSAN dealer may be able to help you with information about tire type, size, speed rating and availability.**

Replacement tires may have a lower speed rating than the factory equipped tires, and they may not match the potential maximum vehicle speed. Never exceed the maximum speed rating of the tire.

#### All season tires

NISSAN specifies all season tires on some models to provide good performance all year, including snowy and icy road conditions. All season tires are identified by ALL SEASON and/or M&S on the tire sidewall. Snow tires have better snow traction than all season tires and may be more appropriate in some areas.

#### Summer tires

NISSAN specifies summer tires on some models to provide superior performance on dry roads. Summer tire performance is substantially reduced in snow and ice. Summer tires do not have the tire traction rating M&S on the tire sidewall.

If you plan to operate your vehicle in snowy or icy conditions, NISSAN recommends the use of snow or all season tires on all four wheels.

#### Snow tires

If snow tires are needed, it is necessary to select tires equivalent in size and load rating to the original equipment tires. If you do not, it can adversely affect the safety and handling of your vehicle.

Generally, snow tires have lower speed ratings than factory equipped tires and may not match the potential maximum vehicle speed. Never exceed the maximum speed rating of the tire. If you install snow tires, they must be the same size, brand, construction and tread pattern on all four wheels.

For additional traction on icy roads, studded tires may be used. However, some states and provinces prohibit their use. Check local, state and provincial laws before installing studded tires. Skid and traction capabilities of studded snow tires on wet or dry surfaces may be poorer than that of non-studded snow tires.

### TIRE CHAINS

Use of tire chains may be prohibited according to location. Check the local laws before installing tire chains. When installing tire chains, make sure that they are of proper size for the tires on your vehicle and are installed according to the chain manufacturer's instructions.

Use chain tensioners when recommended by the tire chain manufacturer to ensure a tight fit. Loose end links of the tire chains must be secured or removed to prevent the possibility of whipping action damage to the fenders or underbody. If possible, avoid fully loading your vehicle when using tire chains. In addition, drive at a reduced speed. Otherwise, your vehicle may be damaged and/or vehicle handling and performance may be adversely affected.

## 8-36 Maintenance and do-it-yourself



**Tire chains must be installed only on the front wheels and not on the rear wheels. Do not use the chains on dry roads.**

Never install tire chains on a Temporary-use spare tire (TEMPORARY USE ONLY) (if equipped).

Do not drive with tire chains on paved roads which are clear of snow. Driving with chains in such conditions can cause damage to the various mechanisms of the vehicle due to some overstress.

### TIRE ROTATION

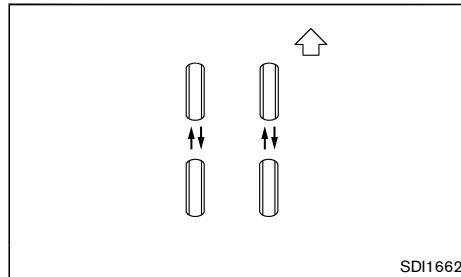

NISSAN recommends that tires be rotated every 5,000 km (3,000 miles) for Four-Wheel Drive (4WD) or every 10,000 km (6,000 miles) for Two-Wheel Drive (2WD) model. However, the timing for tire rotation may vary according to your driving habits and the road surface conditions. (See "Flat tire" (P.6-2) for the tire replacement.)

#### **WARNING:**

- **After rotating the tires, adjust the tire pressure.**
- **Retighten the wheel nuts when the vehicle has been driven for 1,000 km (600 miles)**

(also in cases of a flat tire, etc.).

- **Do not include the spare tire in tire rotation.**
- **Incorrect tire selection, fitting, care, or maintenance can affect vehicle safety with risk of accident and injury. If in doubt, consult a NISSAN dealer or the tire manufacturer.**

For models equipped with Tire Pressure Monitoring System (TPMS)

After the tires are rotated, the TPMS must be reset. See "Tire Pressure Monitoring System (TPMS)" (P.5-4) for details about the resetting procedure.

### TIRE WEAR AND DAMAGE

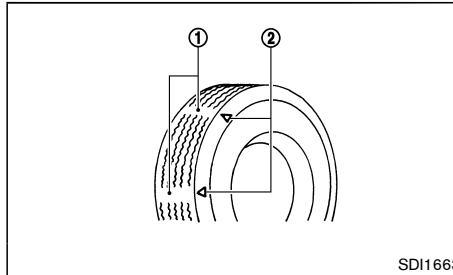

- ① Wear indicator
- ② Wear indicator location mark

Tires should be periodically inspected for wear, cracking, bulging or objects caught in the tread. If excessive wear, cracks, bulging or deep cuts are found, the tire should be replaced immediately.

The original tires have a built-in tread wear indicator. When the wear indicator is visible, the tire should be replaced.

Improper service of a spare tire may result in serious personal injury. If it is necessary to repair the spare tire, contact a NISSAN dealer.

### TIRE AGE

Never use a tire over six years old, regardless of whether it has been used or not.

Tires degrade with age as well as with the vehicle usage. Have your tires checked and balanced often by a repair shop or, if you prefer, a NISSAN dealer.

### CHANGING TIRES AND WHEELS



#### **WARNING:**

**Do not install a deformed wheel or tire even if it has been repaired. Such wheels or tires could have structural damage and could fail without warning.**

When replacing a tire, use the same size, speed rating and load carrying capacity as originally equipped. (See "Tires and wheels" (P.9-7) for recommended types and sizes of tires and wheels.) The use of tires other than those recommended or the mixed use of tires of different brands, construction (bias, bias-belted, or radial), or tread patterns can adversely affect the ride, braking, handling, ground clearance, body-to-tire clearance, snow chain clearance, Tire Pressure Monitoring System (TPMS), speedometer calibration, headlight aim and bumper height. Some of these effects may lead to accidents and could result in serious personal injury.

If the wheels are changed for any reason, always replace with wheels which have the same offset dimension. Wheels of a different offset could cause early tire wear, possibly degraded vehicle handling characteristics and/or interference with the brake

### Maintenance and do-it-yourself 8-37

discs/drums. Such interference can lead to decreased braking efficiency and/or early brake pad/shoe wear. Confirm the following for the TPMS (if equipped).

**WARNING:**

- After a tire or a wheel is replaced, the TPMS must be reset. (See “Tire Pressure Monitoring System (TPMS)” (P.6-2), “Tire Pressure Monitoring System (TPMS)” (P.5-4) and “Tire Pressure Monitoring System (TPMS)” (P.8-36) for details about the resetting procedure.)
- When a spare tire is mounted or a wheel is replaced, the TPMS will not function and the low tire pressure warning light will flash for approximately 1 minute. The light will remain on after 1 minute. Contact a NISSAN dealer as soon as possible for tire replacement and/or system resetting.
- Replacing tires with those not originally specified by NISSAN could affect the proper operation of the TPMS.

Four-Wheel Drive (4WD) model

**CAUTION:**

**Always use tires of the same size, brand, construction (bias, bias-belted or radial), and tread pattern on all four wheels. Failure to do so may result in a circumference difference between tires on the front and rear axles which will cause excessive tire wear and may damage the transmission, transfer case and differential gears.**

Only use spare tires specified for each 4WD model.

## 8-38 Maintenance and do-it-yourself

### WHEEL BALANCE

Unbalanced wheels may affect vehicle handling and tire life. Even with regular use, wheels can get out of balance. Therefore, they should be balanced as required.

### SPARE TIRE (if equipped)

#### Temporary-use spare tire (if equipped)

The spare tire supplied with your vehicle varies depending on the model. See “Tires and wheels” (P.9-7) for applicable spare tire.

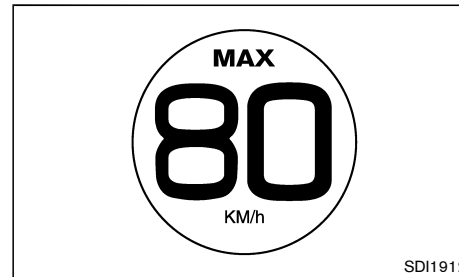

#### Spare tire label (if equipped)

A temporary-use spare tire (different size from the original tire) is supplied with your vehicle.

Observe the following precautions if the spare tire must be used, otherwise your vehicle could be damaged or involved in an accident.

When a spare tire is mounted, the Tire Pressure Monitoring System (TPMS) (if equipped) will not function.

**CAUTION:**

- The spare tire should be used only for emergency. It should be replaced by the standard tire at the first opportunity.
- Drive carefully while the spare tire is installed.
- Avoid sharp turns and abrupt braking while driving.
- Periodically check the T-type spare tire inflation pressure, and always keep it at 420 kPa (4.2 kgf/cm<sup>2</sup>, 60 psi). (T155/90 D17 tire)
- Periodically check the spare tire inflation pressure, and always keep it at 300 kPa (3.0 kgf/cm<sup>2</sup>, 44psi). (225/65 R17 tire)
- Do not drive your vehicle at speeds faster than 80 km/h (50 MPH).
- Do not use tire chains on a spare tire. Tire chains will not fit properly on the spare tire and may cause damage to the vehicle.
- Because the spare tire is smaller than the original tire, ground clearance is reduced. To avoid damage to the vehicle do not drive over obstacles. Also do not drive the vehicle through an automatic car wash since it may get caught.
- Do not use the spare tire on other vehicles.
- Do not use more than one spare tire at the same time.
- Do not tow a trailer while the spare tire is installed.

**Conventional spare tire (if equipped)**

A standard tire (the same size as the original tire) is supplied with your vehicle.

**MEMO**

**8-40 Maintenance and do-it-yourself**

Condition: 'Except for China'

[ Edit: 2014/ 11/ 7 Model: T32-A ]

## 9 Technical information

Recommended Fluids/lubricants and capacities .....	9-2	Uniform tire quality grading (if equipped) .....	9-10
Fuel information .....	9-4	Treadwear .....	9-10
Recommended SAE viscosity number .....	9-4	Traction AA, A, B and C .....	9-10
Air conditioner system refrigerant and lubricant .....	9-5	Temperature A, B and C .....	9-10
Engine .....	9-6	Radio approval number and information .....	9-10
Tires and wheels .....	9-7	For Europe .....	9-10
Dimensions .....	9-7	For Mexico .....	9-12
When travelling or registering in another country .....	9-8	For Abu Dhabi .....	9-12
Vehicle identification .....	9-8	For Morocco .....	9-13
Vehicle identification plate .....	9-8	For South Africa .....	9-13
Vehicle Identification Number (VIN) plate (if equipped) .....	9-8	For Panama .....	9-14
Vehicle identification number (chassis number) .....	9-8	For Jordan .....	9-14
Engine serial number .....	9-9	For Paraguay .....	9-14
Certification label (if equipped) .....	9-9	For Uruguay .....	9-14
Tire placard .....	9-9	For Surinam .....	9-15
Air conditioner specification label .....	9-9	For Jamaica .....	9-15
		For the Middle East .....	9-15
		For Indonesia .....	9-16

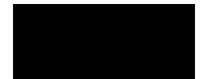

## RECOMMENDED FLUIDS/ LUBRICANTS AND CAPACITIES

The following are approximate capacities. The actual refill quantities may be slightly different. When refilling, follow the procedures instructed in the "8. Maintenance and do-it-yourself" section to determine the proper refill capacity.

			Capacity (Approximate)		Recommended Fluids and Lubricants	
			Liter	Imp measure		
Fuel			60	13-1/4 gal	See "Fuel information" (P.9-4).	
Engine oil* Drain and refill	QR25DE	With oil filter change	4.6	4 qt	Gasoline engine: Except for Kazakhstan, Ukraine and South Africa <ul style="list-style-type: none"> <li>• Genuine NISSAN engine oil</li> <li>• API grade: SL, SM or SN</li> <li>• ILSAC grade: GF-3, GF-4 or GF-5</li> </ul> For Kazakhstan, Ukraine and South Africa <ul style="list-style-type: none"> <li>• Genuine NISSAN engine oil</li> <li>• API grade: SL, SM or SN</li> <li>• ILSAC grade: GF-3, GF-4 or GF-5</li> <li>• ACEA A1/B1, A3/B3, A3/B4, A5/B5, C2 or C3</li> </ul> Diesel engine: With Diesel Particulate filter <ul style="list-style-type: none"> <li>• Genuine NISSAN engine oil</li> <li>• ACEA C4 LOW SAPS, Viscosity SAE 5W-30</li> </ul> Without Diesel Particulate filter <ul style="list-style-type: none"> <li>• Genuine NISSAN engine oil</li> <li>• ACEA A3/B4, Viscosity SAE 5W-30</li> </ul> For additional information, see "Recommended SAE viscosity number" (P.9-4).	
		Without oil filter change	4.3	3-3/4 qt		
	MR20DD	With oil filter change	3.8	3-3/8 qt		
		Without oil filter change	3.6	3-1/8 qt		
	R9M	With oil filter change	5.5	4-7/8 qt		
		Without oil filter change	5.1	4-1/2 qt		
Cooling system (with reservoir)	Total	QR25DE	Except for the Middle East and South Africa	8.2	7-1/4 qt	For Europe: <ul style="list-style-type: none"> <li>• Genuine NISSAN Engine Coolant or equivalent in its quality*</li> </ul> Except for Europe: <ul style="list-style-type: none"> <li>• Genuine NISSAN Engine Coolant (blue) or equivalent*</li> </ul> * Use Genuine NISSAN Engine Coolant, or equivalent in its quality, in order to avoid possible aluminum corrosion within the engine cooling system caused by the use of non-genuine engine coolant. <b>Note that any repairs for the incidents within the engine cooling system while using non-genuine engine coolant may not be covered by the warranty even if such incidents occurred during the warranty period.</b>
			For the Middle East and South Africa	9.0	7-7/8 qt	
		MR20DD	MT model	8.5	7-1/2 qt	
			CVT model	8.7	7-5/8 qt	
	R9M	MT model	7.9	7 qt		
		CVT model	8.1	7-1/8 qt		
	Reservoir	QR25DE and MR20DD	—	0.85	3/4 qt	
		R9M	—	0.57	1/2 qt	
Differential gear oil			—	—	<ul style="list-style-type: none"> <li>• Genuine NISSAN Differential Oil Hypoid Super GL-5 80W-90 or API GL-5, Viscosity SAE 80W-90</li> </ul>	
Transfer oil			—	—	<ul style="list-style-type: none"> <li>• Genuine NISSAN Differential Oil Hypoid Super GL-5 80W-90 or API GL-5, Viscosity SAE 80W-90</li> </ul>	

### 9-2 Technical information

	Capacity (Approximate)		Recommended Fluids and Lubricants
	Liter	Imp measure	
Continuously Variable Transmission (CVT) fluid	—	—	<ul style="list-style-type: none"> <li>Genuine NISSAN CVT Fluid NS-3</li> <li><b>Use only Genuine NISSAN CVT Fluid NS-3. Using transmission fluid other than Genuine NISSAN CVT Fluid NS-3 will damage the CVT, which is not covered by the warranty.</b></li> </ul>
Manual Transmission (MT) gear oil	—	—	<p>R9M engine:</p> <ul style="list-style-type: none"> <li><b>Genuine NISSAN Manual Transmission Fluid (MTF) HQ Multi 75W-85 or equivalent</b></li> <li>If Genuine NISSAN Manual Transmission Fluid (MTF) HQ Multi 75W-85 is hard to obtain, API GL-4, Viscosity SAE 75W-85 may be used as a temporary replacement. However, use Genuine NISSAN gear oil as soon as it is available.</li> </ul> <p>MR20DD engine:</p> <p>For Europe</p> <ul style="list-style-type: none"> <li><b>Genuine NISSAN gear oil (Nissan MT-XZ Gear Oil TL/JR type) 75W-80, or equivalent</b></li> <li>If Genuine NISSAN gear oil (Nissan MT-XZ Gear Oil TL/JR type) is not available, API GL-4+, Viscosity SAE 75W-80 may be used as a temporary replacement. However, use Genuine NISSAN gear oil (Nissan MT-XZ Gear Oil TL/JR Type) as soon as it is available.</li> </ul> <p>Except for Europe</p> <ul style="list-style-type: none"> <li><b>Genuine NISSAN Manual Transmission Fluid (MTF) Chevron-Texaco ETL8997B 75W-80 or equivalent.</b></li> <li>If Genuine NISSAN Manual Transmission Fluid (MTF) Chevron Texaco ETL8997B is not available, API GL-4, Viscosity SAE 75W-80 may be used as a temporary replacement. However, use Genuine NISSAN Manual Transmission Fluid (MTF) Chevron Texaco ETL8997B as soon as it is available.</li> </ul>
Brake and clutch fluid	Refill to the proper fluid level according to the instructions in the "8. Maintenance and do-it-yourself" section.		<p>Except for Europe, Ukraine and Kazakhstan</p> <ul style="list-style-type: none"> <li>Genuine NISSAN Brake Fluid or equivalent DOT3</li> </ul> <p>For Europe, Ukraine and Kazakhstan</p> <ul style="list-style-type: none"> <li>Genuine NISSAN Brake Fluid, or equivalent DOT3 or DOT 4</li> </ul>
Multi-purpose grease	—	—	NLGI No. 2 (Lithium soap base)
Air conditioner system refrigerant	—	—	<p>For Europe:</p> <ul style="list-style-type: none"> <li>HFO-1234yf (R-1234yf)</li> </ul> <p>Except for Europe:</p> <ul style="list-style-type: none"> <li>HFC-134a (R-134a)</li> </ul>
Air conditioner system lubricants	—	—	<p>For Europe:</p> <ul style="list-style-type: none"> <li>ND-OIL12</li> </ul> <p>Except for Europe:</p> <ul style="list-style-type: none"> <li>ND-OIL8</li> </ul>

\* For additional information, see "Changing engine oil and oil filter" (P.8-10)

## FUEL INFORMATION

Gasoline engine (model with three-way catalyst)



### CAUTION:

**Do not use leaded gasoline. Using leaded gasoline will damage the three-way catalyst.**

### QR25DE engine model:

For Thailand:

Use UNLEADED REGULAR gasoline or gasohol (up to E20\*) with an octane rating of at least 91 (RON).

\*: Gasohol is alcohol blended gasoline. For example, "E20" is a mixture of approximately 20% fuel ethanol and 80% unleaded gasoline.

For Mexico:

Use UNLEADED REGULAR gasoline with an octane rating of at least 87 AKI (Anti-Knock index) number (Research octane number 91).

Except for Thailand and Mexico:

Use UNLEADED REGULAR gasoline with an octane rating of at least 91 (RON).

### MR20DD engine model:

For Thailand:

Use UNLEADED REGULAR gasoline or gasohol (up to E20\*) with an octane rating of at least 91 (RON).

\*: Gasohol is alcohol blended gasoline. For example, "E20" is a mixture of approximately 20% fuel ethanol and 80% unleaded gasoline.

Except for Thailand:

Use UNLEADED REGULAR gasoline with an octane rating of at least 91 (RON).

## 9-4 Technical information

### Diesel engine\*

Diesel fuel above 51 cetane and with less than 10 ppm of sulphur (EN590) must be used.

\* If two types of diesel fuel are available, use summer or winter fuel properly according to the following temperature conditions.

- Above  $-7^{\circ}\text{C}$  ( $20^{\circ}\text{F}$ ) ... Summer type diesel fuel.
- Below  $-7^{\circ}\text{C}$  ( $20^{\circ}\text{F}$ ) ... Winter type diesel fuel.



### CAUTION:

- **Do not use home heating oil, gasoline or other alternate fuels in your diesel engine. The use of those or adding those to diesel fuel can cause engine damage.**
- **Do not use summer fuel at temperatures below  $-7^{\circ}\text{C}$  ( $20^{\circ}\text{F}$ ). The cold temperatures will cause wax to form in the fuel. As a result, it may prevent the engine from running smoothly.**

## RECOMMENDED SAE VISCOSITY NUMBER

Gasoline engine oil

**Except for Mexico and Thailand: 5W-30 is preferable.**

**If 5W-30 is not available, select the viscosity, from the chart below, that is suitable for the outside temperature range.**

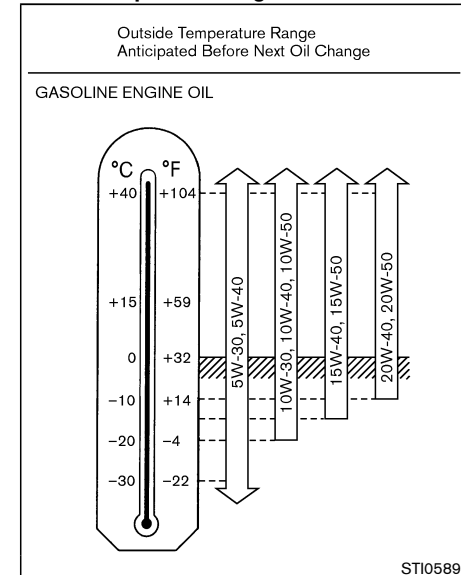



**For Mexico:**

**10W-30 is preferable.**

**5W-30 is also preferable and will improve fuel economy.**

**If 10W-30 or 5W-30 is not available, select the viscosity, from the chart below, that is suitable for the outside temperature range.**

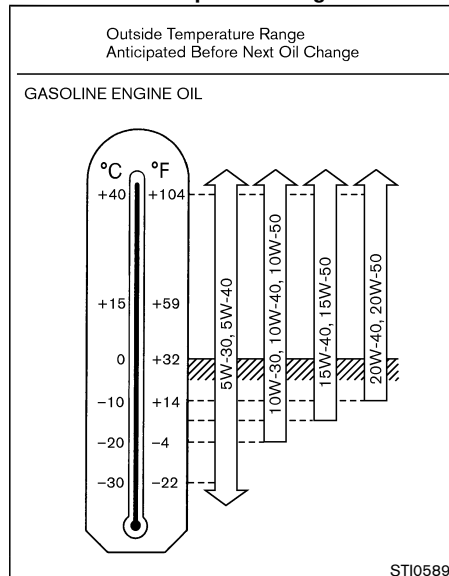
**For Thailand:**

**0W-20 is preferable.**

**If 0W-20 is not available, select the viscosity, from the chart below, that is suitable for the outside temperature range.**

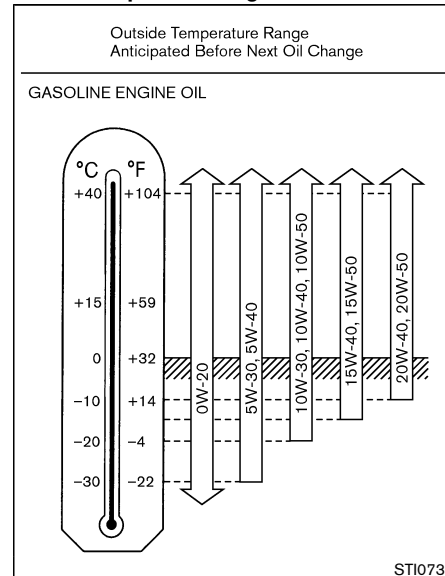
**AIR CONDITIONER SYSTEM REFRIGERANT AND LUBRICANT**

The air conditioner system of your vehicle must be charged with the specified refrigerant and compressor oil or equivalent.

- Refrigerant
  - For Europe: HFO-1234yf (R-1234yf)
  - Except for Europe: HFC-134a (R-134a)
- Compressor Oil
  - For Europe: Compressor Oil ND-OIL12
  - Except for Europe: Compressor Oil ND-OIL8

**CAUTION:**

**Use of any other refrigerants or lubricants will cause severe damage, and you may need to replace your vehicle's entire air conditioner system.**

The release of refrigerants into the atmosphere is prohibited in many countries and regions. The refrigerant in your vehicle will not harm the Earth's ozone layer. However, it may contribute in a small part to the global warming effect. NISSAN recommends that the refrigerant be appropriately recovered and recycled. Contact a NISSAN dealer when servicing the air conditioner system.

## ENGINE

Engine model		QR25DE	MR20DD	R9M
Type		Gasoline, 4-cycle, DOHC	Gasoline, 4-cycle, DOHC	Diesel, 4-cycle
Cylinder arrangement		4-cylinder, in-line	4-cylinder, in-line	4-cylinder, in-line
Bore × Stroke	mm (in)	89.0 × 100.0 (3.504 × 3.937)	84.0 × 90.1 (3.307 × 3.547)	80.0 × 79.5 (3.15 × 3.13)
Displacement	cm <sup>3</sup> (cu in)	2,488 (151.82)	1,997 (121.86)	1,598 (97.51)
Idle speed	rpm	650±50	CVT: 650±50 MT: 700±50	850±50
Ignition timing (B.T.D. C.)	degree at idle	10°	0±2°	-
Spark plugs				
Type	Standard	FXE20HE-11C	DILKAR7D11H	-
Gap	mm (in)	1.1 (0.043)	1.1 (0.043)	-
Camshaft operation		Timing chain	Timing chain	Timing chain
Maximum vehicle speed (for Gulf standard models)*1				
	CVT: km/h (MPH)	190 (118)	-	-

\*1: Gulf Standard regulation requires automobile manufacturers to indicate the maximum vehicle speed for applicable models. The maximum vehicle speed, listed above, is the measured speed under certain testing conditions. The actual value may differ according to the vehicle usage and road and environmental conditions. NISSAN recommends you to ALWAYS observe posted speed limits and never drive too fast for conditions.

## 9-6 Technical information

**TIRES AND WHEELS**

		Standard	Spare	
Tire size		225/65 R17	Conventional T155/90 D17*1	
		225/60 R18	225/65 R17*1 T155/90 D17*1	
		225/55 R19	T155/90 D17*1	
		Size		Offset mm (in)
Road wheel	Standard	Steel	17 × 7J	45(1.77)
		Aluminum	17 × 7J 18 × 7J 19 × 7J	45(1.77) 45(1.77) 40(1.57)
	Spare	Steel	17 × 4T 17 × 7J	30(1.18) 45(1.77)

\*1: Temporary use only

**DIMENSIONS**

		Unit: mm (in)
Overall length	4,640	(182.7)
Overall width	1,820	(71.7)
	1,830	(72.0)*1
Overall height	1,705	(67.1)*2
	1,710	(67.3)*3
	1,715	(67.5)*4
	1,720	(67.7)*5
Front tread	1,575	(62.0)
	1,585	(62.4)*1
Rear tread	1,575	(62.0)
	1,585	(62.4)*1
Wheelbase	2,705	(106.5)

\*1: For 225/55 R19 tire model

\*2: For Mexico (without roof rail)

\*3: For Australia, Philippines, Europe (without roof rail), Ecuador, Chile, Colombia, Peru and the Middle East

\*4: For Europe (with roof rail) and Mexico (with roof rail)

\*5: For Thailand and Indonesia

## WHEN TRAVELLING OR REGISTERING IN ANOTHER COUNTRY

**When planning to travel in another country or region,** find out whether the fuel required for your vehicle is available in that country or region. Using a low octane rated fuel may cause engine damage. Therefore, be sure that the required fuel is available wherever you go. For additional information regarding recommended fuel, see earlier in this section.

**When transferring the registration of your vehicle to another country, state, province or district,** contact the appropriate authorities to find out that the vehicle complies with the local legal requirements. In some cases, a vehicle cannot meet the legal requirements, and it may be necessary to modify the vehicle to meet local laws and regulations. In addition, there may be possibilities that a vehicle cannot be adapted in certain areas.

The laws and regulations for motor vehicle emission control and safety standards vary according to the country, state, province or district; therefore, the vehicle specification may differ.

**When any vehicles are to be taken into another country, state, province or district, its modification, transportation, registration, and any other expenses which may result, are the responsibility of the user. NISSAN is not responsible for any inconveniences that may result.**

## VEHICLE IDENTIFICATION

It is prohibited to cover, paint, weld, cut, drill, alter or remove Vehicle Identification Number (VIN).

### VEHICLE IDENTIFICATION PLATE

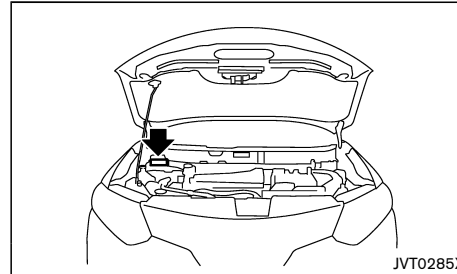

The plate is affixed as shown.

### Built date plate (for Australia and New Zealand)

Built date is stamped on the vehicle identification plate.

The built date means the calendar month and the year in which the body shell and power train subassemblies are conjoined and the vehicle is driven or moved from the production line.

### VEHICLE IDENTIFICATION NUMBER (VIN) PLATE (if equipped)

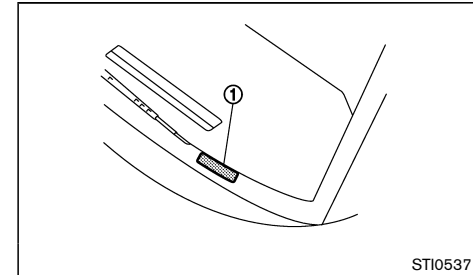

The vehicle identification number plate ① is attached as shown. This number is the identification for your vehicle and is used in the vehicle registration.

### VEHICLE IDENTIFICATION NUMBER (chassis number)

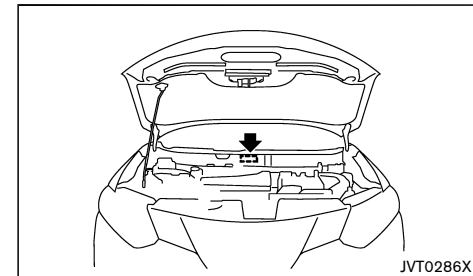

The vehicle identification number is located as shown. Remove the cover to access the number.

## 9-8 Technical information

### ENGINE SERIAL NUMBER

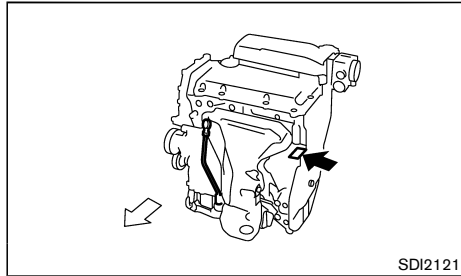

**QR engine**

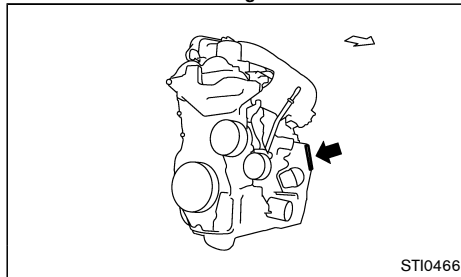

**MR engine**

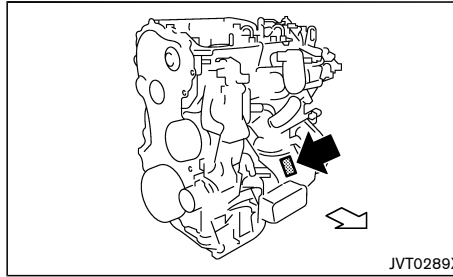

**R9M engine**

The engine serial number is stamped on the engine as shown.

### CERTIFICATION LABEL (if equipped)

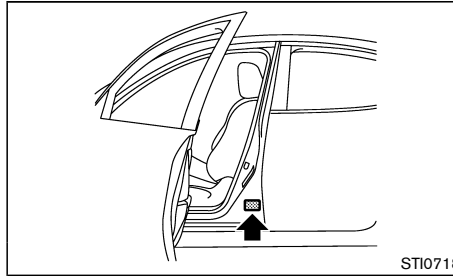

### TIRE PLACARD

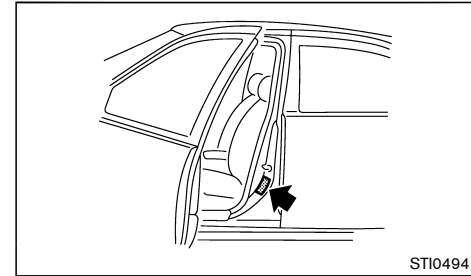

The cold tire pressures are shown on the tire placard affixed to the driver's side center pillar.

### AIR CONDITIONER SPECIFICATION LABEL

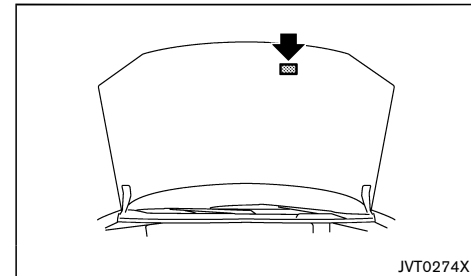

## UNIFORM TIRE QUALITY GRADING (if equipped)

Quality Grades: All passenger car tires must conform to local safety requirements in addition to these grades.

Quality grades can be found where applicable on the tire sidewall between tread shoulder and maximum section width. For example:

### Treadwear 200 Traction AA Temperature A

#### TREADWEAR

The treadwear grade is a comparative rating based on the wear rate of the tire when tested under controlled conditions on a specified government test course. For example, a tire graded 150 would wear one and one-half (1 1/2) times as well on the government course as a tire graded 100. The relative performance of tires depends upon the actual conditions of their use, however, and may depart significantly from the norm due to variations in driving habits, service practices and differences in road characteristics and climate.

#### TRACTION AA, A, B AND C

The traction grades, from highest to lowest, are AA, A, B, and C. Those grades represent the tire's ability to stop on wet pavement as measured under controlled conditions on specified government test surfaces of asphalt and concrete. A tire marked C may have poor traction performance.



#### WARNING:

**The traction grade assigned to this tire is based on straight-ahead braking traction tests, and does not include acceleration, cornering, hydroplaning, or peak traction characteristics.**

#### TEMPERATURE A, B AND C

The temperature grades are A (the highest), B, and C, representing the tire's resistance to the generation of heat and its ability to dissipate heat when tested under controlled conditions on a specified indoor laboratory test wheel. Sustained high temperature can cause the material of the tire to degenerate and reduce tire life, and excessive temperature can lead to sudden tire failure. The grade C corresponds to a level of performance which all passenger car tires must meet under the local regulations. Grades B and A represent higher levels of performance on the laboratory test wheel than the minimum required by law.



#### WARNING:

**The temperature grade for this tire is established for a tire that is properly inflated and not overloaded. Excessive speed, under-inflation, or excessive loading, either separately or in combination, can cause heat build-up and possible tire failure.**

## RADIO APPROVAL NUMBER AND INFORMATION

### FOR EUROPE

#### Intelligent Key system

<small>Continental Service Center - Number: 02201 - 10200 (Germany)</small>	
<small>Global Link 1 800 FCD CFM MM Phone +49 (0)17 790-8842 Fax +49 (0)17 790-88962 jeff.kim@continental-corporation.com</small>	
Date: Dec 17, 2012	Your message: Nissan CMF1 keyfob
<b>Declaration of Conformity in accordance with Directive 1999/5/EC (R&amp;TE Directive)</b>	
Manufacturer:	Continental Automotive GmbH
Address:	Sonnenallee 12 D-63053 Regensburg Germany
Product type designation:	S180144104
Intended use:	Vehicle keyless entry system
<small>The product mentioned above complies with the essential requirements and other relevant provisions of Directive 1999/5/EC, when used for its intended purpose.</small>	
Health and safety pursuant to Art. 3(1)(a):	<small>Applied standards: EN 60950-1:2006 + A11:2009 + A1:2010 EN 62479-1:2010</small>
Electromagnetic compatibility pursuant to Art. 3(1)(b):	<small>Applied standards: EN 301 488-1 V11 B 1 (2006-04) EN 301 488-3 V11 A 1 (2006-05)</small>
Efficient use of spectrum pursuant to Art. 3(2):	<small>Applied standards: EN 300 220-1 V2 3 1 (2010-02) EN 300 220-2 V2 3 1 (2010-02) EN 300 220-3 V1 1 1 (2010-02) EN 300 330-2 V1 1 1 (2010-02) EN 300 330-2 V1 1 1 (2010-02)</small>
<small>The following marking applies to the above mentioned product:</small>	
<small>Continental Automotive GmbH Regensburg, 2012-10-17</small>	
 <small>Andreas Hoff Executive Vice President Sales &amp; Security</small>	 <small>Roland Müller Director Product Group 1 Sales &amp; Security</small>
JVT0313X	

## 9-10 Technical information

**Continental**  
 Continental AG, Hagen 51074, Germany  
 JUnit Ltd  
 188 PDS CRIF JCM  
 Phone +81 (241) 750-8842  
 Fax +81 (241) 750-8842  
 junit.ltd@continental-corporation.com

Date: Jan 23, 2013  
 Part description: Nissan CM1 BCM  
 On board: Yes/No: No

Declaration of Conformity in accordance with Directive 1995/5/EC (R&TTE Directive)

Manufacturer: Continental Automotive GmbH  
 Address: Schwanenweg 17  
 D 93055 Regensburg  
 Germany

Product type designation: 3180/92102  
 Intended use: Vehicle keyless entry system

The product mentioned above complies with the essential requirements and other relevant provisions of Directive 1995/5/EC, when used for its intended purpose.

Health and safety pursuant to Art. 3(7)(b):  
 Applied standards: EN 60950-1:2006 + A11:2009 + A1:2010  
 EN 60950-1:2006

Electromagnetic compatibility pursuant to Art. 3(2)(b):  
 Applied standards: EN 301 489-1 V1.8.1 (2008-04)  
 EN 301 489-3 V1.4.1 (2008-06)

Efficient use of spectrum pursuant to Art. 3(2):  
 Applied standards: EN 300 330-1 V1.1.1 (2010-02)  
 EN 300 330-2 V1.5.1 (2010-02)

The following marking applies to the above mentioned product: **CE**

Continental Automotive GmbH  
 Regensburg, 2013-01-23

Address Head: *Woy*  
 Executive Vice President  
 Body & Security

Nissan Motor  
 Dealer Product Group 1  
 Body & Security

Signature of Responsible Person: *[Signature]*

Toru Kinoshita  
 Group Manager  
 GROUP 2 ENGINEERING DEPT. MS

JVT0314X

### Remote keyless entry system

**ALPS ALPS ELECTRIC CO., LTD.** Engineering Headquarters  
 6-3-36, Nakazono, Furokawa, Osaka-city, Miyagi-pref, 589-6131, Japan  
 Phone: +81 226-24-6111 Fax: +81 226-24-6129

**DECLARATION OF CONFORMITY For**

**CE**

Product: Remote Keyless Entry (Hand Unit)  
 Model: TWB1G767  
 Type: Transmitter

Supplied by: ALPS ELECTRIC CO., LTD.  
 6-3-36, Nakazono, Furokawa, Osaka-city, Miyagi-pref., JAPAN 989-6111

Technical Construction File held by: ALPS ELECTRIC CO., LTD.  
 6-3-36, Nakazono, Furokawa, Osaka-city, Miyagi-pref., JAPAN 989-6111

Notified Body - R&TTE Directive: N/A

Standard used for comply:  
 EN 60965: 2002 + Amd.1: 2006 + Amd.11: 2008 + Amd.2: 2010 + Amd.12: 2011

R&TTE Directive (Article 3.1(a) Safety): EN 60965: 2002 + Amd.1: 2006 + Amd.11: 2008 + Amd.2: 2010 + Amd.12: 2011

R&TTE Directive (Article 3.1(b) EMC): EN 301 489-1 V1.9.2:2011-09  
 EN 301 489-3 V1.4.1:2002-08

R&TTE Directive (Article 3.2 Spectrum): EN 300 220-1 V2.4.1:2012-05  
 EN 300 220-2 V2.4.1:2012-05

Means of Conformity  
 We declare under our sole responsibility that the Product (s) is conformity with the essential requirements and other relevant requirements of the Radio and Telecommunication Terminal Equipment (R&TTE) Directive (1999/5/EC).

Date of issue: February 28, 2013

Signature of Responsible Person: *[Signature]*

Toru Kinoshita  
 Group Manager  
 GROUP 2 ENGINEERING DEPT. MS

JVT0315X

### NISSAN Anti-Theft System (NATS) immobilizer

**DECLARATION OF CONFORMITY**

**CE 0681**

This declaration is the responsibility of the manufacturer / authorized representative within the Community:  
 Johnson Controls Automotive Electronics SAS  
 Parc saint Christophe 10, avenue de l'Entreprise 95892 Cergy Pontoise Cedex  
 (France - Address)

This certifies that the following designated product:  
**CMF-IMMO**  
 (Product identification)

Complies with the essential protection requirements of R&TTE Directive 1999/5/EC on the approximation of the laws of the Member States relating to *Radio Spectrum Matters, EMC and Electrical Safety*.  
 This declaration applies to all specimens manufactured in accordance with the technical documentation described in the annex II. Johnson Controls Automotive Electronics keep this documentation at the disposal of the relevant national authorities of any Member State for inspection purposes.  
 Assessment of compliance of the product with the essential requirements according to the Article 3 R&TTE was based on Annex IV of the Directive 1999/5/EC and the following standards:

Radio Spectrum: EN 300 330-2  
 (Specification of equipment - standard)

EMC: EN 301 489 Part 1&3  
 (Specification of equipment - standard)

Safety: EN 60950-1  
 (Specification of equipment - standard)

The equipment CMF-IMMO is a 125 KHz transmitter which is harmonized throughout the European Community. This device is license exempt and may be distributed in the European countries which apply the R&TTE directive

Place, date: Name in block letters & Signature  
 Cergy-Pontoise, April 10<sup>th</sup>, 2013  
*C. Ohtani*

JVT0316X

Technical information 9-11

### Tire Pressure Monitoring System (TPMS) transmitter (if equipped)

**Continental** Interior

Continental Automotive Group - Avenue 11 20 01 - 92258 Regensburg

Body & Security  
Jasaf Lohr  
1105 902 02-02 18M  
Phone +49 (0)41 730-8842  
Fax +49 (0)41 73099-8942  
jasaf.lohr@continental-corporation.com

Date: July 31, 2012    Your message about:    On behalf of: T32-C Nissan CMF1    Your vehicle:

**Declaration of Conformity**  
We, the undersigned, declare that  
The tire pressure monitoring sensor S180052048 uses the same  

- schematic,
- assembly
- and PCB

as the tire pressure monitoring sensor S180052050.  
They only differ in:  

- Protocol

The modification is necessary to adapt several carlines.  
This modification does not influence the RF characteristics of the system.

Yours truly,  
Continental Automotive GmbH  
Regensburg, 31.07.2012

*Andreas Wolf*  
Andreas Wolf  
Executive Vice President  
Body & Security

*Norbert Müller*  
Norbert Müller  
Director Product Group 1  
Body & Security

Continental Automotive Group    Phone: +49 (0)41 730-0  
Leibnizstr. 11    Fax: +49 (0)41 730-999-0  
92225 Regensburg    www.continental-corp.com

Continental Automotive Group    Phone: +49 (0)41 730-0  
Leibnizstr. 11    Fax: +49 (0)41 730-999-0  
92225 Regensburg    www.continental-corp.com

Continental Automotive Group    Phone: +49 (0)41 730-0  
Leibnizstr. 11    Fax: +49 (0)41 730-999-0  
92225 Regensburg    www.continental-corp.com

JVT0309X

### FOR MEXICO Intelligent Key system

S180144014  
Continental AG  
Siemensstraße 12  
93055 Regensburg

JVT0312X

### FOR ABU DHABI Remote keyless entry system

TRA  
REGISTERED No: ER106342/13  
DEALER No: 0034163/10

JVT0317X

## 9-12 Technical information



FOR MOROCCO

Remote keyless entry system



FOR SOUTH AFRICA

Intelligent Key system



Remote keyless entry system



NISSAN Anti-Theft System (NATS) immobilizer



NISSAN Anti-Theft System (NATS) immobilizer



FOR PANAMA

Remote keyless entry system

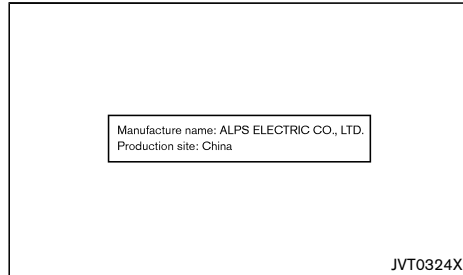

FOR PARAGUAY

Remote keyless entry system

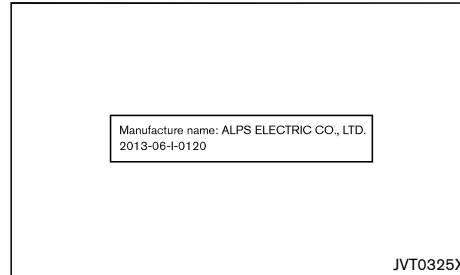

FOR URUGUAY

Remote keyless entry system

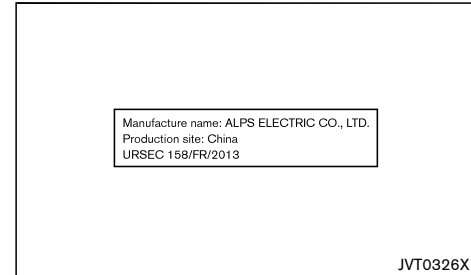

FOR JORDAN

Bluetooth® Hands-Free Phone System

This product contains approved Bluetooth Module  
“VBTD1.5”.

Type approval No. : TRC/LPD/2012/1

9-14 Technical information

FOR SURINAM

Remote keyless entry system

Production site: China

JVT0327X

FOR JAMAICA

Remote keyless entry system

Manufacture name: ALPS ELECTRIC CO., LTD.  
Approved for use in Jamaica SMA EI: [TWB1G767]

JVT0328X

FOR THE MIDDLE EAST

Radio

SSA380-1997 Radio Frequency

Source Parameters	The limits of the frequency bands
FM	87.50-108.00MHz
AM	531-1602kHz

JVT0311X

NISSAN Anti-Theft System (NATS) immobilizer

Approved for use in Jamaica SMA EI: [CMF-IMMO]

JVT0329X

FOR INDONESIA

Remote keyless entry system

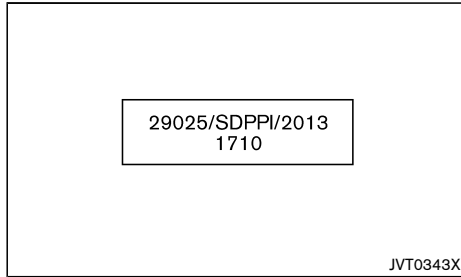

**9-16 Technical information**

Condition: 'Except for China/'

[ Edit: 2014/ 11/ 7 Model: T32-A ]

# 10 Index

## A

Active Engine Brake .....	5-28
Active Ride Control.....	5-29
Active Trace Control.....	5-28
Air bag system	
Air bag warning labels .....	1-30
Air bag warning light .....	1-31
Side (See supplemental side-impact air bag system) .....	1-27, 1-34
Supplemental air bag systems.....	1-32
Supplemental curtain side-impact air bag system.....	1-27, 1-34
Supplemental front-impact air bag system.....	1-27, 1-33
Air cleaner filter.....	8-17
Air conditioner	
Air conditioner operation .....	4-26
Air conditioner specification label .....	9-9
Air conditioner system refrigerant and lubricant ...	9-5
Air fresheners .....	7-4
Aluminum alloy wheels .....	7-3
Antenna.....	4-43
Anti-lock Braking System .....	5-58
Anti-lock braking system (ABS) warning light ....	2-13
Appearance care	
Exterior appearance care .....	7-2
Interior appearance care.....	7-3
Armrest.....	1-7
Around View Monitor.....	4-10
Ashtray.....	2-54
Ashtrays and cigarette lighter .....	2-54
Audible reminders .....	2-19
Audio operation precautions .....	4-35
Audio system .....	4-35
Auto door lock releasing mechanism.....	3-7
Automatic air conditioner .....	4-32, 4-34
Automatic sunroof and sunshade .....	2-52
Auxiliary input jack.....	4-75

Average speed .....	2-35
---------------------	------

## B

Back door .....	3-23
Auto closure.....	3-26
Back door release lever .....	3-26
Operating manual back door.....	3-23
Operating power back door .....	3-24
Battery .....	5-59, 8-3, 8-20
Battery saver system .....	2-44, 2-63
Intelligent Key battery discharge .....	5-11
Intelligent Key battery replacement.....	8-22
Remote controller battery replacement .....	8-21
Variable voltage control system .....	8-23
Before starting engine.....	5-3
Blind Spot Warning (BSW) system .....	5-31, 5-36
BSW driving situations .....	5-33, 5-38
BSW system operation.....	5-32, 5-36
Blocking wheels.....	6-5
Bluetooth® Hands-Free Phone System .....	4-78, 4-84, 4-87, 4-94
Brake	
Brake booster .....	8-15
Brake fluid .....	8-16
Brake system.....	5-57
Electronic parking brake system warning light .....	2-14
Parking brake .....	3-30
Parking brake operation .....	5-60
Press brake pedal warning (for electronic parking brake equipped models) .....	2-31
Warning light .....	2-13
Brake assist .....	5-58
Brake precautions .....	5-57
Brakes .....	8-15
Brightness control	
Instrument panel .....	2-10
BSW automatic deactivation.....	5-39
BSW malfunction .....	5-39

BSW temporary disabled status.....	5-39
BSW/LDW automatic deactivation.....	5-35
BSW/LDW malfunction.....	5-35
BSW/LDW temporary disabled status.....	5-35
Bulb replacement .....	8-2, 8-27

## C

Camera unit maintenance .....	5-35, 5-39
Card holder.....	2-56
Care when driving .....	5-7
Catalytic converter, Three way catalyst .....	5-4
CD player/Radio .....	4-44, 4-52, 4-57, 4-63, 4-69
Center mark on seat belts .....	1-12
Center ventilators .....	4-25
Certification label.....	9-9
Changing engine coolant .....	8-9
Changing engine oil and oil filter .....	8-10
Changing tires and wheels.....	8-37
Chassis control .....	2-36, 5-28
Checking bulbs.....	2-13
Checking engine coolant level.....	8-9
Checking engine oil level .....	8-10
Checking foot brake pedal .....	8-15
Checking parking brake .....	8-15
Child restraints .....	1-14
Child restraint anchorage .....	1-20
Child restraint installation using 3-point type seat belt .....	1-23
Child restraint installation using ISOFIX.....	1-20
ISOFIX child restraint system.....	1-19
Precautions on child restraint usage.....	1-14
Universal child restraints for front seat and rear seats.....	1-15
Child safety .....	1-11
Child safety rear door lock .....	3-7
Chimes, Audible reminders.....	2-19
Chrome parts.....	7-3
Circuit breaker, Fusible link .....	8-24
Cleaning exterior and interior .....	7-2, 7-3

Clock .....	2-36
Clutch fluid .....	8-17
Coat hook .....	2-59
Cockpit .....	2-3
Cold weather driving .....	5-59
Compass .....	2-10
Console box .....	2-55
Console light .....	2-62
Continuously Variable Transmission (CVT) position indicator .....	2-10
Continuously Variable Transmission fluid .....	8-17
Corner sensor function .....	4-15
Corrosion protection .....	5-60, 7-5
Coupling device installation .....	5-56
Cover, Tonneau cover .....	2-60
Cruise control .....	5-43
Cup holders .....	2-55
CVT, Driving with CVT (Continuously Variable Transmission) .....	5-7

**D**

Defogger switch .....	2-49
Diesel Particulate Filter (DPF) .....	5-6
Dimensions .....	9-7
Display Vehicle information display .....	2-20
Distance to empty .....	2-35
Door locks .....	3-4
Drive belt .....	8-14
Driver Attention Alert .....	2-36
Driving Driving in wet conditions .....	5-7
Driving in winter conditions .....	5-7
Driving vehicle .....	5-13
Driving with Continuously Variable Transmission (CVT) .....	5-13
Driving with Manual Transmission (MT) .....	5-17
On-pavement and off-road driving precautions .....	5-7
Precautions when starting and driving .....	5-3

10-2

**E**

ECO mode system .....	5-47
Ambient ECO .....	5-47
ECO Drive Report .....	5-48
ECO Pedal Guide function .....	5-47
ECO mode system indicator light .....	2-17
Elapsed time .....	2-35
Elapsed time and trip odometer .....	2-35
Electric power steering system .....	5-56
Electric power steering warning light .....	2-14
Electronic Stability Program (ESP) OFF switch .....	5-27
Electronic Stability Program (ESP) system .....	5-26
Engine Break-in schedule .....	5-3
Coolant temperature gauge .....	2-9
Engine compartment check locations .....	8-5
Engine cooling system .....	8-8
Engine oil .....	8-10
Engine serial number .....	9-9
Engine specifications .....	9-6
Engine start operation indicator (for Continuously Variable Transmission (CVT) models) .....	2-29
Engine start operation indicator (for Manual Transmission (MT) models) .....	2-29
Engine cold start period .....	5-7
Engine coolant .....	5-59
Environmental factors influence rate of corrosion .....	7-5
Exhaust gas .....	5-4
Explanation of general maintenance items .....	8-2
Exterior lights .....	8-28

**F**

Flat tire .....	6-2
Floor mats .....	7-4

**Fluid**

Brake fluid .....	8-16
Engine coolant .....	8-8
Engine oil .....	8-10
Window washer fluid .....	8-4, 8-19
Fog light switch .....	2-45
Forward emergency braking system .....	5-45
Forward emergency braking system warning light .....	2-14
Front fog lights .....	2-46
Front seats .....	1-2
Fuel Gauge .....	2-9
Fuel filler cap .....	3-27
Fuel filler lid .....	3-27
Fuel information .....	9-4
Fuses .....	8-24
Fusible links .....	8-24

**G**

Garage door opener, HomeLink® Universal Transceiver .....	2-63
Garage mode system .....	3-27
Gauge .....	2-7
Engine coolant temperature gauge .....	2-9
Fuel gauge .....	2-9
Odometer .....	2-7
Speedometer .....	2-7
Tachometer .....	2-8
Gear Shift Indicator .....	5-18
General maintenance .....	8-2
Glass .....	7-2
Glove box .....	2-54

**H**

Hands-Free Phone System, Bluetooth® .....	4-78, 4-84, 4-87, 4-94
Hazard indicator and horn operation .....	3-18
Hazard indicator flasher switch .....	6-2

Hazard indicator operation .....	3-9
Head restraints .....	1-7
Headlight aiming control .....	2-42
Headlight and turn signal switch .....	2-39
Headlights .....	8-27
Headlight switch .....	2-39
Heater	
Heater and air conditioner operation .....	4-26
High beam assist .....	2-40
Hill descent control switch .....	5-31
Hill descent control system .....	5-30
Hill start assist system .....	5-30
HomeLink® Universal Transceiver .....	2-63
Hood .....	3-22
Closing hood .....	3-23
Opening hood .....	3-23
Hook	
Coat hook .....	2-59
Luggage hook .....	2-57
Horn .....	2-50
<b>I</b>	
Idling Stop System .....	5-18
If your vehicle is stolen .....	2-65
If your vehicle overheats .....	6-10
Ignition switch (model without intelligent Key system) .....	5-7
Ignition switch positions .....	5-10
Impact sensing door lock releasing mechanism ..	3-7
Indicator	
Vehicle information display .....	2-20
Indicator lights .....	2-17
Injured persons .....	1-12
Inside rearview mirror .....	3-28
Installing spare tire .....	6-7
Instrument brightness control .....	2-10
Instrument panel .....	2-5
Intelligent Key .....	3-2
Intelligent Key battery .....	8-22
Intelligent Key battery discharge .....	5-11
Intelligent Key operating range .....	3-13

Intelligent Key system .....	3-10, 5-9
Warning signals .....	3-15
Interior light switch .....	2-62
Interior lights .....	2-62, 8-29
Iridium-tipped spark plugs .....	8-14

**J**

Jump starting .....	6-8
---------------------	-----

**K**

Key	
Ignition switch (model without intelligent Key system) .....	5-7
Ignition switch positions .....	5-10
Intelligent Key battery discharge .....	5-11
Intelligent Key system .....	5-9
Push-button ignition switch (model with Intelligent Key system) .....	5-9
Key positions .....	5-8
Keys .....	3-2
For Intelligent Key system .....	3-10

**L**

Labels	
Air conditioner specification label .....	9-9
Engine serial number .....	9-9
Vehicle identification number (VIN) .....	9-8
Lane Departure Warning (LDW) system .....	5-31, 5-39
LDW system operation .....	5-34
Legal requirement to adjust headlight beam .....	8-33
Light	
Bulb replacement .....	8-2, 8-27
Fog light switch .....	2-45
Headlight switch .....	2-39
Indicator lights .....	2-17
Interior lights .....	2-62
Map lights .....	2-62

Rear personal lights .....	2-63
Replacement .....	8-2, 8-27
Room light .....	2-62
Light locations .....	8-30
Lights .....	8-27
Loading luggage .....	5-7
Lock	
Back door lock .....	3-23
Steering lock .....	5-10
Locking with inside lock knob .....	3-5
Locking with key .....	3-4
Low tire pressure warning (Low tyre pressure) .....	2-30
Low tire pressure warning light .....	2-14
Low tire pressure warning system .....	5-4
Low tyre pressure warning .....	2-30
Luggage compartment .....	2-57
Luggage hooks .....	2-57
Luggage room light .....	2-63

**M**

Maintenance	
Battery .....	8-3, 8-20
General maintenance .....	8-2
Maintenance precautions .....	8-4
Maintenance requirements .....	8-2
Seat belt maintenance .....	1-13
Manual air conditioner and heater .....	4-28, 4-30
Manual Transmission (MT) .....	5-8
Map lights .....	2-62
Master warning light .....	2-15
Maximum load limits .....	5-53
Mechanical key (Intelligent Key system) .....	3-4
Mechanical key (NISSAN Anti-Theft System) .....	3-2
Meters and gauges .....	2-7
Instrument brightness control .....	2-10
Mirrors .....	3-28
Inside rearview mirror .....	3-28
Outside rearview mirrors .....	3-29
Vanity mirror .....	3-29

Most common factors contributing to vehicle corrosion.....	7-5
Moving Object Detection (MOD) function.....	4-15
MR20DD engine model.....	8-7
Multi-sensing camera unit maintenance .....	5-41

## N

New vehicle break-in .....	5-3
NISSAN Anti-Theft System (NATS) .....	3-21
NISSAN Anti-Theft System (NATS) key .....	3-2

## O

Odometer .....	2-7
Off-road driving safety precautions .....	5-25
Oil	
Engine oil .....	8-10
One shot call .....	4-96
On-pavement and off-road driving precautions ...	5-7
Operating precautions .....	5-52
Outside air temperature.....	2-36
Outside rearview mirrors .....	3-29

## P

Panic alarm .....	3-9, 3-18
Parallel parking assist.....	4-17
Park Assist (PA) .....	4-17
Parking .....	5-48
Parking brake.....	3-30
Parking brake	
Electronic parking brake warning light.....	2-14
Parking sensor (sonar) system setting.....	5-52
Parking sensor system .....	5-50
Parking sensor system OFF switch.....	5-51
Parking, Parking brake operation .....	5-60
Perpendicular parking assist .....	4-19
Phone	
Bluetooth® Hands-Free Phone System .....	4-78, 4-84, 4-87, 4-94

10-4

Power	
Electric power steering system .....	5-56
Power outlet.....	2-53
Power windows.....	2-50

Precautions	
Audio operation.....	4-35
Cruise control.....	5-43
Maintenance .....	8-4
Push-button ignition switch operation .....	5-9
Seat belt usage.....	1-9
Supplemental Restraint System (SRS) .....	1-27
When starting and driving.....	5-3
Pregnant women.....	1-12
Preparing tools and spare tire .....	6-3
Pre-tensioner seat belt system .....	1-30, 1-36
Protect environment.....	8-13
Push starting.....	6-10
Push-button ignition switch (model with Intelligent Key system) .....	5-9

## Q

QR25DE engine model .....	8-6
---------------------------	-----

## R

Radio with Compact Disc (CD) player .....	4-44, 4-52, 4-57, 4-63, 4-69
Rain-sensing auto wiper system .....	2-48
Rear door lock, Child safety rear door lock .....	3-7
Rear fog light.....	2-46
Rear personal lights.....	2-63
Rear ventilators .....	4-26
Rear window wiper and washer switch .....	2-49
RearView Monitor .....	4-7
Recommended Fluids/lubricants and capacities .....	9-2
Recommended SAE viscosity number.....	9-4
Remote controller battery.....	8-21
Remote keyless entry system .....	3-7
Removing spots .....	7-2

Removing tire.....	6-6
Roof rail.....	2-60
Room light .....	2-62

## S

Safety chains .....	5-55
Safety, Child seat belts.....	1-11
Scheduled maintenance .....	8-2
Seat belt(s)	
Child safety .....	1-11
Precautions on seat belt usage.....	1-9
Pre-tensioner seat belt system .....	1-30, 1-36
Seat belt cleaning .....	7-4
Seat belt maintenance .....	1-13
Seat belt warning light .....	2-16
Seat belts .....	1-9
Shoulder belt height adjustment .....	1-12
Seat(s), Seats .....	1-2
Second row seats .....	1-5
Security system.....	3-20
Shift lever	
Shift lock release .....	5-15
Shift lock release	
Transmission .....	5-15
Shoulder belt height adjustment .....	1-12
Side ventilators .....	4-26
Side-impact air bag system.....	1-27, 1-34
Small light indicator light .....	2-19
Smartphone integration.....	4-74
Soft bottle holders .....	2-56
Sonar system.....	5-50
Sonar system OFF switch.....	5-51
Spare tire.....	8-38
Spark plugs.....	8-14
Special winter equipment.....	5-60
Speed and Average speed (km/h or MPH) .....	2-35
Speedometer .....	2-7
SRS air bag deployment conditions .....	1-34
Starting	
Jump starting .....	6-8
Precautions when starting and driving .....	5-3



Push starting .....	6-10
Starting engine (model with Intelligent Key system) .....	5-12
Starting engine (model without Intelligent Key system) .....	5-11
Steering	
Electric power steering system .....	5-56
Steering lock .....	5-8, 5-10
Steering lock release malfunction indicator .....	2-29
Tilting steering wheel .....	3-28
Stop/Start System or Idling Stop System .....	5-18
Storages .....	2-54
Stowing damaged tire and tools .....	6-7
Sun visors .....	2-61
Sunglasses holder .....	2-55
Sunroof .....	2-52
Super lock system .....	3-4
Supplemental air bag systems .....	1-32
Supplemental curtain side-impact air bag system .....	1-34
Supplemental front-impact air bag system .....	1-33
Supplemental side-impact air bag system .....	1-34
Supplemental curtain side-impact air bag system .....	1-27
Supplemental front-impact air bag system .....	1-27
Supplemental Restraint System (SRS) .....	1-27
Supplemental side-impact air bag system .....	1-27
Switch	
Fog light switch .....	2-45
Headlight switch .....	2-39
Ignition switch .....	5-7
Power door lock switch .....	3-6
Turn signal switch .....	2-44

## T

Tachometer .....	2-8
Temperature gauge, Engine coolant temperature gauge .....	2-9
Theft warning system .....	3-20
Third row seats .....	1-6

Three-point type seat belts .....	1-12
Three-way catalyst .....	5-4
Tilting steering wheel .....	3-28
Tire placard .....	9-9
Tire Pressure Monitoring System (TPMS) .....	8-36
Tires	
Flat tire .....	6-2
Low tire pressure warning light .....	2-14
Low tire pressure warning system .....	5-4
Spare tire .....	8-38
Tire age .....	8-37
Tire chains .....	8-36
Tire equipment .....	5-59
Tire inflation pressure .....	8-36
Tire pressure .....	5-55
Tire pressure monitoring system (TPMS) .....	5-4, 6-2
Tire rotation .....	8-37
Tire wear and damage .....	8-37
Tires of 4WD model .....	5-26
Types of tires .....	8-36
Uniform tire quality grading .....	9-10
Tires and wheels .....	8-36, 9-7
To protect your vehicle from corrosion .....	7-5
Tonneau cover .....	2-60
Towing precautions .....	6-11
Towing recommended by NISSAN .....	6-11
Towing, Tow truck towing .....	6-11
TPMS resetting .....	5-6
TPMS, Tire pressure monitoring system .....	5-4
TPMS, Tire pressure warning system .....	6-2
Traffic Sign Recognition .....	2-37
Traffic Sign Recognition (if equipped) .....	2-36
Trailer brakes .....	5-55
Trailer detection .....	5-55
Trailer towing .....	5-52
Transceiver, HomeLink® Universal Transceiver .....	2-63
Transmission	
Continuously Variable Transmission .....	5-7
Transmission shift lever lock release .....	5-15
Trip computer .....	2-34
Trip odometer .....	2-35

Troubleshooting guide .....	3-16
Turn signal switch .....	2-44

## U

Underbody cleaning .....	7-3
Uniform tire quality grading .....	9-10
USB (Universal Serial Bus) connection port .....	4-75
Using Intelligent Key system .....	3-13
Using remote keyless entry function .....	3-17
Using remote keyless entry system .....	3-8

## V

Vanity mirror .....	3-29
Vanity mirror light .....	2-63
Variable voltage control system .....	8-23
Vehicle	
Dimensions .....	9-7
Identification number (VIN) .....	9-8
Vehicle dynamic control (VDC) system .....	5-26
Vehicle battery .....	8-20
Vehicle Dynamic Control (VDC) OFF switch .....	5-27
Vehicle identification number (chassis number) .....	9-8
Vehicle Identification Number (VIN) plate .....	9-8
Vehicle identification plate .....	9-8
Vehicle information display .....	2-20
How to use the vehicle information display .....	2-20
Settings .....	2-21
Startup display .....	2-21
Vehicle information display warnings and indicators .....	2-28
Vehicle security .....	5-59
Vehicle speed sensing door lock mechanism .....	3-6
Ventilators .....	4-25
Voice prompt interrupt .....	4-95
Voice Recognition system .....	4-98

**W**

Warning

- Low tyre pressure warning ..... 2-30
- Tire pressure monitoring system (TPMS) ..... 5-4, 6-2
- Vehicle information display ..... 2-20
- Warning/indicator lights and audible reminders ..... 2-12

Warning light

- Anti-lock braking system (ABS) warning light ..... 2-13
- Brake warning light ..... 2-13
- Electric power steering warning light ..... 2-14
- Electronic parking brake system warning light ..... 2-14
- Electronic parking brake warning light ..... 2-14
- Low tire pressure warning light ..... 2-14
- Seat belt warning light ..... 2-16

Warning lights ..... 2-13

Washer switch

- Rear window wiper and washer switch ..... 2-49
- Windshield wiper and washer switch ..... 2-47

Washing ..... 7-2

Waxing ..... 7-2

Welcome light and farewell light function ..... 3-14

Wheel balance ..... 8-38

Wheels and tires

- Care of wheels ..... 7-3

When travelling or registering in another country ..... 9-8

Where to go for service ..... 8-2

Window washer fluid ..... 8-4, 8-19

Window(s)

- Cleaning ..... 7-4
- Power windows ..... 2-50

Windows ..... 2-50

Windshield wiper and washer switch ..... 2-47

Wiper

- Rain-sensing auto wiper system ..... 2-48
- Rear window wiper and washer switch ..... 2-49

- Rear window wiper blade ..... 8-19
- Windshield wiper and washer switch ..... 2-47
- Wiper blades ..... 8-18
- Wiper and washer switch ..... 2-47
- Wiper blades ..... 8-18

## GAS STATION INFORMATION

### FUEL INFORMATION

Gasoline engine (model with three-way catalyst)



#### CAUTION:

**Do not use leaded gasoline. Using leaded gasoline will damage the three-way catalyst.**

#### QR25DE engine model:

For Thailand:

Use UNLEADED REGULAR gasoline or gasohol (up to E20\*) with an octane rating of at least 91 (RON).

\*: Gasohol is alcohol blended gasoline. For example, "E20" is a mixture of approximately 20% fuel ethanol and 80% unleaded gasoline.

For Mexico:

Use UNLEADED REGULAR gasoline with an octane rating of at least 87 AKI (Anti-Knock index) number (Research octane number 91).

Except for Thailand and Mexico:

Use UNLEADED REGULAR gasoline with an octane rating of at least 91 (RON).

#### MR20DD engine model:

For Thailand:

Use UNLEADED REGULAR gasoline or gasohol (up to E20\*) with an octane rating of at least 91 (RON).

\*: Gasohol is alcohol blended gasoline. For example, "E20" is a mixture of approximately 20% fuel ethanol and 80% unleaded gasoline.

Except for Thailand:

Use UNLEADED REGULAR gasoline with an octane

rating of at least 91 (RON).

#### Diesel engine\*

Diesel fuel above 51 cetane and with less than 10 ppm of sulphur (EN590) must be used.

\* If two types of diesel fuel are available, use summer or winter fuel properly according to the following temperature conditions.

- Above  $-7^{\circ}\text{C}$  ( $20^{\circ}\text{F}$ ) ... Summer type diesel fuel.
- Below  $-7^{\circ}\text{C}$  ( $20^{\circ}\text{F}$ ) ... Winter type diesel fuel.



#### CAUTION:

- **Do not use home heating oil, gasoline or other alternate fuels in your diesel engine. The use of those or adding those to diesel fuel can cause engine damage.**
- **Do not use summer fuel at temperatures below  $-7^{\circ}\text{C}$  ( $20^{\circ}\text{F}$ ). The cold temperatures will cause wax to form in the fuel. As a result, it may prevent the engine from running smoothly.**

### RECOMMENDED ENGINE OIL

See "Recommended Fluids/lubricants and capacities" (P.9-2).

#### Gasoline engine

Except for Kazakhstan, Ukraine and South Africa

- Genuine NISSAN engine oil
- API grade: SL, SM or SN
- ILSAC grade: GF-3, GF-4 or GF-5

For Kazakhstan, Ukraine and South Africa

- Genuine NISSAN engine oil
- API grade: SL, SM or SN
- ILSAC grade: GF-3, GF-4 or GF-5
- ACEA A1/B1, A3/B3, A3/B4, A5/B5, C2 or C3

#### Diesel engine

With Diesel Particulate filter

- Genuine NISSAN engine oil
- ACEA C4 LOW SAPS, Viscosity SAE 5W-30

Without Diesel Particulate filter

- Genuine NISSAN engine oil
- ACEA A3/B4, Viscosity SAE 5W-30

### TIRE COLD PRESSURE

See the tire placard affixed to the driver's side center pillar.

## QUICK REFERENCE

- In case of emergency ... 6-1  
(Flat tire, engine will not start, overheating, towing)
- How to start the engine ... 5-1
- How to read the meters and gauges ... 2-1
- Maintenance and do-it-yourself ... 8-1
- Technical information ... 9-1