

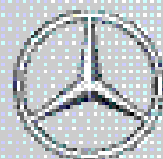

A-Class

Owner's Manual



Mercedes-Benz

Symbols

In this Owner's Manual, you will find the following symbols:

WARNING

Warning notices draw your attention to hazards that may endanger your health or life, or the health or life of others.

Environmental note

Environmental notes provide you with information on environmentally aware actions or disposal.

 Notes on material damage alert you to dangers that could lead to damage to your vehicle.

 This symbol indicates useful instructions or further information that could be helpful to you.

▶ This symbol designates an instruction you must follow.

▶ Several consecutive symbols indicate an instruction with several steps.

(▷ page) This symbol tells you where you can find further information on a topic.

▷▷ This symbol indicates a warning or an instruction that is continued on the next page.

Display This text indicates a message on the multifunction/COMAND display.

Parts of the software in the vehicle are protected by copyright © 2005
The FreeType Project
<http://www.freetype.org>. All rights reserved.

Thank you for choosing Mercedes-Benz

Before you first drive off, read this Owner's Manual carefully and familiarise yourself with your vehicle. For your own safety and a longer vehicle life, follow the instructions and warning notices in this manual. Disregarding them may lead to damage to the vehicle or personal injury.

The equipment or model designation of your vehicle may vary according to:

- model
- order
- country variant
- availability

The illustrations in this manual show a left-hand-drive vehicle. On right-hand-drive vehicles, the layout of components and controls differs accordingly.

Mercedes-Benz is constantly updating its vehicles to the state of the art.

Mercedes-Benz therefore reserves the right to introduce changes in the following areas:

- design
- equipment
- technical features

The equipment in your vehicle may therefore differ from that shown in the descriptions and illustrations.

The following are integral components of the vehicle:

- Owner's Manual
- Service Booklet
- Equipment-dependent supplements

Keep printed copies of the documents in the vehicle at all times. If you sell the vehicle, always pass the documents on to the new owner.

i You can get to know the important features of your vehicle in the interactive Owner's Manual on the Internet at:

<http://www.mercedes-benz.de/betriebsanleitung>

You can also use the A-Class Guide smartphone App:



Apple® iOS



Android™

The technical documentation team at Daimler AG wishes you safe and pleasant motoring.



Index	4	At a glance	27
Introduction	21	Safety	39
		Opening and closing	73
		Seats, steering wheel and mirrors	91
		Lights and windscreen wipers	103
		Climate control	121
		Driving and parking	141
		On-board computer and displays	207
		Stowing and features	267
		Maintenance and care	283
		Breakdown assistance	297
		Wheels and tyres	317
		Technical data	335

- 1, 2, 3 ...**
- 12 V socket**
see Socket
- 4ETS**
see ETS/4ETS (Electronic Traction System)
- 4MATIC (permanent all-wheel drive)**
Display message 254
- 4MATIC (permanent four-wheel drive)** 182
- A**
- ABS (Anti-lock Braking System)**
Display message 230
Function/notes 61
Important safety notes 61
Warning lamp 258
- Activating/deactivating air-recirculation mode** 132
- Activating/deactivating cooling with air dehumidification** 126
- Active light function** 109
- Active Park Assist**
Display message 248
- Active Parking Assist**
Cancelling 190
Detecting parking spaces 187
Exiting a parking space 189
Function/notes 187
Important safety notes 186
Parking 188
Towing a trailer 190
- ADAPTIVE BRAKE** 69
- Adaptive Brake Assist**
Display message 237
Function/notes 64
- Adaptive brake lamps** 65
- Adaptive Highbeam Assist**
Display message 243
Function/notes 110
- Adaptive Main-beam Assist**
Switching on/off (on-board computer) 222
- Additional speedometer** 220
- Additives (engine oil)** 344
- Adjusting the headlamp range** 107
- Airbags**
Front airbag (driver, front passenger) 43
Important safety guidelines 42
Kneebag 44
Sidebag 44
Triggering 41
Windowbag 45
- Air-conditioning system**
see Climate control
- Air filter (white display message)** 245
- Air vents**
Important safety notes 139
Rear 140
Setting 139
Setting the centre air vents 139
Setting the side air vents 140
see Climate control
- Alarm system**
see ATA (Anti-Theft Alarm system)
- Ambient lighting**
Setting the brightness (on-board computer) 222
- AMG**
Menu (on-board computer) 226
Performance Seat 97
- Anti-glare film** 281
- Anti-lock braking system**
see ABS (Anti-lock Braking System)
- Anti-Theft Alarm system**
see ATA (Anti-Theft Alarm system)
- Aquaplaning** 167
- Ashtray** 277
- Assistance display (on-board computer)** 217
- Assistance menu (on-board computer)** 217
- ASSYST PLUS**
Displaying a service message 290
Hiding a service message 289
Notes 289
Resetting the service interval display 290
Service message 289
Special service requirements 290

- ATA (anti-theft alarm system)**
 - Activating/deactivating 69
 - ATA (Anti-Theft Alarm system)**
 - Function 69
 - Interior motion sensor 70
 - Switching off the alarm 69
 - Tow-away protection 70
 - ATTENTION ASSIST**
 - Activating/deactivating 219
 - Display message 245
 - Function/notes 195
 - Audio menu (on-board computer)** 214
 - AUTO lights**
 - Display message 242
 - see Lights
 - Automatic engine start (ECO start/stop function)** 147
 - Automatic engine switch-off (ECO start/stop function)** 146
 - Automatic headlamp mode** 105
 - Automatic transmission**
 - Accelerator pedal position 154
 - Automatic drive program 156
 - Changing gear 154
 - DIRECT SELECT lever 151
 - Display message 252
 - Drive program display 152
 - Driving tips 154
 - Emergency running mode 159
 - Engaging drive position 153
 - Engaging neutral 153
 - Engaging park position (AMG vehicles) 153
 - Engaging reverse gear 153
 - Engaging the park position 152
 - Holding the vehicle stationary on uphill gradients 154
 - Kickdown 154
 - Manual drive program 156
 - Overview 151
 - Problem (fault) 159
 - Program selector button 155
 - Pulling away 144
 - Selector lever 153
 - Starting the engine 144
 - Steering wheel gearshift paddles ... 156
 - Trailer towing 155
 - Transmission position display 152, 153
 - Transmission positions 153
 - Automatic transmission emergency running mode** 159
 - Auxiliary heating**
 - Activating/deactivating 134
 - Activating/deactivating (on the centre console) 135
 - Display message 255
 - Important safety notes 134
 - Problem (display message) 138
 - Remote control 135
 - Setting 224
 - Setting the departure time 136
 - Auxiliary ventilation**
 - Activating/deactivating 134
 - Activating/deactivating (on the centre console) 135
 - Problem (display message) 138
 - Remote control 135
 - Axle load, permissible (trailer towing)** 349
- B
- Bag hook** 273
 - Ball coupling**
 - Folding in 205
 - Folding out 203
 - BAS (Brake Assist System)** 62
 - Battery (key)**
 - Checking 76
 - Important safety notes 76
 - Replacing 76
 - Battery (vehicle)**
 - Charging 306
 - Display message 244
 - Important safety notes 304
 - Jump starting 308
 - Belt force limiter**
 - Activation 49
 - Function 49
 - Belt tensioner**
 - Activation 41
 - Function 49
 - Blind Spot Assist**
 - Activating/deactivating 219
 - Display message 247

- Notes/function 198
 - Trailer towing 199
 - Bonnet**
 - Active bonnet (pedestrian protection) 284
 - Closing 286
 - Display message 254
 - Important safety notes 284
 - Opening 285
 - Boot**
 - see Tailgate
 - Boot load (maximum)** 346
 - Brake Assist System**
 - see BAS (Brake Assist System)
 - Brake fluid**
 - Display message 236
 - Notes 344
 - Brake lamps**
 - Adaptive 65
 - Changing bulbs 116
 - Display message 240
 - Brakes**
 - ABS 61
 - Adaptive Brake Assist 64
 - BAS 62
 - Brake fluid (notes) 344
 - Display message 230
 - Driving tips 166
 - Important safety notes 166
 - Parking brake 163
 - Warning lamp 258
 - Breakdown**
 - see Flat tyre
 - see Towing away/tow-starting
 - Bulbs**
 - see Replacing bulbs
- C
- Calling up a fault**
 - see Display messages
 - Car**
 - see Vehicle
 - Care**
 - Automatic car wash 291
 - Carpets 296
 - Display 295
 - Exhaust pipe 294
 - Exterior lighting 293
 - Gear or selector lever 295
 - High-pressure cleaner 291
 - Interior 295
 - Matt paintwork 292
 - Notes 290
 - Paint 292
 - Plastic trim 295
 - Reversing camera 294
 - Roof lining 296
 - Seat belt 296
 - Seat cover 296
 - Sensors 294
 - Steering wheel 295
 - Trim pieces 295
 - Washing by hand 291
 - Wheels 292
 - Windows 293
 - Wiper blades 293
 - Wooden trim 295
 - Car wash (care)** 291
 - Central locking**
 - Automatic locking (on-board computer) 223
 - Locking/unlocking (key) 75
 - Centre console**
 - Lower section 35
 - Upper section 34
 - Changing bulbs**
 - Brake lamps 116
 - Cornering light function 115
 - Dipped-beam headlamps 114
 - Main-beam headlamps 114
 - Rear foglamp 116
 - Reversing lamps 116
 - Tail lamps 116
 - Turn signals (front) 115
 - Turn signals (rear) 116
 - Child-proof locks**
 - Important safety notes 60
 - Rear doors 60
 - Children**
 - In the vehicle 50
 - Restraint systems 50
 - Child seat**
 - Automatic recognition 52
 - ISOFIX 53
 - On the front-passenger seat 51

- Problem (malfunction) 56
- Recommendations 58
- Suitable positions 56
- Top Tether 54
- Cigarette lighter** 278
- Cleaning**
- Trailer tow hitch 294
- Climate control**
- Auxiliary heating/ventilation 134
- Controlling automatically 128
- Convenience opening/closing (air-recirculation mode) 132
- Cooling with air dehumidification . . 126
- Demisting the windows 130
- Demisting the windscreen 130
- Important safety notes 122
- Indicator lamp 128
- Notes on using THERMATIC automatic climate control 123
- Notes on using THERMOTRONIC automatic climate control 125
- Overview of systems 122
- Problems with cooling with air dehumidification 128
- Problem with the rear window heating 132
- Setting the air distribution 129
- Setting the airflow 129
- Setting the air vents 139
- Setting the temperature 128
- Switching air-recirculation mode on/off 132
- Switching on/off 126
- Switching residual heat on/off 133
- Switching the rear window heating on/off 131
- Switching the ZONE function on/off 129
- THERMATIC automatic climate control 123
- THERMOTRONIC (2-zone) automatic climate control 125
- Cockpit**
- Overview 28
- see Instrument cluster
- COLLISION PREVENTION ASSIST**
- Activating/deactivating the distance warning function 218
- Display message 230
- Operation/notes 62
- COMAND Online**
- see separate operating instructions
- Combination switch** 107
- Consumption statistics (on-board computer)** 211
- Convenience closing feature** 85
- Convenience opening/closing (air-recirculation mode)** 132
- Convenience opening feature** 85
- Coolant (engine)**
- Checking the level 288
- Display message 243
- Important safety notes 344
- Temperature (on-board computer) . 226
- Temperature gauge 208
- Warning lamp 264
- Cooling**
- see Climate control
- Cornering lamps**
- Changing bulbs 115
- Cornering light function**
- Display message 239
- Function/notes 109
- Crash-responsive emergency lighting** 112
- Cruise control**
- Activation conditions 169
- Cruise control lever 169
- Deactivating 170
- Display message 250
- Driving system 168
- Important safety notes 168
- LIM indicator lamp 169
- Selecting 169
- Setting a speed 170
- Storing and maintaining current speed 169
- Cup holder**
- Centre console 276
- Important safety notes 275
- Rear compartment 276

D

Dashboard

see Instrument cluster

Dashboard lighting

see Instrument cluster lighting

Data

see Technical data

Daytime driving lights

Display message 242

Switching on/off (on-board computer) 221

Switching on/off (switch) 105

Dealership

see Qualified specialist workshop

Declarations of conformity 23**Delayed switch-off**

Exterior lighting (on-board computer) 222

Interior lighting 223

Diagnostics connection 23**Diesel** 341**Digital speedometer** 212**Dipped-beam headlamps**

Changing bulbs 114

Display message 239

Setting for driving abroad (symmetrical) 104

Setting for driving on the right/left 221

Switching on/off 105

DIRECT SELECT lever

see Automatic transmission

Display (cleaning instructions) 295**Display message**

ASSYST PLUS 289

General information 229

Hiding (on-board computer) 229

Display messages

Calling up (on-board computer) 229

Driving systems 245

Engine 243

Key 256

Lights 239

Safety systems 230

Tyres 251

Vehicle 252

Distance recorder

see Trip meter

Distance warning function

Activating/deactivating 218

Function/notes 62

Warning lamp 266

DISTRONIC PLUS

Activation conditions 175

Cruise control lever 174

Deactivating 177

Display message 249

Displays in the multifunction display 175

Driving tips 178

Function/notes 174

Important safety notes 173

Selecting 175

Setting the specified minimum distance 177

Warning lamp 266

Door

Automatic locking (on-board computer) 223

Automatic locking (switch) 81

Central locking/unlocking (key) 75

Control panel 37

Display message 254

Emergency locking 81

Emergency unlocking 81

Important safety notes 79

Opening (from the inside) 80

Drive program

Automatic 156

Display 153

Display (DIRECT SELECT lever) 152

Manual 156

Driver's door

see Door

Driving abroad

Service24h 290

Symmetrical dipped beam 104

Driving on flooded roads 167**Driving safety system**

Adaptive Brake Assist 64

COLLISION PREVENTION ASSIST 62

Distance warning function 62

Electronic Brake-force Distribution .. 69

ESP® (Electronic Stability Program) 65, 66

ETS/4ETS (Electronic Traction System)	65	E	
Important safety guidelines	61	EASY-VARIO-PLUS system	
Driving safety systems		Luggage compartment enlarge- ment	272
ABS (Anti-lock Braking System)	61	EBD (electronic brake force distri- bution)	
ADAPTIVE BRAKE	69	Display message	232
Adaptive brake lamps	65	Function/notes	69
BAS (Brake Assist System)	62	ECO display	
Overview	61	Function/notes	165
Steering assistant STEER CON- TROL	69	On-board computer	212
Driving system		ECO start/stop function	
Active Parking Assist	186	Automatic engine start	147
Driving systems		Automatic engine switch-off	146
ATTENTION ASSIST	195	Deactivating/activating	147
Blind Spot Assist	197	General information	146
Cruise control	168	Important safety notes	146
Display message	245	Introduction	145
Distronic Plus	173	Electrical fuses	
HOLD function	179	see Fuses	
Lane Keeping Assist	199	Electronic Stability Program	
Lane package	197	see ESP® (Electronic Stability Program)	
PARKTRONIC	182	Emergency key	
RACE START (AMG vehicles)	181	Unlocking the driver's door	81
Reversing camera	191	Emergency key element	
Speed Limit Assist	196	Function/notes	75
SPEEDTRONIC	171	Locking vehicle	81
Driving tips		Emergency release	
Aquaplaning	167	Driver's door	81
Automatic transmission	154	Emergency spare wheel	
Brakes	166	General notes	332
DISTRONIC PLUS	178	Important safety notes	332
Downhill gradient	166	Removing	332
Driving abroad	104	Technical data	333
Driving in winter	167	Emergency unlocking	
Driving on flooded roads	167	Tailgate	83
Driving on wet roads	167	Vehicle	81
General	165	Engine	
Icy road surfaces	168	Display message	243
Limited braking efficiency on sal- ted roads	167	ECO start/stop function	145
New brake pads/linings	167	Engine number	338
Running-in tips	142	Jump-starting	308
Snow chains	321	Running irregularly	149
Symmetrical dipped beam	104	Starting problems	149
Towing a trailer	201	Starting the engine with the key	144
Wet road surface	166	Stopping	162
DVD audio (on-board computer)	215		

- Tow-starting (vehicle) 314
- Warning lamp (engine diagnostics) 264
- Engine electronics**
- Notes 336
- Problem (fault) 149
- Engine oil**
- Additives 344
- Checking the oil level 286
- Checking the oil level using the dipstick 287
- Display message 245
- Filling capacity 343
- Notes about oil grades 343
- Notes on oil level/consumption ... 286
- Temperature (on-board computer) . 226
- Topping up 287
- Viscosity 344
- Environmental protection**
- Returning an end-of-life vehicle 21
- ESP® (Electronic Stability Program)**
- AMG menu (on-board computer) ... 226
- Deactivating/activating (AMG vehicles) 66
- Deactivating/activating (except AMG vehicles) 218
- Deactivating/activating (notes; except AMG vehicles) 68
- Display message 230
- ETS/4ETS 65
- Function/notes 65, 66
- Important safety guidelines 65
- Trailer stabilisation 68
- Warning lamp 260
- ETS/4ETS (Electronic Traction System)** 65
- Exhaust pipe (cleaning instructions)** 294
- Exterior lighting**
- Settings options 105
- see Lights
- Exterior mirrors**
- Adjusting 99
- Anti-dazzle mode (automatic) 100
- Folding in/out (automatically) 100
- Folding in/out (electrically) 99
- Folding in when locking (on-board computer) 225
- Out of position (troubleshooting) ... 100
- Parking position 100
- Resetting 99
- Storing settings (memory function) 101

F

- Fault message**
- see Display messages
- Filler cap**
- see Fuel filler flap
- Fire extinguisher** 299
- First-aid kit** 298
- Fitting a wheel**
- Removing a wheel 328
- Fitting wheels**
- Fitting a wheel 328
- Lowering the vehicle 329
- Preparing the vehicle 325
- Raising the vehicle 326
- Securing the vehicle against rolling away 325
- Flat tyre**
- MOExtended tyres 300
- Preparing the vehicle 300
- TIREFIT kit 301
- see Emergency spare wheel
- Floormat** 281
- Foglamps**
- Extended range 109
- Switching on/off 106
- Frequencies**
- Mobile phone 336
- Two-way radio 336
- Front foglamps**
- Display message 241
- Fuel**
- Additives 341
- Consumption information 342
- Consumption statistics 211
- Displaying the current consumption 212
- Displaying the range 212
- Fuel gauge 30
- Grade (petrol) 340
- Important safety notes 339
- Notes for AMG vehicles 340
- Problem (malfunction) 161
- Quality (diesel) 341

Refuelling	159
Tank content/reserve fuel	339
Fuel filler flap	
Opening/closing	160
Fuel filter (white display message) .	245
Fuel level	
Calling up the range (on-board computer)	212
Gauge	30
Fuel reserve	
see Fuel	
Fuel tank	
Capacity	339
Problem (malfunction)	161
Fuses	
Allocation chart	315
Before changing	314
Fuse box in the engine compartment	315
Fuse box in the front-passenger footwell	315
Important safety notes	314

G

Gear indicator (on-board computer)	226
Gear or selector lever (cleaning instructions)	295
Gearshift program	
SETUP (on-board computer)	226
Genuine Mercedes-Benz parts	21
Glove compartment	269

H

Handbrake	
see Parking brake	
Hazard warning lamps	108
Display message	256
Headlamp	
Cleaning system (function)	108
Cleaning system (notes)	345
Headlamps	
Misting up	111
Topping up the cleaning system	289
see Automatic headlamp mode	

Head restraints

Adjusting	94
Adjusting (electrically)	95
Adjusting (manually)	95
Adjusting (rear)	96
Fitting/removing (rear)	96

Heating

 see Climate control

High-pressure cleaners	291
-------------------------------------	-----

Hill start assist	145
--------------------------------	-----

HOLD function

Deactivating	180
Display message	246
Function/notes	180

I

Ignition lock

 see Key positions

Immobiliser	69
--------------------------	----

Indicator and warning lamps

Coolant	264
DISTRONIC PLUS	266
Engine diagnostics	264
SPORT handling mode	261

Indicator lamps

Display message	240
see Warning and indicator lamps	

Inspection

 see ASSYST PLUS

Instrument cluster

Overview	30
Settings	220
Warning and indicator lamps	32

Instrument cluster lighting	208
--	-----

Intelligent Light System

Activating/deactivating	221
Display message	242
Overview	108
Setting the dipped-beam headlamps for driving on the right/left .	221

Interior lighting	111
--------------------------------	-----

Automatic control system	111
Delayed switch-off (on-board computer)	223
Emergency lighting	112
Manual control	112
Overview	111

Reading lamp	111
Setting the ambient lighting brightness (on-board computer)	222
Interior motion sensor	70
ISOFIX child seat securing system	53

J

Jack

Storage location	299
Using	326
Jump starting (engine)	308

K

Key

Changing the battery	76
Checking the battery	76
Convenience closing feature	85
Convenience opening feature	85
Display message	256
Door central locking/unlocking	75
Emergency key element	75
Important safety notes	74
Loss	78
Modifying the programming	75
Positions (ignition lock)	143
Problem (malfunction)	78
Starting the engine	144
Key positions (ignition lock)	143
Kickdown	
Driving tips	154
Manual drive program	158
Kneebag	44

L

Lamps

see Warning and indicator lamps

Lane Keeping Assist

Activating/deactivating	219
Display message	247
Function/information	199

Lane package	197
---------------------------	-----

Lap time (RACETIMER)	226
-----------------------------------	-----

Lashing eyelets	273
------------------------------	-----

Licence plate lamp (display message)	241
---	-----

Lighting

see Lights

Lights

Activating/deactivating the Intelligent Light System	221
Activating/deactivating the interior lighting delayed switch-off	223
Active light function	109
Automatic headlamp mode	105
Cornering light function	109
Dipped-beam headlamps	105
Display message	239
Driving abroad	104
Foglamps	106
Foglamps (extended range)	109
Hazard warning lamps	108
Headlamp flasher	108
Headlamp range	107
Light switch	105
Main-beam headlamps	107
Motorway mode	109
Parking lamps	106
Rear foglamp	106
Setting the ambient lighting brightness (on-board computer)	222
Side lamps	106
Switching Adaptive Highbeam Assist on/off	222
Switching the daytime driving lights on/off (on-board computer) .	221
Switching the daytime driving lights on/off (switch)	105
Switching the exterior lighting delayed switch-off on/off (on-board computer)	222
Switching the surround lighting on/off (on-board computer)	222
Turn signals	107
see Interior lighting	
see Replacing bulbs	
Light sensor (display message)	242
LIM indicator lamp	
Cruise control	169
DISTRONIC PLUS	174
Variable SPEEDTRONIC	171
Limiting the speed	
see SPEEDTRONIC	
Loading guidelines	268

- Locking**
see Central locking
- Locking (doors)**
Automatic 81
Emergency locking 81
From inside (central locking button) 80
- Locking centrally**
see Central locking
- Locking verification signal (on-board computer)** 223
- Luggage compartment enlargement** 272
Important safety notes 272
- Luggage compartment floor**
Important safety notes 274
opening/closing 274
stowage well, under 274
- Luggage net** 271
- Lumbar support**
Adjusting the 4-way lumbar support 96
- M**
- M+S tyres** 320
- Main-beam headlamps**
Changing bulbs 114
Display message 241
Switching Adaptive Highbeam Assist on/off 110
Switching on/off 107
- Maintenance**
see ASSYST PLUS
- Manual transmission**
Engaging reverse gear 151
Gear lever 150
Pulling away 144
Shifting to neutral 151
Shift recommendation 151
Starting the engine 144
- Matt finish (cleaning instructions)** .. 292
- Memory card (audio)** 215
- Memory function** 101
- Mercedes-Benz Service Centre**
see Qualified specialist workshop
- Message memory (on-board computer)** 229
- Messages**
see Display messages
- Mirror**
see Vanity mirror (in sun visor)
- Mirrors**
see Exterior mirrors
see Rear-view mirror
- Mobile phone**
Frequencies 336
Installation 336
Menu (on-board computer) 215
Notes/placing in the bracket 279
Transmission output (maximum) 336
- Mobile telephone**
Pre-installed bracket 281
- Modifying the programming (key)** 75
- MOExtended tyres** 300
- Motorway mode** 109
- MP3**
Operating 215
see Separate operating instructions
- Multifunction display**
Function/notes 210
Permanent display 220
- Multifunction steering wheel**
Operating the on-board computer . 209
Overview 33
- N**
- Navigation**
Menu (on-board computer) 213
see separate operating instructions
- Notes on running in a new vehicle** .. 142
- O**
- Occupant safety**
Children in the vehicle 50
Important safety notes 40
- Odometer** 211
see Total distance recorder
see Trip meter
- Oil**
see Engine oil
- On-board computer**
AMG menu 226
Assistance menu 217

- Audio menu 214
 - Convenience submenu 225
 - Displaying a service message 290
 - Display messages 229
 - Factory setting submenu 225
 - Heating submenu 224
 - Important safety notes 208
 - Instrument cluster submenu 220
 - Light submenu 221
 - Menu overview 211
 - Message memory 229
 - Navigation menu 213
 - Operating the TV 215
 - Operating video DVD 215
 - Operation 209
 - RACETIMER 226
 - Service menu 219
 - Settings menu 220
 - Standard display 211
 - Telephone menu 215
 - Trip menu 211
 - Vehicle submenu 223
 - Opening and closing the side trim panels** 115
 - Operating system**
see On-board computer
 - Outside temperature display** 209
 - Overhead control panel** 36
 - Override feature**
Rear side windows 61
- P**
- Paint code** 338
 - Paintwork (cleaning instructions)** ... 292
 - Panorama sliding sunroof**
Important safety information 86
Opening/closing 87
Opening/closing the roller sun-blind 89
Problem (malfunction) 89
Rain closing feature 88
Resetting 89
 - Parking** 162
Important safety notes 162
Parking brake 163
 - Position of exterior mirror, front-passenger side 100
 - Reversing camera 191
see Active Parking Assist
see PARKTRONIC
 - Parking aid**
Active Parking Assist 186
see Exterior mirrors
see PARKTRONIC
 - Parking brake**
Display message 233
Electric parking brake 163
Warning lamp 263
 - Parking lamps**
Display message 241
Switching on/off 106
 - PARKTRONIC**
Deactivating/activating 185
Driving system 182
Function/notes 182
Important safety notes 182
Problem (fault) 186
Sensor range 183
Trailer towing 185
Warning display 184
 - PASSENGER AIRBAG OFF warning lamp** 52
 - Petrol** 340
 - Plastic trim (cleaning instructions)** . 295
 - Power windows**
see Side windows
 - PRE-SAFE® (preventive occupant safety system)**
Display message 236
Operation 45
 - Program selector button** 155
 - Protection of the environment**
General notes 21
 - Pulling away**
Automatic transmission 144
Manual transmission 144
Trailer 145
- Q**
- Qualified specialist workshop** 24

- R**
- RACE START (AMG vehicles)** 181
 - RACETIMER (on-board computer)** 226
 - Radar sensor system**
 - Activating/deactivating 223
 - Country overview 350
 - Display message 246
 - Radio**
 - Selecting a station 214
 - see separate operating instructions
 - Rain closing feature (panorama sliding sunroof)** 88
 - Reading lamp** 111
 - Rear bench seat**
 - Folding the backrest forwards/back 272
 - Rear compartment**
 - Setting the air vents 140
 - Rear-compartment seat belt status indicator** 49
 - Rear foglamp**
 - Changing bulbs 116
 - Display message 241
 - Switching on/off 106
 - Rear lamps**
 - Changing bulbs 116
 - see Lights
 - Rear shelf** 273
 - Rear-view mirror**
 - Anti-dazzle mode (automatic) 100
 - Dipping (manual) 98
 - Rear window heating**
 - Problem (fault) 132
 - Switching on/off 131
 - Rear window wiper**
 - Replacing the wiper blade 119
 - Switching on/off 118
 - Refuelling**
 - Fuel gauge 30
 - Important safety notes 159
 - Notes for AMG vehicles 340
 - Refuelling process 160
 - see Fuel
 - Remote control**
 - Auxiliary heating/ventilation 135
 - Changing the batteries (auxiliary heating) 136
 - Replacing bulbs**
 - Important safety notes 112
 - Overview of bulb types 113
 - Removing/replacing the cover (front wheel arch) 113
 - Replacing the battery (auxiliary heating remote control)** 136
 - Reserve (fuel tank)**
 - see Fuel
 - Reserve fuel**
 - Display message 245
 - Warning lamp 264
 - Residual heat (climate control)** 133
 - Restraint system**
 - see SRS (Supplemental Restraint System)
 - Rev counter** 208
 - Reverse gear**
 - Engaging (manual transmission) 151
 - Reverse gear (selector lever)** 153
 - Reversing camera**
 - Cleaning instructions 294
 - Function/notes 191
 - Switching on/off 191
 - Reversing feature**
 - Panorama sliding sunroof 87
 - Roller sunblinds 88
 - Side windows 84
 - Reversing lamp**
 - Changing bulbs 116
 - Reversing lamps**
 - Display message 241
 - Roller sunblind**
 - Opening/closing 89
 - Panorama sliding sunroof 88
 - Roof carrier** 275
 - Roof lining and carpets (cleaning instructions)** 296
 - Roof load (maximum)** 346
 - Route (navigation)**
 - see Route guidance (navigation)
 - Route guidance (navigation)** 213

S

Safety

- Children in the vehicle 50
- Child restraint systems 50

Safety system

see Driving safety system

Seat

- Adjusting (Performance Seat) 97
- Folding the backrest (rear compartment) forwards/back 272

Seat belt

- Adjusting the driver's and front-passenger seat belt 47
- Adjusting the height 48
- Belt force limiter 49
- Belt tensioner 49
- Cleaning 296
- Display message 237
- Fastening 47
- Important safety guidelines 46
- Rear seat belt status indicator 49
- Releasing 48
- Switching belt adjustment on/off (on-board computer) 225
- Warning lamp 257
- Warning lamp (function) 48

Seats

- Adjusting (electrically) 94
- Adjusting (manually) 94
- Adjusting the 4-way lumbar support 96
- Adjusting the head restraint 94
- Cleaning the cover 296
- Correct driver's seat position 92
- Important safety notes 93
- Seat heating problem 97
- Storing settings (memory function) 101
- Switching seat heating on/off 96

Sensors (cleaning instructions) 294**Service**

see ASSYST PLUS

Service Centre

see Qualified specialist workshop

Service menu (on-board computer) . 219**Service products**

- Brake fluid 344
- Coolant (engine) 344

- Engine oil 343
- Fuel 339
- Important safety notes 338
- Washer fluid 345

Service report

see Qualified specialist workshop

Settings

- Factory (on-board computer) 225
- On-board computer 220

Setting the air distribution 129**Setting the airflow 129****SETUP (on-board computer) 226****Shifting to neutral (manual transmission) 151****Sidebag 44****Side lamps**

- Switching on/off 106

Side windows

- Convenience closing 85
- Convenience opening 85
- Important safety notes 83
- Opening/closing 84
- Problem (malfunction) 86
- resetting 85

Sliding sunroof

see Panorama sliding sunroof

Snow chains 321**Socket**

- Centre console 279
- Luggage compartment 279
- Points to observe before use 278
- Rear compartment 279

Specialist workshop 24**Spectacles compartment 269****Speed, controlling**

see Cruise control

Speed Limit Assist

- Activating/deactivating the warning function 218
- Displaying 218
- Display message 246
- Display message in the multifunction display 197
- Function/notes 196
- Important safety notes 196

- Speedometer**
- Activating/deactivating the additional speedometer 220
 - Digital 212
 - In the Instrument cluster 30
 - Segments 209
 - Selecting the unit of measurement 220
 - see Instrument cluster
- SPEEDTRONIC**
- Deactivating variable 172
 - Display message 250
 - Function/notes 171
 - Important safety notes 171
 - LIM indicator lamp 171
 - Permanent 172
 - Selecting 171
 - Storing the current speed 172
 - Variable 171
- SPORT handling mode**
- Activating/deactivating (AMG vehicles) 66
 - Warning lamp 261
- SRS (Supplemental Restraint System)**
- Display message 238
 - Introduction 41
 - Warning lamp 263
 - Warning lamp (function) 41
- Start/stop function**
- see ECO start/stop function
- Starting (engine) 143**
- STEER CONTROL 69**
- Steering (display message) 255**
- Steering wheel**
- Adjusting (manually) 98
 - Button overview 33
 - Buttons (on-board computer) 209
 - Cleaning 295
 - Gearshift paddles 156
 - Important safety notes 98
- Steering wheel gearshift paddles 156**
- Stopwatch (RACETIMER) 226**
- Stowage areas 269**
- Stowage compartment**
- Spectacles compartment 269
- Stowage compartments**
- Armrest (front) 270
 - Armrest (under) 270
 - Centre console 269
 - Centre console (rear) 271
 - Cup holder 275
 - Glove compartment 269
 - Important safety information 269
 - Luggage net 271
 - Under driver's seat/front-passenger seat 270
- Summer tyres 320**
- Sun visor 277**
- Supplemental Restraint System**
- see SRS (Supplemental Restraint System)
- Surround lighting (on-board computer) 222**
- Switching off the alarm (ATA) 69**

T

Tailgate

- Display message 254
- Emergency unlocking 83
- Important safety notes 82
- Opening/closing (from outside) 82
- Opening dimensions 346

Tail lamps

- Display message 241
- see Lights

Technical data

- Capacities 338
- Emergency spare wheel 333
- Information 336
- Trailer loads 349
- Tyres/wheels 329
- Vehicle data 346

Telephone

- Accepting a call 216
- Display message 256
- Menu (on-board computer) 215
- Number from the phone book 216
- Redialling 217
- Rejecting/ending a call 216
- Telephone compartment 270

Temperature

- Coolant 208
- Coolant (on-board computer) 226
- Engine oil (on-board computer) 226

- Outside temperature 209
- Setting (climate control) 128
- TEMPOMAT**
- Function/notes 168
- Theft-deterrent system**
- ATA (Anti-Theft Alarm system) 69
- Immobiliser 69
- Through-loading** 271
- Time**
- see Separate Owner's manual
- Timing (RACETIMER)** 226
- TIREFIT kit** 301
- Top Tether** 54
- Tow-away protection** 70
- Towing**
- Important safety notes 310
- Towing a trailer**
- Active Parking Assist 190
- Axle load, permissible 349
- Bulb failure indicator for LED lamps 206
- ESP® (Electronic Stability Program) . 68
- Pulling away with a trailer 145
- Trailer tow hitch display message .. 255
- Towing away**
- Fitting the towing eye 311
- Removing the towing eye 312
- With both axles on the ground 312
- With front axle raised 312
- Tow-starting**
- Emergency engine starting 314
- Fitting the towing eye 311
- Important safety notes 310
- Removing the towing eye 312
- Trailer coupling**
- see Towing a trailer
- Trailer towing**
- 7-pin connector 206
- Blind Spot Assist 199
- Cleaning the trailer tow hitch 294
- Coupling up a trailer 204
- Decoupling a trailer 204
- Driving tips 201
- Folding in the ball coupling 205
- Folding out the ball coupling 203
- Important safety notes 201
- Lights display message 239
- Mounting dimensions 348
- Parktronic 185
- Power supply 206
- Trailer loads 349
- Transmission**
- see Automatic transmission
- see Manual transmission
- Transmission position display (DIRECT SELECT lever)** 152
- Transporting the vehicle** 313
- Trim pieces (cleaning instructions)** . 295
- Trip computer (on-board computer)** 211
- Trip meter**
- Calling up 211
- Resetting (on-board computer) 213
- Turn signals**
- Changing bulbs (front) 115
- Changing bulbs (rear) 116
- Switching on/off 107
- TV**
- Operating (on-board computer) 215
- see Separate operating instructions
- Two-way radio**
- Frequencies 336
- Installation 336
- Transmission output (maximum) 336
- Type identification plate**
- see Vehicle identification plate
- Tyre pressure**
- Display message 251
- Not reached (TIREFIT) 303
- Reached (TIREFIT) 303
- Recommended 321
- Tyre pressure loss warning**
- Important safety notes 323
- Restarting 323
- Tyres**
- Changing a wheel 324
- Checking 319
- Direction of rotation 324
- Display message 251
- Important safety notes 318
- M+S tyres 320
- MOExtended tyres 320
- Replacing 324
- Service life 319
- Storing 324
- Summer tyres 168, 320

- Tyre size (data) 329
 Tyre tread 319
 see Flat tyre
- U**
- Unladen weight** 346
- Unlocking**
 Emergency unlocking 81
 From inside the vehicle (central
 unlocking button) 80
- V**
- Vanity mirror (in sun visor)** 277
- Variable SPEEDTRONIC**
 see SPEEDTRONIC
- Vehicle**
 Correct use 24
 Data acquisition 25
 Electronics 336
 Equipment 22
 Implied warranty 24
 Individual settings 220
 Leaving parked up 164
 Locking (in an emergency) 81
 Locking (key) 75
 Lowering 329
 Pulling away 144
 Raising 326
 Registration 24
 Securing from rolling away 325
 Towing away 310
 Tow-starting 310
 Transporting 313
 Unlocking (in an emergency) 81
 Unlocking (key) 75
 Vehicle data 346
- Vehicle data** 346
- Vehicle dimensions** 346
- Vehicle emergency locking** 81
- Vehicle identification number**
 see VIN
- Vehicle identification plate** 338
- Vehicle maintenance**
 see ASSYST PLUS
- Vehicle tool kit** 299
- Vehicle weights** 346
- Video (DVD)** 215
- Video DVD (on-board computer)** 215
- VIN** 338
- W**
- Warning and indicator lamps**
 ABS 258
 Brakes 258
 Distance warning signal 266
 ESP® 260
 ESP® OFF 261
 Fuel tank 264
 LIM (cruise control) 169
 LIM (DISTRONIC PLUS) 174
 LIM (variable SPEEDTRONIC) 171
 Overview 32
 PASSENGER AIRBAG OFF 52
 Reserve fuel 264
 Seat belt 257
 SRS 263
- Warning triangle** 298
- Washer fluid**
 Display message 256
- Wheel bolt tightening torque** 329
- Wheel chock** 325
- Wheels**
 Changing/replacing 324
 Changing a wheel 324
 Checking 319
 Cleaning 292
 Cleaning (warning) 324
 Emergency spare wheel 332
 Fitting a new wheel 328
 Fitting a wheel 325
 Important safety notes 318
 Removing a wheel 328
 Storing 324
 Tightening torque 329
 Wheel size/tyre size 329
- Windowbag**
 Display message 239
 Operation 45
- Windows**
 Cleaning 293
 see Side windows
- Windscreen**
 Demisting 130

Windscreen washer fluid

see Windscreen washer system

Windscreen washer system

Notes 345

Topping up 289

Windscreen wipers

Display message 256

Problem (malfunction) 120

Rear window wiper 118

Replacing the wiper blades 118

Switching on/off 117

see Windscreen

Winter driving

General notes 320

Winter operation

Slippery road surfaces 168

Snow chains 321

Winter tyres

Limiting the speed (on-board computer) 223

M+S tyres 320

Wiper blades

Cleaning 293

Important safety notes 118

Replacing (on the rear window) 119

Replacing (windscreen) 118

Wooden trim (cleaning instructions) 295**Workshop**

see Qualified specialist workshop

Z**ZONE function**

Switching on/off 129

Protection of the environment

General notes

Environmental note

Daimler's declared policy is one of comprehensive environmental protection.

Our objectives are to use the natural resources which form the basis of our existence on this planet sparingly and in a manner which takes the requirements of both nature and humanity into consideration.

You too can help to protect the environment by operating your vehicle in an environmentally-responsible manner.

Fuel consumption and the rate of engine, transmission, brake and tyre wear depend on the following factors:

- operating conditions of your vehicle
- your personal driving style

You can influence both factors. Therefore, please bear the following in mind:

Operating conditions:

- avoid short trips, as these increase fuel consumption.
- observe the correct tyre pressure.
- do not carry any unnecessary weight in the vehicle.
- remove the roof rack once you no longer need it.
- a regularly serviced vehicle will contribute to environmental protection. You should therefore adhere to the service intervals.
- all maintenance work should be carried out at a qualified specialist workshop.

Personal driving style:

- do not depress the accelerator pedal when starting the engine.
- do not warm up the engine when the vehicle is stationary.
- drive carefully and maintain a safe distance from the vehicle in front.
- avoid frequent, sudden acceleration and braking.

- change gear in good time and use each gear only up to $\frac{2}{3}$ of its maximum engine speed.
- switch off the engine in stationary traffic.
- monitor the vehicle's fuel consumption.

Returning an end-of-life vehicle

EU countries only:

Mercedes-Benz will take back your old vehicle to dispose of it in an environmentally-responsible manner in accordance with the European Union (EU) End of Life Vehicles Directive.

There is a network of return points and disassembly plants available. You can return your vehicle to these plants free of charge. This makes a valuable contribution to the recycling process and the conservation of resources.

For further information on recycling old vehicles, recovery and the terms of the policy, visit the Mercedes-Benz homepage.

Genuine Mercedes-Benz parts

Environmental note

Daimler AG also supplies reconditioned assemblies and parts which are of the same quality as new parts. For these, the same warranty applies as for new parts.

! Airbags and seat belt tensioners, as well as control units and sensors for these restraint systems, may be installed in the following areas of your vehicle:

- doors
- door pillars
- door sills
- seats
- dashboard
- instrument cluster
- centre console

Do not install accessories such as audio systems in these areas. Do not carry out repairs or welding. You could impair the operating efficiency of the restraint systems.

Have accessories retrofitted at a qualified specialist workshop.

If you use parts, tyres and wheels as well as accessories relevant to safety which have not been approved by Mercedes, the operating safety of the vehicle could be jeopardised. This could lead to malfunctions in safety-relevant systems, e.g. the brake system. Only use genuine Mercedes-Benz parts or parts of equal quality. Only use tyres, wheels and accessories that have been specifically approved for your vehicle.

Mercedes-Benz tests genuine parts and conversion parts and accessories that have been specifically approved for your vehicle for their reliability, safety and suitability. Despite ongoing market research, Mercedes-Benz is unable to assess other parts. Mercedes-Benz accepts no responsibility for the use of such parts in Mercedes-Benz vehicles, even if they have been independently or officially approved.

In Germany, certain parts are only officially approved for installation or modification if they comply with legal requirements. This also applies to some other countries. All genuine Mercedes-Benz parts meet the approval requirements. The use of non-approved parts may invalidate the vehicle's general operating permit.

This is the case:

- if they cause a change of the vehicle type from that for which the vehicle's general operating permit was granted
- if other road users could be endangered
- if the emission or noise levels are adversely affected

Always specify the vehicle identification number (VIN) (▷ page 338) and the engine number (▷ page 338) when ordering genuine Mercedes-Benz parts.

Owner's Manual

General notes

Before you first drive off, read this Owner's Manual carefully and familiarise yourself with your vehicle.

For your own safety and a longer vehicle life, follow the instructions and warning notices in this manual. Disregarding them may lead to damage to the vehicle or personal injury.

Vehicle equipment

This Owner's Manual describes all models and all standard and optional equipment available for your vehicle at the time of publication of the Owner's Manual. Country-specific differences are possible. Note that your vehicle may not be fitted with all features described. This is also the case for systems and functions relevant to safety. Therefore, the equipment on your vehicle may differ from that in the descriptions and illustrations.

The original purchase contract documentation for your vehicle contains a list of all of the systems in your vehicle.

Should you have any questions concerning equipment and operation, please consult a Mercedes-Benz Service Centre.

The Owner's Manual and Service Booklet are important documents and should be kept in the vehicle.

Operating safety

Important safety notes

WARNING

If you do not have the prescribed service/maintenance work or necessary repairs carried out, this could result in malfunctions or system failures. There is a risk of an accident.

Always have the prescribed service/maintenance work as well as necessary repairs carried out at a qualified specialist workshop.

⚠ WARNING

If you switch off the ignition while driving, safety-relevant functions are only available with limitations, or not at all. This could affect, for example, the power steering and the brake boosting effect. You will require considerably more effort to steer and brake. There is a risk of an accident.

Do not switch off the ignition while driving.

⚠ WARNING

Modifications to electronic components, their software as well as wiring could effect their function and/or the operation of other networked components. This could in particular also be the case for systems relevant to safety. They might not function properly any more and/or jeopardise the operational safety of the vehicle. There is an increased risk of an accident and injury.

Do not attempt to modify the wiring as well as electronic components or their software.

Always have work on electrical and electronic components carried out at a qualified specialist workshop.

There is a risk of damage to the vehicle if:

- the vehicle becomes stuck, e.g. on a high kerb or an unpaved road
- you drive too fast over an obstacle, e.g. a kerb or a hole in the road
- a heavy object strikes the undercarriage or parts of the chassis.

In situations like this, the body, the undercarriage, chassis parts, wheels or tyres could be damaged without the damage being visible. Components damaged in this way can unexpectedly fail or, in the case of an accident, no longer withstand the strain they are designed to.

If the underbody panelling is damaged, combustible materials such as leaves, grass or twigs can gather between the underbody and the underbody panelling. If these materials come in contact with hot parts of the exhaust

system for an extended period, they can catch fire.

Have the vehicle checked and repaired immediately at a qualified specialist workshop. If on continuing your journey you notice that driving safety is impaired, pull over and stop the vehicle immediately, paying attention to road and traffic conditions. In such cases, visit a qualified specialist workshop.

Declarations of conformity**Wireless vehicle components**

The following information applies to all components of the vehicle and the COMAND system which receive and/or transmit radio waves:

The components of this vehicle which receive and/or transmit radio waves are compliant with the basic requirements and other relevant provisions of Directive 1999/5/EC. You can obtain further information from any Mercedes-Benz Service Centre.

Electromagnetic compatibility

The electromagnetic compatibility of the vehicle components has been checked and certified according to the currently valid version of Directive 72/245/EEC or the equivalent ECE Regulation ECE-R 10.

Diagnostics connection

The diagnostics connection is only intended for the connection of diagnostic equipment at a qualified specialist workshop.

⚠ WARNING

If you connect equipment to a diagnostics connection in the vehicle, it can affect the operation of the vehicle systems. This may affect the operating safety of the vehicle. There is a risk of an accident.

Do not connect any equipment to a diagnostics connection in the vehicle.

⚠ WARNING

Objects in the driver's footwell can restrict the pedal travel or obstruct a depressed pedal. The operating and road safety of the vehicle is jeopardised. There is a risk of an accident. Make sure that all objects in the vehicle are stowed correctly, and that they cannot enter the driver's footwell. Fit the floor mats securely and as specified in order to ensure sufficient clearance for the pedals. Do not use loose floor mats.

! If the engine is switched off and equipment on the diagnostics connection is used, the starter battery may discharge.

Connecting equipment to the diagnostics connection can lead to emissions monitoring information being reset, for example. This may lead to the vehicle failing to meet the requirements of the next emissions test during the main inspection.

Qualified specialist workshop

A qualified specialist workshop has the necessary special skills, tools and qualifications to correctly carry out any necessary work on your vehicle. This particularly applies to work relevant to safety.

Observe the notes in the Service Booklet.

Always have the following work carried out at a qualified specialist workshop:

- work relevant to safety
- service and maintenance work
- repair work
- modifications, installations and conversions
- work on electronic components

Mercedes-Benz recommends that you use a Mercedes-Benz Service Centre.

Vehicle registration

Mercedes-Benz may ask its Service Centres to carry out technical inspections on certain vehicles. The quality or safety of the vehicle is improved as a result of the inspection.

Mercedes-Benz can only inform you about vehicle checks if it has your registration data. It is possible that your vehicle has not yet been registered in your name in the following cases:

- if your vehicle was not purchased at an authorised specialist dealer.
- if your vehicle has not yet been examined at a Mercedes-Benz Service Centre.

It is advisable to register your vehicle with a Mercedes-Benz Service Centre.

Inform Mercedes-Benz as soon as possible about any change in address or vehicle ownership.

Correct use

If you remove any warning stickers, you or others could fail to recognise certain dangers. Leave warning stickers in position.

Observe the following information when driving your vehicle:

- the safety notes in this manual
- the technical data in this manual
- traffic rules and regulations
- laws and safety standards pertaining to motor vehicles

Implied warranty

! Follow the instructions in this manual about the proper operation of your vehicle as well as about possible vehicle damage. Damage to your vehicle that arises from culpable contraventions against these instructions are not covered either by Mercedes-Benz implied warranty or by the New or Used-Vehicle Warranty.

Data stored in the vehicle

A number of electronic components in your vehicle contain data memories.

These data memories temporarily or permanently store technical information about:

- the vehicle's operating state
- events
- faults

This technical information generally documents the condition of a component, a module, a system or an environment.

These are, for example:

- operating conditions of system components. This includes, e.g. fluid levels.
- status messages from the vehicle and from individual vehicle components. This includes, e.g. number of wheel revolutions/speed, deceleration, lateral acceleration.
- malfunctions and faults in important system components. This includes, e.g. lights, brakes.
- reactions of the vehicle in special driving situations. This includes, e.g. deployment of an airbag, intervention of stability control systems.
- environmental conditions. This includes, e.g. the outside temperature.

This data is exclusively technical in nature and is used to:

- assist in the detection and rectification of faults and defects
- optimise vehicle functions

The data cannot be used to trace the vehicle's movements over distances travelled.

When your vehicle is serviced, this technical information can be read out from the event and fault memory.

Services include:

- repairs
- service processes

- warranty claims
- quality assurance

The information is read out by authorised employees of the service network (including manufacturers) using special diagnostic devices. You can find more information there if necessary.

After a fault has been rectified, the information in the fault memory is deleted or consecutively overwritten.

In normal vehicle operation, situations may arise in which this technical data could become personal in nature in conjunction with other information and, if necessary, on consultation of an approval official.

Examples include:

- accident reports
- vehicle damage
- witness testimonies

Further additional features which are contractually agreed with the customer likewise allow specific vehicle data to be obtained from the vehicle. Such additional features include vehicle locating in an emergency, for example.

Copyright information

General notes

You can find information on licences for free and open-source software used in your vehicle and its electronic components on the following website:

<http://www.mercedes-benz.com/opensource>

Cockpit	28
Instrument cluster	30
Multifunction steering wheel	33
Centre console	34
Overhead control panel	36
Door control panel	37

Cockpit

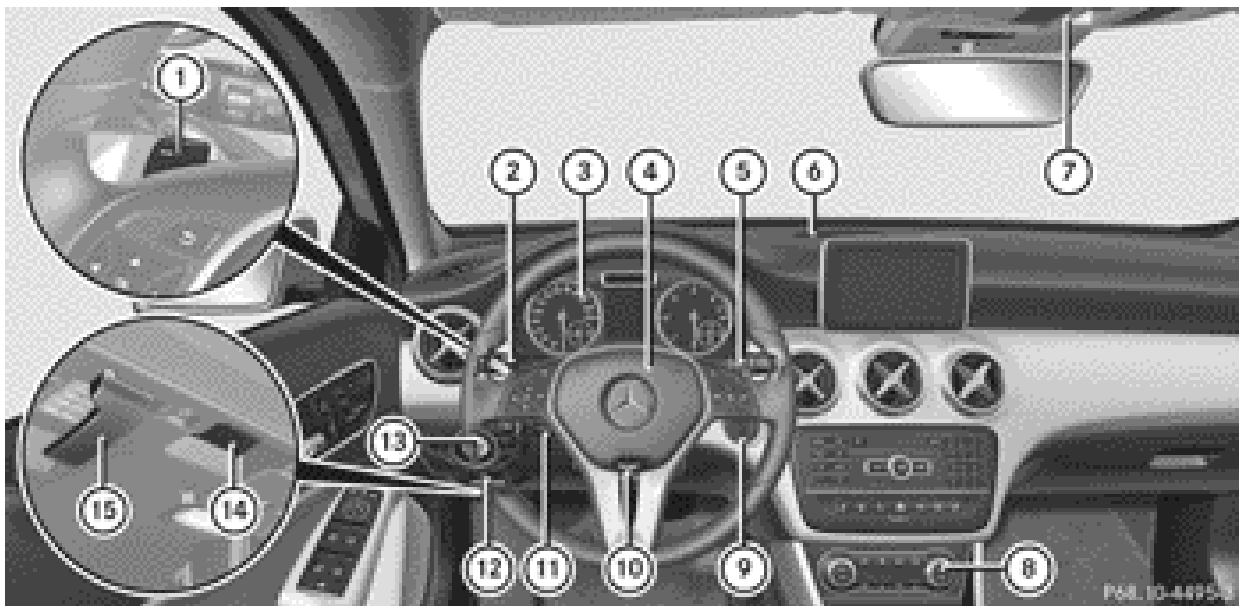

	Function	Page
①	Steering wheel gearshift paddles	156
②	Combination switch	107
③	Instrument cluster	30
④	Horn	
⑤	DIRECT SELECT lever	151
⑥	PARKTRONIC warning display	182
⑦	Overhead control panel	36
⑧	Climate control systems	122

	Function	Page
⑨	Ignition lock	143
⑩	Adjusting the steering wheel	98
⑪	Cruise control lever	169
⑫	Electric parking brake	163
⑬	Light switch	105
⑭	Diagnostics connection	23
⑮	Opening the bonnet	285

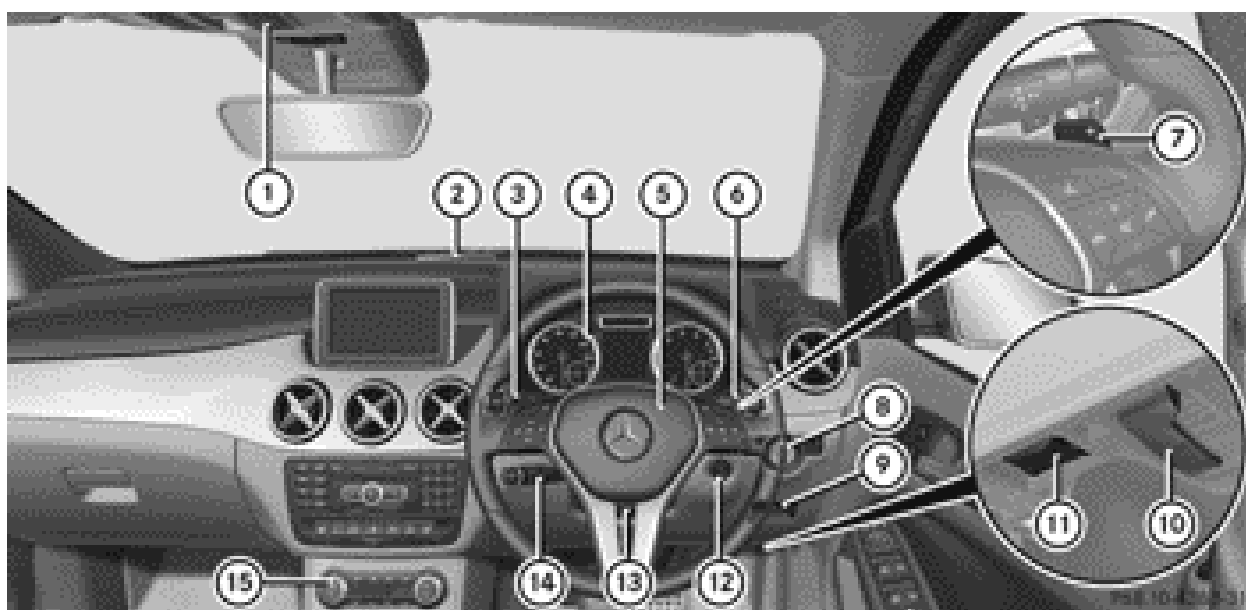

At a glance

	Function	Page
①	Overhead control panel	36
②	PARKTRONIC warning display	182
③	Combination switch	107
④	Instrument cluster	30
⑤	Horn	
⑥	DIRECT SELECT lever	151
⑦	Steering wheel gearshift paddles	156
⑧	Light switch	105

	Function	Page
⑨	Electric parking brake	163
⑩	Opening the bonnet	285
⑪	Diagnostics connection	23
⑫	Ignition lock	143
⑬	Adjusting the steering wheel	98
⑭	Cruise control lever	169
⑮	Climate control systems	122

Instrument cluster

Displays and controls



i Instrument cluster: kilometres

	Function	Page
①	Speedometer with segments	209
②	Multifunction display	210
③	Rev counter	208

	Function	Page
④	Coolant temperature	208
⑤	Fuel gauge	
⑥	Instrument cluster lighting	208



i Instrument cluster: miles

	Function	Page
①	Speedometer with segments	209
②	Multifunction display	210
③	Rev counter	208

	Function	Page
④	Coolant temperature	208
⑤	Fuel gauge	
⑥	Instrument cluster lighting	208

Warning and indicator lamps

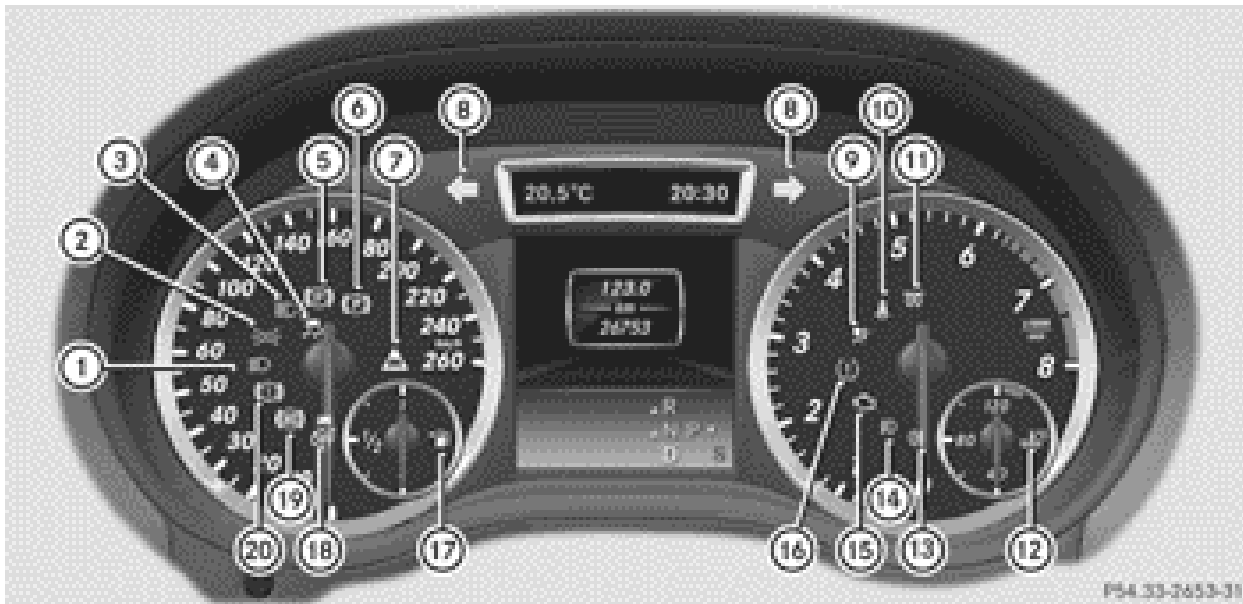





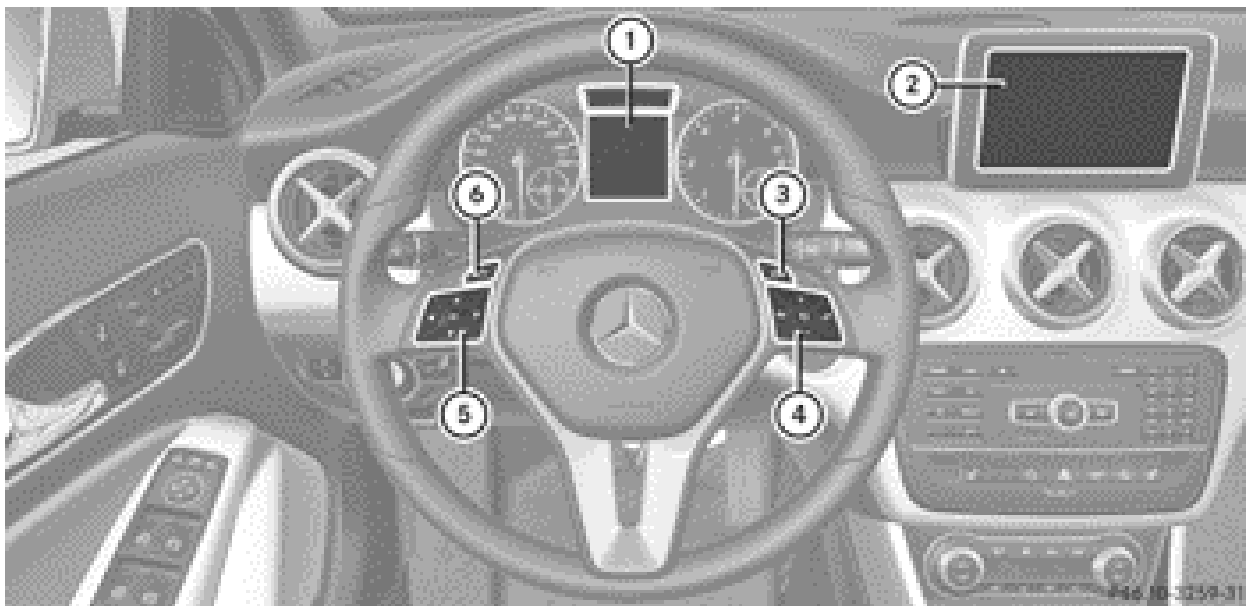

	Function	Page
①	Dipped-beam head-lamps	105
②	Side lamps	106
③	Main-beam head-lamps	107
④	ESP [®]	260
⑤	Electric parking brake (red)	263
⑥	Electric parking brake (yellow)	263
⑦	Distance warning	266
⑧	Turn signals	107
⑨	SRS	263
⑩	Seat belts	257
⑪	Diesel engine: pre- glow	144
	SPORT handling mode in AMG vehicles	261







	Function	Page
⑫	Coolant	264
⑬	Rear foglamp	106
⑭	Front foglamps	106
⑮	Engine diagnostics	264
⑯	This lamp has no func- tion	
⑰	Reserve fuel	264
⑱	ESP [®] OFF	260
⑲	ABS	258
⑳	Brakes	258

Multifunction steering wheel



At a glance





	Function	Page
①	Multifunction display	210
②	Audio/COMAND display; see the separate operating instructions	
③	 Switches on LINGUA-TRONIC; see the separate operating instructions	
④	 Rejects or ends a call Exits telephone book/redial memory  Makes or accepts a call Switches to the redial memory   Adjusts the volume  Mute	215



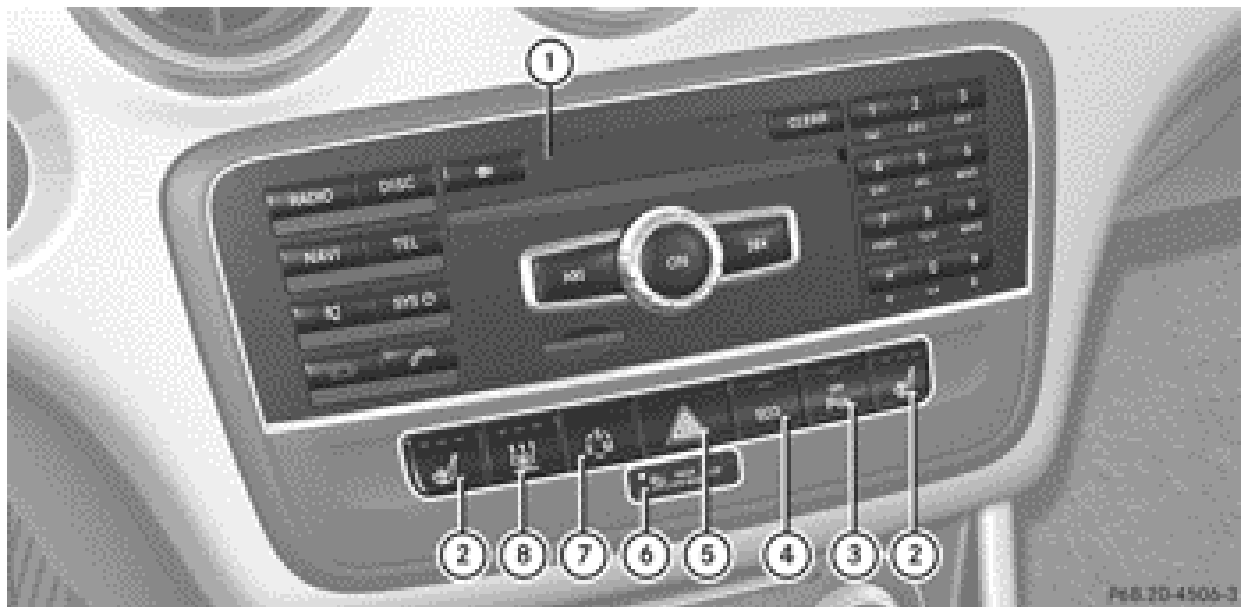

	Function	Page
⑤	  Selects a menu   Selects a submenu or scrolls through lists  Confirms the selection Hiding display messages	209 209 209 229
⑥	 Back Switches off LINGUA-TRONIC; see the separate operating instructions	209

Centre console

Centre console, upper section



	Function	Page
①	Audio system/COMAND Online; see the separate operating instructions	
②	 Seat heating	96
③	 PARKTRONIC	182
④	 ECO start/stop function	146
⑤	 Hazard warning lamps	108

	Function	Page
⑥	 PASSENGER AIRBAG OFF indicator lamp	52
⑦	 Selects the drive program	155
	 AMG vehicles: ESP®	66
⑧	 Auxiliary heating	134

Centre console, lower section

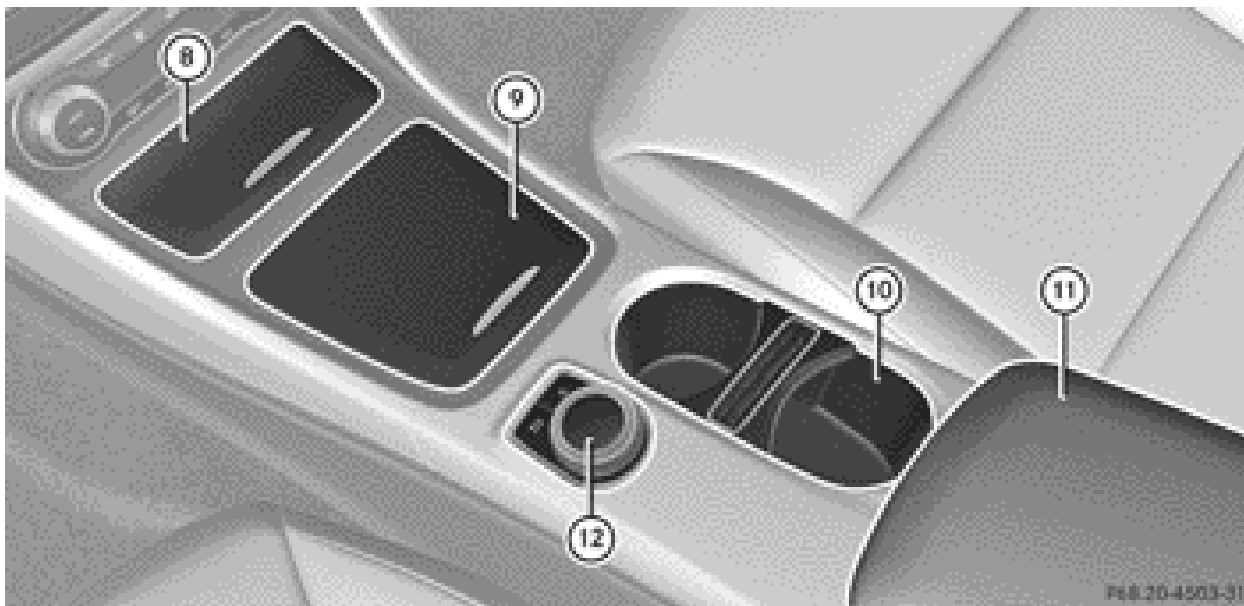

At a glance





i Vehicles with DIRECT SELECT lever



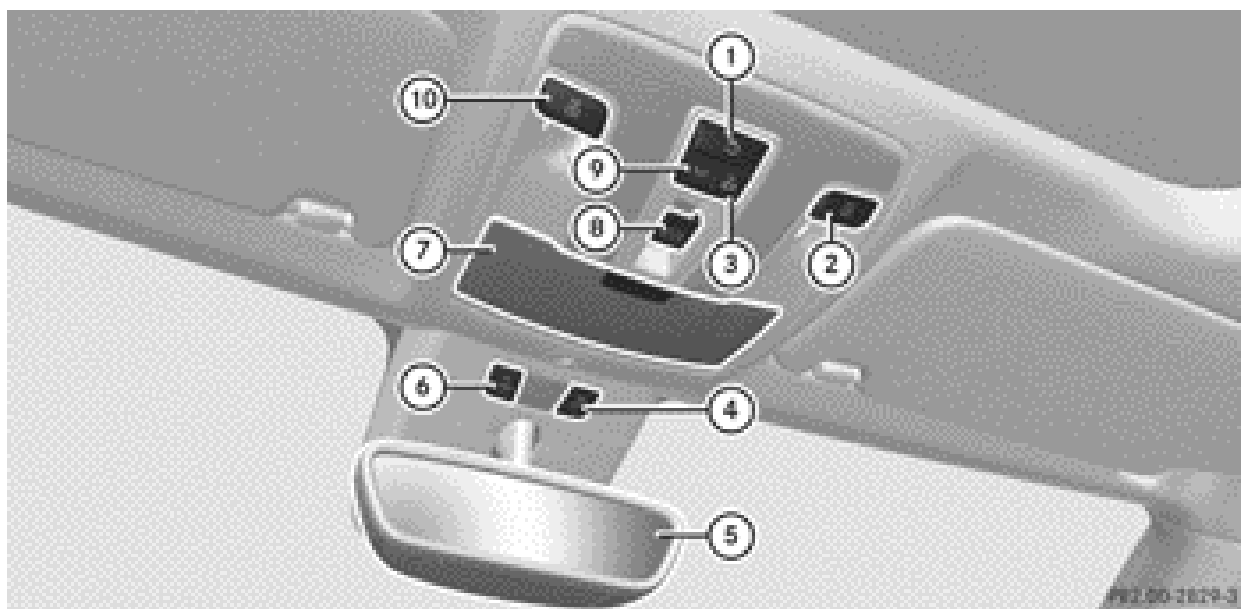

	Function	Page
⑧	Ashtray	277
	Cigarette lighter	278
	Power socket	278
	Stowage compartment	269
⑨	Stowage compartment	269

	Function	Page
⑩	Cup holders	275
⑪	Stowage compartment	269
⑫	Audio/COMAND controller; see the separate operating instructions	

Overhead control panel









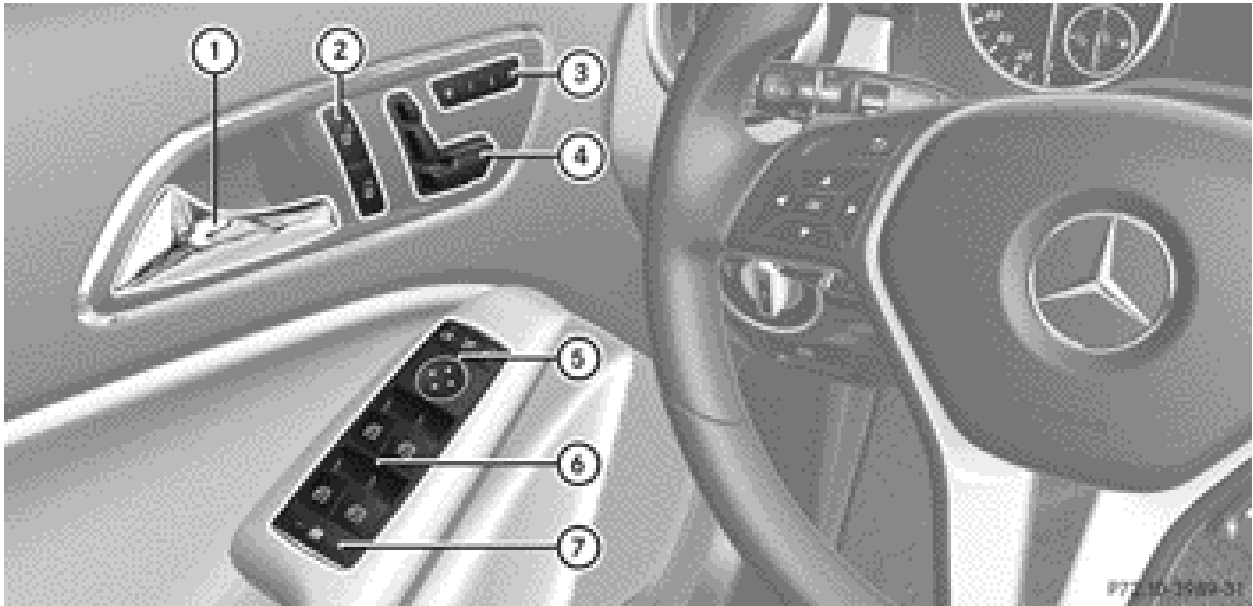



	Function	Page
①	 Switches the rear interior lighting on/off	112
②	 Switches the right-hand reading lamp on/off	111
③	 Switches the front interior lighting/automatic interior lighting control off	111
④	 Deactivates tow-away protection	70
⑤	Rear-view mirror	98



	Function	Page
⑥	 Deactivates the interior motion sensor	70
⑦	Spectacles compartment	269
⑧	 Opens/closes the panorama sliding sunroof with roller sunblinds	87
⑨	 Switches the front interior lighting on	112
⑩	 Switches the left-hand reading lamp on/off	111

Door control panel



At a glance

	Function	Page
①	Opens the door	80
②	  Unlocks/locks the vehicle	80
③	    Saves the seat and exterior mirror settings	101
④	Adjusts the seats electrically	94
⑤	    Adjusts and folds the exterior mirrors in/out electrically	99

	Function	Page
⑥	 Opens/closes the side windows	84
⑦	 Activates/deactivates the override feature for the side windows in the rear compartment	61

Useful information	40
Occupant safety	40
Children in the vehicle	50
Driving safety systems	61
Anti-theft systems	69

Useful information

- i** This Owner's Manual describes all models, series and optional equipment for your vehicle that were available at the time of going to press. National variations are possible. Note that your vehicle may not be equipped with all of the functions described. This is also the case for systems and functions relevant to safety.
- i** Read the information on qualified specialist workshops: (▷ page 24).

Occupant safety

Important safety notes

WARNING

If service work is not carried out correctly, the operating safety of your vehicle may be affected. This could cause you to lose control of your vehicle and cause an accident. Moreover, the safety systems may no longer be able to protect you or others as they are designed to do.

Always have service work carried out at a qualified specialist workshop.

WARNING

Modifications to or work performed incorrectly on the following parts can result in the restraint systems not functioning as intended:

- the restraint system, consisting of seat belts and their anchorage points, belt tensioners, belt force limiters and airbags
- the wiring
- networked electronic systems

Airbags and belt tensioners could fail to deploy or be triggered in an accident despite the deceleration force being sufficient to trigger the systems, or could be triggered unintentionally. For this reason, never make any modifications to the restraint systems.

Therefore, you must not tamper with electronic components or their software.

The seat belts, together with SRS (Supplemental Restraint System), are complementary, co-ordinated restraint systems (▷ page 41). They reduce the risk of injury in specific, pre-defined types of accident situations and thereby increase occupant safety. However, seat belts and airbags generally do not protect against objects penetrating the vehicle from the outside.

To ensure that the restraint systems can deliver their full potential protection, make sure that:

- the seat and head restraint are adjusted properly (▷ page 92)
- the seat belt has been fastened properly (▷ page 46)
- the airbags can inflate unrestricted if deployed (▷ page 42)
- the steering wheel is adjusted properly (▷ page 98)
- the restraint systems have not been modified

An airbag increases the protection of vehicle occupants wearing a seat belt. However, airbags are only an additional restraint system which complements, but does not replace, the seat belt. All vehicle occupants must wear their seat belt correctly at all times, even if the vehicle is equipped with airbags. The airbags are not deployed in all types of accidents. For example, if the protective capacity of correctly fastened seat belts is not increased by deploying the airbags, the airbags will not deploy.

Airbag deployment only provides increased protection if the seat belt is worn correctly. The seat belt helps, firstly, to keep the vehicle occupant in the best position in relation to the airbag. Secondly, in a head-on collision, for example, the seat belt prevents the vehicle occupant from being propelled towards the point of impact.

SRS (Supplemental Restraint System)

Introduction

Supplemental Restraint System (SRS) with:

- The  SRS warning lamp
- Airbags
- Airbag control unit (with crash sensors)
- Belt tensioners for the front seat belts and the outer seat belts in the rear
- Seat belt force limiters for the front seat belts and the outer seat belts in the rear



SRS reduces the risk of occupants coming into contact with parts of the vehicle's interior in the event of an accident. It can also reduce the forces to which occupants are subjected during an accident.

SRS warning lamp

WARNING

If SRS is malfunctioning, individual systems may be triggered unintentionally or might not be triggered in the event of an accident with a high rate of vehicle deceleration.

A malfunction has occurred if:

- the  SRS warning lamp does not light up when the ignition is switched on.
- the engine is running and the  SRS warning lamp does not go out after a few seconds.
- the engine is running and the  SRS warning lamp lights up again.

In this case, have SRS checked immediately at a qualified specialist workshop.

The  SRS warning lamp in the instrument cluster lights up when the ignition is switched on. It goes out no later than a few seconds after the engine is started.

SRS functions are checked regularly when the ignition is switched on or the engine is running. Therefore, malfunctions can be detected in good time.

Triggering of belt tensioners and airbags

During the first stage of a collision, the airbag control unit evaluates important physical data relating to vehicle deceleration or acceleration, such as:

- duration
- direction
- magnitude

Based on the evaluation of this data, the airbag control unit pre-emptively triggers the belt tensioners in the first stage.

If there is an even higher rate of vehicle deceleration or acceleration in a longitudinal direction, the front airbags are also deployed.

Your vehicle has adaptive, two-stage front airbags. The airbag control unit evaluates vehicle deceleration or acceleration in the event of a collision. In the first deployment stage, the front airbag is filled with enough propellant gas to reduce the risk of injuries. The front airbag is fully deployed if a second deployment threshold is reached within a few milliseconds.

The belt tensioner and airbag triggering thresholds are variable and are adapted to the detected rate of deceleration or acceleration of the vehicle. This process is pre-emptive in nature. The triggering process must take place in good time at the start of the collision.

The rate of vehicle deceleration or acceleration and the direction of the force are essentially determined by:

- the distribution of forces during the collision
- the collision angle
- the deformation characteristics of the vehicle
- the characteristics of the object with which the vehicle has collided

Factors which can only be seen and measured after a collision has occurred do not play a decisive role in the deployment of an airbag,

nor do they provide an indication of airbag deployment.

The vehicle may be deformed significantly, e.g. the bonnet or the wing, without an airbag being deployed. This is the case if only parts which are relatively easily deformed are affected and the rate of deceleration is not high. Conversely, airbags may be deployed even though the vehicle suffers only minor deformation. This is the case if, for example, very rigid vehicle parts such as longitudinal body members are hit, and sufficient deceleration occurs as a result.

i The front belt tensioners can only be triggered if the seat belt tongues on the front seats are correctly engaged in the seat belt buckles.

i Not all airbags are deployed in an accident. The different airbag systems work independently of each other.

How the airbag system works is determined by predicting the severity of the accident, especially vehicle deceleration or acceleration, and the type of accident:

- head-on collision
- side impact
- overturn

Airbags

Important safety notes

WARNING

Airbags provide additional protection; they are not, however, a substitute for seat belts.

Observe the following notes to reduce the risk of serious or even fatal injury caused by airbag deployment:

- all vehicle occupants – in particular, pregnant women – must wear their seat belt correctly at all times and lean back against the backrest, which should be positioned as close to the vertical as possible. The

head restraint must support the back of the head at about eye level.

- always secure children less than 1.50 m tall or under 12 years of age in suitable child restraint systems.
- all vehicle occupants must select a seat position that is as far away from the airbag as possible. The driver's seat position must allow the vehicle to be driven safely. The driver's chest should be as far away from the centre of the driver's airbag cover as possible.
- move the front-passenger seat as far back as possible. This is especially important if you have secured a child in a child restraint system on the front-passenger seat.
- vehicle occupants – in particular, children – must not lean their head into the area of the window in which the sidebag/windowbag is deployed.
- rearward-facing child restraint systems must not be fitted to the front-passenger seat unless the front-passenger airbag has been disabled. On the front-passenger seat, the front-passenger airbag is disabled if a child restraint system with a transponder for automatic child seat recognition is fitted to the front-passenger seat in a vehicle equipped with automatic child seat recognition. The  PASSENGER AIRBAG OFF indicator lamp must be continuously lit.

If the front-passenger seat of your vehicle does not have automatic child seat recognition, or your rearward-facing child restraint system does not have a transponder for automatic child seat recognition, children must be secured in a child restraint system on a suitable seat in the rear. If you secure a forward-facing child restraint system to the front-passenger seat, you must move the front-passenger seat as far back as possible.

- make sure there are no heavy or sharp-edged objects in the pockets of clothing.

- do not lean forwards, e.g. over the cover of the driver's/front-passenger front airbag, particularly when the vehicle is in motion.
- do not put your feet on the dashboard.
- only hold the steering wheel on the outside. This allows the airbag to be fully deployed. You could be injured if the airbag is deployed and you are holding the inside of the steering wheel.
- do not lean on the doors from inside the vehicle.
- make sure that there are no people, animals or objects between the vehicle occupants and the area where the airbags are deployed.
- do not place any objects between the seat backrest and the door.
- do not hang any hard objects, e.g. coat hangers, on the grab handles or coat hooks.
- do not attach accessories, e.g. cup holders, to the doors.

It is not possible to rule out a risk of injury being caused by an airbag, due to the high speed at which the airbag must be deployed.

WARNING

Airbag functionality can only be assured if the following parts are not covered and no badges or stickers are attached to them:

- padded steering wheel boss
- kneebag cover below the steering column
- front-passenger airbag cover
- outer side of front seat bolsters
- side trim next to the rear seat backrest
- roof frame cover between the front A-pillar and the C-pillar in the rear compartment

WARNING

When an airbag deploys, a small amount of powder is released. The powder may cause short-term breathing difficulties to persons suffering from asthma or other pulmonary conditions.

In order to prevent potential breathing difficulties, you should leave the vehicle as soon as it is safe to do so. You can also open the window to allow fresh air to enter the vehicle interior. The powder does not constitute a health hazard and does not indicate that there is a fire in the vehicle.

WARNING

The airbag parts are hot after the airbag has been deployed. Do not touch them as you could burn yourself.

Have the airbags replaced at a qualified specialist workshop. Otherwise, occupants are not protected by the airbags in the event of another accident.

Airbag deployment slows down and restricts the movement of the vehicle occupant.

If the airbags are deployed, you will hear a bang and a small amount of powder may also be released. Only in rare cases will the bang affect your hearing. The powder that is released generally does not constitute a health hazard. The  SRS warning lamp lights up.

The airbag installation locations are identified by the AIRBAG symbol.

Front airbags

! Do not place heavy objects on the front-passenger seat. The system may then detect that the seat is occupied and if there is an accident, the restraint systems on the front-passenger side could be deployed. Have restraint systems that have been triggered replaced.

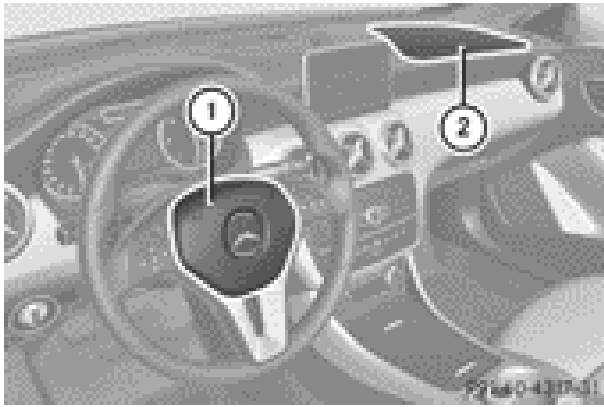

Driver's airbag ① deploys in front of the steering wheel; front-passenger front airbag ② deploys in front of and above the glove compartment.

The front airbags increase protection for the driver's and front-passenger's head and chest.

They are deployed:

- at the start of an accident with a high rate of vehicle acceleration or deceleration in a longitudinal direction
- if the system determines that airbag deployment can offer additional protection to that provided by the seat belt
- depending on whether the seat belt is being used
- independently of other airbags in the vehicle

If the vehicle overturns, the front airbags are generally not deployed.

Vehicles with automatic child seat recognition in the front-passenger seat: front-passenger airbag ② is only activated if the system determines that the front-passenger seat is occupied. The  PASSENGER AIRBAG OFF indicator lamp on the centre console does not light up (▷ page 52).

If a child restraint system is fitted to the front-passenger seat and the PASSENGER AIRBAG OFF  indicator lamp on the centre console is not on:

- a child restraint system without a transponder for automatic child seat recognition has been fitted or
- a child restraint system with a transponder has been fitted incorrectly

Driver's kneebag

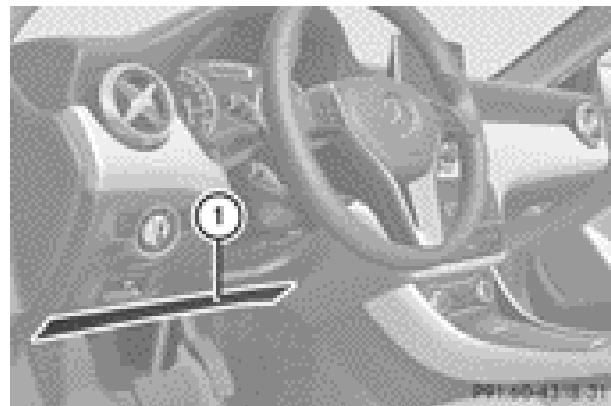

Driver's kneebag ① deploys under the steering column. The driver's kneebag is triggered together with the front airbag. The driver's kneebag is designed to operate together with the front airbag in frontal impacts if certain thresholds are exceeded. The driver's kneebag operates best in conjunction with correctly positioned and fastened seat belts.

Driver's kneebag ① increases the driver's protection against:

- knee injuries
- thigh injuries
- lower leg injuries

Sidebags

WARNING

If you wish to use seat covers, Mercedes-Benz recommends that, for safety reasons, you only use seat covers that have been approved for Mercedes-Benz vehicles.

The seat covers must have a special tear seam for sidebags. Otherwise, the sidebags cannot

deploy correctly and would fail to provide the intended protection in the event of an accident. Appropriate seat covers can be obtained, for example, from a Mercedes-Benz Service Centre.

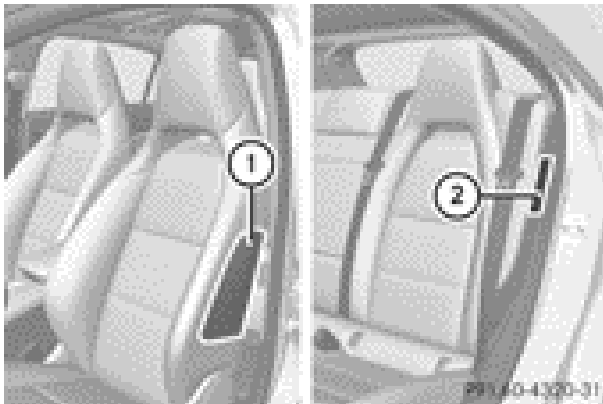

Front sidebags ① and rear sidebags ② deploy next to the outer seat cushions.

When deployed, the sidebags offer additional protection of the thorax for occupants on the front seats as well as also of the pelvis for the vehicle occupants on the side of the vehicle on which the impact occurs. However, they do not protect the:

- head
- neck
- arms

The sidebags are deployed:

- on the side on which an impact occurs
- at the start of an accident with a high rate of lateral vehicle deceleration or acceleration, e.g. in a side impact
- independently of the use of the seat belt
- independently of the front airbags
- independently of the belt tensioners

If the vehicle overturns, the sidebags are generally not deployed. Sidebags are deployed if the system detects high vehicle deceleration or acceleration in a lateral direction and determines that sidebag deployment can offer additional protection to that provided by the seat belt.

Windowbags

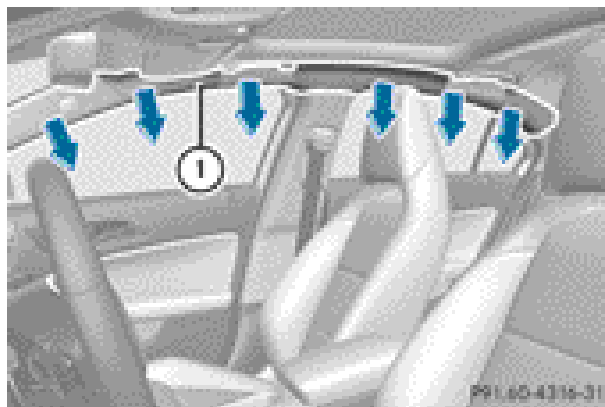

Windowbags ① enhance the level of protection for the head (but not chest or arms), of the vehicle occupants on the side of the vehicle on which the impact occurs.

Windowbags ① are integrated into the side of the roof frame and deployed in the area from the A-pillar to the C-pillar.

Windowbags are deployed:

- at the start of an accident with a high rate of lateral vehicle deceleration or acceleration, e.g. in a side impact
- on the side on which an impact occurs
- on the driver's and the front passenger's side if the vehicle overturns and the system determines that deployment can offer additional protection to that provided by the seat belt
- independently of the use of the seat belt
- regardless of whether the front-passenger seat is occupied
- independently of the front airbags

PRE-SAFE® (anticipatory occupant protection)

WARNING

When adjusting the seat, make sure that nobody can become trapped.

- ❗ Make sure that there are no objects in the footwell or behind the seats when moving the seat back. There is a risk that the seats and/or the objects could be damaged.

PRE-SAFE® takes pre-emptive measures to protect occupants in certain hazardous situations.

PRE-SAFE® intervenes:

- when BAS activates, e.g. in emergency braking situations
- when adaptive Brake Assist intervenes powerfully on vehicles with DISTRONIC PLUS
- in critical driving situations, e.g. when physical limits are exceeded and the vehicle understeers or oversteers severely

PRE-SAFE® takes the following measures depending on the hazardous situation detected:

- the front seat belts are pre-tensioned.
- vehicles with the memory function: the front-passenger seat is adjusted if it is in an unfavourable position.
- if the vehicle skids, the panorama sliding sunroof and the side windows are closed so that only a small gap remains.

If the hazardous situation passes without resulting in an accident, PRE-SAFE® slackens the belt pretensioning. All settings made by PRE-SAFE® can then be reversed.

If the seat belts are not released:

- ▶ Move the backrest or seat back slightly, but only when the vehicle is stationary. The belt pretensioning is reduced and the locking mechanism is released.

More information about seat belt adjustment, a convenience function integrated into PRE-SAFE (▷ page 47).

Seat belts

Important safety notes

WARNING

A seat belt which is not worn correctly, or which has not been engaged in the seat belt buckle correctly, cannot provide the intended level of protection. Under certain circumstan-

ces, this could cause severe or even fatal injuries in the event of an accident.

Therefore, make sure that all occupants – in particular, pregnant women – wear their seat belts correctly at all times.

- The seat belt must fit snugly on your body and must not be twisted. Therefore, avoid wearing bulky clothing, e.g. a winter coat. The shoulder section of the belt must be routed across the centre of your shoulder – on no account across your neck or under your arm – and pulled tight against your upper body. The lap belt must always pass across your lap as low down as possible, i.e. over your hip joints – not across your abdomen. If necessary, push the seat belt slightly downwards and adjust it by pulling it in the direction the seat belt retracts.
- Do not route the seat belt strap over sharp or fragile objects. Please make sure that such objects are not on or in your clothing, e.g. spectacles, pens or keys etc. The seat belt strap could become damaged and tear during an accident and you or other vehicle occupants could be injured.
- Only one person should use each seat belt at any one time. Children must never travel sitting on the lap of another occupant. The child will not be secured in the event of an accident, heavy braking or sudden change of direction. This may result in the child or other occupants being seriously or fatally injured.
- Persons under 1.50 m tall cannot wear the seat belts correctly. For this reason secure persons less than 1.50 m tall in specially designed, suitable restraint systems.
- Children under 1.50 m tall and younger than twelve years of age cannot wear the seat belts correctly. For this reason secure them in special suitable child restraint systems installed on a suitable seat. Additional information can be found in the Operating Instructions in the chapter "Safety", "Children in the Vehicle". Observe the installa-

tion instructions of the child restraint system manufacturer.

- Do not secure an object with a seat belt if the seat belt is also being used by one of the vehicle's occupants.

WARNING

The seat belt does not offer the intended level of protection unless the backrest is almost vertical. Under certain circumstances, this could cause severe or even fatal injuries in the event of an accident.

Before starting a journey, make sure that the seat is properly adjusted and that the backrest is almost vertical.

WARNING

A dirty or damaged seat belt or one that has been modified or subjected to a load in an accident no longer offers the intended level of protection. Under certain circumstances, this could cause severe or even fatal injuries in the event of an accident.

For this reason, check regularly that the seat belts are not damaged or dirty.

Always have damaged seat belts or seat belts that have been subjected to a load in an accident replaced at a qualified specialist workshop.

For safety reasons, Mercedes-Benz recommends that you only use seat belts which have been approved by Mercedes-Benz for your vehicle.

Seat belts are the most effective means of restraining the movement of vehicle occupants in the event of an accident. This reduces the risk of vehicle occupants coming into contact with parts of the vehicle interior.

Fastening seat belts

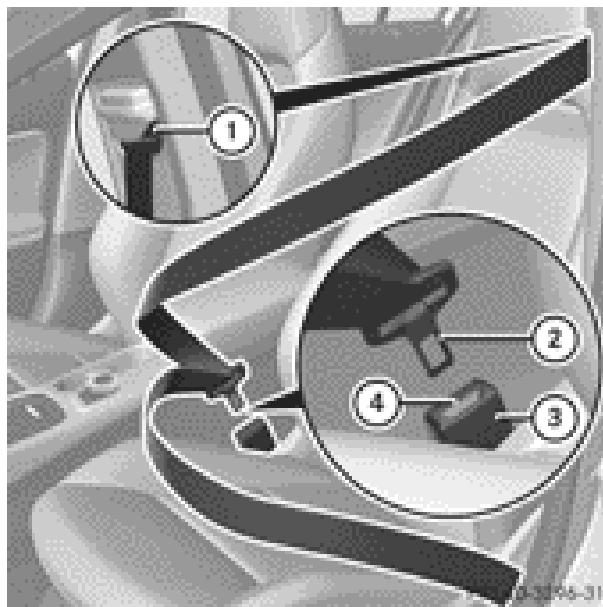

- ▶ Adjust the seat and move the backrest to an almost vertical position (▷ page 92).
- ▶ Pull the seat belt smoothly through belt sash guide ①.
- ▶ Without twisting it, guide the shoulder section of the seat belt across the middle of your shoulder and the lap section across your pelvis.
- ▶ Engage belt tongue ② in buckle ③. Seat belt adjustment: if necessary, the driver's and front-passenger seat belts automatically adjust to the upper body (▷ page 47).
- ▶ If necessary, adjust the seat belt to the appropriate height (▷ page 48).
- ▶ If necessary, pull upwards on the shoulder section of the seat belt to tighten the belt across your body.

Information on releasing the seat belt with release button ④ (▷ page 48).

Seat belt adjustment

The seat-belt adjustment function adjusts the driver's and front-passenger seat belt to the upper body of the occupants.

The belt strap is tightened slightly when:

- you engage the belt tongue in the belt buckle and you then turn the key to position **2** in the ignition lock.
- the key is in position **2** in the ignition lock and you then engage the belt tongue in the buckle.

The seat-belt adjustment will apply a certain tightening force if any slack is detected between the occupant and the seat belt. Do not hold on to the seat belt tightly while it is adjusting. You can switch the seat-belt adjustment on and off in the on-board computer (▷ page 225).

The seat-belt adjustment is an integral part of the PRE-SAFE[®] convenience function. More information about PRE-SAFE[®] can be found in the "PRE-SAFE[®] (preventative occupant protection)" section (▷ page 45).

Belt height adjustment

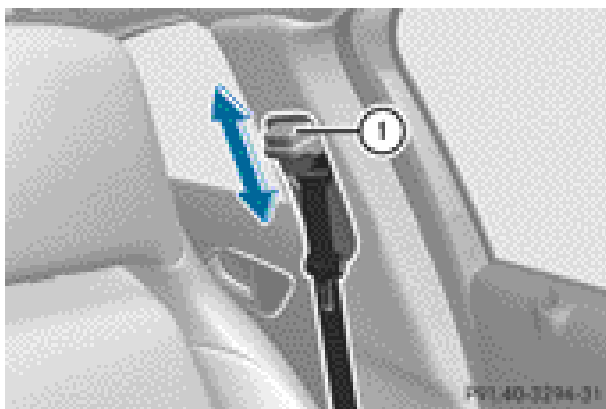

You can adjust the belt height for the front seats. Adjust the belt to a height that allows the upper part of the seat belt to be routed across the centre of your shoulder.

- ▶ **To raise:** slide the belt sash guide upwards. The belt sash guide engages in various positions.
- ▶ **To lower:** press and hold belt sash guide release ①.
- ▶ Slide the belt sash guide downwards.
- ▶ Let go of belt sash guide release ① and make sure that the belt sash guide has engaged.

Releasing the seat belts

! Make sure that the seat belt is fully rolled up. Otherwise, the seat belt or belt tongue will be trapped in the door or in the seat mechanism. This could damage the door, the door trim panel and the seat belt. Damaged seat belts can no longer fulfil their protective function and must be replaced. Visit a qualified specialist workshop.

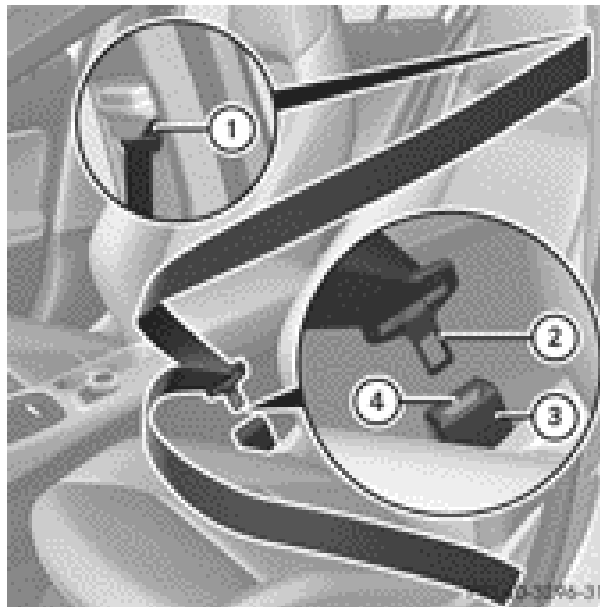

- ▶ Press release button ④ on belt buckle ③.
- ▶ Guide belt tongue ② back to belt sash guide ①.

Belt warning for the driver and front passenger

The  seat belt warning lamp in the instrument cluster is a reminder for all occupants to fasten their seat belts. It may light up continuously or flash. In addition, a warning tone may sound.

The  seat belt warning lamp goes out and the warning tone ceases when the driver and the front passenger have fastened their seat belt.

For certain countries only: regardless of whether the driver and the front passenger have fastened their seat belts, the  seat belt warning lamp lights up for six seconds after the engine is started. It then goes out if



the driver and the front passenger have fastened their seat belts.

- i** For more information on the  seat belt warning lamp, see "Warning and indicator lamps in the instrument cluster, seat belt" (▷ page 257).

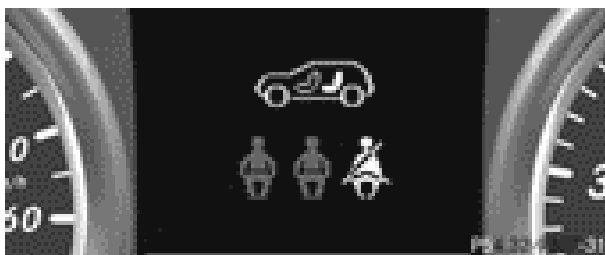
Rear seat belt status indicator



Example: rear seat belt status indicator

The rear-compartment seat belt status indicator indicates the rear seat on which the belt is fastened. In the example, the occupant on the right rear seat, when viewed in the direction of travel, is secured. The  symbol in the display indicates a fastened seat belt. If a seat belt is not fastened or if a seat is not occupied, the  symbol is displayed.

The rear-compartment seat belt status indicator appears in the multifunction display for around 30 seconds if:

- you drive off and reach a speed of approximately 10 km/h.
- the rear passengers fasten or unfasten their seat belts while the vehicle is in motion.
- someone gets in or out of the vehicle and the vehicle drives off again.

You can also cancel the rear seat belt status indicator immediately (▷ page 229).

- i** The status indicator for the rear-compartment seat belts is only available for certain countries.

Belt tensioners, belt force limiters

WARNING

If the seat belt tensioners have been triggered, they provide no additional protection

in the event of another accident. Therefore, have belt tensioners which have been triggered replaced at a qualified specialist workshop.

Comply with safety regulations when disposing of belt tensioners. Any Mercedes-Benz Service Centre can provide details of these regulations.

- !** If the front-passenger seat is not occupied, do not engage the seat belt tongue in the buckle on the front-passenger seat. Otherwise, the belt tensioner could be triggered in the event of an accident.

The front seat belts and the outer seat belts in the rear are equipped with belt tensioners and belt force limiters.

The belt tensioners tighten the seat belts in an accident, pulling them close against the body.

Belt tensioners do not correct incorrect seat positions or incorrectly fastened seat belts. Belt tensioners do not pull vehicle occupants back towards the backrest.

The belt tensioners can only be activated when:

- the ignition is switched on.
- the restraint systems are operational; see " SRS warning lamp" (▷ page 41).
- the belt tongue is engaged in the buckle on each of the front seat belts.

The belt tensioners on the outside seats in the rear compartment are triggered independently of the lock status of the seat belts.

The belt tensioners are triggered depending on the type and severity of an accident:

- if, in the event of a head-on or rear-end collision the vehicle decelerates or accelerates rapidly in a longitudinal direction during the initial stages of the impact
- if, in the event of a side impact, on the side opposite the impact the vehicle decelerates

ates or accelerates rapidly in a lateral direction

- in certain situations where the vehicle overturns and the system determines that it can provide additional protection

If the airbags are deployed, you will hear a bang, and a small amount of powder may also be released. Only in rare cases will the bang affect your hearing. The powder that is released generally does not constitute a health hazard. The  SRS warning lamp lights up.

If the seat belt is also fitted with a belt force limiter and this is triggered, the force exerted by the seat belt on the vehicle occupant is reduced.

The belt force limiters on the front seats are synchronised with the front airbags, which take on a part of the deceleration force. This results in the load being distributed over a greater area.

Children in the vehicle

Child restraint systems

Important safety notes

WARNING

To reduce the risk of serious or even fatal injury to the child in the event of a sudden change in direction, braking or an accident:

- children less than 1.50 m tall and under twelve years of age must always be secured in special child restraint systems on a suitable vehicle seat. This is necessary because the seat belts are not designed for children.
- Do not drive with a child secured in a rearward-facing child restraint system on the front-passenger seat. Exception: if the vehicle is equipped with automatic child seat recognition on the front-passenger seat and the child is secured in a child restraint system with transponders for automatic child seat recognition

- if you secure a forward-facing child restraint system to the front-passenger seat, you must move the front-passenger seat as far back as possible.
- children must never travel sitting on the lap of another occupant. Due to the forces which occur in the event of a sudden change of direction, heavy braking or an accident, it would not be possible to restrain the child. The child could be thrown against parts of the vehicle interior and be seriously or even fatally injured.

WARNING

The child restraint system cannot perform its protective function if it is not correctly fitted to a suitable vehicle seat. The child cannot be restrained in the event of an accident, heavy braking or sudden changes of direction. The child could be seriously or even fatally injured. For this reason, when fitting a child restraint system, observe the manufacturer's installation instructions and the correct use of the child restraint system.

Child restraint systems should be fitted to the rear seats. Children are generally better protected there.

The entire base of the child restraint system must always rest on the seat cushion. Therefore, never place objects, e.g. a cushion, under the child restraint system.

Only use child restraint systems with the original cover designed for them. Only replace damaged covers with genuine Mercedes-Benz covers.

We recommend the use of child restraint systems which have been approved for Mercedes-Benz vehicles.

WARNING

Do not leave children unsupervised in the vehicle, even if they are secured in a child restraint system. They could injure themselves on parts of the vehicle. They could also be seriously or even fatally injured by prolonged exposure to extreme heat or cold.

Do not expose the child restraint system to direct sunlight. Parts of the child restraint system could heat up and the child could burn herself/himself on them.

If a child opens a door, the child or other persons could be injured as a result. They could get out and injure themselves or be injured by a passing vehicle.

Observe the general notes on the HOLD function, which can be found under the same keyword.

WARNING

Unsecured or incorrectly positioned loads increase the risk of injury for children and all other occupants in the event of:

- an accident
- sudden braking
- a sudden change of direction

Do not transport heavy or hard objects in the vehicle interior unless they are secured. You will find further information under "Loading guidelines" in the index.

If a child is travelling in your vehicle, secure the child using a child restraint system which is appropriate to the size, age and weight of the child. You should preferably fit the restraint system to a suitable rear seat. Make sure that the child is secured for the trip.

Mercedes-Benz recommends that you use the listed child restraint systems (▷ page 58). You can obtain further information about the correct child restraint system from any Mercedes-Benz Service Centre.

- i** It is advisable to use Mercedes-Benz care products to clean child restraint systems. You can obtain information about this at any Mercedes-Benz Service Centre.

Child restraint system on the front-passenger seat

WARNING

If the front-passenger airbag is not disabled:

- a child secured in a child restraint system on the front-passenger seat could be seriously and even fatally injured by the front-passenger airbag deploying. This is especially a risk if the child is in the immediate vicinity of the front-passenger airbag when it deploys.
- never secure a child on the front-passenger seat in a rearward-facing child restraint system. Only secure a rearward-facing child restraint system on a suitable rear seat.
- always move the front-passenger seat to the rearmost position if you secure a child in a forward-facing child restraint system on the front-passenger seat.

The front-passenger airbag is not disabled:

- on vehicles without automatic child seat recognition on the front-passenger seat
- in vehicles with automatic child seat recognition in the front-passenger seat, if no special child restraint system with transponders for automatic child seat recognition in the front-passenger seat has been fitted
- on vehicles with automatic child seat recognition on the front-passenger seat, if the PASSENGER AIRBAG OFF indicator lamp  is not lit.

To make you aware of this danger, a corresponding warning sticker has been affixed on the dashboard and on both sides of the sun visor on the front-passenger side.

Information about recommended child restraint systems is available at any Mercedes-Benz Service Centre.



Warning notice on the front-passenger sun visor



Warning symbol for a rearward-facing child restraint system

Do not use a rearward-facing child restraint system on a seat that is protected by an airbag installed in front of it.

Automatic child seat recognition on the front-passenger seat

WARNING

If the  PASSENGER AIRBAG OFF indicator lamp does not light up when the child restraint system is fitted, the front-passenger airbag has not been disabled. If the front-passenger airbag deploys, the child could be seriously or even fatally injured.

Proceed as follows:

- do not use a rearward-facing child restraint system on the front-passenger seat.
- fit a rearward-facing child restraint system on a suitable rear seat.

or



- only use a forward-facing child restraint system on the front-passenger seat and move the front-passenger seat to the rear-most position.
- have the automatic child seat recognition checked at a qualified specialist workshop.

To ensure that the automatic child seat recognition on the front-passenger seat functions/communicates correctly, never place objects, e.g. a cushion, under the child restraint system. The entire base of the child restraint system must always rest on the seat cushion. An incorrectly fitted child restraint system cannot perform its intended protective function in the event of an accident, and could lead to injuries.

WARNING

Do not place electronic devices on the front-passenger seat, e.g.:

- laptops, when switched on
- mobile phones
- cards with transponders, e.g. ski passes or access cards

Signals from electronic equipment can cause interference in the automatic child seat recognition sensor system. This can lead to a system malfunction. This may cause the  PASSENGER AIRBAG OFF indicator lamp to light up without there being a child seat with transponders for automatic child seat recognition fitted. The front-passenger airbag will not then deploy during an accident. It is also possible that the  SRS warning lamp lights up and/or the  PASSENGER AIRBAG OFF indicator lamp does not light up briefly when you turn the key in the ignition lock to position **2**.



If the front-passenger seat of your vehicle does not have automatic child seat recognition, this is indicated by a special sticker. The sticker is affixed to the side of the dashboard on the front-passenger side. The sticker is visible when you open the front-passenger door.

Vehicles without automatic child seat recognition on the front-passenger seat: if you turn the key to position 2 in the ignition lock, the  **PASS AIR BAG OFF** indicator lamp lights up briefly but has no function. It does not indicate that there is automatic child seat recognition on the front-passenger seat.

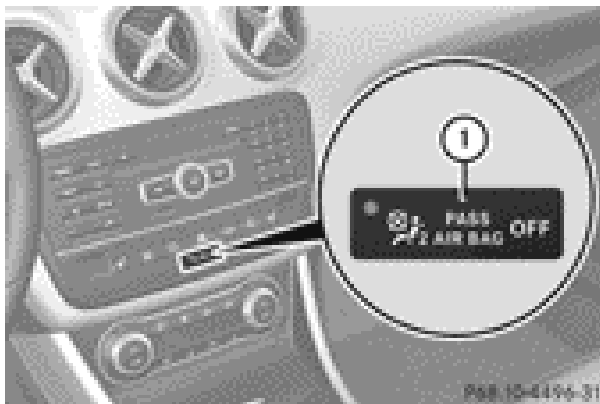

The sensor system for child restraint systems in the front-passenger seat detects whether a special Mercedes-Benz child seat with a transponder for automatic child seat recognition has been fitted. In this case,  **PASS AIR BAG OFF** indicator lamp ① lights up. The front-passenger front airbag is disabled.

i If the front-passenger front airbag is disabled by the automatic child seat recognition, the following remain enabled on the front-passenger side:

- the sidebag
- the windowbag
- the belt tensioner

ISOFIX child seat securing system for the rear seats

WARNING

A child restraint system secured by the ISOFIX child seat securing system does not provide sufficient protection for children weighing more than 22 kg. For this reason, do not secure children weighing more than 22 kg in a child restraint system secured by the ISOFIX child seat securing system. If the child weighs more than 22 kg, secure the child restraint system with the vehicle seat belt as well. In addition, when fitting a child restraint system, be sure to observe the manufacturer's installation instructions and the instructions for correct use of the child restraint system.

WARNING

The child restraint system cannot perform its protective function if it is not correctly fitted to a suitable vehicle seat. The child cannot be restrained in the event of an accident, heavy braking or sudden changes of direction. The child could be seriously or even fatally injured. For this reason, when fitting a child restraint system, be sure to observe the manufacturer's installation instructions and the instructions for correct use of the child restraint system.

For safety reasons, when installing child restraint systems on the rear seats, only use child restraint systems with the ISOFIX child seat securing system, which are specially tested and approved for Mercedes-Benz vehicles.

An incorrectly fitted child restraint system could come loose and seriously or even fatally

injure the child or other vehicle occupants. When fitting the child restraint system, always make sure that it is engaged correctly in the securing rings on both sides.

WARNING

Please note that if child restraint systems, or their retaining systems, are damaged or subjected to a load in an accident, they may not be able to provide their protective function. This could result in serious or even fatal injuries to the secured child in the event of an accident, heavy braking or a sudden change in direction.

For this reason, have child restraint systems and their anchorages which have been damaged or subjected to a load in an accident checked immediately at a qualified specialist workshop.

- ❗ When fitting the ISOFIX child restraint system, make sure that the seat belt for the centre seat does not get trapped. Otherwise, the seat belt could be damaged.

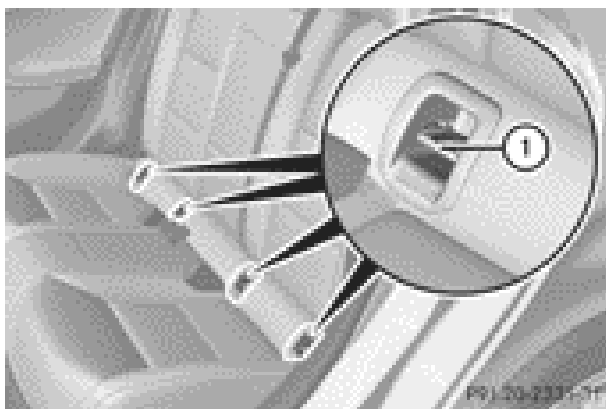

- ▶ Install the ISOFIX child restraint system. Comply with the manufacturer's instructions when installing the ISOFIX child restraint system.

ISOFIX is a standardised securing system for specially designed child restraint systems on the rear seats. Securing rings ① for two ISOFIX child restraint systems are fitted on the left and right of the rear seats.

Top Tether

Important safety notes

WARNING

Make sure that the rear seat backrest is fully locked. When the red lock verification indicators on the left and right are no longer visible, the rear seat backrests are locked. If the rear seat backrests are not locked, occupants could be injured in the event of an accident, e.g. by objects that are thrown forward from the luggage compartment.

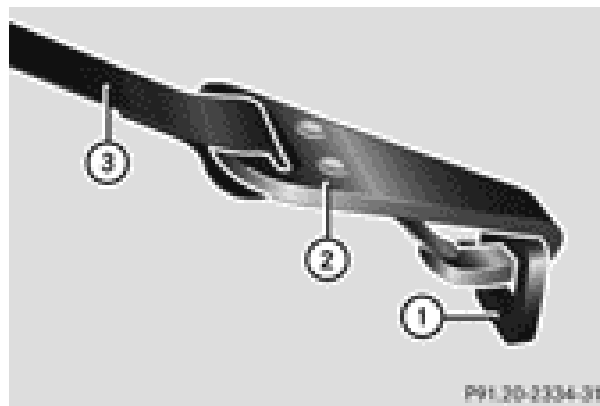

Top Tether provides an additional connection between the ISOFIX child restraint system secured with ISOFIX and the rear seat. It helps reduce the risk of injury even further. The Top Tether anchorage points are fitted on the rear side of the rear seat backrests.

- ▶ **Vehicles with adjustable head restraints:** move the head restraint upwards.
- ▶ Route Top Tether belt ③ under the head restraint between the two head restraint bars.

Vehicles without adjustable head restraints:

- ▶ **Top Tether belt with one belt strap:** route Top Tether belt ③ centrally over head restraint .





or

- ▶ **Top Tether belt with two belt straps:** route Top Tether belts ③ on the left and right past the side of head restraint .
- ▶ Hook Top Tether hook ② of Top Tether belt ③ into Top Tether anchorage ①.

Ensure that:

- Top Tether hook ② is hooked into Top Tether anchorage ① as shown.
 - Top Tether belt ③ is not twisted.
 - Top Tether belt ③ is routed between rear seat backrest and luggage compartment cover if luggage compartment cover is fitted.
- ▶ **Vehicles with adjustable head restraints:** move the head restraint back down slightly again if necessary (▷ page 96). Make sure that you do not interfere with the correct routing of Top Tether belt ③.
 - ▶ Fit the ISOFIX child restraint system with Top Tether. Comply with the manufacturer's installation instructions when doing so. Make sure that Top Tether belt ③ is tight.

Problems with automatic child seat recognition

Problem	Possible causes/consequences and ► Solutions
<p>The  indicator lamp on the centre console is lit.</p>	<p>A special Mercedes-Benz child restraint system with a transponder for automatic child seat recognition has been fitted to the front-passenger seat. The front-passenger front airbag has therefore been disabled as desired.</p> <p>⚠ WARNING</p> <p>There is no child restraint system fitted to the front-passenger seat. Automatic child seat recognition is malfunctioning. It is also possible that the  SRS warning lamp lights up and/or the  PASSENGER AIRBAG OFF indicator lamp does not light up briefly when you switch the ignition on. There is a risk of injury.</p> <p>► Remove electronic equipment from the front-passenger seat, e.g.:</p> <ul style="list-style-type: none"> • Laptop • Mobile phone • Cards with transponders, such as ski passes or access cards <p>If the  indicator lamp remains lit:</p> <p>► Visit a qualified specialist workshop.</p>

Suitable positioning of the child restraint systems

Key to the letters used in the table:

- X Seat which is unsuitable for children in this weight category.
- U Suitable for child restraint systems in the "Universal" category that are approved for use in this weight category.
- UF Suitable for forward-facing child restraint systems that belong to the "Universal" category and are approved for use in this weight category.
- L Suitable for child restraint systems as recommended, see the following table of "Recommended child restraint systems" (► page 58).

Weight categories	Seat positions			
	Front-passenger seat		Rear seat ¹	
	Front-passenger front airbag is not disabled	Front-passenger front airbag is disabled	Left, right	Centre
Category 0: up to 10 kg	X	U ^{2,3} , L ^{2,3}	U, L	U, L
Category 0+: up to 13 kg	X	U ^{2,3} , L ^{2,3}	U, L	U, L
Category I: 9 to 18 kg	UF ³ , L ³	U ³ , L ³	U, L	U, L
Category II: 15 to 25 kg	UF ³ , L ³	U ³ , L ³	U, L	U, L
Category III: 22 to 36 kg	UF ³ , L ³	U ³ , L ³	U, L	U, L

"Universal" category child restraint systems can be recognised by their orange approval label.



Example: approval label on the child restraint system

- 1 If you use a category 0 or 0+ baby car seat on a rear seat, you must adjust the driver's or front-passenger seat so that the seat does not come in contact with the baby car seat.
- 2 Vehicles with automatic child seat recognition in the front-passenger seat: a child restraint system of the "Universal" category with a transponder for automatic child seat recognition must be fitted. The  PASS AIR BAG OFF indicator lamp must be on.
- 3 Move the front-passenger seat to the rearmost and highest position, the backrest to an almost vertical position, and the belt height adjustment to the lowest position. For seats with electrical adjustment, the seat cushion angle must be set to the highest and most upright position.

Key to the letters used in the table:

- X ISOFIX position that is not suitable for ISOFIX child restraint systems in this weight category and/or size category.
- IUF Suitable for forward-facing ISOFIX child restraint systems that belong to the "Universal" category which are approved for use in this weight category.
- IL Suitable for ISOFIX child restraint systems as recommended; see the following table of "Recommended child restraint systems" (▷ page 58).

Suitability of the rear seats for attaching ISOFIX child restraint systems

Weight categories	Size category	Equipment	Rear seat, left and right
Carry-cot	F	ISO/L1	X
	G	ISO/L2	X
0: up to 10 kg up to approximately 6 months	E	ISO/R1	IL
0+: up to 13 kg up to approximately 15 months	E	ISO/R1	IL
	D	ISO/R2	IL
	C	ISO/R3	IL
I: 9 to 18 kg between approx- imately 9 months and 4 years	D	ISO/R2	IL ^{4, 5}
	C	ISO/R3	IL
	B	ISO/F2	IUF ^{4, 5}
	B1	ISO/F2X	IUF
	A	ISO/F3	IUF

Recommended child restraint systems

When installing a child restraint system without a transponder for automatic child seat recognition on the front-passenger seat:

- ▶ Move the front-passenger seat to its rearmost position.

⁴ Vehicles with the Style or Urban package or with front seats with 4-point or 6-point anchorages: move the front seat to the uppermost position.

⁵ Vehicles that have front seats with 2-point anchorages: move the front seat to the uppermost position.

Weight categories	Manufacturer	Type	Approval number (E1 ...)	Order number (A 000 ...) ⁶	Automatic child seat recognition
Category 0: up to 10 kg up to approximately 6 months	Britax Römer	BABY SAFE PLUS	03 301146	970 10 00	Yes
			04 301146		
Group 0+: up to 13 kg up to approximately 15 months	Britax Römer	BABY SAFE PLUS	03 301146	970 10 00	Yes
			04 301146		
Category I: 9 to 18 kg between approximately 9 months and 4 years	Britax Römer	DUO PLUS	03 301133	970 11 00	Yes
			04 301133	970 16 00	No
Group II/III: 15 to 36 kg between approximately 4 and 12 years	Britax Römer	KIDFIX	04 301198	970 18 00	Yes
				970 19 00	No

Suggested "Universal"/"Semi-Universal" category ISOFIX child restraint systems:

Weight categories	Size category	Manufacturer	Type	Approval number (E1 ...)	Order number ⁶	Automatic child seat recognition
Carry-cot	F	-	-	-	-	-
	G	-	-	-	-	-
Group 0: up to 10 kg	E	-	-	-	-	-
Group 0+: up to 13 kg	E	Britax Römer	BABY SAFE ISOFIX PLUS	04 301146	B6 6 86 8224	No

Weight categories	Size category	Manufacturer	Type	Approval number (E1 ...)	Order number ⁶	Automatic child seat recognition
	D	-	-	-	-	-
	C	-	-	-	-	-
Group I: 9 to 18 kg	D	-	-	-	-	-
	C	-	-	-	-	-
	B	-	-	-	-	-
	B1	Britax Römer	DUO PLUS	04 30 1133	A000 970 11 00	Yes
					A000 970 16 00	No
A	-	-	-	-	-	

Child-proof locks

Important safety notes

WARNING

Activate the child-proof locks for the rear doors and the override switch for the rear windows when children are travelling in the vehicle. Otherwise, the children could open doors or side windows while the vehicle is in motion and injure themselves or others.

WARNING

Do not leave children unsupervised in the vehicle, even if they are secured in a child restraint system. They could injure themselves on parts of the vehicle. They could also be seriously or even fatally injured by prolonged exposure to extreme heat or cold. Do not expose the child restraint system to direct sunlight. Parts of the child restraint system could heat up and the child could burn herself/himself on them.

If a child opens a door, the child or other persons could be injured as a result. They could get out and injure themselves or be injured by a passing vehicle.

Observe the general notes on the HOLD function, which can be found under the same keyword.

Child-proof locks for the rear doors

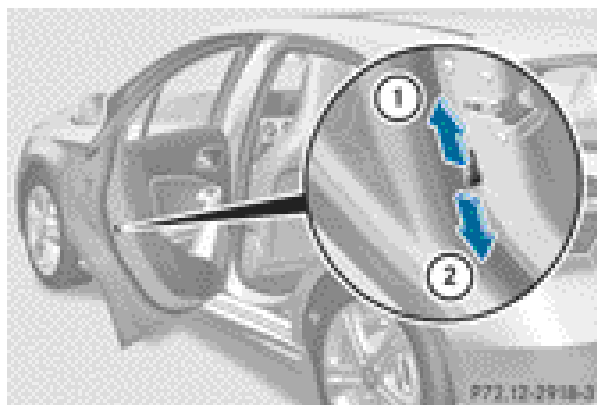

You can secure each door individually with the child-proof locks on the rear doors. A door secured with a child-proof lock cannot be

⁶ Colour code 9H95.

opened from inside the vehicle. When the vehicle is unlocked, the door can be opened from the outside.

- ▶ **To activate:** press the child-proof lock lever up in the direction of arrow ①.
- ▶ Make sure that the child-proof locks are working properly.
- ▶ **To deactivate:** press the child-proof lock lever down in the direction of arrow ②.

Override feature for the rear side windows

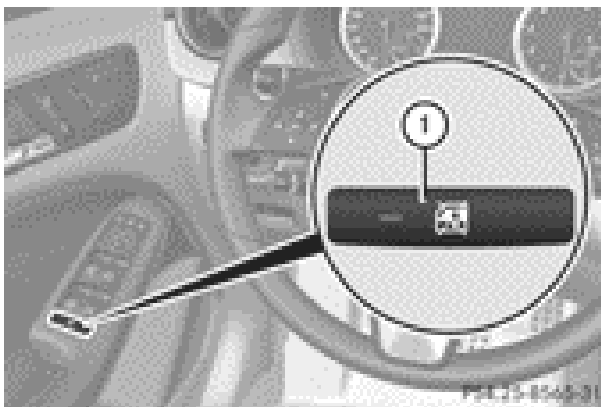

- ▶ **To activate/deactivate:** press button ①. If indicator lamp is lit, operation of the rear side windows is disabled. Operation is only possible using the switches in the driver's door. If the indicator lamp is off, operation is possible using the switches in the rear compartment.

Driving safety systems

Driving safety systems overview

In this section, you will find information about the following driving safety systems:

- ABS (**A**nti-**l**ock **B**raking **S**ystem) (▷ page 61)
- BAS (**B**rake **A**ssist **S**ystem) (▷ page 62)
- COLLISION PREVENTION ASSIST (adaptive Brake Assist and distance warning function) (▷ page 62)
- Adaptive brake lamps (▷ page 65)

- ESP® (**E**lectronic **S**tability **P**rogram) (▷ page 65)
- EBD (**e**lectronic **b**rake force **d**istribution) (▷ page 69)
- ADAPTIVE BRAKE (▷ page 69)
- STEER CONTROL (▷ page 69)

Important safety notes

If you fail to adapt your driving style or if you are inattentive, the driving safety systems can neither reduce the risk of accident nor override the laws of physics. Driving safety systems are merely aids designed to assist driving. You are responsible for the distance to the vehicle in front, for vehicle speed and for braking in good time. Always adapt your driving style to suit the prevailing road, weather and traffic conditions and maintain a safe distance from the vehicle in front. Drive carefully.

- ❗ The driving safety systems described only work as effectively as possible when there is adequate contact between the tyres and the road surface. Pay particular attention to the information regarding tyres, recommended minimum tyre tread depths etc. in the "Wheels and tyres" section (▷ page 318).

In wintry driving conditions, always use winter tyres (M+S tyres) and, if necessary, snow chains. Only in this way will the driving safety systems described in this section work as effectively as possible.

ABS (Anti-lock Braking System)

Important safety notes

- ❗ Observe the "Important safety notes" section for driving safety systems (▷ page 61).

⚠ WARNING

If ABS is faulty, the wheels could lock when braking. The steerability and braking charac-

teristics may be severely impaired. Additionally, further driving safety systems are deactivated. There is an increased danger of skidding and accidents.

Drive on carefully. Have ABS checked immediately at a qualified specialist workshop.

If ABS is malfunctioning, other systems, including driving safety systems, will also become inoperative. Observe the information on the ABS warning lamp (▷ page 258) and display messages which may be shown in the instrument cluster (▷ page 230).

ABS regulates brake pressure in such a way that the wheels do not lock when you brake. This allows you to continue steering the vehicle when braking.

ABS works from a speed of about 8 km/h upwards, regardless of road-surface conditions. ABS works on slippery surfaces, even when you only brake gently.

The  ABS warning lamp in the instrument cluster lights up when the ignition is switched on. It goes out when the engine is running.

Braking

- ▶ **If ABS intervenes:** continue to depress the brake pedal with force until the braking situation is over.
- ▶ **To make a full brake application:** depress the brake pedal with full force.

If ABS intervenes when braking, you will feel a pulsing in the brake pedal.

The pulsating brake pedal can be an indication of hazardous road conditions, and functions as a reminder to take extra care while driving.

BAS (Brake Assist)

- i** Observe the "Important safety notes" section (▷ page 61).

WARNING

If BAS is malfunctioning, the braking distance in an emergency braking situation is increased. There is a risk of accident.

In an emergency braking situation, depress the brake pedal with full force. ABS prevents the wheels from locking.

BAS operates in emergency braking situations. If you depress the brake pedal quickly, BAS automatically boosts the braking force, thus shortening the stopping distance.

The brakes will function as usual once you release the brake pedal. BAS is deactivated.

COLLISION PREVENTION ASSIST

General notes

COLLISION PREVENTION ASSIST consists of the adaptive Brake Assist and the distance warning signal, which are described in the following.

Distance warning function

Important safety notes

- i** Observe the "Important safety notes" section for driving safety systems (▷ page 61).

WARNING

The distance warning function does not react:

- to people or animals
- to oncoming vehicles
- to crossing traffic
- when cornering

Thus, the distance warning function cannot provide a warning in all critical situations. There is a risk of an accident.

Always pay careful attention to the traffic situation and be ready to brake.

⚠ WARNING

The distance warning function cannot always clearly identify objects and complex traffic situations.

In such cases, the distance warning function may:

- give an unnecessary warning
- not give a warning

There is a risk of an accident.

Always pay careful attention to the traffic situation; do not rely on the distance warning function alone.

Function

- ▶ **To activate/deactivate:** activate or deactivate the distance warning function in the on-board computer (▷ page 218).

Vehicles with a black and white multi-function display: when the distance warning function is activated, the  symbol appears in the status overview in the multi-function display.

Vehicles with a colour multifunction display: when the distance warning function is deactivated, the  symbol appears in the assistance graphics in the multifunction display.

The distance warning function can help you to minimise the risk of a front-end collision with a vehicle ahead or reduce the effects of such a collision. If the distance warning function detects that there is a risk of a collision, you will be warned visually and acoustically. Without your intervention, the distance warning function cannot prevent a collision.

The distance warning function issues a warning at speeds:

- of around 30 km/h or more, if, over several seconds, the distance maintained to the vehicle travelling in front is insufficient. The  distance warning lamp then lights up in the instrument cluster.
- of around 7 km/h or higher, if you very quickly approach a vehicle in front. An intermittent warning tone will then sound,

and the  distance warning lamp will light up in the instrument cluster.

- ▶ Brake immediately in order to increase the distance from the vehicle in front.

or

- ▶ Take evasive action provided it is safe to do so.

Due to the nature of the system, particularly complicated but non-critical driving conditions may also cause the system to display a warning.

With the help of the radar sensor system, the distance warning function can detect obstacles that are in the path of your vehicle for an extended period of time.

Up to a speed of around 70 km/h, the distance warning function can also react to stationary obstacles, such as stopped or parked vehicles.

If you approach an obstacle and the distance warning function detects a risk of a collision, the system will alert you both visually and acoustically.

In particular, the detection of obstacles can be impaired in the case of:

- dirt on the sensors or obscured sensors
- snow or heavy rain
- interference by other radar sources
- strong radar reflections, for example, in multi-storey car parks
- a narrow vehicle travelling in front, e.g. a motorcycle
- a vehicle travelling in front on a different line

Following damage to the front end of the vehicle, have the configuration and operation of the radar sensor checked at a qualified specialist workshop. This also applies to collisions at slow speeds where there is no visible damage to the front of the vehicle.

Adaptive Brake Assist

- i** Observe the "Important safety notes" section for driving safety systems (▷ page 61).

WARNING

Adaptive Brake Assist cannot always clearly identify objects and complex traffic situations. In these cases, Adaptive Brake Assist may not intervene. There is a risk of an accident.

Always pay careful attention to the traffic situation and be ready to brake.

WARNING

Adaptive Brake Assist does not react:

- to people or animals
- to oncoming vehicles
- to crossing traffic
- to stationary obstacles
- when cornering

As a result, Adaptive Brake Assist may not intervene in all critical conditions. There is a risk of an accident.

Always pay careful attention to the traffic situation and be ready to brake.

Adaptive Brake Assist aids you in braking during hazardous situations at speeds above 30 km/h and uses the radar sensor system to evaluate the traffic situation.

With the help of a sensor system, adaptive Brake Assist can detect obstacles that are in the path of your vehicle for an extended period of time.

Should you approach an obstacle and adaptive Brake Assist has detected a risk of collision, adaptive Brake Assist calculates the braking force necessary to avoid a collision. Should you apply the brakes forcefully, adaptive Brake Assist will automatically increase the braking force to a level suitable for the traffic conditions.

- ▶ Keep the brake pedal depressed until the emergency braking situation is over. ABS prevents the wheels from locking.

The brakes will work normally again if:

- you release the brake pedal
- there is no longer any danger of a collision
- no obstacle is detected in front of your vehicle

Adaptive Brake Assist is then deactivated.

Vehicles with PRE-SAFE®: if adaptive Brake Assist requires particularly high brake pressure, preventative passenger protection measures (PRE-SAFE®) are deployed simultaneously.

Up to vehicle speeds of around 250 km/h, adaptive Brake Assist is capable of reacting to moving objects that have already been recognised as such at least once over the period of observation. Adaptive Brake Assist does not react to stationary obstacles.

If adaptive Brake Assist is not available due to a malfunction in the radar sensor system, the brake system remains available with full brake boosting effect and BAS.

In particular, the detection of obstacles can be impaired if there is:

- dirt on the sensors or anything else covering the sensors
- snow or heavy rain
- interference by other radar sources
- the possibility of strong radar reflections, for example, in multi-storey car parks
- a narrow vehicle travelling in front, e.g. a motorcycle
- a vehicle travelling in front on a different line

Following damage to the front end of the vehicle, have the configuration and operation of the radar sensor checked at a qualified specialist workshop. This also applies to collisions at slow speeds where there is no visible damage to the front of the vehicle.

Adaptive brake lamps

If you brake sharply from a speed of more than 50 km/h or if braking is assisted by BAS or adaptive Brake Assist, the brake lamps flash rapidly. In this way, traffic travelling behind you is warned in an even more noticeable manner.

If you brake sharply from a speed of more than 70 km/h to a standstill, the hazard warning lamps are activated automatically. If the brakes are applied again, the brake lamps light up continuously. The hazard warning lamps switch off automatically if you travel faster than 10 km/h. You can also switch off the hazard warning lamps using the hazard warning switch button (▷ page 108).

- i** Adaptive brake lamps are only available in certain countries.

ESP® (Electronic Stability Program)

General notes

- i** Observe the "Important safety notes" section (▷ page 61).

ESP® monitors driving stability and traction, i.e. power transmission between the tyres and the road surface.

If ESP® detects that the vehicle is deviating from the direction desired by the driver, one or more wheels are braked to stabilise the vehicle. The engine output is also modified to keep the vehicle on the desired course within physical limits. ESP® assists the driver when pulling away on wet or slippery roads. ESP® can also stabilise the vehicle during braking.

ETS/4ETS (Electronic Traction System)

- i** Observe the "Important safety notes" section (▷ page 61).

ETS/4ETS traction control is part of ESP®. ETS brakes the drive wheels individually if they spin. This enables you to pull away and accelerate on slippery surfaces, for example

if the road surface is slippery on one side. In addition, more drive torque is transferred to the wheel or wheels with traction.

ETS remains active when you deactivate ESP®.

Important safety notes

WARNING

If ESP® is malfunctioning, ESP® is unable to stabilise the vehicle. In addition, other driving safety systems are switched off. This increases the risk of skidding and an accident.



Drive on carefully. Have ESP® checked at a qualified specialist workshop.

- !** When testing the electric parking brake on a braking dynamometer, switch off the ignition. Application of the brakes by ESP® may otherwise destroy the brake system.
- !** Vehicles with 4MATIC: switch off the ignition when the electric parking brake is being tested using a dynamometer. Application of the brakes by ESP® may otherwise destroy the brake system.
- !** Vehicles with 4MATIC: function or performance tests may only be carried out on a 2-axle dynamometer. Before operating the vehicle on such a dynamometer, please consult a qualified specialist workshop. You could otherwise damage the drive train or the brake system.
- !** Do not tow vehicles with 4MATIC with the front or rear axle raised.

Vehicles without 4MATIC: when towing your vehicle with the front axle raised, it is important that you observe the notes on ESP® (▷ page 312).

Vehicles with 4MATIC: when towing your vehicle with both axles on the ground, it is important that you observe the notes on ESP® (▷ page 312).

ESP® is deactivated if the  ESP® OFF warning lamp in the instrument cluster lights up continuously when the engine is running.

If the  ESP® warning lamp and the  ESP® OFF warning lamp are lit continuously, ESP® is not available due to a malfunction.

Observe the information on warning lamps (▷ page 260) and display messages which may be shown in the instrument cluster (▷ page 230).

- i** Only use wheels with the recommended tyre sizes. Only then will ESP® function properly.

Characteristics of ESP®

General notes

If the  ESP warning lamp goes out before beginning the journey, ESP® is automatically active.

If ESP® intervenes, the  ESP® warning lamp flashes in the instrument cluster.

If ESP® intervenes:

- ▶ Do not deactivate ESP® under any circumstances.
- ▶ When pulling away, only depress the accelerator pedal as far as is necessary.
- ▶ Adapt your driving style to suit the prevailing road and weather conditions.

ECO start/stop function

The ECO start/stop function switches the engine off automatically if the vehicle stops moving. When pulling away again, the engine starts automatically. ESP® remains in its previously selected status. **Example:** if ESP® was deactivated before the engine was switched off, ESP® remains deactivated when the engine is switched on again.

The ECO start/stop function switches the engine off automatically if the vehicle stops moving. When pulling away again, the engine starts automatically. ESP® remains in its pre-

viously selected status. **Example:** if ESP® was deactivated before the engine was switched off, ESP® remains deactivated when the engine is switched on again.

Deactivating/activating ESP® (AMG vehicles)

Important safety notes

- i** Observe the "Important safety notes" section (▷ page 61).

You can select between the following states of ESP®:

- ESP® is activated.
- SPORT handling mode is activated.
- ESP® is deactivated.

WARNING

When SPORT handling mode is activated, there is a greater risk of skidding and accidents.

Only activate SPORT handling mode in the situations described in the following.

WARNING

If you deactivate ESP®, ESP® no longer stabilises the vehicle. There is an increased risk of skidding and an accident.

Only deactivate ESP® in the situations described in the following.

In the following situations, it may be better to activate SPORT handling mode or deactivate ESP®:

- when using snow chains
- in deep snow
- on sand or gravel
- on specially designated roads when the vehicle's own oversteering and understeering characteristics are desired

Driving in SPORT handling mode or without ESP® requires an extremely qualified and experienced driver.

- ① Activate ESP® as soon as the situations described above no longer apply. ESP® will otherwise not be able to stabilise the vehicle if the vehicle starts to skid or a wheel starts to spin.

Deactivating/activating ESP®

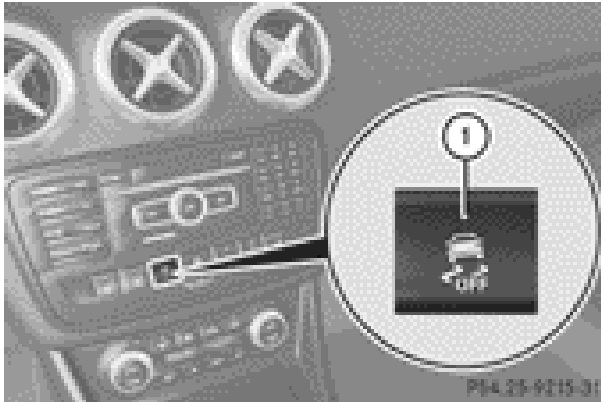

- ▶ **To activate SPORT handling mode:** briefly press button ①. The **SPORT** handling mode warning lamp in the instrument cluster lights up. The **SPORT handling mode** message appears in the multifunction display.
- ▶ **To deactivate SPORT handling mode:** briefly press button ①. The **SPORT** handling mode warning lamp in the instrument cluster goes out.
- ▶ **To deactivate ESP®:** press button ① until the **ESP OFF** warning lamp lights up in the instrument cluster. The **ESP OFF** message appears in the multifunction display.
- ▶ **To activate ESP®:** briefly press button ①. The **ESP OFF** warning lamp in the instrument cluster goes out. The **ESP ON** message appears in the multifunction display.

Characteristics of activated SPORT handling mode

If SPORT handling mode is activated and one or more wheels start to spin, the  ESP® warning lamp in the instrument cluster

flashes. ESP® only stabilises the vehicle to a limited degree.

When SPORT handling mode is activated:

- ESP® only improves driving stability to a limited degree.
- traction control is still activated.
- engine torque is restricted to a limited degree and the drive wheels are able to spin.

The spinning of the wheels results in a cutting action for better traction on loose surfaces.

- ESP® still provides support when you brake.

Characteristics when ESP® is deactivated

If ESP® is deactivated and one or more wheels start to spin, the  ESP® warning lamp in the instrument cluster does not flash. In such situations, ESP® will not stabilise the vehicle.

If you deactivate ESP®:

- ESP® no longer improves driving stability.
- engine torque is no longer limited and the drive wheels are able to spin.

The spinning of the wheels results in a cutting action for better traction on loose surfaces.

- traction control is still activated.
- PRE-SAFE® is no longer available; nor is it activated if you brake firmly with assistance from ESP®.
- COLLISION PREVENTION ASSIST is no longer available; nor is it activated if you brake firmly with assistance from ESP®.
- COLLISION PREVENTION ASSIST is no longer available; nor is it activated if you brake firmly with assistance from ESP®.
- ESP® still provides support when you brake.

Deactivating/activating ESP® (except AMG vehicles)

Important safety notes

You can select between the following states of ESP®:

- ESP® is activated.
- ESP® is deactivated.

WARNING

If you deactivate ESP®, ESP® no longer stabilises the vehicle. There is an increased risk of skidding and an accident.

Only deactivate ESP® in the situations described in the following.

It may be best to deactivate ESP® in the following situations:

- when using snow chains
- in deep snow
- on sand or gravel

- i** Activate ESP® as soon as the situations described above no longer apply. ESP® will otherwise not be able to stabilise the vehicle if the vehicle starts to skid or a wheel starts to spin.

Deactivating/activating ESP®

You can deactivate or activate ESP® via the on-board computer.

- **To deactivate:** (▷ page 218).

The  ESP® OFF warning lamp in the instrument cluster lights up.

- **To activate:** (▷ page 218).

The  ESP® OFF warning lamp in the instrument cluster goes out.

Characteristics when ESP® is deactivated

If ESP® is deactivated and one or more wheels start to spin, the  ESP® warning lamp in the instrument cluster flashes. In such situations, ESP® will not stabilise the vehicle.

If you deactivate ESP®:

- ESP® no longer improves driving stability.
- engine torque is no longer limited and the drive wheels are able to spin.
The spinning of the wheels results in a cutting action for better traction on loose surfaces.
- traction control is still activated.
- ESP® still provides support when you brake.

ESP® trailer stabilisation

General notes

If your vehicle/trailer combination begins to lurch, ESP® assists you in this situation. ESP® slows the vehicle down by braking and limiting the engine output until the vehicle/trailer combination has stabilised.

Important safety notes

WARNING

If road and weather conditions are poor, trailer stabilisation will not be able to prevent the vehicle/trailer combination from swerving. Trailers with a high centre of gravity can tip over before ESP® can detect this. There is a risk of an accident.

Always adapt your driving style to the prevailing road and weather conditions.

If your vehicle/trailer combination begins to lurch, you can only stabilise the vehicle/trailer combination by depressing the brake firmly.

ESP® trailer stabilisation is active above speeds of about 65 km/h.

ESP® trailer stabilisation does not work if ESP® is deactivated or disabled because of a malfunction.

EBD (electronic brake force distribution)

- Observe the "Important safety notes" section for driving safety systems (▷ page 61).

WARNING

If EBD has malfunctioned, the rear wheels can still lock, e.g. under full braking. This increases the risk of skidding and an accident.

You should therefore adapt your driving style to the different handling characteristics. Have the brake system checked at a qualified specialist workshop.

Observe information regarding indicator and warning lamps (▷ page 258) as well as display messages (▷ page 232).

EBD monitors and controls the brake pressure on the rear wheels to improve driving stability while braking.

ADAPTIVE BRAKE

ADAPTIVE BRAKE enhances braking safety and offers increased braking comfort. In addition to the braking function, ADAPTIVE BRAKE also has the HOLD function (▷ page 180) and hill start assist (▷ page 145). For further information, see Driving tips (▷ page 166).

STEER CONTROL

STEER CONTROL helps you by transmitting a noticeable steering force to the steering wheel in the direction required for vehicle stabilisation.

This steering support is provided in particular if:

- both right wheels or both left wheels are on a wet or slippery road surface when you brake
- the vehicle starts to skid.

If there is an ESP[®] malfunction, you will not receive any steering support from STEER

CONTROL. Power steering will, however, continue to function.

Anti-theft systems

Immobiliser

The immobiliser prevents your vehicle from being started without the correct key.

- ▶ **To activate:** remove the key from the ignition lock.
- ▶ **To deactivate:** switch on the ignition.

When leaving the vehicle, always take the key with you and lock the vehicle. The engine can be started by anyone with a valid key that is left inside the vehicle.

- The immobiliser is always deactivated when you start the engine.

ATA (Anti-Theft Alarm system)



- ▶ **To prime:** lock the vehicle with the key. Indicator lamp ① flashes. The alarm system is primed after approximately 15 seconds.
- ▶ **To deactivate:** unlock the vehicle with the key.

or

- ▶ Insert the key into the ignition lock.

A visual and audible alarm is triggered if the alarm system is primed and you open:

- the vehicle with the emergency key element
- a door
- the tailgate
- the bonnet

► **To stop the alarm:** insert the key into the ignition lock.
The alarm is switched off.

or

► Press the  or  button on the key.
The alarm is switched off.

The alarm is not switched off, even if you close the open door that has triggered it, for example.

Tow-away protection

Function

An audible and visual alarm is triggered if your vehicle's angle of inclination is altered while tow-away protection is primed. This can occur if the vehicle is jacked up on one side, for example.

Activating

- Make sure that:
- the doors are closed.
 - the tailgate is closed.
- Only then is the tow-away protection primed.
- Lock the vehicle with the key.
Tow-away protection is primed after approximately 60 seconds.

Deactivating

► Unlock the vehicle with the key.

or

► Insert the key into the ignition lock.
Tow-away protection is switched off automatically.

Deactivating

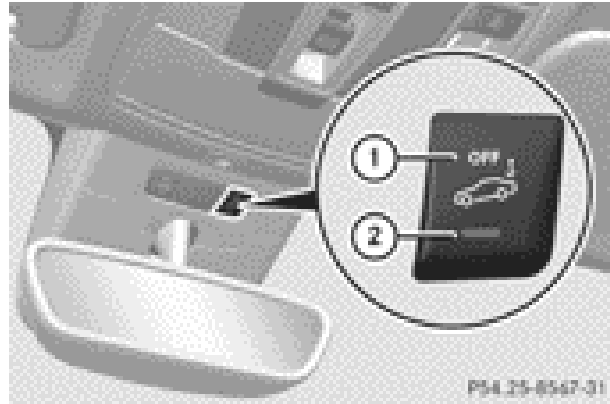

- Remove the key from the ignition lock.
- Press button ①.
Indicator lamp ② lights up briefly.
- Lock the vehicle with the key.
Tow-away protection is deactivated.

Tow-away protection remains deactivated until:

- the vehicle is unlocked again
- a door is opened and closed again
- the vehicle is locked again

To prevent a false alarm, deactivate the tow-away protection if you lock your vehicle and it:

- is being transported
- is being loaded onto a ferry or car transporter, for example
- is parked on a movable surface, e.g. in a split-level garage

Interior motion sensor

Function

When the interior motion sensor is primed, a visual and audible alarm is triggered if movement is detected in the vehicle interior. This can occur if someone reaches into the vehicle interior, for example.

Activating

- ▶ Make sure that:
 - the side windows are closed.
 - the panorama sliding sunroof is closed.
 - there are no objects, e.g. mascots, hanging on the rear-view mirror or on the grab handles on the roof trim.
 This will prevent false alarms.
- ▶ Make sure that:
 - the doors are closed.
 - the panorama sliding sunroof is closed.
 - the tailgate is closed.
 Only then is the interior motion sensor primed.
- ▶ Lock the vehicle with the key.
The interior motion sensor is primed after approximately 30 seconds.

Deactivating

- ▶ Unlock the vehicle with the key.
- or
- ▶ Insert the key into the ignition lock.
The interior motion sensor is switched off automatically.

Deactivating



- ▶ Remove the key from the ignition lock.
- ▶ Press button ①.
Indicator lamp ② flashes briefly.
- ▶ Lock the vehicle with the key.
The interior motion sensor is deactivated.

The interior motion sensor remains deactivated until:

- the vehicle is unlocked again
- a door is opened and closed again
- the vehicle is locked again

To prevent a false alarm, deactivate the interior motion sensor if you lock your vehicle and:

- people or animals remain in the vehicle.
- the panorama sliding sunroof remains open.
- the side windows remain open.

i UK only: your vehicle is equipped with a double lock function. The doors cannot be opened from the inside if the vehicle has been locked with the key (▷ page 80). Deactivate the interior motion sensor before you lock the vehicle with the key. The doors can then be opened from the inside after the vehicle has been locked from the outside with the key. Observe the "Important safety notes" (▷ page 79).

Useful information	74
Key	74
Doors	79
Luggage compartment	82
Side windows	83
Panorama sliding sunroof	86

Useful information

- i** This Owner's Manual describes all models, series and optional equipment for your vehicle that were available at the time of going to press. National variations are possible. Note that your vehicle may not be equipped with all of the functions described. This is also the case for systems and functions relevant to safety.
- i** Read the information on qualified specialist workshops: (▷ page 24).

Key

Important safety notes

WARNING

If children are left unsupervised in the vehicle, they could:

- open the doors, thus endangering other people or road users.
- get out and disrupt traffic.
- operate the vehicle's equipment.

Additionally, children could set the vehicle in motion if, for example, they:

- release the parking brake.
- shift the automatic transmission out of parking position P.
- shift the manual transmission into neutral.
- start the engine.

There is a risk of an accident and injury.

When leaving the vehicle, always take the key with you and lock the vehicle. Never leave children or animals unattended in the vehicle. Always keep the key out of reach of children.

WARNING

If persons (particularly children) are exposed to heat or cold for a prolonged period, there is a risk of serious or even fatal injuries. Never leave persons (particularly children) unattended in the vehicle.

WARNING

If you attach heavy or large objects to the key, the key could be unintentionally turned in the ignition lock. This could cause the engine to be switched off. There is a risk of an accident. Do not attach any heavy or large objects to the key. Remove any bulky keyrings before inserting the key into the ignition lock.

- !** Keep the key away from strong magnetic fields. Otherwise, the remote control function could be affected.

Strong magnetic fields can occur in the vicinity of powerful electrical installations.

Do not keep the key:

- with electronic devices, e.g. a mobile phone or another key
- with metallic objects, e.g. coins or metal film
- inside metallic objects, e.g. a metal case

United Kingdom only:

WARNING



When the double locks are activated, the doors can no longer be opened from the inside. People in the vehicle can no longer get out, e.g. in hazardous situations. There is a risk of injury.

Therefore, do not leave any people unsupervised in the vehicle, particularly children, elderly people or people in need of special assistance. Do not activate the double lock when people are in the vehicle.

If the vehicle has been locked with the key, then the double lock function is activated as standard. You can deactivate the double lock function by deactivating the interior motion sensor (▷ page 70). The doors can then be opened from the inside after the vehicle has been locked from the outside. The anti-theft alarm system is triggered if the door is opened from the inside. Switch off the alarm (▷ page 69).

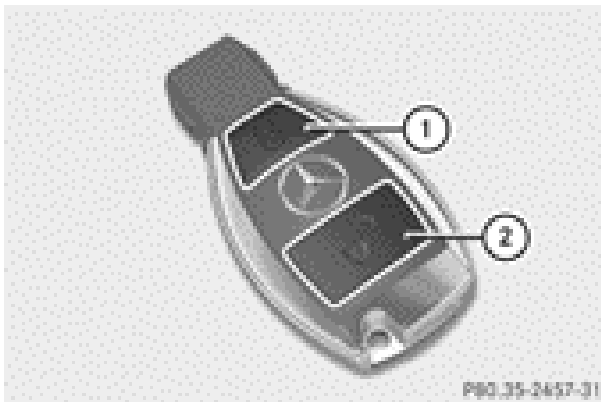
Key functions



- ①  To lock the vehicle
 ②  To unlock the vehicle

► **To unlock centrally:** press button ②.

If you do not open the vehicle within approximately 40 seconds of unlocking:

- the vehicle is locked again.
- the anti-theft system is primed again.

► **To lock centrally:** press button ①.

The key centrally locks/unlocks:



- the doors
- the tailgate
- the fuel filler flap



When unlocking, the turn signals flash once.
 When locking, they flash three times.

- i** When it is dark, the surround lighting also comes on if it is activated in the on-board computer (▷ page 222).
- i** You can also set an audible signal to confirm that the vehicle has been locked. The audible signal can be activated and deactivated using the on-board computer (▷ page 223).

Changing the settings of the locking system

You can change the settings of the locking system. This means that only the driver's door and the fuel filler flap are unlocked when the vehicle is unlocked. This is useful if you frequently travel on your own.

► **To change the setting:** press and hold down the  and  buttons simultaneously for approximately six seconds until battery check lamp (▷ page 76) flashes twice.

i If the setting of the locking system is changed within the signal range of the vehicle, pressing the  or  button:



- locks or
- unlocks the vehicle

The key now functions as follows:

► **To unlock the driver's door:** press the  button once.

► **To unlock centrally:** press the  button twice.

► **To lock centrally:** press the  button.

► **To restore the factory settings:** press and hold down the  and  buttons simultaneously for approximately six seconds until the battery check lamp flashes twice (▷ page 76).



Emergency key element

General notes

If the vehicle can no longer be unlocked with the key, use the emergency key element.

If you use the emergency key element to unlock and open the driver's door, the anti-theft alarm system will be triggered (▷ page 69).

There are several ways to turn off the alarm:

- Press the  or  button on the key.
 or
 ► Insert the key into the ignition lock.

If you unlock the vehicle using the emergency key element, the fuel filler flap will not be unlocked automatically.

- ▶ **To unlock the fuel filler flap:** insert the key into the ignition lock.

Removing the emergency key element

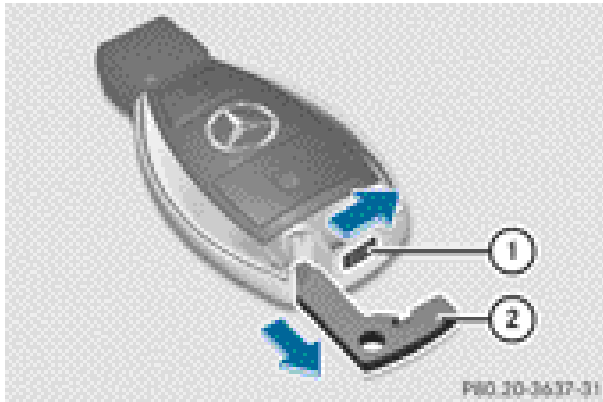

- ▶ Push release catch ① in the direction of the arrow and at the same time, remove emergency key element ② from the key.

Battery of the key

Important safety notes

WARNING

Batteries contain toxic and corrosive substances. If batteries are swallowed, it can result in severe health problems. There is a risk of fatal injury.

Keep batteries out of the reach of children. If a battery is swallowed, seek medical attention immediately.

Environmental note



Batteries contain pollutants. It is illegal to dispose of them with the household rubbish. They must be collected separately and disposed of in an

environmentally responsible recycling system.







Dispose of batteries in an environmentally responsible manner. Take discharged batteries to a qualified specialist workshop or to a collection point for used batteries.

Mercedes-Benz recommends that you have the batteries replaced at a qualified specialist workshop.

Checking the battery



- ▶ Press the  or  button. The battery is working properly if battery check lamp ① lights up briefly. The battery is discharged if battery check lamp ① does not light up briefly.
- ▶ Replace the battery (▷ page 76).
- i** If the key battery is checked within the signal reception range of the vehicle, pressing the  or  button:
 - locks or
 - unlocks the vehicle
- i** You can obtain a battery from any qualified specialist workshop.

Replacing the battery

You require a CR 2025 3 V cell battery.

- ▶ Take the emergency key element out of the key (▶ page 75).

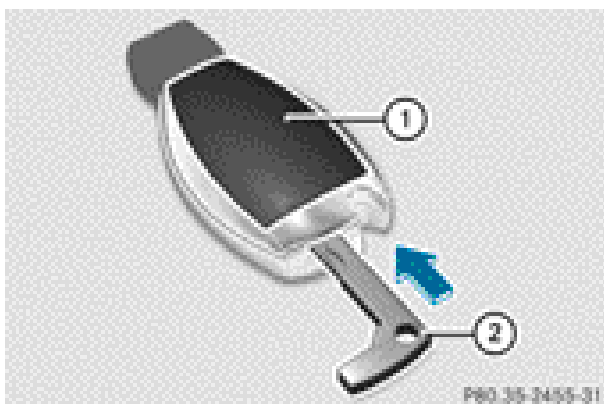



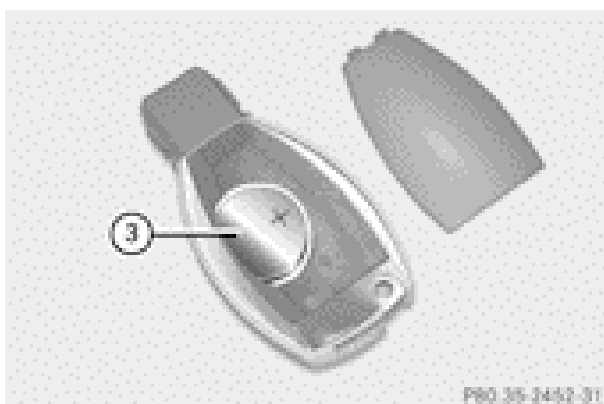

- ▶ Press emergency key element ② into the opening in the key in the direction of the arrow until battery tray cover ① opens. When doing so, do not hold cover ① shut.
- ▶ Remove battery tray cover ①.



- ▶ Repeatedly tap the key against your palm until battery ③ falls out.
- ▶ Insert the new battery with the positive terminal facing upwards. Use a lint-free cloth to do so.
- ▶ Make sure that the surface of the battery is free from lint, grease and all other forms of contamination.
- ▶ Insert the front tabs of battery tray cover ① and then press to close it.
- ▶ Insert the emergency key element into the key.
- ▶ Check the function of all key buttons on the vehicle.

Problems with the key

Problem	Possible causes/consequences and ► Solutions
<p>You cannot lock or unlock the vehicle using the key.</p>	<p>The key battery is discharged or nearly discharged.</p> <ul style="list-style-type: none"> ► Try again to lock/unlock the vehicle using the remote control function of the key. Point the tip of the key at the driver's door handle from close range and press the  /  button. <p>If this does not work:</p> <ul style="list-style-type: none"> ► Check the key battery and replace it if necessary (▷ page 76). ► Lock (▷ page 81) or unlock (▷ page 81) the vehicle using the emergency key element. <p>There is interference from a powerful source of radio waves.</p> <ul style="list-style-type: none"> ► Try again to lock/unlock the vehicle using the remote control function of the key. Point the tip of the key at the driver's door handle from close range and press the  /  button. <p>The key is faulty.</p> <ul style="list-style-type: none"> ► Lock (▷ page 81) or unlock (▷ page 81) the vehicle using the emergency key element. ► Have the key checked at a qualified specialist workshop.
<p>You have lost a key.</p>	<ul style="list-style-type: none"> ► Have the key deactivated at a qualified specialist workshop. ► Report the loss immediately to the vehicle insurers. ► If necessary, have the locks changed as well.
<p>You have lost the emergency key element.</p>	<ul style="list-style-type: none"> ► Report the loss immediately to the vehicle insurers. ► If necessary, have the locks changed as well.

Problem	Possible causes/consequences and ► Solutions
The engine cannot be started using the key.	<p>The on-board voltage is too low.</p> <ul style="list-style-type: none"> ► Switch off non-essential consumers, e.g. seat heating or interior lighting, and try to start the engine again. <p>If this does not work:</p> <ul style="list-style-type: none"> ► Check the starter battery and charge it if necessary (▷ page 304). <p>or</p> <ul style="list-style-type: none"> ► Jump-start the vehicle (▷ page 308). <p>or</p> <ul style="list-style-type: none"> ► Consult a qualified specialist workshop.
The engine cannot be started using the key.	<p>The steering lock is mechanically blocked.</p> <ul style="list-style-type: none"> ► Remove the key and reinsert it into the ignition lock. While doing this, turn the steering wheel in both directions.

Doors

Important safety notes

WARNING

If children are left unsupervised in the vehicle, they could:

- open the doors, thus endangering other people or road users.
- get out and disrupt traffic.
- operate the vehicle's equipment.

Additionally, children could set the vehicle in motion if, for example, they:

- release the parking brake.
- shift the automatic transmission out of parking position P.
- shift the manual transmission into neutral.
- start the engine.

There is a risk of an accident and injury.

When leaving the vehicle, always take the key with you and lock the vehicle. Never leave children or animals unattended in the vehicle. Always keep the key out of reach of children.

WARNING

If persons (particularly children) are exposed to heat or cold for a prolonged period, there is a risk of serious or even fatal injuries. Never leave persons (particularly children) unattended in the vehicle.

United Kingdom only:

WARNING

When the double locks are activated, the doors can no longer be opened from the inside. People in the vehicle can no longer get out, e.g. in hazardous situations. There is a risk of injury.

Therefore, do not leave any people unsupervised in the vehicle, particularly children, elderly people or people in need of special assistance. Do not activate the double lock when people are in the vehicle.

If the vehicle has been locked with the key, then the double lock function is activated as standard. You can deactivate the double lock function by deactivating the interior motion sensor (▷ page 70). The doors can then be opened from the inside after the vehicle has been locked from the outside. The anti-theft

alarm system is triggered if the door is opened from the inside. Switch off the alarm (▷ page 69).

Unlocking and opening the doors from the inside

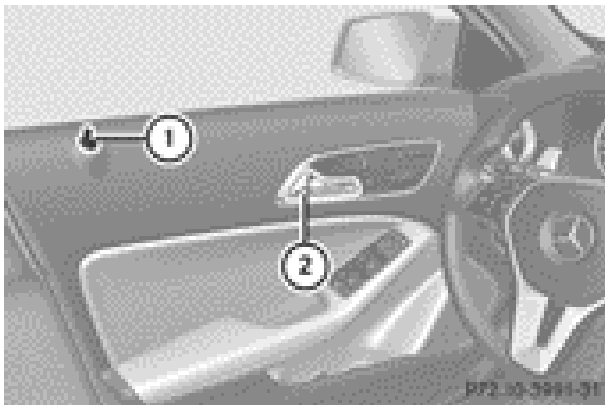

- ▶ Pull door handle ②.
If the door is locked, locking knob ① pops up. The door is unlocked and can be opened.

For all countries except the United Kingdom:

You can open a door from inside the vehicle even if it has been locked.

If the vehicle has previously been locked with the key, opening a door from the inside will trigger the anti-theft alarm system. Switch off the alarm (▷ page 69).

You can only open the rear doors from inside the vehicle if they are not secured by the child-proof locks (▷ page 60).

Only for the United Kingdom: if the vehicle has been locked with the key, the double lock function is activated as standard. It is then not possible to open the doors from inside the vehicle. Deactivate the interior motion sensor (▷ page 70) before you lock the vehicle with the key. The doors can then be opened from the inside after the vehicle has been locked from the outside. The anti-theft alarm system is triggered if the door is opened from the inside. Switch off the alarm (▷ page 69).

Centrally locking and unlocking the vehicle from the inside

You can centrally lock or unlock the vehicle from the inside. This can be useful if you wish to lock the vehicle before pulling away, for example.

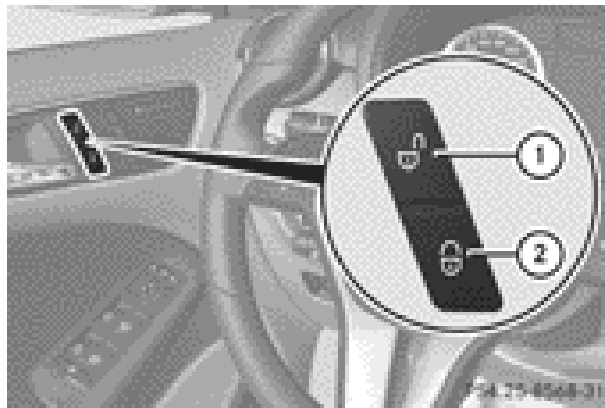

- ▶ **To unlock:** press button ①.
- ▶ **To lock:** press button ②.
If all the doors and the tailgate are closed, the vehicle locks.

This does not lock or unlock the fuel filler flap. You cannot unlock the vehicle centrally from the inside if the vehicle has been locked with the key.

For all countries except the United Kingdom: you can open a door from inside the vehicle even if it has been locked.

If the vehicle has previously been locked with the key, opening a door from the inside will trigger the anti-theft alarm system. Switch off the alarm (▷ page 69).

Only for the United Kingdom: if the vehicle has been locked with the key, the double lock function is activated as standard. It is then not possible to open the doors from inside the vehicle. Deactivate the interior motion sensor (▷ page 70) before you lock the vehicle with the key. The doors can then be opened from the inside after the vehicle has been locked from the outside. The anti-theft alarm system is triggered if the door is opened from the inside. Switch off the alarm (▷ page 69).

You can only open the rear doors from inside the vehicle if they are not secured by the child-proof locks (▷ page 60).

If the vehicle has been locked using the locking button for the central locking, or has been locked automatically, and a door is opened from the inside:

- the vehicle will be fully unlocked if it had previously been fully unlocked
- only the door which has been opened from the inside is unlocked if only the driver's door had been previously unlocked

Automatic locking feature

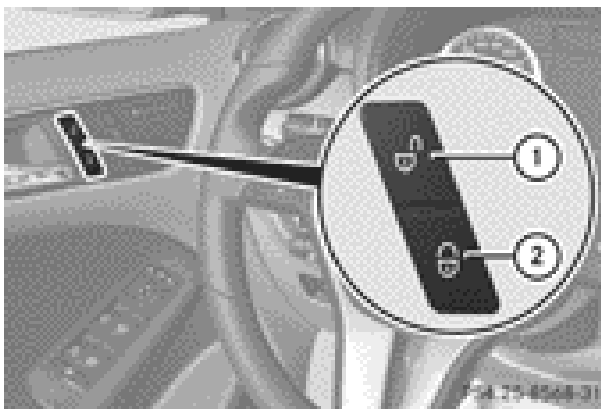

- ▶ **To deactivate:** press and hold button ① for about five seconds until a tone sounds.
 - ▶ **To activate:** press and hold button ② for about five seconds until a tone sounds.
- i** If you press one of the two buttons and do not hear a tone, the relevant setting has already been selected.

The vehicle is locked automatically when the ignition is switched on and the wheels are turning.

You could therefore be locked out if:

- the vehicle is being pushed.
- the vehicle is being towed.
- the vehicle is being tested on a dynamometer.

You can also switch the automatic locking function on and off using the on-board computer (▷ page 223).

Unlocking the driver's door (emergency key element)

If the vehicle can no longer be unlocked with the key, use the emergency key element.

If you use the emergency key element to unlock and open the driver's door, the anti-theft alarm system will be triggered (▷ page 69).

- ▶ Take the emergency key element out of the key (▷ page 75).
- ▶ Insert the emergency key element into the lock of the driver's door as far as it will go.

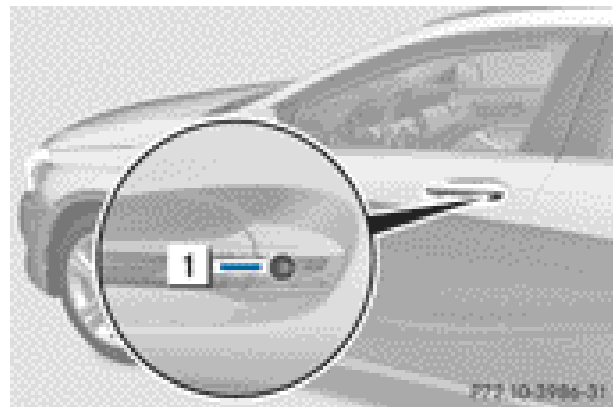

- ▶ Turn the emergency key element anti-clockwise to position 1. The door is unlocked.
- i** On right-hand-drive vehicles, turn the emergency key element clockwise.
- ▶ Turn the emergency key element back and remove it.
 - ▶ Insert the emergency key element into the key.

Locking the vehicle (emergency key element)

If the vehicle can no longer be locked with the key, use the emergency key element.

- ▶ Open the driver's door.
- ▶ Close the front-passenger door, the rear doors and the tailgate.
- ▶ Press the locking button (▷ page 80).
- ▶ Check whether the locking knobs on the front-passenger door and the rear doors

are still visible. Press down the locking knobs manually, if necessary (▷ page 80).

- ▶ Close the driver's door.
- ▶ Take the emergency key element out of the key (▷ page 75).
- ▶ Insert the emergency key element into the lock of the driver's door as far as it will go.

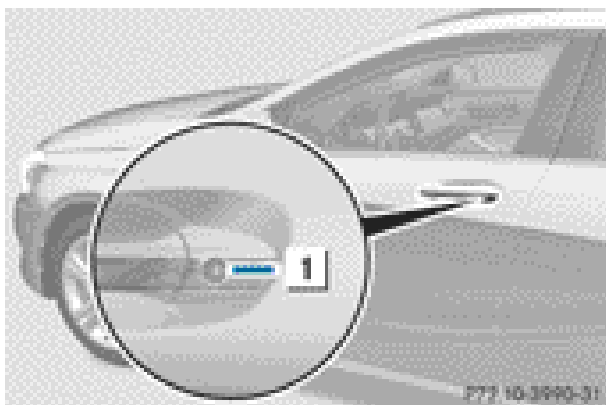

- ▶ Turn the emergency key element clockwise as far as it will go to position **1**.
- i** On right-hand-drive vehicles, turn the emergency key element anti-clockwise.
- ▶ Turn the emergency key element back and remove it.
- ▶ Make sure that the doors and the tailgate are locked.
- ▶ Insert the emergency key element into the key.
- i** If you lock the vehicle as described above, the fuel filler flap is not locked. The anti-theft alarm system is not primed.

Luggage compartment

Important safety notes

! WARNING

Combustion engines emit poisonous exhaust gases such as carbon monoxide. If the tailgate is open when the engine is running, particularly if the vehicle is moving, exhaust fumes could enter the passenger compartment. There is a risk of poisoning.

Turn off the engine before opening the tailgate. Never drive with the tailgate open.

! WARNING

If persons (particularly children) are exposed to heat or cold for a prolonged period, there is a risk of serious or even fatal injuries. Never leave persons (particularly children) unattended in the vehicle.

! The tailgate swings upwards and to the rear when opened. Therefore, make sure that there is sufficient clearance above and behind the tailgate.

i The opening dimensions of the tailgate can be found in the "Vehicle data" section (▷ page 346).

You should preferably place luggage or loads in the luggage compartment. Observe the loading guidelines (▷ page 268).

Do not leave the key in the luggage compartment. You could otherwise lock yourself out.

The tailgate can be:

- opened and closed manually from outside
- unlocked from the inside with the emergency key element

Opening/closing from the outside

Opening

- ▶ Press the  button on the key.

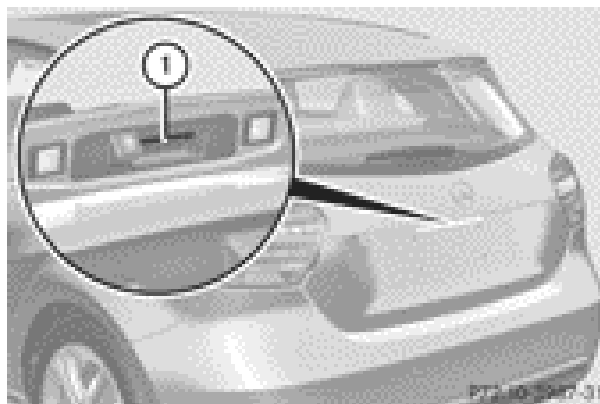

- ▶ Pull handle **1**.
- ▶ Raise the tailgate.

Closing



- ▶ Pull the tailgate down using handle ①.
- ▶ Let the tailgate to drop into the lock.
- ▶ If necessary, lock the vehicle with the  button on the key.

Tailgate emergency release

If the tailgate can no longer be opened from outside the vehicle, use the emergency release on the inside of the tailgate.

- ❗ The tailgate swings upwards and to the rear when opened. Therefore, make sure that there is sufficient clearance above and behind the tailgate.
- i The opening dimensions of the tailgate can be found in the "Vehicle data" section (▶ page 346).

You can reach the emergency release via the luggage compartment. Fold the rear backrests forward (▶ page 272).

- ▶ Take the emergency key element out of the key (▶ page 75).

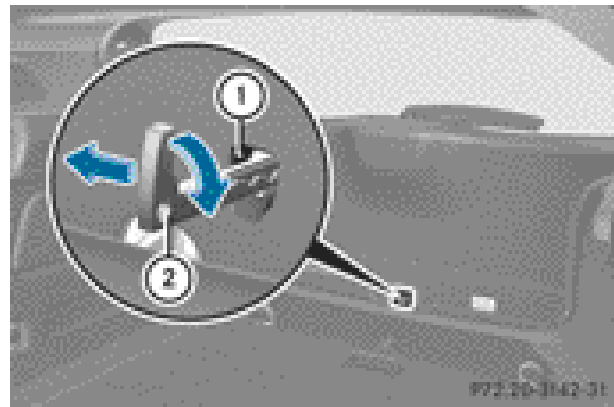

- ▶ Insert emergency key element ② into the opening in trim ①.
- ▶ Turn emergency key element ② 90° clockwise.
- ▶ Push emergency key element ② in the direction of the arrow and open the tailgate.

Side windows

Important safety notes

WARNING

While opening the side windows, body parts in the closing area could become trapped. There is a risk of injury.

Make sure that no body parts are in close proximity during the closing procedure. If somebody becomes trapped, release the switch or press the switch to open the side window again.

WARNING

If children operate the side windows they could become trapped, particularly if they are left unsupervised. There is a risk of injury. Activate the override feature for the rear side windows. When leaving the vehicle, always take the key with you and lock the vehicle. Never leave children unattended in the vehicle.

Side window reversing feature

The side windows are equipped with an automatic reversing feature. If a solid object blocks or restricts a side window during the closing process, the side window opens again automatically. However, the automatic reversing feature is only an aid and does not relieve you of the responsibility to pay attention when closing a side window.

WARNING

The reversing function does not react:

- to soft, light and thin objects, e.g. small fingers
- over the last 4 mm of the closing movement
- during resetting
- when closing the side window again manually immediately after automatic reversing

This means that the reversing function cannot prevent someone being trapped in these situations. There is a risk of injury.

When closing make sure that no parts of the body are in the closing area. If someone becomes trapped, press the switch to open the side window again.

Opening and closing the side windows

The switches for all side windows are located on the driver's door. There is also a switch on each door for the corresponding side window. The switches on the driver's door take precedence.

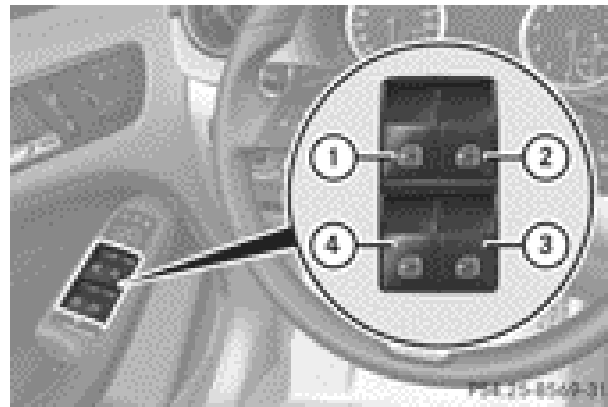

- ① Front left
- ② Front right
- ③ Rear right
- ④ Rear left

- i** The side windows cannot be operated from the rear when the override feature for the side windows is activated (▷ page 61).



 - ▶ Turn the key to position **1** or **2** in the ignition lock.
 - ▶ **To open:** press the corresponding switch.
 - ▶ **To open fully:** press the corresponding switch beyond the point of resistance. Automatic closing is started.
 - ▶ **To close:** pull the corresponding switch.
 - ▶ **To close fully:** pull the corresponding switch beyond the pressure point. Automatic closing is started.
 - ▶ **To interrupt the automatic opening/closing:** press/pull the corresponding switch again.
- i** If you press the switch beyond the point of resistance, an automatic opening/closing process is started in the corresponding direction. You can stop automatic operation by pressing again.
- i** You can continue to operate the side windows after switching off the engine or removing the key. This function remains active for five minutes or until the driver's or front-passenger door is opened.

Convenience opening feature

You can ventilate the vehicle before you start driving. To do this, the key is used to carry out the following functions simultaneously:

- unlock the vehicle
- open the side windows
- open the panorama sliding sunroof and the roller sunblinds

i The convenience opening feature can only be operated using the key. The key must be close to the driver's door handle.

- ▶ Point the tip of the key at the driver's door handle.
- ▶ Press and hold the  button until the side windows and the panorama sunroof are in the desired position.
If the roller sunblinds of the panorama sliding sunroof are closed, the roller sunblinds are opened first.
- ▶ Press and hold the  button again until the panorama sliding sunroof is in the desired position.
- ▶ **To interrupt convenience opening:** release the  button.

Convenience closing feature

WARNING

When the convenience closing feature is operating, parts of the body could become trapped in the closing area of the side window and the sliding sunroof. There is a risk of injury.

Observe the complete closing procedure when the convenience closing feature is operating. When closing make sure that no parts of the body are in the closing area.

When you lock the vehicle, you can simultaneously:



- close the side windows
- close the panorama sliding sunroof

On vehicles with a panorama sliding sunroof, you can then close the roller sunblinds.

i The key must be close to the driver's door handle.

- ▶ Point the tip of the key at the driver's door handle.
- ▶ Press and hold the  button until the side windows and the panorama sliding sunroof are fully closed.
- ▶ Make sure that all the side windows and the panorama sliding sunroof are closed.

On vehicles with a panorama sliding sunroof:

- ▶ Press and hold the  button again until the roller sunblinds of the panorama sliding sunroof close.
- ▶ **To interrupt convenience closing:** release the  button.

Resetting the side windows

You must reset each side window if:

- the side window opens again slightly after being closed fully.
- the side window can no longer be fully opened or closed.
- ▶ Close all doors.
- ▶ Turn the key to position **1** or **2** in the ignition lock.
- ▶ Pull the corresponding switch on the door control panel until the side window is completely closed (▷ page 84).
- ▶ Hold the switch for an additional second.

If the side window opens again slightly:

- ▶ Immediately pull the corresponding switch on the door control panel until the side window is completely closed (▷ page 84).
- ▶ Hold the switch for an additional second.
- ▶ If the corresponding side window remains closed after the button has been released, the side window has been reset correctly. If this is not the case, repeat the steps above again.

Problems with the side windows **WARNING**

If you close a side window again immediately after it has been blocked or reset, the side window closes with increased or maximum force. The reversing function is then not active. Parts of the body could be trapped in the closing area in the process. This poses an increased risk of injury or even fatal injury.

Make sure that no parts of the body are in the closing area. To stop the closing process, release the switch or push the switch again to reopen the side window.

Problem: a side window cannot be closed because it is blocked by objects, e.g. leaves in the window guide.

- ▶ Remove the objects.
- ▶ Close the side window.

Problem: a side window cannot be closed and you cannot see the cause. If a side window is obstructed during closing and reopens again slightly:

- ▶ Immediately after the window blocks, pull the corresponding switch again until the side window has closed.
The side window is closed with increased force.

If a side window is obstructed again during closing and reopens again slightly:

- ▶ Immediately after the window blocks, pull the corresponding switch again until the side window has closed.
The side window is closed without the anti-entrapment feature.

Panorama sliding sunroof**Important safety notes**

In the following section, the term "sliding sunroof" refers to the panorama sliding sunroof.

 **WARNING**

While opening and closing the sliding sunroof, body parts in close proximity could become trapped. There is a risk of injury.

Make sure that no body parts are in close proximity during the opening and closing procedures.

If somebody becomes trapped:

- release the switch immediately, or
- during automatic operation, push the switch briefly in any direction

The opening or closing procedure will be stopped.

 **WARNING**

If children operate the sliding sunroof they could become trapped, particularly if they are left unsupervised. There is a risk of injury.

When leaving the vehicle, always take the key with you and lock the vehicle. Never leave children unattended in the vehicle.

 **WARNING**

At high speeds the sliding sunroof automatically lowers slightly at the rear. This could trap you or other persons. There is a risk of injury. Make sure that nobody reaches into the sweep of the sliding sunroof whilst the vehicle is in motion.

If somebody becomes trapped, reduce speed immediately, paying attention to road and traffic conditions. The sliding sunroof opens again to its original position.

If the maximum position is not reached, you can raise it further.

 Only open the panorama sliding sunroof if it is free of snow and ice. Otherwise, malfunctions may occur.

Do not allow anything to protrude from the sliding sunroof. Otherwise, the seals could be damaged.

 Resonance noises can occur in addition to the usual airflow noises when the sliding sunroof is open. They are caused by minor

pressure fluctuations in the vehicle interior. Change the position of the sliding sunroof or open a side window slightly to reduce or eliminate these noises.

Sliding sunroof reversing feature

The sliding sunroof is equipped with an automatic reversing feature. If a solid object blocks or restricts the sliding sunroof during the closing process, the sliding sunroof opens again automatically. However, the automatic reversing feature is only an aid and does not relieve you of the responsibility to pay attention when closing the sliding sunroof.

WARNING

The reversing function does not react:

- to soft, light and thin objects, e.g. small fingers
- over the last 4 mm of the closing movement
- during resetting
- when closing the sliding sunroof again manually immediately after automatic reversing

This means that the reversing function cannot prevent someone being trapped in these situations. There is a risk of injury.

When closing make sure that no parts of the body are in the closing area.

If someone is trapped:

- release the switch immediately or
- press the switch in any direction during the automatic closing process

The closing process is stopped.

Operating the sliding sunroof

Opening and closing



Overhead control panel

- ① To raise
- ② To open
- ③ To close/lower

► Turn the key to position **1** or **2** in the ignition lock.

► Press or pull the  switch in the corresponding direction.

i If you press the  switch beyond the point of resistance, an automatic opening/closing process is started in the corresponding direction. You can stop automatic operation by pressing again.

i After opening the sliding sunroof, the roller sunblind closes slightly automatically. This reduces drafts in the vehicle interior.

i If the sliding sunroof is raised at the rear, it lowers slightly automatically at higher speeds. The noise level in the vehicle interior is reduced as a result.

At low speeds it raises again automatically.

i You can continue to operate the sliding sunroof after switching off the engine or removing the key. This function remains active for five minutes or until you open a front door.

i The sliding sunroof cannot be opened if a roof carrier is fitted. In order to allow ven-

tilation of the vehicle interior, you can raise the sliding sunroof.

If contact is made with a roof carrier approved by Mercedes-Benz, the sliding sunroof lowers slightly but remains raised at the rear.

Rain-closing feature

The rain-closing feature is only available for vehicles with a rain sensor.

When the key is in position **0** in the ignition lock or is removed, the sliding sunroof closes automatically:

- if it starts to rain
- at extreme outside temperatures
- after six hours
- if there is a malfunction in the power supply

The sliding sunroof remains raised at the rear in order to allow ventilation of the vehicle interior.

i If the sliding sunroof is obstructed when being closed by the rain-closing feature, it opens again slightly. The rain-closing feature is then deactivated.

The sliding sunroof does not close if:

- it is raised at the rear.
- it is blocked.
- no rain is falling on the area of the wind-screen being monitored by the rain sensor, e.g. because the vehicle is under a bridge.

Operating the roller sunblinds for the sliding sunroof

Important safety notes

WARNING

When opening or closing the roller sunblind parts of the body could be trapped between the roller sunblind and the frame or sliding sunroof. There is a risk of injury.

When opening or closing make sure that no parts of the body are in the sweep of the roller sunblind.

If someone is trapped:

- release the switch immediately or
- press the switch in any direction during the automatic opening/closing process

The opening/closing process is stopped.

The roller sunblinds shield the vehicle interior from sunlight. The two roller sunblinds can only be opened and closed together when the sliding sunroof is closed.

Roller sunblind reversing feature

The roller sunblinds are equipped with an automatic reversing feature. If a solid object blocks or restricts the roller blind during the closing process, the roller blind opens again automatically. However, the automatic reversing feature is only an aid and does not relieve you of the responsibility to pay attention when closing the roller blinds.

WARNING

The reversing feature especially does not react to soft, light and thin objects, such as small fingers. This means that the reversing feature cannot prevent someone being trapped in these situations. There is a risk of injury.

When closing make sure that no parts of the body are in the sweep of the roller sunblind.

If someone is trapped:

- release the switch immediately or
- press the switch in any direction during the automatic opening/closing process



The closing process is stopped.

Opening and closing





Overhead control panel



- ① To open
- ② To open
- ③ To close

- ▶ Turn the key to position **1** or **2** in the ignition lock.
- ▶ Press or pull the  switch in the corresponding direction.
- i** If you press the  switch beyond the point of resistance, an automatic opening/closing process is started in the corresponding direction. You can stop automatic operation by pressing again.
- i** After opening the sliding sunroof, the roller sunblind closes slightly automatically. This reduces drafts in the vehicle interior.

Resetting the sliding sunroof and the roller sunblinds

If the sliding sunroof or the roller sunblinds do not move smoothly, reset the sliding sunroof and the roller sunblinds:

- ▶ Turn the key to position **1** or **2** in the ignition lock.
- ▶ Pull the  switch repeatedly to the point of resistance in the direction of arrow ③ until the sliding sunroof is fully closed.
- ▶ Keep the  switch pulled for an additional second.

- ▶ Pull the  switch repeatedly to the point of resistance in the direction of arrow ③ until the roller sunblinds are fully closed.
- ▶ Keep the  switch pulled for an additional second.
- ▶ Make sure that the sliding sunroof (▷ page 87) and the roller sunblinds (▷ page 89) can be fully opened and closed again.
- ▶ If this is not the case, repeat the steps above again.

Problems with the sliding sunroof

WARNING

If you do not reset the sliding sunroof after a malfunction or voltage supply interruption, then the reversing function will malfunction or not work. The sliding sunroof closes with increased or maximum force. Parts of the body could be trapped in the closing area in the process. This poses an increased risk of injury or even fatal injury.

In such or similar situations always make sure that no parts of the body are in the closing area. Always reset the sliding sunroof after a malfunction or voltage supply interruption.

Problem: the sunroof cannot be closed and you cannot see the cause. If the sliding sunroof is obstructed during closing and reopens again slightly:

- ▶ Immediately after it blocks, pull the  switch down again to the point of resistance until the sliding sunroof is closed. The sliding sunroof is closed with increased force.

If the sliding sunroof is obstructed again during closing and reopens again slightly:

- ▶ Immediately after it blocks, pull the  switch down again to the point of resistance until the sliding sunroof is closed. The sliding sunroof is closed without the anti-entrapment feature.

Useful information	92
Correct driver's seat position	92
Seats	93
Steering wheel	98
Mirrors	98
Memory functions	101

Useful information

i This Owner's Manual describes all models, series and optional equipment for your vehicle that were available at the time of going to press. National variations are possible. Note that your vehicle may not be equipped with all of the functions described. This is also the case for systems and functions relevant to safety.

i Read the information on qualified specialist workshops: (▷ page 24).

Correct driver's seat position



Observe the safety guidelines on seat adjustment (▷ page 93).

► Make sure that seat ③ is correctly adjusted.

Manual seat adjustment (▷ page 94)

Electrical seat adjustment (▷ page 94)

When adjusting the seat, make sure that:

- you are as far away from the driver's air-bag as possible.
- you are sitting in a normal upright position.
- you can fasten the seat belt properly.

- you have moved the backrest to an almost vertical position.
- you have set the seat angle so that your thighs are gently supported.
- you can depress the pedals properly.

► Check whether the head restraint is adjusted properly (▷ page 94).

When doing so, make sure that you have adjusted the head restraint so that the back of your head is supported at eye level by the centre of the head restraint.

Observe the safety guidelines on steering wheel adjustment (▷ page 98).

► Make sure that steering wheel ① is adjusted correctly.

Adjusting the steering wheel (▷ page 98)

When adjusting the steering wheel, make sure that:

- you can hold the steering wheel with your arms slightly bent.
- you can move your legs freely.
- you can see all the displays in the instrument cluster clearly.

Observe the safety guidelines for seat belts (▷ page 46).

► Check whether you have fastened seat belt ② properly (▷ page 47).

The seat belt should:

- fit snugly across your body
 - be routed across the middle of your shoulder
 - be routed in your pelvic area across the hip joints
- Before starting off, adjust the rear-view mirror and the exterior mirrors (▷ page 99) so that you have a good view of road and traffic conditions.
- **Vehicles with a memory function:** save the seat and exterior mirror settings (▷ page 101).

Seats

Important safety notes

 **WARNING**

If children adjust the seats, they could become trapped, especially if they are unattended. There is a risk of injury.

When leaving the vehicle, always take the key with you and lock the vehicle. Never leave children unattended in the vehicle.

 **WARNING**

You could lose control of the vehicle while driving if you:

- adjust the driver's seat, steering wheel or mirrors
- fasten the seat belt

There is a risk of an accident.

Adjust the driver's seat, head restraint, steering wheel and mirrors and fasten your seat belt before starting the engine.

 **WARNING**

If you adjust the seat height carelessly, you or other vehicle occupants could be trapped and thereby injured. Children in particular could accidentally press the electrical seat adjustment buttons and become trapped. There is a risk of injury.

While moving the seats, make sure that your hands or other body parts do not get under the lever assembly of the seat adjustment system.

 **WARNING**

When adjusting a seat, you or another vehicle occupant could become trapped by the guide rail of the seat, for instance. There is a risk of injury.

Make sure that no one has any part of their body within the sweep of the seat when adjusting it.

 **WARNING**

The seat belt does not offer the intended level of protection if the backrest is not in the upright position. When braking or in the event of an accident, you could slide underneath the seat belt and sustain abdomen or neck injuries, for example. This poses an increased risk of injury or even fatal injury.

Adjust the seat properly before beginning your journey. Always make sure that the seat is in the upright position.

 **WARNING**

The head restraints cannot provide the intended protection unless they are fitted and adjusted correctly. There is an increased risk of injury to the head and neck in the event of an accident or sudden braking, for example.

Always drive with the head restraints fitted. Ensure that the centre of the head restraints support the back of each vehicle occupant's head at eye level before driving off.

! To avoid damage to the seats and the seat heating, observe the following information:

- do not spill any liquids on the seats. If liquid is spilled on the seats, dry them as soon as possible.
- if the seat covers are damp or wet, do not switch on the seat heating. The seat heating should also not be used to dry the seats.
- clean the seat covers as recommended; see the "Interior care" section.
- do not transport heavy loads on the seats. Do not place sharp objects on the seat cushions, e.g. knives, nails or tools. The seats should only be occupied by passengers, if possible.
- when the seat heating is in operation, do not cover the seats with insulating materials, e.g. blankets, coats, bags, seat covers, child seats or booster seats.

! Make sure that there are no objects in the footwell or behind the seats when moving

the seat back. There is a risk that the seats and/or the objects could be damaged.

- i** The head restraints in the front and rear seats can be removed.⁷

For more information, contact a qualified specialist workshop.

- i** Further related subjects:

- Luggage compartment enlargement (folding down the rear seats) (▷ page 272)

Adjusting the seats manually

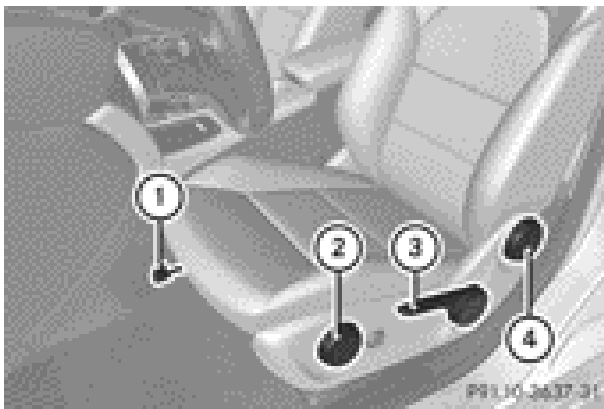

Seat fore-and-aft adjustment

- ▶ Lift handle ① and slide the seat forwards or rearwards.
- ▶ Release lever ① again. Make sure that you hear the seat engage in position.

Backrest angle

- ▶ Relieve the pressure on the backrest.
- ▶ Turn handwheel ④ forwards or backwards.

Seat height

- ▶ Pull handle ③ upwards or push it down repeatedly until the seat has reached the desired height.

⁷ Not on vehicles with sports seats.

⁸ Not available on vehicles with sports seats.

Seat cushion angle

Adjust the angle so that your thighs are lightly supported.

- ▶ Turn handwheel ② forwards or backwards.

Adjusting the seats electrically



- ① Head restraint height⁸
- ② Seat cushion angle
- ③ Seat height
- ④ Seat fore-and-aft adjustment
- ⑤ Backrest angle

- i** You can store the seat settings using the memory function (▷ page 101).

Adjusting the head restraints

⚠ WARNING

You could lose control of the vehicle while driving if you:

- adjust the driver's seat, steering wheel or mirrors
- fasten the seat belt

There is a risk of an accident.

Adjust the driver's seat, head restraint, steering wheel and mirrors and fasten your seat belt before starting the engine.

WARNING

The head restraints cannot provide the intended protection unless they are fitted and adjusted correctly. There is an increased risk of injury to the head and neck in the event of an accident or sudden braking, for example. Always drive with the head restraints fitted. Ensure that the centre of the head restraints support the back of each vehicle occupant's head at eye level before driving off.

General notes

For vehicles with sports seats, you cannot adjust the head restraints or remove and fit the rear head restraints.

Adjusting the head restraints manually

Adjusting the head restraint height

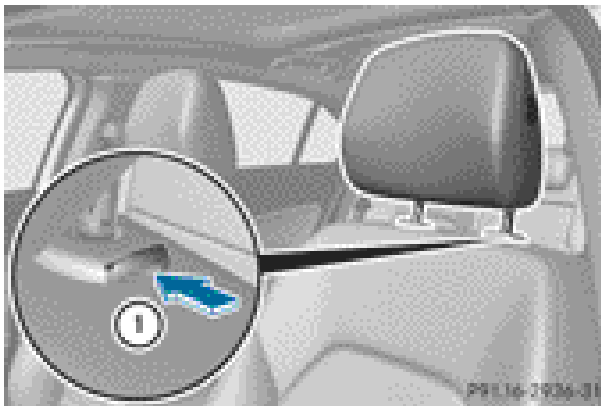

- ▶ **To raise:** pull the head restraint up to the desired position.
- ▶ **To lower:** press release catch ① in the direction of the arrow and push the head restraint down to the desired position.

Adjusting the head restraint fore-and-aft position

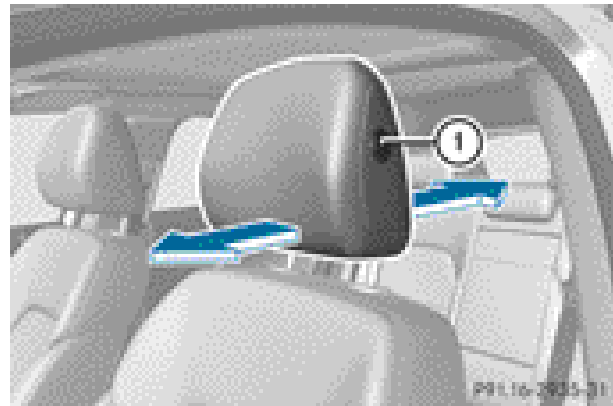

This function allows you to adjust the distance between the head restraint and the back of the head.

- ▶ **To move forwards:** pull the head restraint forwards in the direction of the arrow until it engages. There are a number of detents.
- ▶ **To move backwards:** press and hold release button ① and push the head restraint backwards.
- ▶ When the head restraint is in the desired position, release the button and make sure that the head restraint is engaged in position.

Adjusting the head restraints electrically

- ▶ **To adjust the head restraint height:** slide the switch for head restraint adjustment (▷ page 94) up or down in the direction of the arrow.

Rear seat head restraints

Adjusting the rear seat head restraint height

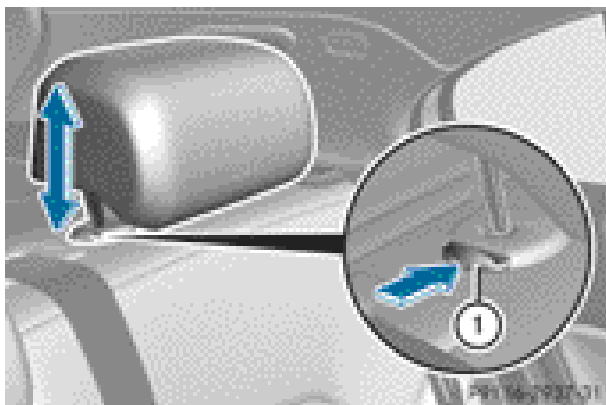

- ▶ **To raise:** pull the head restraint up to the desired position.
- ▶ **To lower:** press release catch ① and push the head restraint down until it is in the desired position.

Removing and fitting the rear seat head restraints

⚠ WARNING

The head restraints cannot provide the intended protection unless they are fitted and adjusted correctly. There is an increased risk of injury to the head and neck in the event of an accident or sudden braking, for example.

Always drive with the head restraints fitted. Ensure that the centre of the head restraints support the back of each vehicle occupant's head at eye level before driving off.

The rear head restraints on the outer seats can be removed and refitted.

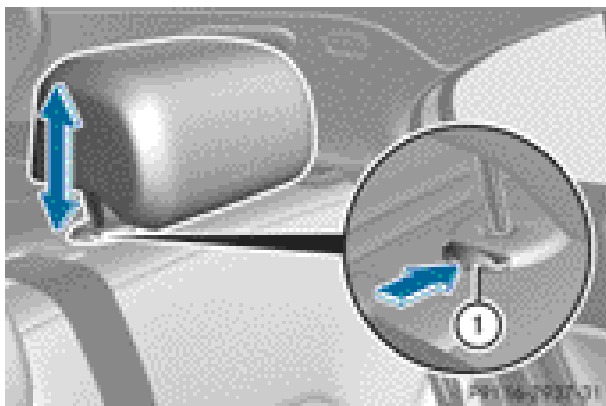

- ▶ Fold the seat backrest slightly forwards in order to remove the head restraint (▷ page 272).
- ▶ **To remove:** pull the head restraint up to the stop.
- ▶ Press release catch ① and pull the head restraint out of the guides.
- ▶ **To refit:** insert the head restraint so that the notches on the bar are on the left when viewed in the direction of travel.
- ▶ Push the head restraint down until you hear it engage in position.

Adjusting the 4-way lumbar support

You can adjust the contour of the front seat backrests individually to provide optimum support for your back.

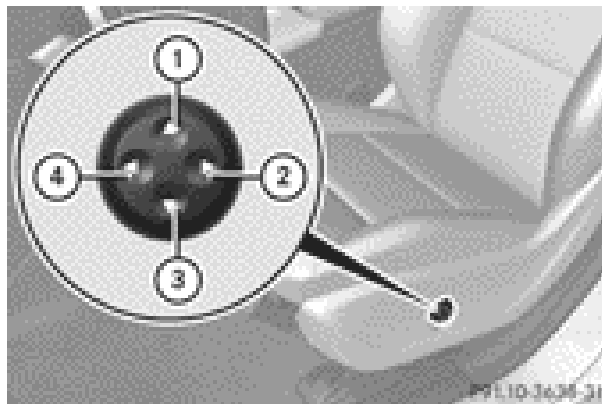

- ① To raise the backrest contour
- ② To soften the backrest contour
- ③ To lower the backrest contour
- ④ To harden the backrest contour

Switching the seat heating on/off

Switching on/off

⚠ WARNING

If you repeatedly switch on seat heating, the seat cushion and backrest padding may become very hot. The health of vehicle occupants with limited temperature sensitivity or a limited ability to react to excessively high temperatures may be affected or they may

even suffer burn-like injuries. There is a risk of injury.

Therefore, do not switch on the seat heating repeatedly.

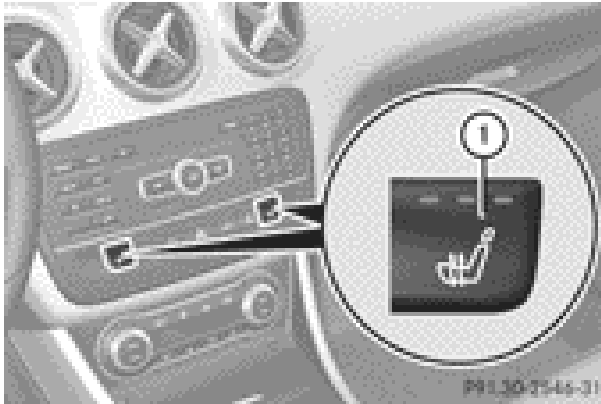

The three red indicator lamps in the button indicate the heating level you have selected. The system automatically switches down from level **3** to level **2** after approximately eight minutes.

The system automatically switches down from level **2** to level **1** after approximately ten minutes.

The system automatically switches off approximately 20 minutes after it is set to level **1**.

- ▶ Make sure that the key is in position **1** or **2** in the ignition lock.
- ▶ **To switch on:** press button ① repeatedly until the desired heating level is set.
- ▶ **To switch off:** press button ① repeatedly until all the indicator lamps go out.

i If the battery voltage is too low, the seat heating may switch off.

Problems with the seat heating

The seat heating has switched off prematurely or cannot be switched on. The vehicle's electrical system voltage is too low because too many electrical consumers are switched on.

- ▶ Switch off electrical consumers that you do not need, such as the rear window heating or interior lighting.

AMG Performance Seat

To adjust the contour of the seat and for improved lateral support, you can individually adjust the front seats.

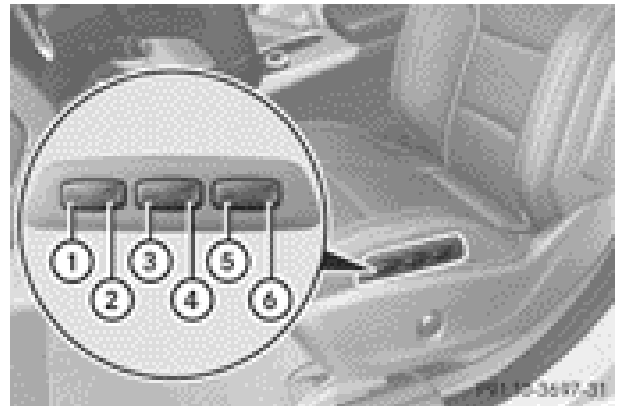

Adjusting the seat cushion length

- ▶ **To extend the seat cushion:** press button ①.
- ▶ **To retract the seat cushion:** press button ②.

Adjusting the side bolsters of the seat cushion

- ▶ **To set the side bolsters of the seat cushion narrower:** press button ③.
- ▶ **To set the side bolsters of the seat cushion wider:** press button ④.

Adjusting the seat backrest side bolsters

- ▶ To set the side bolsters of the seat backrest narrower: press button ⑤.
- ▶ To set the side bolsters of the seat backrest wider: press button ⑥.

Steering wheel

Important safety notes

⚠ WARNING

You could lose control of the vehicle while driving if you:

- adjust the driver's seat, steering wheel or mirrors
- fasten the seat belt

There is a risk of an accident.

Adjust the driver's seat, head restraint, steering wheel and mirrors and fasten your seat belt before starting the engine.

⚠ WARNING

Children could become trapped by the steering wheel if they adjust it. There is a risk of injury.

When leaving the vehicle, always take the key with you and lock the vehicle. Never leave children unattended in the vehicle.

Adjusting the steering wheel

⚠ WARNING

The steering wheel may move unexpectedly if you adjust it while driving. This could cause you to lose control of the vehicle. There is a risk of an accident.

Make sure that the steering wheel is locked before driving off. Never unlock the steering wheel when the vehicle is in motion.

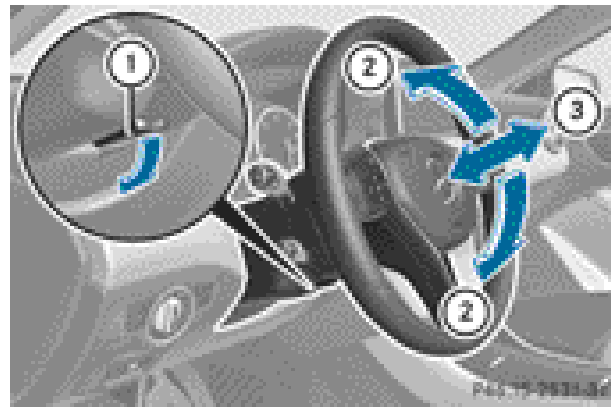

- ① Release lever
 - ② To adjust the steering wheel height
 - ③ To adjust the steering wheel position (fore-and-aft adjustment)
- ▶ Push release lever ① down completely. The steering column is unlocked.
 - ▶ Adjust the steering wheel to the desired position.
 - ▶ Push release lever ① up completely. The steering column is locked.
 - ▶ Check if the steering column is locked. When doing so, try to push the steering wheel up or down or try to move it in the fore-and-aft direction.

Mirrors

Rear-view mirror



- ▶ **Anti-dazzle mode:** pivot anti-dazzle switch ① forwards or back.

Exterior mirrors

Adjusting the exterior mirrors

WARNING

The exterior mirrors reduce the size of the image. Objects visible in the mirrors are closer than they appear. You could misjudge the distance from road users driving behind you when changing lanes, for instance. There is a risk of an accident.

You should therefore always look over your shoulder to determine the actual distance from road users driving behind you.

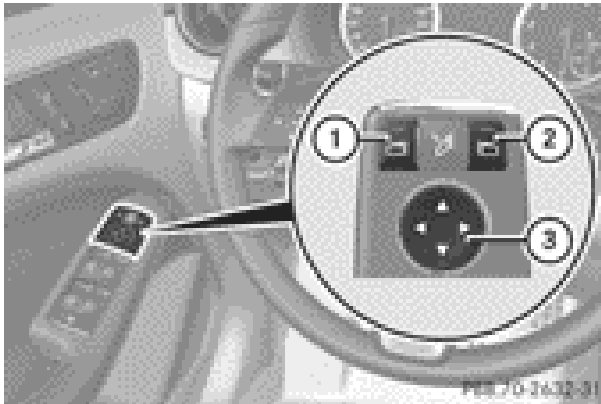

- ▶ Make sure that the key is in position **1** or **2** in the ignition lock.
- ▶ Press button **①** for the left-hand exterior mirror or button **②** for the right-hand exterior mirror.
The indicator lamp in the corresponding button lights up in red.
The indicator lamp goes out again after some time. You can adjust the selected mirror using adjustment button **③** as long as the indicator lamp is lit.
- ▶ Press adjustment button **③** up, down, or to the left or right until you have adjusted the exterior mirror to the correct position. You should have a good overview of traffic conditions.

The convex exterior mirrors provide a larger field of vision.

After the engine has been started, the exterior mirrors are automatically heated if the rear window heating is switched on and the

outside temperature is low. Heating takes a maximum of 10 minutes.

- i** The exterior mirrors can also be heated manually by switching on the rear window heating.

Folding the exterior mirrors in/out electrically

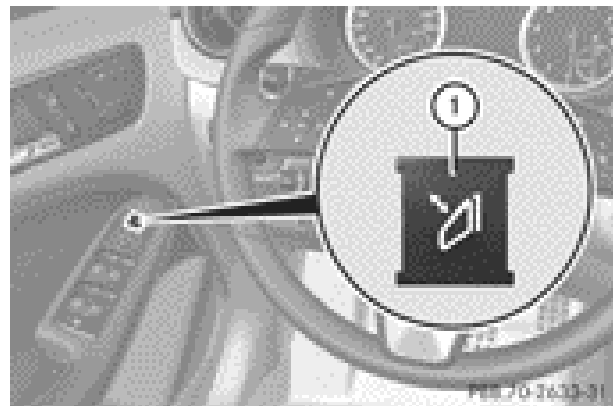

- ▶ Make sure that the key is in position **1** or **2** in the ignition lock.
- ▶ Briefly press button **①**.
Both exterior mirrors fold in or out.
- i** Make sure that the exterior mirrors are always folded out fully while driving. They could otherwise vibrate.
- i** If you are driving faster than 47 km/h (30 mph) you can no longer fold in the exterior mirrors.

Setting the exterior mirrors

If the battery has been disconnected or completely discharged, the exterior mirrors must be reset. The exterior mirrors will otherwise not fold in when you select the "Fold in mirrors when locking" function in the on-board computer (▷ page 225).

- ▶ Make sure that the key is in position **1** in the ignition lock.
- ▶ Briefly press button **①**.

Folding the exterior mirrors in/out automatically

If the "Fold in mirrors when locking" function is activated in the on-board computer (▷ page 225):

- the exterior mirrors fold in automatically as soon as you lock the vehicle from the outside.
- the exterior mirrors fold out again automatically as soon as you unlock the vehicle and then open the driver's or front-passenger door.

i If the exterior mirrors have been folded in manually, they do not fold out.

Exterior mirror pushed out of position

If an exterior mirror has been pushed out of position, proceed as follows.

- ▶ **Vehicles without electrically folding exterior mirrors:** move the exterior mirror into the correct position manually.
- ▶ **Vehicles with electrically folding exterior mirrors:** press and hold the mirror-folding button (▷ page 99) until you hear a click and then the mirror engage in position.

The mirror housing is engaged again and you can adjust the exterior mirrors as usual (▷ page 99).

Automatic anti-dazzle mirrors

The "Automatic anti-dazzle mirrors" function is only available if the vehicle is equipped with the "Mirror package".

The rear-view mirror and the exterior mirror on the driver's side automatically go into anti-dazzle mode if:

- the ignition is switched on and
- incident light from headlamps strikes the sensor in the rear-view mirror

The mirrors do not go into anti-dazzle mode if reverse gear is engaged or if the interior lighting is switched on.

Parking position of the exterior mirror on the front-passenger side

General notes

The "Parking position for the exterior mirror on the front-passenger side" function is only available if the vehicle is equipped with the "Memory package".

Setting and storing the parking position

Using reverse gear

You can set the front-passenger side exterior mirror so that you can see the rear wheel on that side as soon as you engage reverse gear. You can store this position.

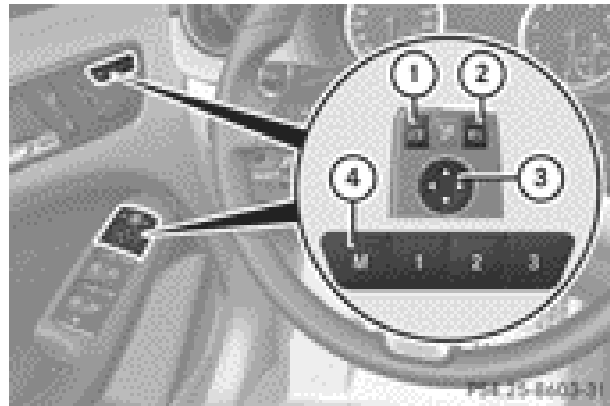

- ▶ Make sure that the vehicle is stationary and that the key is in position **2** in the ignition lock.
- ▶ Press button **2** for the exterior mirror on the front-passenger side.
- ▶ Engage reverse gear. The exterior mirror on the front-passenger side moves to the preset parking position.
- ▶ Use adjustment button **3** to adjust the exterior mirror. You should see the rear wheel and the kerb in the exterior mirror. The parking position is stored.

i If you shift the transmission to another position, the exterior mirror on the front-passenger side returns to the driving position.

Using the memory button

You can set the front-passenger side exterior mirror so that you can see the rear wheel on that side as soon as you engage reverse gear. You can store this position. This setting can be stored using memory button **M** ④.

- ▶ Make sure that the vehicle is stationary and that the key is in position **2** in the ignition lock.
- ▶ Press button ② for the exterior mirror on the front-passenger side.
- ▶ Use adjustment button ③ to adjust the exterior mirror. You should see the rear wheel and the kerb in the exterior mirror.
- ▶ Press memory button **M** ④ and one of the arrows on adjustment button ③ within three seconds.
The parking position is stored if the exterior mirror does not move.
- ▶ If the mirror moves out of position, repeat the steps.

Calling up a stored parking position setting

- ▶ Turn the key to position **2** in the ignition lock.
- ▶ Adjust the exterior mirror on the front-passenger side with the corresponding button (▷ page 99).
- ▶ Engage reverse gear.
The exterior mirror on the front-passenger side moves to the stored parking position.

The exterior mirror on the front-passenger side moves back to its original position:

- as soon as you exceed a speed of 15 km/h
- about ten seconds after you have disengaged reverse gear
- if you press button ① for the exterior mirror on the driver's side

Memory functions

Storing settings

WARNING

If you use the memory function on the driver's side while driving, the adjustments could cause you to lose control of the vehicle. There is a risk of an accident.

Only use the memory function on the driver's side while the vehicle is stationary.

WARNING

If the memory function adjusts the seat, you and other vehicle occupants – particularly children – could become trapped. There is a risk of injury.

While the memory function is making adjustments, make sure that no one has any part of their body within the sweep of the seat. If someone becomes trapped, immediately release the memory function position button. The adjustment is stopped.

WARNING

If children activate the memory function, they could become trapped, especially if they are unattended. There is a risk of injury.

When leaving the vehicle, always take the key with you and lock the vehicle. Never leave children unattended in the vehicle.

With the memory function, you can store up to three different settings, e.g. for three different people.

The following settings are stored as a single memory preset:

- position of the seat, backrest and head restraint
- driver's side: position of the exterior mirrors on the driver's and front-passenger sides

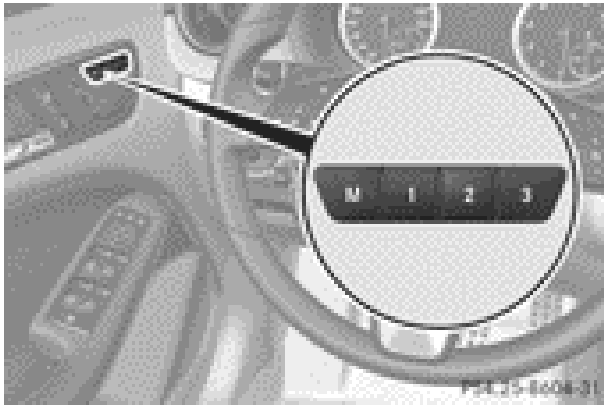

- ▶ Adjust the seat (▷ page 94).
- ▶ Adjust the exterior mirror on the driver's side (▷ page 99).
- ▶ Briefly press the **M** memory button and then press storage position button **1**, **2** or **3** within three seconds.
The settings are stored in the selected pre-set position. A tone sounds when the settings have been completed.

Calling up a stored setting

- ▶ Press and hold the relevant storage position button **1**, **2** or **3** until the seat and exterior mirrors are in the stored position.
- i** The setting procedure is interrupted as soon as you release the storage position button.

Useful information	104
Exterior lighting	104
Interior lighting	111
Replacing bulbs	112
Windscreen wipers	117

Useful information

- i** This Owner's Manual describes all models, series and optional equipment for your vehicle that were available at the time of going to press. National variations are possible. Note that your vehicle may not be equipped with all of the functions described. This is also the case for systems and functions relevant to safety.
- i** Read the information on qualified specialist workshops: (▷ page 24).

Exterior lighting

General notes

For reasons of safety, Mercedes-Benz recommends that you drive with the lights switched on even during the daytime. In some countries, operation of the headlamps varies due to legal requirements and self-imposed obligations.

Driving abroad

General notes

If your journey takes you to countries where vehicles are driven on the opposite side of the road to the country in which the vehicle is registered, your headlamps must be switched to symmetrical dipped beam as soon as possible after crossing the border. This prevents oncoming traffic from being dazzled. Symmetrical lights do not illuminate as large an area of the edge of the carriageway.

Vehicles with halogen headlamps

- ▶ Affix special masking sheets on the headlamps.
- i** You can obtain these special stickers from a qualified specialist workshop.
- !** Mercedes-Benz recommends that you only use genuine Mercedes-Benz masking

tape. Your headlamps could otherwise be damaged.

Remove the masking tape when you are once again driving on the same side of the road as in the country in which your vehicle is registered.

Vehicles with bi-xenon headlamps

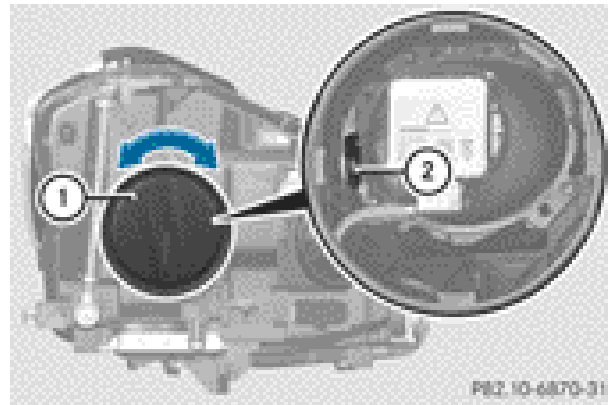

- ▶ Turn protective cap ① anti-clockwise and remove it.
- ▶ Push swivel lever ② down.
- ▶ Insert protective cap ① and turn it clockwise.

Convert the headlamps back to asymmetrical dipped beam as soon as possible after returning across the border.

Vehicles with Intelligent Light System

- ▶ Before crossing the border, set the headlamps to symmetrical dipped beam and after returning back to asymmetrical dipped beam via the "Dipped-beam headlamps for driving on the right/left" function in the on-board computer (▷ page 221).

If the headlamps are converted to symmetrical dipped beam, the "motorway mode" and "extended range foglamps" functions are not available.

Setting the exterior lighting

Setting options

Exterior lighting can be set using the:

- light switch
- headlamp range control (vehicles with halogen headlamps only) (▷ page 107)
- combination switch (▷ page 107)
- on-board computer (▷ page 221)

Light switch

Operation

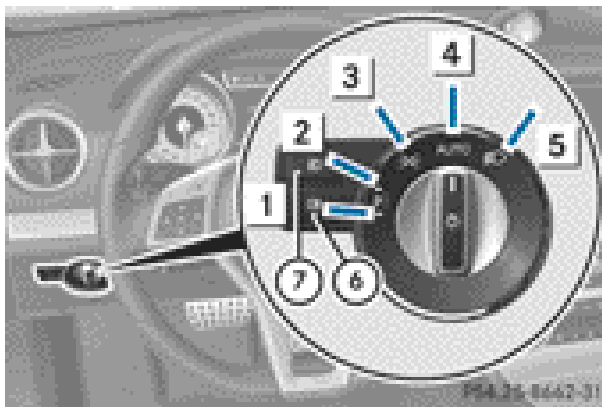

- 1 Left-hand parking lamps
- 2 Right-hand parking lamps
- 3 Side lamps, licence plate and instrument cluster lighting
- 4 **AUTO** Automatic headlamp mode, controlled by the light sensor
- 5 Dipped-beam/main-beam headlamps
- 6 Rear foglamp
- 7 Foglamp (vehicles with front foglamps only)

If you hear a warning tone when you leave the vehicle, the lights may still be switched on.

► Turn the light switch to **AUTO**.

The exterior lighting (except the side lamps/parking lamps) switches off automatically if you:

- remove the key from the ignition lock
- open the driver's door with the key in position **0**.

Automatic headlamp mode

WARNING

When the light switch is set to **AUTO**, the dipped-beam headlamps may not be switched on automatically if there is fog, snow or other causes of poor visibility due to the weather conditions such as spray. There is a risk of an accident.

In such situations, turn the light switch to .

The automatic headlamp feature is only an aid. The driver is responsible for the vehicle's lighting at all times.

AUTO is the preferred light switch setting. The light setting is automatically selected according to the brightness of the ambient light (exception: poor visibility due to weather conditions such as fog, snow or spray):

- Key in position **1** in the ignition lock: the side lamps are switched on or off automatically depending on the brightness of the ambient light.
- With the engine running: if you have switched on the daytime driving lights function in the on-board computer, the daytime driving lights or the side lamps and dipped-beam headlamps are switched on or off automatically depending on the brightness of the ambient light.

► **To switch on automatic headlamp mode:** turn the light switch to **AUTO**.



The daytime driving lights improve the detectability of your vehicle during the day. Here, the daytime driving lights function must be switched on via the on-board computer (▷ page 221).

When the dipped-beam headlamps are switched on, the indicator lamp in the instrument cluster lights up and the daytime driving lights switch off.

Dipped-beam headlamps





When the ignition is switched on and the light switch is in position , the side lamps and dipped-beam headlamps are switched on

even if the light sensor does not sense dark ambient light conditions. This is advantageous when there is fog or rain.

- ▶ **To switch on the dipped-beam headlamps:** turn the key in the ignition lock to position **2** or start the engine.
- ▶ Turn the light switch to . The green  indicator lamp in the instrument cluster lights up.

Foglamps

In conditions where visibility is poor due to fog, snow or rain, the foglamps improve visibility as well as making it easier for other road users to see you. They can be operated together with the side lamps or together with the side lamps and dipped-beam headlamps.





- ▶ **To switch on the foglamps:** turn the key in the ignition lock to position **2** or start the engine.
- ▶ Turn the light switch to  or **AUTO**.
- ▶ Press the  button. The green  indicator lamp in the instrument cluster lights up.
- ▶ **To switch off the front foglamps:** press the  button. The green  indicator lamp in the instrument cluster goes out.

Only vehicles with front foglamps are equipped with the "Foglamp" function; for how to operate the foglamps on vehicles with the Intelligent Light System (▷ page 109).

Rear foglamp



The rear foglamp improves the visibility of your vehicle in heavy fog for the following traffic. Please observe the country-specific laws on the use of rear foglamps.

- ▶ **To switch on the rear foglamp:** turn the key in the ignition lock to position **2** or start the engine.
- ▶ Turn the light switch to  or **AUTO**.

- ▶ Press the  button. The yellow  indicator lamp in the instrument cluster lights up.
- ▶ **To switch off the rear foglamp:** press the  button. The yellow  indicator lamp in the instrument cluster goes out.

- i** Vehicles with bi-xenon headlamps or the Intelligent Light System: when the rear foglamp is switched on, the lower 15 LEDs of the brake lamp in the tail lamp switch off due to a legal requirement: for right-hand traffic only in the left-hand tail lamp and for left-hand traffic only in the right-hand tail lamp.



Side lamps

- !** If the battery has been excessively discharged, the side lamps or parking lamps are automatically switched off to enable the next engine start. Always park your vehicle safely and sufficiently lit according to legal standards. Avoid the continuous use of the  side lamps for several hours. If possible, switch on the  right or the  left parking lamp.

- ▶ **To switch on:** turn the light switch to . Depending on the equipment level, the green indicator lamp or the scale illumination in the instrument cluster light up.

Parking lamps

Switching on the parking lamps ensures the corresponding side of the vehicle is illuminated.

- ▶ **To switch on the parking lamps:** the key is not in the ignition lock or it is in position **0**.
- ▶ Turn the light switch to  (left-hand side of the vehicle) or  (right-hand side of the vehicle).

Adjusting the headlamp range (halogen headlamps)

The headlamp range control allows you to adjust the cone of light from the headlamps to suit the vehicle load.

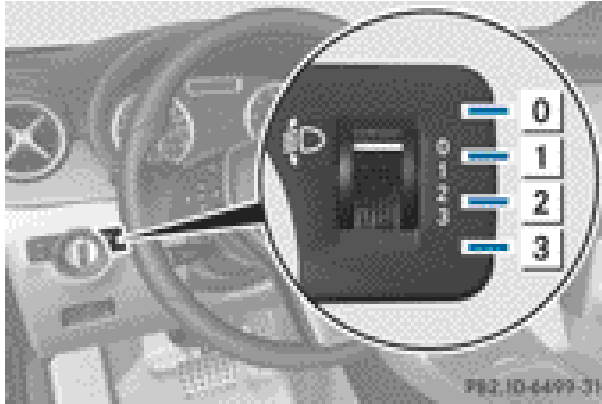

Headlamp range control

- 0 Driver's seat and front-passenger seat occupied
 - 1 Driver's seat, front-passenger seat and rear seats occupied
 - 2 Driver's seat, front-passenger seat and rear seats occupied, luggage compartment laden
 - 3 Driver's and front-passenger seats occupied and maximum permissible rear axle load utilised, e.g. when towing a trailer
- ▶ Start the engine.
 - ▶ Turn the headlamp range control to the position which corresponds to the load in your vehicle.

Combination switch

Turn signals

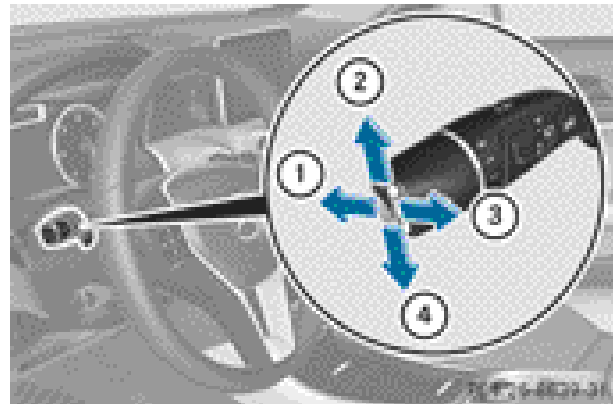

- 1 Main-beam headlamps
- 2 Turn signal, right
- 3 Headlamp flasher
- 4 Turn signal, left

- ▶ **To indicate briefly:** press the combination switch briefly to the pressure point in the direction of arrow 2 or 4. The corresponding turn signal flashes three times.
- ▶ **To indicate:** press the combination switch beyond the pressure point in the direction of arrow 2 or 4.

Main-beam headlamps

- ▶ **To switch on the main-beam headlamps:** turn the key in the ignition lock to position 2 or start the engine.
- ▶ Turn the light switch to  or **AUTO**.
- ▶ Press the combination switch beyond the pressure point in the direction of arrow 1. In the **AUTO** position, the main-beam headlamps are only switched on when it is dark and the engine is running.

The blue  indicator lamp in the instrument cluster lights up when the main-beam headlamps are switched on.

- ▶ **To switch off the main-beam headlamps:** move the combination switch back to its normal position.

The blue  indicator lamp in the instrument cluster goes out.

- i** Vehicles with Adaptive Highbeam Assist: when Adaptive Highbeam Assist is active, it controls activation of the main-beam headlamps (▷ page 110).

Headlamp flasher

- ▶ **To switch on:** turn the key in the ignition lock to position **1** or **2**, or start the engine.
- ▶ Pull the combination switch in the direction of arrow .

Hazard warning lamps



The hazard warning lamps switch on automatically if:

- an airbag is deployed or
 - the vehicle decelerates rapidly from a speed of more than 70 km/h and comes to a standstill
- ▶ **To switch on the hazard warning lamps:** press button .
- All turn signals flash. If you now switch on a turn signal using the combination switch,

only the turn signal lamp on the corresponding side of the vehicle will flash.

- ▶ **To switch off the hazard warning lamps:** press button .

The hazard warning lamps switch off automatically if the vehicle reaches a speed of over 10 km/h again after a full brake application.

- i** The hazard warning lamps still operate if the ignition is switched off.

Headlamp cleaning system

If the "Wipe with washer fluid" function is operated five times (▷ page 117) while the lights are on and the engine is running, the headlamps are cleaned automatically. When you switch off the ignition, the automatic headlamp cleaning system is reset and counting is resumed from 0.

Intelligent Light System

General notes

The Intelligent Light System is a system that adjusts the headlamps automatically to suit the prevailing driving and weather conditions. It offers advanced functions for improved illumination of the road surface, e.g. depending on the vehicle speed or weather conditions. The system includes the active light function, cornering light function, motorway mode and extended range foglamps. The system is only active when it is dark.

You can activate or deactivate the "Intelligent Light System" using the on-board computer (▷ page 221).

Active light function

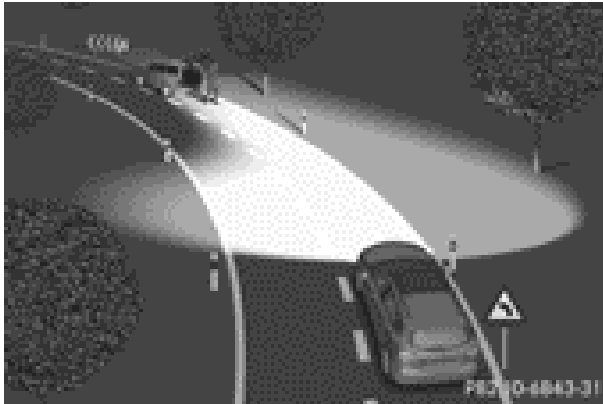

The active light function is a system that moves the headlamps according to the steering movements of the front wheels. In this way, relevant areas remain illuminated while driving. This allows you to recognise pedestrians, cyclists and animals.

Active: when the lights are switched on.

Cornering light function



The cornering light function improves the illumination of the road over a wide angle in the direction you are turning, enabling better visibility in tight bends, for example. The cornering light function can only be activated when the dipped-beam headlamps are switched on.

Active:

- if you are driving at speeds below 40 km/h and the turn signal is activated or the steering wheel is turned.
- if you are driving at speeds between 40 km/h and 70 km/h and turn the steering wheel.

Not active: if you are driving at speeds above 40 km/h or switch off the turn signal or turn the steering wheel to the straight-ahead position.

The cornering lamp may remain lit for a short time, but is automatically switched off after no more than three minutes.

Motorway mode



Motorway mode increases the range of the beam.

Active:

- if you are driving at speeds above 110 km/h and do not make any large steering movements for 1000 m
- if you are driving at speeds above 130 km/h

Not active: if you are driving at speeds below 80 km/h following activation.

Extended range foglamps



The extended range foglamps reduce the glare experienced by the driver and improve

the illumination of the edge of the carriage-way.

Active: if you are driving at speeds below 70 km/h and you switch on the rear foglamp.

Not active: if you are driving at speeds above 100 km/h or if you switch off the rear foglamp following activation.

Adaptive Highbeam Assist

WARNING

Adaptive Highbeam Assist does not recognise road users:

- who have no lights, e.g. pedestrians
- who have poor lighting, e.g. cyclists
- whose lighting is blocked, e.g. by a barrier

In very rare cases, Adaptive Highbeam Assist recognises road users too late or not at all. In this, or in similar situations, the automatic main-beam headlamps will not be deactivated or activated regardless. There is a risk of an accident.

Always carefully observe the traffic conditions and switch off the main-beam headlamps in good time.

You can use this function to set the headlamps to change between dipped beam and main beam automatically. The system recognises vehicles with their lights on, either approaching from the opposite direction or travelling in front of your vehicle, and consequently switches the headlamps from main beam to dipped beam.

The system automatically adapts the dipped-beam headlamp range depending on the distance to the other vehicle. Once the system no longer detects any other vehicles, it reactivates the main-beam headlamps.

The system's optical sensor is located behind the windscreen near the overhead control panel.

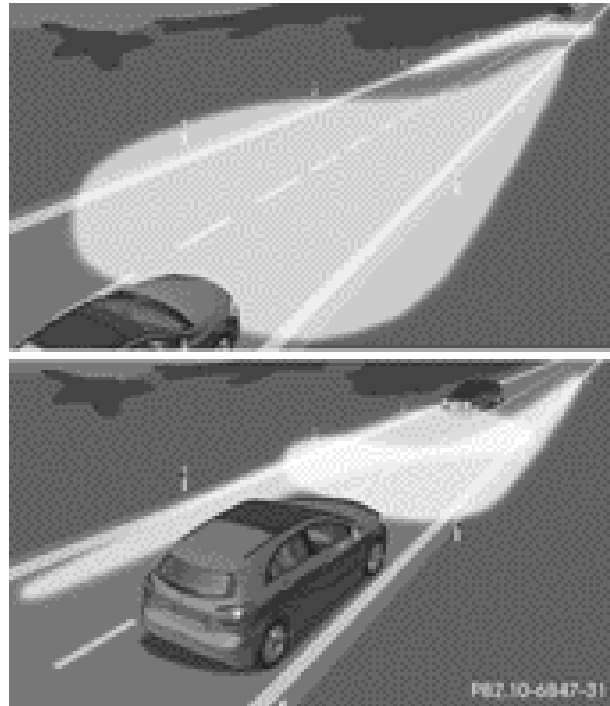

► **To activate:** activate the Adaptive Highbeam Assist function using the on-board computer (▷ page 222).

► Turn the light switch to **AUTO**.

► Press the combination switch beyond the pressure point in the direction of arrow ① (▷ page 107).

The  indicator lamp in the multifunction display lights up when it is dark and the light sensor activates the dipped-beam headlamps.

If you are driving at speeds above 45 km/h:

The headlamp range is set automatically depending on the distance between the vehicle and other road users.

If you are driving at speeds above 55 km/h and no other road users are recognised:

The main-beam headlamps are switched on automatically. The  indicator lamp in the instrument cluster also lights up.

If you are driving at speeds below 45 km/h or other road users are recognised or the roads are adequately lit:

The main-beam headlamps are switched off automatically. The  indicator lamp in

the instrument cluster goes out. The  indicator lamp in the multifunction display remains lit.

- **To deactivate:** move the combination switch back to its normal position. The  indicator lamp in the multifunction display goes out.

Headlamps misted up on the inside

The headlamps may mist up on the inside if there is high atmospheric humidity.

- Switch on the lights and drive off. The level of moisture diminishes, depending on the length of the journey and the weather conditions (humidity and temperature).

If the level of moisture does not diminish:



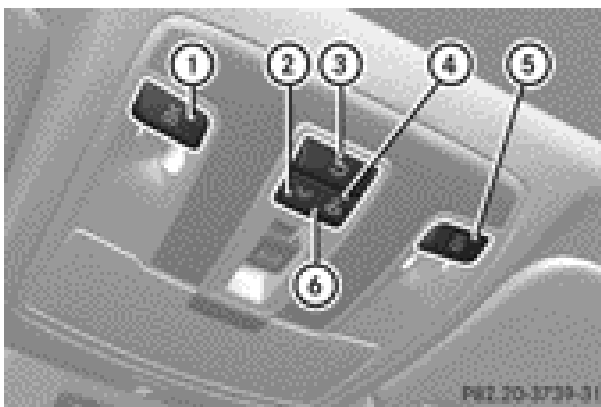

- Have the headlamps checked at a qualified specialist workshop.

Interior lighting

Overview of interior lighting





Front overhead control panel

-  To switch the left-hand front reading lamp on/off
-  To switch the front interior lighting on
-  To switch the rear interior lighting on/off
-  To switch the front interior lighting/automatic interior lighting control off

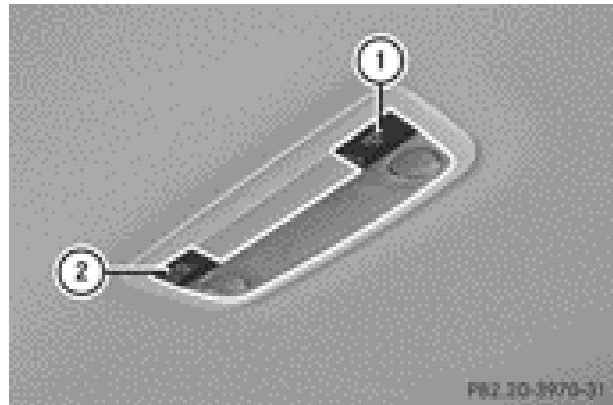
-  To switch the right-hand front reading lamp on/off
- To switch the automatic interior lighting control on



Rear-compartment overhead control panel

-  To switch the left-hand reading lamp on/off
-  To switch the right-hand reading lamp on/off



Interior lighting control

Important notes

In order to prevent the vehicle's battery from discharging, the interior lighting functions are automatically deactivated after some time except for when the key is in position **2** in the ignition lock.

The brightness of the ambient lighting may be set using the on-board computer (► page 222).

Automatic interior lighting control





- **To switch on:** set the switch to centre position .
- **To switch off:** set the switch to the  position.

The interior lighting automatically switches on if you:

- unlock the vehicle
- open a door
- remove the key from the ignition lock

The interior lighting is activated for a short time when the key is removed from the ignition lock. You can activate this delayed switch-off using the on-board computer (▷ page 223).

Manual interior lighting control

- ▶ **To switch the front interior lighting on:** set the switch to the  position.
- ▶ **To switch off the interior lighting:** set the switch to the  position or (if the door is closed) to the centre position.
- ▶ **To switch the rear interior lighting on/off:** press the  button.
- ▶ **To switch the reading lamps on/off:** press the  button.

Crash-responsive emergency lighting

The interior lighting is activated automatically if the vehicle is involved in an accident.

- ▶ **To switch off the crash-responsive emergency lighting:** press the hazard warning lamp button.

or

- ▶ Lock and then unlock the vehicle using the key.

Replacing bulbs

Important safety notes

Xenon bulbs

DANGER

Xenon bulbs are under high voltage. You can get an electric shock if you remove the cover of the xenon bulb and touch the electrical contacts. There is a risk of fatal injury.

Never touch the parts or the electrical contacts of the xenon bulb. Always have work on the xenon bulbs carried out at a qualified specialist workshop.

If your vehicle is equipped with xenon bulbs, you can recognise this by the following: the cone of light from the xenon bulbs moves from the top to the bottom and back again when you start the engine. For this to be observed, the lights must be switched on before starting the engine.

Bulbs and lamps are an important aspect of vehicle safety. You must therefore make sure that these function correctly at all times. Have the headlamp setting checked regularly.

Other bulbs

WARNING

Bulbs, lamps and plug connectors can become very hot during use. When replacing a bulb, you could burn yourself on these components. There is a risk of injury.

Allow these components to cool down before replacing the bulb.

There are bulbs other than the xenon bulbs that you cannot replace. Replace only the bulbs listed (▷ page 113). Have the bulbs that you cannot replace yourself replaced at a qualified specialist workshop.

If you require assistance replacing bulbs, consult a qualified specialist workshop.

Do not touch the glass tube of new bulbs with your bare hands. Even minor contamination can burn into the glass surface and reduce the service life of the bulbs. Always use a lint-free cloth or only touch the base of the bulb when fitting.

Only use bulbs of the correct type.

If the new bulb still does not light up, consult a qualified specialist workshop.

Bulbs and lamps are an important aspect of vehicle safety. You must therefore make sure that these function correctly at all times. Have the headlamp setting checked regularly.

Overview of bulb replacement – bulbs

You can replace the following bulbs. The details for the bulb type can be found in the legend.

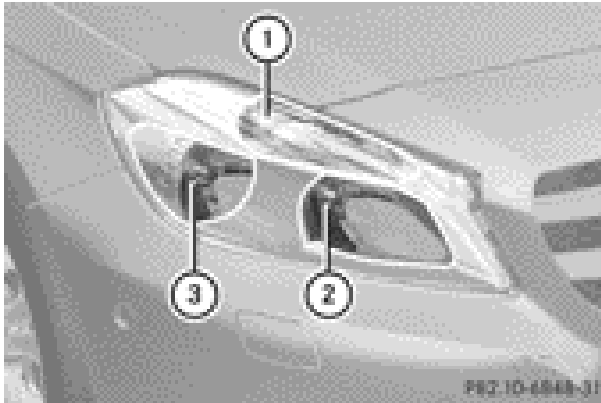

Halogen headlamps

- ① Turn signal lamp: PY 21 W
- ② Main-beam headlamp/side lamp/parking lamp: H15 55 W/15 W
- ③ Dipped-beam headlamp: H7 55 W



Vehicles with Intelligent Light System

- ① Cornering lamp: H7 55 W

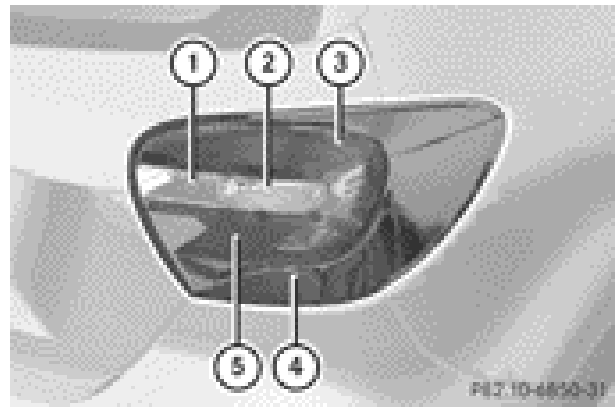

Tail lamp (halogen headlamps)

- ① Reversing lamp: W 16 W
- ② Turn signal lamp: PY 21 W
- ③ Tail lamp/brake lamp: W 16 W
- ④ Rear foglamp: W 16 W
- ⑤ Tail lamp: W 16 W

Replacing the front bulbs

Fitting/removing the cover on the front wheel arch

You must remove the cover from the front wheel housing before you can change the front bulbs.

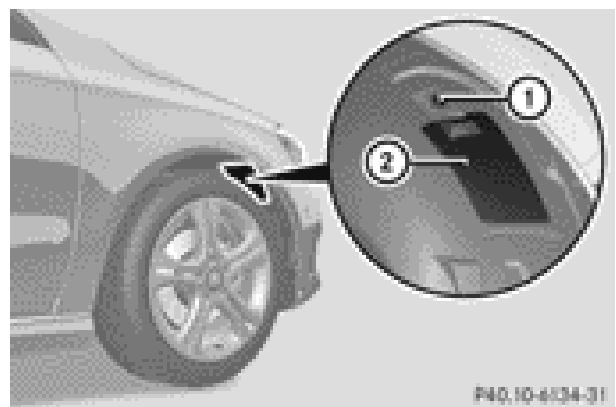

- ▶ **To remove:** switch off the lights.
- ▶ Turn the front wheels inwards.
- ▶ Turn rotary knob ① through 90°. Cover ② is released.
- ▶ Push cover ② down.
- ▶ **To fit:** push cover ② up.
- ▶ Turn rotary knob ① through 90°. Cover ② is locked.

Dipped-beam headlamps (halogen headlamps)

WARNING

These bulbs are pressurised.

They can explode when being changed if:

- they are still hot
- they hit an object when being removed
- they are dropped

There is a risk of injury.

You should wear eye protection and clean gloves when you are changing a bulb. If necessary, have bulbs changed at a qualified specialist workshop.

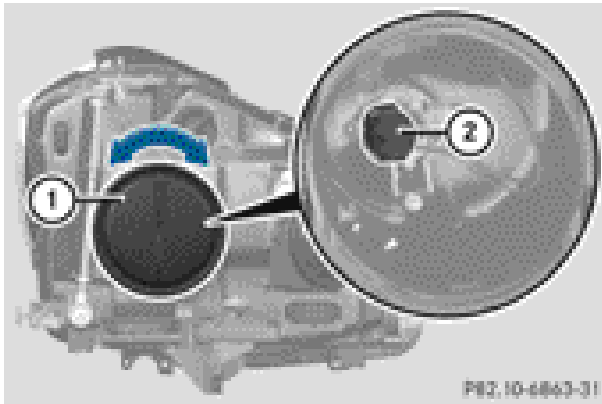

- ▶ Remove the cover in the front wheel arch (▷ page 113).
- ▶ Turn housing cover ① anti-clockwise and pull it out.
- ▶ Turn bulb holder ② anti-clockwise and pull it out.
- ▶ Take the bulb out of bulb holder ②.
- ▶ Insert the new bulb into bulb holder ②.
- ▶ Insert bulb holder ② into the lamp and turn it clockwise.
- ▶ Align housing cover ① and turn it clockwise until it engages.
- ▶ Replace the cover in the front wheel arch (▷ page 113).

Main-beam headlamps and side lamps/parking lamps (vehicles with halogen headlamps)

WARNING

These bulbs are pressurised.

They can explode when being changed if:

- they are still hot
- they hit an object when being removed
- they are dropped

There is a risk of injury.

You should wear eye protection and clean gloves when you are changing a bulb. If necessary, have bulbs changed at a qualified specialist workshop.

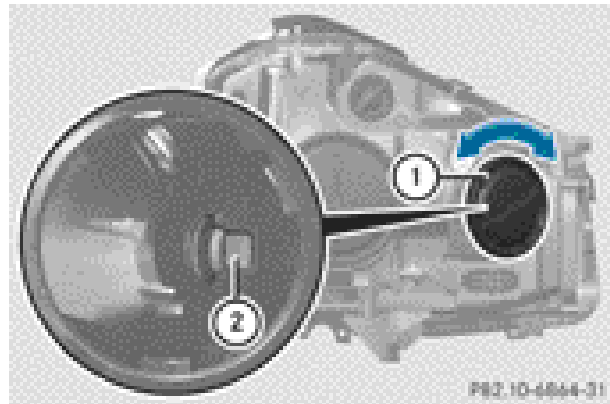

- ▶ Switch off the lights.
- ▶ Open the bonnet.
- ▶ Turn housing cover ① anti-clockwise and pull it out.
- ▶ Turn bulb ② anti-clockwise and pull it out.
- ▶ Insert the new bulb and engage it to the stop.
- ▶ Align housing cover ① and turn it clockwise until it engages.

Turn signal lamp (halogen headlamps)

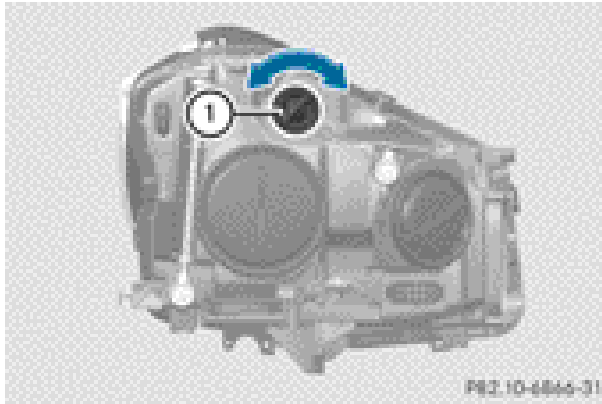

- ▶ Switch off the lights.
- ▶ Open the bonnet.
- ▶ Turn bulb holder ① anti-clockwise and pull it out.
- ▶ Take the bulb out of bulb holder ①.
- ▶ Insert the new bulb into bulb holder ①.
- ▶ Insert bulb holder ① and turn it clockwise until it engages.

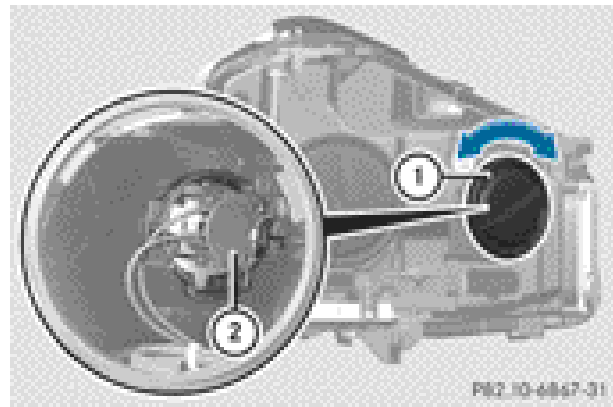

- ▶ Switch off the lights.
- ▶ Open the bonnet.
- ▶ Turn housing cover ① anti-clockwise and pull it out.
- ▶ Turn bulb holder ② anti-clockwise and pull it out.
- ▶ Take the bulb out of bulb holder ②.
- ▶ Insert the new bulb into bulb holder ②.
- ▶ Insert bulb holder ② into the lamp and turn it clockwise.
- ▶ Align housing cover ① and turn it clockwise until it engages.

Cornering lamps (Intelligent Light System)

⚠ WARNING

These bulbs are pressurised. They can explode when being changed if:

- they are still hot
- they hit an object when being removed
- they are dropped

There is a risk of injury.

You should wear eye protection and clean gloves when you are changing a bulb. If necessary, have bulbs changed at a qualified specialist workshop.

Replacing the rear bulbs

Opening and closing the side trim panels

You must open the side trim panel in the luggage compartment before you can replace the bulbs in the tail lamps.

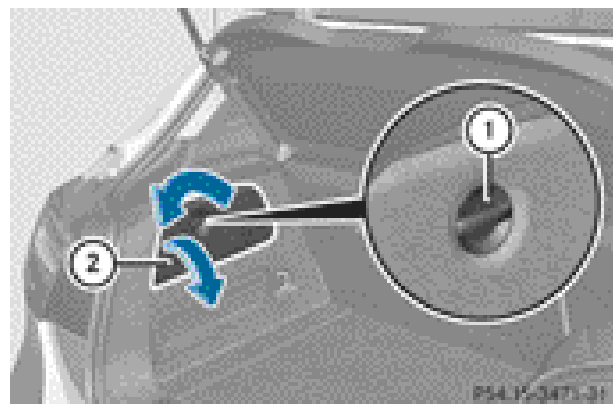

Left-hand side trim panel

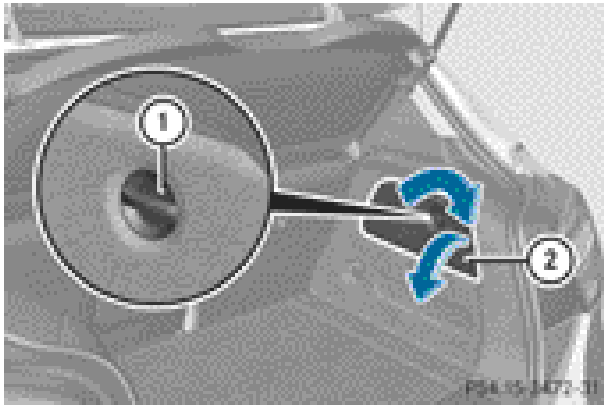

Right-hand side trim panel

- ▶ **To open:** turn release knob ① 90° in the direction of the arrow and remove side trim panel ②.
- ▶ **To close:** insert side trim panel ② and turn release knob ① 90° in the opposite direction to the arrow.

Tail lamps

- ▶ Switch off the lights.
- ▶ Open the luggage compartment.
- ▶ Open the side trim panel (▷ page 115).

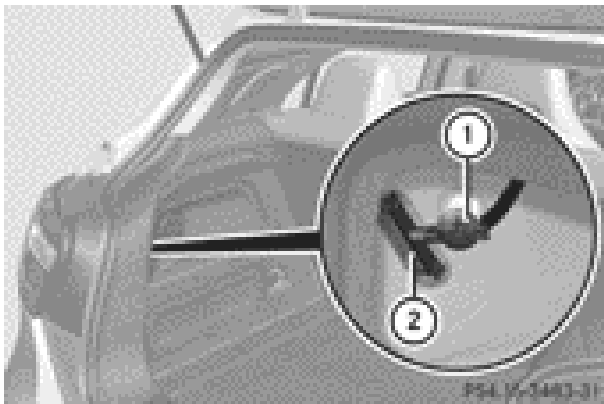

- ▶ Release and remove connector ②.
- ▶ Unscrew wing nut ① and remove the lamp cluster.

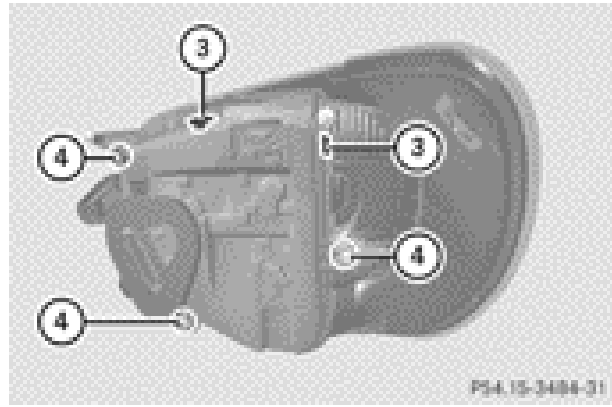

Lamp cluster

- ▶ Remove plastic nut ④ using a suitable item, e.g. a coin.
- ▶ Release attachments ③.
- ▶ Remove the bulb holder from the lamp cluster.

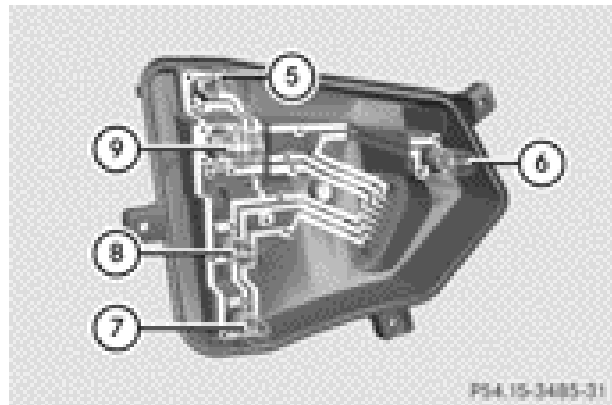

Bulb holder

- ⑤ Tail lamp/brake lamp
- ⑥ Reversing lamp
- ⑦ Rear foglamp
- ⑧ Tail lamp
- ⑨ Turn signals

- ▶ **Tail lamp/brake lamp/rear foglamp/reversing lamp:** remove the corresponding bulb from the bulb holder.
- ▶ Insert the new bulb into the bulb holder.
- ▶ **Turn signal lamp:** lightly press the bulb into the bulb holder, turn it anti-clockwise and remove it from the bulb holder.

- ▶ Insert the new bulb into the bulb holder and turn it clockwise.
- ▶ Secure the bulb holder to attachments ③ on the lamp cluster and tighten plastic nuts ④.

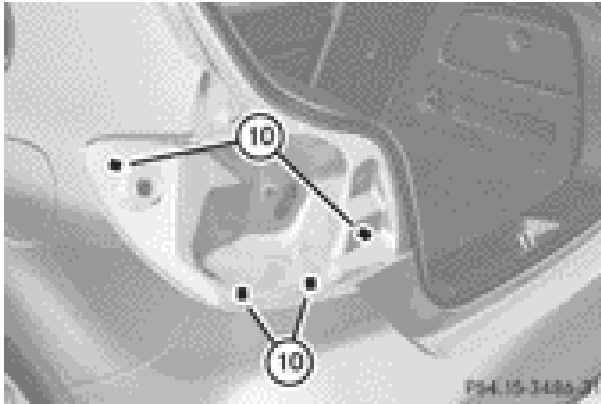

- ▶ Insert the lamp cluster into the vehicle and make sure that it sits correctly in guides ⑩.
- ▶ Tighten wing nut ② and re-establish contact with connector ①.
- ▶ Close the side trim panel (▷ page 115).

Windscreen wipers

Switching the windscreen wipers on/off

! Do not operate the windscreen wipers when the windscreen is dry, as this could damage the wiper blades. Moreover, dust that has collected on the windscreen can scratch the glass if wiping takes place when the windscreen is dry.

If it is necessary to switch on the windscreen wipers in dry weather conditions, always operate them using washer fluid.

! If the windscreen wipers leave smears on the windscreen after the vehicle has been washed in an automatic car wash, this may be due to wax or other residue. Clean the windscreen with washer fluid after an automatic car wash.

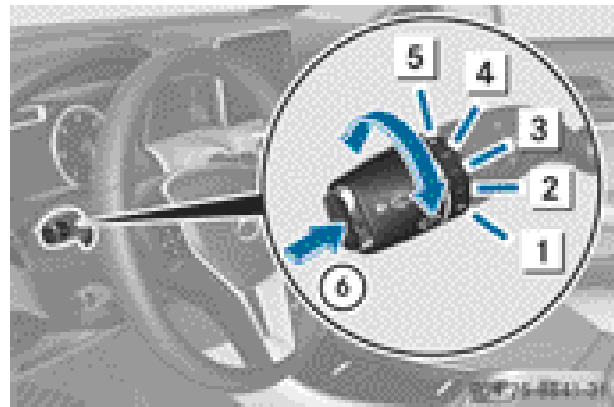

Combination switch

- 1 0 Windscreen wipers off
- 2 ... Intermittent wipe, low (rain sensor set to low sensitivity)
- 3 Intermittent wipe, high (rain sensor set to high sensitivity)
- 4 — Continuous wipe, slow
- 5 = Continuous wipe, fast
- 6 [Washer icon] Single wipe / [Washer icon] to wipe the windscreen using washer fluid

- ▶ Turn the key to position 1 or 2 in the ignition lock.
- ▶ Turn the combination switch to the corresponding position.

! Vehicles with a rain sensor: if the windscreen becomes dirty in dry weather conditions, the windscreen wipers may be activated inadvertently. This could damage the windscreen wiper blades or scratch the windscreen.

For this reason, you should always switch off the windscreen wipers in dry weather.

Vehicles with a rain sensor: in the ... or position, the appropriate wiping frequency is automatically set according to the intensity of the rain. In the position, the rain sensor is more sensitive than in the ... position, causing the windscreen wipers to wipe more frequently.

If the wiper blades are worn, the windscreen will no longer be wiped properly. This could prevent you from observing the traffic conditions. Replace the wiper blades twice a year, ideally in spring and autumn.

Switching the rear window wiper on/off

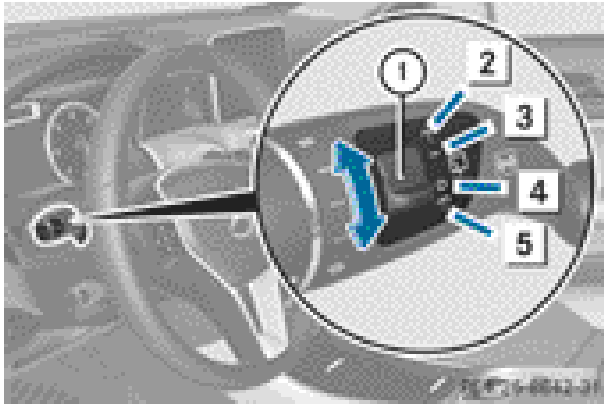

Combination switch

- ① Switch
- ② To wipe with washer fluid
- ③ To switch on intermittent wiping
- ④ To switch off intermittent wiping
- ⑤ To wipe with washer fluid

- ▶ Turn the key to position **1** or **2** in the ignition lock.
- ▶ Turn switch ① on the combination switch to the corresponding position. When the rear window wiper is switched on, the icon appears in the instrument cluster.

Replacing the wiper blades

Important safety notes

WARNING

If the windscreen wipers begin to move while you are changing the wiper blades, you can be trapped by the wiper arm. There is a risk of injury.

Always switch off the windscreen wipers and ignition before changing the wiper blades.

- ❗ To avoid damaging the windscreen wiper blades, make sure that you touch only the wiper arm of the windscreen wiper.
- ❗ Never open the bonnet/tailgate if a wiper arm is folded away from the windscreen/rear window.

Never fold a windscreen wiper arm without a wiper blade back onto the windscreen/rear window.

Hold the windscreen wiper arm firmly when you change the wiper blade. If you release the wiper arm without a wiper blade and it falls onto the windscreen/rear window, the windscreen/rear window may be damaged by the force of the impact.

Mercedes-Benz recommends that you have the wiper blades changed at a qualified specialist workshop.

Replacing the windscreen wiper blades

Removing the wiper blades

- ▶ Remove the key from the ignition lock.
- ▶ Fold the wiper arm away from the windscreen.

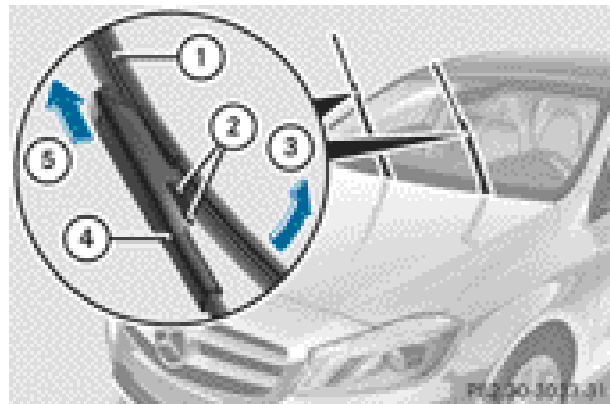

- ▶ Press both release clips ②.
- ▶ Fold wiper blade ① in the direction of arrow ③ away from wiper arm ④.
- ▶ Remove wiper blade ① in the direction of arrow ⑤.

Fitting the wiper blades

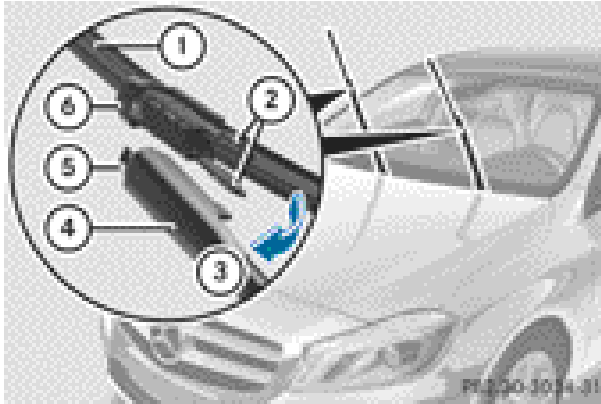

- ▶ Position new wiper blade ① with recess ⑥ on lug ⑤.
- ▶ Fold wiper blade ① in the direction of arrow ③ onto the wiper arm, until retaining clips ② engage in bracket ④.
- ▶ Make sure that wiper blade ① is seated correctly.
- ▶ Fold the wiper arm back onto the windscreen.

Replacing the rear window wiper blade

Removing the wiper blades

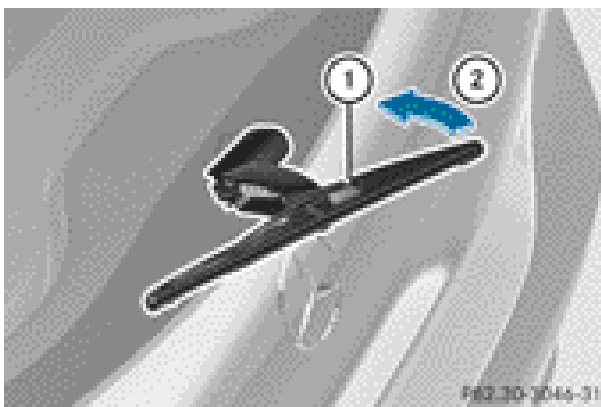

- ▶ Remove the key from the ignition lock.
- ▶ Fold wiper arm ① away from the rear window until it engages.
- ▶ Position wiper blade ② at a right angle to wiper arm ①.

- ▶ Hold wiper arm ① and press wiper blade ② in the direction of the arrow until it releases.
- ▶ Remove wiper blade ②.

Fitting the wiper blades

- ▶ Place new wiper blade ② onto wiper arm ①.
- ▶ Hold wiper arm ① and press wiper blade ② in the opposite direction to the arrow until it engages.
- ▶ Make sure that wiper blade ② is seated correctly.
- ▶ Position wiper blade ② parallel to wiper arm ①.
- ▶ Fold wiper arm ① back onto the rear window.

Problems with the windscreen wipers

Problem	Possible causes/consequences and ► Solutions
The windscreen wipers are jammed.	<p>Leaves or snow, for example, may be obstructing the windscreen wiper movement. The wiper motor has been deactivated.</p> <ul style="list-style-type: none"> ► For safety reasons, you should remove the key from the ignition lock. ► Remove the cause of the obstruction. ► Switch the windscreen wipers back on.
The windscreen wipers fail completely.	<p>The windscreen wiper drive is malfunctioning.</p> <ul style="list-style-type: none"> ► Select another wiper speed on the combination switch. ► Have the windscreen wipers checked at a qualified specialist workshop.
The spray nozzles are misaligned.	<p>The windscreen washer fluid from the spray nozzles no longer hits the centre of the windscreen. The spray nozzles are misaligned.</p> <ul style="list-style-type: none"> ► Have the spray nozzles adjusted at a qualified specialist workshop.

Useful information	122
Overview of climate control systems	122
Operating the climate control system	126
Adjusting the air vents	139

Useful information

- i** This Owner's Manual describes all models, series and optional equipment for your vehicle that were available at the time of going to press. National variations are possible. Note that your vehicle may not be equipped with all of the functions described. This is also the case for systems and functions relevant to safety.
- i** Read the information on qualified specialist workshops: (▷ page 24).

Overview of climate control systems

Important safety notes

Observe the settings recommended on the following pages. The windows could otherwise mist up.

To prevent the windows from misting up:

- switch off climate control only briefly
- switch on air-recirculation mode only briefly
- switch on the cooling with air dehumidification function
- switch on the defrost windscreen function briefly, if required

THERMATIC automatic climate control/
THERMOTRONIC automatic climate control regulates the temperature and the humidity of the vehicle interior and filters out undesirable substances from the air.

THERMATIC automatic climate control/
THERMOTRONIC automatic climate control is only operational when the engine is running. Optimum operation is only achieved with the side windows and panorama sliding sunroof closed.

The residual heat function can only be activated or deactivated with the ignition switched off (▷ page 133).

- i** Ventilate the vehicle for a brief period during warm weather, e.g. using the convenience opening feature (▷ page 85). This

will speed up the cooling process and the desired vehicle interior temperature will be reached more quickly.

- i** The integrated filter can filter out most particles of dust and completely filters out pollen. A clogged filter reduces the amount of air supplied to the vehicle interior. For this reason, you should always observe the interval for replacing the filter, which is specified in the Service Booklet. As it depends on environmental conditions, e.g. heavy air pollution, the interval may be shorter than stated in the Service Booklet.
- i** It is possible that the residual heat function may be activated automatically an hour after the key has been removed in order to dry the air-conditioning system. The vehicle is ventilated for 30 minutes.

Control panel for THERMATIC automatic climate control

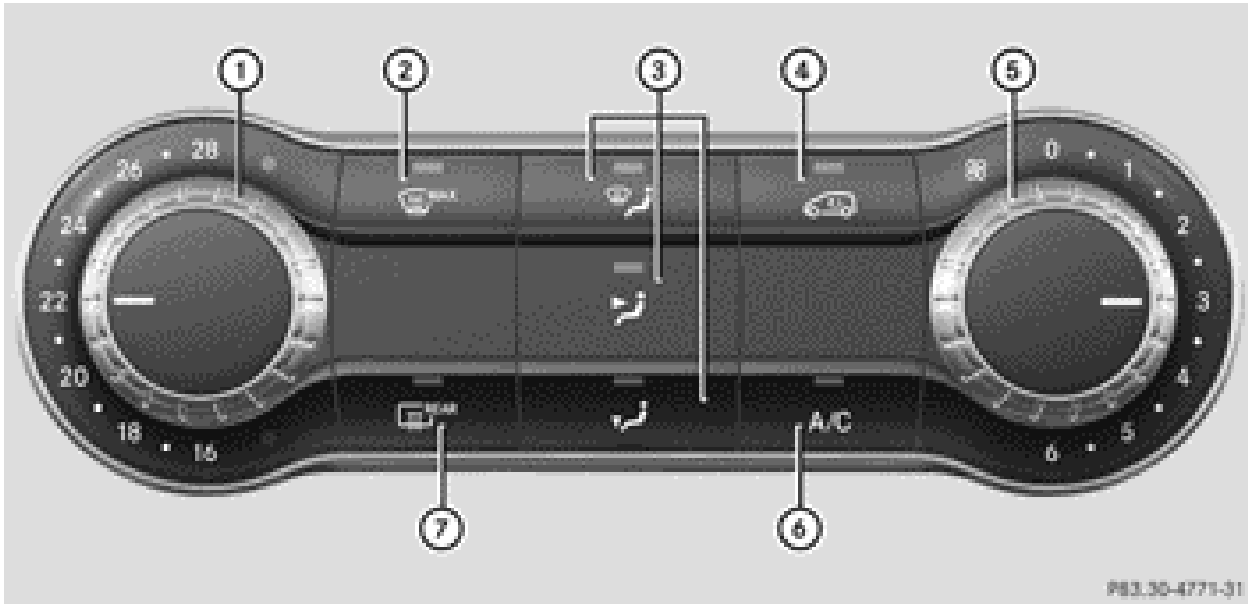





- ① To set the temperature (▷ page 128)
- ② To demist the windscreen (▷ page 130)
- ③ To set the air distribution (▷ page 129)
- ④ To activate/deactivate air-recirculation mode (▷ page 132)
- ⑤ To set the airflow (▷ page 129)
- ⑥ To activate/deactivate cooling with air dehumidification (▷ page 126)
- ⑦ To switch the rear window heating on/off (▷ page 131)

Notes on using THERMATIC automatic climate control





Automatic climate control

The following contains notes and recommendations on optimum use of THERMATIC automatic climate control.

- Switch on the air-conditioning system by turning control knob ⑤ clockwise to the desired position (except position 0).
- Set the temperature to 22 °C.
- **Recommendation to avoid misting of the windows in the event of low outside temperatures or rain:** switch on the air distribution  and if possible switch off  and  (▷ page 129).

Deactivate air-recirculation mode  (▷ page 132).

Set airflow control ⑤ to a setting between 3 and 6 (▷ page 129).

- **Recommendation for rapid cooling or heating of the vehicle interior:** briefly set airflow control ⑤ to a setting between 3 and 6 (▷ page 129).
- **Recommendation for a constant vehicle interior temperature:** set airflow control ⑤ to a position between 1 and 3 (▷ page 129).
- **Recommendation for air distribution in winter:** select the  and  settings (▷ page 129).
- **Recommendation for air distribution in summer:** select the  or  and  settings (▷ page 129).

- Only use the "Windscreen demisting" function briefly until the windscreen is clear again.

- Only use air-recirculation mode briefly, e.g. if there are unpleasant outside odours or when in a tunnel. The windows could otherwise mist up as no fresh air is drawn into the vehicle in air-recirculation mode.
- If you change the settings of the climate control system, the climate status display appears for three seconds at the bottom of the screen in the COMAND display. See also the separate COMAND Online operating instructions⁹. You will see the current settings of the various climate control functions.

ECO start/stop function

During automatic engine switch-off, the climate control only operates at a reduced capacity. If you require the full climate control output, you can switch off the ECO start/stop function by pressing the ECO button (▷ page 147).

⁹ Only for vehicles with "COMAND Online Multimedia System" optional equipment

Control panel for THERMOTRONIC automatic climate control (2-zone)

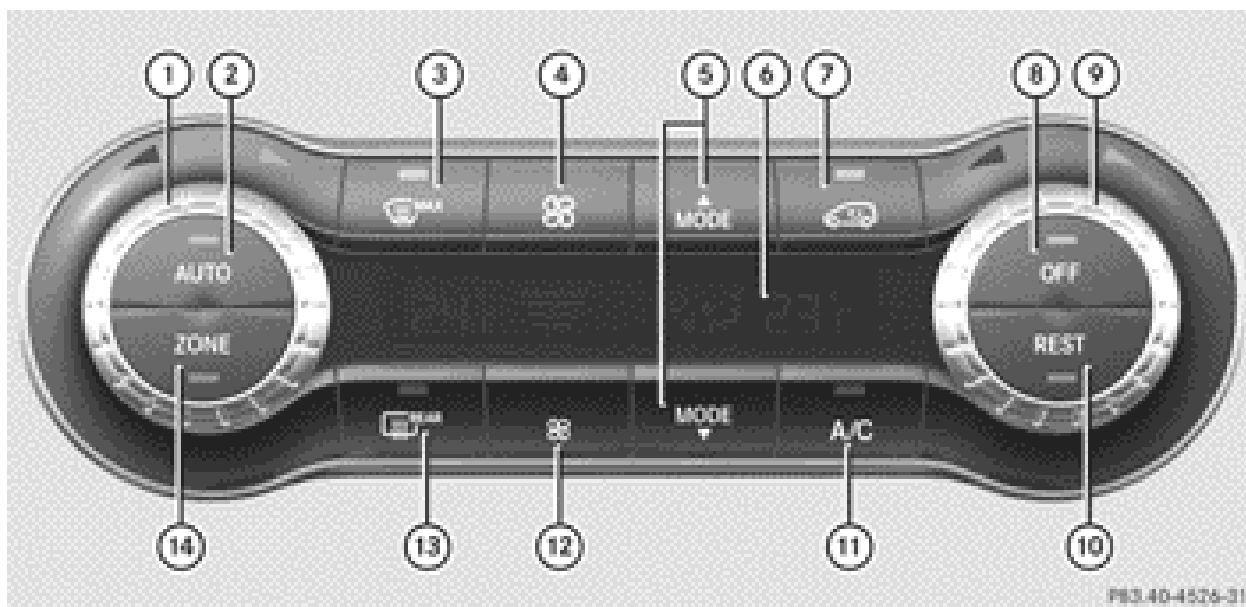

- ① To set the temperature, left (▷ page 128)
- ② To set climate control to automatic mode (▷ page 128)
- ③ To demist the windscreen (▷ page 130)
- ④ To increase the airflow (▷ page 129)
- ⑤ To set the air distribution (▷ page 129)
- ⑥ Display
- ⑦ To activate/deactivate air-recirculation mode (▷ page 132)
- ⑧ To switch climate control on/off (▷ page 126)
- ⑨ To set the temperature, right (▷ page 128)
- ⑩ To activate/deactivate the residual heat function (▷ page 133)
- ⑪ To activate/deactivate cooling with air dehumidification (▷ page 126)
- ⑫ To reduce the airflow (▷ page 129)
- ⑬ To switch the rear window heating on/off (▷ page 131)
- ⑭ To switch the ZONE function on/off (▷ page 129)

Notes on using THERMOTRONIC automatic climate control

Automatic climate control

The following contains instructions and recommendations to enable you to get the most out of your THERMOTRONIC automatic climate control.

- Activate climate control using the **AUTO** and **A/C** buttons. The indicator lamps in the **AUTO** and **A/C** buttons light up.
- Set the temperature to 22 °C.
- Only use the "windscreen demisting" function briefly until the windscreen is clear again.
- Only use air-recirculation mode briefly, e.g. if there are unpleasant outside odours or when in a tunnel. The windows could oth-

erwise mist up as no fresh air is drawn into the vehicle in air-recirculation mode.

- Use the ZONE function to adopt the temperature settings on the driver's side for the front-passenger side as well. The indicator lamp in the **ZONE** button goes out.
- Use the residual heat function if you want to heat or ventilate the vehicle interior when the ignition is switched off. The residual heat function can only be activated or deactivated with the ignition switched off.

ECO start/stop function

During automatic engine switch-off, the climate control only operates at a reduced capacity. If you require the full climate control output, you can switch off the ECO start/stop function by pressing the ECO button (▷ page 147).

Operating the climate control system

Switching climate control on/off

Points to observe before use

When the climate control is switched off, the air supply and air circulation are also switched off. The windows could then mist up. Therefore, switch off climate control only briefly.

THERMATIC automatic climate control

- ▶ Turn the key to position **2** in the ignition lock (▷ page 143).
- ▶ **To switch on:** turn control **5** clockwise to the desired position (except position **0**) (▷ page 123).
- ▶ **To switch off:** turn control **5** anti-clockwise to position **0** (▷ page 123).

THERMOTRONIC automatic climate control

- ▶ Turn the key to position **2** in the ignition lock (▷ page 143).
- ▶ **To activate:** press the **AUTO** button. The indicator lamp in the **AUTO** button lights up. Airflow and air distribution are set to automatic mode.

or

- ▶ Press the **OFF** button. The indicator lamp in the **OFF** button goes out. The previous settings are reactivated.
- ▶ **To deactivate:** press the **OFF** button. The indicator lamp in the **OFF** button lights up.

i THERMOTRONIC automatic climate control: switch on climate control primarily using the **AUTO** button.

Activating/deactivating the cooling with air dehumidification function

Points to observe before use

If you deactivate the "Cooling with air dehumidification function", the air inside the vehicle will not be cooled in warmer weather. The air inside the vehicle will not be dehumidified either. The windows can mist up more quickly. Therefore, only switch off the "Cooling with air dehumidification function" briefly. The "Cooling with air dehumidification" function is only available when the engine is running. The air inside the vehicle is cooled and dehumidified according to the temperature selected.

Condensation may drip from the underside of the vehicle when cooling mode is active. This is normal and not a sign that there is a malfunction.

Switching on/off

- ▶ **To activate:** press the button.
The indicator lamp in the button lights up.
- ▶ **To deactivate:** press the button.
The indicator lamp in the button goes out. The "Cooling with air dehumidification" function has a delayed switch-off feature.

Problems with the "Cooling with air dehumidification" function

Problem	Possible causes/consequences and ► Solutions
The indicator lamp in the  button flashes three times or remains off. The "Cooling with air dehumidification function" cannot be switched on.	Cooling with air dehumidification has been deactivated due to a malfunction. ► Visit a qualified specialist workshop.



Setting climate control to automatic mode



Only THERMOTRONIC automatic climate control features the "control climate control automatically" function.

In automatic mode, the set temperature is maintained automatically at a constant level. The system automatically regulates the temperature of the dispensed air, the airflow and the air distribution.



The automatic mode functions optimally when the "Cooling with air dehumidification" function is activated. If desired, cooling with air dehumidification can be deactivated.

If you deactivate the "Cooling with air dehumidification function", the air inside the vehicle will not be cooled in warmer weather. The air inside the vehicle will not be dehumidified either. The windows can mist up more quickly. Therefore, only switch off the "Cooling with air-dehumidification function" briefly.

- Turn the key to position **2** in the ignition lock (▷ page 143).
- Set the desired temperature.
- **To activate:** press the  button. The indicator lamp in the  button lights up. Automatic air distribution and airflow are activated.

- **To switch to manual operation:** press the  or  button.

or

- Press the  or  button. The indicator lamp in the  button goes out. Automatic air distribution and airflow are deactivated.

Setting the temperature



THERMATIC automatic climate control

You can set the temperature for the entire vehicle.

- Turn the key to position **2** in the ignition lock (▷ page 143).
- **To increase/reduce:** turn control  clockwise or anti-clockwise (▷ page 123). Only change the temperature setting in small increments. Start at 22 °C.

THERMOTRONIC automatic climate control



Different temperatures can be set for the driver's and front-passenger sides.

- Turn the key to position **2** in the ignition lock (▷ page 143).
- **To increase/reduce:** turn controls  or  clockwise or anti-clockwise (▷ page 125). Only change the temperature setting in small increments. Start at 22 °C.

Setting the air distribution



THERMATIC automatic climate control

Air distribution settings

-  Directs the airflow through the demister vents
-  Directs the airflow through the centre and side air vents
-  Directs the airflow through the footwell air vents







i You can also activate several of the air distribution settings simultaneously. In order to do this, press several of the air distribution buttons. The air is then routed through different air vents.

Setting the air distribution

- ▶ Turn the key to position **2** in the ignition lock (▷ page 143).
- ▶ Press one or more of the , ,  buttons.
The corresponding indicator lamp comes on.

THERMOTRONIC automatic climate control



Air distribution settings

-  Directs the airflow through the demister vents
-  Directs the airflow through the centre and side air vents
-  Directs the airflow through the footwell air vents
-  Directs airflow through the centre and side air vents as well as the footwell air vents¹⁰.
-  Directs the airflow through the centre and side air vents as well as the demister vents¹⁰
-  Directs the airflow through the footwell and demister vents

¹⁰ Only for certain countries.

i Regardless of the air distribution setting, airflow is always directed through the side air vents. The side air vents can only be closed if the adjusters are turned clockwise until they engage.

Setting the air distribution



- ▶ Turn the key to position **2** in the ignition lock (▷ page 143).
- ▶ Press the  or  button until the desired symbol appears in the display.

Setting the airflow

THERMATIC automatic climate control





- ▶ Turn the key to position **2** in the ignition lock (▷ page 143).
- ▶ **To increase/reduce:** turn control  clockwise or anti-clockwise (▷ page 123).

THERMOTRONIC automatic climate control

- ▶ Turn the key to position **2** in the ignition lock (▷ page 143).
- ▶ **To increase/reduce:** press the  or  button.

Switching the ZONE function on/off

This function is only available with the THERMOTRONIC automatic climate control.



- ▶ **To activate:** press the  button.
The indicator lamp in the  button lights up.
The temperature setting for the driver's side is not adopted for the front-passenger side.
- ▶ **To deactivate:** press the  button.
The indicator lamp in the  button goes out.

The temperature setting for the driver's side is adopted for the front-passenger side.

Demisting the windscreen

You can use this function to defrost the windscreen or to demist the inside of the windscreen and the side windows.





i You should only select the "Windscreen demisting" function until the windscreen is clear again.

- ▶ Turn the key to position **2** in the ignition lock (▷ page 143).
- ▶ **To activate:** press the  button. The indicator lamp in the  button lights up.

The climate control system switches to the following functions:

- high airflow
- high temperature
- air distribution to the windscreen and front side windows
- air-recirculation mode off

i The "Windscreen demisting" function automatically sets the blower output to the optimum demisting effect. As a result, the airflow may increase or decrease automatically after the button is pressed.

- i** You can adjust the blower output manually while the "Windscreen demisting" function is in operation:
 - **THERMATIC automatic climate control:** turn temperature control  clockwise or anti-clockwise (▷ page 123).
 - **THERMOTRONIC automatic climate control:** press the  or  button.
- ▶ **To deactivate:** press the  button. The indicator lamp in the  button goes out. The previous settings are reactivated.



Air-recirculation mode remains deactivated.

or

- ▶ Press the **AUTO** button¹¹. The indicator lamp in the  button goes out. Airflow and air distribution are set to automatic mode.

or

- ▶ **THERMATIC automatic climate control:** turn temperature control  clockwise or anti-clockwise (▷ page 123).

THERMOTRONIC automatic climate control: turn temperature controls  or  clockwise or anti-clockwise (▷ page 125).

Demisting the windows

Windows misted up on the inside

THERMATIC automatic climate control

- ▶ Activate the  "Cooling with air dehumidification" function.
- ▶ If the windows continue to mist up, activate the "Windscreen demisting" function (▷ page 130).

i You should only select this setting until the windscreen is clear again.



THERMOTRONIC automatic climate control

- ▶ Activate the  "Cooling with air dehumidification" function.
- ▶ Activate automatic mode **AUTO**.
- ▶ If the windows continue to mist up, activate the "Windscreen demisting" function (▷ page 130).

i You should only select this setting until the windscreen is clear again.

¹¹ THERMOTRONIC only.

Windows misted up on the outside



- ▶ Activate the windscreen wipers.
- ▶ Set the air distribution to  or .
- ▶ **i** You should only select this setting until the windscreen is clear again.

Rear window heating

Switching on/off

The rear window heating has a high current draw. You should therefore switch it off as soon as the window is clear. It otherwise switches off automatically after several minutes.

If the battery voltage is too low, the rear window heating may switch off.

- ▶ Turn the key to position **2** in the ignition lock (▶ page 143).
- ▶ Press the  button.
The indicator lamp in the  button lights up or goes out.

Problems with the rear window heating





Problem	Possible causes/consequences and ► Solutions
The rear window heating has switched off prematurely or cannot be activated.	<p>The battery has not been sufficiently charged.</p> <p>► Switch off any consumers that are not required, e.g. reading lamps, interior lighting or the seat heating.</p> <p>When the battery is sufficiently charged, the rear window heating can be activated again.</p>

Activating/deactivating air-recirculation mode

If you switch on air-recirculation mode, the windows can mist up more quickly, in particular at low temperatures. Only use air-recirculation mode briefly to prevent the windows misting up.

You can deactivate the flow of fresh air if unpleasant odours are entering the vehicle from outside. The air already inside the vehicle will then be recirculated.

The operation of air-recirculation mode is the same for all control panels.

- Turn the key to position **2** in the ignition lock (▷ page 143).
- **To activate:** press the  button. The indicator lamp in the  button lights up.
- i** Air-recirculation mode is activated automatically at high outside temperatures. When air-recirculation mode is activated automatically, the indicator lamp in the  button is not lit. Outside air is added after about 30 minutes.
- **To deactivate:** press the  button. The indicator lamp in the  button goes out.

i Air-recirculation mode deactivates automatically:

- after approximately five minutes at outside temperatures below approximately 5 °C.
- after approximately five minutes if the "Cooling with air dehumidification" function is deactivated.
- after approximately 30 minutes at outside temperatures above approximately 5 °C and when the "Cooling with air dehumidification function" is activated.

Convenience opening/closing using the air-recirculation button

WARNING

When the convenience closing feature is operating, parts of the body could become trapped in the closing area of the side window and the sliding sunroof. There is a risk of injury.



Observe the complete closing procedure when the convenience closing feature is operating. When closing make sure that no parts of the body are in the closing area.

WARNING





During convenience opening parts of the body could be drawn in or become trapped between the side window and window frame. There is a risk of injury.

When opening, make sure that nobody is touching the side window. If someone becomes trapped, press the  switch

immediately to open/close the side window in the door. The side window stops. To continue closing the side window, pull on the  switch.



- ▶ **Convenience closing feature:** press and hold the  button until the side windows and the panorama sliding sunroof are closed.
The indicator lamp in the  button lights up. Air-recirculation mode is activated.

If parts of the body are in the closing area during convenience closing, proceed as follows:

- ▶ To open/close the side window, press the  button.
The side window stops.
- ▶ To then open the side window, press the  button again.
- ▶ To open/close the panorama sliding sunroof press the  button.
The panorama sliding sunroof stops.
- ▶ To then open the panorama sliding sunroof press the  button again.
- ▶ Press the  button again for longer than 2 seconds.
The side windows move in the opposite direction.

- i** Notes on the automatic reversing function for:

- the side window (▷ page 84)
- the panorama sliding sunroof (▷ page 87)

- ▶ **Convenience opening feature:** press and hold the  button until the side windows and the panorama sliding sunroof have opened. The side windows and the panorama sliding sunroof move back to their original position.
The indicator lamp in the  button goes out. Air-recirculation mode is deactivated.





- i** If you open the side windows or the panorama sliding sunroof manually after closing with the convenience closing feature,

they will remain in this position when opened using the convenience opening feature.

Activating/deactivating the residual heat function

The residual heat function is only available with THERMOTRONIC automatic climate control.

It is possible to make use of the residual heat of the engine to continue heating the vehicle for approximately 30 minutes after the engine has been switched off. The heating time depends on the temperature that has been set for the vehicle interior.

- i** The blower will run at a low speed regardless of the airflow setting.
- i** If you activate the residual heat function at high temperatures, only the ventilation will be activated. The blower runs at medium speed.
- ▶ Turn the key to position **0** in the ignition lock or remove it (▷ page 143).
- ▶ **To activate:** press the  button.
The indicator lamp in the  button lights up.
- ▶ **To deactivate:** press the  button.
The indicator lamp in the  button goes out.
- i** Residual heat is deactivated automatically:
 - after approximately 30 minutes
 - when the ignition is switched on
 - if the battery voltage drops
 - when the auxiliary heating is switched on

Auxiliary heating

Important safety notes

DANGER

If the exhaust pipe is blocked or sufficient ventilation is not possible, toxic exhaust fumes can enter the vehicle, especially carbon monoxide. This is the case, e.g. in enclosed spaces, or if the vehicle is stuck in snow. There is a risk of fatal injuries.

You should switch off the auxiliary heating in enclosed spaces which do not have an extraction system, e.g. a garage. If the vehicle is stuck in snow and you must leave the auxiliary heating running, keep the exhaust pipe and the area around the vehicle clear of snow. To guarantee a sufficient supply of fresh air, open a window on the side of the vehicle away from the wind.

WARNING

When the auxiliary heating is switched on, parts of the vehicle can become very hot. Flammable material such as leaves, grass or twigs may ignite if they come into contact with hot parts of the exhaust system for extended periods. There is a risk of fire.

When the auxiliary heating is switched on, make sure that no flammable material can come into contact with hot vehicle components.

! Operating the auxiliary heating/ventilation draws on the vehicle battery. After you have heated or ventilated the vehicle a maximum of two times, drive for a longer distance.

i Switch the auxiliary heating on regularly once a month for about ten minutes.

The auxiliary heating heats the air in the vehicle interior to the set temperature. This occurs without using the heat of the running engine. The auxiliary heating is operated directly using the vehicle's fuel. For this reason, the fuel tank must be at least $\frac{1}{4}$ full to ensure that the auxiliary heating functions.

The auxiliary heating/ventilation automatically adjusts to changes in temperature and weather conditions. For this reason, the auxiliary heating could switch from ventilation mode to heating mode or from heating mode to ventilation mode.

The auxiliary heating switches off when the engine is switched off. The auxiliary ventilation switches off when you turn the key to key position **2** (▷ page 143).

The auxiliary heating switches off automatically after 30 minutes.

You cannot use the auxiliary ventilation to cool the vehicle interior to a temperature lower than the outside temperature.

Before switching on

- ▶ Turn the key to position **2** in the ignition lock (▷ page 143).
- ▶ Set the desired temperature.

Auxiliary heating or ventilation can also be switched on if the manually set climate control is activated. Optimum comfort can be attained when the system is set to automatic mode. Set the temperature to 22 °C.

The auxiliary heating/ventilation can be activated or deactivated using the remote control or the button on the centre console.

The on-board computer can be used to specify up to three departure times, one of which may be preselected (▷ page 224).

Switching the auxiliary heating/ventilation on/off using the centre console button

Switching on the auxiliary heating/ventilation

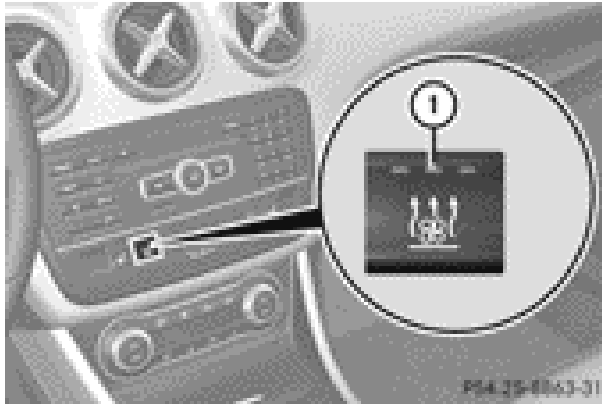

The colours of the indicator lamps on the button have the following meanings:

- Blue Auxiliary ventilation switched on
- Red Auxiliary heating switched on
- Yellow Departure time preselected (▷ page 224)

- ▶ Press button ①. The red or blue indicator lamp in button ① lights up.

Switching off the auxiliary heating/ventilation

- ▶ Press button ①. The red or blue indicator lamp in button ① goes out.

Switching the auxiliary heating/ventilation on/off using the remote control

Your vehicle comes with one remote control. You may use two additional remote controls for your vehicle. For more information, please contact a qualified specialist workshop.

The remote control has a maximum range of approximately 300 metres. This range is reduced by:

- sources of radio interference
- solid objects between the remote control and the vehicle

- the remote control being in an unfavourable position in relation to the vehicle
- transmitting from an enclosed space

- ① The optimum range can be achieved if you hold the remote control vertically, pointing upwards when you press one of the buttons.
- ① A battery symbol appears in the display when the battery in the remote control is low. Replace the remote control battery (▷ page 136).

Switching the auxiliary heating/ventilation on/off

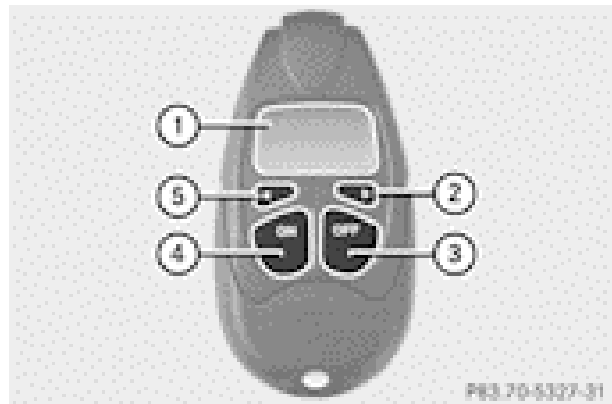

Remote control







- ① Display
- ② To check the status/set the departure time
- ③ **OFF** To switch off the auxiliary heating/ventilation
- ④ **ON** To switch on the auxiliary heating/ventilation
- ⑤ To check the status/set the departure time

- ▶ **To activate:** press the **ON** button. **ON** is shown in the remote control display.
- ▶ **To deactivate:** press the **OFF** button. **OFF** is shown in the remote control display.





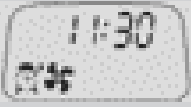

Checking the status of the auxiliary heating/ventilation



- ▶ Press the or button.



The following messages may appear in the display:

Display	Meaning
	The auxiliary heating/ventilation is switched off.
	The auxiliary ventilation is switched on. The number in the display shows the remaining time (in minutes) for the auxiliary ventilation.
	The auxiliary heating is switched on. The number in the display shows the remaining time (in minutes) for the auxiliary heating.
	A departure time has been activated. The departure time appears in the display.
	A departure time has been activated. The auxiliary ventilation is currently activated. The departure time appears in the display.
	A departure time has been activated. The auxiliary heating is currently activated. The departure time appears in the display.





Setting the departure time

- ▶ Press the  or  button repeatedly until the time to be changed appears in the display.
- ▶ Press the  and  buttons simultaneously. The  symbol in the remote control display flashes.
- ▶ Press the  or  button to set the desired departure time.





i The longer you press the  or  button, the faster the time changes.

- ▶ Press the  and  buttons simultaneously. The new departure time is stored.

Activating the set departure time

- ▶ Press the  or  button repeatedly until the desired departure time appears in the display.
- ▶ Press the  button. The  symbol and the departure time appear in the display.

Deactivating a set departure time

- ▶ Press the  or  button. The status of the auxiliary heating is shown in the display.
- ▶ Press the  button. The first departure time stored appears in the display.
- ▶ Press the  button. **OFF** is shown in the remote control display.

Replacing the remote control battery

WARNING

Batteries contain toxic and corrosive substances. If batteries are swallowed, it can result in severe health problems. There is a risk of fatal injury.

Keep batteries out of the reach of children. If a battery is swallowed, seek medical attention immediately.

ⓘ **Environmental note**



Batteries contain pollutants. It is illegal to dispose of them with the household rubbish. They must be collected separately and disposed of in an environmentally responsible recycling system.



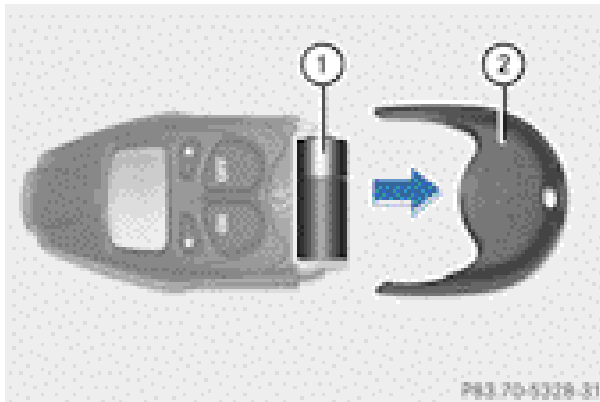

Dispose of batteries in an environmentally responsible manner. Take discharged batteries to a qualified specialist workshop or to a collection point for used batteries.

One 6 V pin battery, type 2CR11108 is required.



- ▶ Prise apart the side arms of battery cover ② and pull off battery cover ②.
- ▶ Remove old battery ①.
- ▶ Insert the new battery. Observe the polarity signs on the back of the remote control when doing so.
- ▶ Slide battery cover ② back onto the remote control.
- ▶ Use the remote control to check the vehicle's auxiliary heating functions.

Problems with the auxiliary heating/ventilation

Display messages	Possible causes/consequences and ► Solutions
 FAIL	<p>The signal transmission between the transmitter and the vehicle is faulty.</p> <ul style="list-style-type: none"> ► Change your position in relation to the vehicle, moving closer if necessary. ► Make another attempt to switch the auxiliary heating on or off using the remote control.
 FAIL	<p>There is too little fuel in the fuel tank.</p> <ul style="list-style-type: none"> ► Refuel at the nearest filling station. ► Make another attempt to switch on the auxiliary heating using the remote control.
	<p>The auxiliary heating is faulty.</p> <ul style="list-style-type: none"> ► Have the auxiliary heating checked at a qualified specialist workshop.
FAIL	<p>The auxiliary heating cannot be switched on or has switched itself off.</p> <p>The auxiliary heating was started more than twice when the engine was switched off.</p> <ul style="list-style-type: none"> ► Switch on the engine and let it run for more than ten seconds. ► Make another attempt to switch on the auxiliary heating using the remote control.
	<p>The auxiliary heating cannot be switched on or has switched itself off.</p> <p>The starter battery is not sufficiently charged.</p> <ul style="list-style-type: none"> ► Charge the starter battery. ► Make another attempt to switch on the auxiliary heating using the remote control.

Display messages	Possible causes/consequences and ► Solutions
	<p>The auxiliary heating cannot be switched on or has switched itself off.</p> <p>There is too little fuel in the fuel tank.</p> <ul style="list-style-type: none"> ► Refuel at the nearest filling station. ► Make another attempt to switch on the auxiliary heating using the remote control.
	<p>The auxiliary heating cannot be switched on or has switched itself off.</p> <p>The auxiliary heating is faulty.</p> <ul style="list-style-type: none"> ► Have the auxiliary heating checked at a qualified specialist workshop.

Adjusting the air vents

Important safety notes

WARNING

Very hot or very cold air can flow from the air vents. This could result in burns or frostbite in the immediate vicinity of the air vents. There is a risk of injury.

Make sure that all vehicle occupants always maintain a sufficient distance to the air outlets. If necessary, redirect the airflow to another area of the vehicle interior.

In order to ensure the direct flow of fresh air through the air vents into the vehicle interior, please observe the following notes:

- keep the air inlet between the windscreen and the bonnet free of blockages, such as ice, snow or leaves.
- never cover the vents or ventilation grilles in the vehicle interior.
- i** Move the adjusters for the air vents vertically or horizontally, to set the direction of the airflow.
- i** Optimal climate control function is achieved by opening the air vents fully and setting the adjusters to the middle position.

Setting the centre air vents

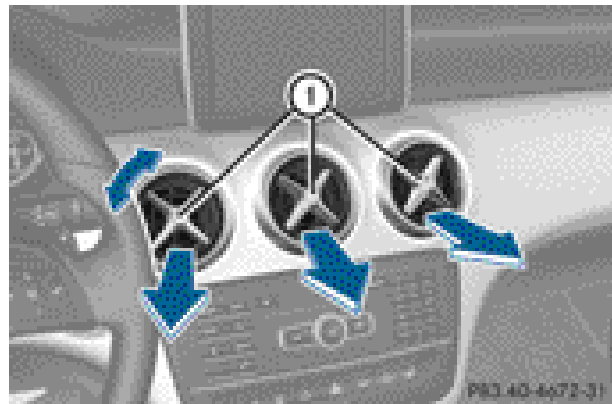

- **To open the centre air vent:** turn the adjuster in one of centre air vents ① anti-clockwise.
- **To close the centre air vent:** turn the adjuster in one of centre air vents ① clockwise until it engages.

Adjusting the side air vents

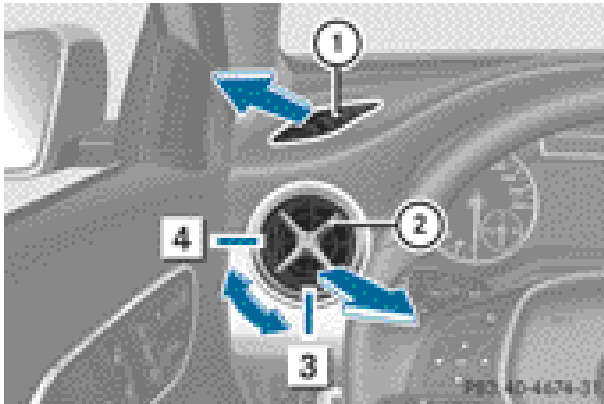

① Side window demister vent

② Side air vent

- ▶ **To open a side air vent:** turn the adjuster in side air vent ② anti-clockwise.
- ▶ **To close a side air vent:** turn the adjuster in side air vent ② clockwise until it engages.

Setting the rear-compartment air vents

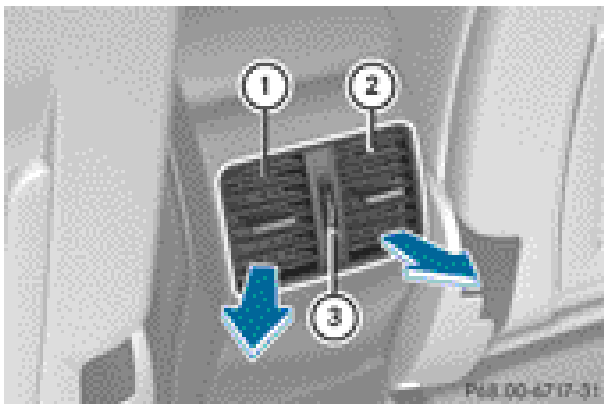

① Rear-compartment air vent, left

② Rear-compartment air vent, right

③ Rear-compartment air vent thumbwheel

- ▶ **To open/close:** turn thumbwheel ③ up or down.

Useful information	142
Running-in notes	142
Driving	142
Manual transmission	150
Automatic transmission	151
Refuelling	159
Parking	162
Driving tips	165
Driving systems	168
Towing a trailer	201

Useful information

- i** This Owner's Manual describes all models, series and optional equipment for your vehicle that were available at the time of going to press. National variations are possible. Note that your vehicle may not be equipped with all of the functions described. This is also the case for systems and functions relevant to safety.
- i** Read the information on qualified specialist workshops: (▷ page 24).

Running-in notes

Important safety notes

New brake pads/linings and discs that have been replaced only achieve optimum braking effect after several hundred kilometres of driving. Compensate for the reduced braking effect by applying greater force to the brake pedal.

The first 1500 km

If you treat the engine with sufficient care from the very start, you will be rewarded with excellent performance for the remainder of the engine's life.

- Drive at varying vehicle speeds and engine speeds for the first 1500 km.
- Avoid overstraining the vehicle during this period, e.g. driving at full throttle.
- Change gear in good time, before the rev counter needle is $\frac{2}{3}$ of the way to the red area of the rev counter.
- Do not shift down a gear manually in order to brake.

Vehicles with automatic transmission:

- Try to avoid depressing the accelerator pedal beyond the point of resistance (kick-down).

After 1,500 km, you may gradually bring the vehicle up to full road and engine speeds.

Additional running-in notes for AMG vehicles:

- Do not drive at speeds above 140 km/h for the first 1,500 km.
- Only allow the engine to reach a maximum engine speed of 4,500 rpm briefly.
- i** You should also observe these notes on running-in if the engine or parts of the drive train on your vehicle have been replaced.

Driving

Important safety notes

WARNING

Objects in the driver's footwell may restrict the clearance around the pedals or block a depressed pedal. This jeopardises the operating and road safety of the vehicle. There is a risk of an accident.

Stow all objects securely in the vehicle so that they do not get into the driver's footwell. Always fit the floor mats securely and as prescribed in order to ensure that there is always sufficient room for the pedals. Do not use loose floor mats and do not place several floor mats on top of one another.

WARNING

Unsuitable footwear can hinder correct usage of the pedals, e.g.:

- shoes with thick soles
- shoes with high heels
- slippers

There is a risk of an accident.

Wear suitable footwear to ensure correct usage of the pedals.

WARNING

If you switch off the ignition while driving, safety-relevant functions are only available with limitations, or not at all. This could affect, for example, the power steering and the brake boosting effect. You will require considerably

more effort to steer and brake. There is a risk of an accident.

Do not switch off the ignition while driving.

WARNING

If the parking brake has not been fully released when driving, the parking brake can:

- overheat and cause a fire
- lose its hold function.

There is a risk of fire and an accident. Release the parking brake fully before driving off.

! Warm up the engine quickly. Do not use the engine's full performance until it has reached operating temperature.

Only set the automatic transmission to the respective drive positions when the vehicle is stationary.

Where possible, avoid spinning the drive wheels when pulling away on slippery roads. Otherwise, you could damage the drive train.

! **AMG vehicles:** avoid full-load operation and engine speeds greater than 5000 rpm when the engine is cold. This helps to protect the engine and avoids uncomfortable driving.

Key positions

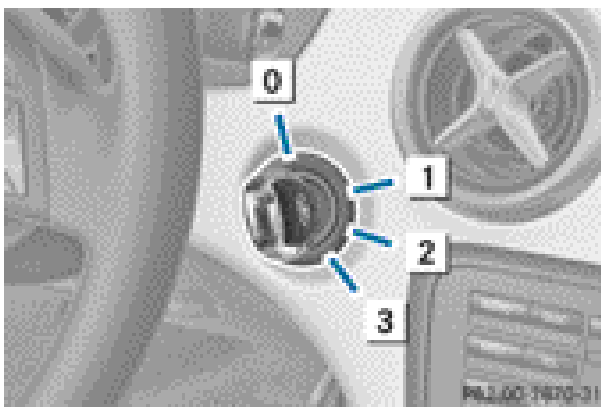

- 0** To remove the key
- 1** Power supply for some consumers, such as the windscreen wipers

- 2** Ignition (power supply for all consumers) and drive position
- 3** To start the engine

Vehicles with manual transmission: the steering is locked when the key is taken out of the ignition lock.

- i** If the key does not belong to the vehicle, it can still be turned in the ignition lock. However, the ignition will not be switched on. The engine cannot be started.

Starting the engine

Important safety notes

WARNING

Combustion engines emit poisonous exhaust gases such as carbon monoxide. Inhaling these exhaust gases leads to poisoning. There is a risk of fatal injury. Therefore never leave the engine running in enclosed spaces without sufficient ventilation.

WARNING

Flammable materials introduced through environmental influence or by animals can ignite if in contact with the exhaust system or parts of the engine that heat up. There is a risk of fire.

Carry out regular checks to make sure that there are no flammable foreign materials in the engine compartment or in the exhaust system.

! Do not depress the accelerator pedal when starting the engine.

- i** **Vehicles with a petrol engine:** the engine runs at a higher engine speed during the cold start procedure so that the catalytic converter can reach operating temperature more quickly. The sound of the engine may change as a result.



Manual transmission

- ▶ Depress the brake pedal and keep it depressed.
 - ▶ Depress the clutch pedal fully.
 - ▶ Shift to neutral **N**.
- i** You can only start the engine when the clutch pedal is fully depressed.

Automatic transmission

- ▶ Shift the transmission to position **P**. Transmission position display **P** is shown in the multifunction display.
- i** When the transmission is in position **N**, you can also start the engine with the brake pedal depressed.

Starting procedure

- ▶ **To start a petrol engine:** turn the key to position **3** in the ignition lock (▷ page 143) and release it as soon as the engine is running.
 - ▶ **To start a diesel engine:** turn the key to position **2** in the ignition lock (▷ page 143).
The  preglow indicator lamp in the instrument cluster lights up.
 - ▶ When the  preglow indicator lamp goes out, turn the key to position **3** (▷ page 143) and release it as soon as the engine is running.
- i** You can start the engine without preglow if the engine is warm.

Pulling away

Manual transmission

- !** Change gear in good time and avoid spinning the wheels. Otherwise, you could damage the vehicle.

- ▶ Depress the brake pedal and keep it depressed.
- ▶ Depress the clutch pedal fully.
- ▶ Shift to either first gear or reverse gear **R**.
- ▶ Release the electric parking brake (▷ page 163).
- ▶ Release the brake pedal.
- ▶ Slowly release the clutch pedal and gently depress the accelerator pedal.

- i** Follow the shift recommendations in the multifunction display for an economical driving style (▷ page 151).

- i** The vehicle locks centrally once you have pulled away. The locking knobs in the doors drop down.

You can open the doors from the inside at any time.

You can also deactivate the automatic locking feature (▷ page 223).

Automatic transmission

- i** It is only possible to shift the transmission from position **P** to the desired position if you depress the brake pedal. Only then can the parking lock be deactivated. If you do not depress the brake pedal, the DIRECT SELECT lever can still be moved but the parking lock remains engaged.

- i** At transmission fluid temperatures below $-20\text{ }^{\circ}\text{C}$, you can only shift out of position **P** into another transmission position when the engine is running.

- ▶ Depress the brake pedal and keep it depressed.
- ▶ Shift the transmission to position **D** or **R**.
- ▶ Release the brake pedal.
- ▶ Carefully depress the accelerator pedal. The electric parking brake (▷ page 163) is automatically released.
The red  indicator lamp in the instrument cluster goes out.

- i** The vehicle locks centrally once you have pulled away. The locking knobs in the doors drop down.

You can open the doors from the inside at any time.



You can also deactivate the automatic locking feature (▷ page 223).

- i** Upshifts take place at higher engine speeds after a cold start. This helps the catalytic converter to reach its operating temperature more quickly.

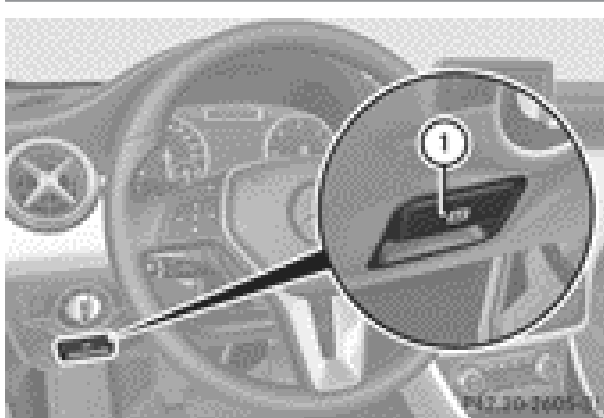
Pulling away with a trailer



To ensure that you do not roll backwards when pulling away on an uphill slope, engage the electric parking brake.

- ▶ Press and hold handle ①.
The electric parking brake continues to brake and prevent the vehicle from rolling backwards.
The red  indicator lamp in the instrument cluster remains lit.
- ▶ Depress the accelerator pedal.
- ▶ As soon as the vehicle/trailer combination is held by the driving force of the engine, release lever ①.
The electric parking brake is released.
The red  indicator lamp in the instrument cluster goes out.
- i** For further information on the electric parking brake, see (▷ page 163).

Hill start assist

WARNING

After a short time, hill start assist will no longer brake your vehicle and it could roll away. There is a risk of an accident and injury.

Therefore, quickly move your foot from the brake pedal to the accelerator pedal. Never leave the vehicle when it is held by hill start assist.

Hill start assist helps you when pulling away forwards or in reverse on an uphill gradient. It holds the vehicle for a short time after you have removed your foot from the brake pedal. This gives you enough time to move your foot from the brake pedal to the accelerator pedal and depress it before the vehicle begins to roll.

- ▶ Remove your foot from the brake pedal.
The vehicle is then held for about a second.
- ▶ Pull away.

Hill start assist will not function if:

- you are pulling away on a level road or a downhill gradient.
- on vehicles with automatic transmission, the transmission is in position **N**.
- the electric parking brake is engaged.
- ESP[®] is malfunctioning.

Further information on holding the vehicle stationary on uphill gradients (▷ page 154).

ECO start/stop function

Introduction

The ECO start/stop function switches the engine off automatically if the vehicle is stopped under certain conditions.

When pulling away again, the engine starts automatically. The ECO start/stop function thereby helps you to reduce the fuel consumption and emissions of your vehicle.

Important safety notes

WARNING

If the engine is switched off automatically and you exit the vehicle, the engine is restarted automatically. The vehicle may begin moving. There is a risk of accident and injury.

If you wish to exit the vehicle, always turn off the ignition and secure the vehicle against rolling away.

General notes



ECO start/stop display

If the **ECO** symbol is shown in green in the multifunction display, the ECO start/stop function switches the engine off automatically if the vehicle stops moving.

The stop/start function is automatically activated each time you start the engine with the ignition key.

If the ECO start/stop function has been manually deactivated ([▷ page 147](#)) or a malfunction has caused the system to be deactivated, the **ECO** symbol is not displayed.

AMG vehicles: the ECO start/stop function is only available in drive program **C**.

Automatic engine switch-off

General notes

The ECO start/stop function is operational and the **ECO** symbol is displayed in green in the multifunction display, if:

- the indicator lamp in the ECO button is lit green
- the outside temperature is within the range that is suitable for the system

- the engine is at normal operating temperature
- the set temperature for the vehicle interior has been reached
- the battery is sufficiently charged
- the system detects that the windscreen is not misted up when the air-conditioning system is switched on
- the bonnet is closed
- the driver's door is closed and the driver's seat belt is fastened

If not all conditions for automatic engine switch-off are fulfilled, the **ECO** symbol is shown in yellow.

 All of the vehicle's systems remain active when the engine is switched off automatically.

 The engine can be switched off automatically a maximum of four times (initial stop, then three subsequent stops) in succession. The **ECO** symbol is shown in yellow in the multifunction display after the engine has been started automatically for the fourth time. When the **ECO** symbol is shown in green in the multifunction display, automatic engine switch-off is again possible.

Vehicles with manual transmission

The ECO start/stop function switches off the engine automatically at low speeds.

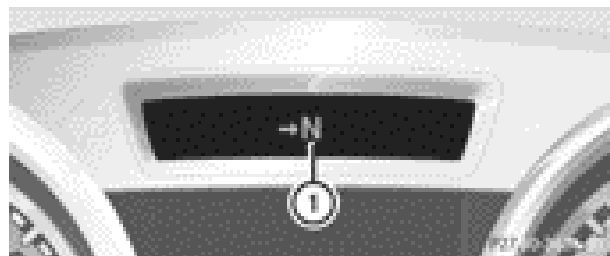

- ▶ Brake the vehicle.
- ▶ Engage neutral **N** ([▷ page 151](#)) (follow gearshift instruction  to engage neutral **N**, if necessary).
- ▶ Release the clutch pedal.
The engine is switched off automatically.

Vehicles with automatic transmission

If the vehicle is braked to a standstill in **D** or **N**, the ECO start/stop function switches off the engine automatically.

- i** The HOLD function can be activated if the engine has been switched off automatically. It is then not necessary to continue applying the brakes during the automatic stop phase. When you depress the accelerator pedal, the engine starts automatically and the braking effect of the HOLD function is deactivated.

Automatic engine start

General notes

The engine is started automatically if:

- you switch off the ECO start/stop function by pressing the ECO button
- you engage reverse gear **R**
- the vehicle starts to roll
- the brake system requires this
- the temperature in the vehicle interior deviates from the set range
- the system detects moisture on the windscreen when the air-conditioning system is switched on
- the battery's charge status is too low
- the driver's seat belt is released or the driver's door is opened

Vehicles with manual transmission

- !** Only engage gear when the clutch pedal is depressed.

The engine is started automatically if you:

- depress the clutch pedal fully
- depress the accelerator pedal

Vehicles with automatic transmission

The engine is started automatically if you:

- release the brake pedal when HOLD is not activated and the transmission is in position **D** or **N**
- depress the accelerator pedal
- move the transmission out of position **P**

- i** Shifting the transmission to position **P** does not start the engine.

- i** If you shift the transmission from **R** to **D**, the ECO start/stop function is available again once the **ECO** symbol reappears in green in the multifunction display.

Deactivating/activating the ECO start/stop function

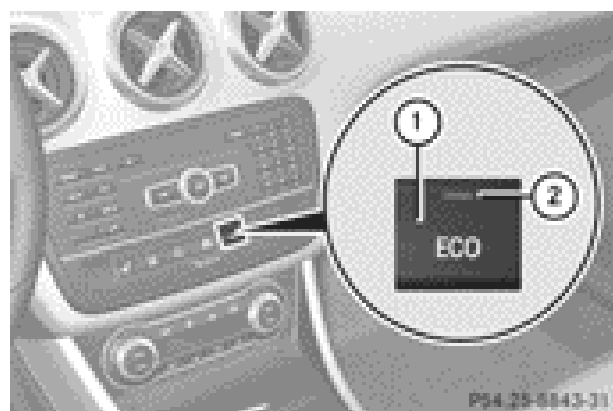

ECO button

- ▶ **To switch off:** press button ①. Indicator lamp ② and the **ECO** symbol in the multifunction display go out.

- ▶ **To switch on:** press button ①. Indicator lamp ② lights up.

If all conditions for automatic engine switch-off (▷ page 146) are met, the **ECO** symbol is shown in green in the multifunction display.

If not all conditions for automatic engine switch-off (▷ page 146) are met, the **ECO** symbol is shown in yellow in the multifunction display. If this is the case, the ECO start/stop function is not available.

- i** If indicator lamp ② is off, the ECO start/stop function has been deactivated manually or as the result of a malfunction. The engine will then not be switched off automatically when the vehicle stops.

Problems with the engine

Problem	Possible causes/consequences and ► Solutions
The engine does not start.	<p>The HOLD function or DISTRONIC PLUS is activated.</p> <ul style="list-style-type: none"> ► Deactivate the HOLD function (▷ page 179) or DISTRONIC PLUS (▷ page 173). ► Try to start the engine again.
The engine does not start. The starter motor can be heard.	<ul style="list-style-type: none"> • There is a malfunction in the engine electronics. • There is a malfunction in the fuel supply. <ul style="list-style-type: none"> ► Turn the key back to position 0 in the ignition lock before attempting to start the engine again. ► Try to start the engine again (▷ page 143). Avoid excessively long and frequent attempts to start the engine, as this will drain the battery. <p>If the engine does not start after several attempts:</p> <ul style="list-style-type: none"> ► Consult a qualified specialist workshop.
The engine does not start. The starter motor can be heard. The reserve fuel warning lamp is lit and the fuel gauge display shows 0 .	<p>The fuel tank is empty.</p> <ul style="list-style-type: none"> ► Refuel the vehicle.
The engine does not start. You cannot hear the starter motor.	<p>The on-board voltage is too low because the battery is too weak or discharged.</p> <ul style="list-style-type: none"> ► Jump-start the vehicle (▷ page 308). <p>If the engine does not start despite attempts to jump-start it:</p> <ul style="list-style-type: none"> ► Consult a qualified specialist workshop. <p>The starter motor was exposed to a thermal load that was too high.</p> <ul style="list-style-type: none"> ► Allow the starter motor to cool down for approximately two minutes. ► Try to start the engine again. <p>If the engine still does not start:</p> <ul style="list-style-type: none"> ► Consult a qualified specialist workshop, e.g. a Mercedes-Benz Service Centre.

Problem	Possible causes/consequences and ► Solutions
Vehicles with a petrol engine: The engine is not running smoothly and is misfiring.	There is a malfunction in the engine electronics or in a mechanical component of the engine management system. <ul style="list-style-type: none"> ► Only depress the accelerator pedal slightly. Otherwise, non-combusted fuel may get into the catalytic converter and damage it. ► Have the cause rectified immediately at a qualified specialist workshop.
The coolant temperature display is showing more than 120 °C. The coolant warning lamp may also be on and a warning tone may sound.	The coolant level is too low. The coolant is too hot and the engine is no longer being cooled sufficiently. <ul style="list-style-type: none"> ► Stop as soon as possible and allow the engine and the coolant to cool down. ► Check the coolant level (► page 288). Observe the warning notes as you do so and top up the coolant if necessary. <p>If the coolant level is correct, the engine radiator fan may be faulty. The coolant is too hot and the engine is no longer being cooled sufficiently.</p> <ul style="list-style-type: none"> ► If the coolant temperature is below 120 °C, you can continue driving to the nearest qualified specialist workshop. ► Avoid heavy loads on the engine as you do so, e.g. driving in mountainous terrain and stop-start traffic.

Manual transmission

Gear lever

- ! Only engage gear when the clutch pedal is depressed.
 - ! When shifting to **5th** and **6th** gear, you must press the shift lever to the right. Otherwise, you could shift unintentionally into **3rd** or **4th** gear and damage the engine or transmission.
- If you shift down at too high a speed (transmission braking), this can cause the engine to overrev, leading to engine damage.
- Do not use the clutch bite point to keep the vehicle stationary on uphill gradients. There is otherwise a risk of damaging the clutch.
- ! On long and steep downhill gradients, especially if the vehicle is laden or towing

a trailer, you must shift into gear **1**, **2** or **3** in good time. This uses the engine's braking effect. This relieves the load on the brake system and prevents the brakes from overheating and wearing too quickly.

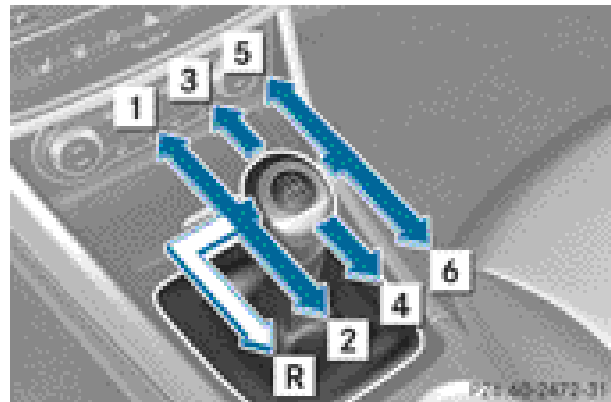

Gear lever

R Reverse gear

1 to **6** Forward gears

Shifting to neutral (N)



- ▶ Depress the clutch pedal fully.
- ▶ Move the gear lever to position **N** ①.

Engaging reverse gear

- ❗ Only shift into reverse gear **R** when the vehicle is stationary. Otherwise, you could damage the transmission.
- ▶ Pull the gear lever up, push it to the left and then pull it back.
- i The ECO start/stop function is not available when reverse gear is engaged.
For further information on the ECO start/stop function, see (▷ page 146).

Gearshift recommendation

The gearshift recommendations assist you in adopting an economical driving style. The recommended gear is shown in the multifunction display.

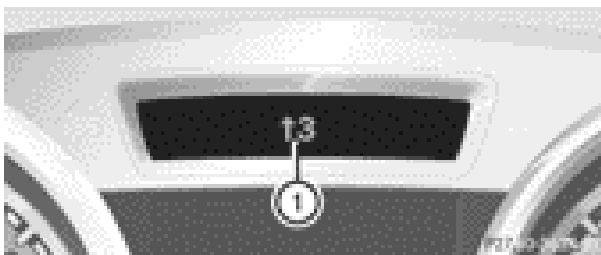

- ▶ Shift gear according to gearshift recommendation ① when shown in the multifunction display of the instrument cluster.

Automatic transmission

Important safety notes

⚠ WARNING

If the engine speed is above the idling speed and you engage transmission position **D** or **R**, the vehicle could pull away suddenly. There is a risk of an accident.

When engaging transmission position **D** or **R**, always firmly depress the brake pedal and do not simultaneously accelerate.

⚠ WARNING

The automatic transmission switches to neutral position **N** when you switch off the engine. The vehicle may roll away. There is a risk of an accident.

After switching off the engine, always switch to parking position **P**. Prevent the parked vehicle from rolling away by applying the parking brake.

- i Bear in mind that the power transmission between the engine and the transmission is interrupted when the engine is switched off.

To prevent the vehicle from rolling away:

- when the engine is switched off and the vehicle is stationary, shift the automatic transmission to park position **P** and
- apply the electric parking brake

DIRECT SELECT lever

Overview of transmission positions

All vehicles (except AMG vehicles): the DIRECT SELECT lever is on the right of the steering column.

Information about the selector lever on AMG vehicles (▷ page 153).

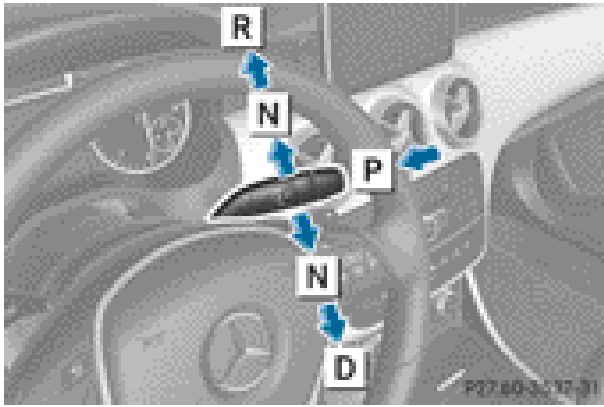

- P** Park position with parking lock
- R** Reverse gear
- N** Neutral
- D** Drive

- i** The DIRECT SELECT lever always returns to its original position. The current transmission position **P**, **R**, **N** or **D** appears in the transmission position display (▷ page 152) in the multifunction display.

Transmission position and drive program display

The current transmission position and drive program appear in the multifunction display.



- ① Transmission position display
- ② Drive program display

- i** The arrows in the transmission position display show how and into which transmission positions you can change using the DIRECT SELECT lever.

- !** If the transmission position display in the multifunction display is not working, you should pull away carefully to check whether the desired transmission position is engaged. Ideally, you should select transmission position **D** and drive program **E** or **S**.

Engaging park position P

- ▶ Push the DIRECT SELECT lever in the direction of arrow **P**.

Transmission position display **P** is shown in the multifunction display.

- i** When you engage park position **P**, make sure that the transmission position display shows **P** in the multifunction display.
- i** You can only engage park position **P** when the vehicle is stationary.
- i** The automatic transmission shifts into park position **P** automatically:
 - if you open the driver's door while the vehicle is stationary in transmission position **D** or **R**
 - if you open the door while travelling at very low speeds in transmission position **D** or **R**

In addition, a warning tone sounds and a display message is shown.

- i** Depressing the brake and pushing the DIRECT SELECT lever up or down disengages the parking lock. The transmission is in **N** neutral.

At transmission fluid temperatures below -20°C , you can only shift out of park position **P** into another transmission position when the engine is running.

In order to shift from park position **P** directly into **R** or **D**:

- depress the brake pedal and
- push the DIRECT SELECT lever up or down past the first point of resistance

- !** If the engine speed is too high, do not shift the automatic transmission directly from **D** to **R**, from **R** to **D** or directly to **P**. Otherwise, the automatic transmission could be damaged.

Engaging reverse gear R

- ❗ Only shift the automatic transmission to **R** when the vehicle is stationary.
- i The ECO start/stop function is not available when reverse gear is engaged. For further information on the ECO start/stop function, see (▷ page 146).
- ▶ Depress the brake pedal while the vehicle is stationary.
- ▶ Push the DIRECT SELECT lever up past the first point of resistance.

Shifting to neutral (N)

- ▶ Push the DIRECT SELECT lever up or down to the first point of resistance.

Engaging drive position D

- ▶ Depress the brake pedal while the vehicle is stationary.
- ▶ Push the DIRECT SELECT lever down past the first point of resistance.

Selector lever

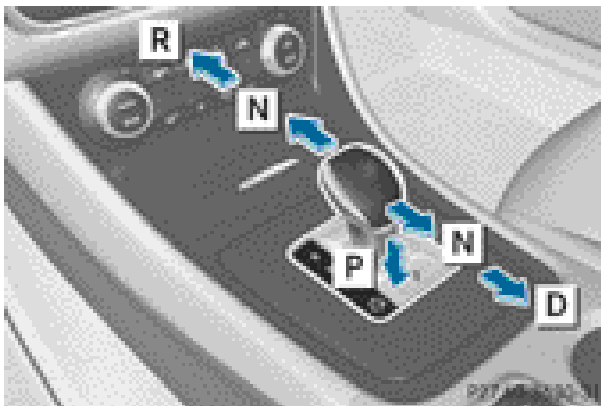

Selector lever in AMG vehicles with P button

- P** Park position with parking lock
- R** Reverse gear
- N** Neutral
- D** Drive

Transmission position and drive program display

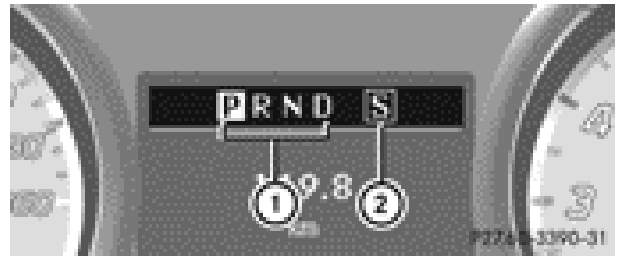

Example

- ① Transmission position display
- ② Drive program display

The current transmission position and drive program appear in the multifunction display.

Engaging park position P

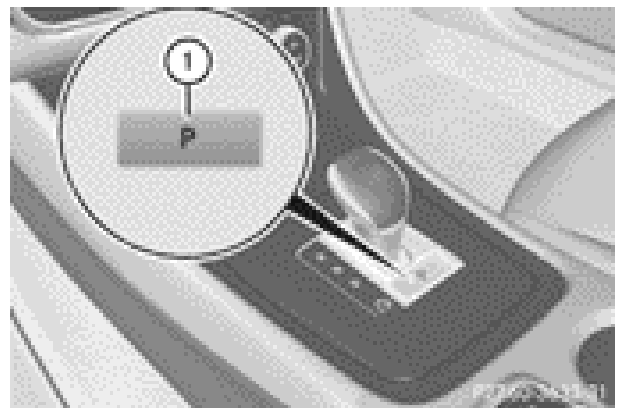

- ▶ When the vehicle is stationary, press **P** button ①.

Transmission positions

- P** **Park position**
This prevents the vehicle from rolling away when stopped. Do not shift the transmission into position **P** unless the vehicle is stationary.
- R** **Reverse gear**
Only shift the transmission to **R** when the vehicle is stationary.

N	<p>Neutral</p> <p>No power is transmitted from the engine to the drive wheels.</p> <p>Releasing the brakes will allow you to move the vehicle freely, e.g. to push it or tow it.</p> <p>If ESP® is deactivated or faulty: only shift the transmission to position N if the vehicle is in danger of skidding, e.g. on icy roads.</p> <p>When you switch off the engine, the automatic transmission automatically shifts into neutral N.</p>
D	<p>Drive</p> <p>The automatic transmission changes gear automatically. All forward gears are available.</p>

Changing gear

The automatic transmission shifts to the individual gears automatically when it is in transmission position **D**. Gearshifting is determined by:

- the selected drive program (▷ page 155)
- the position of the accelerator pedal
- the road speed

Driving tips

Accelerator pedal position

Your style of driving influences how the automatic transmission shifts gear:

- little throttle: early upshifts
- more throttle: late upshifts

Holding the vehicle stationary on uphill gradients

WARNING

If the clutch overheats, the electronic management system is automatically deactivated.

This interrupts the power transmission. The vehicle may, for example, roll backwards on gradients. There is a risk of an accident.

Never hold the vehicle stationary on uphill gradients by depressing the accelerator.

The clutch may overheat if you hold the vehicle stationary on uphill gradients by depressing the accelerator pedal. If the clutch overheats, a warning tone sounds.

All vehicles (except AMG vehicles): the **Stop vehicle Shift to P Leave engine running** display message appears in the multifunction display. You will only be able to continue your journey once the clutch has cooled down and the display message in the multifunction display has disappeared.

AMG vehicles: the **Trans. oil overheated Drive on with care** display message appears in the multifunction display.

Do not hold the vehicle stationary on uphill gradients by depressing the accelerator pedal. Instead, only ever hold the vehicle stationary on uphill gradients by:

- depressing the brake pedal
- activating the HOLD function
- engaging the electric parking brake

Kickdown

AMG vehicles: it is only possible to use kickdown in temporary manual drive program **M**. For further information on the manual drive program **M**, see (▷ page 156).

Use kickdown for maximum acceleration:

- ▶ Depress the accelerator pedal beyond the pressure point.
The transmission shifts to a lower gear depending on the engine speed.
- ▶ Ease off the accelerator pedal once the desired speed is reached.
The automatic transmission shifts back up.

Towing a trailer

Trailer towing is not permissible on the following models:

- A 45 AMG 4MATIC
- Vehicles with the AMG Sports package
- ▶ Drive in the middle of the engine speed range on uphill gradients.
- ▶ Depending on the uphill or downhill gradient, select a lower gear (▷ page 166), even if cruise control, DISTRONIC PLUS, or SPEEDTRONIC are activated.

Program selector button

General notes

The program selector button allows you to choose between drive programs with different driving characteristics.

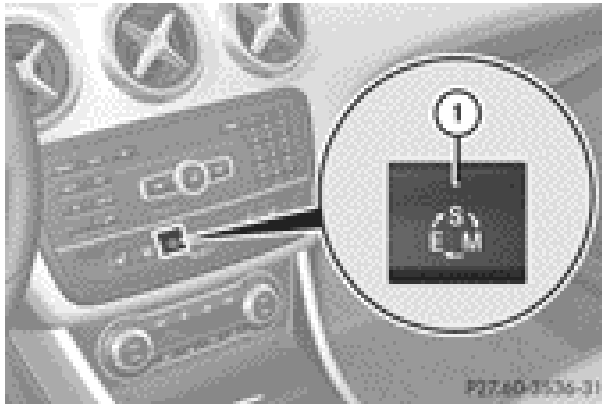

Example: program selector button

E Economy	Comfortable, economical driving
S Sport	Sporty driving style
M Manual	Manual gearshifting

- ▶ Press program selector button ① repeatedly until the letter for the desired gearshift program appears in the multifunction display.

- ① The automatic transmission switches to automatic drive program **E** each time the engine is started.

- ① For further information on the automatic drive program, see (▷ page 156).

AMG vehicles



C Controlled Efficiency	Comfortable, economical driving
S Sport	Sporty driving style
M Manual	Manual gearshifting

- ▶ Press program selector button ① repeatedly until the letter for the desired gearshift program appears in the multifunction display.

- ① The automatic transmission switches to automatic drive program **C** each time the engine is started.
- ① For further information on the automatic drive program, see (▷ page 156).

Steering wheel gearshift paddles

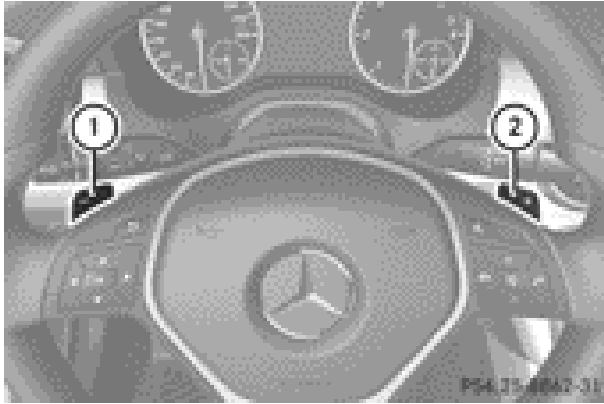

- ① Left steering wheel gearshift paddle (shifts down)
- ② Right steering wheel gearshift paddle (shifts up)

In drive program **M**, you can change gear yourself using the steering wheel gearshift paddles.

If you pull the left or right steering wheel gearshift paddle when in automatic drive program **E** (drive program **C** on AMG vehicles) or **S**, the automatic transmission shifts into drive program **M** for a limited time. Depending on which gearshift paddle is pulled, the automatic transmission immediately shifts into the next gear down or up.

AMG vehicles: you can activate drive program **M** RACE START (▷ page 181) using the steering wheel gearshift paddles.

- i** You can only change gear with the steering wheel gearshift paddles when the transmission is in position **D**.
- i** For further information on the manual drive program, see (▷ page 156).

Automatic drive program

Drive program **E** (drive program **C** on AMG vehicles) is characterised by the following:

- comfort-oriented engine settings.
- optimal fuel consumption resulting from the automatic transmission shifting up sooner.

- the vehicle pulling away more gently in forward and reverse gears unless the accelerator pedal is depressed fully.
- increased sensitivity. This improves driving stability on slippery road surfaces, for example.
- the automatic transmission shifting up sooner. This results in the vehicle being driven at lower engine speeds and the wheels being less likely to spin.

Drive program **S** is characterised by the following:

- sporty engine settings.
- the automatic transmission shifting up later.
- as a result of the later automatic transmission shift points, the fuel consumption possibly being higher.

Manual drive program

Introduction

In manual drive program **M**, you can change gear yourself by using the steering wheel gearshift paddles. For this, the transmission must be in position **D**. The gear currently selected and engaged is shown in the multi-function display.

Manual drive program **M** differs from drive programs **E** (drive program **C** on AMG vehicles) and **S** with regard to spontaneity, responsiveness and smoothness of gear changes.

Gear	Driving situations
3	To use the engine's braking effect

2 To use the braking effect of the engine on downhill gradients and for driving:

- on steep mountain roads
- in mountainous terrain
- in arduous conditions

1 To use the braking effect of the engine on extremely steep downhill gradients and on long downhill stretches

Activating the manual drive program

Activating permanently

- ▶ Press the program selector button (▷ page 155) repeatedly until **M** appears in the multifunction display. Manual drive program **M** remains active until drive program **E** (drive program **C** on AMG vehicles) or **S** is engaged.

Activating temporarily

- ▶ Pull the right or left steering wheel gearshift paddle (▷ page 156). **M** is shown in the multifunction display. Manual drive program **M** is temporarily active. Depending on which gearshift paddle is pulled, the automatic transmission immediately shifts into the next gear down or up.

- i** When manual drive program **M** is activated via the steering wheel gearshift paddles, the temporarily active manual drive program **M** will be deactivated automatically after a limited time, if the driving situation permits. The automatic transmission switches to the previously activated drive program **E** (drive program **C** on AMG vehicles) or **S**. When driving on downhill gradients, the temporarily active manual drive program **M** will only be deactivated if the accelerator pedal is depressed while the vehicle is rolling downhill.

Shifting up

- ▶ Pull the right-hand steering wheel gearshift paddle (▷ page 156). The automatic transmission shifts up to the next gear.

- i** **All vehicles (except AMG vehicles):** in order to prevent engine damage the automatic transmission automatically shifts up:
 - if the maximum engine speed on the currently engaged gear is reached and
 - you depress the accelerator pedal.

AMG vehicles:

- !** In manual gearshift program **M**, the automatic transmission does not shift up automatically even when the engine limiting speed for the current gear is reached. When the engine limiting speed is reached, the fuel supply is cut to prevent the engine from overrevving. You must make sure that the engine speed does not reach the red area of the rev counter. Otherwise, there is a risk of engine damage.

AMG vehicles

- !** In manual gearshift program **M**, the automatic transmission does not shift up automatically even when the engine limiting speed for the current gear is reached. When the engine limiting speed is reached, the fuel supply is cut to prevent the engine from overrevving. You must make sure that the engine speed does not reach the red area of the rev counter. Otherwise, there is a risk of engine damage.

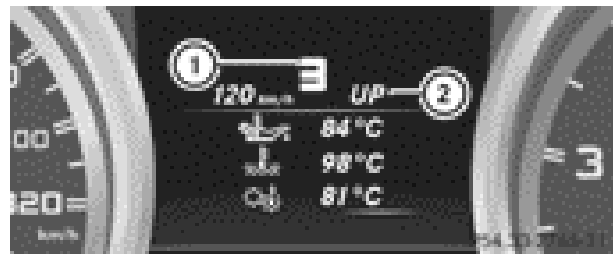

- ① Gear indicator
- ② Upshift indicator

Before the engine speed reaches the red area, an upshift indicator will be shown in the multifunction display.

- ▶ If the colour in the speedometer multifunction display changes to red and the **UP** display message is shown, shift up a gear.

Downshifting

- ▶ Pull the left-hand steering wheel gearshift paddle (▷ page 156).
The automatic transmission shifts down to the next gear.

- i** If you slow down or stop without shifting down, the automatic transmission automatically shifts down.
- i** For maximum acceleration, pull the left-hand steering wheel gearshift paddle until the transmission selects the optimum gear for the current speed.
- i** If the engine exceeds the maximum engine speed when shifting down, the automatic transmission protects against engine damage by not shifting down.

Kickdown

AMG vehicles: it is only possible to use kickdown in temporary manual drive program **M**.

You can also use kickdown for maximum acceleration in manual drive program **M**.

- ▶ Depress the accelerator pedal beyond the pressure point.
The transmission shifts to a lower gear depending on the engine speed.
- ▶ Shift back up once the desired speed is reached.
- i** During kickdown, you cannot shift gears using the steering wheel gearshift paddles.
- i** If you apply full throttle, the automatic transmission shifts up to the next gear when the maximum engine speed is reached. This prevents the engine from overrevving.

Deactivating the manual drive program

- ▶ Press the program selector button (▷ page 155) repeatedly until **E** or **S** appears in the multifunction display.

Deactivating the temporary manual drive program

- ▶ Pull and hold the right steering wheel gearshift paddle until the automatic transmission shifts into the last active automatic drive program **E** (drive program **C** on AMG vehicles) or **S**.
- i** When manual drive program **M** is deactivated, the automatic transmission in automatic drive program **E** (drive program **C** on AMG vehicles) or **S** may shift from the current gear into a higher or lower gear. This is dependent on the position of the accelerator pedal, speed and load.

Problems with the transmission

Problem	Possible causes/consequences and ► Solutions
The transmission has problems shifting gear.	The transmission is losing oil. ► Have the transmission checked at a qualified specialist workshop immediately.
The acceleration ability is deteriorating. The transmission no longer shifts into all of the gears. Reverse gear can no longer be engaged.	The transmission is in emergency mode. ► Stop. ► Shift the transmission to position P . ► Switch off the engine. ► Wait at least 10 seconds before restarting the engine. ► Shift the transmission to position D . ► Have the transmission checked at a qualified specialist workshop immediately.

Refuelling

Important safety notes

WARNING

Fuel is highly flammable. If you handle fuel incorrectly, there is a risk of fire and explosion.

You must avoid fire, naked flames, creating sparks and smoking. Switch off the engine and, if applicable, the auxiliary heating before refuelling.

WARNING

Fuels are poisonous and hazardous to health. There is a danger of injury.

Do not swallow fuel or let it come into contact with skin, eyes or clothing. Do not inhale fuel vapours. Keep fuels out of the reach of children.

If you or others come into contact with fuel, observe the following:

- Wash the fuel off any affected areas of skin with water and soap immediately.
- If you get fuel in your eyes, rinse them thoroughly with clean water immediately. Seek immediate medical attention.

- If fuel is swallowed, seek immediate medical attention. Do not induce vomiting.
- Change any clothing that has come into contact with fuel immediately.

WARNING

Electrostatic charge can cause sparks and thereby ignite fuel vapours. There is a risk of fire and explosion.

Always touch the vehicle body before opening the fuel filler flap or touching the fuel pump nozzle. This discharges any electrostatic charge that may have built up.

WARNING

Vehicles with a diesel engine:

If you mix diesel fuel with petrol, the flash point of this fuel mixture is lower than that of pure diesel fuel. When the engine is running, components in the exhaust system may overheat unnoticed. There is a risk of fire.

Never refuel with petrol. Never add petrol to diesel fuel.

- ❗ Do not use petrol to refuel vehicles with a diesel engine. Do not use diesel to refuel vehicles with a petrol engine. Do not switch

on the ignition if you accidentally refuel with the wrong fuel. Otherwise, the fuel will enter the fuel system. Even small amounts of the wrong fuel could result in damage to the fuel system and the engine. The repair costs are high. Notify a qualified specialist workshop and have the fuel tank and fuel lines drained completely.

- ❗ Overfilling the fuel tank could damage the fuel system.
- ❗ Take care not to spill any fuel on painted surfaces. You could otherwise damage the paintwork.
- ❗ Use a filter when adding fuel from a fuel can. The fuel lines and/or the diesel injection system could otherwise be blocked by particles from the fuel can.

Do not get into the vehicle again during the refuelling process. Otherwise, electrostatic charge could build up again.

If you overfill the fuel tank, some fuel may spray out when you remove the fuel pump nozzle.

For further information on fuel and fuel quality (▷ page 339).

Refuelling

Opening/closing the fuel filler flap

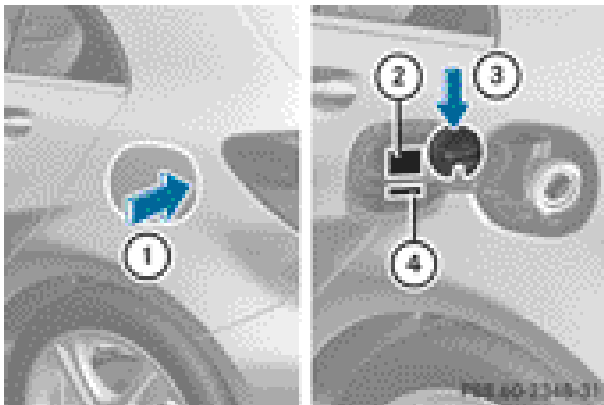

- ① To open the fuel filler flap
- ② Tyre pressure table
- ③ To insert the fuel filler cap
- ④ Fuel type to be refuelled

The fuel filler flap is unlocked or locked automatically when you open or close the vehicle with the key.

The position of the fuel filler cap is displayed  in the instrument cluster. The arrow next to the filling pump indicates the side of the vehicle.

Opening

- ▶ Switch off the engine.
- ▶ Remove the key from the ignition lock.
- ▶ Press the fuel filler flap in the direction of arrow ①.
The fuel filler flap swings up.
- ▶ Turn the fuel filler flap anti-clockwise and remove it.
- ▶ Insert the fuel filler cap into holder on the inside of fuel filler flap ③.
- ▶ Completely insert the filler neck of the fuel pump nozzle into the tank, hook in place and refuel.
- ▶ Only fill the tank until the pump nozzle switches off.
- ❗ Do not add any more fuel after the pump stops filling for the first time. Otherwise, fuel may leak out.

Closing

- ▶ Replace the cap on the filler neck and turn clockwise until it engages audibly.
- ▶ Close the fuel filler flap.
- ❗ Close the fuel filler flap before locking the vehicle.

Problems with the fuel and fuel tank

Problem	Possible causes/consequences and ► Solutions
Fuel is leaking from the vehicle.	<p>The fuel line or the fuel tank is faulty.</p> <p> WARNING</p> <p>Risk of explosion or fire.</p> <ul style="list-style-type: none"> ► Turn the key to position 0 in the ignition lock and remove it immediately (▷ page 143). ► Do not restart the engine under any circumstances. ► Consult a qualified specialist workshop.
The engine does not start.	<p>The fuel tank of a vehicle with a diesel engine has been run completely dry.</p> <ul style="list-style-type: none"> ► Refuel the vehicle with at least 5 litres of diesel. ► Turn the ignition on for approximately ten seconds (▷ page 143). ► Start the engine continuously for a maximum of ten seconds until it runs smoothly. <p>or</p> <ul style="list-style-type: none"> ► Start the engine using the touch-start function. To do this, turn the key to position 3 in the ignition lock and then release it immediately (▷ page 143). <p>If the engine does not start:</p> <ul style="list-style-type: none"> ► Turn the ignition on again a maximum of ten seconds (▷ page 143). ► Start the engine again continuously for a maximum of ten seconds until it runs smoothly. <p>or</p> <ul style="list-style-type: none"> ► Start the engine again via the touch-start function. <p>If the engine does not start after three attempts:</p> <ul style="list-style-type: none"> ► Consult a qualified specialist workshop.

Problem	Possible causes/consequences and ► Solutions
The fuel filler flap cannot be opened.	The fuel filler flap is not unlocked. or The key battery is discharged. ► Unlock the vehicle (▷ page 75). or ► Unlock the vehicle using the emergency key element (▷ page 75).
	The fuel filler flap is unlocked, but the opening mechanism is jammed. ► Consult a qualified specialist workshop.

Parking

Important safety notes

WARNING

Flammable material such as leaves, grass or twigs may ignite if they come into contact with hot parts of the exhaust system or exhaust gas flow. There is a risk of fire.

Park the vehicle so that no flammable material can come into contact with hot vehicle components. In particular, do not park on dry grassland or harvested grain fields.

WARNING

If you leave children unattended in the vehicle, they may be able to set the vehicle in motion if, for example, they:

- release the parking brake
- shift the automatic transmission out of park position **P** or shift manual transmission into neutral
- start the engine

In addition, they may operate vehicle equipment and become trapped. There is a risk of an accident and injury.

When leaving the vehicle, always take the key with you and lock the vehicle. Never leave children unattended in the vehicle.

 Always secure the vehicle correctly against rolling away. Otherwise, the vehicle or its drivetrain could be damaged.

To ensure that the vehicle is secured against rolling away unintentionally:

- the electric parking brake must be applied.
- on vehicles with manual transmission, engage first gear or reverse gear.
- on vehicles with automatic transmission, the transmission must be in position **P** and the transmission position display must show **P** in the multifunction display.
- the key must be removed from the ignition lock.
- on uphill or downhill gradients, the front wheels must be turned towards the kerb.

Switching off the engine

Important safety notes

WARNING

The automatic transmission switches to neutral position **N** when you switch off the engine. The vehicle may roll away. There is a risk of an accident.

After switching off the engine, always switch to parking position **P**. Prevent the parked vehi-

cle from rolling away by applying the parking brake.

Vehicles with manual transmission

- ▶ Shift to either first gear or reverse gear **R**.
- ▶ Turn the key to position **0** in the ignition lock and remove it.
The immobiliser is activated.
- ▶ Apply the electric parking brake.

Vehicles with automatic transmission

All vehicles (except AMG vehicles)

- ▶ Apply the electric parking brake.
- ▶ Shift the transmission to position **P**.

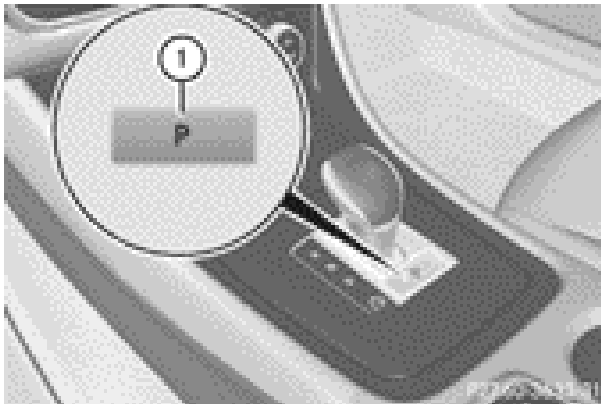

Selector lever in AMG vehicles

AMG vehicles:

- ▶ Apply the electric parking brake.
 - ▶ Press **P** button ①.
 - ▶ Turn the key to position **0** in the ignition lock and remove it.
The immobiliser is activated.
- i** If you switch the engine off with the transmission in position **R** or **D**, the automatic transmission shifts to **N** automatically. If you then open one of the front doors or remove the key from the ignition, the automatic transmission shifts to **P**. If you shift the automatic transmission to **N** before switching off the engine, the automatic transmission remains in **N** even if a door is opened.

Electric parking brake

General notes

WARNING

If you leave children unattended in the vehicle, they could set the vehicle in motion by, for example:

- releasing the parking brake
- shifting an automatic transmission out of parking position **P**
- shifting a manual transmission into neutral
- starting the engine

They could also operate vehicle equipment. There is a risk of an accident and injury.

When leaving the vehicle, always take the key with you and lock the vehicle. Never leave children unattended in the vehicle.

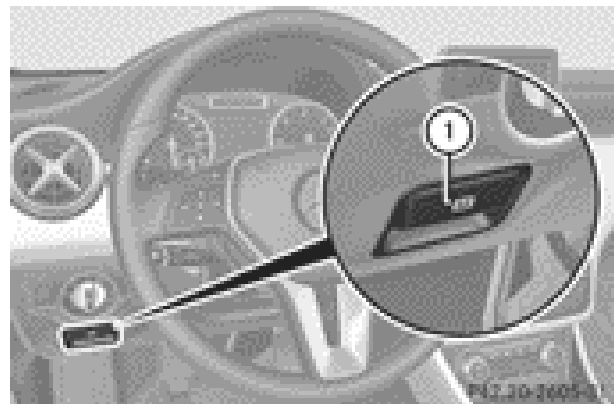

- i** The electric parking brake carries out a function check at regular intervals when the engine is switched off. Noises that occur are normal.

Engaging/releasing manually

Engaging

- ▶ Push handle ①.
When the electric parking brake is applied, the  red indicator lamp lights up in the instrument cluster.
- i** The electric parking brake can also be applied when the key is removed.

Releasing

- ▶ Pull handle ①.

The red  indicator lamp in the instrument cluster goes out.

- i** You can only release the electric parking brake when the key is in position **1** or **2** in the ignition lock.

Applying automatically

The electric parking brake is applied automatically:

- if DISTRONIC PLUS brings the vehicle to a standstill (vehicles with automatic transmission) or
- if the HOLD function is keeping the vehicle stationary.

In addition, at least one of the following conditions must be fulfilled:

- the engine is switched off
- the driver's door is open and the seat belt is not fastened
- there is a system malfunction
- the power supply is insufficient
- the vehicle is stationary for a lengthy period.

The red  indicator lamp in the instrument cluster lights up.

- i** The electric parking brake is not automatically applied if the engine is switched off by the ECO start/stop function.

Releasing automatically

- i** The electric parking brake can only be released automatically in vehicles with automatic transmission.

The electric parking brake of your vehicle is released automatically when all of the following conditions are fulfilled:

- the engine is running.
- the transmission is in position **D** or **R**.
- the seat belt is fastened.
- you depress the accelerator pedal.

If the transmission is in position **R**, the tailgate must be closed.

If your seat belt is not fastened, the following conditions must be fulfilled to automatically release the electric parking brake:

- the driver's door is closed.
- you have shifted out of transmission position **P** or you have previously driven faster than 3 km/h.

Emergency braking

The vehicle can also be braked during an emergency using the electric parking brake.

- ▶ While driving, push handle ① of the electric parking brake (▷ page 163).

- i** The vehicle is braked for as long as handle ① of the electric parking brake pressed. The longer the electric parking brake handle ① is depressed, the greater the braking force.

During braking:

- a warning tone sounds
- the **Release parking brake** message appears
- the red  indicator lamp in the instrument cluster flashes

When the vehicle has been braked to a standstill, the electric parking brake is engaged.

Parking up the vehicle

If you leave the vehicle parked up for longer than four weeks, the battery may be damaged by exhaustive discharging.

If you leave the vehicle parked up for longer than six weeks, the vehicle may suffer damage as a result of lack of use.

- ▶ Visit a qualified specialist workshop and seek advice.

- i** You can obtain information about trickle chargers from a qualified specialist workshop.

Driving tips

General notes

WARNING

If you switch off the ignition while driving, safety-relevant functions are only available with limitations, or not at all. This could affect, for example, the power steering and the brake boosting effect. You will require considerably more effort to steer and brake. There is a risk of an accident.

Do not switch off the ignition while driving.

ECO display

The ECO display provides feedback on how economical your driving characteristics are. The ECO display assists you in achieving the most economical driving style for the selected settings and prevailing conditions. Consumption can be significantly influenced by your driving style.



Example: ECO display

The ECO display consists of three bars:

- **Acceleration**
- **Constant**
- **Coasting**

The percentage count is the mean value of the three bar values. The three bars and the mean value begin at the value of 50%. A higher percentage count indicates a more economical driving style.

The ECO display does not indicate the actual fuel consumption and a fixed percentage count in the ECO display does not indicate a fixed consumption figure.

In addition to driving style, the consumption is affected by many other factors, such as:

- load
- tyre pressure
- cold start
- choice of route
- the use of electrical consumers

These factors are not included in the ECO display.

The evaluation of your driving style takes the following three categories into consideration:

- **Acceleration** (evaluation of all acceleration processes):
 - The bar fills up: moderate acceleration, especially at higher speeds
 - The bar empties: sporty acceleration
- **Constant** (assessment of driving behaviour at all times):
 - The bar fills up: constant speed and avoidance of unnecessary acceleration and deceleration
 - The bar empties: fluctuations in speed
- **Coasting** (assessment of all deceleration processes):
 - The bar fills up: anticipatory driving, keeping your distance and early release of the accelerator. The vehicle can coast without use of the brakes
 - The bar empties: frequent braking

i An economical driving style involves driving at a moderate engine speed.

To achieve a higher value in the categories **Acceleration** and **Constant**:

- observe the gearshift recommendation.
- drive the vehicle in drive program **E** (vehicles with automatic transmission).

i On long journeys at a constant speed, e.g. on the motorway, only the bar for **Constant** will change.

i The ECO display summarises the driving characteristics from the start of the journey to its completion. Therefore, there are

dynamic changes in the bars at the start of a journey. During a prolonged driving time, these changes are smaller. For more dynamic changes, perform a manual reset.

For further information on the ECO display, see (▷ page 212).

Braking

Important safety notes

WARNING

If you shift down on a slippery road surface in an attempt to increase the engine's braking effect, the drive wheels could lose their grip. This increases the risk of skidding and having an accident.

Do not shift down for additional engine braking on a slippery road surface.

Downhill gradients

Change into a lower gear in good time on long and steep downhill gradients. Take particular note of this when driving a laden vehicle and when towing a trailer. For vehicles with automatic transmission, you need to have selected manual drive program **M** (▷ page 156).

-  This also applies if you have activated cruise control, SPEEDTRONIC or DISTRONIC PLUS.

This will use the braking effect of the engine, so less braking will be required to prevent the vehicle from gaining speed. This relieves the load on the brake system and prevents the brakes from overheating and wearing too quickly.

-  Briefly depressing the accelerator pedal on downhill gradients while the manual drive program **M** is temporarily activated (vehicles with automatic transmission): the automatic transmission may switch back to the last active automatic drive program **E** or **S**. The automatic transmission may shift

to a higher gear. This can reduce the engine's braking effect.

Heavy and light loads

WARNING

The braking system can overheat if you leave your foot on the brake pedal while driving. This increases the braking distance and could even cause the braking system to fail. There is a risk of an accident.

Never use the brake pedal as a footrest. Do not simultaneously depress both the brake pedal and the accelerator pedal while driving.

-  Depressing the brake pedal constantly results in excessive and premature wear to the brake pads.

If heavy demands are made on the brakes, do not park the vehicle immediately. Drive on for a short while. This allows the airflow to cool the brakes more quickly.

If the brakes have been used only moderately, you should occasionally test their effectiveness. To do this, brake more firmly from a higher speed, paying attention to traffic conditions. This improves the grip of the brakes.

Wet road surfaces

If you have driven for a long time in heavy rain without braking, there may be a delayed reaction from the brakes when braking for the first time. This may also occur after a car wash or after driving through deep water.

You have to depress the brake pedal more firmly. Maintain a greater distance from the vehicle in front.

After driving on a wet road or having the vehicle washed, brake firmly while paying attention to the traffic conditions. This will warm up the brake discs, thereby drying them more quickly and protecting them against corrosion.

Limited braking performance on salt-treated roads

If you drive on salted roads, a layer of salt residue may form on the brake discs and brake pads. This can result in a significantly longer braking distance.

- Brake occasionally to remove any possible salt residue. Make sure that you do not endanger other road users when doing so.
- Carefully depress the brake pedal at the beginning and end of a journey.
- Maintain a greater distance to the vehicle ahead.

New brake pads/linings

New and replaced brake pads and discs only reach their optimum braking effect after several hundred kilometres of driving. Compensate for this by applying greater force to the brake pedal.

For safety reasons, Mercedes-Benz recommends that you only have brake pads/linings fitted to your vehicle which have been approved for Mercedes-Benz vehicles or which correspond to an equivalent quality standard. Brake pads/linings which have not been approved for Mercedes-Benz vehicles or which are not of an equivalent quality could affect your vehicle's operating safety.

Driving on wet roads

Aquaplaning

If water has accumulated to a certain depth on the road surface, there is a danger of aquaplaning occurring, even if:

- you are driving at low speeds
- the tyres have adequate tread depth

For this reason, do not drive in tyre ruts and brake carefully.

Driving on flooded roads

! Bear in mind that vehicles travelling in front or in the opposite direction create waves. This may cause the maximum permissible water depth to be exceeded.

These notes must be observed under all circumstances. You could otherwise damage the engine, the electronics or the transmission.

If you have to drive on stretches of road on which water has collected, please bear in mind that:

- the maximum permissible fording depth in still water is 25 cm
- you should drive no faster than walking pace

Winter driving

General notes

WARNING

If you shift down on a slippery road surface in an attempt to increase the engine's braking effect, the drive wheels could lose their grip. This increases the risk of skidding and having an accident.

Do not shift down for additional engine braking on a slippery road surface.

DANGER

If the exhaust pipe is blocked or adequate ventilation is not possible, poisonous gases such as carbon monoxide (CO) may enter the vehicle. This is the case, e.g. if the vehicle becomes trapped in snow. There is a risk of fatal injury.

If you leave the engine or the auxiliary heating running, make sure the exhaust pipe and area around the vehicle are clear of snow. To ensure an adequate supply of fresh air, open a window on the side of the vehicle that is not facing into the wind.

Have your vehicle winterproofed at a qualified specialist workshop at the onset of winter. Observe the notes in the "Winter operation" section (▷ page 320).

Driving with summer tyres

Observe the notes in the "Winter operation" section (▷ page 320).

Slippery road surfaces

WARNING

If you shift down on a slippery road surface in an attempt to increase the engine's braking effect, the drive wheels could lose their grip. This increases the risk of skidding and having an accident.

Do not shift down for additional engine braking on a slippery road surface.

If the vehicle threatens to skid or cannot be stopped when moving at low speed:

- ▶ **Vehicles with manual transmission:** shift to neutral.
- ▶ **Vehicles with automatic transmission:** shift the transmission to position **N**.
- ▶ Try to bring the vehicle under control by using corrective steering.

You should drive particularly carefully on slippery road surfaces. Avoid sudden acceleration, steering and braking manoeuvres.

The outside temperature indicator is not designed to serve as an ice-warning device and is therefore unsuitable for that purpose. Changes in the outside temperature are displayed after a short delay.

Indicated temperatures just above the freezing point do not guarantee that the road surface is free of ice. The road may still be icy, especially in wooded areas or on bridges. You should pay special attention to road conditions when temperatures are around freezing point.

-  For more information on driving with snow chains, see (▷ page 321).

Driving systems

Cruise control

Important safety notes

If you fail to adapt your driving style, cruise control can neither reduce the risk of an accident nor override the laws of physics. Cruise control cannot take into account road, weather or traffic conditions. Cruise control is only an aid. You are responsible for the distance to the vehicle in front, for vehicle speed, for braking in good time, and for staying in the lane.

Do not use cruise control:

- in road and traffic conditions which do not allow you to maintain a constant speed (e.g. in heavy traffic or on winding roads).
- on smooth or slippery roads. Braking or accelerating can cause the drive wheels to lose traction and the vehicle could then skid.
- when there is poor visibility, e.g. due to fog, heavy rain or snow.

If there is a change of drivers, advise the new driver of the speed stored.

General notes

Cruise control maintains a constant road speed for you. It brakes automatically in order to avoid exceeding the set speed. You must select a lower gear in good time on long and steep downhill gradients, especially if the vehicle is laden or towing a trailer. For vehicles with automatic transmission, you need to have selected manual drive program **M** (▷ page 156). By doing so, you will make use of the braking effect of the engine. This relieves the load on the brake system and prevents the brakes from overheating and wearing too quickly.

Use cruise control only if road and traffic conditions make it appropriate to maintain a steady speed for a prolonged period. You can store any road speed above 30 km/h.

Cruise control lever

You can operate cruise control and variable SPEEDTRONIC with the cruise control lever. The LIM indicator lamp on the cruise control lever indicates which system you have selected:

- **LIM indicator lamp off:** cruise control is selected.
- **LIM indicator lamp on:** variable SPEEDTRONIC is selected.

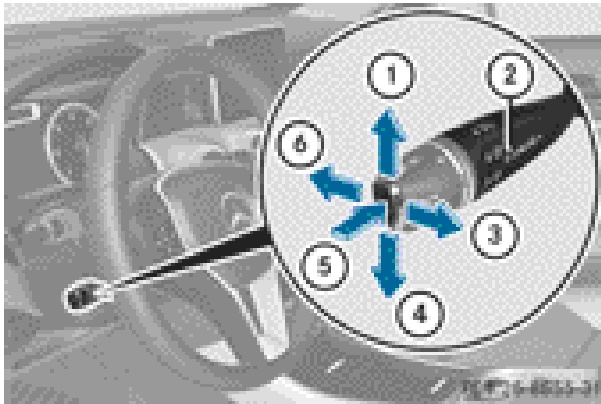

- ① To activate or increase speed
- ② LIM indicator lamp
- ③ To activate at the current speed/last stored speed
- ④ To activate or reduce speed
- ⑤ To switch between cruise control and variable SPEEDTRONIC
- ⑥ To deactivate cruise control

When you activate cruise control, the stored speed is shown in the multifunction display for five seconds.

In the multifunction display, the segments between the stored speed and the maximum speed light up.

Activation conditions

To activate cruise control, all of the following activation conditions must be fulfilled:

- the electric parking brake must be released.
- you are driving faster than 30 km/h.

- ESP® must be switched on, but not intervening.
- on vehicles with automatic transmission, the selector lever must be in position **D**.
- on vehicles with manual transmission, a gear must be engaged.
- cruise control must be selected.

► **To select cruise control:** check whether LIM indicator lamp ② is on or off.

If it is off, cruise control is already selected.

► If it is not, press the cruise control lever in the direction of arrow ⑤.

LIM indicator lamp ② in the cruise control lever goes out. Cruise control is selected.

Storing, maintaining and calling up a speed

Storing and maintaining the current speed

You can store the current speed if you are driving faster than 30 km/h.

- Accelerate the vehicle to the desired speed.
- Briefly press the cruise control lever up ① or down ④.
- Remove your foot from the accelerator pedal. Cruise control is activated. The vehicle automatically maintains the speed.

i Cruise control may be unable to maintain the stored speed on uphill gradients. The stored speed is resumed when the gradient evens out. Cruise control maintains the stored speed on downhill gradients by automatically braking the vehicle.

i Vehicles with manual transmission:

- always drive at adequate, but not excessive, engine speeds.
- change gear in good time.
- if possible, do not change down several gears at a time.

Storing the current speed and calling up the last stored speed

WARNING

If you call up a stored speed and this is different from the current speed, the vehicle accelerates or brakes. If you do not know what the stored speed is, the vehicle may accelerate or brake unexpectedly. There is a risk of an accident.

Take the traffic conditions into account before calling up the stored speed. If you do not know what the stored speed is, store the desired speed again.

- ▶ Briefly pull the cruise control lever towards you ③.
- ▶ Remove your foot from the accelerator pedal.
The first time cruise control is activated, it stores the current speed or regulates the speed of the vehicle to the previously stored speed.

Setting a speed

Keep in mind that it may take a brief moment until the vehicle has accelerated or braked to the set speed.

- ▶ Press the cruise control lever up ① for a higher speed or down ④ for a lower speed.
- ▶ Keep the cruise control lever pressed until the desired speed is reached.
- ▶ Release the cruise control lever.
The new speed is stored.
- ▶ **To adjust the set speed in 1 km/h increments:** briefly press the cruise control lever up ① or down ④ to the pressure point.
The last stored speed increases or decreases in 1 km/h increments.
- ▶ **To adjust the set speed in 10 km/h increments:** press the cruise control lever briefly up ① or down ④ beyond the pressure point.
The last stored speed increases or decreases in 10 km/h increments.

- ① Cruise control is not deactivated if you depress the accelerator pedal. For example, if you accelerate briefly to overtake, cruise control adjusts the vehicle's speed to the last speed stored after you have finished overtaking.

Deactivating cruise control

There are several ways to deactivate cruise control:

- ▶ Briefly press the cruise control lever forwards ⑥.

or

- ▶ Brake

or

- ▶ Briefly press the cruise control lever in the direction of arrow ⑤.
Variable SPEEDTRONIC is selected. LIM indicator lamp ② in the cruise control lever lights up.

Cruise control is automatically deactivated if:

- you engage the electric parking brake.
- you are driving at less than 30 km/h.
- ESP® intervenes or you deactivate ESP®
- while driving a vehicle with manual transmission, you shift into neutral or depress the clutch pedal for longer than six seconds.
- on vehicles with manual transmission, you shift to a gear that is too high, and as a result the engine speed is too low.
- on vehicles with automatic transmission, you shift into position **N** while driving.

If cruise control is deactivated, you will hear a warning tone. You will see the **Cruise control off** message in the multifunction display for approximately five seconds.

- ① The last speed stored is cleared when you switch off the engine.

SPEEDTRONIC

Important safety notes

SPEEDTRONIC brakes automatically so that you do not exceed the set speed. On long and steep downhill gradients, especially if the vehicle is laden or towing a trailer, you must select shift range **1**, **2** or **3** in good time. By doing so, you will make use of the braking effect of the engine. This relieves the load on the brake system and prevents the brakes from overheating and wearing too quickly. If you need additional braking, depress the brake pedal repeatedly rather than continuously.

If you fail to adapt your driving style, SPEEDTRONIC can neither reduce the risk of an accident nor override the laws of physics. SPEEDTRONIC cannot take into account road, weather or traffic conditions. SPEEDTRONIC is only an aid. You are responsible for the distance to the vehicle in front, for vehicle speed, for braking in good time, and for staying in the lane.

If there is a change of drivers, advise the new driver of the speed stored.

General notes

You can set a variable or permanent limit speed:

- **variable** for speed limits, e.g. in built-up areas
- **permanent** for long-term speed restrictions, e.g. when driving with winter tyres fitted (▷ page 172)

i The speed indicated in the speedometer may differ slightly from the limit speed stored.

Variable SPEEDTRONIC

General notes

With the cruise control lever, you can operate cruise control or DISTRONIC PLUS and variable SPEEDTRONIC.

The LIM indicator lamp on the cruise control lever indicates which system you have selected:

- **LIM indicator lamp off:** cruise control or DISTRONIC PLUS is selected.
- **LIM indicator lamp on:** variable SPEEDTRONIC is selected.

You can use the cruise control lever to limit the speed to any speed above 30 km/h while the engine is running.

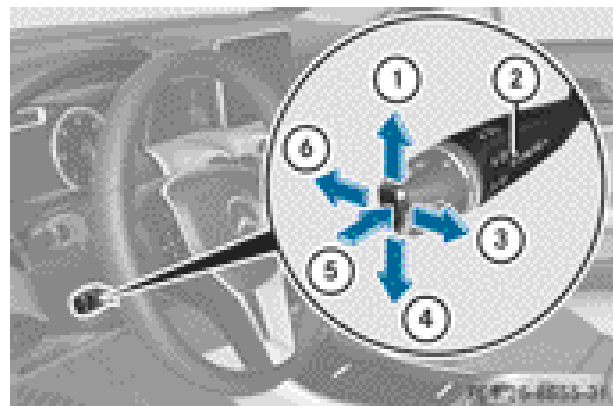

- ① To store the current speed or a higher speed
- ② LIM indicator lamp
- ③ To store the current speed and calling up the last stored speed
- ④ To store the current speed or a lower speed
- ⑤ To switch between cruise control or DISTRONIC PLUS and variable SPEEDTRONIC
- ⑥ To deactivate variable SPEEDTRONIC

Selecting variable SPEEDTRONIC

► Check whether LIM indicator lamp ② is on. If it is on, variable SPEEDTRONIC is already selected.

If it is not, press the cruise control lever in the direction of arrow ⑤.

LIM indicator lamp ② in the cruise control lever lights up. Variable SPEEDTRONIC is selected.

► Make sure that the accelerator pedal is not depressed beyond the pressure point.

Storing the current speed

You can use the cruise control lever to limit the speed to any speed above 30 km/h while the engine is running.

- ▶ Briefly press the cruise control lever up ① or down ④.
The current speed is stored. For five seconds, the multifunction display shows the stored speed, e.g. **Limit 100 km/h**.
The segments in the speedometer light up from the start of the scale up to the stored speed.

Storing the current speed and calling up the last stored speed

WARNING

If you call up the stored speed and it is lower than the current speed, the vehicle decelerates. If you do not know the stored speed, the vehicle could decelerate unexpectedly. There is a risk of an accident.

Pay attention to the road and traffic conditions before calling up the stored speed. If you do not know the stored speed, store the desired speed again.

- ▶ Briefly pull the cruise control lever towards you ③.
- ▶ **To adjust the set speed in 1 km/h increments:** briefly press the cruise control lever up ① to the pressure point for a higher speed, or down ④ for a lower speed.

or

- ▶ Keep the cruise control lever pressed to the pressure point until the desired speed is set. Press the cruise control lever up ① for a higher speed or down ④ for a lower speed.
- ▶ **To adjust the set speed in 10 km/h increments:** briefly press the cruise control lever up ① past the pressure point for

a higher speed, or down ④ for a lower speed.

or

- ▶ Keep the cruise control lever pressed beyond the pressure point until the desired speed is set. Press the cruise control lever up ① for a higher speed or down ④ for a lower speed.

Deactivating variable SPEEDTRONIC

It is not possible to deactivate variable SPEEDTRONIC by braking.

There are several ways to deactivate variable SPEEDTRONIC:

- ▶ Briefly press the cruise control lever forwards ⑥.

or

- ▶ Briefly press the cruise control lever in the direction of arrow ⑤.
LIM indicator lamp ② in the cruise control lever goes out. Variable SPEEDTRONIC is deactivated.
Cruise control or DISTRONIC PLUS is selected.

Variable SPEEDTRONIC is automatically deactivated if:

- you depress the accelerator pedal beyond the pressure point (kickdown), but only if your current speed does not differ by more than 20 km/h from the stored speed. You will hear a warning tone if this is the case.
- on vehicles with manual transmission, if you shift to a higher gear and as a result, the engine speed is too low.

-  The last speed stored is cleared when you switch off the engine.

Permanent SPEEDTRONIC

You can use the on-board computer to limit the speed permanently to a value between 160 km/h (e.g. for driving on winter tyres) and the maximum speed (▷ page 223).

Shortly before the stored speed is reached, it appears in the multifunction display.

Permanent SPEEDTRONIC remains active, even if variable SPEEDTRONIC is deactivated. You cannot exceed the stored limit speed, even if you depress the accelerator pedal beyond the pressure point (kickdown).

DISTRONIC PLUS

Important safety notes

WARNING

DISTRONIC PLUS does not react to:

- people or animals
- stationary obstacles on the road, e.g. stopped or parked vehicles
- oncoming and crossing traffic

As a result, DISTRONIC PLUS may neither give warnings nor intervene in such situations. There is a risk of an accident.

Always pay careful attention to the traffic situation and be ready to brake.

WARNING

DISTRONIC PLUS cannot always clearly identify other road users and complex traffic situations.

In such cases, DISTRONIC PLUS may:

- give an unnecessary warning and then brake the vehicle
- neither give a warning nor intervene
- accelerate unexpectedly

There is a risk of an accident.

Continue to drive carefully and be ready to brake, in particular when warned to do so by DISTRONIC PLUS.

WARNING

DISTRONIC PLUS brakes your vehicle with up to 40% of the maximum braking force. If this braking force is insufficient, DISTRONIC PLUS warns you visually and audibly. There is a risk of an accident.

In such cases, apply the brakes yourself and try to take evasive action.

! If DISTRONIC PLUS or the HOLD function is activated, the vehicle brakes automatically in certain situations. To prevent damage to the vehicle, deactivate DISTRONIC PLUS and the HOLD function in the following or other similar situations:

- when towing the vehicle
- in the car wash

If you fail to adapt your driving style, DISTRONIC PLUS can neither reduce the risk of an accident nor override the laws of physics. DISTRONIC PLUS cannot take road and weather conditions or traffic conditions into account. DISTRONIC PLUS is only an aid. You are responsible for the distance to the vehicle in front, for vehicle speed, for braking in good time, and for staying in the lane.

Do not use DISTRONIC PLUS:

- in road and traffic conditions which do not allow you to maintain a constant speed (e.g. in heavy traffic or on winding roads).
- on smooth or slippery roads. Braking or accelerating can cause the drive wheels to lose traction and the vehicle could then skid.
- when there is poor visibility, e.g. due to fog, heavy rain or snow.

DISTRONIC PLUS may not detect narrow vehicles driving in front, e.g. motorcycles, or vehicles driving on a different line.

In particular, the detection of obstacles can be impaired by:

- dirt on the sensors or anything else covering the sensors
- snow or heavy rain
- interference by other radar sources
- the possibility of strong radar reflections, for example, in multi-storey car parks

If DISTRONIC PLUS no longer detects a vehicle in front, it may unexpectedly accelerate to the speed stored.

This speed can:

- be too high for a filter lane or a slip road
- be so high in the right lane that you pass vehicles driving on the left
- be so high in the left lane that you pass vehicles driving on the right

If there is a change of drivers, advise the new driver of the speed stored.

General notes

DISTRONIC PLUS regulates the speed and automatically helps you maintain the distance to the vehicle detected in front. DISTRONIC PLUS brakes automatically so that the set speed is not exceeded.

You must select a lower gear in good time on long and steep downhill gradients, especially if the vehicle is laden or towing a trailer. For this, you need to have selected manual drive program **M** (▷ page 166). By doing so, you will make use of the braking effect of the engine. This relieves the load on the brake system and prevents the brakes from overheating and wearing too quickly.

If a slower-moving vehicle is detected in front, DISTRONIC PLUS brakes your vehicle. It maintains the preset distance to the vehicle in front.

If DISTRONIC PLUS detects that there is a risk of a collision, you will be warned visually and acoustically. Without your intervention, DISTRONIC PLUS cannot prevent a collision. An intermittent warning tone will then sound and the distance warning lamp will light up in the instrument cluster. Brake immediately to increase the distance to the vehicle driving in front, or take evasive action, provided it is safe to do so.

The radar sensor system is switched off automatically in the vicinity of radio telescope facilities (▷ page 350).

For DISTRONIC PLUS to assist you when driving, the radar sensor system must be:

- activated (▷ page 223)
- operational

i In some countries you must deactivate the radar sensor system (▷ page 223).

For further information about the radar sensor system; see (▷ page 350).

DISTRONIC PLUS is automatically deactivated if:

- you are driving slower than 25 km/h and there is no longer a vehicle in front or
- the vehicle ahead has not been detected

If there is no vehicle in front, DISTRONIC PLUS operates in the same way as cruise control in the speed range between 30 km/h and 200 km/h. If a vehicle is driving in front of you, it operates in the speed range between 0 km/h and 200 km/h.

Do not use DISTRONIC PLUS on roads with steep gradients.

Cruise control lever

With the cruise control lever, you can operate DISTRONIC PLUS and variable SPEEDTRONIC.

The LIM indicator lamp on the cruise control lever indicates which system you have selected:

- **LIM indicator lamp off:** DISTRONIC PLUS is selected.
- **LIM indicator lamp on:** variable SPEEDTRONIC is selected.

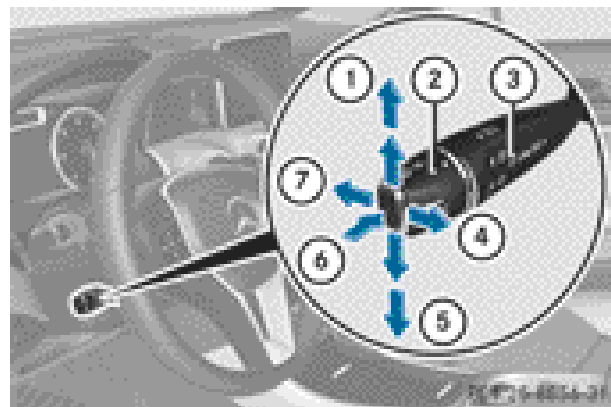

- ① To store the current speed or a higher speed
- ② To set the specified minimum distance
- ③ LIM indicator lamp

- ④ To store the current speed and calling up the last stored speed
- ⑤ To store the current speed or a lower speed
- ⑥ To switch between DISTRONIC PLUS and variable SPEEDTRONIC
- ⑦ To deactivate DISTRONIC PLUS

Selecting DISTRONIC PLUS

- ▶ Check whether LIM indicator lamp ③ is off. If it is off, DISTRONIC PLUS is already selected.
- ▶ If it is not, press the cruise control lever in the direction of arrow ⑥. LIM indicator lamp ③ in the cruise control lever goes out. DISTRONIC PLUS is selected.

Activating DISTRONIC PLUS; storing, maintaining and calling up a speed

Activation conditions

To activate DISTRONIC PLUS, all of the following activation conditions must be fulfilled:

- the engine must be running. It may take up to two minutes of driving before DISTRONIC PLUS is ready for use.
- the electric parking brake must be released.
- ESP® must be switched on, but not intervening.
- Active Parking Assist must not be activated.
- the transmission must be in position **D**.
- the driver's door must be closed when you shift from **P** to **D** or your seat belt must be fastened.
- the front-passenger door and the rear doors must be closed.
- the DISTRONIC PLUS function must be selected with the cruise control lever (▶ page 175).

Activating

To activate while driving: you can only activate DISTRONIC PLUS at speeds below 20 km/h if the vehicle in front is detected and shown in the multifunction display. If the vehicle in front is no longer detected and displayed, DISTRONIC PLUS switches off and you will hear a tone.

- ▶ Briefly pull the cruise control lever towards you ④ or press it up ① or down ⑤. DISTRONIC PLUS is activated.
- ▶ Press the cruise control lever repeatedly up ① or down ⑤ until the desired speed is set.
- ▶ Remove your foot from the accelerator pedal. Your vehicle adapts its speed to that of the vehicle in front, but only up to the desired stored speed.

When driving at speeds below 30 km/h, you can only activate DISTRONIC PLUS if the vehicle in front has been detected and is shown in the multifunction display. If the vehicle in front is no longer detected and displayed, DISTRONIC PLUS switches off and you will hear a tone.

- i** If you do not fully release the accelerator pedal, the **DISTRONIC PLUS inactive** message appears in the multifunction display. The set distance to a slower-moving vehicle in front will then not be maintained. You will be driving at the speed you determine by the position of the accelerator pedal.



Displaying DISTRONIC PLUS in the speedometer

When DISTRONIC PLUS is activated, one or two segments ② in the set speed range light up.

- ❶ For design reasons, the speed displayed in the speedometer may differ slightly from the speed set for DISTRONIC PLUS.

If DISTRONIC PLUS detects a vehicle in front, segments ② between speed of the vehicle in front ① and stored speed ③ light up.



Assistance graphic in vehicles with a colour multi-function display

- ① Vehicle in front, if detected
- ② Specified minimum distance to the vehicle in front; adjustable
- ③ Own vehicle
- ④ DISTRONIC PLUS active (text only appears when the cruise control lever is actuated)

In the Assistance menu (▷ page 217) of the on-board computer, you can select the assistance graphic.

- ▶ Select the **Distance display** function using the on-board computer (▷ page 217).

- ❶ You will see the stored speed for approximately five seconds when you activate DISTRONIC PLUS.

Activating at the current speed/last stored speed

⚠ WARNING

If you call up a stored speed and this is different from the current speed, the vehicle accelerates or brakes. If you do not know

what the stored speed is, the vehicle may accelerate or brake unexpectedly. There is a risk of an accident.

Take the traffic conditions into account before calling up the stored speed. If you do not know what the stored speed is, store the desired speed again.

- ▶ Briefly pull the cruise control lever (▷ page 174) towards you ④.
- ▶ Remove your foot from the accelerator pedal. DISTRONIC PLUS is activated. The first time it is activated, the current speed is stored. Otherwise, it sets the vehicle cruise speed to the previously stored value.

Setting a speed

Keep in mind that it may take a brief moment until the vehicle has accelerated or braked to the set speed.

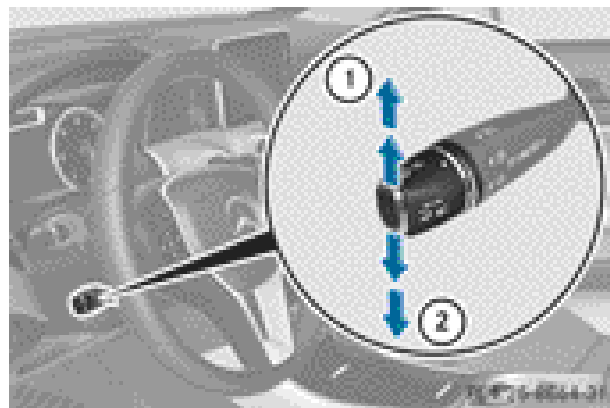

- ① To store the current speed or a higher speed
- ② To store the current speed or a lower speed
- ▶ Press the cruise control lever up ① for a higher speed or down ② for a lower speed.
- ▶ Keep the cruise control lever pressed until the desired speed is reached.
- ▶ Release the cruise control lever. The new speed is stored. DISTRONIC PLUS is activated and adjusts the vehicle's speed to the new speed stored.

- ▶ **To adjust the set speed in 1 km/h increments:** briefly press the cruise control lever up ① or down ② to the pressure point.

The last stored speed increases or decreases in 1 km/h increments.

- ▶ **To adjust the set speed in 10 km/h increments:** press the cruise control lever briefly up ① or down ② beyond the pressure point.

The last stored speed increases or decreases in 10 km/h increments.

- ❗ **DISTRONIC PLUS** is not deactivated if you depress the accelerator pedal. If you accelerate to overtake, **DISTRONIC PLUS** adjusts the vehicle's speed to the last speed stored after you have finished overtaking.

Setting the specified minimum distance

You can set the specified minimum distance for **DISTRONIC PLUS** by varying the time span between one and two seconds. With this function, you can set the minimum distance that **DISTRONIC PLUS** keeps to the vehicle in front, dependent on vehicle speed. You can see this distance in the multifunction display (▷ page 175).

- ❗ Make sure that you maintain the minimum distance to the vehicle in front as required by law. Adjust the distance to the vehicle in front if necessary.

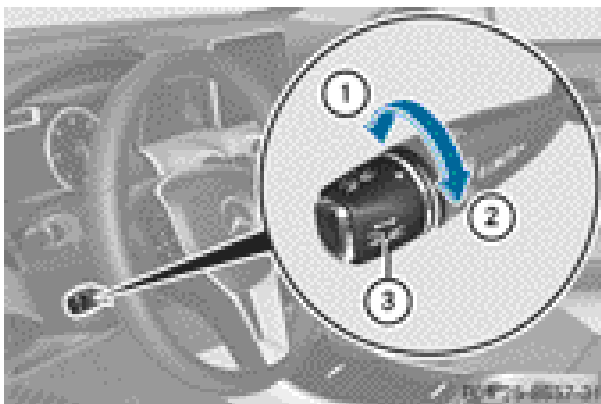

- ▶ **To increase:** turn control ③ in direction ②.

DISTRONIC PLUS then maintains a greater distance between your vehicle and the vehicle in front.

- ▶ **To decrease:** turn control ③ in direction ①.

DISTRONIC PLUS then maintains a shorter distance between your vehicle and the vehicle in front.

Deactivating **DISTRONIC PLUS**

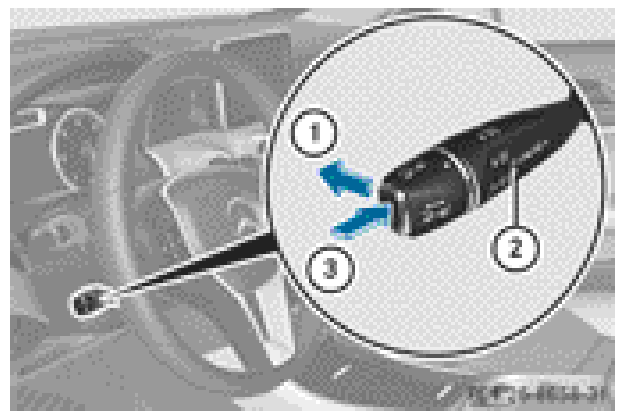

There are several ways to deactivate **DISTRONIC PLUS**:

- ▶ Briefly press the cruise control lever forwards ①.

or

- ▶ Brake, unless the vehicle is stationary.

or

- ▶ Briefly press the cruise control lever in the direction of arrow ③.

Variable **SPEEDTRONIC** is selected. **LIM** indicator lamp ② in the cruise control lever lights up.

When you deactivate **DISTRONIC PLUS**, you will see the **DISTRONIC PLUS off** message in the multifunction display for approximately five seconds.

- ❗ The last speed stored remains stored until you switch off the engine. **DISTRONIC PLUS** is not deactivated if you depress the accelerator pedal.

DISTRONIC PLUS is automatically deactivated if:

- you apply the electric parking brake or if the vehicle is automatically secured with the electric parking brake
- you are driving slower than 10 km/h and there is no longer a vehicle in front, or if the vehicle in front is no longer detected
- ESP® intervenes or you deactivate ESP®
- the transmission is in the **P**, **R** or **N** position
- you switch off the radar sensor system
- you pull the cruise control lever towards you in order to pull away and the front-passenger door or one of the rear doors is open
- the vehicle is skidding
- you activate Active Parking Assist

If DISTRONIC PLUS is deactivated, you will hear a warning tone. You will see the **DISTRONIC PLUS off** message in the multifunction display for approximately five seconds. In the Assistance menu (▷ page 217) of the on-board computer, you can select the assistance graphic.



- ① Vehicle in front, if detected
 - ② Distance indicator: current distance to the vehicle in front
 - ③ Specified minimum distance to the vehicle in front; adjustable
 - ④ Own vehicle
- ▶ Select the **Distance display** function using the on-board computer (▷ page 217).

Tips for driving with DISTRONIC PLUS

General notes

The following contains descriptions of certain road and traffic conditions in which you must be particularly attentive. In such situations, brake if necessary. DISTRONIC PLUS is then deactivated.

Cornering, going into and coming out of a bend

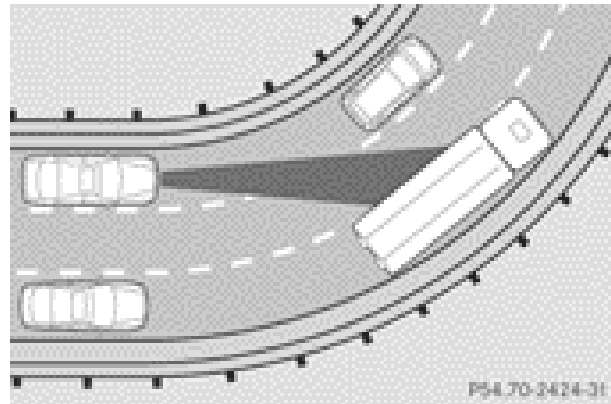

The ability of DISTRONIC PLUS to detect vehicles when cornering is limited. Your vehicle may brake unexpectedly or late.

Vehicles which are not driving in the middle of their lane

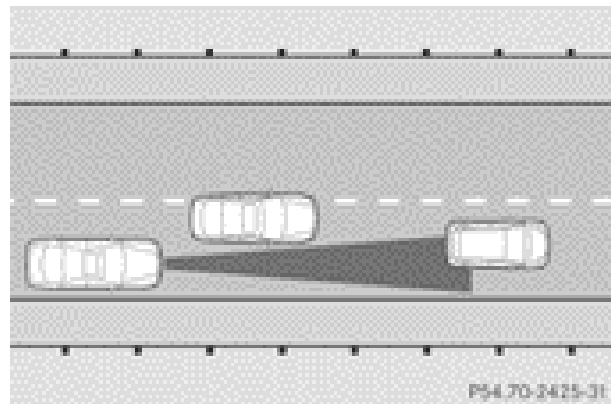

DISTRONIC PLUS may not detect vehicles which are not driving in the middle of their lane. The distance to the vehicle in front will be too short.

Other vehicles changing lane

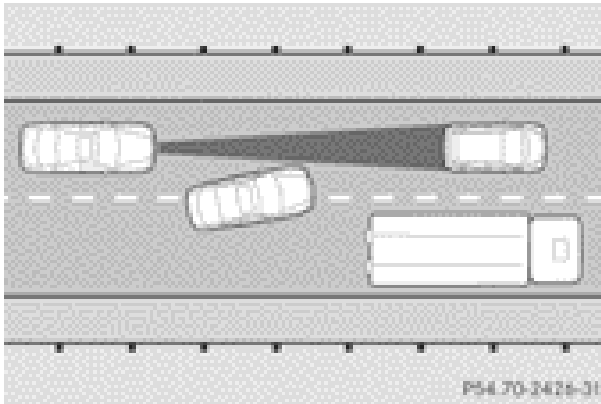

DISTRONIC PLUS has not detected the vehicle cutting in yet. The distance to this vehicle will be too short.

Narrow vehicles

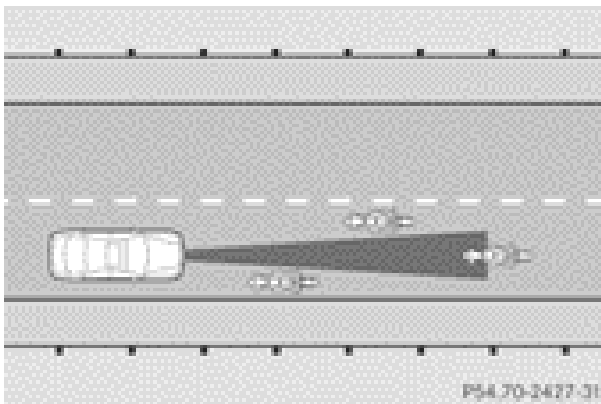

DISTRONIC PLUS has not yet detected the vehicle in front on the edge of the carriageway, because of its narrow width. The distance to the vehicle in front will be too short.

Obstructions and stationary vehicles

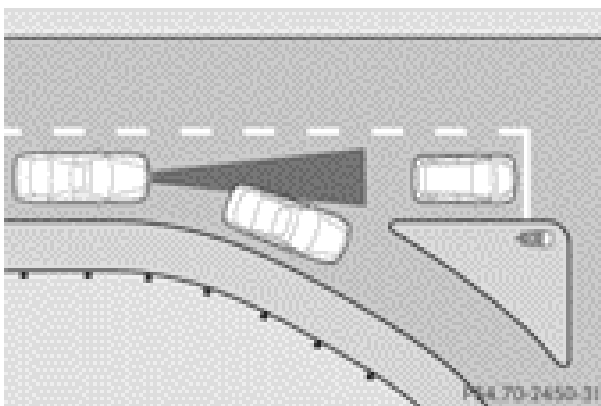

DISTRONIC PLUS does not brake for obstacles or stationary vehicles. If, for example, the

detected vehicle turns a corner and reveals an obstacle or stationary vehicle, DISTRONIC PLUS will not brake for these.

Crossing vehicles

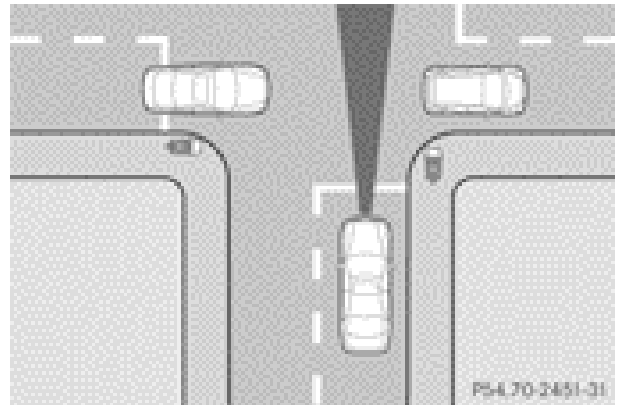

DISTRONIC PLUS may detect vehicles that are crossing your lane by mistake. Activating DISTRONIC PLUS at traffic lights with crossing traffic, for example, could cause your vehicle to pull away unintentionally.

HOLD function

Important safety notes

WARNING

When leaving the vehicle, it can still roll away despite being braked by the HOLD function if:

- there is a malfunction in the system or in the voltage supply
- the HOLD function is deactivated by the accelerator pedal being depressed, e.g. by a vehicle occupant
- the electrical system in the engine compartment, the battery or the fuses are tampered with
- the battery is disconnected

There is a risk of an accident.

Before leaving the vehicle, always deactivate the HOLD function and secure the vehicle from rolling away.

! If DISTRONIC PLUS or the HOLD function is activated, the vehicle brakes automatically in certain situations. To prevent damage to the vehicle, deactivate DISTRONIC PLUS and the HOLD function in the following or other similar situations:

- when towing the vehicle
- in the car wash

Deactivate the HOLD function (▷ page 180).

General notes

The HOLD function can assist the driver in the following situations:

- when pulling away, especially on steep slopes
- when manoeuvring on steep slopes
- when waiting in traffic

The vehicle is kept stationary without the driver having to depress the brake pedal.

The braking effect is cancelled and the HOLD function is deactivated when you depress the accelerator pedal to pull away.

Activation conditions

You can activate the HOLD function if:

- the vehicle is stationary
- the engine is running or if it has been automatically switched off by the ECO start/stop function
- the driver's door is closed or if your seat belt is fastened
- the electric parking brake is released
- the transmission is in position **D**, **R** or **N** on vehicles with automatic transmission
- DISTRONIC PLUS is deactivated

Activating the HOLD function

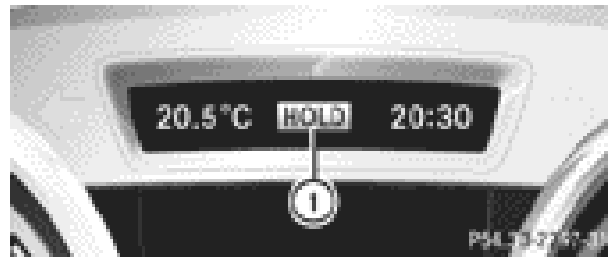

Example: vehicles with colour multifunction display

- ▶ Make sure that the activation conditions are met.
- ▶ Depress the brake pedal.
- ▶ Quickly depress the brake pedal further until ① appears in the multifunction display.

The HOLD function is activated. You can release the brake pedal.

- i** If depressing the brake pedal the first time does not activate the HOLD function, wait briefly and then try again.

Deactivating the HOLD function

The HOLD function is deactivated automatically if:

- you accelerate. On vehicles with automatic transmission: only when the transmission is in position **D** or **R**.
- the transmission is in position **P** on vehicles with automatic transmission.
- you depress the brake pedal again with a certain amount of pressure until ① disappears from the multifunction display.
- you secure the vehicle using the electric parking brake.
- you activate DISTRONIC PLUS.

- i** After a short period the vehicle is secured by the electric parking brake, thus relieving the service brake.

The electric parking brake secures the vehicle automatically if the HOLD function is activated and:

- the driver's door is open and the driver's seat belt is unfastened
- the engine is switched off, unless it is automatically switched off by the ECO start/stop function
- a system fault occurs
- the power supply is not sufficient

Vehicles with automatic transmission

If a fault occurs, then the transmission may also be shifted into position **P** automatically.

Vehicles with manual transmission

The **Brake immediately** message can also appear in the multifunction display.

- ▶ Immediately depress the brake pedal firmly until the warning message in the multifunction display goes out.

The HOLD function is deactivated.

A horn will sound at regular intervals if you turn off the engine, take off your seat belt or open the driver's door when the HOLD function is activated. The horn alerts you to the fact that the HOLD function is still activated. If you attempt to lock the vehicle, the tone becomes louder. The vehicle cannot be locked until you have deactivated the HOLD function.

- i** Once you have switched off the engine, you cannot restart it until you have deactivated the HOLD function.

RACE START

Important safety notes

RACE START enables optimum acceleration from a standing start. The precondition for this is a suitable high-grip road surface.

Only activate RACE START on dedicated race circuits.

- i** RACE START is only available in AMG vehicles.

Activation conditions

You can activate RACE START if:

- the doors, the bonnet and the tailgate are closed
- the engine is running and the transmission, traction control and engine are at operating temperature
- SPORT handling mode is activated (▷ page 66)
- the steering wheel is in the straight-ahead position.
- the vehicle is stationary and the brake pedal is depressed (left foot)
- the transmission is in position **D**.
- drive program **M** is selected (▷ page 155).

Activating RACE START

- ▶ Depress the brake pedal with your left foot and keep it depressed.
- ▶ Pull and hold both steering wheel gearshift paddles.
- ▶ The **RACE START Confirm: Paddle UP Cancel: Paddle DOWN** message appears in the multifunction display.
- ▶ Release both steering wheel gearshift paddles.

- i** If the activation conditions are no longer fulfilled, RACE START is cancelled. The **RACE START not possible See Owner's Manual** message appears in the multifunction display.

- ▶ **To cancel:** pull the left steering wheel shift paddle (▷ page 156).

or

- ▶ **To confirm:** pull the right steering wheel shift paddle (▷ page 156).

The **RACE START available Depress accelerator** message appears in the multifunction display.

i If you do not depress the accelerator pedal within a few seconds, RACE START is cancelled. The multifunction display shows the **RACE START cancelled** message.

► Fully depress the accelerator pedal. The engine speed is increased. The **RACE START Release brake to start** message appears in the multifunction display.

i If the brake pedal is not released after a short while, RACE START is cancelled. The multifunction display shows the **RACE START cancelled** message.

► Take your foot off the brake, but keep the accelerator pedal depressed. The vehicle pulls away at maximum acceleration.

The **RACE START active** message appears in the multifunction display.

RACE START is deactivated when the vehicle reaches a speed of approximately 50 km/h. Drive program **S** is activated. SPORT handling mode remains activated.

RACE START is deactivated immediately if you release the accelerator pedal during RACE START or if any of the activation conditions are no longer fulfilled. The **RACE START not possible** or **RACE START cancelled** message appears in the multifunction display.

i After using it several times in short succession, RACE START will be unavailable until a certain distance has been driven.

4MATIC (permanent all-wheel drive)

4MATIC ensures that all four wheels are permanently driven. Together with ESP[®], it improves the traction of your vehicle whenever a drive wheel spins due to insufficient grip.

If you fail to adapt your driving style, 4MATIC can neither reduce the risk of accident nor override the laws of physics. 4MATIC cannot

take account of road, weather and traffic conditions. 4MATIC is only an aid. You are responsible for the distance to the vehicle in front, for vehicle speed, for braking in good time, and for staying in the lane.

If a drive wheel spins due to insufficient grip:

- when pulling away, only depress the accelerator pedal as far as is necessary.
- accelerate less when driving.

! Never tow the vehicle with one axle raised. This may damage the transfer case. Damage of this sort is not covered by the Mercedes-Benz implied warranty. All wheels must remain either on the ground or be fully raised. Observe the instructions for towing the vehicle with all wheels in full contact with the ground.

i In wintry driving conditions, the maximum effect of 4MATIC can only be achieved if you use winter tyres (M+S tyres), with snow chains if necessary.

PARKTRONIC

Important safety notes

PARKTRONIC is only an aid. It is not a substitute for your attention to the immediate surroundings. The responsibility for safe manoeuvring and parking remains with you. Make sure that there are no persons, animals or objects in range while manoeuvring and parking.

! When parking, pay particular attention to objects above or below the sensors, such as flower pots or trailer drawbars. PARKTRONIC does not detect such objects when they are in the immediate vicinity of the vehicle. You could damage the vehicle or the objects.

The sensors may not detect snow and objects which absorb ultrasonic sources. Ultrasonic sources, such as an automatic car wash, a lorry's compressed-air brakes

or a pneumatic drill, could cause PARKTRONIC to malfunction.

PARKTRONIC may not function correctly on uneven terrain.

PARKTRONIC is an electronic parking aid with ultrasonic sensors. It indicates visually and audibly the distance between your vehicle and an object.

PARKTRONIC is activated automatically if you:

- switch on the ignition
- shift to position **D**, **R** or **N** on vehicles with automatic transmission
- release the electric parking brake

PARKTRONIC is deactivated at speeds above 18 km/h. It is reactivated at lower speeds.

PARKTRONIC monitors the area around your vehicle using six sensors in the front bumper and four sensors in the rear bumper.

Range of the sensors

General notes

PARKTRONIC does not take into account obstacles located:

- below the detection range, e.g. persons, animals or objects
- above the detection range, e.g. overhanging loads, tail sections or loading ramps of goods vehicles

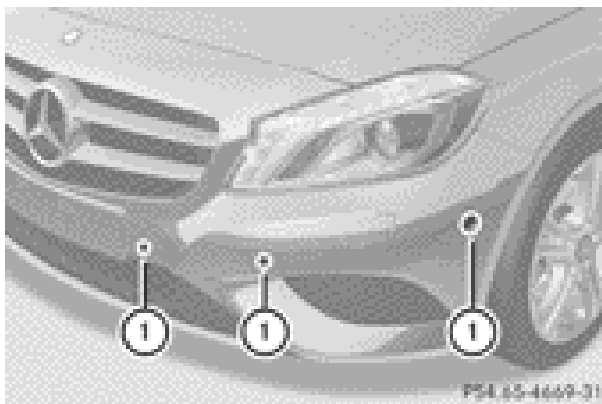

- ① Example: sensors in the front bumper, left-hand side



Side view

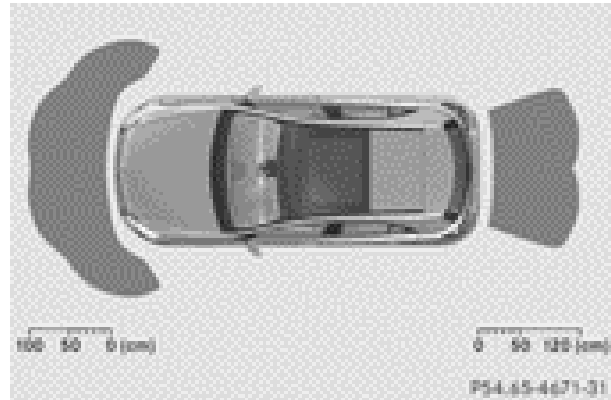

Top view

The sensors must be free of dirt, ice and slush. Otherwise, they may not function correctly. Clean the sensors regularly, taking care not to scratch or damage them (▷ page 294).

Front sensors

Centre	Approx. 100 cm
Corners	Approx. 60 cm

Rear sensors

Centre	Approx. 120 cm
Corners	Approx. 80 cm

Minimum distance

Centre	Approx. 20 cm
Corners	Approx. 20 cm

If there is an obstacle within this range, the relevant warning displays light up and a warning tone sounds. If the distance falls below the minimum, the distance may no longer be shown.

Warning displays

The warning displays show the distance between the sensors and the obstacle. The warning display for the front area is located on the dashboard above the centre air vents. The warning display for the rear area is located on the roof lining in the rear compartment.

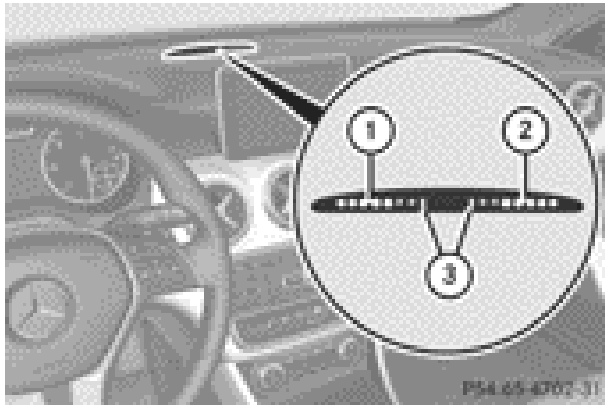

Warning display for the front area

- ① Segments on the left-hand side of the vehicle
- ② Segments on the right-hand side of the vehicle
- ③ Segments showing operational readiness

The warning display for each side of the vehicle is divided into five yellow and two red segments. PARKTRONIC is operational if yellow segments showing operational readiness ③ light up.

The gear lever position or the transmission position of the automatic transmission and the direction in which the vehicle is rolling determine which warning display is active when the engine is running.

Manual transmission:

Gear lever position	Warning display
Forwards gear or Neutral	Front area activated
Reverse gear, or the vehicle is rolling backwards	Rear and front areas activated

Automatic transmission:

Transmission position	Warning display
D	Front area activated
R, N or the vehicle is rolling backwards	Rear and front areas activated
P	No areas activated

One or more segments light up as the vehicle approaches an obstacle, depending on the vehicle's distance from the obstacle.

From the:

- sixth segment onwards, you will hear an intermittent warning tone for approximately two seconds.
- seventh segment onwards, you will hear a warning tone for approximately two seconds. This indicates that you have now reached the minimum distance.

Deactivating/activating PARKTRONIC

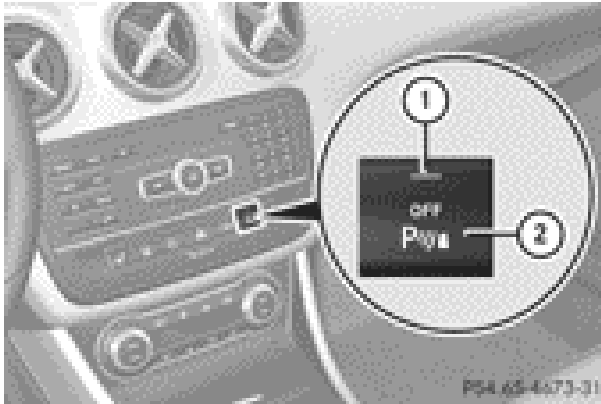

- ① Indicator lamp
- ② To deactivate/activate PARKTRONIC

If indicator lamp ① lights up, PARKTRONIC is deactivated.

- i** PARKTRONIC is automatically activated when you turn the key to position **2** in the ignition lock.

Towing a trailer

- !** Fold in the ball coupling if the trailer tow hitch is not required. PARKTRONIC measures the minimum detection range to an obstacle from the bumper, not the ball coupling.

PARKTRONIC is deactivated for the rear area when you establish an electrical connection between your vehicle and a trailer.

Problems with PARKTRONIC

Problem	Possible causes/consequences and ► Solutions
Only the red segments in the PARKTRONIC warning displays are lit. You also hear a warning tone for approximately two seconds. PARKTRONIC is deactivated after approximately five seconds, and the indicator lamp in the PARKTRONIC button lights up.	<p>PARKTRONIC has malfunctioned and has switched off.</p> <ul style="list-style-type: none"> ► If problems persist, have PARKTRONIC checked at a qualified specialist workshop.
Only the red segments in the PARKTRONIC warning displays are lit. PARKTRONIC is deactivated after approximately five seconds.	<p>The PARKTRONIC sensors are dirty or there is interference.</p> <ul style="list-style-type: none"> ► Clean the PARKTRONIC sensors (► page 294). ► Switch the ignition back on. <p>The problem may be caused by an external source of radio or ultrasound waves.</p> <ul style="list-style-type: none"> ► See if PARKTRONIC functions in a different location.

Active Parking Assist

Important safety notes

Active Parking Assist is only an aid. It is not a substitute for your attention to the immediate surroundings. The responsibility for safe manoeuvring and parking remains with you. Make sure that there are no persons, animals or objects in range while manoeuvring and parking.

WARNING

The vehicle will veer out when parking and can take you onto sections of the oncoming lane. As a result, you may collide with other road users. There is a risk of an accident.

When parking, pay attention to other road users. Stop the vehicle if necessary or cancel the Active Parking Assist parking procedure.

! If unavoidable, you should drive over obstacles such as kerbs slowly and not at

a sharp angle. Otherwise, you may damage the wheels or tyres.

Active Parking Assist may also display spaces not suitable for parking, e.g.:

- parking or stopping prohibitions
- in front of driveways or entrances and exits
- unsuitable surfaces

Parking tips:

- on narrow roads, drive as closely as possible past the parking space.
- parking spaces that are littered, overgrown or partially occupied by trailer drawbars might be identified incorrectly or not at all.
- snowfall or heavy rain may lead to a parking space being measured inaccurately.
- pay attention to the PARKTRONIC (► page 184) warning messages during the parking procedure.

- at any time, you can intervene in the steering procedure to correct it. Active Parking Assist will then be cancelled.
- when transporting a load which protrudes from your vehicle, you should not use Active Parking Assist.
- never use Active Parking Assist when snow chains are fitted.
- make sure that the tyre pressures are always correct. This has a direct influence on the parking characteristics of the vehicle.

General notes

Active Parking Assist is an electronic parking aid with ultrasound. Ultrasound is used to measure the road on both sides of the vehicle. A suitable parking space is indicated by the parking symbol. Active steering intervention can assist you during parking.

You may also use PARKTRONIC (▷ page 182). When PARKTRONIC is switched off, Active Parking Assist is also unavailable. Use Active Parking Assist for parking spaces:

- that are parallel to the direction of travel
- that are on straight roads, not bends
- that are on the same level as the road, e.g. not on the pavement

Detecting parking spaces

Objects located above the height range of Active Parking Assist will not be detected when the parking space is measured. These are not taken into account when the parking procedure is calculated, e.g. overhanging loads, tail sections or loading ramps of goods vehicles.

WARNING

If objects are located above the detection range, Active Parking Assist may start to steer into the parking space too soon. As a result, you could cause a collision. There is a risk of an accident.

If objects are located above the detection range, stop the vehicle and switch Active Parking Assist off.

For further information on the detection range (▷ page 183).

Active Parking Assist does not support you parking in spaces that are parallel to the direction of travel if:

- the parking space is on a kerb stone
- the parking space appears to be blocked, for example by foliage or grass paving blocks
- the range of movement is too small
- the parking space is bordered by an obstacle which is not clearly defined such as a tree or a trailer

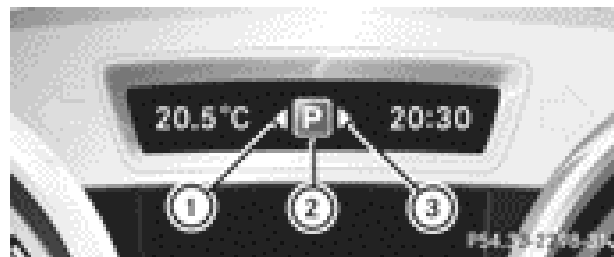

- ① Detected parking space on the left
- ② Parking symbol
- ③ Detected parking space on the right

Active Parking Assist is activated automatically when driving forwards. The system is operational at speeds of up to approximately 35 km/h. While in operation, the system independently locates and measures parking spaces on both sides of the vehicle.

Active Parking Assist will only detect parking spaces:

- that are parallel to the direction of travel
- that are at least 1.5 m wide
- that are at least 1.3 m longer than your vehicle

i In the case of parking spaces that are at right angles to the direction of travel, please ensure that the parking space is long enough to accommodate your vehicle.

When driving at speeds below 30 km/h, you will see parking symbol ② as a status indicator in the instrument cluster. When a parking space has been detected, an arrow towards the right or the left also appears. Active Parking Assist only displays parking spaces on the front-passenger side as standard. Parking spaces on the driver's side are displayed as soon as the turn signal on the driver's side is activated. When parking on the driver's side, this must remain switched on until you acknowledge the use of Active Parking Assist by pressing the **OK** button on the multifunction steering wheel.

A parking space is displayed while you are driving past it, and until you are approximately 15 m away from it.

Parking

WARNING

Active Parking Assist merely aids you by intervening actively in the steering. There is a risk of accident if you do not apply the brakes yourself.

Always apply the brakes yourself when parking and manoeuvring.

Active Parking Assist does not support you with parking spaces parallel to the direction of travel if:

- the parking space is on a kerbstone
 - the parking space is apparently blocked, for example by foliage or grass paving blocks
 - the range of movement is too small
 - the parking space is bordered by an obstacle which is not clearly defined such as a tree or a trailer
- Stop the vehicle when the parking symbol shows the desired parking space in the instrument cluster.
- Vehicles with manual transmission: shift to reverse gear.

Vehicles with automatic transmission: shift into position **R**.

The **Start Park Assist? Yes: OK No:**  message appears in the multifunction display.

- **To cancel the procedure:** press the  button on the multifunction steering wheel or pull away.

or

- **To park using Active Parking Assist:** press the **OK** button on the multifunction steering wheel.

The **Park Assist active Accelerate and brake Observe surroundings** message appears in the multifunction display.

- Release the multifunction steering wheel.
- Reverse the vehicle, being ready to brake at all times. Do not exceed a maximum speed of approximately 10 km/h when reversing. Otherwise, Active Parking Assist will be cancelled.

i In tight parking spaces, you will achieve the best parking results by backing up as far as possible. When doing so, also observe the PARKTRONIC messages.

- Stop as soon as PARKTRONIC sounds the continuous warning tone, if not before. Manoeuvring may be required in tight parking spaces.

Vehicles with manual transmission: the **Park Assist active Engage forward gear Observe surroundings** message appears in the multifunction display.

Vehicles with automatic transmission: the **Park Assist active Select D Observe surroundings** message appears in the multifunction display.

- Vehicles with manual transmission: while the vehicle is stationary, shift to first gear. Vehicles with automatic transmission: select transmission position **D** while the vehicle is stationary. Active Parking Assist immediately steers in the other direction.

The **Park Assist active Accelerate and brake Observe surroundings** message appears in the multifunction display.

i You will achieve the best results by waiting for the steering procedure to complete before pulling away.

- ▶ Drive forwards and be ready to brake at all times.
- ▶ Stop as soon as PARKTRONIC sounds the continuous warning tone, if not before.

Vehicles with manual transmission: the **Park Assist active Engage reverse gear Observe surroundings** message appears in the multifunction display.

Vehicles with automatic transmission: the **Park Assist active Select R Observe surroundings** message appears in the multifunction display.

- ▶ Additional transmission shifts may be necessary.

As soon as the parking procedure is complete, the **Park Assist switched off** message appears in the multifunction display.

Active Parking Assist is then deactivated. PARKTRONIC is still available.

- ▶ Manoeuvre if necessary.
- ▶ Always observe the warning messages displayed by PARKTRONIC (▷ page 184).

Parking tips:

- the way your vehicle is positioned in the parking space after parking is dependent on various factors. These include the position and shape of the vehicles parked in front and behind it and the conditions of the location. It may be the case that Active Parking Assist guides you too far into a parking space, or not far enough into it. In some cases, it may also lead you across or onto the kerb. If necessary, you should cancel the parking procedure with Active Parking Assist.
- you can also engage forward gear prematurely. The vehicle redirects and does not drive as far into the parking space. Should

a gear be changed too early, the parking procedure will be cancelled. A sensible parking position can no longer be achieved from this position.

Exiting a parking space

In order that Active Parking Assist can support you when you exit the parking space:

- the border of the parking space must not be too low.
- the border of the parking space must not be too wide. The system manoeuvres the vehicle into a position at a maximum of 45° to the starting position in the parking space.
- a manoeuvring distance of at least 0.60 m must be available.

Active Parking Assist can only assist you with exiting a parking space if you have parked the vehicle using Active Parking Assist.

- ▶ Start the engine.
- ▶ Switch on the turn signal on the side facing the street.

- ▶ **Vehicles with manual transmission:** engage first or reverse gear.

Vehicles with automatic transmission:

shift the transmission to position **D** or **R**.

The **Start Park Assist? Yes: OK No:**

 message appears in the multifunction display.

- ▶ **To cancel the procedure:** press the  button on the multifunction steering wheel or pull away.

or

- ▶ **To exit a parking space using Active Parking Assist:** press the  button on the multifunction steering wheel.

The **Park Assist active Accelerate and brake Observe surroundings** message appears in the multifunction display.

- ▶ Release the multifunction steering wheel.
- ▶ Reverse the vehicle or drive forwards, being ready to brake at all times. Do not exceed a maximum speed of approximately

10 km/h when exiting a parking space. Otherwise, Active Parking Assist will be cancelled.

- ▶ Stop when PARKTRONIC sounds the continuous warning tone, if not before.
- ▶ **Vehicles with manual transmission:** shift to first or reverse gear as required while the vehicle is stationary.

Vehicles with automatic transmission: shift to position **D** or **R** as required while the vehicle is stationary.

Active Parking Assist immediately steers in the other direction. The **Park Assist active Accelerate and brake Observe surroundings** message appears in the multifunction display.

- i** You will achieve the best results by waiting for the steering procedure to complete before pulling away.

If you reverse after activation, the steering wheel is moved to the straight-ahead position.

- ▶ Drive forwards or reverse the vehicle, being ready to brake at all times.
- ▶ Stop as soon as PARKTRONIC sounds the continuous warning tone, if not before.
- ▶ Drive forwards and reverse as prompted by the PARKTRONIC warning displays, several times if necessary.

Once you have exited the parking space completely, the steering wheel is moved to the straight-ahead position. You hear a tone and the **Park Assist switched off** message appears in the multifunction display. You will then have to steer and merge into traffic on your own. PARKTRONIC is still available.

Cancelling Active Parking Assist

You can cancel Active Parking Assist at any time.

- ▶ Stop the movement of the multifunction steering wheel or steer yourself. Active Parking Assist will be cancelled at once. The **Park Assist cancelled** message appears in the multifunction display.

or

- ▶ Press the PARKTRONIC button on the centre console (▷ page 185). PARKTRONIC is switched off and Active Parking Assist is immediately cancelled. The **Park Assist cancelled** message appears in the multifunction display.

Active Parking Assist is cancelled automatically if:

- you engage the electric parking brake.
- parking using Active Parking Assist is no longer possible.
- you are driving faster than 10 km/h.
- a wheel spins and ESP® intervenes or fails. The  warning lamp lights up in the instrument cluster.

A warning tone sounds. The parking space symbol disappears and the multifunction display shows the **Park Assist cancelled** message.

When Active Parking Assist is cancelled, you must steer again yourself.

If a system malfunction occurs, the vehicle is braked to a standstill. To drive on, depress the accelerator again.

Towing a trailer

For vehicles with a trailer tow hitch, the minimum required length for parking spaces is slightly increased.

If you have attached a trailer to your vehicle, you should not use Active Parking Assist. Once the electrical connection is established between your vehicle and the trailer, Active Parking Assist is no longer available. PARKTRONIC is deactivated for the rear area.

Reversing camera

Important safety notes

The reversing camera is only an aid. It is not a substitute for your attention to the immediate surroundings. The responsibility for safe manoeuvring and parking remains with you. Make sure that there are no persons, animals or objects in range while manoeuvring and parking.

Under the following circumstances, the reversing camera will not function, or will function in a limited manner:

- if the tailgate is open
- in heavy rain, snow or fog
- at night or in very dark places
- if the camera is exposed to very bright light
- if the area is lit by fluorescent light or LED lighting (the display may flicker)
- if there is a sudden change in temperature, e.g. when driving into a heated garage in winter
- if the camera lens is dirty or obstructed
- if the rear of your vehicle is damaged. In this event, have the camera position and setting checked at a qualified specialist workshop.

General notes

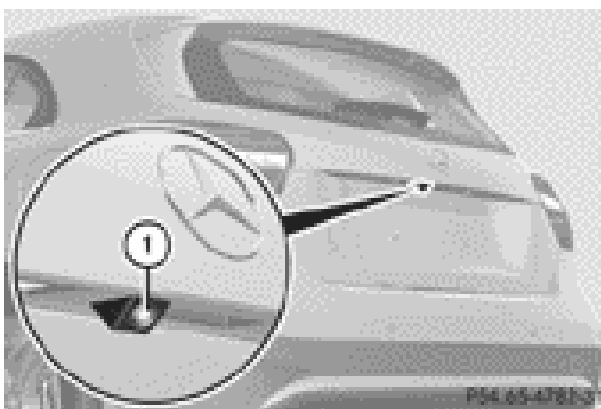

Reversing camera ① is in the boot lid handle. The reversing camera extends, when it is activated.

The reversing camera is an optical parking and manoeuvring aid. It uses guide lines to

show the area behind your vehicle in the Audio/COMAND display.

The area behind the vehicle is displayed as a mirror image, as in the rear-view mirror.

- ① The text of messages shown in the COMAND display depends on the language setting. The following are examples of reversing camera messages in the COMAND display.

Activating/deactivating the reversing camera

- ▶ **To activate:** make sure that the key is in position **2** in the ignition lock.
- ▶ Make sure that the "Activation by R gear" setting is active in the audio system/COMAND Online; see the separate audio system/COMAND Online operating instructions.
- ▶ Engage reverse gear. Guide lines are used to show the area behind the vehicle in the Audio/COMAND display.

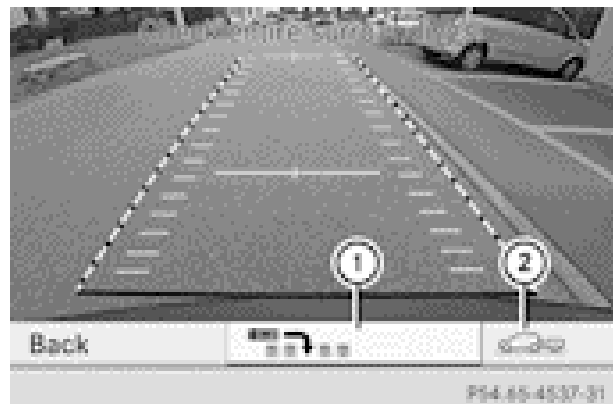

Function mode display for vehicles with COMAND Online and a trailer tow hitch

- ▶ **To change the function mode in vehicles with COMAND Online and trailer tow hitch:** using the COMAND controller, select symbol ① for the "Reverse parking"

function; see the separate COMAND Online operating instructions.

or

- ▶ Select symbol ② for the coupling up a trailer function (see the separate COMAND Online operating instructions). The symbol of the selected function is highlighted.

To deactivate: the reversing camera is deactivated if you:

- select transmission position **P** (vehicles with automatic transmission)
- drive forward ten metres
- for vehicles with an automatic transmission, shift the transmission from **R** to another position after 15 seconds
- shift out of reverse gear (vehicles with manual transmission) after 15 seconds
- drive forwards at a speed of over 10 km/h

Displays in the Audio/COMAND display

The reversing camera may show a distorted view of obstacles, show them incorrectly or not at all. Obstacles are not shown by the reversing camera in the following locations:

- very close to the rear bumper
- under the rear bumper
- in the area immediately above the tailgate handle

! Objects not at ground level may appear to be further away than they actually are, e.g.:

- the bumper of a parked vehicle
- the drawbar of a trailer
- the ball coupling of a trailer tow hitch
- the rear section of an HGV
- a slanted post

Use the guidelines only for orientation. Approach objects no further than the bottom-most guideline.

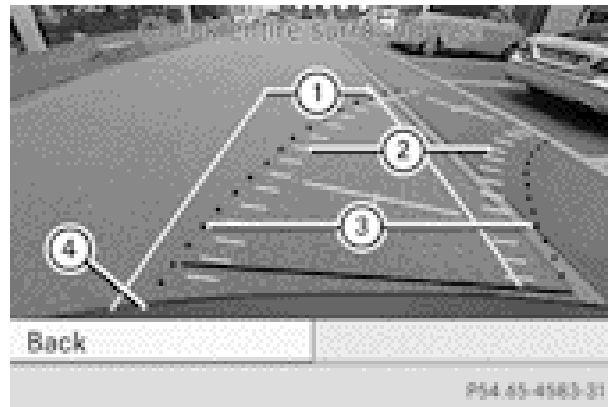

Lanes

- ① White guide line without turning the steering wheel, vehicle width including the exterior mirrors (static)
- ② Yellow lane marking the course the tyres will take at the current steering wheel angle, vehicle width including the outer edge of the wheel (dynamic)
- ③ Red guide line for the vehicle width including the exterior mirrors, for current steering wheel angle (dynamic)
- ④ Bumper

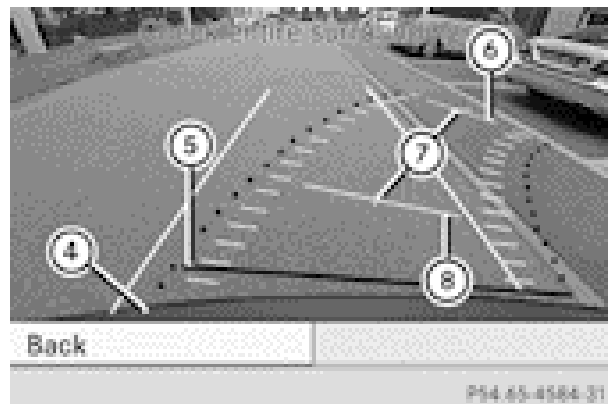

Guide lines

- ④ Bumper
- ⑤ Red guide line at a distance of approximately 0.25 m from the rear of the vehicle
- ⑥ Yellow guide line at a distance of approximately 4.0 m from the rear of the vehicle
- ⑦ Vehicle centre axle (marker assistance)
- ⑧ Yellow guide line at a distance of approximately 1.0 m from the rear of the vehicle

The lanes and guide lines are only displayed if you have engaged reverse gear.

The distance specifications only apply to objects that are at ground level.



Additional displays on vehicles with PARKTRONIC and COMAND Online

- ① Front warning display
- ② Additional PARKTRONIC operational readiness indicator
- ③ Rear warning display

Vehicles with PARKTRONIC and COMAND Online: when PARKTRONIC is operational (▷ page 182), additional operational readiness indicator ② appears in the COMAND display. If the PARKTRONIC warning displays are active or light up, warning displays ① and ③ are also active or light up correspondingly in the COMAND display.

Reverse parking function

- ▶ Make sure that the reversing camera is activated and the "Reverse parking" function is selected; see the separate operating instructions for the audio system/COMAND Online.
The lane and the guide lines are shown.

Reversing straight into a parking space without turning the steering wheel



- ① White lane indicating the route the vehicle will take with the steering wheel straight
- ② Yellow guide line at a distance of approximately 1.0 m from the rear of the vehicle
- ③ Red guide line at a distance of approximately 0.25 m from the rear of the vehicle

- ▶ With the help of white lane ①, check whether the vehicle will fit into the parking space.
- ▶ Using the white lane as a guide, carefully reverse until you reach the end position. Red guide line ③ is then at the end of the parking space. The vehicle is almost parallel in the parking space.

Reverse perpendicular parking with the steering wheel at an angle

- ▶ Drive past the parking space and bring the vehicle to a standstill.

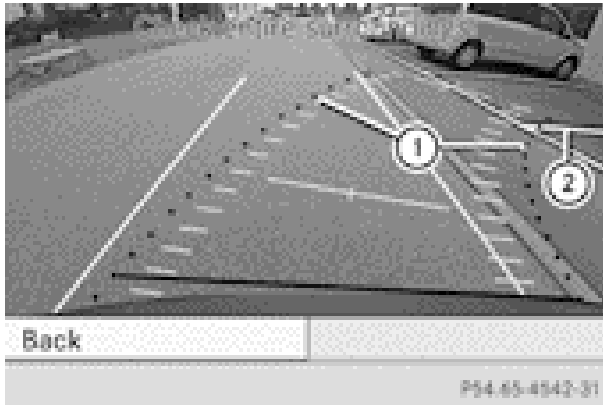

Turning the steering wheel

- ① Red lane indicating the route the vehicle will take with the steering wheel in its current position
- ② Parking space marking
- ▶ While the vehicle is at a standstill, turn the steering wheel in the direction of the parking space until the red lane reaches parking space marking ②.
- ▶ Keep the steering wheel in that position and reverse carefully.

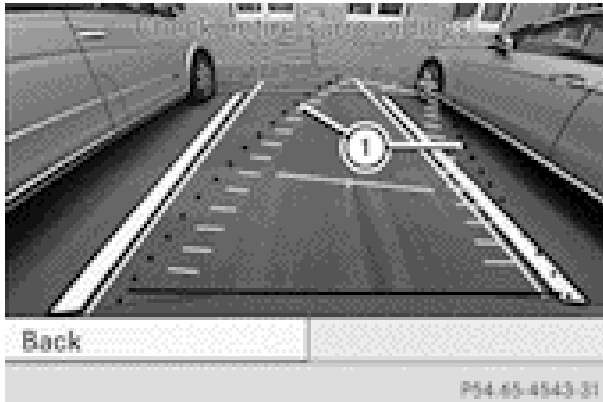

Reversing with the steering wheel turned

- ① Red lane indicating the route the vehicle will take with the steering wheel in its current position
- ▶ Stop the vehicle when it is almost exactly in front of the parking space. The white lane should be as close to parallel with the parking space marking as possible.



Driving to the final position

- ① White lane indicating the route the vehicle will take with the steering wheel in its current position
- ② Parking space marking
- ▶ Turn the steering wheel to the centre position while the vehicle is stationary.

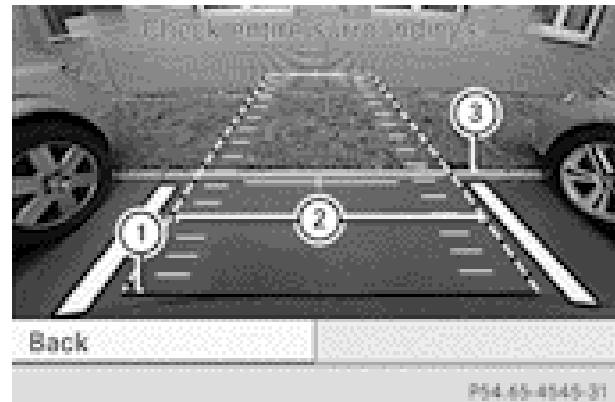

- ① Red guide line at a distance of approximately 0.25 m from the rear of the vehicle
- ② White lane indicating the route the vehicle will take with the steering wheel straight
- ③ End of parking space
- ▶ Reverse carefully until you have reached the end position. Red guide line ① is then at end of parking space ③. The vehicle is almost parallel in the parking space.

"Coupling up a trailer" function

This function is only available on vehicles with a trailer tow hitch and COMAND Online.

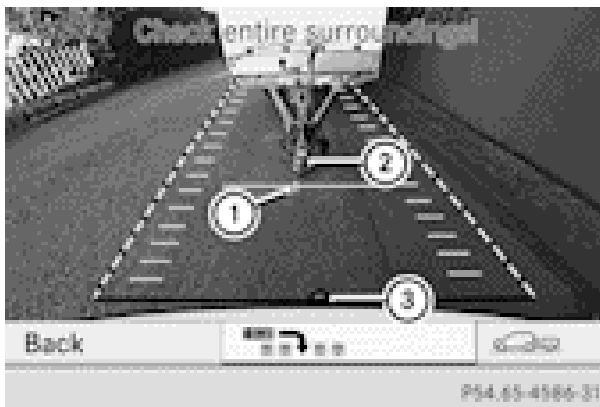

- ① Vehicle centre point on the yellow guide line at a distance of approximately 1.0 m from the rear of the vehicle
 - ② Trailer drawbar
 - ③ Ball coupling
- ▶ Set the height of trailer drawbar ② so that it is slightly higher than ball coupling ③.
 - ▶ Position the vehicle centrally in front of trailer drawbar ②.

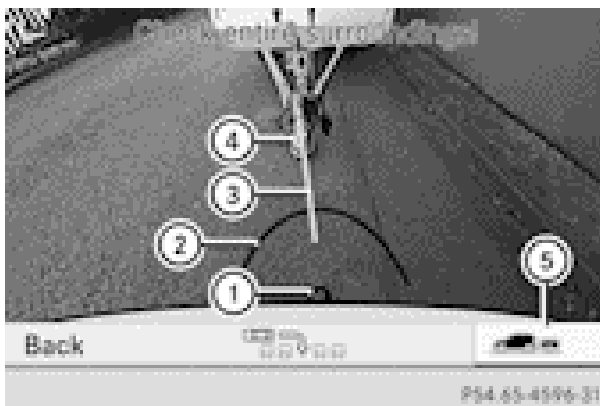

- ① Ball coupling
 - ② Red guide line at a distance of approximately 0.25 m from the ball coupling
 - ③ Trailer drawbar locating aid
 - ④ Trailer drawbar
 - ⑤ Symbol for the "Coupling up a trailer" function
- ▶ Select symbol ⑤ with the Audio/COMAND controller; see the separate operating instructions for the audio system/COMAND Online.
The "Coupling up a trailer" function is selected. The distance specifications now only

apply to objects that are at the same level as the ball coupling.

- ▶ Reverse carefully, making sure that trailer drawbar locating aid ③ points approximately in the direction of trailer drawbar ④.
- ▶ Reverse carefully until trailer drawbar ④ touches red guide line ②.
- ▶ Couple up the trailer (▶ page 201).

ATTENTION ASSIST

General notes

ATTENTION ASSIST helps you during long, monotonous journeys such as on motorways and trunk roads. It is active in the 80 km/h to 180 km/h range.

If ATTENTION ASSIST detects typical indicators of fatigue or increasing lapses in concentration on the part of the driver, it suggests taking a break.

Important safety notes

ATTENTION ASSIST is only an aid. It cannot always detect fatigue or lapses in concentration until too late or not at all. The system is not a substitute for a well-rested and attentive driver.

ATTENTION ASSIST assesses your level of fatigue or lapses in concentration by taking the following criteria into account:

- your personal driving style, e.g. steering characteristics
- journey-related parameters, e.g. time of day, length of journey

The functionality of ATTENTION ASSIST is restricted, and warnings may be delayed or not occur at all:

- if the road condition is poor, e.g. if the surface is uneven or if there are potholes
- if there is a strong side wind

- if you have adopted a sporty driving style with high cornering speeds or high rates of acceleration
- if you are predominantly driving slower than 80 km/h or faster than 180 km/h
- if you are currently using COMAND Online or making a telephone call with COMAND Online
- if the time has been set incorrectly
- in active driving situations, such as when you change lanes or change your speed

Warning and display messages in the multifunction display

- ▶ Activate ATTENTION ASSIST using the on-board computer (▷ page 219).

If ATTENTION ASSIST is active, you will be warned no sooner than 20 minutes after your journey has begun. You then hear an intermittent warning tone twice and the **Attention Assist: Take a break!** message appears in the multifunction display.

- ▶ If necessary, take a break.
- ▶ Press the **OK** or **↩** button to confirm the message.

On long journeys, take regular breaks in good time to allow yourself to rest properly. If you do not take a break, you will be warned again after 15 minutes at the earliest. This will only happen if ATTENTION ASSIST still detects typical indicators of fatigue or increasing lapses in concentration.

ATTENTION ASSIST is reset and starts assessing your tiredness again when you continue your journey if:

- you switch off the engine
- you take off your seat belt and open the driver's door, e.g. for a change of drivers or to take a break

When ATTENTION ASSIST is deactivated, the **OFF** symbol appears in the multifunction display in the assistance graphic display.

Speed Limit Assist

General notes

Speed Limit Assist shows you detected speed limits in the multifunction display. Data from the navigation system is also used for this purpose. If a traffic sign indicating a speed limit or the end of a speed limit is detected, it is shown in the multifunction display. If Speed Limit Assist does not detect any traffic signs, the speed limit from the digital road map is taken and shown in the display.

Speed Limit Assist detects the traffic signs with a camera attached behind the top of the windscreen.

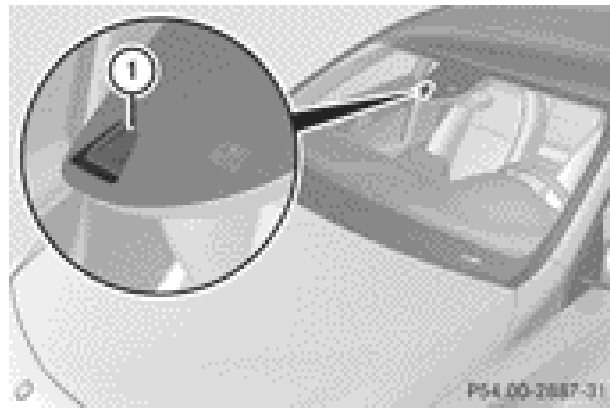

① Speed Limit Assist camera

Important safety notes

Speed Limit Assist is only an aid and does not always detect traffic signs specifying the maximum permissible speed. Traffic signs always have priority over the Speed Limit Assist display.

The system may be impaired or may not function if:

- there is poor visibility, e.g. due to snow, rain, fog or spray
- there is glare, e.g. from the sun or from oncoming traffic
- the windscreen is dirty, misted up or covered, for instance by a sticker, in the vicinity of the camera
- the traffic signs are covered, for instance by dirt, snow or trees

- the traffic signs are poorly illuminated
- there are ambiguous traffic signs, for instance near roadworks or on multi-lane roads

Information in the multifunction display

Briefly showing detected traffic signs in the multifunction display

- ▶ Activate the Speed Limit Assist warning function using the on-board computer (▷ page 218).
A traffic sign indicating a speed limit or the end of a speed limit appears in the multifunction display for around five seconds as soon as it is detected. Any other information in the multifunction display is hidden for this period.



- ① Maximum permissible speed (example)
- ② Maximum permissible speed for vehicles subject to the restriction in the additional sign (example)
- ③ Additional character in fog
- ④ Speed Limit Assist is available and switched on

Permanently showing detected traffic signs in the multifunction display

- ▶ Display the assistance graphic using the on-board computer (▷ page 217).
A traffic sign indicating a speed limit or the end of a speed limit appears in the multifunction display as soon as it is detected.

The traffic sign indicating a speed limit ① is generally displayed until:

- a traffic sign indicating the end of the speed limit is detected.
- you make a turn.
- you leave or enter a town.
- the road type changes (e.g. motorway, country road).
- you have travelled a certain minimum distance without the traffic sign being repeated or detected again.

Lane Tracking package

General notes

The Lane Tracking package consists of Blind Spot Assist (▷ page 198) and Lane Keeping Assist (▷ page 199).

Blind Spot Assist

Important safety notes

WARNING

Blind Spot Assist does not react to:

- vehicles overtaken too closely on the side, placing them in the blind spot area
- if you overtake these with a difference in speed in excess of 12 km/h
- or if they approach with a great relative speed and overtake you

As a result, Blind Spot Assist cannot warn drivers in these situations. There is a risk of an accident.

Always pay careful attention to the traffic situation and maintain a safe distance at the side of the vehicle.

Blind Spot Assist is only an aid. It may fail to detect some vehicles and is no substitute for attentive driving.

General notes

Blind Spot Assist uses a radar sensor system to monitor the areas on both sides of your vehicle. It supports you from speeds of 30 km/h. A warning display in the exterior mirrors draws your attention to vehicles detected in the monitored area. If you then switch on the corresponding turn signal to change lane, you will also receive an optical and audible collision warning. For this purpose, Blind Spot Assist uses sensors in the rear bumper.

The radar sensor system is switched off automatically in the vicinity of radio telescope facilities (▷ page 350).

For Blind Spot Assist to assist you when driving, the radar sensor system must be:

- activated (▷ page 223)
- operational

i In some countries you must deactivate the radar sensor system (▷ page 223).

For further information about the radar sensor system; see (▷ page 350).

Monitoring range of the sensors

In particular, the detection of obstacles can be impaired in the case of:

- dirt on the sensors or anything else covering the sensors
- poor visibility, e.g. due to fog, heavy rain or snow
- a narrow vehicle travelling in front, e.g. a motorcycle or a bicycle
- very wide lanes
- narrow lanes
- vehicles not driving in the middle of their lane
- barriers or other road boundaries

Vehicles in the monitoring range are then not indicated.

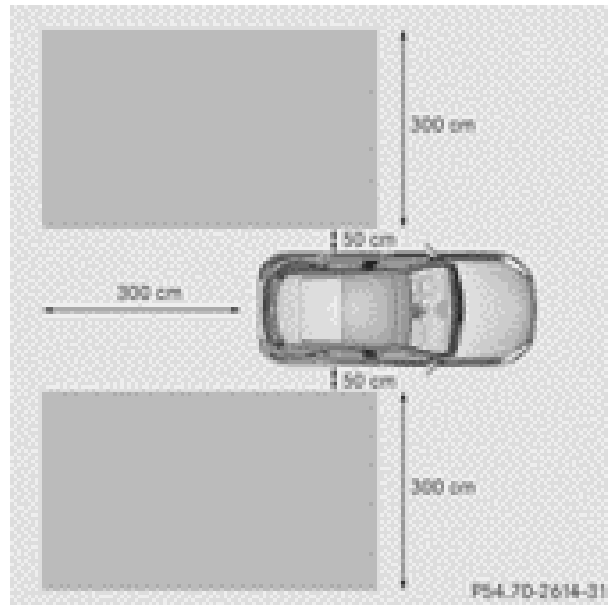

Blind Spot Assist monitors the area up to 3.0 m behind your vehicle and directly next to your vehicle, as shown in the diagram. For this purpose, Blind Spot Assist uses radar sensors in the rear bumper.

If the lanes are narrow, vehicles driving in the lane beyond the lane next to your vehicle may be indicated, especially if the vehicles are not driving in the middle of their lane. This may be the case if the vehicles are driving on the inner side of their lane.

Due to the nature of the system:

- warnings may be issued in error when driving close to crash barriers or similar solid lane borders.
- warnings may be interrupted when driving alongside particularly long vehicles, for example lorries, for a prolonged time.

The two sensors for Blind Spot Assist are integrated into the sides of the rear bumper. Make sure that the bumper is free of dirt, ice or slush in the vicinity of the sensors. The radar sensors must not be covered, for example by cycle racks or overhanging loads. Following a severe impact or in the event of damage to the bumpers, have the function of the radar sensors checked at a qualified specialist workshop. Blind Spot Assist may otherwise not work properly.

Indicator and warning display

Blind Spot Assist is not active at speeds below approximately 30 km/h. Vehicles in the monitoring range are then not indicated.

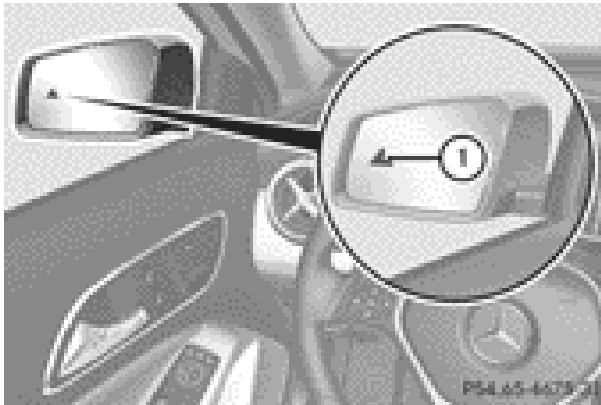

① Yellow indicator lamp/red warning lamp

If Blind Spot Assist is switched on, indicator lamp ① in the exterior mirrors lights up yellow up to a speed of 30 km/h. At speeds above 30 km/h, the indicator lamp goes out and Blind Spot Assist is operational.

If a vehicle is detected within the monitoring range of Blind Spot Assist at speeds above 30 km/h, warning lamp ① on the corresponding side lights up in red. This warning always occurs when a vehicle enters the blind spot monitoring range from behind or from the side. When you overtake a vehicle, the warning only occurs if the difference in speed is less than 12 km/h.

The yellow indicator lamp goes out if reverse gear is engaged. Blind Spot Assist is then deactivated.

The brightness of the indicator/warning lamps is adjusted automatically according to the ambient light.

Collision warning

If a vehicle is detected in the monitoring range of Blind Spot Assist and you switch on the corresponding turn signal, a double warning tone sounds. Red warning lamp ① flashes. If the turn signal remains on, detected vehicles are indicated by the flashing of red warning lamp ①. There are no further warning tones.

Activating Blind Spot Assist

- ▶ Make sure that the radar sensor system (▷ page 223) and Blind Spot Assist (▷ page 219) are activated in the on-board computer.
- ▶ Turn the key to position **2** in the ignition lock.
Warning lamps ① in the exterior mirrors light up red for approximately 1.5 seconds and then turn yellow.

Towing a trailer

If you attach a trailer, make sure that you have correctly established the electrical connection. This can be accomplished by checking the trailer lighting. Blind Spot Assist is then deactivated. The indicator lamp lights up yellow in the exterior mirrors and the **Blind Spot Assist currently unavailable** See Owner's Manual message appears in the multifunction display.

- i** You can deactivate the indicator lamps in the exterior mirrors.

To do so, switch off Blind Spot Assist if:

- the key is in position **2** in the ignition lock.
- the engine is not running.
- the electrical connection to the trailer has been established.

Lane Keeping Assist

General notes

Lane Keeping Assist monitors the area in front of your vehicle by means of a camera at the top of the windscreen. Lane Keeping Assist detects lane markings on the road and warns you before you leave your lane unintentionally.

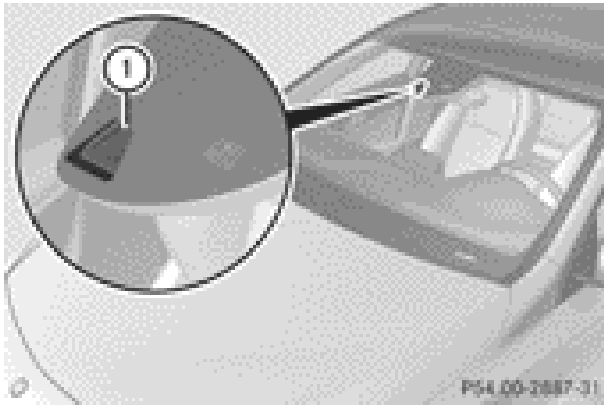

① Lane Keeping Assist camera

If you select **km** on the on-board computer in the **Display unit Speed-/odometer** function (▷ page 220), Lane Keeping Assist is active starting at a speed of 60 km/h. If the **miles** display unit is selected, the assistance range begins at 40 mph.

Important safety notes

⚠ WARNING

Lane Keeping Assist cannot always clearly identify lane markings.

In these cases, Lane Keeping Assist may:

- give an unnecessary warning
- not give a warning

There is a risk of an accident.

Always pay particular attention to the traffic situation and keep in lane, especially if Lane Keeping Assist alerts you.

⚠ WARNING

The Lane Keeping Assist warning does not return the vehicle to the original lane. There is a risk of an accident.

Always steer, apply the brakes or accelerate the vehicle yourself, especially if Lane Keeping Assist alerts you.

If you fail to adapt your driving style, Lane Keeping Assist can neither reduce the risk of an accident nor override the laws of physics. Lane Keeping Assist cannot take into account road, weather or traffic conditions. Lane Keeping Assist is only an aid. You are responsible for the distance to the vehicle in front,

for vehicle speed, for braking in good time, and for staying in the lane.

Lane Keeping Assist does not keep your vehicle in its lane.

The system may be impaired or may not function if:

- there is poor visibility, e.g. due to insufficient illumination of the road, or due to snow, rain, fog or spray
- there is glare, e.g. from oncoming traffic, the sun or reflection from other vehicles (e.g. if the road surface is wet)
- the windscreen is dirty, misted up, damaged or covered, for instance by a sticker in the vicinity of the camera
- no, or several, unclear lane markings are present for one lane, e.g. in a construction area
- the lane markings are worn away, dark or covered up, e.g. by dirt or snow
- the distance to the vehicle in front is too small and the lane markings thus cannot be detected
- the lane markings change quickly, e.g. lanes branch off, cross one another or merge
- the road is narrow and winding
- there are highly variable shade conditions on the road

A warning may be given if a front wheel passes over a lane marking. It will warn you by means of intermittent vibration in the steering wheel for up to 1.5 seconds.

Activating Lane Keeping Assist

- ▶ Activate Lane Keeping Assist using the on-board computer; to do so, select **Standard** or **Adaptive** (▷ page 219).

If you drive at speeds above 60 km/h and lane markings are detected, the lane markings in the assistance graphics display (▷ page 217) are shown in green.

When **Standard** is selected, no warning vibration occurs if:

- you have switched on the turn signals. In this event, the warnings are suppressed for a certain period of time.
- a driving safety system intervenes, such as ABS, BAS or ESP®.

When **Adaptive** is selected, no warning vibration occurs if:

- you have switched on the turn signals. In this case, the warnings are suppressed for a certain period of time.
- a driving safety system intervenes, such as ABS, BAS or ESP®.
- you accelerate hard, e.g. kickdown.
- you brake hard.
- you steer actively, e.g. swerve to avoid an obstacle or change lane quickly.
- you cut the corner on a sharp bend.

In order that you are warned only when necessary and in good time if you cross the lane marking, the system recognises certain conditions and warns you accordingly.

The warning vibration occurs earlier if:

- you approach the outer lane marking on a bend.
- the road has very wide lanes, e.g. a motorway.
- the system recognises solid lane markings.

The warning vibration occurs later if:

- the road has narrow lanes.
- you cut the corner on a bend.

Towing a trailer

Notes on towing a trailer

Important safety notes

WARNING

The braking system can overheat if you leave your foot on the brake pedal while driving. This increases the braking distance and could

even cause the braking system to fail. There is a risk of an accident.

Never use the brake pedal as a footrest. Do not simultaneously depress both the brake pedal and the accelerator pedal while driving.

WARNING

You could lose control of the vehicle/trailer combination if it begins to swerve. The vehicle/trailer combination could even overturn. There is a risk of an accident.

On no account should you attempt to straighten out the vehicle/trailer combination by increasing speed. Decrease your speed and do not countersteer. Brake if necessary.

WARNING

If the maximum the permissible load for a carrier system is exceeded, the carrier could come loose from the vehicle and endanger other road users. There is a risk of an accident and injury.

Never exceed the permissible noseweight when using a carrier.

- ! Depressing the brake pedal constantly results in excessive and premature wear to the brake pads.

Trailer towing is not permissible on the following models:

- A 45 AMG 4MATIC
- Vehicles with the AMG Sports package

If you exceed the maximum permissible noseweight of the trailer drawbar on the ball coupling, the following may become damaged:

- your vehicle
- the trailer
- the ball coupling
- the trailer tow hitch

The vehicle/trailer combination could become unstable.

If the noseweight used is lower than the minimum permissible noseweight, the vehicle/

trailer combination could also become unstable.

To avoid hazardous situations:

- make sure to check the noseweight before each journey.
- use a drawbar noseweight as close as possible to the maximum noseweight.
- do not exceed the maximum permissible noseweight.
- do not use a noseweight lower than the minimum permissible trailer drawbar noseweight.

When reversing the vehicle towards the trailer, make sure there is nobody between the trailer and the vehicle.

Couple and uncouple the trailer carefully. If you do not couple the trailer to the towing vehicle correctly, the trailer could become detached.

Make sure that the following values are not exceeded:

- the permissible trailer drawbar noseweight
- the permissible trailer load
- the permissible rear axle load of the towing vehicle
- the maximum permissible gross vehicle weight of both the towing vehicle and the trailer

The applicable permissible values, which must not be exceeded, can be found:

- in your vehicle documents
- on the identification plates of the trailer tow hitch and the trailer
- on the vehicle identification plate

If the values differ, the lowest value applies.

You will find the values approved by the manufacturer on the vehicle identification plates and those for the towing vehicle under "Technical data" (▷ page 349).

When towing a trailer, your vehicle's handling characteristics will be different in comparison to when driving without a trailer.

The vehicle/trailer combination:

- is heavier
- is restricted in its acceleration and gradient-climbing capability
- has an increased braking distance
- is affected more by strong crosswinds
- demands more sensitive steering
- has a larger turning circle

This can impair the vehicle's handling characteristics. Adapt your style of driving accordingly. Maintain a safe distance. Drive carefully.

When towing a trailer, always adjust your speed to the current road and weather conditions. Do not exceed the maximum permissible speed for your vehicle/trailer combination.

General notes

- ▶ When towing a trailer, set the tyre pressure on the rear axle of the towing vehicle for a maximum load; see the tyre pressure table in the fuel filler flap (▷ page 321).

Please note that when towing a trailer, PARKTRONIC (▷ page 182) and Blind Spot Assist (▷ page 197) availability is limited or not available at all.

- i** The height of the ball coupling changes with the load of the vehicle. If necessary, use a trailer with a height-adjustable drawbar.

You will find fitting dimensions and loads under "Technical data" (▷ page 348).

Driving tips

- i** Observe the notes on ESP® trailer stabilisation (▷ page 68).

The maximum permissible speed for vehicle/trailer combinations depends on the type of trailer. Before beginning the journey, check the trailer's documents to see what the maximum permitted speed is. Observe the legally

prescribed maximum speed in the relevant country.

For certain Mercedes-Benz vehicles, the maximum permissible rear axle load is increased when towing a trailer. Refer to the "Technical data" section to find out whether this applies to your vehicle. If you utilise any of the added maximum rear axle load when towing a trailer, the vehicle/trailer combination may not exceed a maximum speed of 100 km/h for reasons concerning the operating permit. This also applies in countries in which the permissible maximum speed for vehicle/trailer combinations is above 100 km/h.

When towing a trailer, your vehicle's handling characteristics will be different in comparison to when driving without a trailer and it will consume more fuel.

Change into a lower gear in good time on long and steep downhill gradients. For vehicles with automatic transmission, you need to have selected manual drive program **M** (▷ page 156).

- ❗ This also applies if you have activated cruise control, SPEEDTRONIC or DIS-TRONIC PLUS.

This will use the braking effect of the engine, so less braking will be required to maintain vehicle speed. This relieves the load on the brake system and prevents the brakes from overheating and wearing too quickly. If you need additional braking, depress the brake pedal repeatedly rather than continuously.

- ❗ Briefly depressing the accelerator pedal on downhill gradients while the manual drive program **M** is temporarily activated (vehicles with automatic transmission): the automatic transmission may switch back to the last active automatic drive program **E** or **S**. The automatic transmission may shift to a higher gear. This can reduce the engine's braking effect.

Driving tips

If the trailer swings from side to side:

- ▶ Do not accelerate.
- ▶ Do not countersteer.
- ▶ Brake if necessary.
 - Maintain a greater distance from the vehicle in front than when driving without a trailer.
 - Avoid braking abruptly. If possible, brake gently at first to allow the trailer to run on. Then, increase the braking force rapidly.
 - The values given for gradient-climbing capabilities from a standstill refer to sea level. When driving in mountainous areas, note that the power output of the engine, and consequently the vehicle's gradient-climbing capability, decrease with increasing altitude.

Folding out the ball coupling

WARNING

If you release the ball coupling or it does not engage correctly when folding in, it will swing out. Within pivoting range of the ball coupling, there is an increased risk of an accident and injury.

Only release the ball coupling if the pivoting range is unobstructed. Always make sure that the ball coupling engages when folding in.

Before you can tow a trailer with your vehicle, you must fold out the ball coupling.

The release wheel is located behind the left-hand side trim panel in the boot.

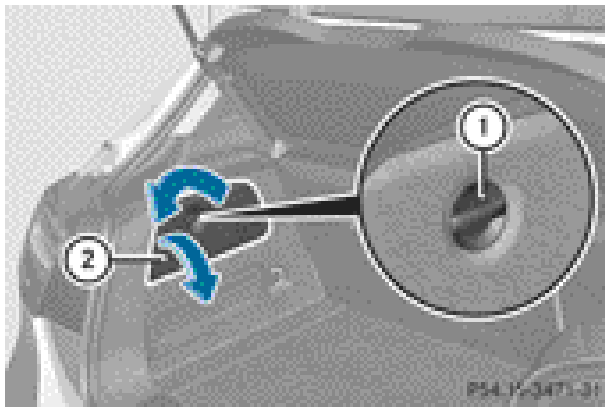

- ▶ **To open the cover:** turn handle ① anti-clockwise and fold down cover ② and remove it.

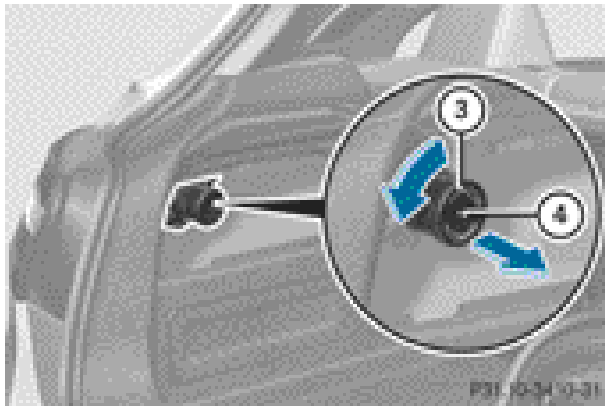

- ▶ Pull out release wheel ③.
- ▶ Turn release wheel ③ anti-clockwise as far as it will go.
The ball coupling disengages and folds out behind the rear bumper. Indicator lamp ④ flashes.



⚠ WARNING

If the ball coupling is not correctly engaged, the trailer can detach. There is a risk of an accident.

Always engage the ball coupling as described.

- ▶ Pull the ball coupling in the direction of the arrow until it engages in a vertical position. Indicator lamp ④ goes out. The power socket folds down automatically.
The multifunction display shows the **Check trailer hitch lock** display message until the ball coupling is engaged.
- ▶ Remove the protective covering from the ball coupling and store it in a safe place.
- ▶ Make sure that the ball of the ball coupling is clean and that it is either greased or dry (grease free), depending on the instructions for the trailer.

Coupling up a trailer

- ▶ Make sure that the transmission is in position **P**.
- ▶ Apply the electric parking brake.
- ▶ Position the trailer level behind the vehicle.
- ▶ Couple up the trailer.
- ▶ Establish the electric connection between the vehicle and the trailer.
- ▶ Check that the trailer lighting system is working.

A trailer that is connected is recognised only when the electrical connection is established correctly and when the lighting system is working properly. The function of other systems, such as ESP[®] or PARK-TRONIC also depends on this.

Uncoupling a trailer

⚠ WARNING

If you uncouple a trailer with an engaged over-run brake, you could trap your hand between

the vehicle and the trailer drawbar. This poses a risk of injury.

Do not uncouple a trailer with an engaged overrun brake.

- ❗ Do not disconnect a trailer with an engaged overrun brake. Otherwise, your vehicle could be damaged by the rebounding of the overrun brake.
- ❗ Remove the installed adapter cable before folding in the ball coupling. Otherwise, damage may occur to the rear bumper and the adapter cable.
- ▶ Make sure that the transmission is in position **P**.
- ▶ Apply the electric parking brake.
- ▶ Secure the trailer against rolling away.
- ▶ Remove the trailer cable and decouple the trailer.

Folding in the ball coupling

WARNING

If you release the ball coupling or it does not engage correctly when folding in, it will swing out. Within pivoting range of the ball coupling, there is an increased risk of an accident and injury.

Only release the ball coupling if the pivoting range is unobstructed. Always make sure that the ball coupling engages when folding in.

- ▶ Fold the ball coupling back in if you are not using the trailer tow hitch.
- ▶ Place the protective covering on the ball coupling.

The release wheel is located behind the left-hand side trim panel in the boot.

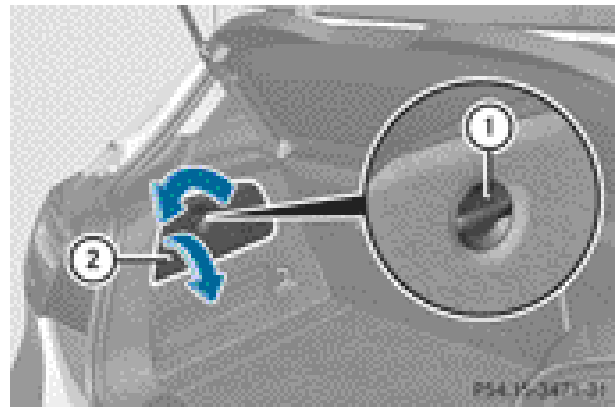

- ▶ **To open the cover:** turn handle ① anti-clockwise and fold down cover ② and remove it.

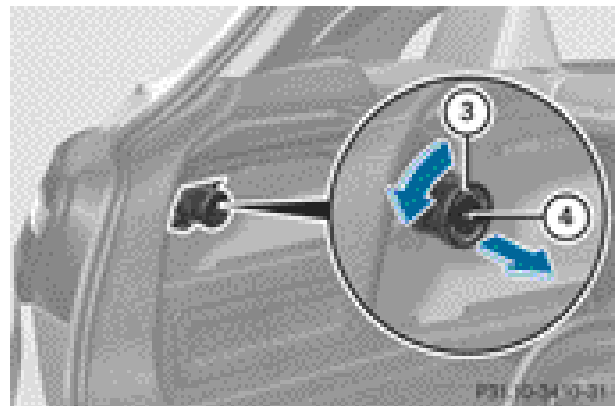

- ▶ Pull out release wheel ③.
- ▶ Turn release wheel ③ anti-clockwise as far as it will go.
The ball coupling disengages and folds out behind the rear bumper. Indicator lamp ④ flashes.



- ▶ Press the ball coupling in the direction of the arrow until it engages behind the bumper.
Indicator lamp ④ goes out and the message in the multifunction display disappears.

Trailer power supply

- ❗ You can connect accessories with a power rating of up to 240 W to the permanent power supply and with a power rating of up to 180 W to the power supply that is switched on via the ignition lock.

The trailer battery may not be charged from the power supply.

- ▶ **To switch the connected power supply on or off:** turn the key in the ignition lock to position **2** or **0** respectively.

When it leaves the factory, your vehicle's trailer socket is equipped with a permanent power supply and a power supply that is switched on via the ignition lock.

The permanent power supply is supplied via trailer socket pin 9.

The power supply that is switched on via the ignition lock is supplied via trailer socket pin 10.

The trailer's permanent power supply is switched off in the event of low vehicle supply voltage and after six hours at the latest.

You can find more information about installing the trailer electrics at a qualified specialist workshop.

Bulb failure indicator for LED lamps

- ❗ If LED lamps are fitted in the trailer, an error message may appear in the multifunction display even if there is no fault. The reason for the error message could be that the current has fallen below the minimum of 50 mA.

To ensure reliable operation of the bulb failure indicator, each LED chain in the trailer lighting must be guaranteed a minimum current of 50 mA.

Trailer with 7-pin connector

General notes

Trailer with 7-pin connector: you can connect to the 13-pin socket on the ball coupling using an adapter or, if necessary, an adapter cable. Both can be obtained at a qualified specialist workshop.

Fitting the adapter

- ❗ Make sure that there is sufficient cable play so that the cable cannot become detached when cornering.

- ❗ Remove the installed adapter cable before folding in the ball coupling. Otherwise, damage may occur to the rear bumper and the adapter cable.

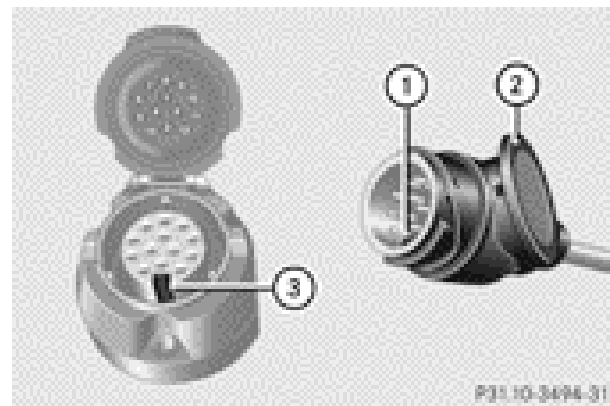

- ▶ Open the socket cover.
- ▶ Insert the plug connector with lug ① into groove ③ on the socket. Turn bayonet connection ② clockwise to the stop.
- ▶ Let the cover engage.
- ▶ If you are using an adapter cable, secure the cable to the trailer with cable ties.

Useful information	208
Important safety notes	208
Displays and operation	208
Menus and submenus	211
Display messages	229
Warning and indicator lamps in the instrument cluster	257

Useful information

- i** This Owner's Manual describes all models, series and optional equipment for your vehicle that were available at the time of going to press. National variations are possible. Note that your vehicle may not be equipped with all of the functions described. This is also the case for systems and functions relevant to safety.
- i** Read the information on qualified specialist workshops: (▷ page 24).

Important safety notes

WARNING

Operating the integrated information systems and communications equipment in the vehicle while driving will distract you from traffic conditions. You could then lose control of the vehicle. There is a risk of an accident.

Only operate these devices if road traffic conditions permit. If you are unsure about the surrounding conditions, pull over to a safe location and make entries only while the vehicle is stationary.

WARNING

If the instrument cluster has failed or malfunctioned, you may not recognise function restrictions relevant to safety. The operating safety of your vehicle may be impaired. There is a risk of an accident.

Drive on carefully. Have the vehicle checked at a qualified specialist workshop immediately.

You must observe the legal requirements for the country in which you are currently driving when operating the on-board computer.

The on-board computer only shows messages or warnings from certain systems in the multifunction display. You should therefore make sure your vehicle is operating safely at all

times. Otherwise, a vehicle that is not operating safely may cause an accident.

For an overview, see the instrument panel illustration (▷ page 30).



Displays and operation

Instrument cluster lighting

The lighting in the instrument cluster, in the displays and the controls in the vehicle interior can be adjusted using the brightness control knob.

The brightness control knob is on the bottom left of the instrument cluster (▷ page 30).

- ▶ Turn the brightness control knob clockwise or anti-clockwise.

If the light switch is set to **AUTO**,  or , the brightness is dependant upon the brightness of the ambient light.

- i** The light sensor in the instrument cluster automatically controls the brightness of the multifunction display.

In daylight, the displays in the instrument cluster are not illuminated.

Coolant temperature gauge

The coolant temperature gauge is in the instrument cluster on the right-hand side.

The reading may rise up to 120 °C below normal driving conditions if the coolant has been filled correctly.

At high outside temperatures and when driving uphill, the coolant temperature may rise to the end of the scale.

Rev counter

- !** Do not drive in the overrevving range. Doing so will damage the engine.

The red band in the rev counter indicates the engine's overrevving range.

The fuel supply is interrupted to protect the engine when the red band is reached.

Outside temperature display

You should pay special attention to road conditions when temperatures are around the freezing point.

The outside temperature display is in the multifunction display.

Changes in the outside temperature are displayed after a short delay.

Speedometer with segments

The segments in the speedometer indicate which speed range is available.

- Cruise control activated (▷ page 168):
The segments light up from the stored speed to the maximum speed.
- Variable SPEEDTRONIC activated (▷ page 171):
The segments light up from the start of the scale to the selected limit speed.
- DISTRONIC PLUS activated (▷ page 173):
One or two segments in the set speed range light up.
- DISTRONIC PLUS detects a vehicle in front:
The segments between the speed of the vehicle in front and the stored speed light up.

Operating the on-board computer

Overview

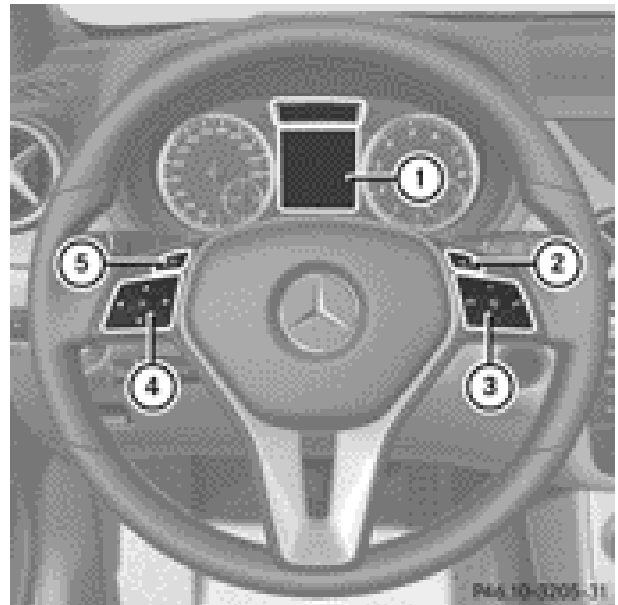







- ① Multifunction display
- ② Switches on LINGUATRONIC; see the separate operating instructions
- ③ Right control panel
- ④ Left control panel
- ⑤ Back button



► **To activate the on-board computer:** turn the key to position **1** in the ignition lock.



You can control the multifunction display and the settings in the on-board computer using the buttons in the multifunction steering wheel.

Left control panel



	<ul style="list-style-type: none"> • Calls up the menu and menu bar
	
	Press briefly: <ul style="list-style-type: none"> • Scrolls through lists • Selects a submenu or function • In the Audio menu: selects a stored station, an audio track or a video scene • In the Tel(telephone) menu: switches to the phone book and selects a name or telephone number
	
	Press and hold: <ul style="list-style-type: none"> • In the Audio menu: selects the previous/next station or selects an audio track or a video scene using rapid scrolling • In the Tel (Telephone) menu, starts rapid scrolling through the phone book
	
	<ul style="list-style-type: none"> • Confirms selection/display message • In the Tel (telephone) menu: switches to the telephone book and starts dialling the selected number • In the Audio menu: stops the station search function at the desired station

Right control panel

	<ul style="list-style-type: none"> • Rejects or ends a call • Exits telephone book/redial memory
	<ul style="list-style-type: none"> • Makes or accepts a call • Switches to the redial memory

	• Adjusts the volume
	
	• Mute

Back button

	Press briefly: <ul style="list-style-type: none"> • Back • Switches off LINGUATRONIC; see the separate operating instructions • Hides display messages/calls up the last Trip menu function used • Exits the telephone book/redial memory
	Press and hold: <ul style="list-style-type: none"> • Calls up the standard display in the Trip menu

Multifunction display

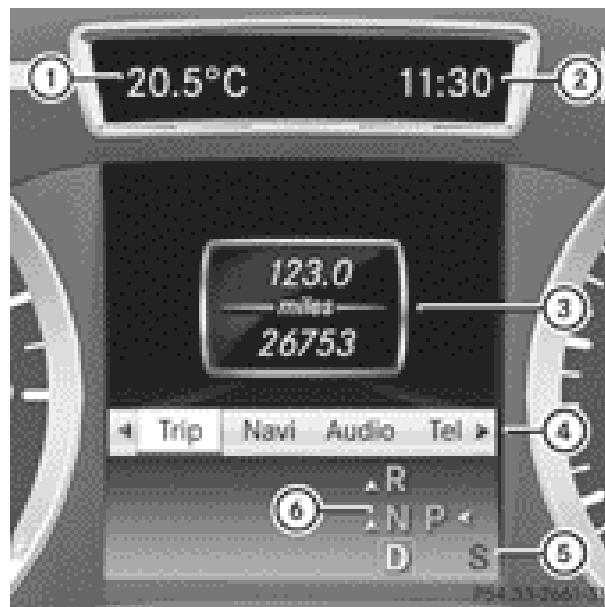

Multifunction display (example: vehicles with automatic transmission)

- ① Permanent display: outside temperature or speed (▷ page 220)
- ② Time
- ③ Text field



- ④ Menu bar
- ⑤ Drive program (▷ page 152)
- ⑥ Transmission position (▷ page 152)

► **To show the menu bar ④:** press the ◀ or ▶ button on the steering wheel.

Menu bar ④ disappears after a few seconds. Text field ③ shows the selected menu or submenu as well as display messages.

i You can set the time using the audio system or COMAND Online; see the separate operating instructions.

The following messages may appear in the multifunction display:

- ↑ Gearshift recommendation, for manual transmission (▷ page 151) or automatic transmission (▷ page 156)
- ← P → Active Parking Assist (▷ page 186)
-  Cruise control (▷ page 168)
- LIM** SPEEDTRONIC (▷ page 171)
-  Adaptive Highbeam Assist (▷ page 110)
- ECO** ECO start/stop function (▷ page 146)
- HOLD** HOLD function (▷ page 179)
- 120 km/h!** Maximum permissible speed exceeded (only for certain countries)

Menus and submenus

Menu overview

Operating the on-board computer (▷ page 209).

Depending on the equipment fitted in the vehicle, you can call up the following menus:

- **Trip** menu (▷ page 211)
- **Navi** menu (navigation instructions) (▷ page 213)
- **Audio** menu (▷ page 214)

- **Te1** (telephone) menu (▷ page 215)
- **Assist** (Assistance) menu (▷ page 217)
- **Serv.** menu (▷ page 219)
- **Settings** menu (▷ page 220)
- **AMG** menu in AMG vehicles (▷ page 226)

The **Audio**, **Navi** and **Te1** menus differ slightly in vehicles with Audio 5, Audio 20 and in vehicles with COMAND Online. The examples given in this Owner's Manual apply to vehicles equipped with COMAND Online.

Trip menu

Standard display

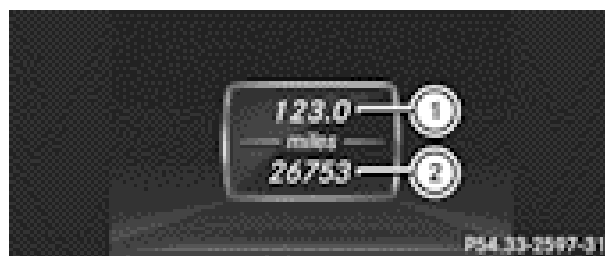



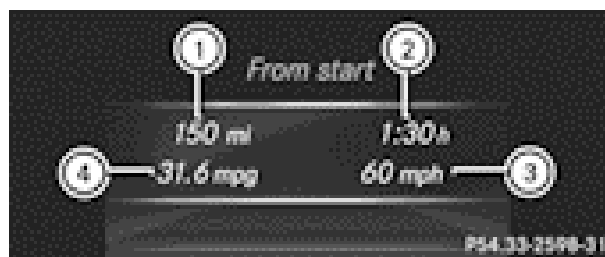

► Press and hold the ◀ button on the steering wheel until the **Trip** menu with trip meter ① and total distance recorder ② is shown.

Trip computer "From start" or "From reset"



Example: "From start" trip computer

- ① Distance
- ② Time
- ③ Average speed
- ④ Average fuel consumption

- ▶ Press the  or  button on the steering wheel to select the **Trip** menu.
- ▶ Press the  or  button to select **From start** or **From reset**.

The values in the **From start** submenu are calculated from the start of a journey, whilst the values in the **From reset** submenu are calculated from the last time the submenu was reset (▷ page 213).

The **From start** trip computer is automatically reset when:



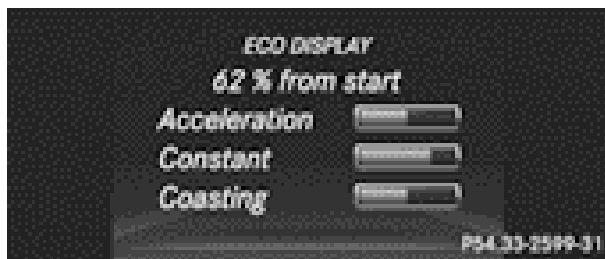

- the ignition has been switched off for more than four hours.
- 999 hours have been exceeded.
- 9,999 kilometres have been exceeded.

The **From reset** trip computer is automatically reset if the value exceeds 9,999 hours or 99,999 kilometres.

ECO display



Example: ECO display





- ▶ Press the  or  button on the steering wheel to select the **Trip** menu.
- ▶ Press the  or  button to select **ECO DISPLAY**.

If the ignition remains switched off for longer than four hours, the ECO display will be automatically reset.

For further information on the ECO display, see (▷ page 165).

Displaying the range and current fuel consumption



- ▶ Press the  or  button on the steering wheel to select the **Trip** menu.
- ▶ Press the  or  button to select current fuel consumption ② (not for AMG vehicles) and approximate range ①.



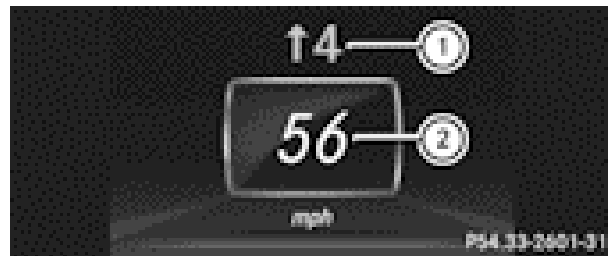

The approximate range that can be covered is calculated according to your current driving style and the amount of fuel in the tank. If there is only a small amount of fuel left in the fuel tank, the display shows a vehicle being refuelled  instead of the range.

Digital speedometer



- ① Gearshift recommendation, manual transmission (▷ page 151) or automatic transmission (▷ page 156)
- ② Digital speedometer

Gearshift recommendation ① is not given on AMG vehicles.

- ▶ Press the  or  button on the steering wheel to select the **Trip** menu.
- ▶ Press the  or  button to select the digital speedometer.

Resetting values

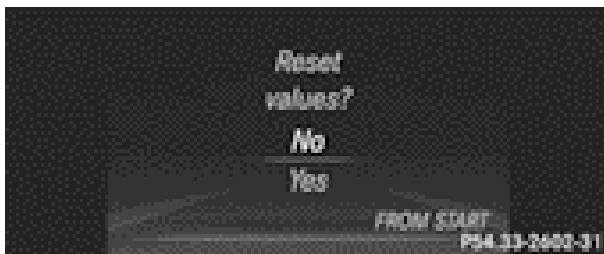

Example: resetting the "From start" trip computer
 You can reset the values of the following functions:

- trip meter
- "From start" trip computer
- "From reset" trip computer
- ECO display
- ▶ Press the ◀ or ▶ button on the steering wheel to select the **Trip** menu.
- ▶ Press the ▲ or ▼ button to select the function that you wish to reset.
- ▶ Press the **OK** button.
- ▶ Press the ▼ button to select **Yes** and press **OK** to confirm.

i If you reset the values in the ECO display, the values in the "From start" trip computer are also reset. If you reset the values in the "From start" trip computer, the values in the ECO display are also reset.

Navigation menu

Displaying navigation instructions

- ▶ Switch on the audio system or COMAND Online; see the separate operating instructions.
- ▶ Press the ◀ or ▶ button on the steering wheel to select the **Navi** menu.

In the **Navi** menu, the multifunction display shows navigation instructions. For more information, see the separate operating instructions.

Route guidance not active

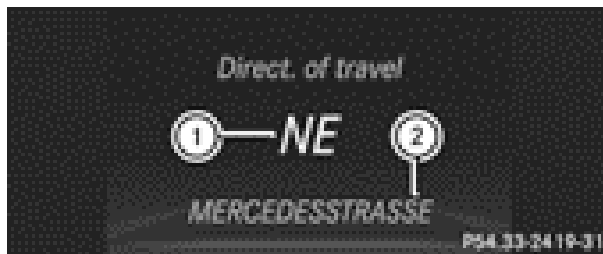

- ① Direction of travel
- ② Current road

Activating route guidance

No change of direction announced



- ① Distance to the destination
- ② Distance to the next change of direction
- ③ Current road
- ④ Symbol indicating "follow the road's course"

Change of direction announced without a lane recommendation



- ① Road to which the change of direction leads
- ② Distance to change of direction and visual distance display
- ③ Change-of-direction symbol

When a change of direction is announced, you will see symbol ③ for the change of direction and distance graphic ②. This shortens towards the top of the display as you

approach the point of the announced change of direction.

Change of direction announced with a lane recommendation

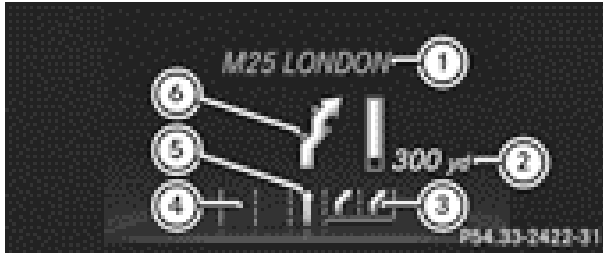

Example: change of direction announced with lane recommendation (colour multifunction display)

- ① Road to which the change of direction leads
- ② Distance to change of direction and visual distance display
- ③ New lane during a change of direction
- ④ Lane continues through change of direction
- ⑤ Lane recommendation
- ⑥ Change-of-direction symbol

On multilane roads, the system can display a new lane recommendation ③ for the next change of direction. During the change of direction, additional lanes may be displayed. Lane recommendations are only displayed if the relevant data is available on the digital map.

Other status indicators of the navigation system

- : you have reached the destination or an intermediate destination.
- **New route...** or **Calculating route:** calculating a new route
- **Off map** or **Off road:** the vehicle position is outside the area of the digital map (off-map position).
- **No route:** no route could be calculated to the selected destination.

Audio menu

Selecting a radio station



- ① Waveband
- ② Station frequency with memory position

i The memory position is only displayed along with station ② if this has been stored.

- ▶ Switch on the audio system or COMAND Online and select Radio; see the separate operating instructions.
- ▶ Press the or button on the steering wheel to select the **Audio** menu.
- ▶ **To select a stored station:** briefly press the or button.
- ▶ **To select a station from the station list:** press and briefly hold the or button.

If no station list is received:

- ▶ **To select a station using the station search:** press and briefly hold the or button.

i For information on changing waveband and storing stations, see the separate operating instructions.

i DAB radio mode (**D**igital **A**udio **B**roadcasting); see the separate operating instructions.

Audio player or audio media operation



Example: CD/DVD changer display

① Current track

Audio data from various audio devices or media can be played, depending on the equipment fitted in the vehicle.

- ▶ Switch on the audio system or COMAND Online and select audio CD, audio DVD or MP3 mode; see the separate operating instructions.
- ▶ Press the ◀ or ▶ button on the steering wheel to select the **Audio** menu.
- ▶ **To select the next/previous track:** briefly press the ▲ or ▼ button.
- ▶ **To select a track from the track list (rapid scrolling):** press and hold the ▲ or ▼ button until the desired track has been reached.

If you press and hold the ▲ or ▼ button, the rapid scrolling speed is increased. Not all audio devices or media support this function.

If track information is stored on the audio player or medium, the multifunction display will show the number and title of the track. The current track does not appear in audio AUX mode (**A**uxiliary audio mode: external audio source connected).

TV operation

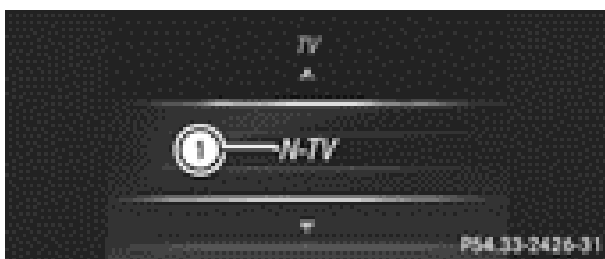

① If channel ① has been stored, the system displays the associated preset as well.

- ▶ Switch on COMAND Online and select TV; see the separate operating instructions.
- ▶ Press the ◀ or ▶ button on the steering wheel to select the **Audio** menu.
- ▶ **To select a stored channel:** briefly press the ▲ or ▼ button.
- ▶ **To select a channel from the channel list:** press and briefly hold the ▲ or ▼ button.

① To store a TV channel, see the separate operating instructions.

Video DVD operation



Example: CD/DVD changer display

① Current scene

- ▶ Switch on COMAND Online and select video DVD; see the separate operating instructions.
- ▶ Press the ◀ or ▶ button on the steering wheel to select the **Audio** menu.
- ▶ **To select the next or previous scene:** briefly press the ▲ or ▼ button.
- ▶ **To select a scene from the scene list (rapid scrolling):** press and hold the ▲ or ▼ button until desired scene has been reached.

Telephone menu

Introduction

⚠ WARNING

Operating the integrated information systems and communications equipment in the vehicle

while driving will distract you from traffic conditions. You could then lose control of the vehicle. There is a risk of an accident.

Only operate these devices if road traffic conditions permit. If you are unsure about the surrounding conditions, pull over to a safe location and make entries only while the vehicle is stationary.

When telephoning, you must observe the legal requirements for the country in which you are currently driving.

- ▶ Switch on your mobile phone and audio system or COMAND Online, see the separate operating instructions.
- ▶ Place a mobile phone in the mobile phone bracket (▷ page 279), or establish a Bluetooth® connection with the audio system or COMAND Online (see the separate operating instructions).
- ▶ Press the ◀ or ▶ button on the steering wheel to select the **Te1** menu.

You will see one of the following display messages in the multifunction display:

- **Please enter PIN:** the mobile phone has been placed in the mobile phone bracket and the PIN has not been entered.

When you enter your PIN via the mobile phone, LINGUATRONIC, the audio system or COMAND Online, the mobile phone searches for a network.

- **Telephone ready** or the name of the network provider: the mobile phone has found a network and is ready to receive.
- **Telephone No service:** there is no network available or the mobile phone is searching for a network.

i You can obtain further information about suitable mobile phones and connecting mobile phones via Bluetooth®:

- from any Mercedes Benz Service Centre
- on the Internet at: <http://www.mercedes-benz.com/connect>

Accepting a call



Example: incoming call

- ▶ Press the  button on the steering wheel to accept an incoming call.

If someone calls you when you are in the **Te1** menu, a display message appears in the multifunction display.

If you are not in the **Te1** menu, you can still accept a call.

Rejecting or ending a call

- ▶ Press the  button on the steering wheel.

If you are not in the **Te1** menu, you can still reject or end a call.

Dialling a number from the phone book







- ▶ Press the ◀ or ▶ button on the steering wheel to select the **Te1** menu.
- ▶ Press the ▲, ▼ or **OK** button to switch to the phone book.
- ▶ Press the ▲ or ▼ button to select the desired name.
To start scrolling rapidly, press and hold the ▲ or ▼ button for longer than one second.

Rapid scrolling stops when you release the button or reach the end of the list.

- ▶ **If only one telephone number is stored for a name:** press the  or **OK** button to start dialling.







or

- ▶ **If there is more than one number for a particular name:** press the  or **OK** button to display the numbers.



- ▶ Press the  or  button to select the number you want to dial.
 - ▶ Press the  or  button to start dialing.
- or
- ▶ **If you do not want to make a call:** press the  or  button.

Redialling

The on-board computer saves the last names or numbers dialled in the redial memory.

- ▶ Press the  or  button on the steering wheel to select the **Te1** menu.
- ▶ Press the  button to switch to the redial memory.
- ▶ Press the  or  button to select the desired name or number.
- ▶ Press the  or  button to start dialing.

or

- ▶ **If you do not want to make a call:** press the  or  button.

Assistance menu

Introduction







In the **Assist.** menu, you have the following options:

- Showing the assistance graphic
- Showing Speed Limit Assist and activating/deactivating its message function
- Activating/deactivating ESP®
- Activating/deactivating the distance warning function





- Activating/deactivating ATTENTION ASSIST
- Activating/deactivating Blind Spot Assist
- Activating/deactivating Lane Keeping Assist

Showing the assistance graphic

- ▶ Press the  or  button on the steering wheel to select the **Assist.** menu.
- ▶ Press the  or  button to select **Assistance graphic.**
- ▶ Press the  button.
The multifunction display shows the DISTRONIC PLUS distance display in the assistance graphic (▷ page 175).





The assistance graphic can display the status of and information from other driving systems or driving safety systems.

The assistance graphic shows:







- the  symbol when the rear window wiper (▷ page 118) is activated
 - the  symbol when ATTENTION ASSIST (▷ page 195) is deactivated
 - the lane markings as bright lines when Lane Keeping Assist (▷ page 199) is activated
 - the  symbol when Speed Limit Assist (▷ page 196) is operational and the message function is activated
- The assistance graphic can also display traffic signs that are detected and indicate speed limits.
- the  symbol when the distance warning function (▷ page 62) is deactivated

Speed Limit Assist

Displaying Speed Limit Assist

- ▶ Press the  or  button on the steering wheel to select the **Assist.** menu.
- ▶ Press the  or  button to select **Speed Limit Assist.**
- ▶ Press the  button.
Under certain conditions, detected speed limits are shown in the multifunction display (▷ page 196).

Activating/deactivating the Speed Limit Assist message function

- ▶ Press the  or  button on the steering wheel to select the **Assist.** menu.
- ▶ Press the  or  button to select **Speed Limit Assist.**
- ▶ Press the  button.
The multifunction display shows Speed Limit Assist.
- ▶ Press the  button.
The current selection is displayed.
- ▶ **To activate or deactivate:** press .
If the Speed Limit Assist message function is activated, a detected speed limit is automatically displayed for five seconds. Other items in the multifunction display are not shown during this time.

When Speed Limit Assist is operational and the message function is activated, the assistance graphic shows the  symbol.

Deactivating/activating ESP®

- i** Observe the "Important safety notes" section in the description of ESP (▷ page 65).

WARNING

If you deactivate ESP®, ESP® no longer stabilises the vehicle. There is an increased risk of skidding and an accident.







Only deactivate ESP® in the situations described in the following.



It may be best to deactivate ESP® in the following situations:

- when using snow chains
- in deep snow
- on sand or gravel

Deactivating/activating ESP® on AMG vehicles (▷ page 66).

For further information about ESP®, see (▷ page 65).







- ▶ Start the engine.
- ▶ Press the  or  button on the steering wheel to select the **Assist.** menu.
- ▶ Press the  or  button to select **ESP.**
- ▶ Press the  button.
- ▶ **To activate/deactivate:** press the  button again.
ESP® is deactivated if the  warning lamp in the instrument cluster lights up continuously when the engine is running.

If the  warning lamp and the  warning lamp are lit continuously, ESP® is not available due to a malfunction.

Observe the information on warning lamps (▷ page 260).

Observe the information on display messages (▷ page 230).

Activating/deactivating the distance warning function

- ▶ Press the  or  button on the steering wheel to select the **Assist.** menu.
- ▶ Press the  or  button to select **Distance warning.**
- ▶ Press the  button.
The current selection is displayed.
- ▶ **To activate/deactivate:** press the  button again.
When the distance warning function is deactivated, the  symbol appears in the multifunction display in the assistance graphics display.

Further information on the distance warning function (▷ page 62).

Activating/deactivating ATTENTION ASSIST

- ▶ Press the ◀ or ▶ button on the steering wheel to select the **Assist.** menu.
- ▶ Press the ▲ or ▼ button to select **ATTENTION ASSIST.**
- ▶ Press the **OK** button.
The current selection is displayed.
- ▶ **To activate/deactivate:** press the **OK** button again.
When ATTENTION ASSIST is deactivated, the **OFF** symbol appears in the multifunction display in the assistance graphics display.

For further information about ATTENTION ASSIST, see (▷ page 195).

Activating/deactivating Blind Spot Assist

- ▶ Press the ◀ or ▶ button on the steering wheel to select the **Assist.** menu.
- ▶ Press the ▲ or ▼ button to select **Blind Spot Assist.**
- ▶ Press the **OK** button.
The current selection is displayed.
- ▶ **To activate/deactivate:** press the **OK** button again.

For further information about Blind Spot Assist, see (▷ page 197).

When the **Blind Spot Assist Sensors deactivated** message is shown, the radar sensors are deactivated.

- ▶ Switch on the radar sensor system (▷ page 223).

Activating/deactivating Lane Keeping Assist

- ▶ Press the ◀ or ▶ button on the steering wheel to select the **Assist.** menu.
- ▶ Press the ▲ or ▼ button to select **Lane Keeping Assist.**
- ▶ Press the **OK** button.
The current selection is displayed.
- ▶ Press **OK** to confirm.
- ▶ Press the ▼ or ▲ button to set **Off**, **Standard** or **Adaptive.**
- ▶ Press the **OK** button to save the setting.
When Lane Keeping Assist is activated, the multifunction display shows the lane markings as bright lines in the assistance graphic.

For further information about Lane Keeping Assist, see (▷ page 199).

Service menu



In the **Serv.** menu, you have the following options:

- Calling up display messages in the message memory (▷ page 229)
- Restarting the tyre pressure loss warning system (▷ page 323)
- Calling up the service due date (▷ page 289)

Settings menu

Introduction



In the **Settings** menu, you have the following options:

- changing the instrument cluster settings
- changing the light settings
- changing the vehicle settings
- changing the auxiliary heating settings (▷ page 224)
- changing the convenience settings
- restoring the factory settings

Instrument cluster

Selecting the unit of measurement for distance

You can determine whether the multifunction display shows some messages in miles or kilometres.

- ▶ Press the or button on the steering wheel to select the **Settings** menu.
- ▶ Press the or button to select the **Inst. cluster** submenu.
- ▶ Press to confirm.
- ▶ Press the or button to select the **Display unit Speed-/odometer**: function.
You will see the selected setting **km** or **miles**.
- ▶ Press the button to save the setting.

The selected unit of measurement for distance applies to:

- the digital speedometer in the **Trip** menu
- the total distance recorder and the trip meter

- the trip computer
- the current consumption and the range
- the navigation instructions in the **Navi** menu
- cruise control
- SPEEDTRONIC
- DISTRONIC PLUS
- ASSYST PLUS service interval display

Switching the additional speedometer on/off

Only vehicles with manual transmission have this function.

- ▶ Press the or button on the steering wheel to select the **Settings** menu.
- ▶ Press the or button to select the **Inst. cluster** submenu.
- ▶ Press to confirm.
- ▶ Press or to select the **Dig. speedo [mph]**: function.
You will see the selected setting: **Activated** or **Deactivated**.
- ▶ Press the button to save the setting.

i The speed is displayed in mph.

i Vehicles for the United Kingdom: this function is unavailable.



The **Dig. speedo [mph]** function allows you to choose whether the status area in the multifunction display always shows the speed in **mph** instead of the outside temperature.

Selecting the permanent display function

i Vehicles for the United Kingdom: this function is unavailable.

You can determine whether the multifunction display permanently shows your speed or the outside temperature.

- ▶ Press the or button on the steering wheel to select the **Settings** menu.
- ▶ Press the or button to select the **Inst. cluster** submenu.
- ▶ Press to confirm.









- ▶ Press the  or  button to select the **Permanent display:** function.
You will see the selected setting: **outside temperature** or **Dig. speedo [mph]**.
- ▶ Press the  button to save the setting.

i The speed is displayed in mph.

Lights









Switching the daytime driving lights on/off

The **Daytime driving lights** function can only be switched on with the engine turned off.

- ▶ Press the  or  button on the steering wheel to select the **Settings** menu.
- ▶ Press the  or  button to select the **Lights** submenu.
- ▶ Press  to confirm.
- ▶ Press the  or  button to select the **Daytime driving lights** function.
If the **Daytime driving lights** function has been switched on, the cone of light and the  symbol in the multifunction display are shown in orange.
- ▶ Press the  button to save the setting.

Further information on daytime driving lights (▷ page 105).

Switching the Intelligent Light System on/off

- ▶ Press the  or  button on the steering wheel to select the **Settings** menu.
- ▶ Press the  or  button to select the **Lights** submenu.
- ▶ Press  to confirm.
- ▶ Press the  or  button to select the **Intell. Light System** function.
If the **Intell. Light Sys.** function has been switched on, the cone of light and the  symbol in the multifunction display are shown in orange.
- ▶ Press the  button to save the setting.







If you activate the **Intell. Light System** function, you activate the following functions:

- motorway mode
- active light function
- cornering light function
- extended range foglamps

If you set the dipped-beam headlamps for driving on the right/left, the multifunction display shows the **Intell. Light System: system inoperative Inactive for left-side traffic** or **Intell. Light System: System inoperative Inactive for right-side traffic** display message instead of the **Intell. Light Sys.** function in the **Lights** submenu (▷ page 221).

Further information on the Intelligent Light System (▷ page 108).

Setting the dipped-beam headlamps for driving on the left/right

- ▶ Press the  or  button on the steering wheel to select the **Settings** menu.
- ▶ Press the  or  button to select the **Lights** submenu.
- ▶ Press  to confirm.
- ▶ Press  or  to select the **Dipped beams Setting for:** function.

You will see the selected setting: **Right-side traffic** or **Left-side traffic**.

- ▶ Press the  button to save the setting.
If you change the setting, conversion does not take place until the next time the vehicle is stationary.

This function is only available on vehicles with the Intelligent Light System.

You can use this function to switch between symmetrical and asymmetrical dipped beam (▷ page 104).









If you set the dipped-beam headlamps for driving on the right/left, then motorway mode and the extended range foglamps are unavailable.

You can also have the dipped-beam headlamps set for driving on the right/left at a

qualified specialist workshop, e.g. a Mercedes-Benz Service Centre.













Switching Adaptive Highbeam Assist on/off

This function is only available on vehicles with the Intelligent Light System.

- ▶ Press the  or  button on the steering wheel to select the **Settings** menu.
- ▶ Press the  or  button to select the **Lights** submenu.
- ▶ Press  to confirm.
- ▶ Press the  or  button to select the **Adapt. main beam** function.
If the **Adapt. main beam** function has been switched on, the cone of light and the  symbol in the multifunction display are shown in orange.
- ▶ Press the  button to save the setting.

For further information about Adaptive Highbeam Assist, see (▷ page 110).









Setting the brightness of the ambient lighting

- ▶ Press the  or  button on the steering wheel to select the **Settings** menu.
- ▶ Press the  or  button to select the **Lights** submenu.
- ▶ Press  to confirm.
- ▶ Press the  or  button to select the **Amb. light +/-** function.
You will see the selected setting.
- ▶ Press  to confirm.
- ▶ Press the  or  button to adjust the brightness to any level from **Off** to **Level 5** (bright).
- ▶ Press the  or  button to save the setting.

Activating/deactivating the surround lighting and exterior lighting delayed switch-off

If you have activated the **Surround lighting** function and the light switch is set to

AUTO, the following functions are activated when it is dark:

- **surround lighting:** the exterior lighting remains lit for 40 seconds after unlocking with the key. If you start the engine, the surround lighting is switched off and automatic headlamp mode is activated (▷ page 105).
 - **exterior lighting delayed switch-off:** the exterior lighting remains lit for 60 seconds after the engine is switched off. If you close all the doors and the tailgate, the exterior lighting goes off after 15 seconds.
- ▶ Press the  or  button on the steering wheel to select the **Settings** menu.
 - ▶ Press the  or  button to select the **Lights** submenu.
 - ▶ Press  to confirm.
 - ▶ Press the  or  button to select the **Surround lighting** function.
When the **Surround lighting** function is activated, the light cone and the area around the vehicle are displayed in orange in the multifunction display.
 - ▶ Press the  button to save the setting.

Deactivating delayed switch-off of the exterior lighting temporarily:

- ▶ Before leaving the vehicle, turn the key to position **0** in the ignition lock.
- ▶ Turn the key to position **2** in the ignition lock.
The exterior lighting delayed switch-off is deactivated.

Delayed switch-off of the exterior lighting is reactivated the next time you start the engine.









i Depending on your vehicle's equipment, when the surround lighting and delayed switch-off exterior lighting are on, the following light up:

- side lamps
- foglamps

- dipped-beam headlamps
- daytime driving lights
- surround lighting in the exterior mirrors











Activating/deactivating the interior lighting delayed switch-off

If you activate the **Lighting delayed sw.-off** function, the interior lighting remains on for 20 seconds after you remove the key from the ignition lock.

- ▶ Press the  or  button on the steering wheel to select the **Settings** menu.
- ▶ Press the  or  button to select the **Lights** submenu.
- ▶ Press  to confirm.
- ▶ Press the  or  button to select the **Lighting delayed sw.-off** function. If the **Lighting delayed sw.-off** function has been switched on, the vehicle interior is displayed in orange in the multifunction display.
- ▶ Press the  button to save the setting.









Vehicle

Setting permanent SPEEDTRONIC

- ▶ Press the  or  button on the steering wheel to select the **Settings** menu.
- ▶ Press the  or  button to select the **Vehicle** submenu.
- ▶ Press  to confirm.
- ▶ Press the  or  button to select the **Limit speed (winter tyres)**: function. You will see the current setting.
- ▶ Press  to confirm.
- ▶ Press the  or  button to adjust permanent SPEEDTRONIC in increments of ten (230 km/h to 160 km/h). The **Off** setting switches permanent SPEEDTRONIC off.
- ▶ Press the  button to store the entry.

Using the **Limit speed (winter tyres)** function, you can set permanent SPEEDTRONIC (▶ page 172).

Switching the automatic locking feature on/off









- ▶ Press the  or  button on the steering wheel to select the **Settings** menu.
- ▶ Press the  or  button to select the **Vehicle** submenu.
- ▶ Press  to confirm.
- ▶ Press the  or  button to select the **Automatic door locks** function. When the **Automatic door locks** function is activated, the vehicle doors are displayed in orange in the multifunction display.
- ▶ Press the  button to save the setting.

If you activate the **Automatic door locks** function, the vehicle is centrally locked above a speed of around 15 km/h.





For further information on the automatic locking feature, see (▶ page 81).



Activating/deactivating the acoustic locking confirmation

If you switch on the **Acoustic Lock** function, an acoustic signal sounds when you lock the vehicle.

- ▶ Press the  or  button on the steering wheel to select the **Settings** menu.
- ▶ Press the  or  button to select the **Vehicle** submenu.
- ▶ Press  to confirm.
- ▶ Press the  or  button to select the **Acoustic Lock** function. If the **Acoustic Lock** function is activated, the  symbol in the multifunction display lights up orange.
- ▶ Press the  button to save the setting.

Activating/deactivating the radar sensor system















- ▶ Press the  or  button on the steering wheel to select the **Settings** menu.
- ▶ Press the  or  button to select the **Vehicle** submenu.
- ▶ Press  to confirm.

- ▶ Press the  or  button to select **Radar sensor** (See *Owner's Man.*). You will see the selected setting: **Activated** or **Deactivated**.
- ▶ Press the  button to save the setting.
- i** In some countries you must deactivate the radar sensor system. For further information, see (▶ page 350).







If the radar sensor system is switched off, Blind Spot Assist is deactivated (▶ page 197).



Heating

Changing the departure time

- ▶ Press the  or  button on the steering wheel to select the **Settings** menu.
- ▶ Press the  or  button to select the **Heating** submenu.
- ▶ Press  to confirm. You will see the selected setting.
- ▶ Press  to confirm.
- ▶ Press the  or  button to select **A**, **B** or **Change C**.
- ▶ Press  to confirm. You can now change the departure time.
- ▶ Press the  or  button to select the display to be changed: hours, minutes.
- ▶ Press the  or  button to set the selected display.
- ▶ Press the  button to store the entry. The yellow indicator lamp on the auxiliary heating button lights up.

Selecting the departure time or deactivating a selected departure time

- ▶ Press the  or  button on the steering wheel to select the **Settings** menu.
- ▶ Press the  or  button to select the **Heating** submenu.
- ▶ Press  to confirm. You will see the selected setting.
- ▶ Press  to confirm.

- ▶ Press  or  to select one of the three departure times or **Timer off** (no timer active).
- ▶ Press  to confirm. If a departure time is selected, the yellow indicator lamp lights up on the auxiliary heating button.

Changing the departure time

Only vehicles with auxiliary heating (▶ page 134) have this function.

In the **Heating** submenu, you can select a stored departure time or change a departure time.

The auxiliary heating timer function calculates the switch-on time according to the outside temperature so that the vehicle is pre-heated by the departure time. When the departure time is reached, the auxiliary heating continues to heat for a further five minutes and then switches off. The auxiliary heating adopts the THERMATIC or THERMOTRONIC temperature setting.

You can switch off the auxiliary heating by using the remote control or the auxiliary heating button on the centre console.

DANGER

If the exhaust pipe is blocked or sufficient ventilation is not possible, toxic exhaust fumes can enter the vehicle, especially carbon monoxide. This is the case, e.g. in enclosed spaces, or if the vehicle is stuck in snow. There is a risk of fatal injuries.

You should switch off the auxiliary heating in enclosed spaces which do not have an extraction system, e.g. a garage. If the vehicle is stuck in snow and you must leave the auxiliary heating running, keep the exhaust pipe and the area around the vehicle clear of snow. To guarantee a sufficient supply of fresh air, open a window on the side of the vehicle away from the wind.

WARNING

When the auxiliary heating is switched on, parts of the vehicle can become very hot.

Flammable material such as leaves, grass or twigs may ignite if they come into contact with hot parts of the exhaust system for extended periods. There is a risk of fire.









When the auxiliary heating is switched on, make sure that no flammable material can come into contact with hot vehicle components.

! Operating the auxiliary heating/ventilation draws on the vehicle battery. After you have heated or ventilated the vehicle a maximum of two times, drive for a longer distance.

i Switch the auxiliary heating on regularly once a month for about ten minutes.

Comfort

Switching belt adjustment on/off

- ▶ Press the  or  button on the steering wheel to select the **Settings** menu.
- ▶ Press the  or  button to select the **Convenience** submenu.
- ▶ Press  to confirm.
- ▶ Press the  or  button to select the **Belt adjustment** function.
If the **Belt adjustment** function is activated, the vehicle seat belt is shown in orange in the multifunction display.
- ▶ Press the  button to save the setting.

For further information on belt adjustment, see (▷ page 47).

Switching the fold in mirrors when locking function on/off









This function is only available on vehicles with a memory function (▷ page 101).

When you activate the **Auto. fold-in mirrors** function, the exterior mirrors are folded in when the vehicle is locked.









When you unlock the vehicle and then open a door, the exterior mirrors fold out again.

If you have switched on the **Auto. fold-in mirrors** function and you fold in the exterior

mirrors using the button on the door (▷ page 99), they will not fold out automatically. The exterior mirrors can then only be folded out using the button on the door.

- ▶ Press the  or  button on the steering wheel to select the **Settings** menu.
- ▶ Press the  or  button to select the **Convenience** submenu.
- ▶ Press  to confirm.
- ▶ Press the  or  button to select the **Auto. fold-in mirrors** function.
If the **Auto. fold-in mirrors** function is activated, the vehicle's exterior mirror is displayed in orange in the multifunction display.
- ▶ Press the  button to save the setting.

Resetting to factory settings

- ▶ Press the  or  button on the steering wheel to select the **Settings** menu.
- ▶ Press the  or  button to select the **Factory setting** submenu.
- ▶ Press  to confirm.
The **Reset all settings?** message appears.
- ▶ Press the  or  button to select **No** or **Yes**.
- ▶ Press the  button to confirm the selection.
If you have selected **Yes**, the multifunction display shows a confirmation message.

For safety reasons, not all functions are reset: the **Limit speed (winter tyres)**: function in permanent SPEEDTRONIC can only be set in the **VEHICLE** submenu. If you want to reset the **Daytime driving lights**: in the **Light** submenu, you must turn the key in the ignition lock to position **1**.

AMG menu in AMG vehicles

AMG displays

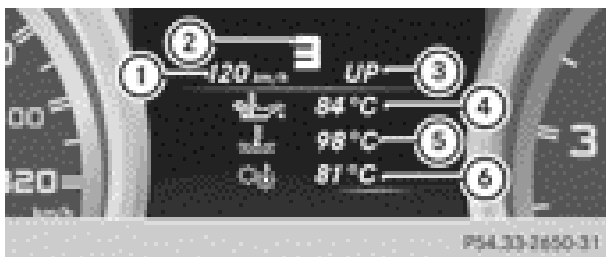

- ① Digital speedometer
 - ② Gear indicator
 - ③ Upshift indicator
 - ④ Engine oil temperature
 - ⑤ Coolant temperature
 - ⑥ Transmission fluid temperature
- ▶ Press the or button on the steering wheel to select the **AMG** menu.

Upshift indicator **UP** ③ indicates that the engine has reached the overrevving range when in the manual gearshift program. Upshift indicator **UP** ③ fades out other messages until you have shifted up.

If the engine oil temperature is below 80 °C, oil temperature ④ is shown in blue. Avoid using the full output of the engine during this time.

If the transmission fluid temperature is below 50 °C, oil temperature ⑥ is shown in blue. Avoid using the full output of the engine during this time.

SETUP



- ① Drive program (**C/S/M**)
- ② ESP[®] mode (**ON/OFF**) or SPORT handling mode (**SPORT**)

SETUP shows the drive program, the ESP[®] (Electronic Stability Program) mode and the SPORT handling mode.

- ▶ Press the or button on the steering wheel to select the **AMG** menu.
- ▶ Press the button repeatedly until SETUP is displayed.

RACETIMER

Displaying and starting the RACETIMER

The RACETIMER is only intended for use on a closed race circuit. Do not use the function on public roads.

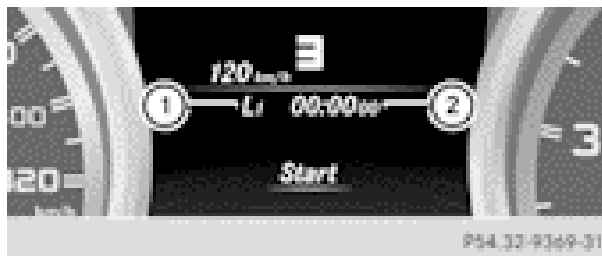



- ① Lap
- ② RACETIMER

You can start the RACETIMER when the engine is running or if the key is in position **2** in the ignition lock.

- ▶ Press the or button on the steering wheel to select the **AMG** menu.
- ▶ Press the button repeatedly until the RACETIMER is shown.
- ▶ **To start:** press the button to start the RACETIMER.

Displaying the intermediate time



- ▶ Press the  or  button to select **Interm. Time**.
- ▶ Press  to confirm.
The intermediate time is displayed for five seconds.

Starting a new lap





- ① RACETIMER
- ② Fastest lap time (best lap)
- ③ Lap
- ▶ Press  to confirm **New Lap**.

i A maximum of 16 laps may be stored. The 16th lap can only be completed with **Finish Lap**.



Stopping the RACETIMER



- ▶ Press the  button on the steering wheel.
- ▶ Confirm **Yes** with .

The RACETIMER interrupts timing if you stop the vehicle and turn the key to position **1** in the ignition lock. If you turn the key to position **2** or **3** and then press  to confirm **Start**, timing is continued.

Resetting the current lap



- ▶ Stop the RACETIMER.
- ▶ Press the  or  button to select **Reset Lap**.
- ▶ Press  to reset the lap time to "0".

Deleting all laps



If you switch off the engine, the RACETIMER is reset to "0" after 30 seconds. All laps are deleted.

You cannot delete individual stored laps. If you have stopped 16 laps, the current lap does not have to be reset.

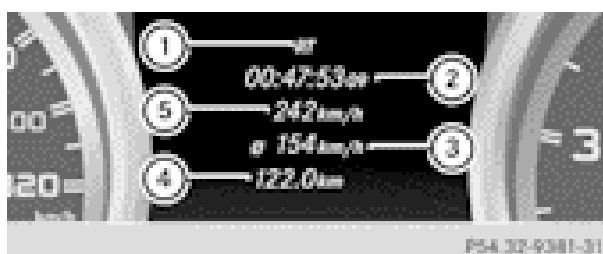

- ▶ Reset the current lap.
- ▶ Press  to confirm **Reset**.
Reset Race-Timer? appears in the multi-function display.
- ▶ Press the  button to select **Yes** and press the  button to confirm.
All laps are deleted.

Overall evaluation



- ① RACETIMER overall evaluation
- ② Total time driven
- ③ Average speed
- ④ Distance covered
- ⑤ Maximum speed

This function is shown if you have stored at least one lap and stopped the RACETIMER.



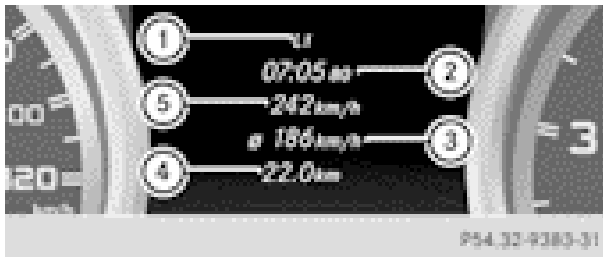

- ▶ Press the  or  button on the steering wheel to select the **AMG** menu.
- ▶ Press the  button repeatedly until the overall evaluation is shown.

Lap evaluation



- ① Lap
- ② Lap time
- ③ Average lap speed
- ④ Lap length
- ⑤ Top speed during lap

This function is only available if you have stored at least two laps and have stopped the RACETIMER.

- ▶ Press the  or  button on the steering wheel to select the **AMG** menu.
- ▶ Press the  button repeatedly until the lap evaluation is shown. Each lap is shown in a separate submenu. The fastest lap is indicated by flashing symbol ①.
- ▶ Press the  or  button to select a different lap evaluation.

Display messages

General notes

Display messages appear in the multifunction display.

Display messages with graphic symbols are simplified in the Owner's Manual and may differ from the symbols in the multifunction display.



Please respond in accordance with the display messages and follow the additional notes in this Owner's Manual.

Certain display messages are accompanied by an audible warning tone or a continuous tone.

When the ignition is switched off, all display messages are deleted apart from some high-priority display messages. Once the causes of the high-priority display messages have been rectified, the corresponding display messages are also deleted.

When you stop and park the vehicle, please observe the notes on the HOLD function (▷ page 179) and parking (▷ page 162).

Hiding display messages







- ▶ Press the  or  button on the steering wheel to hide the display message.
The display message is cleared.

The multifunction display shows high-priority display messages in red. Some high-priority display messages cannot be hidden.

The multifunction display shows these messages continuously until the causes for the messages have been remedied.

Message memory

The on-board computer saves certain display messages in the **message memory**. You can call up the display messages:

- ▶ Press  or  on the steering wheel to select the **Service** menu.
If there are display messages, the multifunction display shows, for example, **2 messages**.
- ▶ Press the  or  button to select the entry, e.g. **2 messages**.
- ▶ Press  to confirm.
- ▶ Press the  or  button to scroll through the display messages.

Safety systems

Display messages





currently unavailable See Owner's Manual

Possible causes/consequences and ► Solutions

ABS (Anti-lock Braking System), ESP[®] (Electronic Stability Program), BAS (Brake Assist), PRE-SAFE[®], the HOLD function, hill start assist and ESP[®] trailer stabilisation are temporarily unavailable.

The adaptive brake lights and COLLISION PREVENTION ASSIST may also have failed.

In addition, the ,  and  warning lamps light up in the instrument cluster.

ATTENTION ASSIST is deactivated.

Possible causes:

- self-diagnosis is not yet complete.
- the on-board voltage may be insufficient

 **WARNING**

The brake system continues to function normally, but without the functions listed above. The wheels could therefore lock if you brake hard, for example.

The steerability and braking characteristics may be severely affected. The braking distance may increase in an emergency braking situation.

If ESP[®] is not operational, ESP[®] is unable to stabilise the vehicle. There is an increased danger of skidding and risk of an accident.

► Carefully drive on a suitable stretch of road, making slight steering movements, at a speed above 20 km/h.

If the display message disappears, the functions mentioned above are available again.



If the display message continues to be displayed:

- Drive on carefully.
- Visit a qualified specialist workshop.





inoperative See Owner's Manual

ABS, ESP[®], BAS, PRE-SAFE[®], the HOLD function, hill start assist and ESP[®] trailer stabilisation are unavailable due to a malfunction. The adaptive brake lights and COLLISION PREVENTION ASSIST may also have failed.

In addition, the ,  and  warning lamps light up in the instrument cluster.

ATTENTION ASSIST is deactivated.

 **WARNING**

Display messages	Possible causes/consequences and ► Solutions
	<p>The brake system continues to function normally, but without the functions listed above. The wheels could therefore lock if you brake hard, for example.</p> <p>The steerability and braking characteristics may be severely affected. The braking distance may increase in an emergency braking situation.</p> <p>If ESP® is not operational, ESP® is unable to stabilise the vehicle. There is an increased danger of skidding and risk of an accident.</p> <ul style="list-style-type: none"> ► Drive on carefully. ► Visit a qualified specialist workshop immediately.
<div style="display: flex; align-items: center;">  <div style="margin-left: 10px;"> <p>currently unavailable See Owner's Manual</p> </div> </div>	<p>ESP®, BAS, PRE-SAFE®, the HOLD function, hill start assist and ESP® trailer stabilisation are temporarily unavailable.</p> <p>The adaptive brake lights and COLLISION PREVENTION ASSIST may also have failed.</p> <p>In addition, the  and  warning lamps light up in the instrument cluster.</p> <p>ATTENTION ASSIST is deactivated.</p> <p>The self-diagnosis function, for example, may not be complete.</p> <p>⚠ WARNING</p> <p>The brake system continues to function normally, but without the functions listed above.</p> <p>The braking distance may thus increase in an emergency braking situation.</p> <p>If ESP® is not operational, ESP® is unable to stabilise the vehicle. There is an increased danger of skidding and risk of an accident.</p> <ul style="list-style-type: none"> ► Carefully drive on a suitable stretch of road, making slight steering movements, at a speed above 20 km/h. <p>If the display message disappears, the functions mentioned above are available again.</p> <p>If the display message continues to be displayed:</p> <ul style="list-style-type: none"> ► Drive on carefully. ► Visit a qualified specialist workshop.

Display messages



inoperative See
Owner's Manual

Possible causes/consequences and ► Solutions

ESP[®], BAS, PRE-SAFE[®], the HOLD function, hill start assist and ESP[®] trailer stabilisation are not available due to a malfunction. The adaptive brake lights and COLLISION PREVENTION ASSIST may also have failed.

In addition, the  and  warning lamps light up in the instrument cluster.

ATTENTION ASSIST is deactivated.

 **WARNING**

The brake system continues to function normally, but without the functions listed above.

The braking distance may thus increase in an emergency braking situation.

If ESP[®] is not operational, ESP[®] is unable to stabilise the vehicle. There is an increased danger of skidding and risk of an accident.



- Drive on carefully.
- Visit a qualified specialist workshop.



inoperative See
Owner's Manual

EBD (electronic brake force distribution), ABS, ESP[®], BAS, PRE-SAFE[®], the HOLD function, hill start assist and ESP[®] trailer stabilisation are unavailable due to a malfunction.

The adaptive brake lights and COLLISION PREVENTION ASSIST may also have failed.

In addition, the ,  and  warning lamps light up in the instrument cluster and a warning tone sounds.

ATTENTION ASSIST is deactivated.







 **WARNING**





The brake system continues to function normally, but without the functions listed above. The front and rear wheels could therefore lock, for example, if you brake hard.









The steerability and braking characteristics may be severely affected. The braking distance may increase in an emergency braking situation.





If ESP[®] is not operational, ESP[®] is unable to stabilise the vehicle. There is an increased danger of skidding and risk of an accident.



- Drive on carefully.
- Visit a qualified specialist workshop immediately.









Display messages	Possible causes/consequences and ► Solutions
 Release parking brake	<p>The red  indicator lamp flashes and a warning tone sounds. A condition for automatic release of the electric parking brake is not fulfilled (► page 163).</p> <p>You are driving with the electric parking brake applied.</p> <ul style="list-style-type: none"> ► Release the electric parking brake manually.
 Parking brake See Owner's Manual	<p>The red  indicator lamp flashes and a warning tone sounds. You are making an emergency stop using the electric parking brake (► page 163).</p> <p>The yellow  warning lamp lights up. The electric parking brake is malfunctioning.</p> <p>To apply:</p> <ul style="list-style-type: none"> ► Switch the ignition off. ► Press the electric parking brake handle for at least ten seconds. ► Vehicles with manual transmission: engage first gear. ► Vehicles with automatic transmission: shift the transmission to P. ► Consult a qualified specialist workshop. <p>The yellow  warning lamp and the red  indicator lamp are lit. The electric parking brake is malfunctioning.</p> <p>To release:</p> <ul style="list-style-type: none"> ► Switch off the ignition and turn it back on. ► Release the electric parking brake manually. <p>or</p> <ul style="list-style-type: none"> ► Vehicles with manual transmission (automatic emergency release): insert the seat belt in the belt buckle and accelerate slightly more when pulling away. ► Vehicles with automatic transmission: release the electric parking brake automatically (► page 163). <p>If the electric parking brake still cannot be released:</p> <ul style="list-style-type: none"> ► Do not drive on. ► Consult a qualified specialist workshop.





Display messages	Possible causes/consequences and ► Solutions
	<p>The red  indicator lamp flashes and the yellow  warning lamp is lit.</p> <p>The electric parking brake is malfunctioning.</p> <p>To release:</p> <ul style="list-style-type: none"> ► Switch off the ignition and turn it back on. ► Release the electric parking brake manually. <p>To apply:</p> <ul style="list-style-type: none"> ► Switch off the ignition and turn it back on. ► Apply the electric parking brake manually. <p>If the red  indicator lamp continues to flash:</p> <ul style="list-style-type: none"> ► Do not drive on. ► Secure the vehicle against rolling away (▷ page 325). ► Vehicles with manual transmission: engage first gear. ► Vehicles with automatic transmission: shift the transmission to P. ► Turn the front wheels towards the kerb. ► Consult a qualified specialist workshop.
	<p>The yellow  warning lamp lights up. The red  indicator lamp flashes for about ten seconds after the electric parking brake has been applied or released. It then goes out or remains lit.</p> <p>The electric parking brake is malfunctioning.</p> <ul style="list-style-type: none"> ► Switch off the ignition and turn it back on. ► Apply the electric parking brake. <p>If it is not possible to apply the electric parking brake:</p> <ul style="list-style-type: none"> ► Vehicles with manual transmission: engage first gear. ► Vehicles with automatic transmission: shift the transmission to P. ► Visit a qualified specialist workshop. <p>If it is not possible to release the electric parking brake:</p> <ul style="list-style-type: none"> ► Vehicles with manual transmission (automatic emergency release): insert the seat belt in the belt buckle and accelerate slightly more when pulling away. ► Vehicles with automatic transmission: release the electric parking brake automatically (▷ page 163). <p>If the electric parking brake still cannot be released:</p> <ul style="list-style-type: none"> ► Consult a qualified specialist workshop.

Display messages	Possible causes/consequences and ► Solutions
	<p>The yellow  warning lamp lights up. If you manually apply or release the electric parking brake, the red  indicator lamp flashes.</p> <p>The electric parking brake is malfunctioning. It is not possible to apply the electric parking brake manually.</p> <ul style="list-style-type: none"> ► Vehicles with manual transmission: engage first gear. ► Vehicles with automatic transmission: shift the transmission to P. ► Visit a qualified specialist workshop.
<p> Parking brake inoperative</p>	<p>The yellow  warning lamp lights up. The red  indicator lamp flashes for about ten seconds after the electric parking brake has been applied or released. It then goes out or remains lit.</p> <p>The electric parking brake is malfunctioning, e.g. because of overvoltage or undervoltage.</p> <ul style="list-style-type: none"> ► Rectify the cause of the overvoltage or undervoltage, e.g. by charging the battery or restarting the engine. ► Apply or release the electric parking brake. <p>If it remains impossible to apply or release the electric parking brake:</p> <ul style="list-style-type: none"> ► Switch off the ignition and turn it back on. ► Apply or release the electric parking brake. <p>If the electric parking brake still cannot be released:</p> <ul style="list-style-type: none"> ► Consult a qualified specialist workshop. <p>The display message is only shown while the vehicle is in motion. The red  indicator lamp flashes and the yellow  warning lamp is lit.</p> <p>It is not possible to apply the electric parking brake manually.</p> <ul style="list-style-type: none"> ► Vehicles with manual transmission: engage first gear. ► Vehicles with automatic transmission: shift the transmission to P. ► Visit a qualified specialist workshop.
<p> Turn on the ignition to release the parking brake</p>	<p>The red  indicator lamp lights up.</p> <p>You attempted to release the electric parking brake while the ignition was switched off.</p> <ul style="list-style-type: none"> ► Turn the key to position 1 in the ignition lock.

Display messages	Possible causes/consequences and ► Solutions
 <p>Brake immediately</p>	<p>Vehicles with manual transmission: a malfunction has occurred while the HOLD function was activated.</p> <p>A tone may also sound at regular intervals. If you attempt to lock the vehicle, the tone becomes louder.</p> <p>You cannot start the engine.</p> <ul style="list-style-type: none"> ► Paying attention to the traffic situation, immediately depress the brake pedal firmly and hold until the display message disappears. ► Secure the vehicle against rolling away (▷ page 162). You can restart the engine.
 <p>Check brake fluid level</p>	<p>There is insufficient brake fluid in the brake fluid reservoir. In addition, the red  warning lamp lights up in the instrument cluster and a warning tone sounds.</p> <p>⚠ WARNING</p> <p>The braking efficiency may be impaired. There is a risk of an accident.</p> <ul style="list-style-type: none"> ► Pull over and stop the vehicle safely as soon as possible, paying attention to road and traffic conditions. Do not continue driving under any circumstances. ► Secure the vehicle against rolling away (▷ page 162). ► Consult a qualified specialist workshop. ► Do not top up the brake fluid. This does not correct the fault.
 <p>Check brake pad wear</p>	<p>The brake pads/linings have reached their wear limit.</p> <ul style="list-style-type: none"> ► Visit a qualified specialist workshop.
<p>PRE-SAFE inoperative See Owner's Manual</p>	<p>Important functions of PRE-SAFE® have failed. All other occupant safety systems, e.g. airbags, remain available.</p> <ul style="list-style-type: none"> ► Visit a qualified specialist workshop immediately.

Display messages	Possible causes/consequences and ► Solutions
<p>PRE-SAFE Functions currently limited See Owner's Manual</p>	<p>Adaptive Brake Assist is temporarily inoperative. Possible causes:</p> <ul style="list-style-type: none"> • the radar sensor cover in the radiator trim is dirty. • the function is impaired due to heavy rain or snow. • the radar sensor system is temporarily inoperative, e.g. due to electromagnetic radiation emitted by nearby TV or radio stations or other sources of electromagnetic radiation. • AMG vehicles: ESP® is deactivated. • the system is outside the operating temperature range. • the on-board voltage is too low. <p>Once the causes listed above no longer apply, the display message goes out. Adaptive Brake Assist is operational again.</p> <p>If the display message does not disappear:</p> <ul style="list-style-type: none"> ► Pull over and stop the vehicle safely as soon as possible, paying attention to road and traffic conditions. ► Secure the vehicle against rolling away (▷ page 162). ► Clean the radar sensor cover in the radiator grille (▷ page 294). ► Restart the engine. ► AMG vehicles: reactivate ESP®(▷ page 66).
<p>PRE-SAFE Functions limited See Owner's Manual</p>	<p>Adaptive Brake Assist is faulty. The distance warning signal may also have failed.</p> <ul style="list-style-type: none"> ► Visit a qualified specialist workshop.
	<p>If the symbol appears in the multifunction display, a seat belt tongue has been inserted into a rear seat belt buckle.</p> <p>Further information on the status indicator for the rear seat belts (▷ page 49).</p>
	<p>If the symbol appears in the multifunction display, a seat belt tongue has not been inserted in a rear seat belt buckle.</p> <p>⚠ WARNING</p> <p>A seat belt which is not worn correctly, or which has not been engaged in the seat belt buckle correctly, cannot provide the intended level of protection.</p> <p>This poses an increased risk of injury.</p> <ul style="list-style-type: none"> ► If necessary, ask the occupants in the rear to fasten their seat belts (▷ page 47). <p>Further information on the status indicator for the rear seat belts (▷ page 49).</p>



Display messages	Possible causes/consequences and ► Solutions
 <p>Restraint sys. malfunction Consult workshop</p>	<p>There is a malfunction in the SRS (Supplemental Restraint System). The  warning lamp also lights up in the instrument cluster.</p> <p> WARNING</p> <p>The airbags or belt tensioners may either be triggered unintentionally or, in the event of an accident, may not be triggered. This poses an increased risk of injury.</p> <p>► Visit a qualified specialist workshop.</p> <p>Further information on occupant safety (► page 40).</p>
 <p>Front left malfunction Consult workshop or Front right malfunction Consult workshop</p>	<p>SRS has malfunctioned at the front on the left or right. The  warning lamp also lights up in the instrument cluster.</p> <p> WARNING</p> <p>The airbags or belt tensioners may either be triggered unintentionally or, in the event of an accident, may not be triggered. This poses an increased risk of injury.</p> <p>► Visit a qualified specialist workshop.</p>
 <p>Rear left malfunction Consult workshop or Rear right malfunction Consult workshop</p>	<p>SRS has malfunctioned at the rear on the left or right. The  warning lamp also lights up in the instrument cluster.</p> <p> WARNING</p> <p>The airbags or belt tensioners may either be triggered unintentionally or, in the event of an accident, may not be triggered. This poses an increased risk of injury.</p> <p>► Visit a qualified specialist workshop.</p>







Display messages	Possible causes/consequences and ► Solutions
 <p>Rear centre malfunction Consult workshop</p>	<p>SRS has malfunctioned at the rear centre. The  warning lamp also lights up in the instrument cluster.</p> <p>⚠ WARNING</p> <p>The airbags or belt tensioners may either be triggered unintentionally or, in the event of an accident, may not be triggered. This poses an increased risk of injury.</p> <p>► Visit a qualified specialist workshop.</p>
 <p>Left windowbag malfunction Consult workshop or Right windowbag malfunction Consult workshop</p>	<p>There is a malfunction in the left-hand and/or right-hand windowbag. The  warning lamp also lights up in the instrument cluster.</p> <p>⚠ WARNING</p> <p>The left or right windowbag may either be triggered unintentionally or, in the event of an accident, may not be triggered. This poses an increased risk of injury.</p> <p>► Visit a qualified specialist workshop.</p>







Lights







i Display messages about LEDs:

This display message will only appear if all the LEDs have failed.

Display messages	Possible causes/consequences and ► Solutions
 <p>Left cornering light or Right cornering light</p>	<p>The left or right-hand cornering light is faulty.</p> <p>► Check whether you are permitted to replace the bulb yourself (▷ page 112).</p> <p>or</p> <p>► Visit a qualified specialist workshop.</p>
 <p>Left dipped beam or Right dipped beam</p>	<p>The left or right-hand dipped-beam headlamp is faulty.</p> <p>► Check whether you are permitted to replace the bulb yourself (▷ page 112).</p> <p>or</p> <p>► Visit a qualified specialist workshop.</p>
 <p>Trailer left tail lamp or Trailer right tail lamp</p>	<p>The left or right-hand trailer tail lamp is faulty.</p> <p>► Check whether you are permitted to replace the bulb yourself.</p> <p>or</p> <p>► Visit a qualified specialist workshop.</p>



Display messages	Possible causes/consequences and ► Solutions
 <p>Trailer left indicator or Trailer right indicator</p>	<p>The left or right-hand trailer turn signal lamp is faulty.</p> <ul style="list-style-type: none"> ► Check whether you are permitted to replace the bulb yourself. or ► Visit a qualified specialist workshop.
 <p>Trailer brake lamp</p>	<p>The trailer brake lamp is faulty.</p> <ul style="list-style-type: none"> ► Check whether you are permitted to replace the bulb yourself. or ► Visit a qualified specialist workshop.
 <p>Rear left indicator or Rear right indicator</p>	<p>The rear left-hand or rear right-hand turn signal is faulty.</p> <ul style="list-style-type: none"> ► Check whether you are permitted to replace the bulb yourself (▷ page 112). or ► Visit a qualified specialist workshop.
 <p>Front left indicator or Front right indicator</p>	<p>The front left-hand or front right-hand turn signal is faulty.</p> <ul style="list-style-type: none"> ► Check whether you are permitted to replace the bulb yourself (▷ page 112). or ► Visit a qualified specialist workshop.
 <p>Left mirror indicator or Right mirror indicator</p>	<p>The turn signal in the left-hand or right-hand exterior mirror is faulty.</p> <ul style="list-style-type: none"> ► Check whether you are permitted to replace the bulb yourself (▷ page 112). or ► Visit a qualified specialist workshop.
 <p>Third brake lamp</p>	<p>The third brake lamp is faulty.</p> <ul style="list-style-type: none"> ► Check whether you are permitted to replace the bulb yourself (▷ page 112). or ► Visit a qualified specialist workshop.
 <p>Left brake lamp or Right brake lamp</p>	<p>The left or right-hand brake lamp is faulty.</p> <ul style="list-style-type: none"> ► Check whether you are permitted to replace the bulb yourself (▷ page 112). or ► Visit a qualified specialist workshop.





Display messages	Possible causes/consequences and ► Solutions
 Left-hand tail lamp/brake lamp or Right-hand tail lamp/brake lamp	The left or right-hand tail lamp/brake lamp is faulty. ► Check whether you are permitted to replace the bulb yourself (▷ page 112). or ► Visit a qualified specialist workshop.
 Left main beam or Right main beam	The left or right-hand main-beam headlamp is faulty. ► Check whether you are permitted to replace the bulb yourself (▷ page 112). or ► Visit a qualified specialist workshop.
 Number plate lamp	The left or right-hand licence plate lamp is faulty. ► Check whether you are permitted to replace the bulb yourself (▷ page 112). or ► Visit a qualified specialist workshop.
 Front foglamp left or Front foglamp right	The left-hand or right-hand front foglamp is faulty. ► Check whether you are permitted to replace the bulb yourself (▷ page 112). or ► Visit a qualified specialist workshop.
 Rear fog lamp	The rear foglamp is faulty. ► Check whether you are permitted to replace the bulb yourself (▷ page 112). or ► Visit a qualified specialist workshop.
 Front left parking lamp or Front right parking lamp	The front left or front right parking lamp is faulty. ► Check whether you are permitted to replace the bulb yourself (▷ page 112). or ► Visit a qualified specialist workshop.
 Reversing light	The reversing lamp is faulty. ► Check whether you are permitted to replace the bulb yourself (▷ page 112). or ► Visit a qualified specialist workshop.





Display messages	Possible causes/consequences and ► Solutions
 <p>Left tail lamp or Right tail lamp</p>	<p>The left or right-hand tail lamp is faulty.</p> <ul style="list-style-type: none"> ► Check whether you are permitted to replace the bulb yourself (▷ page 112). <p>or</p> <ul style="list-style-type: none"> ► Visit a qualified specialist workshop.
 <p>Left daytime driving lamp or Right daytime driving lamp</p>	<p>The left-hand or right-hand daytime driving lamp is faulty.</p> <ul style="list-style-type: none"> ► Check whether you are permitted to replace the bulb yourself (▷ page 112). <p>or</p> <ul style="list-style-type: none"> ► Visit a qualified specialist workshop.
 <p>Intell. Light System inoperative</p>	<p>The Intelligent Light System is faulty. The lights remain available without the Intelligent Light System.</p> <ul style="list-style-type: none"> ► Visit a qualified specialist workshop.
 <p>Malfunction See Owner's Manual</p>	<p>The exterior lighting is faulty.</p> <ul style="list-style-type: none"> ► Visit a qualified specialist workshop. <p>Vehicles with trailer tow hitch: a fuse may have blown.</p> <ul style="list-style-type: none"> ► Check the fuses (▷ page 314). ► If necessary, replace the blown fuse. Observe the warning notes as you do so. <p>If the display message continues to be displayed:</p> <ul style="list-style-type: none"> ► Visit a qualified specialist workshop.
 <p>AUTO lights inoperative</p>	<p>The light sensor is faulty.</p> <ul style="list-style-type: none"> ► Visit a qualified specialist workshop.
 <p>Switch off lights</p>	<p>The lights are still switched on when you leave the vehicle. A warning tone also sounds.</p> <ul style="list-style-type: none"> ► Turn the light switch to AUTO.

Display messages	Possible causes/consequences and ► Solutions
Adaptive Main-beam Assist inoperative	Adaptive Highbeam Assist is faulty. ► Visit a qualified specialist workshop.
Adaptive Main-beam Assist currently unavailable See Owner's Manual	Adaptive Highbeam Assist is deactivated and temporarily inoperative. Possible causes: <ul style="list-style-type: none"> • the windscreen is dirty in the camera's field of vision. • visibility is impaired due to heavy rain, snow or fog. ► Clean the windscreen. If the system detects that the camera is fully operational again, the Adaptive Main-beam Assist available again message is displayed. Adaptive Highbeam Assist is operational again.



Engine

Display messages	Possible causes/consequences and ► Solutions
 Top up coolant See Owner's Manual	The coolant level is too low. ! Avoid making long journeys with too little coolant in the engine cooling system. The engine will otherwise be damaged. ► Top up the coolant, observing the warning notes before doing so (▷ page 288). ► If the coolant needs topping up more often than usual, have the engine coolant system checked at a qualified specialist workshop.
	The fan motor is faulty. ► If the coolant temperature is below 120 °C, you can continue driving to the nearest qualified specialist workshop. ► Avoid heavy loads on the engine as you do so, e.g. driving in mountainous terrain and stop-start traffic.

Display messages	Possible causes/consequences and ► Solutions
 <p data-bbox="181 300 488 411">Coolant Stop vehicle Switch engine off</p>	<p data-bbox="521 233 906 310">The coolant is too hot. A warning tone also sounds.</p> <p data-bbox="521 338 737 373"> WARNING</p> <p data-bbox="521 394 1398 499">Never drive with an overheated engine. Driving when your engine is overheated can cause some fluids which may have leaked into the engine compartment to catch fire.</p> <p data-bbox="521 516 1398 583">Steam from an overheated engine can cause serious burns, which can occur just by opening the bonnet.</p> <p data-bbox="521 600 837 632">There is a risk of injury.</p> <ul style="list-style-type: none"> <li data-bbox="521 653 1398 720">► Stop the vehicle immediately, paying attention to road and traffic conditions, and switch off the engine. <li data-bbox="521 737 1268 768">► Secure the vehicle against rolling away (► page 162). <li data-bbox="521 785 1073 816">► Wait until the engine has cooled down. <li data-bbox="521 833 1333 900">► Make sure that the air supply to the engine radiator is not blocked, e.g. by frozen slush. <li data-bbox="521 917 1398 1022">► Do not start the engine again until the display message goes out and the coolant temperature is below 120 °C. The engine may otherwise be damaged. <li data-bbox="521 1039 1214 1071">► Pay attention to the coolant temperature display. <li data-bbox="521 1087 1373 1155">► If the temperature increases again, visit a qualified specialist workshop immediately. <p data-bbox="521 1171 1398 1239">Under normal operating conditions and with the specified coolant level, the coolant temperature may rise to 120 °C.</p>
	<p data-bbox="521 1272 967 1350">The battery is not being charged. A warning tone also sounds.</p> <p data-bbox="521 1367 748 1398">Possible causes:</p> <ul style="list-style-type: none"> <li data-bbox="521 1415 769 1446">• faulty alternator <li data-bbox="521 1463 764 1495">• torn poly-V-belt <li data-bbox="521 1512 980 1543">• a malfunction in the electronics <ul style="list-style-type: none"> <li data-bbox="521 1560 1398 1627">► Stop the vehicle immediately, paying attention to road and traffic conditions, and switch off the engine. <li data-bbox="521 1644 789 1675">► Open the bonnet. <li data-bbox="521 1692 1065 1724">► Check whether the poly-V-belt is torn. <p data-bbox="521 1740 878 1772">If the poly-V-belt is torn:</p> <p data-bbox="521 1789 1398 1833"> Do not continue driving. The engine could otherwise overheat.</p> <ul style="list-style-type: none"> <li data-bbox="521 1850 1089 1881">► Consult a qualified specialist workshop. <p data-bbox="521 1898 862 1929">If the poly-V-belt is OK:</p> <ul style="list-style-type: none"> <li data-bbox="521 1946 1219 1978">► Visit a qualified specialist workshop immediately.



Display messages	Possible causes/consequences and ► Solutions
 Check eng. oil lev. when next refuelling	The engine oil level has dropped to the minimum level. A warning tone also sounds. <ul style="list-style-type: none"> ► Check the oil level when next refuelling, at the latest (▷ page 286). ► If necessary, top up the engine oil (▷ page 287). ► Have the engine checked at a qualified specialist workshop if the engine oil needs topping up more often than usual.
 Reserve fuel level	The fuel level has dropped into the reserve range. The auxiliary heating cannot be operated. <ul style="list-style-type: none"> ► Refuel at the nearest filling station.
 Reserve fuel level	There is very little fuel in the fuel tank. The auxiliary heating cannot be operated. <ul style="list-style-type: none"> ► Refuel at the nearest filling station without fail.
 Replace air cleaner	Vehicles with a diesel engine: the engine air filter is dirty and must be replaced. <ul style="list-style-type: none"> ► Visit a qualified specialist workshop. <p>i This message does not appear for the 180 CDI BlueEFFICIENCY, manual transmission model A.</p>
 Clean the fuel filter	Vehicles with a diesel engine: there is water in the fuel filter. The water must be drained off. <ul style="list-style-type: none"> ► Visit a qualified specialist workshop.

Driving systems

Display messages	Possible causes/consequences and ► Solutions
 Attention Assist: Drowsiness detected	Based on certain criteria, ATTENTION ASSIST has detected fatigue or a lack of concentration on the part of the driver. A warning tone also sounds. <ul style="list-style-type: none"> ► If necessary, take a break. During long journeys, take regular breaks in good time so that you get enough rest.
 Attention Assist inoperative	ATTENTION ASSIST is inoperative. <ul style="list-style-type: none"> ► Visit a qualified specialist workshop.

Display messages	Possible causes/consequences and ► Solutions
Speed Limit Assist Currently unavailable See Owner's Manual	<p>Speed Limit Assist is deactivated and temporarily inoperative. Possible causes:</p> <ul style="list-style-type: none"> • the windscreen is dirty in the camera's field of vision. • visibility is impaired due to heavy rain, snow or fog. <p>► Clean the windscreen.</p> <p>If the system detects that the camera is fully operational, the display message disappears. Speed Limit Assist is operational again.</p>
Speed Limit Assist: Unavailable in this country	<p>Speed Limit Assist is only available in certain countries.</p> <p>► Drive on. Speed Limit Assist is available again as soon as you drive into a country in which its use is approved.</p>
Speed Limit Assist inoperative	<p>Speed Limit Assist is faulty.</p> <p>► Visit a qualified specialist workshop.</p>
HOLD Off	<p>The HOLD function is deactivated. the vehicle is skidding. A warning tone also sounds.</p> <p>► Reactivate the HOLD function later (▷ page 179).</p> <p>The HOLD function is deactivated. When the brake pedal is firmly depressed, an activation condition is not fulfilled. A warning tone also sounds.</p> <p>► Check the activation conditions for the HOLD function (▷ page 179).</p>
Radar sensor deactivated See Owner's Manual	<p>The radar sensor system is deactivated.</p> <p>► Check whether or not the radar sensor system may be activated (▷ page 350).</p> <p>► Switch on the radar sensor system (▷ page 223).</p>
Radar sensor deactivated autom. See Owner's Manual	<p>Vehicles with a navigation system: the vehicle is close to a radio telescope facility and is therefore prohibited from transmitting any radar signals. The radar sensor system is deactivated automatically.</p> <p>If Blind Spot Assist was activated, it is no longer available. The yellow  indicator lamps also light up in the exterior mirrors.</p> <p>► Drive on. Blind Spot Assist is available again as soon as the vehicle is far enough away from the radio telescope facility (▷ page 350).</p>

Display messages	Possible causes/consequences and ► Solutions
	<p>Vehicles with Becker® MAP PILOT: if the Becker® MAP PILOT is not connected, the radar sensor system is deactivated automatically.</p> <p>Blind Spot Assist is not available.</p> <p>► Connect the Becker® MAP PILOT; see the separate operating instructions.</p>
<p>Lane Keeping Assist currently unavailable See Owner's Manual</p>	<p>Lane Keeping Assist is deactivated and temporarily inoperative. Possible causes:</p> <ul style="list-style-type: none"> • the windscreen is dirty in the camera's field of vision. • visibility is impaired due to heavy rain, snow or fog. • there are no lane markings for a longer period. • the lane markings are worn, dark or covered, e.g. by dirt or snow. <p>Once the causes listed above no longer apply, the display message goes out.</p> <p>Lane Keeping Assist is operational again.</p> <p>If the display message does not disappear:</p> <ul style="list-style-type: none"> ► Pull over and stop the vehicle safely as soon as possible, paying attention to road and traffic conditions. ► Secure the vehicle against rolling away (▷ page 162). ► Clean the windscreen.
<p>Lane Keeping Assist inoperative</p>	<p>Lane Keeping Assist is faulty.</p> <p>► Visit a qualified specialist workshop.</p>
<p>Blind Spot Assist currently unavailable See Owner's Manual</p>	<p>Blind Spot Assist is temporarily inoperative.</p> <p>You have established the electrical connection between the trailer and your vehicle.</p> <p>► Press <input type="button" value="OK"/> on the steering wheel to confirm the display message.</p> <p>Blind Spot Assist is deactivated while towing a trailer.</p>

Display messages	Possible causes/consequences and ► Solutions
	<p>Blind Spot Assist is temporarily inoperative. Possible causes:</p> <ul style="list-style-type: none"> • the sensors are dirty. • the function is impaired due to heavy rain or snow. • the radar sensor system is outside the operating temperature range. • the radar sensor system is temporarily inoperative, e.g. due to electromagnetic radiation emitted by nearby TV or radio stations or other sources of electromagnetic radiation. <p>The yellow  indicator lamps also light up in the exterior mirrors.</p> <p>Once the causes listed above no longer apply, the display message goes out.</p> <p>Blind Spot Assist is operational again.</p> <p>If the display message does not disappear:</p> <ul style="list-style-type: none"> ► Pull over and stop the vehicle safely as soon as possible, paying attention to road and traffic conditions. ► Secure the vehicle against rolling away (▷ page 162). ► Clean the sensors (▷ page 294). ► Restart the engine.
Blind Spot Assist inoperative	<p>Blind Spot Assist is faulty.</p> <p>The yellow  indicator lamps also light up in the exterior mirrors.</p> <ul style="list-style-type: none"> ► Visit a qualified specialist workshop.
Park Assist cancelled	<p>The driver's door is open and the driver's seat belt has not been fastened.</p> <ul style="list-style-type: none"> ► Repeat the parking process with the seat belt fastened and the driver's door closed. <p>You inadvertently touched the multifunction steering wheel while steering intervention was active.</p> <ul style="list-style-type: none"> ► While steering intervention is active, make sure not to touch the multifunction steering wheel. <p>The vehicle has started to skid and ESP® has intervened.</p> <ul style="list-style-type: none"> ► Use Active Parking Assist again later (▷ page 186).



Display messages	Possible causes/consequences and ► Solutions
Park Assist inoperative	<p>You have just carried out a large number of turning or parking manoeuvres.</p> <p>Active Parking Assist will become available again after approximately ten minutes (▷ page 186).</p> <ul style="list-style-type: none"> ► Pull over and stop the vehicle safely as soon as possible, paying attention to road and traffic conditions. ► Switch off and restart the engine. <p>If the display message continues to be displayed:</p> <ul style="list-style-type: none"> ► Visit a qualified specialist workshop.
DISTRONIC PLUS off	<p>DISTRONIC PLUS has been deactivated (▷ page 173). If it was deactivated automatically, a warning tone also sounds.</p>
DISTRONIC PLUS available again	<p>DISTRONIC PLUS is operational again after having been temporarily unavailable. You can now reactivate DISTRONIC PLUS (▷ page 173).</p>
DISTRONIC PLUS currently unavailable See Owner's Manual	<p>DISTRONIC PLUS is temporarily inoperative. Possible causes:</p> <ul style="list-style-type: none"> • the function is impaired due to heavy rain or snow. • the sensors in the radiator trim are dirty • the radar sensor system is temporarily inoperative, e.g. due to electromagnetic radiation emitted by nearby TV or radio stations or other sources of electromagnetic radiation. • the system is outside the operating temperature range. • the on-board voltage is too low. <p>A warning tone also sounds.</p> <p>Once the causes listed above no longer apply, the display message goes out.</p> <p>DISTRONIC is operational again.</p> <p>If the display message does not disappear:</p> <ul style="list-style-type: none"> ► Pull over and stop the vehicle safely as soon as possible, paying attention to road and traffic conditions. ► Secure the vehicle against rolling away (▷ page 162). ► Clean the sensors in the radiator trim (▷ page 294). ► Restart the engine.





Display messages	Possible causes/consequences and ► Solutions
DISTRONIC PLUS inoperative	DISTRONIC PLUS is faulty. Adaptive Brake Assist may also have failed. A warning tone also sounds. ► Visit a qualified specialist workshop.
DISTRONIC PLUS inactive	You have depressed the accelerator pedal. DISTRONIC PLUS is no longer controlling the speed of the vehicle. ► Remove your foot from the accelerator pedal.
DISTRONIC PLUS --- km/h	An activation condition for DISTRONIC PLUS is not fulfilled. ► Check the activation conditions for DISTRONIC PLUS (▷ page 175).
DISTRONIC PLUS and SPEEDTRONIC inoperative	DISTRONIC PLUS and SPEEDTRONIC are faulty. A warning tone also sounds. ► Visit a qualified specialist workshop.
Cruise control and SPEEDTRONIC inoperative	SPEEDTRONIC and cruise control are malfunctioning. A warning tone also sounds. ► Visit a qualified specialist workshop.
Limit --- km/h	While depressing the accelerator pedal beyond the pressure point (kickdown), SPEEDTRONIC cannot be activated.
Cruise control --- km/h	A condition for activating cruise control has not been met. You have tried to store a speed below 30 km/h, for example. ► If conditions permit, drive faster than 30 km/h and store the speed. ► Check the activation conditions for cruise control (▷ page 169).
120 km/h Maximum speed exceeded	Only for certain countries: the maximum speed has been exceeded. In addition, the multifunction display shows 120 km/h. ► Drive more slowly.

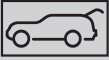

Tyres	
Display messages	Possible causes/consequences and ► Solutions
<p>Tyre pressure Check tyres</p>	<p>The tyre pressure loss warning system has detected a significant loss in pressure. A warning tone also sounds.</p> <p> WARNING</p> <p>With tyre pressures which are too low, there is a risk of the following hazards:</p> <ul style="list-style-type: none"> • the tyres may burst, especially as the load and vehicle speed increase. • the tyres may wear excessively and/or unevenly, which may greatly impair tyre traction. • the driving characteristics, as well as steering and braking, may be greatly impaired. <p>There is a risk of an accident.</p> <ul style="list-style-type: none"> ► Stop the vehicle without making any sudden steering or braking manoeuvres. Pay attention to the traffic conditions as you do so. ► Secure the vehicle against rolling away (▷ page 162). ► Check the tyres and, if necessary, follow the instructions for a flat tyre (▷ page 300). ► Check the tyre pressures and, if necessary, correct the tyre pressure. ► Restart the tyre pressure loss warning system when the tyre pressure is correct (▷ page 323).
<p>Check tyre pressures then restart Run Flat Indicator</p>	<p>The tyre pressure loss warning system generated a display message and has not been restarted since.</p> <ul style="list-style-type: none"> ► Set the correct tyre pressure in all four tyres. ► Restart the tyre pressure loss warning system (▷ page 323).
<p>Run Flat Indicator inoperative</p>	<p>The tyre pressure loss warning system is faulty.</p> <ul style="list-style-type: none"> ► Visit a qualified specialist workshop.

Vehicle	
Display messages	Possible causes/consequences and ► Solutions
To start engine, shift to either P or N	<p>You have attempted to start the engine with the transmission in position R or D.</p> <p>► Shift the transmission to position P or N.</p>
Auxiliary battery malfunction	<p>The auxiliary battery for the automatic transmission is no longer being charged.</p> <p>► Visit a qualified specialist workshop at the next opportunity.</p> <p>► Until then, set the automatic transmission to position P before you switch off the engine.</p> <p>► Before leaving the vehicle, apply the electric parking brake.</p>
Depress brake to start engine	<p>You have attempted to start the engine with the transmission in position N without depressing the brake pedal.</p> <p>► Depress the brake pedal.</p>
To shift out of P or N depress brake and start engine	<p>You have attempted to shift the transmission to position R or D without starting the engine.</p> <p>► Start the engine.</p> <p>► Depress the brake pedal.</p> <p>i It is only possible to shift the transmission from position P to the desired position if you depress the brake pedal. Only then can the parking lock be deactivated. If you do not depress the brake pedal, the DIRECT SELECT lever can still be moved but the parking lock remains engaged.</p> <p>i At transmission fluid temperatures below -20 °C you can only shift out of position P into another transmission position when the engine is running.</p>
Apply brake to deselect Park (P) position	<p>You have attempted to move the transmission selector lever to position R, N or D without depressing the brake pedal.</p> <p>► Depress the brake pedal.</p>
Risk of vehicle rolling Transmission not in P	<p>The driver's door is open and the transmission is in position R, N or D.</p> <p>A warning tone also sounds.</p> <p>► Shift the transmission to position P.</p> <p>► Secure the vehicle against rolling away (► page 162).</p>



Display messages	Possible causes/consequences and ► Solutions
Without changing gear, consult workshop	<p>You cannot change the transmission position due to a malfunction. A warning tone also sounds.</p> <p>If transmission position D is selected:</p> <ul style="list-style-type: none"> ► Drive to a qualified specialist workshop without shifting the transmission from position D. <p>If transmission position R, N or P is selected:</p> <ul style="list-style-type: none"> ► Consult a qualified specialist workshop.
Only select Park (P) when vehicle is stationary	<p>The vehicle is moving.</p> <ul style="list-style-type: none"> ► Pull over and stop the vehicle safely as soon as possible, paying attention to road and traffic conditions. ► Shift the transmission to position P.
Reversing not poss. Consult workshop	<p>The automatic transmission is malfunctioning. You cannot drive in reverse.</p> <ul style="list-style-type: none"> ► Visit a qualified specialist workshop.
Transmission Malfunction	<p>The automatic transmission is malfunctioning.</p> <ul style="list-style-type: none"> ► Visit a qualified specialist workshop.
Transmission malfunction Stop	<p>The automatic transmission is malfunctioning.</p> <ul style="list-style-type: none"> ► Pull over and stop the vehicle safely as soon as possible, paying attention to road and traffic conditions. ► Secure the vehicle against rolling away (▷ page 162). ► Consult a qualified specialist workshop.
Stop vehicle Shift to P Leave engine running	<p>The automatic transmission has overheated.</p> <ul style="list-style-type: none"> ► Drive on carefully. <p>If the display message disappears, the automatic transmission is available again.</p> <p>If the display message continues to be displayed:</p> <ul style="list-style-type: none"> ► Pull over and stop the vehicle safely as soon as possible, paying attention to road and traffic conditions. ► Secure the vehicle against rolling away (▷ page 162). ► Wait until the automatic transmission has cooled off and the display message goes out.

Display messages	Possible causes/consequences and ► Solutions
Trans. oil overheated Drive on with care	AMG vehicles: the transmission oil has overheated. Manual drive program M and the temporarily active manual drive program are no longer available. The engine power output is reduced. ► Allow the vehicle to cool down.
4matic currently unavailable	4MATIC (permanent all-wheel drive) has overheated. The vehicle is only driven by the front wheels. ► Drive on. The airflow cools 4MATIC more quickly. When the display message goes out, 4MATIC is available again and the vehicle is driven by all four wheels.
4matic inoperative	4MATIC is malfunctioning. The vehicle is only driven by the front wheels. ► Visit a qualified specialist workshop.
	The tailgate is open. ⚠ WARNING When the engine is running, exhaust gases can enter the vehicle interior if the tailgate is open. There is a risk of poisoning. ► Close the tailgate.
	The bonnet is open. A warning tone also sounds. ⚠ WARNING The open bonnet may then block your view when the vehicle is in motion. There is a risk of an accident. ► Pull over and stop the vehicle safely as soon as possible, paying attention to road and traffic conditions. ► Apply the electric parking brake. ► Close the bonnet.
Active bonnet malfunction See Owner's Manual	The active bonnet (pedestrian protection) is not active due to a malfunction or because it has already been triggered. ► Visit a qualified specialist workshop.
	At least one door is open. A warning tone also sounds. ► Close all doors.

Display messages	Possible causes/consequences and ► Solutions
 <p>Check trailer hitch lock</p>	<p>The trailer tow hitch is not correctly engaged. A warning tone also sounds.</p> <ul style="list-style-type: none"> ► Stop the vehicle immediately, paying attention to road and traffic conditions, and switch off the engine. ► Apply the electric parking brake. ► Engage the trailer coupling's ball coupling in the end position (► page 203). <p>Otherwise, the trailer may detach itself.</p>
 <p>Power steering malfunction See Owner's Manual</p>	<p>The power steering assistance is faulty. A warning tone also sounds.</p> <p> WARNING</p> <p>You will need to use more force to steer. There is a risk of an accident.</p> <ul style="list-style-type: none"> ► Check whether you are able to apply the extra force required. ► If you are able to steer safely: carefully drive on to a qualified specialist workshop. ► If you are unable to steer safely: do not drive on. Contact the nearest qualified specialist workshop.
 <p>inoperative Battery low</p>	<p>You have attempted to switch on the auxiliary heating or to activate a departure time using the on-board computer after operating the auxiliary heating twice.</p> <ul style="list-style-type: none"> ► Let the engine run for 10 seconds. The auxiliary heating is operational again. <p>The on-board voltage is too low. The auxiliary heating has switched itself off or cannot be switched on (► page 134).</p> <ul style="list-style-type: none"> ► Drive for a longer distance. The battery is being charged. The auxiliary heating is operational again as soon as the on-board electrical system voltage is sufficient.
 <p>inoperative Refuel vehicle</p>	<p>There is too little fuel in the fuel tank. The auxiliary heating cannot be switched on (► page 134).</p> <ul style="list-style-type: none"> ► Refuel at the nearest filling station.





Display messages	Possible causes/consequences and ► Solutions
 <p>inoperative See Owner's Man.</p>	<p>The auxiliary heating has a temporary malfunction or is faulty.</p> <ul style="list-style-type: none"> ► When the vehicle is on a level surface and the engine has cooled down, make up to four attempts to switch on the auxiliary heating, waiting several minutes between each attempt (► page 134). ► If the auxiliary heating does not switch on, consult a qualified specialist workshop.
<p>Telephone No service</p>	<p>Your vehicle is outside the network provider's transmitter/receiver range.</p> <ul style="list-style-type: none"> ► Wait until the mobile phone operational readiness symbol appears in the multifunction display.
 <p>Top up washer fluid</p>	<p>The washer fluid level in the washer fluid reservoir has dropped below the minimum.</p> <p>i If, during the winter months, you do not add antifreeze to the washer fluid, it may freeze in the washer fluid container. In this case, the Top up washer fluid display message may appear in the multifunction display.</p> <ul style="list-style-type: none"> ► Top up the washer fluid (► page 289).
<p>Wiper malfunctioning</p>	<p>The windscreen wipers are defective.</p> <ul style="list-style-type: none"> ► Visit a qualified specialist workshop.
<p>Hazard warning lamps malfunctioning</p>	<p>The hazard warning lamps are faulty.</p> <ul style="list-style-type: none"> ► Visit a qualified specialist workshop.

Key





Display messages	Possible causes/consequences and ► Solutions
 <p>Key does not belong to vehicle</p>	<p>You have put the wrong key in the ignition lock.</p> <ul style="list-style-type: none"> ► Use the correct key.
 <p>Replace key</p>	<p>The key needs to be replaced.</p> <ul style="list-style-type: none"> ► Visit a qualified specialist workshop.



Warning and indicator lamps in the instrument cluster







Seat belts





Problem	Possible causes/consequences and ► Solutions
 <p>Only for certain countries: the red seat belt warning lamp lights up for six seconds after the engine starts.</p>	<p>The seat belt warning lamp reminds the driver and front passenger to fasten their seat belts.</p> <p>► Fasten your seat belt (▷ page 46).</p>
 <p>Only for certain countries: the red seat belt warning lamp lights up after the engine starts. In addition, a warning tone sounds for up to six seconds.</p>	<p>The driver's seat belt is not fastened.</p> <p>► Fasten your seat belt (▷ page 46). The warning tone ceases.</p>
 <p>The red seat belt warning lamp lights up after the engine starts, as soon as the driver's or the front-passenger door is closed.</p>	<p>The driver or front passenger has not fastened their seat belt.</p> <p>► Fasten your seat belt (▷ page 46). The warning lamp goes out.</p> <p>There are objects on the front-passenger seat.</p> <p>► Remove the objects from the front-passenger seat and stow them in a secure place. The warning lamp goes out.</p>
 <p>The red seat belt warning lamp flashes and an intermittent audible warning sounds.</p>	<p>The driver or front passenger has not fastened their seat belt. At the same time, you are driving faster than 25 km/h or have briefly driven faster than 25 km/h.</p> <p>► Fasten your seat belt (▷ page 46). The warning lamp goes out and the intermittent warning tone ceases.</p> <p>There are objects on the front-passenger seat. At the same time, you are driving faster than 25 km/h or have briefly driven faster than 25 km/h.</p> <p>► Remove the objects from the front-passenger seat and stow them in a secure place. The warning lamp goes out and the intermittent warning tone ceases.</p>





Safety systems



Problem	Possible causes/consequences and ► Solutions
 <p>The red brake system warning lamp is lit while the engine is running. A warning tone also sounds.</p>	<p>There is insufficient brake fluid in the brake fluid reservoir.</p> <p> WARNING</p> <p>The braking efficiency may be impaired. There is a risk of an accident.</p> <ul style="list-style-type: none"> ► Pull over and stop the vehicle safely as soon as possible, paying attention to road and traffic conditions. Do not continue driving under any circumstances. ► Secure the vehicle against rolling away (► page 162). ► Do not top up the brake fluid. Topping up will not rectify the fault. ► Consult a qualified specialist workshop. ► Observe the additional display messages in the multifunction display.
 <p>The yellow ABS warning lamp is lit while the engine is running.</p>	<p>ABS (Anti-lock Brake System) has been deactivated due to a fault. BAS (Brake Assist), COLLISION PREVENTION ASSIST, ESP® (Electronic Stability Program), PRE-SAFE®, the HOLD function, hill start assist, the adaptive brake lights and ESP® trailer stabilisation are also therefore deactivated, for example. ATTENTION ASSIST is deactivated.</p> <p> WARNING</p> <p>The brake system continues to function normally, but without the functions listed above. The wheels could therefore lock if you brake hard, for example.</p> <p>The steerability and braking characteristics may be severely affected. The braking distance may increase in an emergency braking situation.</p> <p>If ESP® is not operational, ESP® is unable to stabilise the vehicle. There is an increased danger of skidding and risk of an accident.</p> <ul style="list-style-type: none"> ► Observe the additional display messages in the multifunction display. ► Drive on carefully. ► Visit a qualified specialist workshop. <p>If the ABS control unit is faulty, there is also a possibility that other systems, such as the navigation system or the automatic transmission, will be unavailable.</p>

Problem	Possible causes/consequences and ► Solutions
 <p>The yellow ABS warning lamp is lit while the engine is running.</p>	<p>ABS is temporarily unavailable. Therefore, BAS, COLLISION PREVENTION ASSIST, ESP[®], EBD (electronic brake force distribution), PRE-SAFE[®], the HOLD function, hill start assist, the adaptive brake lights and ESP[®] trailer stabilisation, for example, are also deactivated.</p> <p>Possible causes:</p> <ul style="list-style-type: none"> • Self-diagnosis is not yet complete. • the on-board voltage may be insufficient <p>ATTENTION ASSIST is deactivated.</p> <p> WARNING</p> <p>The brake system continues to function normally, but without the functions listed above. The front and rear wheels could therefore lock, for example, if you brake hard.</p> <p>The steerability and braking characteristics may be severely affected. The braking distance may increase in an emergency braking situation.</p> <p>If ESP[®] is not operational, ESP[®] is unable to stabilise the vehicle. There is a risk of an accident.</p> <p>► Carefully drive on a suitable stretch of road, making slight steering movements at a speed above 20 km/h. The functions mentioned above are available again when the warning lamp goes out.</p> <p>If the warning lamp is still on:</p> <ul style="list-style-type: none"> ► Observe the additional display messages in the multifunction display. ► Drive on carefully. ► Visit a qualified specialist workshop.



Problem	Possible causes/consequences and ► Solutions
 <p>The yellow ABS warning lamp is lit while the engine is running. A warning tone also sounds.</p>	<p>EBD is faulty. Therefore, ABS, BAS, COLLISION PREVENTION ASSIST, ESP[®], PRE-SAFE[®], the HOLD function, hill start assist, the adaptive brake lights and ESP[®] trailer stabilisation, for example, are not available either.</p> <p>ATTENTION ASSIST is deactivated.</p> <p> WARNING</p> <p>The brake system continues to function normally, but without the functions listed above. The front and rear wheels could therefore lock, for example, if you brake hard.</p> <p>The steerability and braking characteristics may be severely affected. The braking distance may increase in an emergency braking situation.</p> <p>If ESP[®] is not operational, ESP[®] is unable to stabilise the vehicle. There is an increased danger of skidding and risk of an accident.</p> <ul style="list-style-type: none"> ► Observe the additional display messages in the multifunction display. ► Drive on carefully. ► Visit a qualified specialist workshop.
    <p>The red brake warning lamp, the yellow ESP[®] and ESP[®] OFF warning lamps and the yellow ABS warning lamp are lit while the engine is running.</p>	<p>ABS and ESP[®] are malfunctioning. Therefore, BAS, COLLISION PREVENTION ASSIST, EBD, PRE-SAFE[®], the HOLD function, hill start assist, the adaptive brake lights and ESP[®] trailer stabilisation, for example, are not available either.</p> <p>ATTENTION ASSIST is deactivated.</p> <p> WARNING</p> <p>The brake system continues to function normally, but without the functions listed above. The front and rear wheels could therefore lock, for example, if you brake hard.</p> <p>The steerability and braking characteristics may be severely affected. The braking distance may increase in an emergency braking situation.</p> <p>If ESP[®] is not operational, ESP[®] is unable to stabilise the vehicle. There is an increased danger of skidding and risk of an accident.</p> <ul style="list-style-type: none"> ► Observe the additional display messages in the multifunction display. ► Drive on carefully. ► Visit a qualified specialist workshop.



Problem	Possible causes/consequences and ► Solutions
 <p>The yellow ESP[®] warning lamp flashes while the vehicle is in motion.</p>	<p>ESP[®] or traction control has intervened because there is a risk of skidding or at least one wheel has started to spin. Cruise control or DISTRONIC PLUS is deactivated.</p> <ul style="list-style-type: none"> ► Only depress the accelerator pedal as far as necessary when pulling away. ► Accelerate more gently while the vehicle is in motion. ► Adapt your driving style to suit the road and weather conditions. ► Do not deactivate ESP[®]. <p>For exceptions, see: (► page 65).</p>
 <p>The yellow ESP[®] OFF warning lamp is lit while the engine is running.</p>	<p>ESP[®] and ESP[®] trailer stabilisation are deactivated. ESP[®] will not stabilise the vehicle if it starts to skid or if a wheel starts to spin.</p> <p> WARNING</p> <p>If ESP[®] is deactivated, ESP[®] is unable to stabilise the vehicle. There is an increased danger of skidding and risk of an accident.</p> <ul style="list-style-type: none"> ► Reactivate ESP[®]. <p>For exceptions, see: (► page 65).</p> <ul style="list-style-type: none"> ► Adapt your driving style to suit the road and weather conditions. <p>If ESP[®] cannot be activated:</p> <ul style="list-style-type: none"> ► Have ESP[®] checked at a qualified specialist workshop.
 <p>AMG vehicles only: The yellow SPORT handling mode warning lamp is lit while the engine is running.</p>	<p>SPORT handling mode is activated.</p> <p> WARNING</p> <p>When SPORT handling mode is switched on, ESP[®] is unable to stabilise the vehicle. There is an increased danger of skidding and risk of an accident.</p> <ul style="list-style-type: none"> ► Only switch on SPORT handling mode in certain situations (► page 66).

Problem	Possible causes/consequences and ► Solutions
 <p>The yellow ESP[®] and ESP[®] OFF warning lamps are lit while the engine is running.</p>	<p>ESP[®], BAS, COLLISION PREVENTION ASSIST, PRE-SAFE[®], the HOLD function, hill start assist, the adaptive brake lights and ESP[®] trailer stabilisation are not available due to a malfunction. ATTENTION ASSIST is deactivated.</p> <p> WARNING</p> <p>The brake system continues to function normally, but without the functions listed above.</p> <p>The braking distance may thus increase in an emergency braking situation.</p> <p>If ESP[®] is not operational, ESP[®] is unable to stabilise the vehicle. There is an increased danger of skidding and risk of an accident.</p> <ul style="list-style-type: none"> ► Observe the additional display messages in the multifunction display. ► Drive on carefully. ► Visit a qualified specialist workshop.
 <p>The yellow ESP[®] and ESP[®] OFF warning lamps are lit while the engine is running.</p>	<p>ESP[®], BAS, PRE-SAFE[®], the HOLD function, hill start assist and ESP[®] trailer stabilisation are temporarily unavailable. The adaptive brake lights and COLLISION PREVENTION ASSIST may also have failed. ATTENTION ASSIST is deactivated. Self-diagnosis is not yet complete.</p> <p> WARNING</p> <p>The brake system continues to function normally, but without the functions listed above.</p> <p>The braking distance may thus increase in an emergency braking situation.</p> <p>If ESP[®] is not operational, ESP[®] is unable to stabilise the vehicle. There is an increased danger of skidding and risk of an accident.</p> <ul style="list-style-type: none"> ► Carefully drive on a suitable stretch of road, making slight steering movements at a speed above 20 km/h. The functions mentioned above are available again when the warning lamp goes out. <p>If the warning lamp is still on:</p> <ul style="list-style-type: none"> ► Observe the additional display messages in the multifunction display. ► Drive on carefully. ► Visit a qualified specialist workshop.

Problem	Possible causes/consequences and ► Solutions
 <p>The red indicator lamp for the electric parking brake flashes or is lit and/or the yellow warning lamp for the electric parking brake is lit.</p>	<ul style="list-style-type: none"> ► Observe the additional display messages in the multifunction display.
 <p>The red SRS warning lamp is lit while the engine is running.</p>	<p>There is a malfunction in the SRS (Supplemental Restraint System).</p> <p> WARNING</p> <p>The airbags or belt tensioners may either be triggered unintentionally or, in the event of an accident, may not be triggered. This poses an increased risk of injury.</p> <ul style="list-style-type: none"> ► Drive on carefully. ► Have SRS checked at a qualified specialist workshop immediately. <p>For further information about the Supplemental Restraint System, see (► page 41).</p>





Engine	
Problem	Possible causes/consequences and ► Solutions
 <p>The yellow engine diagnostics warning lamp lights up while the engine is running.</p>	<p>There may be a fault, for example:</p> <ul style="list-style-type: none"> • in the engine management • in the fuel injection system • in the exhaust system • in the ignition system (for vehicles with petrol engines) • in the fuel system <p>The emission limit values may be exceeded and the engine may be running in emergency mode.</p> <p>► Have the vehicle checked as soon as possible at a qualified specialist workshop.</p> <p>Vehicles with a diesel engine: the fuel tank has been run dry (▷ page 161).</p> <p>► Start the engine three to four times after refuelling. If the yellow engine diagnostics warning lamp goes out, emergency running mode is cancelled. The vehicle need not be checked.</p>
 <p>The yellow reserve fuel warning lamp lights up while the engine is running.</p>	<p>The fuel level has dropped into the reserve range.</p> <p>Operation of the auxiliary heating is deactivated when the fuel level drops into the reserve range.</p> <p>► Refuel at the nearest filling station.</p>
 <p>The red coolant warning lamp lights up while the engine is running and the coolant temperature gauge is at the start of the scale.</p>	<p>The temperature sensor for the coolant temperature gauge is faulty.</p> <p>The coolant temperature is no longer being monitored. There is a risk of engine damage if the coolant temperature is too high.</p> <p>► Stop the vehicle immediately, paying attention to road and traffic conditions, and switch off the engine. Do not continue driving under any circumstances.</p> <p>► Secure the vehicle against rolling away (▷ page 162).</p> <p>► Consult a qualified specialist workshop.</p>

Problem	Possible causes/consequences and ► Solutions
 <p>The red coolant warning lamp comes on while the engine is running.</p>	<p>The coolant level is too low.</p> <p>If the coolant level is correct, the airflow to the engine radiator may be blocked or the electric engine radiator fan may be malfunctioning.</p> <p>The coolant is too hot and the engine is no longer being cooled sufficiently.</p> <ul style="list-style-type: none"> ► Observe the additional display messages in the multifunction display. ► Stop the vehicle immediately, paying attention to road and traffic conditions, and switch off the engine. ► Secure the vehicle against rolling away (► page 162). ► Leave the vehicle and keep a safe distance from the vehicle until the engine has cooled down. ► Check the coolant level and top up the coolant (► page 288). Observe the warning notes as you do so. ► If you have to top up the coolant frequently, have the engine cooling system checked. ► Make sure that the air supply to the engine radiator is not blocked, e.g. by frozen slush. ► Do not start the engine again until the coolant temperature is below 120 °C. The engine may otherwise be damaged. ► Drive to the nearest qualified specialist workshop. ► Avoid heavy loads on the engine as you do so, e.g. driving in mountainous terrain and stop-start traffic.
 <p>The red coolant warning lamp comes on while the engine is running. A warning tone also sounds.</p>	<p>The coolant temperature has exceeded 120 °C. The airflow to the engine radiator may be blocked or the coolant level may be too low.</p> <p> WARNING</p> <p>The engine is not being cooled sufficiently and may be damaged. Never drive with an overheated engine. Driving when your engine is overheated can cause some fluids which may have leaked into the engine compartment to catch fire.</p> <p>Steam from an overheated engine can cause serious burns which can occur just by opening the bonnet.</p> <p>This poses a risk of injury.</p> <ul style="list-style-type: none"> ► Observe the additional display messages in the multifunction display. ► Stop the vehicle immediately, paying attention to road and traffic conditions, and switch off the engine. ► Secure the vehicle against rolling away (► page 162).

Problem	Possible causes/consequences and ► Solutions
	<ul style="list-style-type: none"> ► Leave the vehicle and keep a safe distance from the vehicle until the engine has cooled down. ► Check the coolant level and top up the coolant (▷ page 288). Observe the warning notes as you do so. ► If you have to top up the coolant frequently, have the engine cooling system checked. ► Make sure that the air supply to the engine radiator is not blocked, e.g. by frozen slush. ► If the coolant temperature is below 120 °C, you can continue driving to the nearest qualified specialist workshop. ► Avoid heavy loads on the engine as you do so, e.g. driving in mountainous terrain and stop-start traffic.

Driving systems

Problem	Possible causes/consequences and ► Solutions
 <p>The red distance warning lamp lights up while the vehicle is in motion.</p>	<p>The distance to the vehicle in front is too small for the speed selected.</p> <ul style="list-style-type: none"> ► Increase the distance.
 <p>The red distance warning lamp lights up while the vehicle is in motion. A warning tone also sounds.</p>	<p>You are approaching a vehicle or a stationary obstacle in your line of travel at too high a speed.</p> <ul style="list-style-type: none"> ► Be prepared to brake immediately. ► Pay careful attention to the traffic situation. You may have to brake or take evasive action.

Useful information	268
Loading guidelines	268
Stowage areas	269
Features	275

Useful information

- i** This Owner's Manual describes all models, series and optional equipment for your vehicle that were available at the time of going to press. National variations are possible. Note that your vehicle may not be equipped with all of the functions described. This is also the case for systems and functions relevant to safety.
- i** Read the information on qualified specialist workshops: (▷ page 24).

Loading guidelines

WARNING

If objects, luggage or loads are not secured or not secured sufficiently, they could slip, tip over or be flung around and thereby hit vehicle occupants. There is a risk of injury, especially when braking or abruptly changing directions. Always store objects so that they cannot be flung around. Secure objects, luggage or loads against slipping or tipping before the journey.

WARNING

Combustion engines emit poisonous exhaust gases such as carbon monoxide. If the tailgate is open when the engine is running, particularly if the vehicle is moving, exhaust fumes could enter the passenger compartment. There is a risk of poisoning. Turn off the engine before opening the tailgate. Never drive with the tailgate open.

The handling characteristics of a laden vehicle are dependent on the distribution of the load within the vehicle. For this reason, you should observe the following notes when transporting a load:

- when transporting a load, never exceed the maximum permissible gross vehicle weight

or the permissible axle loads for the vehicle (including occupants).

- the luggage compartment is the preferred place to carry objects.
 - position heavy loads as far forwards as possible and as low down in the luggage compartment as possible.
 - the load must not protrude above the upper edge of the seat backrests.
 - always place the load against the rear or front seat backrests. Make sure that the seat backrests are securely locked into place.
 - always place the load behind unoccupied seats if possible.
 - use the lashing eyelets and the luggage nets to transport loads and luggage.
 - only use lashing eyelets and fastening components that are suitable for the weight and size of the load.
 - the maximum load capacity of the stowage well under the luggage compartment floor is 25 kg.
 - secure the load with sufficiently strong and wear-resistant lashing material. Pad sharp edges for protection.
- i** Lashing material is available at any qualified specialist workshop.
- !** Do not position the load on one part of the folding luggage compartment floor only. The maximum load capacity of the folding luggage compartment floor is 100 kg. Spread the weight evenly to avoid damaging the luggage compartment floor. Place a solid board under the load if necessary. Please note that the load on the luggage compartment floor will be increased when the load is lashed down.

Stowage areas

Stowage spaces

Important safety notes

WARNING

If you do not correctly store objects in the vehicle interior, they can slip or be flung around, thus striking vehicle occupants. There is a risk of injury, especially when braking or abruptly changing directions.

- Always store objects so that they cannot be flung around in these or in similar situations.
- Always make sure that objects do not protrude from stowage compartments, luggage nets or stowage nets.
- Close lockable stowage compartments while driving.
- Stow and secure objects that are heavy, hard, pointy, sharp-edged, fragile or too large in the luggage compartment.

Observe the loading guidelines (▷ page 268).

Front stowage compartments

Glove compartment

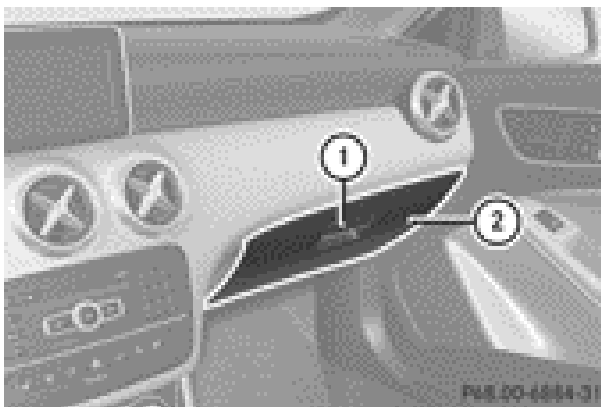

- ▶ **To open:** pull handle ① and open glove compartment flap ②.
 - ▶ **To close:** fold glove compartment flap ② upwards until it engages.
- i** There is a pen holder at the top of the glove compartment flap.

Spectacles compartment

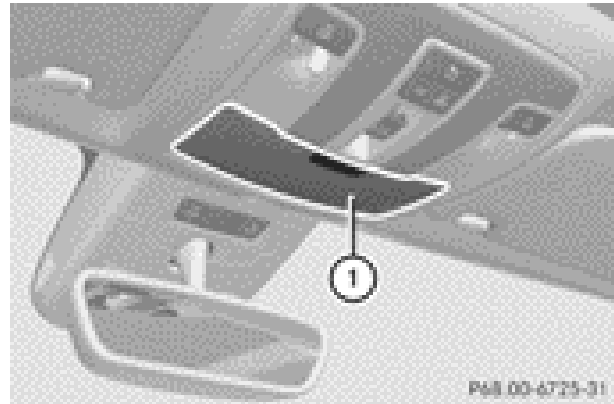

- ▶ **To open:** press marking ①.

Make sure that the spectacles compartment is always closed while the vehicle is in motion.

Stowage compartment in the centre console



- ▶ **To open:** press the marking on cover ①.
- i** Depending on the vehicle's equipment, there is an open instead of a closed stowage compartment or an ashtray in the centre console.

Stowage compartment in front of the armrest (vehicles with automatic transmission)



► **To open:** press the marking on cover ①.

i You can remove the non-slip mat and the insert for cleaning. When removing the insert you will have to overcome some slight resistance.

Stowage compartment/telephone compartment under the armrest

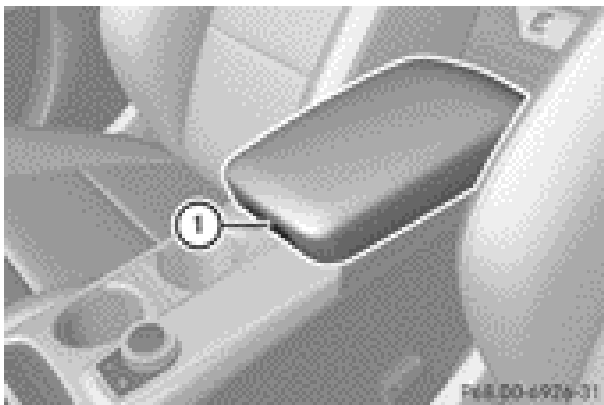

► **To open:** on vehicles with moveable armrests, make sure that the armrest is in the rearmost position.

► Press button ① and fold the armrest up.

i Depending on the vehicle's equipment, a USB port and an AUX-IN jack or a Media Interface are installed in the stowage compartment. A Media Interface is a universal interface for portable audio equipment, e.g. for an iPod® or MP3 player (see the separate Audio or COMAND Online operating instructions).

Stowage compartment under the driver's and front-passenger seat

⚠ WARNING

If you exceed the maximum permitted load of the stowage compartment, the cover is unable to restrain the objects. Objects may be thrown out of the stowage compartment and hit vehicle occupants as a result. There is a risk of injury, particularly in the event of sudden braking or a sudden change in direction.

Always observe the maximum load of the stowage compartment. Stow and secure heavy objects in the luggage compartment.

The maximum permissible load of the stowage compartment is 1.2 kg.

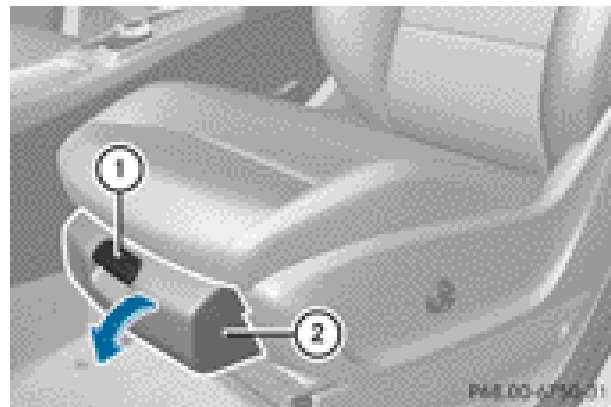

► **To open:** pull handle ① up and fold cover ② forwards.

i On vehicles with a fire extinguisher instead of a stowage compartment, the fire extinguisher is installed under the driver's seat.

Rear storage compartments

Stowage compartment in the rear centre console

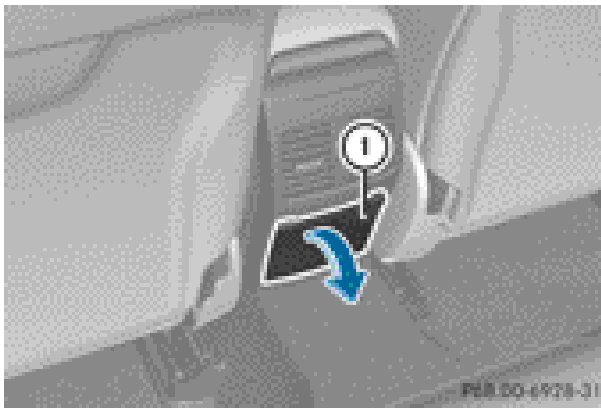

- ▶ **To open:** pull down the top of storage compartment ① by the edge of the handle.

i Depending on the vehicle's equipment, there may be an open stowage space above the stowage compartment.

Luggage nets

! The maximum load that may be placed on the luggage net under the rear shelf is 2.5 kg.

Luggage nets are located:

- in the front-passenger footwell
- on the back of the driver's and front-passenger seat
- beneath the parcel shelf
- on the left and right-hand side in the luggage compartment

Observe the loading guidelines (▷ page 268) and the safety notes regarding stowage spaces (▷ page 269).

Through-loading facility in the rear compartment

Observe the loading guidelines (▷ page 268).

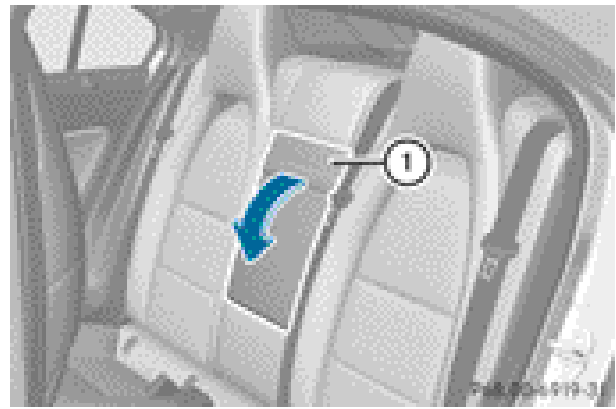

- ▶ **To open:** fold down seat armrest ①.
- ▶ Pull the cover, which can now be seen, forwards by the grip until it lies on armrest ①.
- ▶ Pull the centre head restraint on the rear bench seat into the uppermost position (▷ page 94).

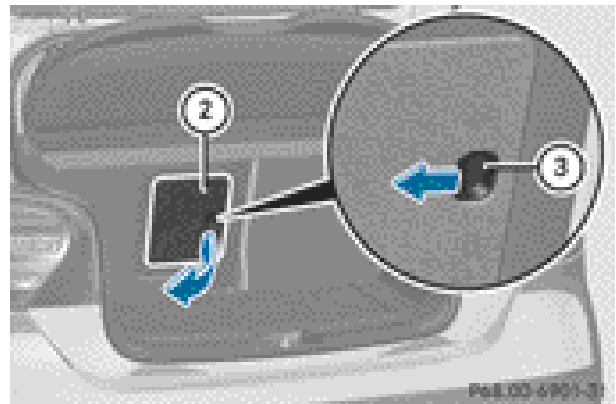

- ▶ Slide locking mechanism ③ in the direction of the arrow.
- ▶ Swing flap ② fully to the side. Flap ② is held open by a magnet.
- ▶ **To close:** swing flap ② in the luggage compartment back until it engages.
- ▶ Fold the cover forwards until it engages into armrest ①.
- ▶ Fold armrest ① up fully if necessary.

Enlarging the luggage compartment

Important safety notes

WARNING

If the rear bench seat/rear seat and seat backrest are not engaged they could fold forwards, e.g. when braking suddenly or in the event of an accident.

- The vehicle occupant would thereby be pushed into the seat belt by the rear bench seat/rear seat or by the seat backrest. The seat belt cannot protect as intended and could result in additional injury.
- Objects or loads in the boot/luggage compartment cannot be restrained by the seat backrest.

This poses an increased risk of injury.

Before every trip, make sure that the seat backrests and the rear bench seat/rear seat are engaged before every trip.

- !** Before folding the backrest in the rear compartment forwards, make sure that the rear compartment armrest and the cupholder are folded in. They may otherwise be damaged.

Observe the loading guidelines (▷ page 268).

Folding the rear seat backrest forwards and back

Folding the rear seat backrest forward

The left-hand and right-hand rear seat backrests can be folded forwards separately to increase the luggage compartment capacity.

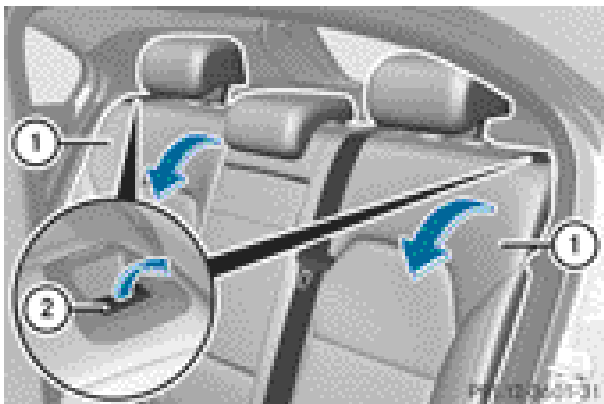

- ▶ Fully insert the backrest head restraints (▷ page 96).
- ▶ Move the driver's or front-passenger seat forward if necessary.
- ▶ Pull left-hand or right-hand release handle (2) of the seat backrest forwards. The corresponding seat backrest (1) is released.
- ▶ Fold backrest (1) forwards.
- ▶ Move the driver's or front-passenger seat back if necessary.

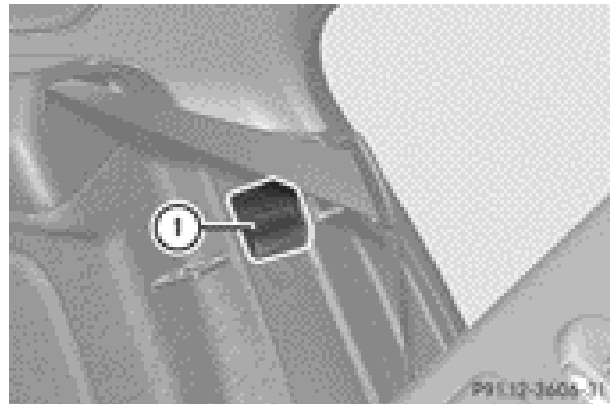

- ▶ Insert the seat belt into seat-belt extender (1).

Folding the rear seat backrest back

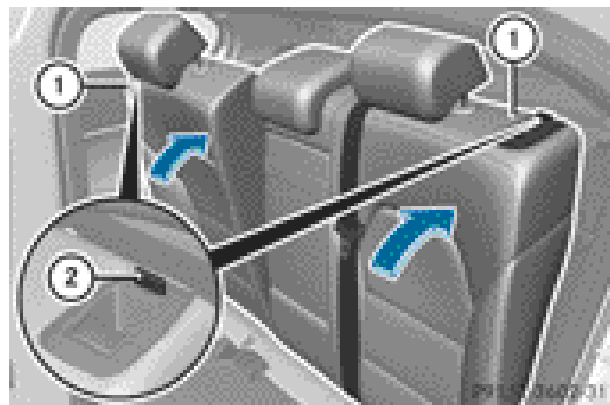

- ▶ Move the driver's or front-passenger seat forward if necessary.
- !** Make sure that the seat belt does not become trapped when folding the rear seat backrest back. Otherwise, it could be damaged.

- ▶ Fold seat backrest ① back until it engages. Red lock status indicator ② is no longer visible.
- ▶ Adjust the head restraints if necessary (▷ page 96).
- ▶ Move the driver's or front-passenger seat back if necessary.

Parcel shelf

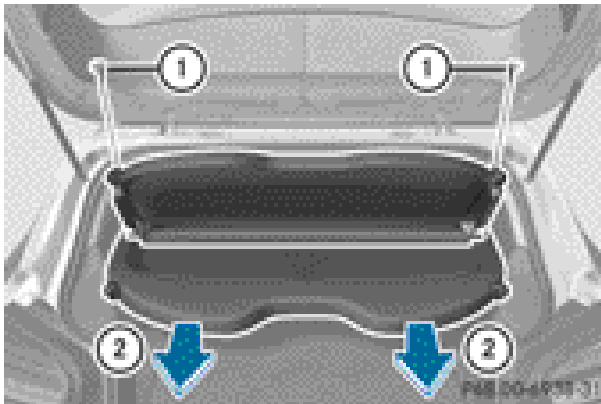

! The maximum load which may be placed on the rear shelf is 2.5 kg.

- ▶ **To remove:** detach straps ① from the tailgate.
- ▶ Swing the rear shelf down.
- ▶ Pull the rear shelf out to the rear ②.
- ▶ **To fit:** place the rear shelf on the guide rails on the left and right.
- ▶ Push the rear shelf evenly forwards using both hands until it engages.
- ▶ Swing the rear shelf up.
- ▶ Attach straps ① to the tailgate.

Securing a load

Lashing eyelets

Observe the following notes on securing loads:

- observe the loading guidelines (▷ page 268).
- secure the load using the lashing eyelets.

- distribute the load on the lashing eyelets evenly.
- do not use elastic straps or nets to secure a load, as these are only intended as an anti-slip protection for light loads.
- do not route lashing materials across sharp edges or corners.
- pad sharp edges for protection.

There are four lashing eyelets in the luggage compartment.

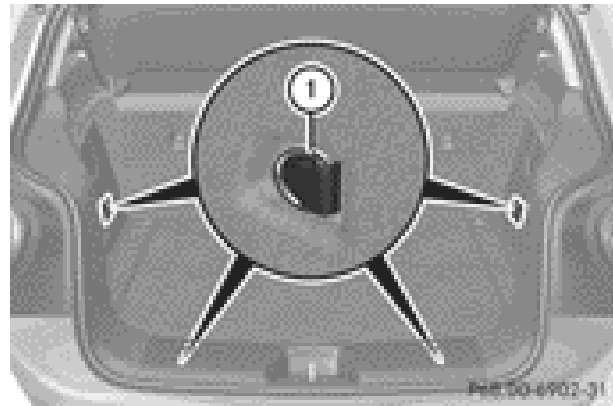

① Lashing eyelets

Bag hook

⚠ WARNING

The bag hooks cannot restrain heavy objects or items of luggage. Objects or items of luggage could be flung around and thereby hit vehicle occupants when braking or abruptly changing directions. There is a risk of injury. Only hang light objects on the bag hooks. Never hang hard, sharp-edged or fragile objects on the bag hooks.

! The bag hook can bear a maximum load of 3 kg. Do not use it to secure a load.

There is one bag hook on either side of the luggage compartment.

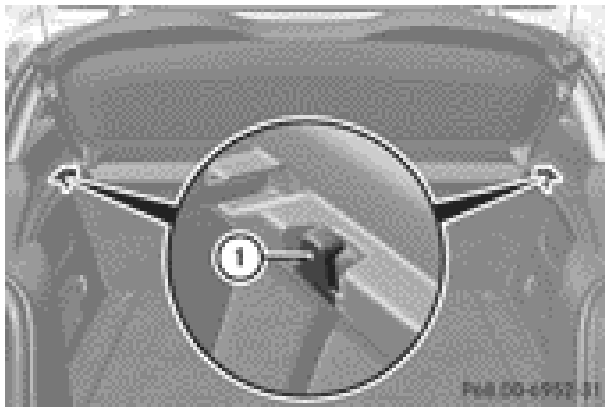

① Bag hook

Stowage well underneath the luggage compartment floor

Important safety notes

WARNING

If you drive when the luggage compartment floor is open, objects could be flung around, thus striking vehicle occupants. There is a risk of injury, especially when braking or abruptly changing directions.

Always close the luggage compartment floor before a journey.

! The maximum load capacity of the stowage well under the luggage compartment floor is 25 kg.

Opening/closing the luggage compartment floor

A bracket for TIREFIT, the vehicle tool kit, etc. is located underneath the luggage compartment floor.



- ▶ **To open:** open the tailgate.
- ▶ Press down handle ① on ribbing ②. Handle ① folds upwards.
- ▶ Swing the luggage compartment floor upwards using handle ① until it rests against the luggage compartment cover.
- ▶ **If the rear shelf is fitted:** hook the loop on the luggage compartment floor into the hook on the underside of the rear shelf.

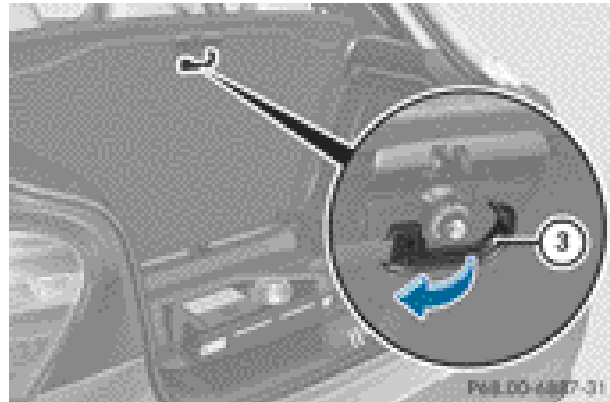

- ▶ **If the rear shelf is not fitted:** fold out hook ③ on the underside of the luggage compartment floor.

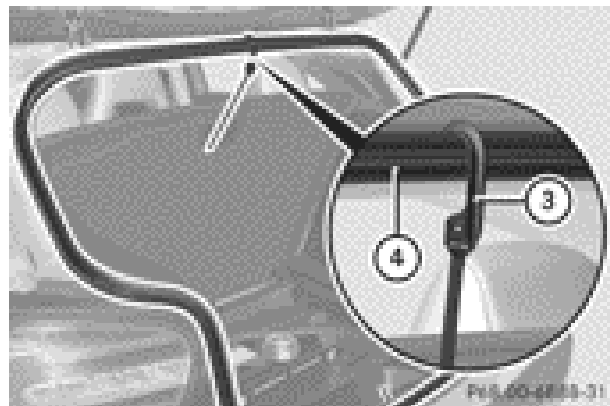

- ▶ Attach hook ③ to the luggage compartment's upper seal ④.
- ▶ **To close (if the rear shelf is fitted):** unhook the loop from the hook on the underside of the rear shelf.
- ▶ **If the rear shelf is not fitted:** detach hook ③ from upper seal ④.
- ▶ Fasten hook ③ to the bracket on the underside of the luggage compartment floor.

- ▶ Fold the luggage compartment floor down.
- ▶ Press the luggage compartment floor down until it engages.

Roof carrier

Important safety notes

WARNING

An incorrectly secured roof carrier, ski rack or load could become detached from the vehicle. These objects might then be thrown around, and could injure you or others or cause an accident. Follow the roof carrier/ski rack manufacturer's installation instructions and special instructions for use.

The roof load raises the vehicle's centre of gravity, thereby affecting vehicle handling. You must always observe the maximum roof load of 75 kg. Always adapt your driving style to the prevailing road, traffic and weather conditions and drive with particular care if the roof is laden.

! Mercedes-Benz recommends that you only use roof carriers that have been tested and approved for Mercedes-Benz vehicles. This helps to prevent damage to the vehicle.

Position the load on the roof carrier in such a way that the vehicle will not sustain damage even when it is in motion.

Ensure that, depending on the vehicle's equipment, you can raise the panorama sliding sunroof fully and open the tailgate fully when the roof carrier is fitted.

i Vehicles with panorama sliding sunroof: if a roof carrier is fitted, the panorama sliding sunroof cannot be opened. In order to allow ventilation of the vehicle interior, you can raise the panorama sliding sunroof. If a roof carrier approved by Mercedes-Benz makes contact with the panorama sliding sunroof, the sunroof will lower slightly but remain raised in the rear.

Attaching the roof carrier

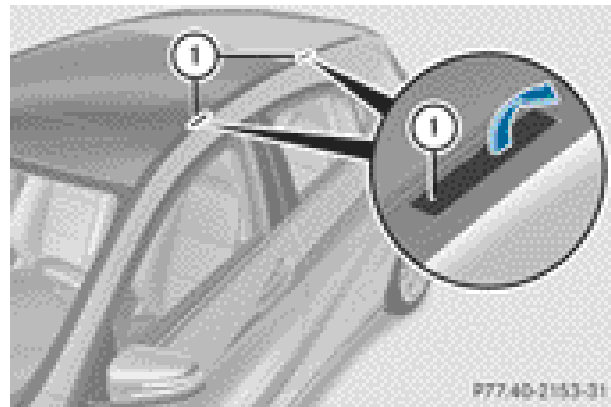

- ▶ Open covers ① carefully in the direction of the arrow.
- ▶ Fold covers ① upwards.
- ▶ Only secure the roof carrier to the anchorage points under covers ①.
- ▶ Observe the manufacturer's installation instructions.

Features

Cup holders

Important safety notes

WARNING

The cup holder cannot secure a drinks container in place during a journey. If you use a cup holder during a journey, the drinks container could be flung around and liquid could be spilt. Vehicle occupants could come into contact with the liquid and, in particular, be scalded by hot liquid. You could be distracted from the traffic situation and lose control of the vehicle. There is a risk of an accident and injury.

Only use the cup holder when the vehicle is stationary. Only place containers of a suitable size in the cup holder. Seal the container, in particular when it contains hot liquid.

WARNING

If you do not correctly store objects in the vehicle interior, they can slip or be flung around, thus striking vehicle occupants.

There is a risk of injury, especially when braking or abruptly changing directions.

- Always store objects so that they cannot be flung around in these or in similar situations.
- Always make sure that objects do not protrude from stowage compartments, luggage nets or stowage nets.
- Close lockable stowage compartments while driving.
- Stow and secure objects that are heavy, hard, pointy, sharp-edged, fragile or too large in the luggage compartment.

! Only use the cup holders for containers of the right size and which have lids. The drinks could otherwise spill.

The stowage compartments in the doors provide space for bottles:

- front: capacity up to 1.0 l
- rear: capacity up to 0.5 l

Cup holder in the front centre console

All vehicles (except vehicles with Audio 5)

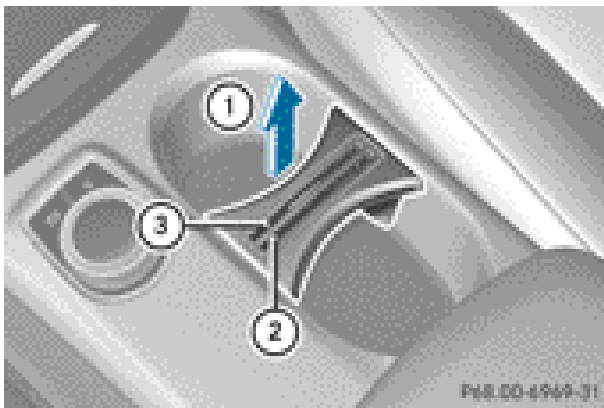

Two coin holders ③ and a card holder ② can be found in the cup holder.

The cup holder and the rubber mat underneath can be removed for cleaning. Clean them with clean, lukewarm water only.

► **To remove:** Lift the cup holder up and out with a brief tug ①.

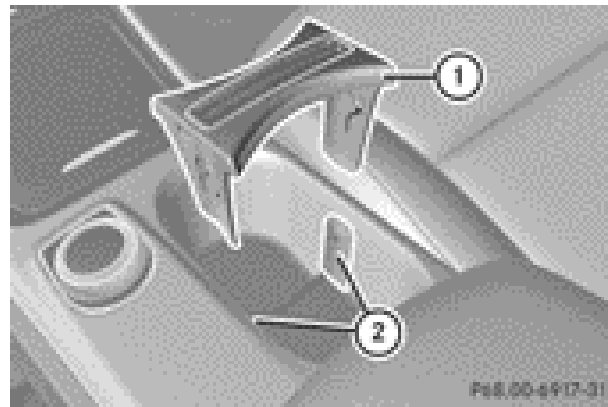

- **To fit:** ① insert the cup holder into lateral curved sections ② in the stowage compartment. Simultaneously insert the cup holder in such a way that the wedge of the upper section of the cup holder faces forwards.
- ① Press the cup holder downwards until it engages on the right and left-hand sides.

Vehicles with Audio 5

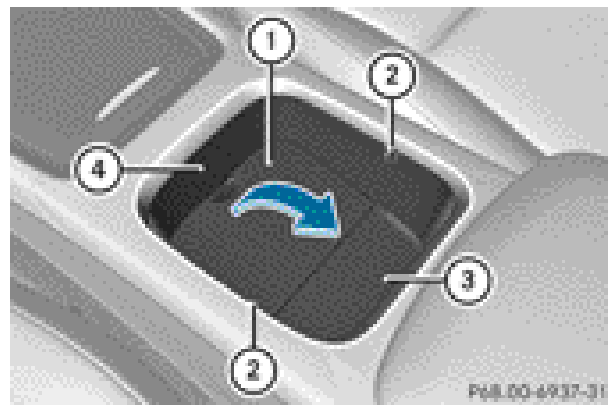

- Fold lift-up lid ① in stowage compartment ③ up until it engages in the two lugs ②. You can use front part ④ as a cup holder.

Cup holder in the rear seat armrest

! Do not sit on or support your body weight on the rear seat armrest when it is folded down, as you could otherwise damage it.

! Close the cup holder before folding the rear seat armrest up. Otherwise, the cup holder could be damaged.

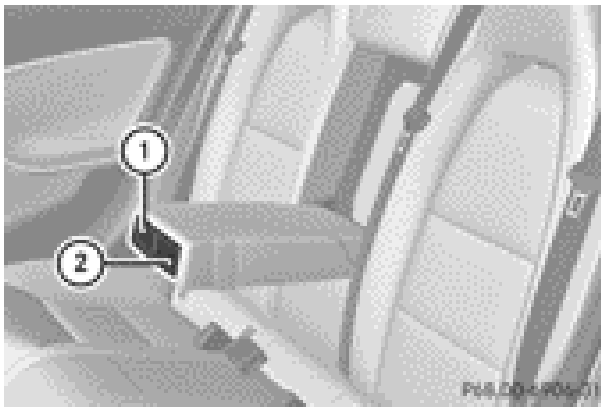

- ▶ Fold down the rear seat armrest.
- ▶ **To open:** press the front of cup holder ① or ②. Cup holder ① or ② extends automatically.
- ▶ **To close:** slide cup holder ① or ② back until it engages.

Sun visors

Overview

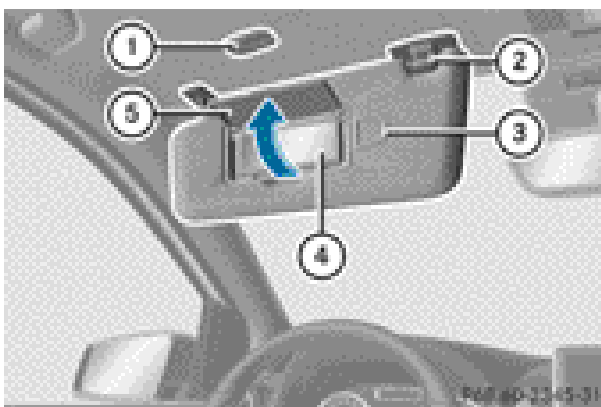

- ① Mirror light
- ② Bracket
- ③ Retaining clip, e.g. for a car park ticket
- ④ Vanity mirror
- ⑤ Mirror cover

Vanity mirror in the sun visor

Mirror light ① only functions if the sun visor is clipped into bracket ② and mirror cover ⑤ has been folded up.

Glare from the side

- ▶ Fold down the sun visor.
- ▶ Pull the sun visor out of bracket ②.
- ▶ Swing the sun visor to the side.
- ▶ **Vehicles with mirror lights:** slide the sun visor horizontally as desired.

Ashtray

Front ashtray

- ! The stowage space under the ashtray is not heat resistant. Before placing lit cigarettes in the ashtray, make sure that the ashtray is properly engaged. Otherwise, the stowage space could be damaged.

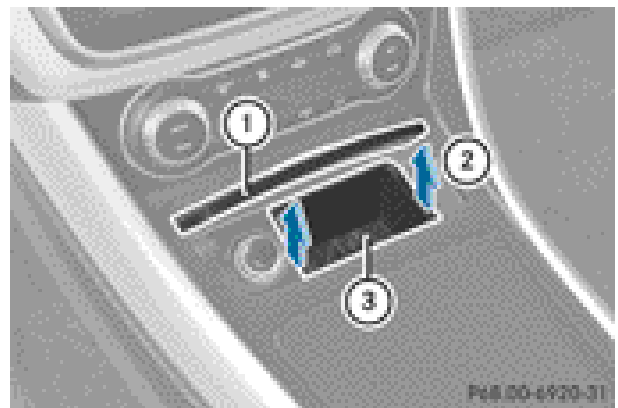

Example: vehicles with a stowage compartment cover

- ▶ **To open:** push the lower section of cover ①. The stowage compartment opens.
 - ▶ **To remove the insert:** lift insert ② up ② and out.
 - ▶ **To refit the insert:** press insert ③ into the holder until it engages.
- i** If you remove the ashtray insert, you can use the resulting compartment for stowage.

Rear-compartment ashtray

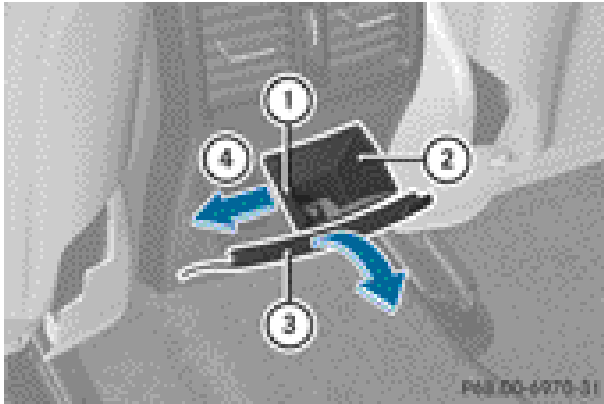

- ▶ **To open:** pull cover (3) out by its top edge.
- ▶ **To remove:** pull insert (2) by recess (1) in the direction of arrow (4) until it audibly releases.
- ▶ Lift insert (2) up and out.
- ▶ **To fit the insert:** fit insert (2) from above into the holder and press down into the holder until it engages.

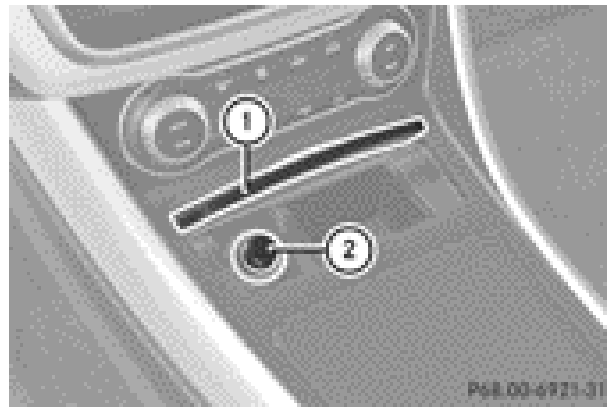

Example: vehicles with a stowage compartment cover

- ▶ Turn the key to position **2** in the ignition lock (▷ page 143).
- ▶ **To open:** push the lower section of cover (1). The stowage compartment opens.
- ▶ Press in cigarette lighter (2). Cigarette lighter (2) will pop out automatically when the heating element is red-hot.

Cigarette lighter

WARNING

You can burn yourself if you touch the hot heating element or the socket of the cigarette lighter.

In addition, flammable materials can ignite if:

- the hot cigarette lighter falls
- a child holds the hot cigarette lighter to objects, for example

There is a risk of fire and injury.

Always hold the cigarette lighter by the knob. Always make sure that the cigarette lighter is out of reach of children. Never leave children unattended in the vehicle.

Your attention must always be focused on the traffic conditions. Only use the cigarette lighter when road and traffic conditions permit.

12 V sockets

Points to observe before use

- ▶ Turn the key to position **1** in the ignition lock (▷ page 143).

The sockets can be used for accessories with a maximum draw of 180 W (15 A). Accessories include such items as lamps or chargers for mobile phones.

If you use the sockets for long periods when the engine is switched off, the battery may discharge.

- i** An emergency cut-off ensures that the on-board voltage does not drop too low. If the on-board voltage is too low, the power to the sockets is automatically cut. This ensures that there is sufficient power to start the engine.

Socket in the front centre console

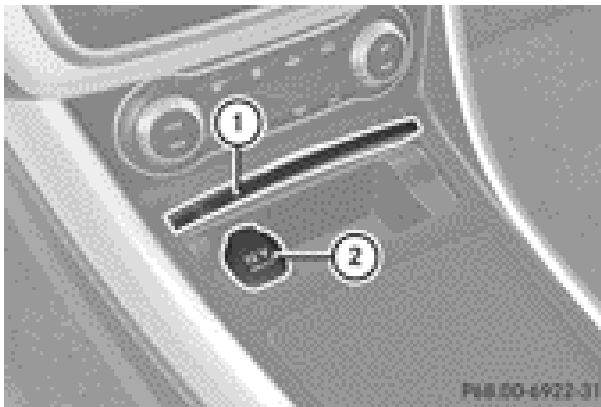

Vehicles with a stowage compartment cover

- ▶ **To open:** push the lower section of cover ①.
- The stowage compartment opens.
- ▶ Lift up the cover of socket ②.

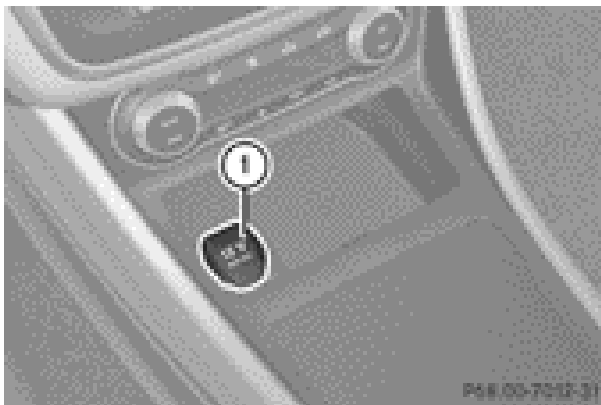

Vehicles without a stowage compartment cover

- ▶ Lift up the cover of socket ①.

Socket in the rear-compartment centre console



- ▶ Pull cover ① out by its top edge.
- ▶ Lift up the cover of socket ②.

Socket in the luggage compartment

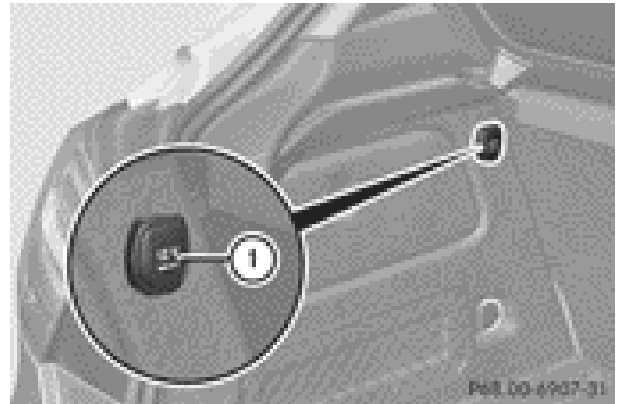

- ▶ Lift up the cover of socket ①.

Mobile phone

Important safety notes

WARNING

Operating mobile communications equipment while driving distracts you from paying attention to traffic conditions. This could also cause you to lose control of the vehicle. There is a risk of an accident.

Use this device only when the vehicle is stationary.

- i** You must observe the legal requirements for the country in which you are currently driving when operating mobile communications equipment in the vehicle.

If it is permitted by law to operate communications equipment while the vehicle is in motion, you may only do so if the traffic situation permits. You may otherwise be distracted from the traffic conditions, cause an accident and injure yourself and others.

Excessive levels of electromagnetic radiation may cause damage to your health and to the health of others. The use of an exterior aerial takes into consideration the scientific discus-

sion surrounding the possible health risk posed by electromagnetic fields.

Mercedes-Benz recommends the use of an approved exterior aerial. This ensures:

- optimal mobile phone reception quality in the vehicle
- mutual influences between the vehicle electronics and mobile phones are minimised

An exterior aerial has the following advantages:

- it conducts the electromagnetic fields generated by a wireless device to the exterior.
- the field strength in the vehicle interior is lower than in a vehicle that does not have an exterior aerial.

Information on retrofitting two-way radios and mobile phones (RF transmitters) (▷ page 336).

General notes

There are various mobile phone brackets that may be fitted in your vehicle; in some cases, these are country-specific.

You can connect a Bluetooth®-capable mobile phone with Audio 20 or COMAND Online via the Bluetooth® interface. This also applies if your vehicle is equipped with convenience telephony.

More information on suitable mobile phones, mobile phone brackets and on connecting Bluetooth®-capable mobile phones with Audio 20 or COMAND Online can be obtained:

- at your Mercedes-Benz Service Centre
- on the Internet at <http://www.mercedes-benz.com/connect>

i The functions and services available when you use the phone depend on your mobile phone model and service provider.

Using a mobile phone



If the mobile phone is inserted in the mobile phone bracket, you can speak to the person you are calling using the hands-free system.

- ▶ Open the telephone compartment (▷ page 270).
- ▶ Place the mobile phone bracket into the pre-installed fitting (see the separate installation instructions for the mobile phone fitting).
- ▶ Insert the mobile phone into the mobile phone bracket (see the separate installation instructions for the mobile phone fitting).

i On some mobile phone brackets, first you have to connect the phone to the mobile phone bracket via Bluetooth® (see the separate operating instructions for the mobile phone bracket).

If this is the case, the mobile phone does not have to be inserted into the bracket for you to be able to use the telephone functions. However, the charging function and aerial function are not available.

Operating the mobile phone

You can operate the telephone using the  and  buttons on the multifunction steering wheel. You can operate other mobile phone functions via the on-board computer (▷ page 215).

When you remove the key from the ignition lock, the mobile phone stays switched on. However, you can no longer use the hands-free system.

If you have an active call and would like to take the key out of the ignition lock, first remove the mobile phone from the bracket.

i If you use a mobile phone bracket which is connected to your mobile via Bluetooth® and you wish to continue a call on your mobile phone:

You should switch the call to "Private mode" before you remove the key from the

ignition lock. Otherwise, it will take up to 20 seconds for the mobile phone to disconnect from the system. Only then can you continue the call on your mobile phone. Notes on the necessary steps for setting "Private mode" can be found in the separate operating instructions of the mobile phone.

- ❗ Not all mobile phones support "Private mode".

Mobile phone bracket in the stowage space

You can fold the pre-installed bracket up to improve access to the stowage space beneath it. Depending on the vehicle's equipment, a USB connection and an AUX-IN connection/Media Interface are fitted in the stowage compartment (▷ page 270).

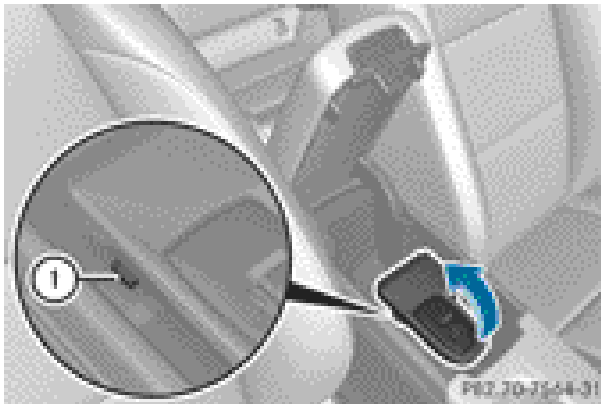

- ▶ **To fold the bracket up:** press button ①.
- ▶ **To fold the bracket down:** press the bracket down and allow it to engage.

Floormat on the driver's side

⚠ WARNING

Objects in the driver's footwell can restrict the pedal travel or obstruct a depressed pedal. The operating and road safety of the vehicle is jeopardised. There is a risk of an accident. Make sure that all objects in the vehicle are stowed correctly, and that they cannot enter the driver's footwell. Fit the floormats

securely and as specified in order to ensure sufficient clearance for the pedals. Do not use loose floormats.

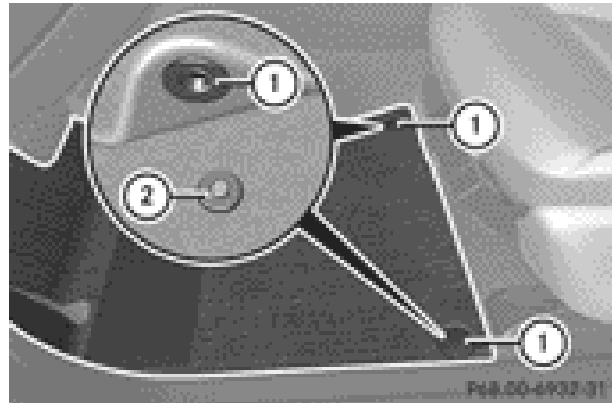

- ▶ Slide the seat backwards.
- ▶ **To fit:** lay the floormat in the footwell.
- ▶ Press safety catch knobs ① onto retainers ②.
- ▶ **To remove:** pull the floormat away from retainers ②.
- ▶ Remove the floormats.

Retrofitted anti-glare film

Retrofitted anti-glare film on the inside of the windows can interfere with radio/mobile telephone reception. This is particularly the case for conductive or metallic-coated films. You can obtain information about anti-glare film from a qualified specialist workshop.

Useful information	284
Engine compartment	284
Service	289
Care	290

Useful information

- i** This Owner's Manual describes all models, series and optional equipment for your vehicle that were available at the time of going to press. National variations are possible. Note that your vehicle may not be equipped with all of the functions described. This is also the case for systems and functions relevant to safety.
- i** Read the information on qualified specialist workshops: (▷ page 24).

Engine compartment

Bonnet

Important safety notes

WARNING

An unlocked bonnet may open while driving and block your view. There is a risk of an accident.

Never unlock the bonnet while driving.

WARNING

When being opened and closed, the bonnet may suddenly fall into the closed position. There is a risk of injury to persons in the range of movement of the bonnet.

Open and close the bonnet only when nobody is in the range of movement.

WARNING

Certain components in the engine compartment could be very hot, e.g. the engine, the radiator and parts of the exhaust system. There is a risk of injury when accessing the engine compartment.

As far as possible, allow the engine to cool down and only touch the following components.

WARNING

If you open the bonnet while the engine is overheating or while there is a fire in the

engine compartment, you could come into contact with hot gases or other leaking service products. There is a danger of injury. Allow an overheating engine to cool down before opening the bonnet. If there is a fire in the engine compartment, leave the bonnet closed and notify the fire brigade.

WARNING

There are parts in the engine compartment that move. Certain components may continue to run even if the ignition is switched off or may suddenly start again, e.g. the radiator fan. There is a danger of injury.

If you need to access the engine compartment:

- switch off the ignition
- never enter the danger area of moving components, e.g. the rotation area of the fan
- keep items of clothing away from moving parts

WARNING

The ignition system and the fuel injection system operate with a high voltage. If you touch the live components, you could receive an electric shock. There is a danger of injury. Never touch components of the ignition system or the fuel injection system when the ignition is switched on.

Active bonnet (pedestrian protection)

Operating principle

- !** Once triggered, an active bonnet must be reset at a qualified specialist workshop, e.g. a Mercedes-Benz Service Centre. The active bonnet function will then be available again. The additional pedestrian protection provided by the active bonnet will then be restored.

The active bonnet is only available in certain countries.

The active bonnet can reduce the risk of injury to pedestrians in certain accident situations.

Raising the active bonnet increases the clearance to hard components, such as the engine. If the active bonnet has been triggered, it is raised at the rear in the area around the hinge by approximately 60 mm.

For the drive to the workshop, reset the triggered active bonnet yourself. If the active bonnet has been triggered, pedestrian protection may be limited.

Resetting

WARNING

Certain components in the engine compartment could be very hot, e.g. the engine, the radiator and parts of the exhaust system. There is a risk of injury when accessing the engine compartment.

As far as possible, allow the engine to cool down and only touch the following components.

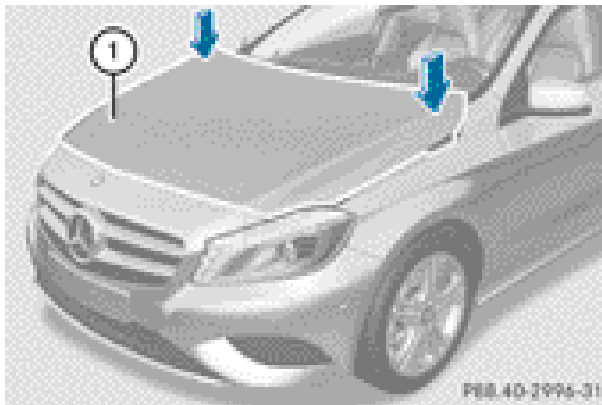

- ▶ With your hand flat, push down active bonnet ① in the area around the hinges on both sides (arrows) until you feel it engage.

If you can raise the active bonnet slightly in the area around the hinges, it is not engaged correctly. Repeat the step.

If the bonnet can then still be raised, drive directly to a qualified specialist workshop. Do not drive faster than 100 km/h.

Opening the bonnet

WARNING

When the bonnet is open, and the windscreen wipers are set in motion, you can be injured by the wiper linkage. There is a risk of injury. Always switch off the windscreen wipers and the ignition before opening the bonnet.

- ! Make sure that the windscreen wipers are not folded away from the windscreen. Otherwise, you could damage the windscreen wipers or the bonnet.



- ▶ Make sure that the windscreen wipers are switched off.
- ▶ Pull release lever ① on the bonnet. The bonnet is released.



- ▶ Reach into the gap between the bonnet and the radiator trim and press bonnet catch lever ② to the left.
- ▶ Raise the bonnet.

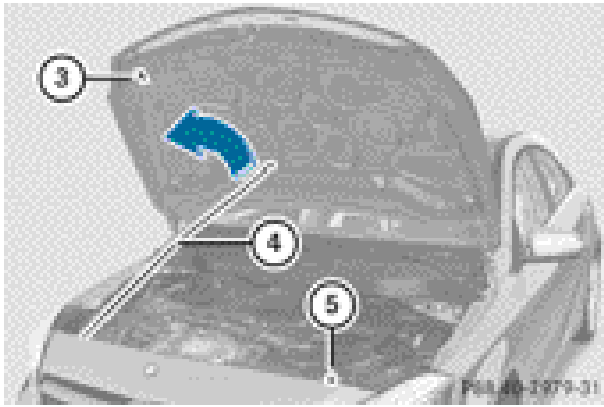

Maintenance and care

- ▶ Pull support strut (4) out of bracket (5).
- ▶ Lift up support strut (4) and insert it into yellow retaining clip (3).

Closing the bonnet

- ▶ Raise the bonnet slightly and, at the same time, remove support strut (4) from yellow retaining clip (3).
- ▶ Swing support strut (4) down and press it into bracket (5) until it engages.
- ▶ Lower the bonnet and let it fall from a height of approximately 20 cm.
- ▶ Check that the bonnet has engaged properly.

If the bonnet can be raised slightly, it is not properly engaged. Do not press the bonnet closed. Open the bonnet again and close it with a little more force.

Engine oil

General notes

Depending on your driving style, the vehicle consumes up to 0.8 l of oil per 1,000 km. The oil consumption may be higher than this when the vehicle is new or if you frequently drive at high engine speeds.

Depending on the engine, the oil dipstick may be installed at a different location.

When checking the oil level:

- park the vehicle on a level surface.
- the engine should be switched off for approximately five minutes if the engine is at normal operating temperature.
- if the engine is not at normal operating temperature, e.g. if the engine was only started briefly: wait about 30 minutes before carrying out the measurement.

Checking the oil level using the oil dipstick

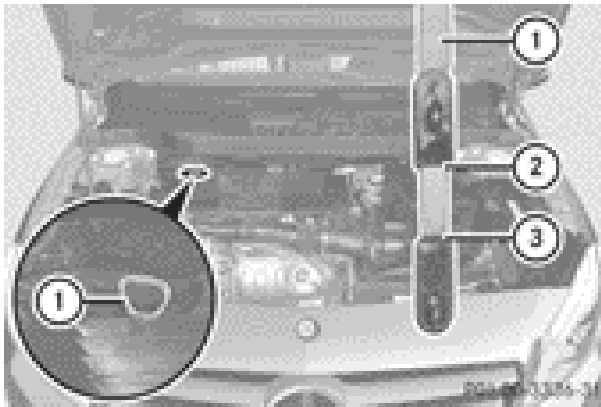

Example: vehicles with a petrol engine

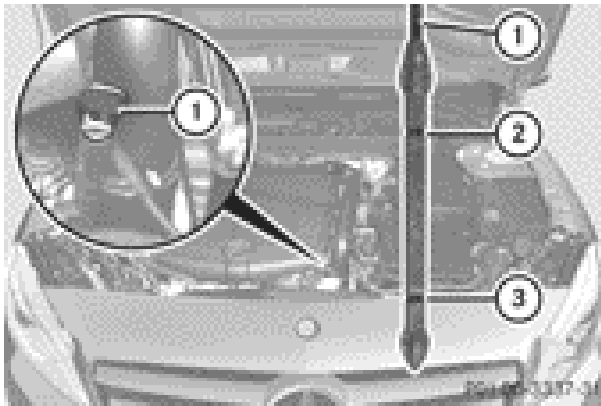

Vehicles with a diesel engine (apart from the A 180 CDI BlueEFFICIENCY model with manual transmission)

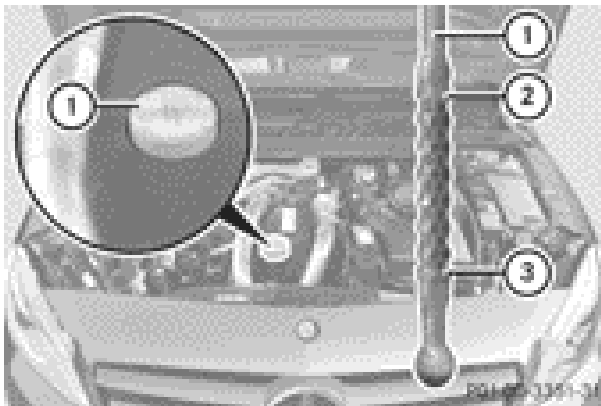

A 180 CDI BlueEFFICIENCY, manual transmission

- ▶ **All models apart from the A 180 CDI BlueEFFICIENCY model with manual transmission:** pull out oil dipstick ①.
- ▶ **A 180 CDI BlueEFFICIENCY model with manual transmission:** undo the oil filler cap and pull it out together with integrated oil dipstick ①.

- ▶ Wipe off oil dipstick ①.
- ▶ Slowly slide oil dipstick ① into the guide tube to the stop, and take it out again. If the level is between MIN mark ③ and MAX mark ②, the oil level is correct.
- ▶ If the oil level has dropped to MIN mark ③ or below, top up with 1.0 litre of engine oil.

Adding engine oil

⚠ WARNING

If engine oil comes into contact with hot components in the engine compartment, it may ignite. There is a risk of fire and injury.

Make sure that engine oil does not spill out over the filler neck. Allow the engine to cool down and thoroughly clean the components that have come into contact with engine oil before you start the engine.

♻ Environmental note

When topping up the oil, take care not to spill any. If oil enters the soil or waterways, it is harmful to the environment.

- ❗ Only use engine oils and oil filters that have been approved for vehicles with a service system. You can obtain a list of the engine oils and oil filters tested and approved in accordance with the Mercedes-Benz Specifications for Service Products at any Mercedes-Benz Service Centre.

Damage to the engine or exhaust system is caused by the following:

- using engine oils and oil filters that have not been specifically approved for the service system
- changing the engine oil and oil filter after missing the change interval required by the service system
- using engine oil additives

- ❗ Do not add too much oil. Topping up with too much engine oil can result in damage

to the engine or to the catalytic converter. Have excess engine oil siphoned off.

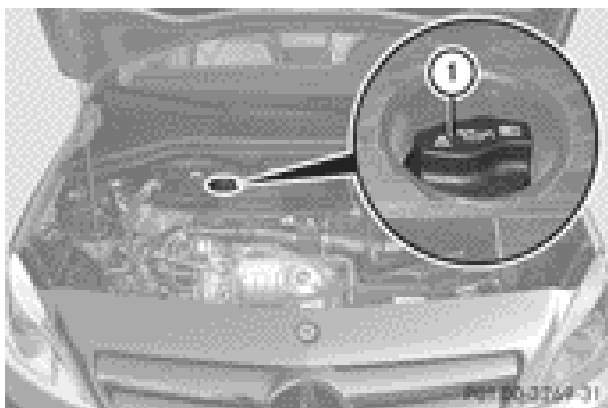

Example: engine oil filler cap

- ▶ Turn cap ① anti-clockwise and remove it.
- ▶ Top up the engine oil.
If the oil level is at or below the MIN mark on the oil dipstick, top up with 1.0 litre of engine oil.
- ▶ Replace cap ① on the filler neck and turn clockwise.
Make sure that the cap locks securely into place.
- ▶ Check the oil level again with the oil dipstick (▷ page 287).

For further information on engine oil, see (▷ page 343).

Checking and adding other service products

Checking the coolant level

WARNING

The engine cooling system is under pressure, particularly if the engine is warm. You could be scalded by hot coolant spraying out when opening the cap. There is a danger of injury. Allow the engine to cool before opening the cap. Wear gloves and protective eyewear when opening. Slowly turn the cap half a turn to allow pressure to escape.

- ❗ The coolant level must only be checked and corrected when the engine has cooled down (coolant temperature under 40 °C).

Checking the coolant level when the coolant temperature is over 40 °C can lead to damage to the engine or engine cooling system.

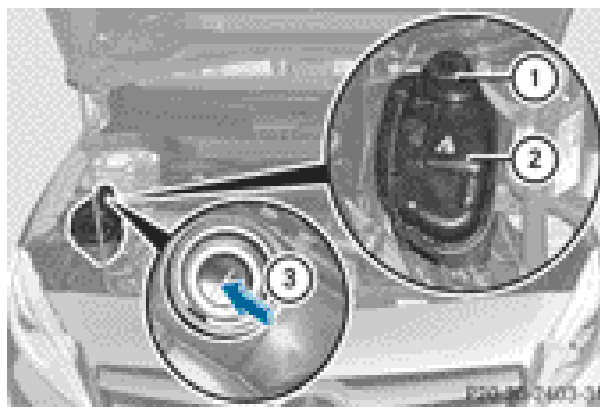

Example

- ▶ Park the vehicle on a level surface.
Only check the coolant level if the vehicle is on a level surface and the engine has cooled down.
- ▶ Turn the key to position **2** in the ignition lock (▷ page 143).
- ▶ Check the coolant temperature display in the instrument cluster.
The coolant temperature must be below 40 °C.
- ▶ Turn the key to position **0** (▷ page 143) in the ignition lock.
- ▶ Slowly turn cap ① half a turn anti-clockwise to allow excess pressure to escape.
- ▶ Turn cap ① further anti-clockwise and remove it.
If the coolant is at the level of marker bar ③ in the filler neck when cold, there is enough coolant in coolant expansion tank ②.
- ▶ If necessary, top up with coolant that has been tested and approved by Mercedes-Benz.
- ▶ Replace cap ① and turn it clockwise as far as it will go.

For further information on coolant, see (▷ page 344).

Topping up the windscreen washer system/headlamp cleaning system

WARNING

Windscreen washer concentrate is highly flammable. If it comes into contact with hot engine components or the exhaust system it could ignite. There is a risk of fire and injury. Make sure that no windscreen washer concentrate is spilled next to the filler neck.

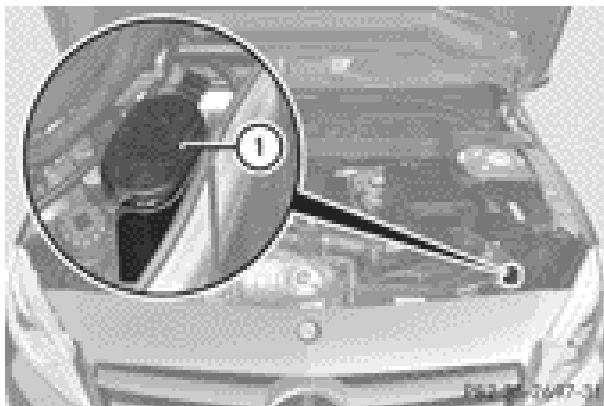

Example

- ▶ **To open:** pull cap ① upwards by the tab.
- ▶ Top up with the premixed washer fluid.
- ▶ **To close:** press cap ① onto the filler neck until it engages.

The washer fluid reservoir is used for both the windscreen washer system and the headlamp cleaning system.

The recommended minimum amount when topping up is 1 litre. If the water level drops below this, a message appears in the multifunction display prompting you to refill the washer fluid (▷ page 256).

Further information on windscreen washer fluid/antifreeze (▷ page 345).

Service

ASSYST PLUS

Service messages

The ASSYST PLUS service interval display informs you of the next service due date.

Information on the type of service and service intervals (see separate Service Booklet).

You can obtain further information from any Mercedes-Benz Service Centre.

- ▶ **i** The ASSYST PLUS service interval display does not show any information on the engine oil level. Observe the notes on the engine oil level (▷ page 286).

The multifunction display shows a service message for a few seconds, e.g.:

- Next service A in .. days
- Service A due
- Service A overdue by .. days

Depending on the operating conditions of the vehicle, the remaining time or distance until the next service due date is displayed.

The letter indicates which service is due. **A** stands for a minor service and **B** for a major service. A number or another letter may be displayed after the letter. This figure indicates any necessary additional maintenance work to be performed.

If you notify a qualified specialist workshop of this display, you will receive a statement on the associated costs.

The ASSYST PLUS service interval display does not take into account any periods of time during which the battery is disconnected.

Maintaining the time-dependent service schedule:

- ▶ Note down the service due date displayed in the multifunction display before disconnecting the battery.





or

- ▶ After reconnecting the battery, subtract the battery disconnection periods from the service date shown on the display.

Hiding a service message

- ▶ Press  or .

Displaying service messages

- ▶ Switch the ignition on.
- ▶ Using  or , select the **Service** menu.
- ▶ Press  or  to select the **ASSYST PLUS** submenu and press  to confirm. The service due date appears in the multi-function display.

Information about Service

Resetting the ASSYST PLUS service interval display

- ❗ If the ASSYST PLUS service interval display has been inadvertently reset, this setting can be corrected at a qualified specialist workshop.

Have service work carried out as described in the Service Booklet. This may otherwise lead to increased wear and damage to the major assemblies or the vehicle.

A qualified specialist workshop, e.g. a Mercedes-Benz Service Centre, will reset the ASSYST PLUS service interval display after the service work has been carried out. You can also obtain further information on maintenance work, for example.

Special service requirements

The prescribed service interval is based on normal operation of the vehicle. Service work will need to be performed more often if the vehicle is operated under arduous conditions or increased loads, for example:

- regular city driving with frequent intermediate stops
- if the vehicle is primarily used to travel short distances
- for frequent operation in mountainous terrain or on poor road surfaces
- if the engine is often left idling for long periods

In these or similar operating conditions, have the air filter, engine oil and oil filter, for example, changed more frequently. The tyres must

be checked more frequently if the vehicle is operated under increased loads. Further information can be obtained at a qualified specialist workshop, e.g. a Mercedes-Benz Service Centre.

Driving abroad

An extensive Mercedes-Benz Service network is also available in other countries. The Service Hotline's current telephone numbers for use when you are abroad are to be found in the "Mercedes-Benz Service24h" section of the Service Booklet.

Care

General notes

Environmental note

Dispose of empty packaging and cleaning cloths in an environmentally responsible manner.

- ❗ For cleaning your vehicle, do not use any of the following:

- dry, rough or hard cloths
- abrasive cleaning agents
- solvents
- cleaning agents containing solvents

Do not scrub.

Do not touch the surfaces or protective films with hard objects, e.g. a ring or ice scraper. You could otherwise scratch or damage the surfaces and protective film.

- ❗ Do not park up the vehicle for an extended period straight after cleaning it, particularly after having cleaned the wheels with wheel cleaner. Wheel cleaners could cause increased corrosion of the brake discs and brake pads/linings. For this reason, you should drive for a few minutes after cleaning. Braking heats the brake discs and the brake pads/linings, thus drying them. The vehicle can then be parked up.

Regular care of your vehicle is a condition for retaining the quality in the long term.

Use care products and cleaning agents recommended and approved by Mercedes-Benz.

Care of the exterior

Automatic car wash

WARNING

Braking efficiency is reduced after the vehicle has been washed. There is a risk of an accident.

After washing the vehicle, brake carefully while paying attention to the traffic conditions in order to restore full braking efficiency.

! If DISTRONIC PLUS or the HOLD function is activated, the vehicle brakes automatically in certain situations. To prevent damage to the vehicle, deactivate DISTRONIC PLUS and the HOLD function in the following or other similar situations:

- when towing the vehicle
- in the car wash

! Make sure that the automatic transmission is in position **N** when washing your vehicle in a tow-through car wash. The vehicle could be damaged if the transmission is in another position.

! Make sure that:

- the side windows and sliding sunroof are closed completely.
- the blower for the ventilation/heating is switched off (OFF button is depressed/ airflow control is turned to position **0**).
- the windscreen wiper switch is at position **0**.

The vehicle could otherwise be damaged.

You can wash the vehicle in an automatic car wash from the very start.

Wash off excess dirt before cleaning the vehicle in an automatic car wash.

After using an automatic car wash, wipe off wax from the windscreen and the wiper blades. This will prevent smears and reduce wiping noises caused by residue on the windscreen.

Washing by hand

In some countries, washing by hand is only allowed at wash bays that are specially designed for this purpose. Observe the legal requirements for each individual country.

- ▶ Do not use hot water and do not wash the vehicle in direct sunlight.
- ▶ Use a soft sponge to clean.
- ▶ Use a mild cleaning agent, such as a car shampoo approved by Mercedes-Benz.
- ▶ Thoroughly hose down the vehicle with a gentle jet of water.
- ▶ Do not point the water jet directly towards the air inlet.
- ▶ Use plenty of water and rinse out the sponge frequently.
- ▶ Rinse the vehicle with clean water and dry thoroughly with a chamois.
- ▶ Do not let the cleaning agent dry on the paintwork.

When using the vehicle in winter, remove all traces of road salt deposits carefully and as soon as possible.

High-pressure cleaning equipment

WARNING

The water jet of circular-jet nozzles (dirt grinders) can cause damage not visible from the outside to tyres or chassis components. Components damaged in this way can unexpectedly fail. There is a risk of an accident.

Do not use high-pressure cleaners with circular-jet nozzles to clean the vehicle. Have damaged tyres or chassis components replaced immediately.

! Always maintain a distance of at least 30 cm between the vehicle and the high-

pressure cleaner nozzle. Information about the correct distance is available from the equipment manufacturer.

Move the high-pressure cleaner nozzle around when cleaning your vehicle.

Do not aim directly at any of the following:

- tyres
- door gaps, roof gaps, joints etc.
- electrical components
- battery
- connectors
- lights
- seals
- trim elements
- ventilation slots

Damaged seals or electrical components can lead to leaks or failures.

Cleaning the wheels

! Do not use acidic wheel cleaning products to remove brake dust. This could damage wheel bolts and brake components.

! Do not park up the vehicle for an extended period straight after cleaning it, particularly after having cleaned the wheels with wheel cleaner. Wheel cleaners could cause increased corrosion of the brake discs and brake pads/linings. For this reason, you should drive for a few minutes after cleaning. Braking heats the brake discs and the brake pads/linings, thus drying them. The vehicle can then be parked up.

Cleaning the paintwork

! Do not affix:

- stickers
- films
- magnetic plates or similar items

to painted surfaces. You could otherwise damage the paintwork.

- ▶ Remove impurities immediately, where possible, whilst avoiding rubbing too hard.
- ▶ Soak insect remains with insect remover and rinse off the treated areas afterwards.
- ▶ Soak bird droppings with water and rinse off the treated areas afterwards.
- ▶ Remove coolant, brake fluid, tree resin, oils, fuels and greases by rubbing gently with a cloth soaked in petroleum ether or lighter fluid.
- ▶ Use tar remover to remove tar stains.
- ▶ Use silicone remover to remove wax.

The following cannot always be completely repaired:

- scratches
- corrosive deposits
- areas affected by corrosion
- damage caused by inadequate care

In such cases, visit a qualified specialist workshop.

Care and treatment of matt paintwork

! Never polish the vehicle or the light alloy wheels. Polishing makes the paintwork shiny.

! The following may cause the paint to become shiny and thus reduce the matt effect:

- Vigorous rubbing with unsuitable materials.
- Frequent use of car washes.
- Washing the vehicle in direct sunlight.

! Never use paint cleaner, buffing or polishing products, or gloss preserver, e.g. wax. These products are only suitable for high-gloss surfaces. Their use on vehicles with matt finish leads to considerable surface damage (shiny, spotted areas).

Always have paintwork repairs carried out at a qualified specialist workshop.

! Do not use wash programs with a hot wax treatment under any circumstances.

Observe these notes if your vehicle has a clear matt finish. This will help you to avoid damage to the paintwork due to incorrect treatment.

These notes also apply to light-alloy wheels with a clear matt finish.

- i** The vehicle should preferably be washed by hand using a soft sponge, car shampoo and plenty of water.
- i** Use only insect remover and car shampoo from the range of recommended and approved Mercedes-Benz care products.

Cleaning the windows

WARNING

If the windscreen wipers are set in motion when cleaning the windscreen or wiper blades, you could become trapped. There is a danger of injury.

Always switch off the windscreen wipers and the ignition before cleaning the windscreen or wiper blades.

- !** Only fold the windscreen wipers away from the windscreen when vertical. Otherwise, you will damage the bonnet.
- !** Do not use dry cloths, abrasive products, solvents or cleaning agents containing solvents to clean the inside of the windows. Do not touch the insides of the windows with hard objects, e.g. an ice scraper or ring. There is otherwise a risk of damaging the windows.
- !** Clean the water drainage channels of the windscreen and the rear window at regular intervals. Deposits such as leaves, petals and pollen may under certain circumstances prevent water from draining away. This can lead to corrosion damage and damage to electronic components.
- Clean the inside and outside of the windows with a damp cloth and a cleaning agent that is recommended and approved by Mercedes-Benz.

Cleaning the wiper blades

WARNING

If the windscreen wipers are set in motion when cleaning the windscreen or wiper blades, you could become trapped. There is a danger of injury.

Always switch off the windscreen wipers and the ignition before cleaning the windscreen or wiper blades.

- !** Only fold the windscreen wipers away from the windscreen when vertical. Otherwise, you will damage the bonnet.
- !** Do not pull on the wiper blade. Otherwise, the wiper blade could be damaged.
- !** Do not clean wiper blades too often and do not rub them too hard. Otherwise, the graphite coating could be damaged. This could cause wiper noise.
- Fold the wiper arms away from the windscreen.
- Clean the wiper blades carefully using a damp cloth.
- Fold the windscreen wipers back again before switching on the ignition.
- !** Hold the wiper arm securely when folding back. The windscreen could be damaged if the wiper arm hits against it suddenly.

Cleaning the exterior lighting

- !** Only use cleaning agents or cleaning cloths that are suitable for plastic lenses. Unsuitable cleaning agents or cleaning cloths could scratch or damage the plastic lenses of the exterior lighting.
- Clean the plastic lenses of the exterior lighting using a wet sponge and a mild cleaning agent, e.g. Mercedes-Benz car shampoo or cleaning cloths.

Cleaning the mirror turn signal

- ❗ Only use cleaning agents or cleaning cloths that are suitable for plastic lenses. Unsuitable cleaning agents or cleaning cloths could scratch or damage the plastic lenses of the mirror turn signals.
- ▶ Clean the plastic lenses of the mirror turn signals in the exterior mirror housing using a wet sponge and a mild cleaning agent, e.g. Mercedes-Benz car shampoo or cleaning cloths.

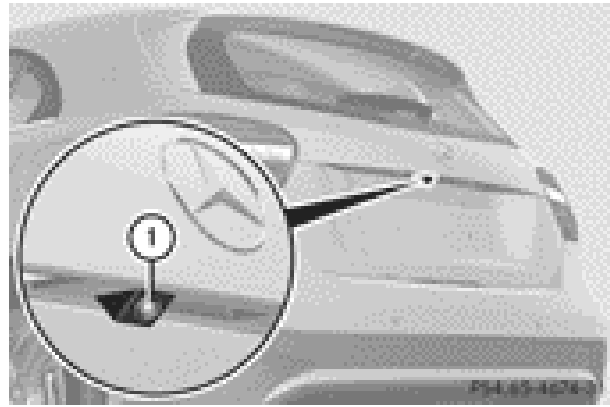

- ▶ Use clear water and a soft cloth to clean camera lens ①.

Cleaning the sensors

- ❗ If you clean the sensors with a high-pressure cleaner, make sure that you keep a distance of at least 30 cm between the vehicle and the high-pressure cleaner nozzle. Information about the correct distance is available from the equipment manufacturer.

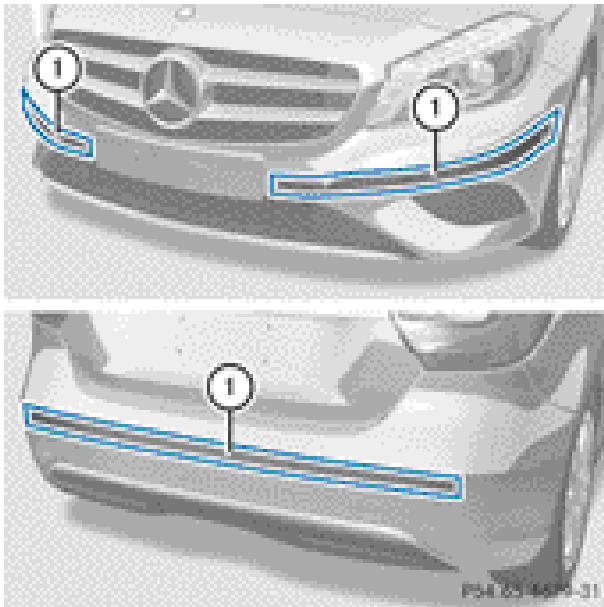

- ▶ Clean sensors ① of the driving systems with water, car shampoo and a soft cloth.

Cleaning the reversing camera

- ❗ Do not clean the camera lens and the area around the reversing camera with a high-pressure cleaner.

Cleaning the exhaust tail pipes

Impurities combined with the effects of road grit and corrosive environmental factors may cause flash rust to form on the surface. You can restore the original shine of the exhaust pipe by cleaning it regularly, especially in winter and after washing.

- ❗ Do not clean the exhaust pipe with acid-based cleaning agents such as sanitary cleansers or wheel cleaners.
- ▶ Clean the exhaust pipe with a care product tested and approved by Mercedes-Benz.
- ❗ AMG vehicles with black exhaust pipes: do not use chrome polish to polish black chromed screens. They will otherwise lose their silky black shine. Rub the screen using a lightly oiled cloth after every car wash. Commercially available engine oils, WD 40 or Ballistol are suitable oils.

Cleaning the trailer tow hitch

🌿 Environmental note

Dispose of oily and greasy cloths in an environmentally-responsible manner.

- ❗ Do not clean the ball coupling with a high-pressure cleaner. Do not use solvents.
- ❗ Observe the note on care provided by the trailer manufacturer.

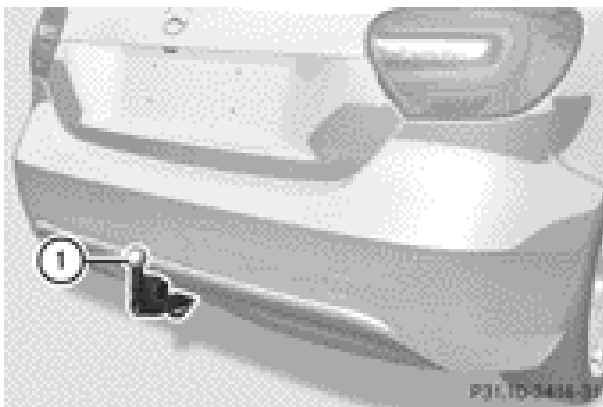

- ▶ Remove rust, e.g. with a wire brush.
- ▶ Remove dirt with a clean, lint-free cloth or a brush.
- ▶ After cleaning, lightly oil or grease ball coupling ①.
- ▶ Check that the vehicle's trailer tow hitch is working properly.

i Maintenance of the ball coupling and trailer tow hitch can also be performed at a qualified specialist workshop, e.g. a Mercedes-Benz Service Centre.

Interior care

Cleaning the display

! For cleaning, do not use any of the following:

- alcohol-based thinner or petrol
- abrasive cleaning agents
- commercially-available household cleaning agents

These may damage the display surface. Do not put pressure on the display surface when cleaning. This could lead to irreparable damage to the display.

- ▶ Before cleaning the display, make sure that it is switched off and has cooled down.
- ▶ Clean the display surface using a commercially available microfibre cloth and TFT/LCD display cleaner.
- ▶ Dry the display surface using a dry microfibre cloth.

Cleaning the plastic trim

! WARNING

Care products and cleaning agents containing solvents can cause surfaces in the cockpit to become porous. This could result in plastic parts breaking away when the airbags are deployed. There is a danger of injury.

Do not use care products and cleaning agents containing solvents to clean the cockpit.

! Do not affix the following to plastic surfaces:

- stickers
- films
- scented oil bottles or similar items

You could otherwise damage the plastic.

! Do not allow cosmetics, insect repellent or sunscreen to come in contact with the plastic trim. This maintains the high-quality look of the surfaces.

- ▶ Wipe the plastic trim with a damp, lint-free cloth, e.g. a microfibre cloth.
- ▶ **Heavy soiling:** use car care and cleaning products recommended and approved by Mercedes-Benz.

The surface may change colour temporarily. Wait until the surface is dry again.

Cleaning the steering wheel and gear or selector lever

- ▶ Thoroughly wipe with a damp cloth or use leather care agents that have been recommended and approved by Mercedes-Benz.

Cleaning wooden trim and trim elements

! Do not use solvent-based cleaning agents such as tar remover, wheel cleaners, polishes or waxes. There is otherwise a risk of damaging the surface.

- ▶ Wipe the wooden trim and trim elements with a damp, lint-free cloth, e.g. a microfibre cloth.
- ▶ **Heavy soiling:** use car care and cleaning products recommended and approved by Mercedes-Benz.

Cleaning the seat covers

General notes

- ❗ Do not use microfibre cloths to clean genuine leather, artificial leather or Alcantara® covers. If used often, these can damage the cover.
- ℹ Note that regular care is essential to make sure that the appearance and comfort of the covers are retained over time.

Genuine leather seat covers

Leather is a natural product.

It exhibits natural surface characteristics, for example:

- Differences in the texture
- Signs of stretching and marking
- Slight nuances of colour

These are characteristics of leather and not material defects.

- ❗ To retain the natural appearance of the leather, observe the following cleaning instructions:
 - Clean genuine leather covers carefully with a damp cloth and then wipe the covers down with a dry cloth.
 - Make sure that the leather does not become soaked. It may otherwise become rough and cracked.
 - Only use leather care agents that have been tested and approved by Mercedes-Benz. You can obtain these from a qualified specialist workshop.

Seat covers of other materials

- ❗ Observe the following when cleaning:
 - Clean artificial leather covers with a cloth moistened with a solution containing 1% detergent (e.g. washing-up liquid).
 - Clean cloth covers with a microfibre cloth moistened with a solution containing 1% detergent (e.g. washing-up liquid). Rub carefully, and always wipe entire seat sections to avoid leaving visible lines. Leave the seat to dry afterwards. Cleaning results depend on the type of dirt and how long it has been there.
 - Clean Alcantara® covers with a damp cloth. Make sure that you wipe entire seat sections to avoid leaving visible lines.

Cleaning the seat belts

⚠ WARNING

Seat belts may be severely weakened if bleached or coloured. This may lead to the seat belts, for example, tearing or failing in an accident. There is an increased risk of injury, possibly even fatal.

Never bleach or colour seat belts.

- ❗ Do not clean the seat belts using chemical cleaning agents. Do not dry the seat belts at temperatures above 80 °C or in direct sunlight.
- ▶ Use clean, lukewarm water and soap solution.

Cleaning the roof lining and carpets

- ▶ **Roof lining:** if it is very dirty, use a soft brush or a cleaning agent recommended and approved by Mercedes-Benz.
- ▶ **Carpets:** use the carpet and textile cleaning agents recommended and approved by Mercedes-Benz.

Useful information	298
Where will I find...?	298
Flat tyre	300
Battery (vehicle)	304
Jump-starting	308
Towing and tow-starting	310
Electrical fuses	314

Useful information

- i** This Owner's Manual describes all models, series and optional equipment for your vehicle that were available at the time of going to press. National variations are possible. Note that your vehicle may not be equipped with all of the functions described. This is also the case for systems and functions relevant to safety.
- i** Read the information on qualified specialist workshops: (▷ page 24).

Where will I find...?

Warning triangle

Removing/replacing the warning triangle

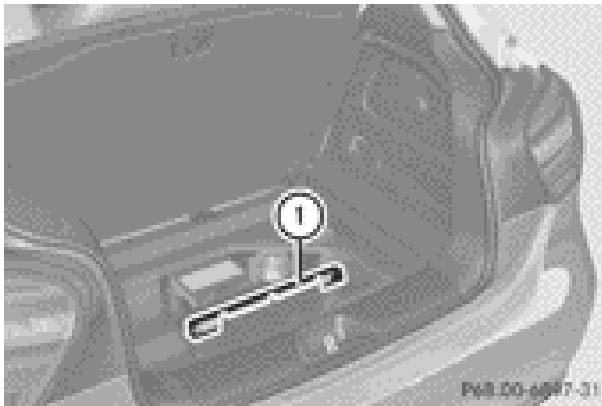

- ▶ **To remove:** open the tailgate.
- ▶ Swing the luggage compartment floor upwards (▷ page 274).
- ▶ To loosen warning triangle (1), push back the retainers on the bracket.
- ▶ Remove warning triangle (1) from the bracket.
- ▶ **To replace:** place warning triangle (1) back into the bracket and push down to secure.

Setting up the warning triangle

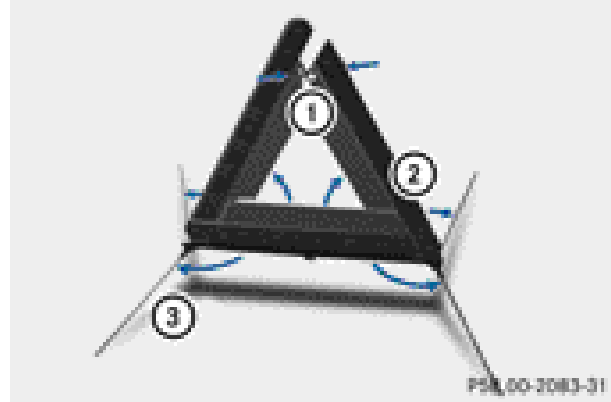

- ▶ Fold feet (3) down and out to the side.
- ▶ Fold side reflectors (2) upwards to form a triangle and lock them at the top using press stud (1).

First-aid kit

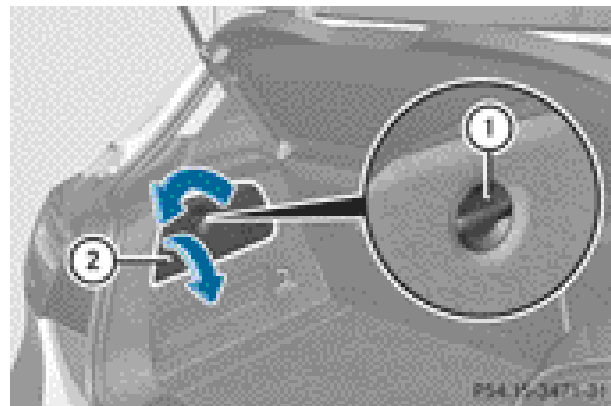

- ▶ Open the tailgate.
- ▶ **To open the stowage compartment:** turn rotary knob (1) anti-clockwise and fold down cover (2).

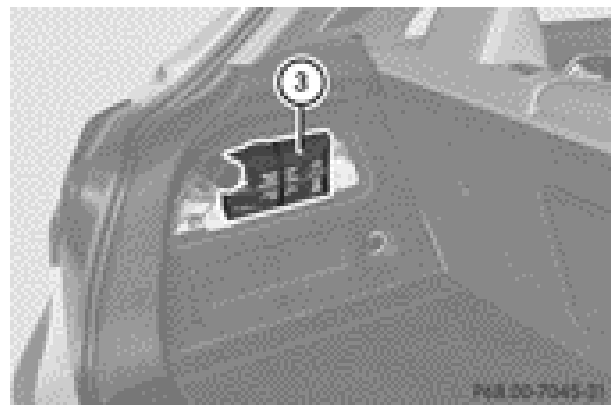

► Remove first-aid kit ③.

i Check the expiry date on first-aid kit ③ at least once a year. Replace the contents if necessary, and replace any missing items.

Fire extinguisher

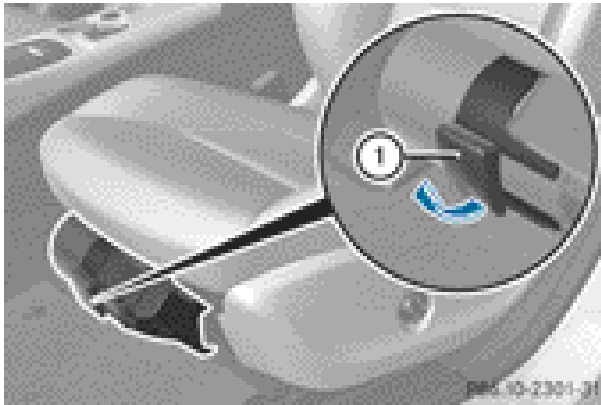

The fire extinguisher is located underneath the front of the driver's seat.

► Pull tab ① upwards.
► Remove the fire extinguisher.

i Have the fire extinguisher refilled after each use and checked every one or two years. It may otherwise fail in an emergency.

Observe the legal requirements for each individual country.

Vehicle tool kit

General notes

Vehicles with a TIREFIT kit: the TIREFIT kit is located in the stowage well under the boot floor.

Vehicles with a tyre-change tool kit: the tyre-change tool kit is in the stowage well under the luggage compartment floor.

For vehicles with an emergency spare wheel, see "Removing the emergency spare wheel" (► page 332).

i Apart from some country-specific variants, vehicles are not equipped with tyre-changing tools. Some tools for changing a wheel are specific to the vehicle. For more information on which tools are required and approved to perform a wheel change on your vehicle, consult a qualified specialist workshop.

Necessary tyre-changing tools can include, for example:

- Jack
- Wheel chock
- Wheel wrench

Vehicles with a TIREFIT kit

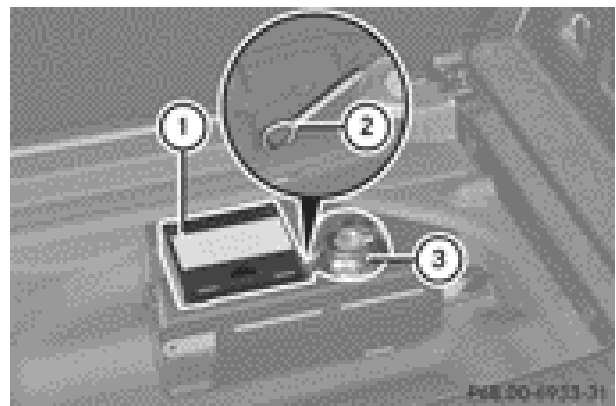

- ① Tyre inflation compressor
- ② Towing eye
- ③ Tyre sealant filler bottle

► Open the tailgate.
► Swing the luggage compartment floor upwards (► page 274).

i Towing eye ② is located under tyre inflation compressor ①.

Vehicles with a tyre-change tool kit

► Open the tailgate.
► Swing the luggage compartment floor upwards (► page 274).
► Remove the tyre-change tool kit.

The tyre-change tool kit contains:

- Jack
- Wheel wrench

- One pair of gloves
- Foldable wheel chock

Flat tyre

Preparing the vehicle

Your vehicle may be equipped with:

- MOExtended tyres (tyres with run-flat characteristics) (▷ page 300)
Vehicle preparation is not necessary on vehicles with MOExtended tyres.
- a TIREFIT kit (▷ page 299)
- an emergency spare wheel (only for certain countries)

Information on changing/fitting a wheel (▷ page 325).

- ▶ Stop the vehicle as far away as possible from traffic on solid, non-slippery and level ground.
- ▶ Switch on the hazard warning lamps.
- ▶ Secure the vehicle against rolling away (▷ page 162).
- ▶ If possible, bring the front wheels into the straight-ahead position.
- ▶ Switch off the engine.
- ▶ Remove the key from the ignition lock.
- ▶ All occupants must get out of the vehicle. Make sure that they are not endangered as they do so.
- ▶ Make sure that no one is near the danger area while a wheel is being changed. Anyone who is not directly assisting in the wheel change should, for example, stand behind the barrier.
- ▶ Get out of the vehicle. Pay attention to traffic conditions when doing so.
- ▶ Close the driver's door.
- ▶ Place the warning triangle a suitable distance away (▷ page 298). Observe legal requirements.

i Vehicles with MOExtended tyres are not equipped with a TIREFIT kit at the factory. It is therefore recommended that you addi-

tionally equip your vehicle with a TIREFIT kit if you fit tyres that do not feature run-flat characteristics, e.g. winter tyres. A TIREFIT kit can be obtained from a qualified specialist workshop.

MOExtended tyres (tyres with run-flat characteristics)

General notes

With MOExtended tyres (tyres with run-flat characteristics), you can continue to drive your vehicle even if there is a total loss of pressure in one or more tyres. The affected tyre must not show any clearly visible damage.

You can recognise MOExtended tyres by the MOExtended marking which appears on the tyre wall. You will find this marking next to the tyre size designation, the load-bearing capacity and the speed index.

MOExtended tyres may only be used in conjunction with an active tyre pressure loss warning system.

If the pressure loss warning message appears in the multifunction display:

- Observe the instructions in the display messages (▷ page 251).
- Check the tyre for damage.
- If driving on, observe the following notes.

The maximum driving distance is approximately 80 km when the vehicle is partially laden and approximately 30 km when the vehicle is fully laden.

In addition to the vehicle load, the driving distance possible depends upon:

- speed
- road condition
- outside temperature

The driving distance possible in run-flat mode may be reduced by extreme driving conditions/manoeuvres, or it can be increased through a moderate style of driving.

The maximum permissible distance which can be driven in run-flat mode is counted from the moment the tyre pressure loss warning appears in the multifunction display.

You must not exceed a maximum speed of 80 km/h.

i When replacing one or all tyres, make sure that you use only:

- the tyre size specified for the vehicle and
- tyre(s) marked "MOExtended"

If a tyre has gone flat and cannot be replaced with an MOExtended tyre, a standard tyre may be used as a temporary measure. Make sure that you use the proper size and type (summer or winter tyre).

i Vehicles with MOExtended tyres are not equipped with a TIREFIT kit at the factory. It is therefore recommended that you additionally equip your vehicle with a TIREFIT kit if you fit tyres that do not feature run-flat characteristics, e.g. winter tyres. A TIREFIT kit can be obtained from a qualified specialist workshop.

Important safety notes

WARNING

When driving in emergency mode, the driving characteristics deteriorate, e.g. when cornering, accelerating quickly and when braking. There is a risk of accident.

Do not exceed the stated maximum speed. Avoid abrupt steering and driving manoeuvres, and driving over obstacles (kerbs, potholes, off-road). This applies in particular to a laden vehicle.

Stop driving in emergency mode if:

- you hear banging noises.
- the vehicle starts to shake.
- you see smoke and smell rubber.
- ESP® is intervening constantly.
- there are tears in the sidewalls of the tyre.

After driving in emergency mode, have the wheel rims checked at a qualified specialist workshop with regard to their further use. The faulty tyre must be replaced.

TIREFIT kit

Important safety notes

WARNING

In the following situations, the tyre sealant is unable to provide sufficient breakdown assistance, as it is unable to seal the tyre properly:

- there are cuts or punctures in the tyre larger than those mentioned above.
- the wheel rim is damaged.
- you have driven at very low tyre pressures or on a flat tyre.

There is a risk of accident.

Do not drive any further. Contact a qualified specialist workshop.

WARNING

The tyre sealant is harmful and causes irritation. It must not come into contact with your skin, eyes or clothing or be swallowed. Do not inhale TIREFIT fumes. Keep tyre sealant away from children. There is a risk of injury.

If you come into contact with the tyre sealant, observe the following:

- Rinse off the tyre sealant from your skin immediately with water.
- If the tyre sealant comes into contact with your eyes, immediately rinse them thoroughly with clean water.
- If tyre sealant is swallowed, immediately rinse your mouth out thoroughly and drink plenty of water. Do not induce vomiting, and seek medical attention immediately.
- Immediately change out of clothing which has come into contact with tyre sealant.
- If an allergic reaction occurs, seek medical attention immediately.

Using the TIREFIT kit

TIREFIT is a tyre sealant.

You can use TIREFIT to seal punctures of up to 4 mm, particularly those in the tyre tread. You can use TIREFIT at outside temperatures down to -20 °C.

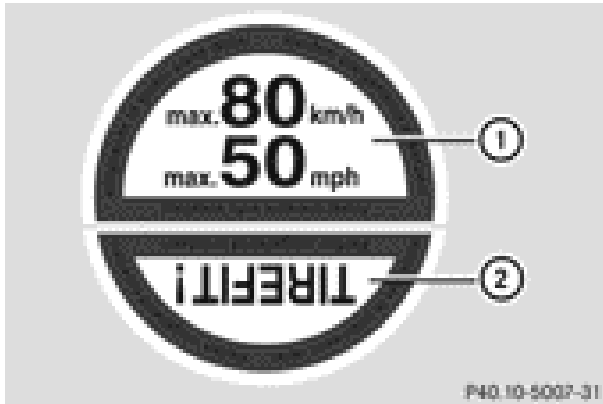

TIREFIT sticker, 2-part

- ▶ Do not remove any foreign objects which have penetrated the tyre, e.g. screws or nails.
- ▶ Remove the tyre sealant bottle, the accompanying TIREFIT sticker and the tyre inflation compressor from the stowage well underneath the luggage compartment floor (▷ page 299).
- ▶ Affix part ① of the TIREFIT sticker within the driver's field of vision.
- ▶ Affix part ② of the TIREFIT sticker near the valve on the wheel with the defective tyre.

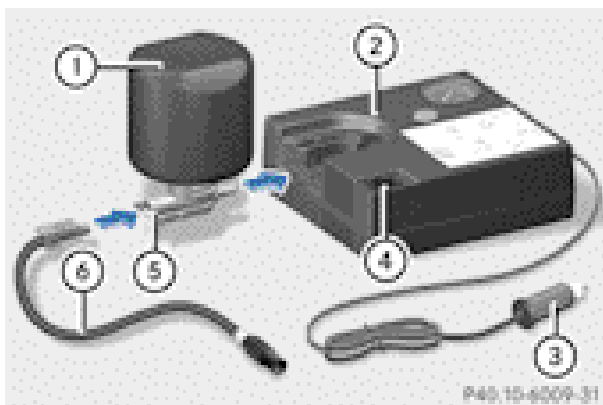

- ▶ Remove filler hose ⑥ and plug ③ from the bottom section of the tyre inflation compressor housing.
- ▶ Slide the yellow filler hose connector into the mounting on yellow cap ⑤ of tyre sealant bottle ① until the plug engages.
- ▶ With the sealing rings in front, slide yellow cap ⑤ of tyre sealant bottle ① into the mounting of tyre inflation compressor ② until the cap and both hooks engage.

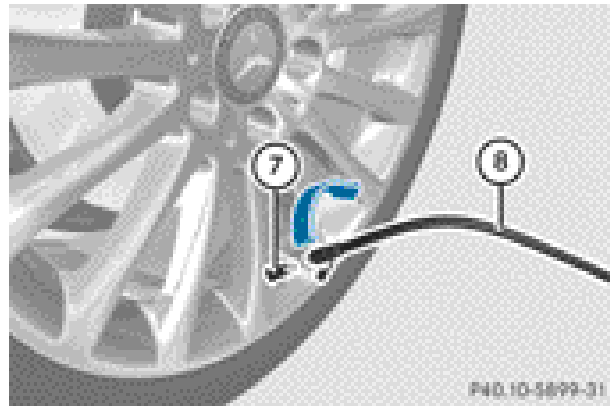

- ▶ Remove the cap from valve ⑦ on the faulty tyre.
- ▶ Screw filler hose ⑧ onto valve.
- ▶ Insert plug ③ into the socket of the cigarette lighter (▷ page 278) or into a 12 V power socket in your vehicle (▷ page 278).
- ▶ Turn the key to position 1 in the ignition lock (▷ page 143).
- ▶ Press on/off switch ④ on the tyre inflation compressor to **ON**.

The tyre inflation compressor is switched on. The tyre is inflated.

- ▶ **i** First, tyre sealant is pumped into the tyre. The pressure can briefly rise to approximately 500 kPa (5 bar/73 psi).

Do not switch off the tyre inflation compressor during this phase.

- ▶ Let the tyre inflation compressor run for a maximum of ten minutes. The tyre should then have attained a pressure of at least 200 kPa (2.0 bar/29 psi).

- ▶ **!** Do not operate the tyre inflation compressor for longer than ten minutes at a

time without a break. It may otherwise overheat.

The tyre inflation compressor can be operated again once it has cooled down.

If a pressure of 200 kPa (2.0 bar/29 psi) has been achieved after ten minutes, see (▷ page 303).

If a pressure of 200 kPa (2.0 bar/29 psi) has not been achieved after ten minutes, see (▷ page 303).

- i** If the tyre sealant leaks out, allow it to dry. It can then be removed like a layer of film. If you get tyre sealant on your clothing, have it cleaned as soon as possible with perchloroethylene.

Tyre pressure not reached

If a pressure of 200 kPa (2.0 bar/29 psi) has not been achieved after ten minutes:

- ▶ Switch off the tyre inflation compressor.
- ▶ Unscrew the filler hose from the valve of the faulty tyre.
- ▶ Very slowly drive forwards or reverse approximately 10 m.
- ▶ Pump up the tyre again.

After a maximum of ten minutes, the tyre pressure must be at least 200 kPa (2.0 bar/29 psi).

WARNING

If the required tyre pressure is not reached after the specified time, the tyre is too badly damaged. The tyre sealant cannot repair the tyre in this instance. Damaged tyres and a tyre pressure that is too low can significantly impair the vehicle's braking and driving characteristics. There is a risk of accident.

Do not continue driving. Contact a qualified specialist workshop.

Tyre pressure reached

WARNING

A tyre temporarily sealed with tyre sealant impairs the driving characteristics and is not suitable for higher speeds. There is a risk of accident.

You should therefore adapt your driving style accordingly and drive carefully. Do not exceed the specified maximum speed with a tyre that has been repaired using tyre sealant.

- !** After use, excess tyre sealant may run out of the filler hose. This could cause stains. Therefore, place the filler hose in the plastic bag that contained the TIREFIT kit.

Environmental note

Have the used tyre sealant bottle disposed of professionally, e.g. at a qualified specialist workshop.

If a tyre pressure of 200 kPa (2.0 bar/29 psi) has been achieved after ten minutes:

- ▶ Switch off the tyre inflation compressor.
- ▶ Unscrew the filler hose from the valve of the faulty tyre.
- ▶ Stow the tyre sealant bottle, the tyre inflation compressor and the warning triangle.
- ▶ **Pull away immediately.**

The maximum speed for a tyre sealed with tyre sealant is 80 km/h. The upper part of the TIREFIT sticker must be affixed to the instrument cluster where it will be easily seen by the driver.

- ▶ Stop after driving for approximately ten minutes and check the tyre pressure with the tyre inflation compressor. The tyre pressure must now be at least 130 kPa (1.3 bar/19 psi).

WARNING

If the required tyre pressure is not reached after driving for a short period, the tyre is too badly damaged. The tyre sealant cannot repair the tyre in this instance. Damaged tyres

and a tyre pressure that is too low can significantly impair the vehicle's braking and driving characteristics. There is a risk of accident. Do not continue driving. Contact a qualified specialist workshop.

i In your vehicle, you will find a sticker with the Mercedes-Benz Service24h telephone number, e.g. on the B-pillar on the driver's side.

- ▶ Correct the tyre pressure if it is still at least 130 kPa (1.3 bar/ 19 psi) (see the fuel filler flap for values).
- ▶ **To increase the tyre pressure:** switch on the tyre inflation compressor.

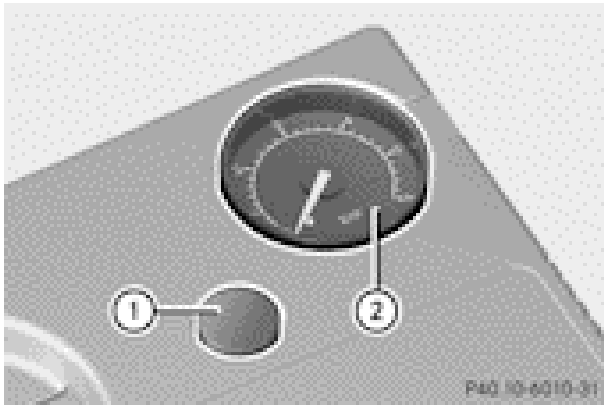

- ▶ **To reduce the tyre pressure:** depress pressure release button ① next to pressure gauge ②.

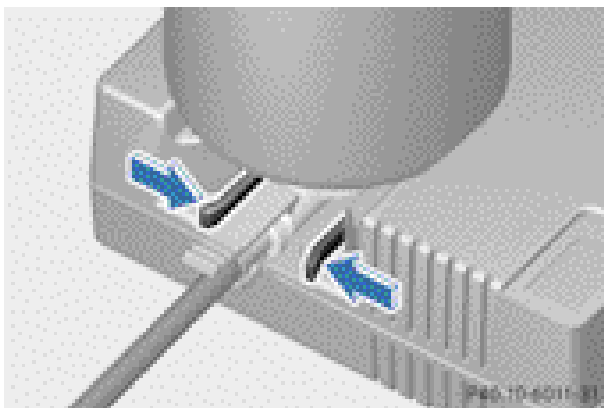

- ▶ To remove the tyre sealant bottle from the tyre inflation compressor, press together the locking tabs on the yellow cap.
- ▶ Pull the tyre sealant bottle out of the tyre inflation compressor.

The filler hose stays on the tyre sealant bottle.

- ▶ Stow the tyre sealant bottle, the tyre inflation compressor and the warning triangle.
- ▶ Drive to the nearest qualified specialist workshop and have the tyre changed there.
- ▶ Have the tyre sealant bottle and the filler hose replaced as soon as possible at a qualified specialist workshop.
- ▶ Have the tyre sealant bottle replaced every four years at a qualified specialist workshop.

Battery (vehicle)

Important safety notes

Work on the battery, e.g. removing or installing, requires specialist knowledge and the use of special tools. Therefore, always have work on the battery carried out at a qualified specialist workshop.

⚠ WARNING

Work carried out incorrectly on the battery can, for example, lead to a short circuit and damage your vehicle's electronic system. This can disrupt driving safety systems such as ABS (anti-lock braking system) or ESP® (Electronic Stability Program).

- If ABS malfunctions, the wheels can lock during braking. This limits the steerability of the vehicle when braking and the braking distance may increase. There is a risk of accident.
- If ESP® malfunctions, the vehicle will not be stabilised if it starts to skid or a wheel starts to spin. There is a risk of accident.

You should therefore have all work involving the battery carried out at a qualified specialist workshop.

⚠ WARNING

Electrostatic build-up can lead to the creation of sparks, which could ignite the highly explo-

sive gases of a battery. There is a risk of an explosion.

Before handling the battery, touch the vehicle body to remove any existing electrostatic build-up.

The highly flammable gas mixture is formed when charging the battery or jump-starting the vehicle.

Always make sure that neither you nor the battery is electrostatically charged. Electrostatic charge is caused, for example, by:

- wearing synthetic clothing
- the friction of clothing on the seat
- pulling or sliding the battery over carpets or other synthetic materials
- rubbing the battery with a cloth

WARNING

During the charging process, a battery produces hydrogen gas. If a short circuit occurs or sparks are created, the hydrogen gas can ignite. There is a risk of an explosion.

- Make sure that the positive terminal of a connected battery does not come into contact with vehicle parts.
- Never place metal objects or tools on a battery.
- It is important that you observe the described order of the battery terminals when connecting and disconnecting a battery.
- When jump-starting, make sure that the battery poles with identical polarity are connected.
- It is particularly important to observe the described order when connecting and disconnecting the jump leads.
- Never connect or disconnect the battery terminals while the engine is running.

WARNING

Battery acid is caustic. There is a risk of injury. Avoid contact with the skin, eyes or clothing. Do not inhale any battery gases. Do not lean over the battery. Keep children away from

batteries. Wash battery acid immediately with water and seek medical attention.

Environmental note



Batteries contain pollutants. It is illegal to dispose of them with the household rubbish. They must be collected separately and disposed of in an environmentally responsible recycling system.



Dispose of batteries in an environmentally responsible manner. Take discharged batteries to a qualified specialist workshop or to a collection point for used batteries.

- !** Have the battery checked regularly at a qualified specialist workshop.

Observe the service intervals in the Service Booklet or contact a qualified specialist workshop for more information.

- !** Always have work on the battery carried out at a qualified specialist workshop. Should it, in exceptional circumstances, be absolutely necessary to disconnect the battery yourself, please observe the following:
 - switch off the engine and remove the key. Check that all the indicator lamps in the instrument cluster are off. Otherwise, you may damage electronic components such as the alternator, for example.
 - first, disconnect the negative terminal clamp, followed by the positive terminal clamp. Never swap the terminal clamps. The vehicle electronics may otherwise be damaged.
 - on vehicles with automatic transmission, the transmission is locked in position **P** after disconnecting the battery. The vehicle is secured against rolling away. You can then no longer move the vehicle.

The battery and the cover of the positive terminal clamp must be fitted securely during operation.

Comply with safety precautions and take protective measures when handling batteries.

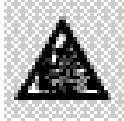

WARNING



Fire, naked flames and smoking are prohibited when handling the battery. Avoid creating sparks.



Battery acid is caustic. Avoid contact with the skin, eyes or clothing.

Wear suitable protective clothing, in particular gloves, an apron and a face mask.

Immediately rinse acid splashes off with clean water. Consult a doctor if necessary.



Wear eye protection.



Keep children away.

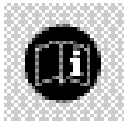

Observe this Owner's Manual.

For safety reasons, Mercedes-Benz recommends that you only use batteries which have been tested and approved for your vehicle by Mercedes-Benz. These batteries provide increased impact protection to prevent vehicle occupants from suffering acid burns should the battery be damaged in the event of an accident.

In order for the battery to achieve the maximum possible service life, it must always be sufficiently charged.

Like other batteries, the vehicle battery may discharge over time if you do not use the vehicle. In such cases, have the battery disconnected at a qualified specialist workshop.

You can also charge the battery with a charger recommended by Mercedes-Benz. For more information, please contact a qualified specialist workshop.

Have the battery charge checked more frequently if you use the vehicle mainly for short trips or if you leave it standing idle for a lengthy period. Consult a qualified specialist workshop if you wish to leave your vehicle parked up for a long period of time.

i When you park the vehicle, remove the key if you do not require any electrical consumers. The vehicle will then use very little energy, thus conserving battery power.

i If the power supply has been interrupted, e.g. if the battery was discharged, you will have to:

- set the clock (audio system/COMAND Online, see the separate operating instructions).
- reset the function for folding the exterior mirrors in/out automatically, by folding the mirrors out once (▷ page 99).

Charging the battery

WARNING

During charging and jump-starting, explosive gases can escape from the battery. There is a risk of an explosion.

Particularly avoid fire, naked flames, creating sparks and smoking. Ensure there is sufficient ventilation while charging and jump-starting. Do not lean over a battery.

WARNING

Battery acid is caustic. There is a risk of injury. Avoid contact with the skin, eyes or clothing. Do not inhale any battery gases. Do not lean over the battery. Keep children away from batteries. Wash battery acid immediately with water and seek medical attention.

 **WARNING**

A discharged battery can freeze at temperatures below freezing point. When jump-starting the vehicle or charging the battery, gases can escape from the battery. There is a risk of an explosion.

Allow the frozen battery to thaw out before charging it or jump-starting.

! Only use battery chargers with a maximum charging voltage of 14.8 V.

! Only charge the battery using the jump-start connection point.

The jump-starting connection point is in the engine compartment (▷ page 308).

- ▶ Open the bonnet (▷ page 285).
- ▶ Connect the battery charger to the positive terminal and earth point in the same order as when connecting the donor battery in the jump-starting procedure (▷ page 308).

If the indicator/warning lamps do not light up at low temperatures, it is very likely that the discharged battery has frozen. In this case you may neither jump-start the vehicle nor charge the battery. The service life of a battery that has been thawed could be reduced. The starting characteristics may be impaired, especially at low temperatures. Have the thawed battery checked at a qualified specialist workshop.

Only charge the installed battery with a battery charger which has been tested and approved by Mercedes-Benz. A battery charger unit specially adapted for Mercedes-Benz vehicles and tested and approved by Mercedes-Benz is available as an accessory. It permits the charging of the battery in its installed position. Contact a Mercedes-Benz Service Centre for information and availability. Read the battery charger's operating instructions before charging the battery.



Jump-starting

For the jump-starting procedure, use only the jump-starting connection point, consisting of a positive terminal and an earth point, in the engine compartment.

WARNING

Battery acid is caustic. There is a risk of injury.

Avoid contact with the skin, eyes or clothing. Do not inhale any battery gases. Do not lean over the battery. Keep children away from batteries. Wash battery acid immediately with water and seek medical attention.

WARNING

During charging and jump-starting, explosive gases can escape from the battery. There is a risk of an explosion.

Particularly avoid fire, naked flames, creating sparks and smoking. Ensure there is sufficient ventilation while charging and jump-starting. Do not lean over a battery.

WARNING

During the charging process, a battery produces hydrogen gas. If a short circuit occurs or sparks are created, the hydrogen gas can ignite. There is a risk of an explosion.

- Make sure that the positive terminal of a connected battery does not come into contact with vehicle parts.
- Never place metal objects or tools on a battery.
- It is important that you observe the described order of the battery terminals when connecting and disconnecting a battery.
- When jump-starting, make sure that the battery poles with identical polarity are connected.
- It is particularly important to observe the described order when connecting and disconnecting the jump leads.
- Never connect or disconnect the battery terminals while the engine is running.

WARNING

A discharged battery can freeze at temperatures below freezing point. When jump-starting the vehicle or charging the battery, gases can escape from the battery. There is a risk of an explosion. Allow the frozen battery to thaw out before charging it or jump-starting.

WARNING

Non-combusted fuel can collect in the exhaust system and ignite. There is a risk of fire. Avoid repeated and lengthy starting attempts.

! **Vehicles with a petrol engine:** avoid repeated and lengthy starting attempts. Otherwise, the non-combusted fuel may damage the catalytic converter.

If the indicator/warning lamps do not light up at low temperatures, it is very likely that the discharged battery has frozen. In this case you may neither jump-start the vehicle nor charge the battery. The service life of a battery that has been thawed could be reduced. The starting

characteristics may be impaired, especially at low temperatures. Have the thawed battery checked at a qualified specialist workshop.

Do not use a rapid charging device to start the vehicle. If your vehicle's battery is discharged, the engine can be jump-started from another vehicle or from a second battery using jump leads. Observe the following points:

- The battery is not accessible in all vehicles. If the other vehicle's battery is not accessible, jump-start the vehicle using a second battery or a jump-starting device.
- **Vehicles with a petrol engine:** only jump-start the vehicle when the engine and exhaust system are cold.
- Do not start the engine if the battery is frozen. Let the battery thaw first.
- Jump-starting may only be performed from batteries with a nominal voltage of 12 V.
- Only use jump leads that have a sufficient cross-section and insulated terminal clamps.
- If the battery is fully discharged, leave the battery that is being used to jump-start connected for a few minutes before attempting to start. This charges the empty battery a little.
- Make sure that the two vehicles do not touch.

Make sure that:

- the jump leads are not damaged.
- bare parts of the terminal clamp do not come into contact with other metal parts while the jump leads are connected to the battery.
- the jump leads cannot come into contact with parts which can move when the engine is running, such as the V-belt pulley or the fan.
- ▶ Secure the vehicle by applying the electric parking brake.
- ▶ **Manual transmission:** shift into neutral.
- ▶ **Automatic transmission:** shift the transmission to position **P**.
- ▶ Turn the key to position **0** in the ignition lock and remove it.
- ▶ Switch off all electrical consumers (e.g. radio, blower, etc.).
- ▶ Open the bonnet (▷ page 285).

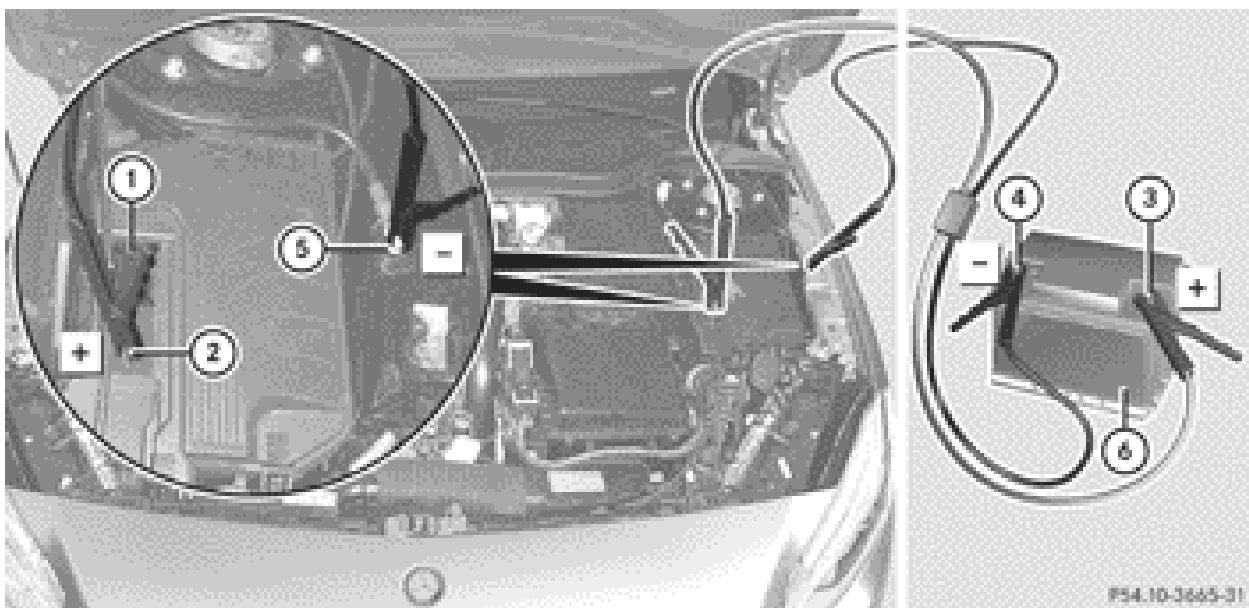

Position number ⑥ identifies the charged battery of the other vehicle or an equivalent jump-starting device.

- ▶ Press together cover ① of positive clamp ② and slide it back.
 - ▶ Connect positive terminal ② on your vehicle to positive terminal ③ of donor battery ⑥ using the jump lead, beginning with your own battery.
 - ▶ Start the engine of the donor vehicle and run it at idling speed.
 - ▶ Connect negative terminal ④ of donor battery ⑥ to earth point ⑤ of your vehicle using the jump lead, connecting the jump lead to donor battery ⑥ first.
 - ▶ Start the engine.
 - ▶ Before disconnecting the jump leads, let the engines run for several minutes.
 - ▶ First, remove the jump leads from earth point ⑤ and negative terminal ④, then from positive clamp ② and positive terminal ③. Begin each time at the contacts on your own vehicle first.
 - ▶ Close cover ① of positive clamp ② after removing the jump leads.
 - ▶ Have the battery checked at a qualified specialist workshop.
- i** Jump-starting is not considered to be a normal operating condition.
- i** Jump-starting cables and further information regarding jump starting can be obtained at any qualified specialist workshop.

Towing and tow-starting

Important safety notes

WARNING

Safety-relevant functions are restricted or not available if:

- the engine is not running.
- the brake system or the power steering is malfunctioning
- the voltage supply or the vehicle's electrical system is malfunctioning.

If your vehicle is towed, significantly greater force may be required to steer the vehicle or to brake. There is a risk of an accident.

In such circumstances, use a towing bar. Make sure that the steering is moving freely before towing.

WARNING

If the weight of the vehicle to be towed or tow-started is greater than the permissible gross weight of your vehicle:

- the towing eye could detach itself
- the vehicle/trailer combination could overturn.

There is a risk of an accident.

When towing or tow-starting another vehicle, its weight should not be greater than the permissible gross weight of your vehicle.

Information on your vehicle's gross vehicle weight rating can be found on the vehicle identification plate (▷ page 338).

WARNING

The vehicle is braked when the HOLD function or DISTRONIC PLUS is activated. Therefore, deactivate HOLD and DISTRONIC PLUS if the vehicle is to be towed.

❗ Only secure the tow rope or towing bar to the towing eyes. The vehicle may otherwise be damaged.

❗ Observe the following points when towing with a tow rope:

- secure the tow rope on the same side on both vehicles.
- make sure that the tow rope is not longer than legally permitted. Mark the tow rope in the middle, e.g. with a white cloth (30 x 30 cm). This makes other road users aware that a vehicle is being towed.
- only secure the tow rope to the towing eye.
- observe the brake lamps of the towing vehicle while driving. Always maintain a distance so that the tow rope does not sag.
- do not use steel cables or chains to tow your vehicle. You could otherwise damage the vehicle.

❗ Do not use the towing eyes for recovery purposes as this could damage the vehicle. If in doubt, recover the vehicle with a crane.

❗ Pull away smoothly when towing away or tow-starting a vehicle. If the tractive power is too high, the vehicles could be damaged.

❗ You may tow the vehicle for a maximum of 50km. A towing speed of 50 km/h must not be exceeded.

For towing distances over 50 km, the front axle or the entire vehicle must be raised and transported.

❗ Vehicles with automatic transmission must not be tow-started. The transmission may otherwise be damaged.

Observe the legal requirements for the relevant countries when towing and tow-starting. It is better to have the vehicle transported than to have it towed.

Vehicles with automatic transmission:

when towing a vehicle, the transmission must be in position **N**.

The battery must be connected and charged. Otherwise, you:

- cannot turn the key in the ignition lock to position **2**
- **vehicles with automatic transmission:** cannot shift the transmission to position **N**

i Deactivate the automatic locking feature (▷ page 223). You could otherwise be locked out when pushing or towing the vehicle.

Deactivate tow-away protection (▷ page 70) before the vehicle is towed.

Fitting/removing the towing eye

Fitting the towing eye

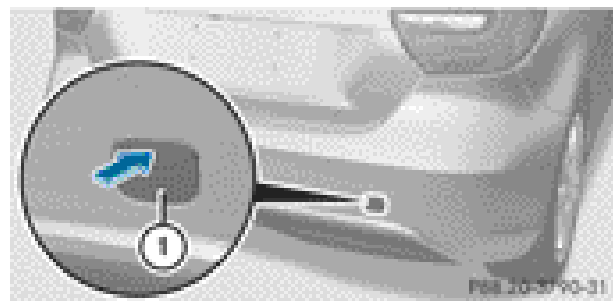
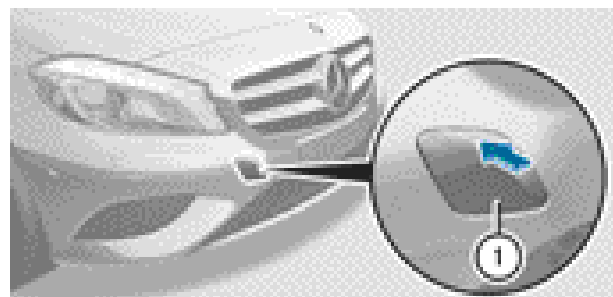

► Remove the towing eye from the stowage space.

The towing eye is located with the vehicle tool kit under the luggage compartment floor (▷ page 299).

Vehicles with a TIREFIT kit: the towing eye is located under the tyre inflation compressor.

- ▶ Press the mark on cover ① inwards in the direction of the arrow.
- ▶ Remove cover ① from the opening.
- ▶ Screw the towing eye in clockwise to the stop and tighten it.

Vehicles with a trailer tow hitch do not have a bracket for the screw-in towing eye at the back. If you intend to use the vehicle for towing, fold out the ball coupling (▷ page 203) and secure the towbar to it.

Removing the towing eye

- ▶ Loosen the towing eye and unscrew it.
- ▶ Attach cover ① to the bumper and press until it engages.
- ▶ Place the towing eye in the stowage well under the luggage compartment floor (▷ page 299).
- ▶ Vehicles with a TIREFIT kit: replace the tyre inflation compressor.

Towing the vehicle with the front axle raised

Only vehicles without 4MATIC can be towed with the front axle raised.

- ❗ Vehicles with 4MATIC must not be towed with the front or rear axle raised; otherwise, the transmission may be damaged.

Vehicles with 4MATIC may either be towed away with both axles on the ground or be loaded up and transported.

- ❗ The ignition must be switched off if you are towing the vehicle with the front axle raised. Intervention by ESP® could otherwise damage the brake system.
- ▶ Turn the key to position **2** in the ignition lock.
- ▶ When the vehicle is stationary, depress the brake pedal and keep it depressed.

- ▶ **Vehicles with manual transmission:** depress the clutch pedal fully and shift to neutral.

or

- ▶ **Vehicles with automatic transmission:** shift the automatic transmission to position **P**.
- ▶ Release the brake pedal.
- ▶ Release the electric parking brake.
- ▶ Deactivate automatic locking (▷ page 223).
- ▶ Switch on the hazard warning lamps (▷ page 108).
- ▶ Turn the key in the ignition lock to position **0** and leave the key in the ignition lock.

When towing your vehicle with the front axle raised, it is important that you observe the safety instructions (▷ page 310).

Towing the vehicle with both axles on the ground

WARNING

The power assistance for the steering and the brake force booster do not work when the engine is not running. You will then need much more effort to brake and steer the vehicle. Adapt your style of driving accordingly.

- ❗ In order to signal a change of direction when towing with the hazard warning lamps switched on, use the combination switch as usual. In this case, only the turn signals for the desired direction flash. When you reset the combination switch, the hazard warning lamps start flashing again.

Vehicles with automatic transmission: the automatic transmission automatically shifts to position **P** when you open the driver's or front-passenger door or when you remove the key from the ignition lock. In order to ensure that the automatic transmission stays in position **N** when towing the vehicle, you must observe the following points:

- ▶ Make sure that the vehicle is stationary.
- ▶ Turn the key to position **2** in the ignition lock.
- ▶ Depress and hold the brake pedal.
- ▶ Shift the automatic transmission to position **N**.

Vehicles with manual transmission:

- ▶ Turn the key to position **2** in the ignition lock.
- ▶ Depress and hold the brake pedal.
- ▶ Engage neutral.

Vehicles with manual or automatic transmission:

- ▶ Leave the key in position **2** in the ignition lock.
- ▶ Release the brake pedal.
- ▶ Release the electric parking brake.
- ▶ Switch on the hazard warning lamps (▷ page 108).

It is important that you observe the safety instructions when towing away your vehicle (▷ page 310).

Transporting the vehicle

- ❗ Only lash the vehicle down by the wheels or wheel rims, not by parts of the vehicle such as axle or steering components. Otherwise, the vehicle could be damaged.

- ▶ **Vehicles with manual transmission:** shift to neutral.
- ▶ **Vehicles with automatic transmission:** turn the key to position **2** in the ignition lock.
- ▶ Move the transmission to position **N**.

As soon as the vehicle is loaded:

- ▶ Prevent the vehicle from rolling away by applying the electric parking brake.
- ▶ **Vehicles with manual transmission:** engage first or reverse gear.
- ▶ **Vehicles with automatic transmission:** shift the transmission to position **P**.
- ▶ Turn the key to position **0** in the ignition lock and remove it.
- ▶ Secure the vehicle.

The towing eyes or trailer tow hitch can be used to pull the vehicle onto a trailer or transporter if you wish to transport it.

Notes for 4MATIC vehicles

- ❗ Vehicles with 4MATIC must not be towed with the front or rear axle raised; otherwise, the transmission may be damaged.

Vehicles with 4MATIC may only be either towed away with both axles on the ground or be loaded up and transported.

If the vehicle has transmission damage or damage to the front or rear axle, have it transported on a transporter or trailer.

In the event of damage to the electrical system

If the battery is defective, the automatic transmission will be locked in position **P**. To shift the automatic transmission to position **N**, you must provide power to the vehicle's electrical system in the same way as when jump-starting (▷ page 308).

Have the vehicle transported on a transporter or trailer.

Tow-starting (emergency engine starting)

! Do not tow-start vehicles with automatic transmission. You could otherwise damage the automatic transmission.

Before tow-starting, the following conditions must be fulfilled:

- the battery is connected.
- the engine has cooled down.
- the exhaust system has cooled down.
- ▶ Switch on the hazard warning lamps (▷ page 108).
- ▶ Fit the towing eye (▷ page 311).
- ▶ Secure the rigid towing bar or the towing rope.
- ▶ Depress and hold the brake pedal.
- ▶ Turn the key to position **2** in the ignition lock.
- ▶ Depress the clutch pedal and keep it depressed.
- ▶ Engage neutral.
- ▶ Release the brake pedal.
- ▶ Tow-start the vehicle.
- ▶ Engage second gear.
- ▶ Release the clutch pedal slowly without depressing the accelerator pedal. The engine is started.
- ▶ Depress the clutch pedal and shift to neutral.
- ▶ Stop at a suitable place.
- ▶ Secure the vehicle by applying the electric parking brake.
- ▶ Remove the rigid towing bar or towing rope.
- ▶ Remove the towing eye (▷ page 312).
- ▶ Switch off the hazard warning lamps.

When tow-starting, it is important that you observe the safety instructions (▷ page 310) and the legal requirements for the relevant countries.

Electrical fuses**Important safety notes****⚠ WARNING**

If you manipulate, bridge or replace a faulty fuse with a fuse of a higher amperage, the electric cables could be overloaded. This may result in a fire. There is a risk of an accident and injury.

Always replace faulty fuses with specified new fuses of the correct amperage.

! Only use fuses that have been approved for Mercedes-Benz vehicles and which have the correct fuse rating for the system concerned. Only use fuses marked with an "S". Components or systems could otherwise be damaged.

The fuses in your vehicle serve to disconnect faulty circuits. If a fuse blows, all the components on the circuit and their functions will fail.

Blown fuses must be replaced with fuses of the same rating, which you can recognise by the colour and fuse rating. The fuse ratings are listed in the fuse allocation chart.

If the newly inserted fuse also blows, have the cause traced and rectified at a qualified specialist workshop, e.g. a Mercedes-Benz Service Centre.

Before replacing a fuse

- ▶ Secure the vehicle against rolling away (▷ page 162).
- ▶ Switch off all electrical consumers.
- ▶ Turn the key to position **0** in the ignition lock and remove it (▷ page 143). All indicator lamps in the instrument cluster must be off.

The fuses are located in various fuse boxes:

- fuse box in the engine compartment on the left-hand side of the vehicle, when viewed in the direction of travel
- fuse box in the front-passenger footwell

The fuse allocation chart is on the fuse box in the front-passenger footwell (▷ page 315).

Fuse box in the engine compartment

WARNING

When the bonnet is open, and the windscreen wipers are set in motion, you can be injured by the wiper linkage. There is a risk of injury. Always switch off the windscreen wipers and the ignition before opening the bonnet.

! Make sure that no moisture can enter the fuse box when the cover is open.

! When closing the cover, make sure that it is lying correctly on the fuse box. Moisture seeping in or dirt could otherwise impair the operation of the fuses.

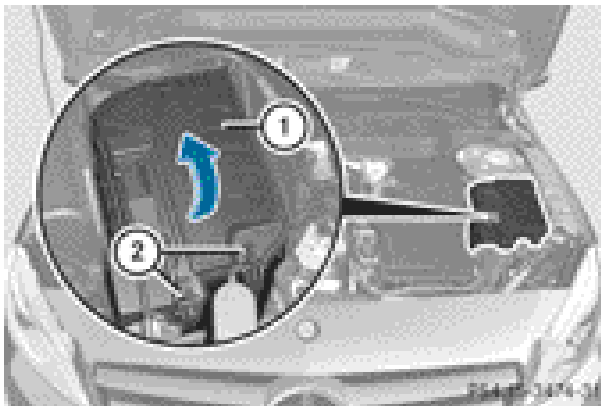

- ▶ Open the bonnet.
- ▶ Remove any existing moisture from the fuse box using a dry cloth.
- ▶ **To open:** open clamps (2).
- ▶ Fold cover (1) up in the direction of the arrow and remove it.

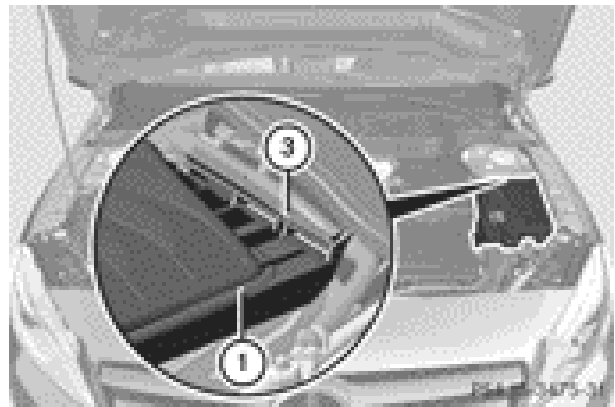

- ▶ **To close:** check whether the seal is lying correctly in cover (1).
- ▶ Insert cover (1) at the back into openings (3) on the fuse box.
- ▶ Fold down cover (1).
- ▶ Hook clamps (2) into the fuse box and close.
- ▶ Close the bonnet.

Fuse box in the front-passenger footwell

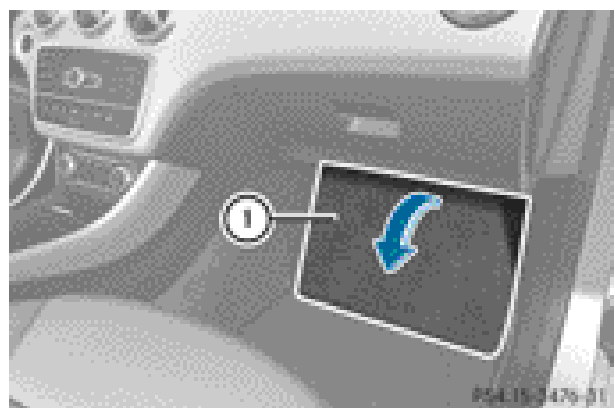

- ▶ **To open:** remove the floor mat from the front-passenger side.
- ▶ Fold out perforated floor covering (1) in the direction of the arrow.

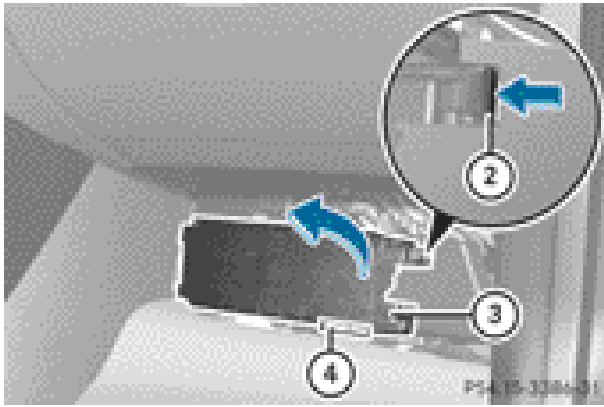

- ▶ To release cover (3), press retaining clamp (2).
- ▶ Fold out cover (3) in the direction of the arrow to the catch.
- ▶ Remove cover (3) forwards.
- i Fuse allocation chart (4) is located on the lower right-hand side of cover (3).
- ▶ **To close:** insert cover (3) on the left-hand side of the fuse box into the retainer. Cover (3) engages in the retainers.
- ▶ Fold down cover (3) until clamps (2) lock audibly.
- ▶ Fold back perforated floor covering (1).

Useful information	318
Important safety notes	318
Operation	318
Winter operation	320
Tyre pressure	321
Changing a wheel	324
Wheel and tyre combinations	329
Emergency spare wheel	332

Useful information

- i** This Owner's Manual describes all models, series and optional equipment for your vehicle that were available at the time of going to press. National variations are possible. Note that your vehicle may not be equipped with all of the functions described. This is also the case for systems and functions relevant to safety.
- i** Read the information on qualified specialist workshops: (▷ page 24).

Important safety notes

WARNING

If wheels and tyres of the wrong size are used, the wheel brakes or suspension components may be damaged. There is a risk of an accident.

Always replace wheels and tyres with those that fulfil the specifications of the original part.

When replacing wheels, make sure to fit the correct:

- designation
- type

When replacing tyres, make sure to fit the correct:

- designation
- manufacturer
- type

WARNING

A flat tyre severely impairs the driving, steering and braking characteristics of the vehicle. There is a risk of accident.

Tyres without run-flat characteristics:

- do not drive with a flat tyre.
- immediately replace the flat tyre with your emergency spare wheel or spare wheel, or consult a qualified specialist workshop.

Tyres with run-flat characteristics:

- pay attention to the information and warning notices on MOExtended tyres (tyres with run-flat characteristics).

Accessories that are not approved for your vehicle by Mercedes-Benz or that are not being used correctly can impair the operating safety.

Before purchasing and using non-approved accessories, visit a qualified specialist workshop and enquire about:

- suitability
- legal stipulations
- factory recommendations

Information on dimensions and types of wheels and tyres for your vehicle can be found (▷ page 329).

Information on air pressure for the tyres on your vehicle can be found:

- on the tyre pressure label on the fuel filler flap
- under "Tyre pressure"

Modification work on the brake system and wheels is not permitted. The use of wheel spacers or brake dust shields is not permitted. This invalidates the general operating permit for the vehicle.

- i** Further information on wheels and tyres can be obtained at any qualified specialist workshop.

Operation

Information on driving

- Check the tyre pressures when the vehicle is heavily laden and, if necessary, adjust.
- While driving, pay attention to vibrations, noises and unusual handling characteristics, e.g. pulling to one side. This may indicate that the wheels or tyres are damaged. If you suspect that a tyre is defective, reduce your speed immediately. Stop the vehicle as soon as possible to check the

wheels and tyres for damage. Hidden tyre damage could also be causing the unusual handling characteristics. If you find no signs of damage, have the wheels and tyres checked at a qualified specialist workshop.

- When parking your vehicle, make sure that the tyres do not get deformed by the kerb or other obstacles. If it is necessary to drive over kerbs, speed humps or similar elevations, try to do so slowly and at an obtuse angle. Otherwise, the tyres, particularly the sidewalls, may be damaged.

Regular checking of wheels and tyres

WARNING

Damaged tyres can cause tyre inflation pressure loss. As a result, you could lose control of your vehicle. There is a risk of accident.

Check the tyres regularly for signs of damage and replace any damaged tyres immediately.

Regularly check the wheels and tyres of your vehicle for damage at least once a month, as well as after driving off-road or on rough roads. Damaged wheels can cause a loss of tyre pressure. Pay particular attention to damage such as:

- cuts in the tyres
- punctures
- tears in the tyres
- bulges on tyres
- deformation or severe corrosion on wheels

Regularly check the tyre tread depth and the condition of the tread across the whole width of the tyre (▷ page 319). If necessary, turn the front wheels to full lock in order to inspect the inner side of the tyre surface.

All wheels must have a valve cap to protect the valve against dirt and moisture. Do not fit anything onto the valve other than the standard valve cap or other valve caps approved by Mercedes-Benz for your vehicle. Do not fit any other valve caps or systems, e.g. tyre pressure monitoring systems.

Regularly check the pressure of all the tyres, particularly prior to long trips. Adjust the tyre pressure as necessary (▷ page 321).

Observe the notes on the emergency spare wheel (▷ page 332).

The service life of tyres depends on various factors, including the following:

- driving style
- tyre pressure
- tyre mileage

Tyre tread

WARNING

Insufficient tyre tread will reduce tyre traction. The tyre is no longer able to dissipate water. This means that on wet road surfaces, the risk of aquaplaning increases, in particular where speed is not adapted to suit the driving conditions. There is a risk of accident.

If the tyre pressure is too high or too low, tyres may exhibit different levels of wear at different locations on the tyre tread. Thus, you should regularly check the tread depth and the condition of the tread across the entire width of all tyres.

Minimum tyre tread depth for:

- summer tyres: 3 mm
- M+S tyres: 4 mm

For safety reasons, replace the tyres before the legally prescribed limit for the minimum tyre tread depth is reached..

Selecting, fitting and replacing tyres

- Only fit tyres and wheels of the same type and make.

Exception: it is permissible to fit a different type or make in the event of a flat tyre.

Observe the "MOExtended tyres (tyres with run-flat characteristics)" section (▷ page 300).

- Only fit tyres of the correct size onto the wheels.

- Run in new tyres at moderate speeds for the first 100 km. They only reach their full performance after this distance.
- Do not drive with tyres which have too little tread depth. This otherwise significantly reduces the traction on wet roads (aquaplaning).
- Replace the tyres after six years at the latest, regardless of wear.

Observe the notes on the emergency spare wheel (▷ page 332).

MOExtended tyres (tyres with run-flat characteristics)

With MOExtended tyres (tyres with run-flat characteristics), you can continue to drive your vehicle even if there is a total loss of pressure in one or more tyres.

MOExtended tyres may only be used in conjunction with an active tyre pressure loss warning system and only on wheels specifically tested by Mercedes-Benz.

Notes on driving with MOExtended tyres with a flat tyre (▷ page 300).

- i** Vehicles with MOExtended tyres are not equipped with a TIREFIT kit at the factory. It is therefore recommended that you additionally equip your vehicle with a TIREFIT kit if you fit tyres that do not feature run-flat characteristics, e.g. winter tyres. A TIREFIT kit can be obtained from a qualified specialist workshop.

Winter operation

General notes

Have your vehicle winterproofed at a qualified specialist workshop at the onset of winter.

Observe the notes in the "Changing a wheel" section (▷ page 324).

Driving with summer tyres

At temperatures below +7 °C, summer tyres lose elasticity and therefore traction and braking power. Change the tyres on your vehicle to M+S tyres. Using summer tyres at very cold temperatures could cause tears to form, thereby damaging the tyres permanently. Mercedes-Benz cannot accept responsibility for this type of damage.

M+S tyres

WARNING

M+S tyres with a tyre tread depth of less than 4 mm are not suitable for use in winter as they do not provide sufficient traction. There is a risk of accident.

M+S tyres with a tread depth of less than 4 mm must be replaced.

At temperatures below +7 °C, use winter tyres or all-season tyres. Both types of tyre are identified by the M+S marking.

Only winter tyres bearing the  snowflake symbol in addition to the M+S marking provide the best possible grip in wintry road conditions. Only these tyres will allow driving safety systems such as ABS and ESP® to function optimally in winter. These tyres have been developed specifically for driving in snow.

Use M+S tyres of the same make and tread on all wheels to maintain safe handling characteristics.

Always observe the maximum permissible speed specified for the M+S tyres you have fitted.

If you fit M+S tyres that have a lower maximum permissible speed than that of the vehicle, affix an appropriate warning sign in the driver's field of vision. This can be obtained at a qualified specialist workshop.

Under these circumstances, you should also restrict the maximum speed of the vehicle using permanent SPEEDTRONIC so that it

does not exceed the maximum permissible speed for the M+S tyres (▷ page 172).

When you have fitted the M+S tyres:

- ▶ Check the tyre pressures (▷ page 321).
- ▶ Restart the tyre pressure loss warning system (▷ page 323).

For more information on driving with the emergency spare wheel, see (▷ page 332).

Snow chains

WARNING

If snow chains are fitted to the rear wheels, they may scrape against the vehicle body or chassis components. This could cause damage to the vehicle or the tyres. There is a risk of an accident.

To avoid hazardous situations:

- never fit snow chains on the rear wheels
- always fit snow chains in pairs to the front wheels.

! **Vehicles with steel wheels:** if you fit snow chains on steel wheels, you may damage the hub caps. Remove the hub caps from the relevant wheels before fitting the snow chains.

For safety reasons, Mercedes-Benz recommends that you only use snow chains that have been specially approved for your vehicle by Mercedes-Benz, or that are of a corresponding standard of quality.

If you intend to fit snow chains, please bear the following points in mind:

- snow chains cannot be fitted to all wheel-tyre combinations. Permissible wheel-tyre combinations (▷ page 329).
- only use snow chains when the road surface is completely snow-covered. Remove the snow chains as soon as possible when you come to a road that is not snow-covered.

- local regulations may restrict the use of snow chains. Observe the appropriate regulations if you wish to fit snow chains.
- do not exceed the maximum permissible speed of 50 km/h.
- when snow chains are fitted, never use Active Parking Assist (▷ page 186).

i You may wish to deactivate ESP® (▷ page 65) when pulling away with snow chains fitted. This way you can allow the wheels to spin in a controlled manner, achieving an increased driving force (cutting action).

Information about driving with an emergency spare wheel (▷ page 332).

Tyre pressure

Tyre pressure specifications

WARNING

Tyres with too low or too high tyre pressure contain the following hazards:

- they can burst, in particular if the vehicle is heavily laden or when driven at high speeds.
- the tyres can wear excessively and/or unevenly, which can severely impair tyre traction.
- the driving, steering and braking characteristics may be severely impaired.

There is a risk of accident.

Follow recommended tyre inflation pressures and check the pressure of all the tyres including the spare wheel:

- at least every two weeks
- if the load changes
- before beginning a long journey
- for changed operating conditions, e.g. off-road driving

If necessary, correct the tyre pressure.

⚠ WARNING

If you fit unsuitable accessories onto tyre valves, the tyre valves may be overloaded and malfunction, which can cause tyre pressure loss. Due to their design, retrofitted tyre pressure monitors keep the tyre valve open. This can also result in tyre pressure loss. There is a risk of accident.

Only screw standard valve caps or valve caps specifically provided by Mercedes-Benz for your vehicle onto the tyre valve.

⚠ WARNING

If the tyre pressure drops repeatedly, the wheel, valve or tyre may be damaged. Tyre pressure that is too low may result in a tyre blow-out. There is a risk of accident.

- Check the tyre for foreign objects.
- Check whether the wheel is losing air or the valve is leaking.

If you are unable to rectify the damage, contact a qualified specialist workshop.

🌿 Environmental note

Check the tyre pressure regularly, at least every 14 days.

You will find a table of tyre pressures for various operating conditions on the inside of your vehicle's fuel filler flap.

Operation with an emergency spare wheel (▷ page 332).

Operation with a trailer: the applicable value for the rear tyres is the maximum tyre pressure value stated in the table inside the fuel filler flap.

The table inside the fuel filler flap may state tyre pressures for different load conditions. These are defined in the table as different numbers of passengers and amounts of luggage. The actual number of seats may vary; for more information, please refer to the vehicle's registration documents.

If tyre sizes are not specified, the tyre pressures stated on the tyre pressure information

label apply for all tyres approved for this vehicle.

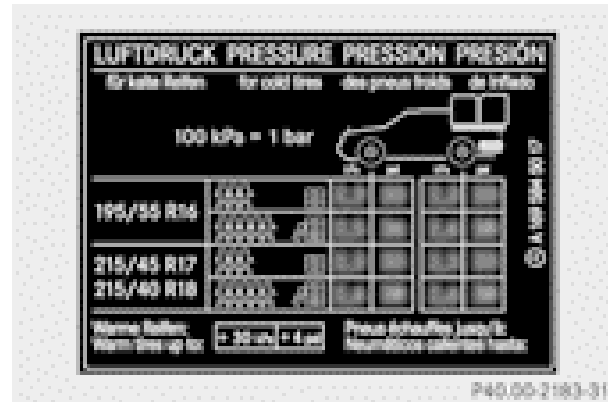

If a tyre size precedes a tyre pressure, the following tyre pressure information is only valid for that tyre size.

Use a suitable pressure gauge to check the tyre pressure. The outer appearance of a tyre does not permit any reliable conclusion about the tyre pressure.

If possible, only correct tyre pressures when the tyres are cold.

The tyres are cold:

- if the vehicle has been parked with the tyres out of direct sunlight for at least three hours and
- if the vehicle has not been driven further than 1.6 km

Depending on the ambient temperature, the speed at which you are driving and the load on the tyres, the tyre temperature and thus the tyre pressure change by approximately 10 kPa per 10 °C (0.1 bar/1.5 psi). Take this into account when checking the pressure of warm tyres. Only correct the tyre pressure if it is too low for the current operating conditions.

Driving with tyre pressure that is too high or too low can:

- shorten the service life of the tyres
- cause increased tyre damage
- have a negative effect on handling characteristics and thus the driving safety (e.g. aquaplaning)

- i** The tyre pressure values given for low loads are minimum values which offer you good ride comfort characteristics.

However, you can also use the values given for higher loads. These are permissible and will not adversely affect the running of the vehicle.

Tyre pressure loss warning system

Important safety notes

While the vehicle is in motion, the tyre pressure loss warning system monitors the set tyre pressure using the rotational speed of the wheels. This enables the system to detect significant pressure loss in a tyre. If the speed of rotation of a wheel changes as a result of a loss of pressure, a corresponding warning message will appear in the multifunction display.

The tyre pressure warning system does not warn you of an incorrectly set tyre pressure. Observe the notes on the recommended tyre pressure (▷ page 321).

The tyre pressure loss warning system does not replace the need to regularly check your vehicle's tyre pressures, since an even loss of pressure on several tyres at the same time cannot be detected by the tyre pressure loss warning system.

The tyre pressure monitor is not able to warn you of a sudden loss of pressure, e.g. if the tyre is penetrated by a foreign object. In the event of a sudden loss of pressure, bring the vehicle to a halt by braking carefully. Avoid abrupt steering manoeuvres.

The function of the tyre pressure loss warning system is limited or delayed if:

- snow chains are fitted to your vehicle's tyres.
- road conditions are wintry.
- you are driving on sand or gravel.
- you adopt a very sporty driving style (cornering at high speeds or driving with high rates of acceleration).
- you are towing a very heavy or large trailer.
- you are driving with a heavy load (in the vehicle or on the roof).





Restarting the tyre pressure loss warning system

Restart the tyre pressure loss warning system if you have:





- changed the tyre pressure
- changed the wheels or tyres
- fitted new wheels or tyres

- ▶ Before restarting, make sure that the tyre pressures are set properly on all four tyres for the respective operating conditions. The recommended tyre pressures can be found in the table on the fuel filler flap.

The tyre pressure loss warning system can only give reliable warnings if you have set the correct tyre pressure. If an incorrect tyre pressure is set, these incorrect values will be monitored.

- ▶ Observe the notes on tyre pressure (▷ page 321).
- ▶ Make sure that the key is in position **2** (▷ page 143) in the ignition lock.
- ▶ Press the  or  button on the steering wheel to select the **Service** menu.
- ▶ Press the  or  button to select **Tyre pressure**.
- ▶ Press the  button.
The **Run Flat Indicator active Restart with OK** message appears in the multifunction display.

If you wish to confirm the restart:

- ▶ Press the  button.
The **Tyre press. now OK?** message appears in the multifunction display.
- ▶ Press the  or  button to select **Yes**.
- ▶ Press the  button.
The **Run Flat Indicator restarted** message appears in the multifunction display.



After a teach-in period, the tyre pressure loss warning system will monitor the set tyre pressures of all four tyres.

or

If you wish to cancel the restart:

▶ Press the  button.

or

▶ If the **Tyre press. now OK?** message appears, use the  or  button to select **Cancel**.

▶ Press the  button.

The tyre pressure values stored at the last restart will continue to be monitored.

Always pay attention to the instructions and safety notes when changing a wheel (▷ page 324).

The wear patterns on the front and rear tyres differ, depending on the operating conditions. Interchange the wheels before a clear wear pattern has formed on the tyres. Front tyres typically wear more on the shoulders and the rear tyres in the centre.

On vehicles that have the same size front and rear wheels, you can interchange the wheels every 5,000km to 10,000 km depending on the degree of tyre wear. Maintain the direction of tyre rotation.

Clean the contact surfaces of the wheel and the brake disc thoroughly every time a wheel is interchanged. Check the tyre pressure and, if necessary, restart the tyre pressure loss warning system.

Changing a wheel

Flat tyre

You can find information on what to do in the event of flat tyre in the "Flat tyre" section (▷ page 300). You will also find information on driving with MOExtended tyres in the event of a flat tyre.

Vehicles with an emergency spare

wheel: in the event of a flat tyre, the emergency spare wheel is fitted according to the description under "Fitting a wheel" (▷ page 325).

Interchanging the wheels

 **WARNING**

Interchanging the front and rear wheels may severely impair the driving characteristics if the wheels or tyres have different dimensions. The wheel brakes or suspension components may also be damaged. There is a risk of accident.

Interchange front and rear wheels only if the wheels and tyres are of the same dimensions.

Interchanging the front and rear wheels of differing dimensions can render the general operating permit invalid.

Direction of rotation

Tyres with a specified direction of rotation have additional benefits, e.g. if there is a risk of aquaplaning. You will only gain these benefits if the correct direction of rotation is observed.

An arrow on the sidewall of the tyre indicates its correct direction of rotation.

Storing wheels

Store wheels that are not being used in a cool, dry and preferably dark place. Protect the tyres against oil, grease, petrol and diesel.

Cleaning the wheels

 **WARNING**

The water jet of circular-jet nozzles (dirt grinders) can cause damage not visible from the outside to tyres or chassis components. Components damaged in this way can unexpectedly fail. There is a risk of an accident.

Do not use high-pressure cleaners with circular-jet nozzles to clean the vehicle. Have damaged tyres or chassis components replaced immediately.

Fitting a wheel

Preparing the vehicle

- ▶ Stop the vehicle on solid, non-slippery and level ground.
- ▶ Apply the electric parking brake manually (▷ page 163).
- ▶ Bring the front wheels into the straight-ahead position.
- ▶ **Vehicles with manual transmission:** engage first or reverse gear.
- ▶ **Vehicles with automatic transmission:** move the DIRECT SELECT lever to **P**.
- ▶ Switch off the engine.
- ▶ Remove the key from the ignition lock.
- ▶ If a trailer is coupled to the vehicle, uncouple it.
- ▶ If included in the vehicle equipment, remove the tyre-change tool kit from the vehicle.
- ▶ Secure the vehicle to prevent it from rolling away.

i Apart from certain country-specific variations, vehicles are not equipped with a tyre-change tool kit. For information on which tools are required to perform a wheel change on your vehicle, consult a Mercedes-Benz Service Centre.

Necessary wheel-changing tools can include, for example:

- Jack
- Wheel chock
- Wheel wrench

Securing the vehicle against rolling away

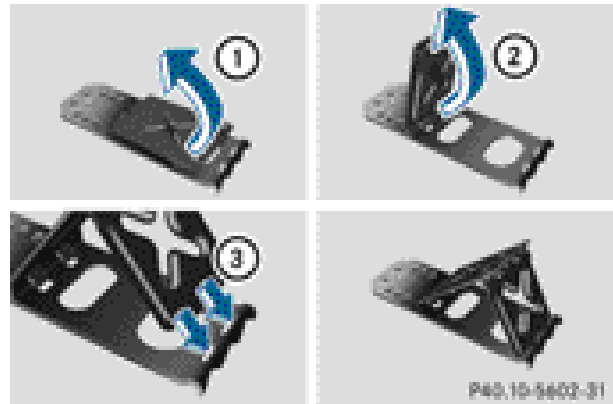

If your vehicle is equipped with a wheel chock, it can be found in the tyre-change tool kit (▷ page 299).

The folding wheel chock is an additional securing measure to prevent the vehicle from rolling away, for example when changing a wheel.

- ▶ Fold both plates upwards ①.
- ▶ Fold out lower plate ②.
- ▶ Guide the lugs on the lower plate fully into the openings in base plate ③.



Securing the vehicle on level ground

- ▶ **On level ground:** place chocks or other suitable items under the front and rear of the wheel that is diagonally opposite the wheel you wish to change.



Securing the vehicle on slight downhill gradients

- **On light downhill gradients:** place chocks or other suitable items in front of the wheels of the front and rear axle.

Raising the vehicle

WARNING

If you do not position the jack correctly at the appropriate jacking point of the vehicle, the jack could tip over with the vehicle raised. There is a risk of injury.

Only position the jack at the appropriate jacking point of the vehicle. The base of the jack must be positioned vertically, directly under the jacking point of the vehicle.

Observe the following when raising the vehicle:

- to raise the vehicle, only use the vehicle-specific jack that has been tested and approved by Mercedes-Benz. If the jack is used incorrectly, it could tip over while the vehicle is raised.
- the jack is designed only to raise and hold the vehicle for a short time while a wheel is being changed. It is not suitable for performing maintenance work under the vehicle.
- avoid changing the wheel on uphill and downhill slopes.
- before raising the vehicle, secure it from rolling away by applying the parking brake and positioning wheel chocks. Never release the parking brake while the vehicle is raised.

- the jack must be placed on a firm, flat and non-slip surface. On a loose surface, a large, load-bearing underlay must be used. On a slippery surface, a non-slip underlay must be used, e.g. rubber mats.
- do not use wooden blocks or similar objects as a jack underlay. Otherwise, the jack will not be able to achieve its load-bearing capacity due to the restricted height.
- make sure that the distance between the underside of the tyres and the ground does not exceed 3 cm.
- never place your hands or feet under the raised vehicle.
- never lie under the raised vehicle.
- never start the engine when the vehicle is raised.
- never open or close a door or the tailgate when the vehicle is raised.
- make sure that no persons are present in the vehicle when the vehicle is raised.

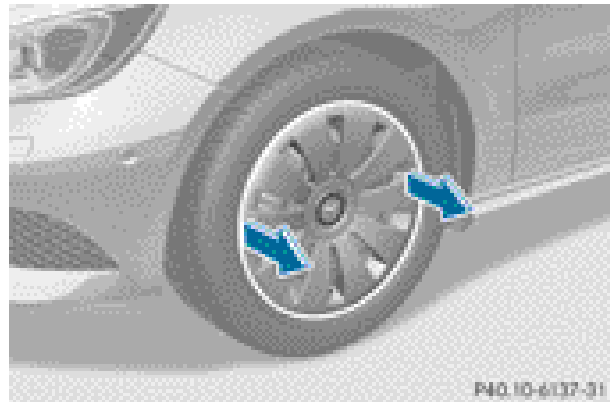

Steel wheel with wheel trim

- **Vehicles with steel wheels:** carefully reach into two of the wheel trim openings and remove the wheel trim.

Vehicles with hub caps: the hub cap covers the wheel bolts. Before you can unscrew the wheel bolts, you must remove the hub cap.



- ▶ **To remove:** turn the centre cover of hub cap ① anti-clockwise and remove.
- ▶ **To fit:** before fitting, ensure that hub cap ① is in the open position. To do so, turn the centre cover anti-clockwise.
- ▶ Put hub cap ① in position and turn the centre cover clockwise until you feel and hear hub cap ① engage.
- ▶ Make sure that hub cap ① is fitted securely.

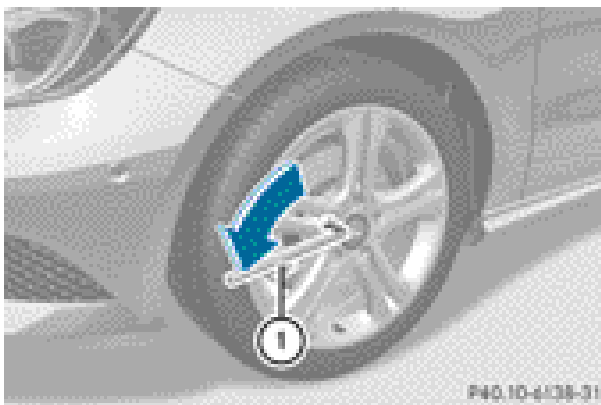

- ▶ Using wheel wrench ①, loosen the bolts on the wheel you wish to change by about one full turn. Do not unscrew the bolts completely.

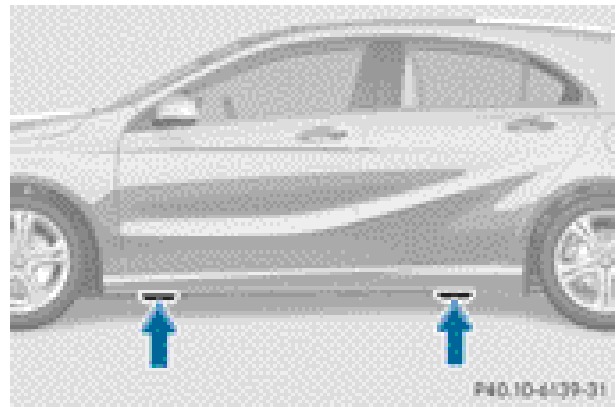

The jacking points are located just behind the front wheel arches and just in front of the rear wheel arches (arrows).

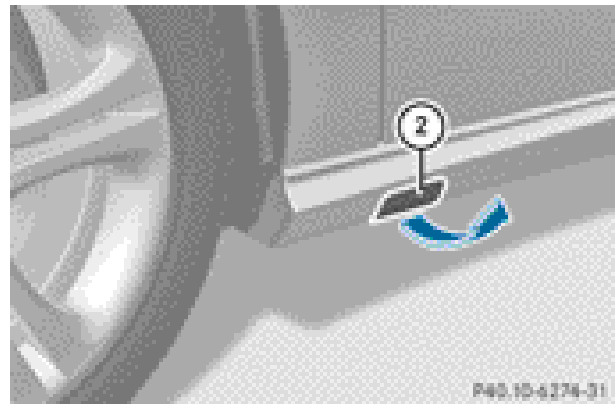

Covers, front (example: vehicles with AMG equipment)

AMG vehicles and vehicles with AMG equipment: the vehicle has covers fitted next to the jacking points on the outer sills to protect the vehicle body.

- ▶ **AMG vehicles and vehicles with AMG equipment:** fold cover ② upwards.
- ▶ Take the ratchet ring spanner out of the tyre-changing tool kit and place it on the hexagon nut of the jack so that the letters **AUF** are visible.

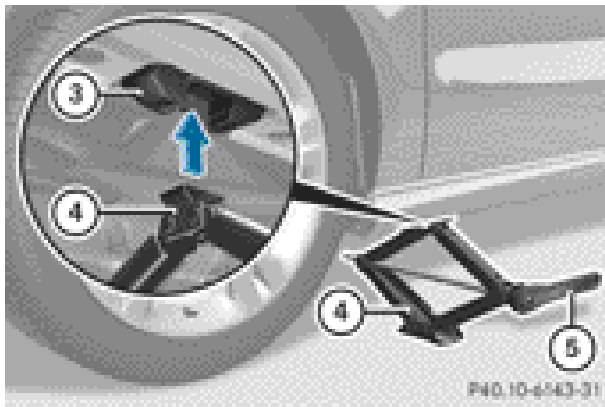

- ▶ Position jack ④ at jacking point ③.

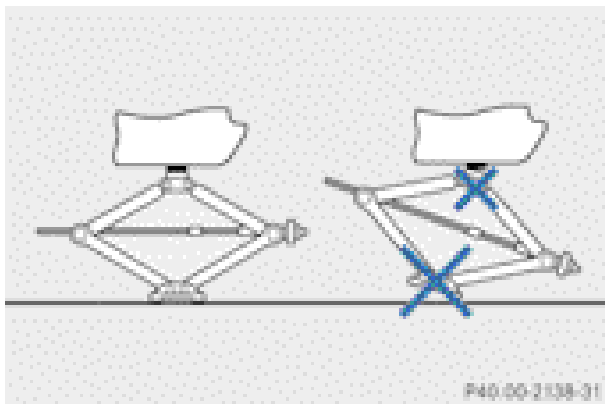

- ▶ Make sure that the base of the jack is positioned vertically under the jacking point.
- ▶ Turn ratchet ring spanner ⑤ until jack ④ sits completely on jacking point ③ and the base of the jack lies evenly on the ground.
- ▶ Turn ratchet ring spanner ⑤ until the tyre is raised a maximum of 3 cm from the ground.

Removing a wheel

- ❗ Do not place wheel bolts in sand or dirt. The threads of the wheel bolts and wheel hubs could otherwise be damaged when the bolts are tightened.
- ▶ Unscrew the wheel bolts.
- ▶ Remove the wheel.

Fitting a new wheel

⚠ WARNING

Oiled or greased wheel bolts or damaged wheel bolts/hub threads can cause the wheel bolts to come loose. As a result, you could lose a wheel while driving. There is a risk of accident.

Never oil or grease wheel bolts. In the event of damage to the threads, contact a qualified specialist workshop immediately. Have the damaged wheel bolts or hub threads replaced/renewed. Do not continue driving.

⚠ WARNING

If you tighten the wheel bolts or wheel nuts when the vehicle is raised, the jack could tip over. There is a risk of injury.

Only tighten the wheel bolts or wheel nuts when the vehicle is on the ground.

Always pay attention to the instructions and safety notices in "Changing a wheel" (▷ page 324).

Only use wheel bolts that have been designed for the wheel and the vehicle. For safety reasons, Mercedes-Benz recommends that you only use wheel bolts which have been approved for Mercedes-Benz vehicles and the respective wheel.

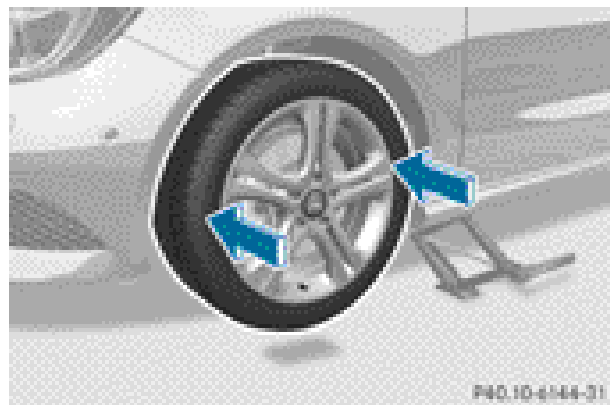

- ▶ Clean the wheel and wheel hub contact surfaces.
- ▶ Place the new wheel on the wheel hub and push it on.

- ▶ Tighten the wheel bolts until they are finger-tight.

Lowering the vehicle

WARNING

The wheels could work loose if the wheel nuts and bolts are not tightened to the specified tightening torque. There is a risk of accident. Have the tightening torque immediately checked at a qualified specialist workshop after a wheel is changed.

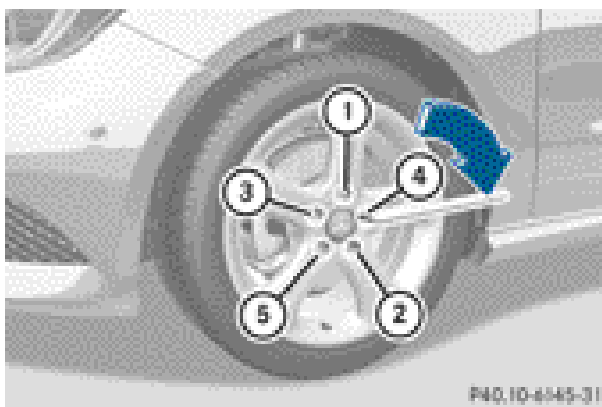

- ▶ Place the ratchet ring spanner onto the hexagon nut of the jack so that the letters **AB** are visible.
- ▶ Turn the ratchet ring spanner until the vehicle is once again standing firmly on the ground.
- ▶ Place the jack to one side.
- ▶ Tighten the wheel bolts evenly in a cross-wise pattern in the sequence indicated (① to ⑤). The tightening torque must be **130 Nm**.
- ▶ Turn the jack back to its initial position.
- ▶ Stow the jack and the rest of the vehicle tools in the vehicle again.
- ▶ **Vehicles with AMG equipment:** insert the cover into the outer sill.
- ▶ Check the air pressure of the newly fitted wheel and adjust accordingly.
Observe the recommended tyre pressure (▶ page 321).

Wheel and tyre combinations

General notes

- ! For safety reasons, Mercedes-Benz recommends that you only use tyres and wheels which have been approved by Mercedes-Benz specifically for your vehicle.

These are specially adapted to the control systems, such as ABS or ESP® and are marked as follows:

- MO = Mercedes-Benz Original
- MOE = Mercedes-Benz Original Extended (tyres featuring run-flat characteristics)
- MO1 = Mercedes-Benz Original (only certain AMG tyres)

Mercedes-Benz Original Extended tyres may only be used on wheels that have been specifically approved by Mercedes-Benz.

Only use tyres, wheels or accessories tested and approved by Mercedes-Benz. Certain characteristics, e.g. handling, vehicle noise emissions or fuel consumption, may otherwise be adversely affected. In addition, when driving with a load, tyre dimension variations could cause the tyres to come into contact with the bodywork and axle components. This could result in damage to the tyres or the vehicle.

Mercedes-Benz accepts no liability for damage resulting from the use of tyres, wheels or accessories other than those tested and approved.

Further information about wheels, tyres and approved combinations can be obtained from any qualified specialist workshop.

- ! Retreaded tyres are neither tested nor recommended by Mercedes-Benz, since previous damage cannot always be detected on retreaded tyres. As a result, Mercedes-Benz cannot guarantee vehicle safety if retreaded tyres are fitted. Do not fit used tyres if you have no information about their previous usage.

! Large wheels: the lower the section width for a certain wheel size, the lower the ride comfort is on poor road surfaces. Roll comfort and suspension comfort are reduced and the risk of damage to the wheels and tyres as a result of driving over obstacles increases.

Overview of abbreviations used in the following tyre tables:

- BA: both axles
- FA: front axle
- RA: rear axle

You will find a table with recommended tyre pressures for various operating conditions on the inside of your vehicle's fuel filler flap. For further information on tyre pressure, see (▷ page 321). Check tyre pressures regularly and only when the tyres are cold.

Notes on the vehicle equipment – always fit the vehicle:

- with tyres of the same size on a given axle (left/right)
- with the same type of tyres at a given time (summer tyres, winter tyres, MOExtended tyres)

Exception: it is permissible to fit a different type or make in the event of a flat tyre.

Observe the "MOExtended tyres (tyres with run-flat characteristics)" section (▷ page 300).





Vehicles with MOExtended tyres are not equipped with a TIREFIT kit at the factory. It is therefore recommended that you additionally equip your vehicle with a TIREFIT kit if you fit tyres that do not feature run-flat characteristics, e.g. winter tyres. A TIREFIT kit can be obtained from a qualified specialist workshop.

In the following table, the wheel/tyre combinations are allocated to the vehicle models through variants, e.g. V1, V2 etc.:

V1	A 180 ¹²
V2	A 180 CDI ¹²
V3	A 200 ¹² , A 220 CDI ¹²
V4	A 200 CDI ¹²
V5	A 250 ¹²
V6	A 250 Sport
V7	A 45 AMG 4MATIC

i Not all wheel/tyre combinations can be fitted at the factory in all countries.

Tyres									
	Summer tyres	Light-alloy wheels	V 1	V 2	V 3	V 4	V 5	V 6	V 7
BA	195/65 R15 91 T	6.5 J x 15 H2 ET 47	—	•	—	—	—	—	—
BA	195/65 R15 91 H ¹³	6.5 J x 15 H2 ET 47	•	—	—	—	—	—	—
BA	205/55 R16 91 H	6.5 J x 16 H2 ET 49	•	•	—	•	—	—	—
BA	205/55 R16 91 V ¹⁴	6.5 J x 16 H2 ET 49	•	•	•	•	—	—	—
BA	205/55 R16 91 V MOExtended ^{14, 15}	6.5 J x 16 H2 ET 49	•	•	•	•	—	—	—
BA	225/45 R17 91 V ^{14, 16}	7.5 J x 17 H2 ET 52.5	•	•	•	•	•	—	—
BA	225/45 R17 91 W MOExtended ^{14, 15, 16}	7.5 J x 17 H2 ET 52.5	•	•	•	•	•	—	—
BA	225/40 R18 92 W XL MOExtended ^{14, 15, 16, 17}	7.5 J x 18 H2 ET 52	•	•	•	•	•	—	—
BA	235/40 ZR18 95 Y XL ¹⁶	8.0 J x 18 H2 ET 48	—	—	—	—	—	•	•
BA	235/35 ZR19 91 Y XL ¹⁶	8.0 J x 19 H2 ET 48	—	—	—	—	—	—	•

	Winter tyres	Light-alloy wheels	V 1	V 2	V 3	V 4	V 5	V 6	V 7
BA	195/65 R15 91 T M+S  ¹³	6.5 J x 15 H2 ET 47	•	•	—	—	—	—	—
BA	205/55 R16 91 H M+S  ¹⁴	6.5 J x 16 H2 ET 49	•	•	•	•	—	—	—
BA	205/55 R16 91 H M+S  MOExtended ^{14, 15}	6.5 J x 16 H2 ET 49	•	•	•	•	—	—	—
BA	205/50 R17 93 H XL M+S 	6.5 J x 17 H2 ET 49	•	•	•	•	•	•	—
BA	205/50 R17 93 H XL M+S  MOExtended ^{14, 15}	6.5 J x 17 H2 ET 49	•	•	•	•	•	•	—



¹³ A 180 BlueEFFICIENCY: only for vehicles with 15" tyres fitted at the factory.

¹⁴ A 250 BlueEFFICIENCY: not in conjunction with Sports Edition package (code P84).

¹⁵ MOExtended tyres (tyres featuring run-flat characteristics) only in combination with an activated tyre pressure loss warning system.

¹⁶ Use of snow chains not permitted. Observe the notes in the "Snow chains" section.

¹⁷ Observe notes on "Large wheels" in the "Wheel/tyre combinations" section.

Winter tyres		Light-alloy wheels	V 1	V 2	V 3	V 4	V 5	V 6	V 7
BA	215/45 R18 93 V XL M+S 	7.5 J x 18 H2 ET 42	–	–	–	–	–	–	•
BA	235/40 R18 95 V XL M+S  ¹⁶	8.0 J x 18 H2 ET 48	–	–	–	–	–	–	•

Emergency spare wheel

Important safety notes

WARNING

The wheel/tyre dimensions and the tyre type of the spare wheel/emergency spare wheel and the wheel to be replaced may differ. Fitting a spare wheel/emergency spare wheel may severely impair the driving characteristics. There is a risk of accident.

To prevent hazardous situations:

- Adapt your driving style accordingly and drive carefully.
- Never fit more than one spare wheel/emergency spare wheel if the dimensions are different to those of the wheel being replaced.
- Only use a spare wheel/emergency spare wheel briefly if the dimensions are different to those of the wheel being replaced.
- Do not switch off ESP®.
- Have the spare wheel/emergency spare wheel in question replaced at the nearest qualified specialist workshop. Make sure that the wheel/tyre dimensions and tyre type are correct.

When using an emergency spare wheel or spare wheel of a different size, you must not exceed the maximum speed of 80 km/h. Snow chains must not be fitted to emergency spare wheels.

General notes

You should regularly check the pressure of the emergency spare wheel, particularly prior to long trips, and correct the pressure as necessary (▷ page 321). The value on the wheel or as given in the "Technical data" section (▷ page 329) is valid.

- i** When you are driving with the emergency spare wheel fitted, the tyre pressure loss warning system cannot function reliably. Only restart the tyre pressure loss warning system when the defective wheel has been replaced with a new wheel.

An emergency spare wheel may also be fitted against the direction of rotation. Observe the time restriction on use as well as the speed limitation specified on the emergency spare wheel.

Replace the tyres after six years at the latest, regardless of wear. This also applies to the emergency spare wheel.

Removing the emergency spare wheel

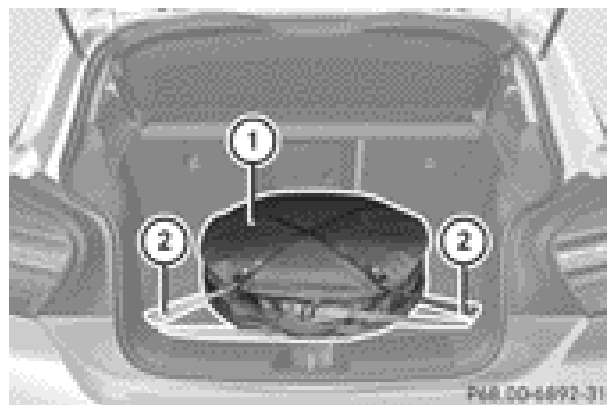

¹⁶ Use of snow chains not permitted. Observe the notes in the "Snow chains" section.

- ▶ Open the tailgate.
- ▶ Loosen lashing straps ② on emergency spare wheel bag ①.
- ▶ Remove emergency spare wheel bag ① with the "Minispare" emergency spare wheel.

For further information on changing and fitting a wheel, see (▷ page 325).

Technical data

"Minispare" emergency spare wheel

Tyres	Steel wheel
T 125/80 R17 99 M Tyre pressure: 420 kPa (4.2 bar/61 psi)	3.5 B x 17 H2 ET 19.5

Useful information	336
Information on technical data	336
Vehicle electronics	336
Identification plates	338
Service products and capacities	338
Vehicle data	346
Trailer tow hitch	348
24 GHz radar sensor system (country overview)	350

Useful information

- i** This Owner's Manual describes all models, series and optional equipment for your vehicle that were available at the time of going to press. National variations are possible. Note that your vehicle may not be equipped with all of the functions described. This is also the case for systems and functions relevant to safety.
- i** Read the information on qualified specialist workshops: (▷ page 24).

Information on technical data

You can find technical data on the Internet at: <http://www.mercedes-benz.com>

- i** The technical data was determined in accordance with EC Directives. All data applies to the vehicle's standard equipment. It may therefore differ for vehicles with optional equipment. You can obtain further information from a Mercedes-Benz Service Centre.

Vehicle electronics

Tampering with the engine electronics

- !** Only have work carried out on the engine electronics and its associated parts, such as control units, sensors and connector leads, at a qualified specialist workshop. Vehicle components may otherwise wear more quickly and the vehicle's operating permit may be invalidated.

Retrofitting two-way radios and mobile phones (RF transmitters)

WARNING

If RF transmitters are tampered with or not properly retrofitted, the electromagnetic radi-

ation they emit can interfere with the vehicle electronics. This may jeopardise the operational safety of the vehicle. There is a risk of an accident.

You should have all work on electrical and electronic components carried out at a qualified specialist workshop.

WARNING

If you use the RF transmitter in the vehicle in an improper way, its electromagnetic radiation can disrupt vehicle electronics, e.g. if:

- the RF transmitter is not connected to an exterior aerial
- the exterior aerial is fitted incorrectly or is not a low-reflection aerial

This can jeopardise the operating safety of the vehicle. There is a risk of an accident.

Have the low-reflection exterior aerial fitted at a qualified specialist workshop. When operating in the vehicle, always connect the RF transmitter to the low-reflection exterior aerial.

- !** The operating permit may be invalidated if the instructions for installation and use of RF transmitters are not observed.

In particular, the following conditions must be complied with:

- only approved wavebands may be used.
- observe the maximum permissible output in these wavebands.
- only approved aerial positions may be used.

Observe the notes on operating mobile phones (▷ page 279).

The following aerial positions may be used for the correct installation of RF transmitters:

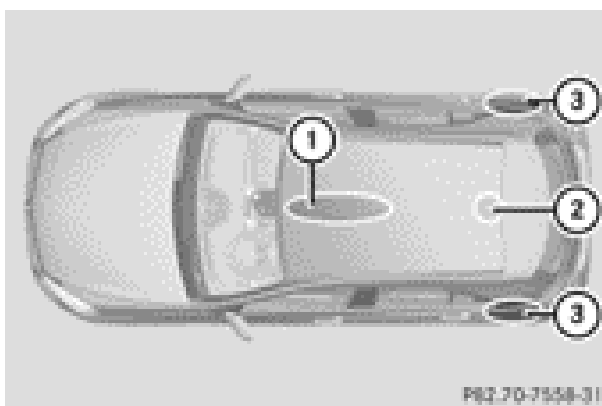

Approved aerial positions

- ① Front roof area
- ② Rear roof area
- ③ Rear wing

i On vehicles with panorama sliding sunroof, fitting an aerial to the front roof area is not permitted.

On the rear wing, it is recommended that you position the aerial on the side of the vehicle closest to the centre of the road.

Use Technical Specification ISO/TS 21609 (Road Vehicles – "EMC guidelines for fitting aftermarket radio frequency transmitting equipment") when retrofitting RF (radio frequency) transmitters. Comply with the legal requirements for add-on parts.

If your vehicle has fittings for two-way radio equipment, use the power supply or aerial connections intended for use with the basic wiring. Be sure to observe the manufacturer's additional instructions when installing.

Deviations with respect to wavebands, maximum transmission outputs or aerial positions must be approved by Mercedes-Benz.

The maximum transmission output (PEAK) at the base of the aerial must not exceed the following values:

Waveband	Maximum transmission output
Short wave 3 - 54 MHz	100 W
4 m waveband 68 - 87.5 MHz	30 W
2 m waveband 144 - 174 MHz	50 W
Trunked radio/Tetra 380 - 460 MHz	35 W
70 cm waveband 400 - 460 MHz	35 W
GSM/DCS/PCS 850/900/1800/1900	10 W
UMTS/LTE	10 W

The following can be used in the vehicle without restrictions:

- RF transmitters with a maximum transmission output of up to 100 mW
- mobile phones (GSM/DCS/PCS/UMTS/LTE)

There are no restrictions when positioning the aerial on the outside of the vehicle for the following wavebands:

- Trunked radio/Tetra
- 70 cm waveband
- GSM/DCS/PCS
- UMTS/LTE

Identification plates

Vehicle identification plate with vehicle identification number (VIN)

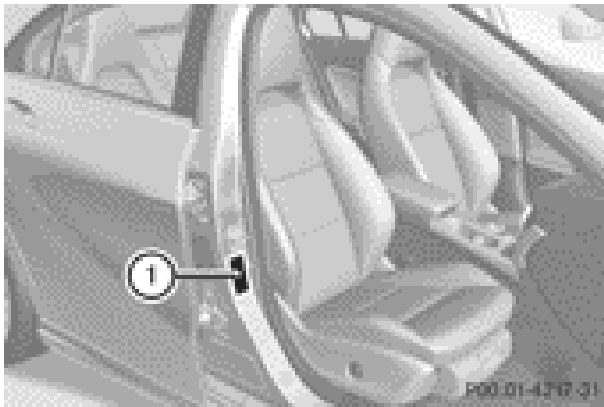

- Open the front right-hand door. You will see vehicle identification plate ①.

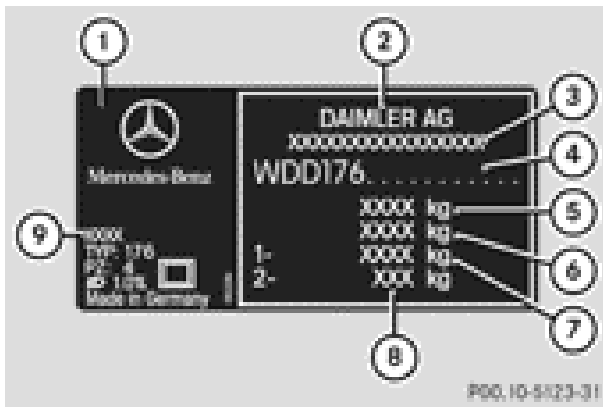

Example: vehicle identification plate

- ① Vehicle identification plate
- ② Vehicle manufacturer (Daimler AG)
- ③ EU type approval number (only for certain countries)
- ④ VIN
- ⑤ Maximum permissible gross vehicle weight (kg)
- ⑥ Maximum permissible mass of vehicle/trailer combination (kg)
- ⑦ Maximum permissible front axle load (kg)
- ⑧ Maximum permissible rear axle load (kg)
- ⑨ Paint code

i The data shown on the vehicle identification plate is example data. This data is different for every vehicle and can deviate from the data shown here. You can find the

data applicable to your vehicle on the vehicle's identification plate.

VIN

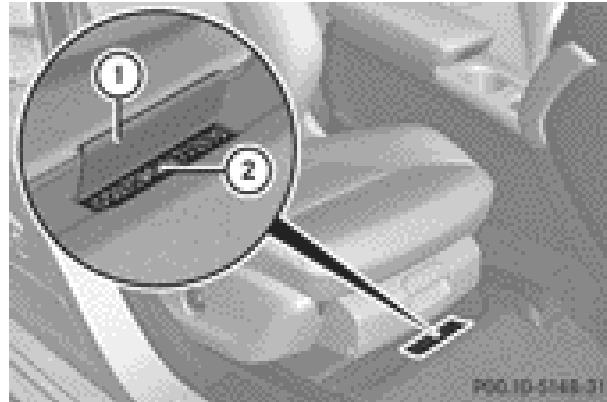

- Slide the right-hand front seat to its rearmost position.
- Fold up floor covering ① in front of the right-hand front seat. You will see VIN ②.

The VIN can also be found on the vehicle identification plate (► page 338).

Engine number

The engine number is stamped onto the crankcase. More information can be obtained from any Mercedes-Benz Service Centre.

Service products and capacities

Important safety notes

⚠ WARNING

Service product can be poisonous and hazardous to health. There is a risk of injury.

Observe the instructions on the respective original container when using, storing and disposing off service products. Always store service products in the sealed original container. Always keep service products out of the reach of children.

Environmental note

Dispose of service products in an environmentally-responsible manner.

Service products include the following:

- Fuels (e.g. petrol, diesel)
- Lubricants (e.g. engine oil, transmission oil)
- Coolant
- Brake fluid
- Windscreen washer fluid
- Climate control system refrigerant

Components and service products must be matched. Mercedes-Benz recommends that you use products tested and approved by Mercedes-Benz. They are listed in this Mercedes-Benz Owner's Manual in the appropriate section.

You can identify service products approved by Mercedes-Benz by the following inscriptions on the container:

- MB-Freigabe (e.g. MB-Freigabe 229.51)
- MB Approval (e.g. MB Approval 229.51)

Other designations or recommendations indicate a level of quality or a specification in accordance with an MB Sheet Number (e.g. MB 229.5). They have not necessarily been approved by Mercedes-Benz.

Further information can be obtained from any Mercedes-Benz Service Centre or on the Internet at <http://bevo.mercedes-benz.com>.

Fuel

Important safety notes

WARNING

Fuel is highly flammable. If you handle fuel incorrectly, there is a risk of fire and explosion.

You must avoid fire, naked flames, creating sparks and smoking. Switch off the engine and, if applicable, the auxiliary heating before refuelling.

WARNING

Fuels are poisonous and hazardous to health. There is a danger of injury.

Do not swallow fuel or let it come into contact with skin, eyes or clothing. Do not inhale fuel vapours. Keep fuels out of the reach of children.

If you or others come into contact with fuel, observe the following:

- Wash the fuel off any affected areas of skin with water and soap immediately.
- If you get fuel in your eyes, rinse them thoroughly with clean water immediately. Seek immediate medical attention.
- If fuel is swallowed, seek immediate medical attention. Do not induce vomiting.
- Change any clothing that has come into contact with fuel immediately.

Tank capacity

The total capacity of the fuel tank may vary, depending on the vehicle equipment.

Model	Total capacity
A 180 BlueEFFICIENCY, manual transmission	40 l
A 180 CDI BlueEFFICIENCY, manual transmission	or 50.0 l
Models with 4MATIC	56.0 l
All other models	50.0 l

Model	Of which reserve fuel
AMG vehicles	Approx. 8.0 l
All other models	Approx. 6.0 l

Petrol (EN 228, E DIN 51626-1)

Fuel grade (AMG vehicles)

! Only refuel using super unleaded petrol with at least 98 RON/88 MON that conforms to European standard EN 228 or an equivalent specification.

You can otherwise impair engine output or damage the engine.

! Premium-grade unleaded petrol with an octane rating of 95 RON/85 MON may be used as a temporary measure if the recommended fuel is not available. This may reduce engine performance and increase fuel consumption. As much as possible, avoid driving at full throttle.

! Regular unleaded petrol with an octane rating of 91 RON/82.5 MON may also be used as a temporary measure if the recommended fuel is not available.

Doing so results in noticeably higher fuel consumption, and the engine power output is noticeably reduced. Avoid driving at full throttle.

If only regular unleaded petrol with an octane rating of 91 RON/82.5 MON or lower is available, you must have the vehicle adapted to this fuel at a qualified specialist workshop.

i E10 fuel contains up to 10% bioethanol. Your vehicle is suitable for use with E10 fuel. You can refuel your vehicle using E10 fuel.

Fuel grade (except AMG vehicles)

! Do not use diesel to refuel vehicles with a petrol engine. Do not switch on the ignition if you accidentally refuel with the wrong fuel. Otherwise, fuel can enter the fuel system. Even small amounts of the wrong fuel could result in damage to the fuel system and the engine. Notify a qualified specialist workshop and have the fuel tank and fuel lines drained completely.

! Only refuel using premium-grade unleaded petrol with at least 95 ROZ/85 MOZ, that conforms to European standard EN 228 or E DIN 51626-1 or an equivalent specification.

Fuel of this specification can contain up to 10 % ethanol.

Fuel that does not conform to EN 228 or E DIN 51626-1 can lead to increased wear and damage the engine and exhaust system.

! Only use the fuel recommended. Operating the vehicle with other fuels can lead to engine failure.

! Do not use the following:

- E85 (petrol with 85% ethanol)
- E100 (100% ethanol)
- M15 (petrol with 15% methanol)
- M30 (petrol with 30% methanol)
- M85 (petrol with 85% methanol)
- M100 (100% methanol)
- Petrol with additives containing metal
- Diesel

Do not mix such fuels with the fuel recommended for your vehicle. Do not use additives. This can otherwise lead to engine damage. This does not include cleaning additives for the removal and prevention of residue build-up. Petrol must only be mixed with additives recommended by Mercedes-Benz; see "Additives". You can obtain further information from any Mercedes-Benz Service Centre.

Usually you will find information about the fuel grade on the pump. If you cannot find the label on the petrol pump, ask the filling station staff.

i E10 fuel contains up to 10% bioethanol. Your vehicle is suitable for use with E10 fuel. You can refuel your vehicle using E10 fuel.

i **A 200 BlueEFFICIENCY, A 250 BlueEFFICIENCY:** as a temporary measure, if the

recommended fuel is not available, you may also use unleaded petrol with an octane rating of 93 RON/83 MON.

All other models: as a temporary measure, if the recommended fuel is not available, you may also use unleaded petrol with an octane rating of 91 RON/82 MON. This may reduce engine performance and increase fuel consumption. Avoid driving at full throttle and sudden acceleration. Never refuel using fuel with a lower RON/MON.

- i** In some countries, the available petrol may not be sufficiently low in sulphur. This fuel can temporarily produce unpleasant odours, especially on short journeys. As soon as sulphur-free fuel (sulphur content < 10 ppm) is used for refuelling, the odours are reduced.

Information on refuelling (▷ page 159).

Additives

- !** Operating the engine with fuel additives can cause wear in the fuel high-pressure pump and contaminate the entire fuel system. The repair costs are high. This does not include additives for the removal and prevention of residue build-up. Petrol must only be mixed with additives recommended by Mercedes-Benz. More information about recommended additives can be obtained from any Mercedes-Benz Service Centre.

One of the major problems with low-grade fuel is the creation of carbon deposits during the process of burning fuel. Mercedes-Benz recommends that you use fuel brands that have additives.

If you use fuels without these additives for a longer period of time, there may be a build-up of carbon deposits. These will form especially on the inlet valves and in the combustion chamber.

This could lead to engine running problems, e.g.:

- longer engine warm-up phase
- uneven idle

- engine noise
- misfiring
- loss of power

In areas where petrol with the required additives is not available, carbon deposits can build up. In this case, Mercedes-Benz recommends the use of additives that have been approved for Mercedes-Benz vehicles; see <http://bevo.mercedes-benz.com>.

The quality of the fuel available in some countries may not be sufficient. Residue could build up as a result. In such cases, and in consultation with a Mercedes-Benz Service Centre, the petrol may be mixed with the additive recommended by Mercedes-Benz (part no. A000989254512). You must observe the notes and mixing ratios specified on the container.

Consult a Mercedes-Benz Service Centre to view a list of approved products. Observe the instructions for use in the product description.

Do not mix other fuel additives with fuel. This causes unnecessary costs and could damage the engine.

Diesel (EN 590)

Fuel grade

WARNING

If you mix diesel fuel with petrol, the flash point of this fuel mixture is lower than that of pure diesel fuel. When the engine is running, components in the exhaust system may overheat unnoticed. There is a risk of fire.

Never refuel with petrol. Never add petrol to diesel fuel.

- !** When refuelling, only use diesel fuel that conforms to the European standard EN 590 or is of equivalent quality. Fuel that does not conform to EN 590 can lead to increased wear as well as damage to the engine and exhaust system.

! Do not use the following:

- marine diesel
- heating oil
- bio-diesel
- vegetable oil
- petrol
- paraffin
- kerosene

Do not mix such fuels with diesel fuel and do not use any special additives. This can otherwise lead to engine damage.

! **Vehicles with a diesel particle filter:** in countries outside the EU, only refuel with low-sulphur Euro diesel with a sulphur content under 50 ppm; otherwise the emission control system could be damaged.

! **Vehicles without a diesel particle filter:** in countries where only diesel fuel with a high sulphur content is available, you will need to carry out your vehicle's oil change at shorter intervals. More information about the interval for oil change can be obtained from any qualified specialist workshop.

Usually you will find information about the fuel grade on the pump. If you cannot find the label on the petrol pump, ask the filling station staff.

Information on refuelling (▷ page 159).

Low outside temperatures

In winter months, diesel fuel with an improved cold flow quality is available. In Europe, the EN 590 standard defines various climate-dependent temperature categories. Malfunctions can be avoided by refuelling with diesel fuel that corresponds to the climatic specifications outlined in EN 590. At unusually low outside temperatures, it is possible that the flow characteristics of the diesel fuel could be insufficient. Accordingly, diesel fuel from warmer areas may not be suitable for operation in colder climatic conditions.

i Further information on country-specific fuel properties can be obtained from oil companies, e.g. at filling stations.

Fuel consumption information

Environmental note

CO₂ (carbon dioxide) is the gas which scientists believe to be principally responsible for global warming (the greenhouse effect). Your vehicle's CO₂ emissions are directly related to fuel consumption and therefore depend on:

- efficient use of the fuel by the engine
- driving style
- other non-technical factors, such as environmental influences or road conditions

You can minimise your vehicle's CO₂ emissions by driving carefully and having it serviced regularly.

The vehicle will use more fuel than usual in the following situations:

- at very low outside temperatures
- in urban traffic
- on short journeys
- in mountainous terrain
- when towing a trailer

i Only for certain countries: you can find the current consumption and emission values of your vehicle in the COC documents (EU CERTIFICATE OF CONFORMITY). These documents are delivered with your vehicle.

The consumption figures were in each case based on the currently applicable version:

- for vehicles that comply with standards up to and including the EURO 4 standard, in accordance with EU Directive 80/1268/EEC
- for vehicles that comply with or exceed the EURO 5 standard, in accordance with Regulation (EC) No. 715/2007

Deviations from these values may occur under normal operating conditions.

Engine oil

General notes

When handling engine oil, observe the important safety notes on service products (▷ page 338).

The quality of the engine oil is decisive for the function and service life of an engine. After extensive tests, Mercedes-Benz approves engine oils that correspond to the current technical standard.

Therefore, only Mercedes-Benz approved engine oils may be used in Mercedes-Benz engines.

Further information on tested and approved engine oils can be obtained from any Mercedes-Benz Service Centre. Mercedes-Benz recommends that you have the oil change carried out at a qualified specialist workshop.

Mercedes-Benz approval is indicated on the oil container by the inscription "MB Approval" and the corresponding designation, e.g. MB Approval 229.51.

You can call up an overview of approved engine oils on the Internet at <http://bevo.mercedes-benz.com> by entering the designation, e.g. 229.5.

The table shows which engine oils have been approved for your vehicle.

Missing values were not available at the time of going to print.

Petrol engines	MB Approval
All models	229.5

Diesel engines with a diesel particle filter	MB Approval
A 180 CDI BlueEFFICIENCY, manual transmission	
A 180 CDI BlueEFFICIENCY, automatic transmission	228.51, 229.31, 229.51
A 200 CDI BlueEFFICIENCY	
A 220 CDI BlueEFFICIENCY	

Diesel engines without a diesel particle filter	MB Approval
A 180 CDI BlueEFFICIENCY, manual transmission	
A 180 CDI BlueEFFICIENCY, automatic transmission	228.3, 228.5, 228.51, 229.3, 229.31, 229.5, 229.51
A 200 CDI BlueEFFICIENCY	
A 220 CDI BlueEFFICIENCY	

i If the engine oils listed in the table are not available, you may add the following engine oils until the next oil change:

- vehicles with a petrol engine: MB Approval 229.1 or ACEA A3
- vehicles with a diesel engine: MB Approval 229.1, 229.3, 229.5 or ACEA C3

This may only be added once and the amount must not be greater than 1.0 l.

Capacities

The following values refer to an oil change, including the oil filter.

Model	Replacement amount
A 180 BlueEFFICIENCY A 200 BlueEFFICIENCY	5.8 l
A 250 BlueEFFICIENCY	5.6 l
A 180 CDI BlueEFFICIENCY, manual transmission	4.5 l
A 180 CDI BlueEFFICIENCY, automatic transmission A 200 CDI BlueEFFICIENCY A 220 CDI BlueEFFICIENCY	7.0 l
A 45 AMG 4MATIC	5.5 l

Additives

! Do not use any additives with the engine oil. This could damage the engine.

Engine oil viscosity

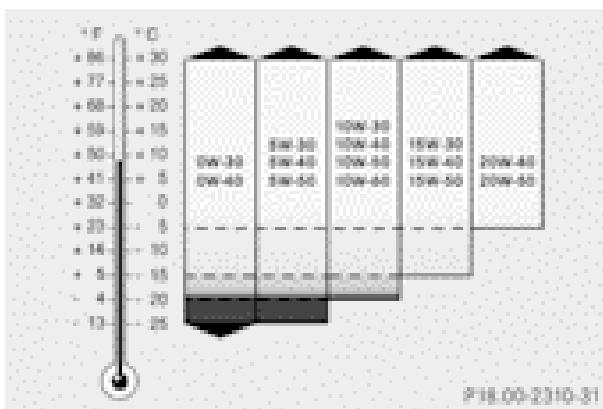

Viscosity describes the flow characteristics of a fluid. If an engine oil has a high viscosity rating, it flows slowly; the lower the viscosity, the faster it flows.

Engine oil selection is based on the respective outside temperatures and in accordance with the SAE classification (viscosity). The table shows you which SAE classifications are to be used. The low-temperature properties of

engine oils can be significantly impaired during operation due to, for example, ageing or soot and fuel accretion. It is therefore strongly recommended to observe regular oil changes using an approved engine oil with the appropriate SAE classification.

Brake fluid

! WARNING

The brake fluid continuously absorbs moisture from the air. This results in the boiling point of the brake fluid lowering. If the boiling point of the brake fluid is too low, vapour pockets may form when the brakes are subjected to a heavy load. This would impair braking efficiency. There is a risk of an accident. Have the brake fluid renewed at the prescribed intervals.

When handling brake fluid, observe the important safety notes on service products (> page 338).

The brake fluid change intervals can be found in the Service Booklet.

Only use brake fluid approved by Mercedes-Benz according to MB Approval 331.0.

Information about approved brake fluid can be obtained at any qualified specialist workshop or on the Internet at:

<http://bevo.mercedes-benz.com>.

i Have the brake fluid regularly replaced at a qualified specialist workshop.

Coolant

Important safety notes

! WARNING

If antifreeze comes into contact with hot components in the engine compartment, it may ignite. There is a risk of fire and injury.

Let the engine cool down before you top up the antifreeze. Make sure that antifreeze is not spilled next to the filler neck. Thoroughly

clean the antifreeze from components before starting the engine.

! Only add coolant that has been premixed with the desired antifreeze protection. You could otherwise damage the engine.

Further information on coolants can be found in the Mercedes-Benz Specifications for Service Products, MB Specifications for Service Products 310.1, e.g. on the Internet at <http://bevo.mercedes-benz.com>. Or contact a qualified specialist workshop.

! Always use a suitable coolant mixture, even in countries where high temperatures prevail.

Otherwise, the engine cooling system is not sufficiently protected from corrosion and overheating.

! The engine cooling system is filled with coolant, which must be renewed after 15 years or after 250,000 kilometres at the latest.

When handling coolant, observe the important safety notes on service products (▷ page 338).

The coolant is a mixture of water and anti-freeze/corrosion inhibitor. It performs the following tasks:

- anti-corrosion protection
- antifreeze protection
- raising the boiling point

If antifreeze/corrosion inhibitor is present in the correct concentration, the boiling point of the coolant during operation will be approximately 130 °C.

The antifreeze/corrosion inhibitor concentration in the engine cooling system should:

- be at least 50%. This will protect the engine cooling system against freezing down to approximately -37 °C.
- not exceed 55% (antifreeze protection down to -45 °C). Heat will otherwise not be dissipated as effectively.

If the vehicle has lost coolant, top it up with equal amounts of water and antifreeze/corrosion inhibitor.

Mercedes-Benz recommends an antifreeze/corrosion inhibitor concentrate in accordance with MB Specifications for Service Products 310.1.

The coolant is checked at every maintenance interval at a qualified specialist workshop.

i When the vehicle is first delivered, it is filled with a coolant mixture that ensures adequate antifreeze and corrosion protection.

Windscreen washer system and headlamp cleaning system

Important safety notes

WARNING

Windscreen washer concentrate is highly flammable. If it comes into contact with hot engine components or the exhaust system it could ignite. There is a risk of fire and injury. Make sure that no windscreen washer concentrate is spilled next to the filler neck.

! Only use washer fluid that is suitable for plastic lamp lenses, e.g. MB SummerFit or MB WinterFit. Unsuitable washer fluid could damage the plastic lenses of the headlamps.

! Do not use distilled or de-ionised water in the washer fluid reservoir. Otherwise, the level sensor may be damaged.

! Only the washer fluids SummerFit and WinterFit can be mixed. Otherwise, the spraying nozzles could become blocked.

When handling washer fluid, observe the important safety notes on service products (▷ page 338).

At temperatures above freezing:

- ▶ Fill the washer fluid reservoir with a mixture of water and washer fluid, e.g. MB SummerFit.

Mix 1 part MB SummerFit to 100 parts water.

At temperatures below freezing:

- ▶ Fill the washer fluid reservoir with a mixture of water and washer fluid, e.g. MB WinterFit.

Adapt the mixing ratio to the outside temperature.

- Down to -10 °C: mix 1 part MB WinterFit to 2 parts water.
- Down to -20 °C: mix 1 part MB WinterFit to 1 part water.
- Down to -29 °C: mix 2 parts MB WinterFit to 1 part water.

- ❗ Add washer fluid concentrate, e.g. MB SummerFit or MB WinterFit, to the washer fluid all year round.

- vehicle-specific weight information can be found on the vehicle identification plate (▷ page 338).
- only for certain countries: you can find vehicle-specific vehicle data in the COC documents (CERTIFICATE OF CONFORMITY) These documents are delivered with your vehicle.

Dimensions and weights



Model	① Maximum headroom	② Opening height
A 180 BlueEFFICIENCY A 180 CDI BlueEFFICIENCY	1856 mm	1975 mm
A 200 BlueEFFICIENCY A 200 CDI BlueEFFICIENCY A 220 CDI BlueEFFICIENCY	1857 mm	1976 mm
A 250 BlueEFFICIENCY	1861 mm	1980 mm
A 45 AMG 4MATIC	1840 mm	1959 mm

Vehicle data

General notes

Please note that for the specified vehicle data:

- the heights specified may vary as a result of:
 - tyres
 - load
 - condition of the suspension
 - optional equipment
- items of optional equipment increase the unladen weight and reduce the maximum payload. The unladen weight is specified in accordance with EC directives and includes:
 - driver (68 kg)
 - luggage (7 kg)
 - all fluids (fuel tank 90% full)

Missing values were not available at the time of going to print.

All models (except AMG vehicles)	
Vehicle length	4292 mm
Vehicle width including exterior mirrors	2022 mm
Vehicle width excluding exterior mirrors	1780 mm
Wheelbase	2699 mm
Maximum roof load	100 kg
Maximum boot load	100 kg

A 180 BlueEFFICIENCY	
Vehicle height	1433 mm
Unladen weight, manual transmission	1370 kg
Unladen weight, automatic transmission	1395 kg

A 200 BlueEFFICIENCY	
Vehicle height	1434 mm
Unladen weight, manual transmission	1370 kg
Unladen weight, automatic transmission	1395 kg

A 250 BlueEFFICIENCY	
Vehicle height	1438 mm
Unladen weight	1445 kg

A 180 CDI BlueEFFICIENCY	
Vehicle height	1433 mm
Unladen weight, manual transmission	1395 kg
Unladen weight, automatic transmission	1475 kg

A 200 CDI BlueEFFICIENCY	
Vehicle height	1434 mm
Unladen weight, manual transmission	1445 kg
Unladen weight, automatic transmission	1475 kg

A 220 CDI BlueEFFICIENCY	
Vehicle height	1434 mm
Unladen weight	

AMG vehicles	
Vehicle length	4395 mm
Vehicle width including exterior mirrors	2022 mm
Vehicle width excluding exterior mirrors	1780 mm
Vehicle height	1417 mm
Wheelbase	2699 mm
Roof load	100 kg
Maximum boot load	100 kg

Trailer tow hitch

Mounting dimensions

! If you have a trailer tow hitch retrofitted, changes to the engine cooling system may be necessary, depending on the vehicle type.

If you have a trailer tow hitch retrofitted, observe the anchorage points on the chassis.

Trailer towing is not permissible on the following models:

- A 45 AMG 4MATIC
- Vehicles with the AMG Sports package

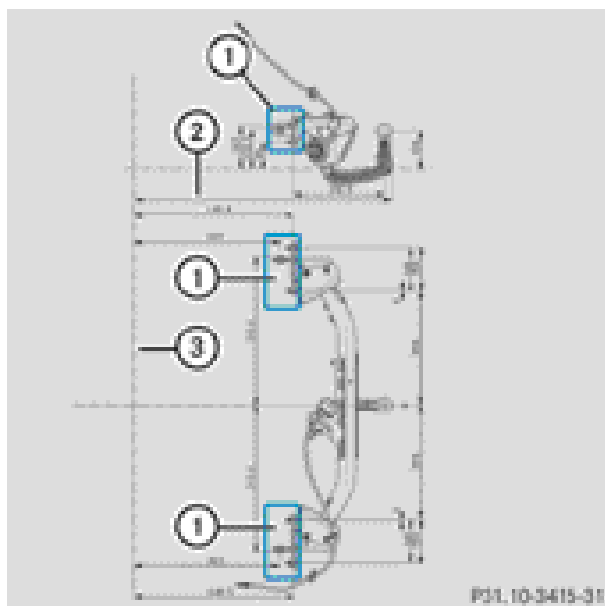

Technical data

Example: anchorage points for the trailer tow hitch

- ① Anchorage points
- ② Overhang dimension
- ③ Rear axle centre line

For trailer tow hitches fitted at the factory, the overhang dimension including protective covering is 794 mm.

Trailer loads

Vehicles with manual transmission

! Use a drawbar noseweight as close as possible to the maximum permissible noseweight. Do not use a noseweight of less than 50kg, otherwise the trailer may come loose.

Note that the payload and the rear axle load are reduced by the actual payload.

	Permissible trailer load, braked ¹⁸	Permissible trailer load, braked ¹⁹	Permissible trailer load, unbraked	Maximum drawbar nose-weight ²⁰	Permissible rear axle load when towing a trailer
A 180²¹	1500 kg	1200 kg	685 kg	75 kg	985 kg
A 200²¹	1500 kg	1400 kg	685 kg	75 kg	980 kg
A 180 CDI²¹	1500 kg	1200 kg	695 kg	75 kg	980 kg
A 200 CDI²¹	1500 kg	1500 kg	720 kg	75 kg	975 kg

The actual noseweight may not be higher than the value which is given. The value can be found on the trailer tow hitch or trailer identification plates. The lowest weight applies.

You can attach carrier systems, e.g. bicycle racks or load-bearing implements, on the ball coupling. The maximum noseweight of 75 kg applies when using carrier systems on the ball coupling.

Vehicles with automatic transmission

! Use a drawbar noseweight as close as possible to the maximum permissible noseweight. Do not use a noseweight of less than 50kg, otherwise the trailer may come loose.

Note that the payload and the rear axle load are reduced by the actual payload.

Trailer towing is not permissible on the following models:

- A 45 AMG 4MATIC
- Vehicles with the AMG Sports package

¹⁸ At a minimum gradient-climbing capability of 8% from a standstill.

¹⁹ At a minimum gradient-climbing capability of 12% from a standstill.

²⁰ The drawbar noseweight is not included in the trailer load.

²¹ BlueEFFICIENCY

	Permissible trailer load, braked ¹⁸	Permissible trailer load, braked ¹⁹	Permissible trailer load, unbraked	Maximum drawbar nose-weight ²⁰	Permissible rear axle load when towing a trailer
A 180²¹	1500 kg	1200 kg	695 kg	75 kg	955 kg
A 200²¹	1500 kg	1400 kg	695 kg	75 kg	950 kg
A 250²¹	1500 kg	1500 kg	720 kg	75 kg	960 kg
A 180 CDI²¹	1500 kg	1200 kg	735 kg	75 kg	950 kg
A 200 CDI²¹	1500 kg	1500 kg	735 kg	75 kg	950 kg
A 220 CDI²¹	1500 kg	1500 kg	740 kg	75 kg	950 kg

The actual noseweight may not be higher than the value which is given. The value can be found on the trailer tow hitch or trailer identification plates. The lowest weight applies.

You can attach carrier systems, e.g. bicycle racks or load-bearing implements, on the ball coupling. The maximum noseweight of 75 kg applies when using carrier systems on the ball coupling.

24 GHz radar sensor system (country overview)

The 24 GHz radar sensor system requires separate approval for each country. When you are driving in a country in which the radar sensor system is not approved, you must deactivate the system using the on-board computer (▷ page 223).

The current country overview can be obtained from a Mercedes-Benz Service Centre or on the Internet at: <http://www.mercedes-benz.de/betriebsanleitung>.

Vehicles with a navigation system: the radar sensor system is deactivated automatically near radio telescope facilities. A display message appears in the multifunction display to tell you that the radar sensor system is being switched off (▷ page 246).

If Blind Spot Assist is active, it will be deactivated automatically (▷ page 219).

If deactivation does not occur automatically, you must deactivate the radar sensor system using the on-board computer (▷ page 223).

Vehicles without navigation and vehicles for Australia: you must deactivate the radar sensor system using the on-board computer when you are near a radio telescope facility (▷ page 223).

¹⁸ At a minimum gradient-climbing capability of 8% from a standstill.

¹⁹ At a minimum gradient-climbing capability of 12% from a standstill.

²⁰ The drawbar noseweight is not included in the trailer load.

²¹ BlueEFFICIENCY

Publication details

Internet

Further information about Mercedes-Benz vehicles and about Daimler AG can be found on the following websites:

<http://www.mercedes-benz.com>

<http://www.daimler.com>

Editorial office

You are welcome to forward any queries or suggestions you may have regarding this Owner's Manual to the technical documentation team at the following address:

Daimler AG, HPC: CAC, Customer Service,
70546 Stuttgart, Germany

©Daimler AG: not to be reprinted, translated or otherwise reproduced, in whole or in part, without written permission from Daimler AG.

As at 13.12.2012



1765841400Z102

Order no. 65155008 02 Part no. 1765841400Z102 Edition NA 2012-09d