

Contents

A-Z

Owner's Manual
for Vehicle



The Ultimate
Driving Machine®



THE BMW X1. OWNER'S MANUAL.

BMW EfficientDynamics
Less emissions. More driving pleasure.

X1 Owner's Manual for Vehicle

Thank you for choosing a BMW.

The more familiar you are with your vehicle, the better control you will have on the road. We therefore strongly suggest:

Read this Owner's Manual before starting off in your new BMW. It contains important information on vehicle operation that will help you make full use of the technical features available in your BMW. The manual also contains information designed to enhance operating reliability and road safety, and to contribute to maintaining the value of your BMW.

Supplementary information can be found in the additional brochures in the onboard literature.

We wish you a safe and enjoyable drive.

BMW AG

© 2015 Bayerische Motoren Werke
Aktiengesellschaft
Munich, Germany
Reprinting, including excerpts, only with the written
consent of BMW AG, Munich.
deutsch II/15, 03 15 500
Printed on environmentally friendly paper, bleached
without chlorine, suitable for recycling.



ADDENDUM TO OWNER'S MANUAL

We wanted to provide you with some updates and clarifications with respect to the printed BMW Owner's Manual. These updates and clarifications will supersede the materials contained in that document.

1. Where the terms “service center,” “the service center,” “your service center,” “service specialist,” or “service” are used in the Owner's Manual, we wanted to clarify that the terms refer to a BMW dealer's service center or another service center or repair shop that employs trained personnel that can perform maintenance and repair work on your vehicle in accordance with BMW specifications.
2. Where the text of the Owner's Manual contains an affirmative instruction to contact a “service center” or “your service center,” we wanted to clarify that BMW recommends that, if you are faced with one of the situations addressed by that text, you contact or seek the assistance of a BMW dealer's service center or another service center or repair shop that employs trained personnel that can perform maintenance and repair work on your vehicle in accordance with BMW specifications.

While BMW of North America LLC, at no cost to you, will pay for repairs required by the limited warranties provided with respect to your vehicle and for maintenance under the Maintenance Program during the applicable warranty and maintenance coverage periods, you are free to elect, both during those periods and thereafter, to have maintenance and repair work provided by other service centers or repair shops.

3. Where the Owner's Manual makes reference to parts and accessories having been approved by BMW, those references are intended to reflect that those parts and accessories are recommended by BMW of North America LLC. You may elect to use other parts and accessories, but, if you do,

we recommend that you make sure that any such parts and/or accessories are appropriate for use on your vehicle.

4. At page 7, under the warranty section's discussion of homologation, where it states that you “cannot lodge warranty claims for your vehicle there,” the text should read that you “may not be able to lodge warranty claims for your vehicle there.”
5. At page 7, under the “Parts and accessories” section, the sentence beginning “For your own safety ...,” should be disregarded and the following text should be read in lieu thereof: “The manufacturer of your vehicle recommends using genuine BMW parts and accessories.” In the fifth sentence, the word “cannot” should read “does not.”
6. At page 49, in the “Checking and replacing safety belts” section, the text beginning, “Have the work performed only by your service center ...” should be disregarded and the following text should be read in lieu thereof: “BMW recommends having this work performed by a service center as it is important that this safety feature functions properly.”
7. At page 134 under the heading: “Objects in the area around the pedals” and at page 266 under the heading: “Carpets and floor mats,” the paragraph that begins: “Only use floor mats ...” should be disregarded and the following language should be read in lieu thereof: “The manufacturer of your vehicle recommends that you use floor mats that have been identified by it as appropriate for use in your vehicle and that can be properly fixed in place.”
8. At page 140, under the heading: “Have maintenance carried out,” the sentence beginning, “Have the maintenance carried out ...” should be disregarded and the following text should be read in lieu thereof:

“BMW recommends that you have the maintenance carried out by your service center.”

9. At page 225, under the heading “Apps” and subheading “Requirements,” the section that begins, “Use only ... ,” should be disregarded and the following text should be read in lieu thereof: “The manufacturer of your vehicle recommends the use of BMW recommended software; otherwise there may be malfunctions in system operations.”

10. At page 232, under the heading “Pressure specifications,” the sentence beginning, “The inflation pressures apply to the tire sizes approved” should be disregarded.

11. At page 240, under the heading: “Approved wheels and tires,” the term “Approved” should be disregarded and in lieu thereof, the term “Recommended” should be read in its place. In addition, the text of that section should be disregarded and the following text should be read in lieu thereof:

The manufacturer of your vehicle strongly suggests that you use wheels and tires that have been recommended by the vehicle manufacturer for your vehicle type; otherwise, for example, despite having the same official size ratings, variations can lead to body contact and with it, the risk of severe accidents.

The manufacturer of your vehicle does not evaluate non-recommended wheels and tires to determine if they are suitable for use on your vehicle.

12. At page 243, under the heading “Hood,” the sentence beginning, “If you are unfamiliar” should be disregarded.

13. At page 248, under the heading: “Service and Warranty Information Booklet for US models and Warranty and Service Guide Booklet for Canadian models,” the second paragraph should be disregarded and the following text read in lieu thereof:

The manufacturer of your vehicle recommends that you have maintenance and repair performed by your BMW dealer's service center or another service center or repair shop that employs trained personnel that can perform maintenance and repair work on your vehicle in accordance with BMW specifications. The manufacturer of your vehicle recommends that you maintain records of all maintenance and repair work performed on your vehicle.

14. At page 250 and page 252, where it reads: “Do not perform work/bulb replacement on xenon headlamps,” that text should be disregarded and in lieu thereof the following text should be read: “Xenon headlamp work or replacement can cause serious and fatal injuries.” In the text that follows, where it reads: “[h]ave any work on the xenon lighting system ... ,” the following words should be read as preceding that passage: “It is strongly suggested that you”

15. At page 255, under the “Battery replacement” section, the text should be disregarded and in lieu thereof the following text should be read:

Use of recommended vehicle batteries

The manufacturer of your vehicle recommends that you use vehicle batteries that it has tested and recommends for use in your vehicle; otherwise the vehicle could be damaged and systems or functions may not be fully available.

After a battery replacement, the manufacturer of your vehicle recommends that you have the battery registered on your vehicle by a service center to ensure that all comfort functions are fully available, and that any “check control” messages of these comfort functions are no longer displayed.

Contents

The fastest way to find information on a particular topic or item is by using the index, refer to page [280](#).

[6](#) Notes

At a glance

[14](#) Cockpit
[20](#) iDrive
[27](#) Voice activation system

Controls

[32](#) Opening and closing
[46](#) Adjusting
[54](#) Transporting children safely
[59](#) Driving
[73](#) Displays
[85](#) Lamps
[90](#) Safety
[99](#) Driving stability control systems
[103](#) Driving comfort
[110](#) Climate
[115](#) Interior equipment
[125](#) Storage compartments

Driving tips

[132](#) Things to remember when driving
[136](#) Loading
[139](#) Saving fuel

Navigation

[144](#) Navigation system
[146](#) Destination entry
[155](#) Destination guidance
[163](#) What to do if...

Entertainment

[166](#) Tone
[168](#) Radio
[176](#) CD/multimedia

Communication

[198](#) Telephone
[209](#) Office
[218](#) Contacts
[221](#) ConnectedDrive

Mobility

[228](#) Refueling
[230](#) Fuel
[232](#) Wheels and tires
[242](#) Engine compartment
[247](#) Maintenance
[249](#) Replacing components
[257](#) Breakdown assistance
[263](#) Care

Reference

[270](#) Technical data
[272](#) Short commands for voice activation system
[280](#) Everything from A to Z

Notes

Using this Owner's Manual

The fastest way to find information on a particular topic is by using the index.

An initial overview of the vehicle is provided in the first chapter.

Additional sources of information

Should you have any questions, your service center will be glad to advise you at any time.

Information on BMW, e.g., on technology, is available on the Internet: www.bmwusa.com.

BMW Driver's Guide App

The Owner's Manual is available in many countries as an app. Additional information on the Internet:

www.bmw.com/bmw_drivers_guide

Symbols

 Indicates precautions that must be followed precisely in order to avoid the possibility of personal injury and serious damage to the vehicle.

◀ Marks the end of a specific item of information.

"..." Identifies display texts in vehicle used to select individual functions.

›...‹ Verbal instructions to use with the voice activation system.

›...‹ Identifies the answers generated by the voice activation system.

 Refers to measures that can be taken to help protect the environment.

Symbols on vehicle components

 Indicates that you should consult the relevant section of this Owner's Manual for information on a particular part or assembly.

Vehicle equipment

This Owner's Manual describes all models, all series equipment, as well as country-specific and special equipment offered in the model series. Therefore, this Owner's Manual also describes and depicts equipment that may not be contained in your vehicle because of the selected special equipment or country version, for example.

This also applies to safety-related functions and systems.

For options and equipment not described in this Owner's Manual, please refer to the Supplementary Owner's Manuals.

On right-hand drive vehicles, some controls are arranged differently than shown in the illustrations.

Status of this Owner's Manual at time of printing

The manufacturer of your vehicle pursues a policy of constant development that is conceived to ensure that our vehicles continue to embody the highest quality and safety standards. In rare cases, therefore, the features described in this Owner's Manual may differ from those in your vehicle.

Updates made after the editorial deadline

Any updates made after the editorial deadline for the Owner's Manuals are located in the appendix of the printed quick reference for the vehicle.

For your own safety

Warranty

Your vehicle is technically configured for the operating conditions and registration requirements applying in the country of first delivery — homologation. If your vehicle is to be operated in a different country it might be necessary to adapt your vehicle to potentially differing operating conditions and permit requirements. If your vehicle does not comply with the homologation requirements in a certain country you cannot lodge warranty claims for your vehicle there. Further information can be obtained from your Service Center.

Maintenance and repairs

Advanced technology, e.g., the use of modern materials and high-performance electronics, requires suitable maintenance and repair methods.

Therefore, have this work performed only by a BMW center or a workshop that works according to BMW repair procedures with appropriately trained personnel.

If this work is not carried out properly, there is the danger of subsequent damage and related safety hazards.

Parts and accessories

For your own safety, it is recommended that you use genuine parts and accessories approved by BMW. When you purchase accessories tested and approved by BMW and Genuine BMW Parts, you simultaneously acquire the assurance that they have been thoroughly tested by BMW to ensure optimum performance when installed on your vehicle. BMW warrants these parts to be free from defects in material and workmanship. BMW will not accept any liability for damage resulting from installation of parts and accessories not approved by BMW. BMW cannot test every product made by other manufacturers to verify if it can be used on a BMW safely and without

risk to either the vehicle, its operation, or its occupants. Genuine BMW Parts, BMW Accessories and other products approved by BMW, together with professional advice on using these items, are available from all BMW centers. Installation and operation of non BMW approved accessories such as alarms, radios, amplifiers, radar detectors, wheels, suspension components, brake dust shields, telephones, including operation of any mobile phone from within the vehicle without using an externally mounted antenna, or transceiver equipment, for instance, CBs, walkie-talkies, ham radios or similar accessories, may cause extensive damage to the vehicle, compromise its safety, interfere with the vehicle's electrical system or affect the validity of the BMW Limited Warranty. See your BMW center for additional information. Maintenance, replacement, or repair of the emission control devices and systems may be performed by any automotive repair establishment or individual using any certified automotive part.

California Proposition 65 Warning

California laws require us to state the following warning:

Engine exhaust and a wide variety of automobile components and parts, including components found in the interior furnishings in a vehicle, contain or emit chemicals known to the State of California to cause cancer and birth defects and reproductive harm. In addition, certain fluids contained in vehicles and certain products of component wear contain or emit chemicals known to the State of California to cause cancer and birth defects or other reproductive harm. Battery posts, terminals and related accessories contain lead and lead compounds. Wash your hands after handling. Used engine oil contains chemicals that have caused cancer in laboratory animals. Always protect your skin by washing thoroughly with soap and water.

Service and warranty

We recommend that you read this publication thoroughly. Your vehicle is covered by the following warranties:

- ▷ New Vehicle Limited Warranty
- ▷ Rust Perforation Limited Warranty
- ▷ Federal Emissions System Defect Warranty
- ▷ Federal Emissions Performance Warranty
- ▷ California Emission Control System Limited Warranty

Detailed information about these warranties is listed in the Service and Warranty Information Booklet for US models or in the Warranty and Service Guide Booklet for Canadian models.

Your vehicle has been specifically adapted and designed to meet the particular operating conditions and homologation requirements in your country and continental region in order to deliver the full driving pleasure while the vehicle is operated under those conditions. If you wish to operate your vehicle in another country or region, you may be required to adapt your vehicle to meet different prevailing operating conditions and homologation requirements. You should also be aware of any applicable warranty limitations or exclusions for such country or region. In such case, please contact Customer Relations for further information.

Maintenance

Maintain the vehicle regularly to sustain the road safety, operational reliability and the New Vehicle Limited Warranty.

Specifications for required maintenance measures:

- ▷ BMW Maintenance system
- ▷ Service and Warranty Information Booklet for US models
- ▷ Warranty and Service Guide Booklet for Canadian models

If the vehicle is not maintained according to these specifications, this could result in seri-

ous damage to the vehicle. Such damage is not covered by the BMW New Vehicle Limited Warranty.

Data memory

Numerous electronic components in your vehicle contain data memories that store technical information on the vehicle condition, events and faults, either temporarily or permanently. This technical information generally documents the state of a component, a module, a system or the environment.

- ▷ Operating conditions of system components, such as filling levels.
- ▷ Status messages from the vehicle and its individual components, such as wheel rpm/speed, motion delay, transverse acceleration.
- ▷ Malfunctions and defects in important system components, such as lights and brakes.
- ▷ Vehicle responses to special driving situations, such as airbag deployment, use of the stability control systems.
- ▷ Ambient conditions, such as the temperature.

These data are of a technical nature only and are used to detect and eliminate faults and to optimize vehicle functions. Travel profiles of routes driven with the vehicle cannot be created from these data. If services are used, for instance in the event of repairs, service processes, warranty cases, quality assurance, etc., this technical information can be read out from the event and fault data memories by service personnel, including the manufacturer, using special diagnosis tools. This service personnel can provide you with more information if needed. After troubleshooting, the information in the fault memory is cleared or overwritten continuously.

Situations are conceivable during the use of the vehicle in which these technical data could

become associated with a specific person in combination with other information, such as an accident report, damage to the vehicle, witness accounts, etc., possibly with the involvement of an authorized expert.

Additional functions that are contractually agreed with the customer, such as vehicle localization in the event of an emergency, permit the transfer of certain vehicle data out of the vehicle.

Event Data Recorder EDR

This vehicle is equipped with an event data recorder EDR. The main purpose of an EDR is to record, in certain crash or near crash-like situations, such as an air bag deployment or hitting a road obstacle, data that will assist in understanding how a vehicle's systems performed. The EDR is designed to record data related to vehicle dynamics and safety systems for a short period of time, typically 30 seconds or less.

The EDR in this vehicle is designed to record such data as:

- ▶ How various systems in your vehicle were operating.
- ▶ Whether or not the driver and passenger safety belts were fastened.
- ▶ How far, if at all, the driver was depressing the accelerator and/or brake pedal.
- ▶ How fast the vehicle was traveling.

These data can help provide a better understanding of the circumstances in which crashes and injuries occur.

EDR data are recorded by your vehicle only if a nontrivial crash situation occurs; no data are recorded by the EDR under normal driving conditions and no personal data, e.g., name, gender, age, and crash location, are recorded.

However, other parties, such as law enforcement, could combine the EDR data with the

type of personally identifying data routinely acquired during a crash investigation.

To read data recorded by an EDR, special equipment is required, and access to the vehicle or the EDR is needed. In addition to the vehicle manufacturer, other parties, such as law enforcement, that have the special equipment, can read the information if they have access to the vehicle or the EDR.

Reporting safety defects

For US customers

The following only applies to vehicles owned and operated in the US.

If you believe that your vehicle has a defect which could cause a crash or could cause injury or death, you should immediately inform the National Highway Traffic Safety Administration NHTSA, in addition to notifying BMW of North America, LLC, P.O. Box 1227, Westwood, New Jersey 07675-1227, Telephone 1-800-831-1117.

If NHTSA receives similar complaints, it may open an investigation, and if it finds that a safety defect exists in a group of vehicles, it may order a recall and remedy campaign.

However, NHTSA cannot become involved in individual problems between you, your dealer, or BMW of North America, LLC.

To contact NHTSA, you may call the Vehicle Safety Hotline toll-free at 1-888-327-4236 (TTY: 1-800-424-9153); go to <http://www.safercar.gov>; or write to: Administrator, NHTSA, 400 Seventh Street, SW., Washington, DC 20590. You can also obtain other information about motor vehicle safety from <http://www.safercar.gov>

For Canadian customers

Canadian customers who wish to report a safety-related defect to Transport Canada, Defect Investigations and Recalls, may tele-

phone the toll-free hotline 1-800-333-0510.
You can also obtain other information about
motor vehicle safety from <http://www.tc.gc.ca/roadsafety>.





At a glance

These overviews of buttons, switches and displays are intended to familiarize you with your vehicle. You will also become quickly acquainted with the available control concepts and options.

Cockpit

Vehicle equipment

This chapter describes all series equipment as well as country-specific and special equipment offered for this model series. Therefore, it also describes equipment that may not be found in your vehicle, for instance due to the selected

special equipment or the country version. This also applies to safety-related functions and systems.

When using the features and systems described here, adhere to local regulations.

All around the steering wheel

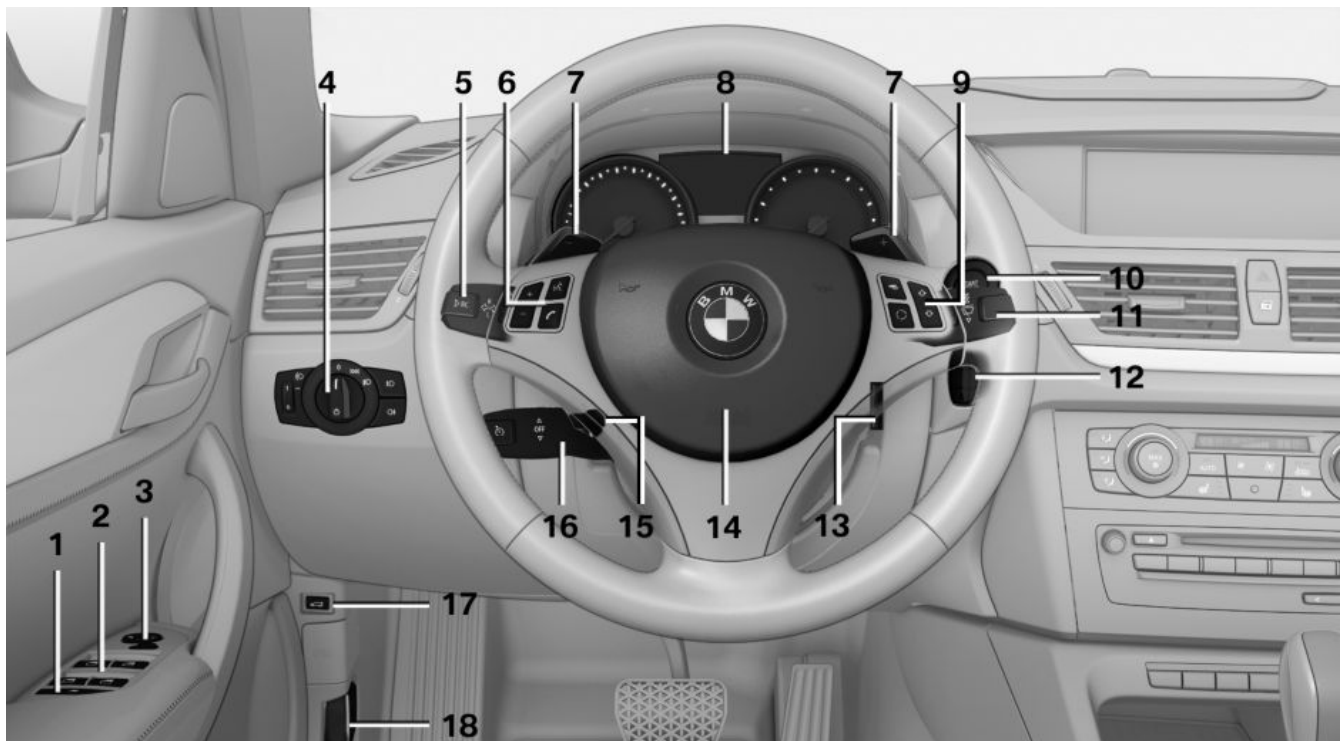

1 Safety switch for rear power windows [43](#)

2 Power windows [42](#)

3 Exterior mirror operation [51](#)

4 Lamps



Parking lights [85](#)



Low beams [85](#)



Automatic headlight control [86](#)



























Adaptive Light Control [86](#)

High-beam Assistant [87](#)



Front fog lamps [88](#)

5 Steering column stalk, left

- | | | | |
|---|--|---|---|
|  | Turn signal 64 |  | Change the radio station
Select a music track |
|  | High-beams, head-light flasher 87 |  | Scroll through the radial list |
|  | High-beam Assistant 87 |  | Next entertainment source |
|  | Roadside parking lights 87 |  | Recirculated air mode 112 |
|  | Computer 75 |  | 10 Start/stop the engine and switch the ignition on/off 59 |
|  | Settings and information about the vehicle 76 |  | 11 Steering column stalk, right |
|  | Instrument lighting 89 |  | Windshield wipers 64 |
| 6 Steering wheel buttons, left | |  | Rain sensor 65 |
|  | Telephone 198 |  | Rear window wiper 66 |
|  | Volume |  | 12 Ignition lock 59 |
|  | Activate/deactivate the voice activation system 27 |  | 13 Steering wheel heating 53 |
| 7 Shift paddles 69 | |  | 14 Horn, the entire surface |
| 8 Instrument cluster 16 | |  | 15 Adjust the steering wheel 53 |
| 9 Steering wheel buttons, right | |  | 16 Cruise control 103 |
| | |  | 17 Opening tailgate 38 |
| | |  | 18 Releasing the hood 243 |

Instrument cluster

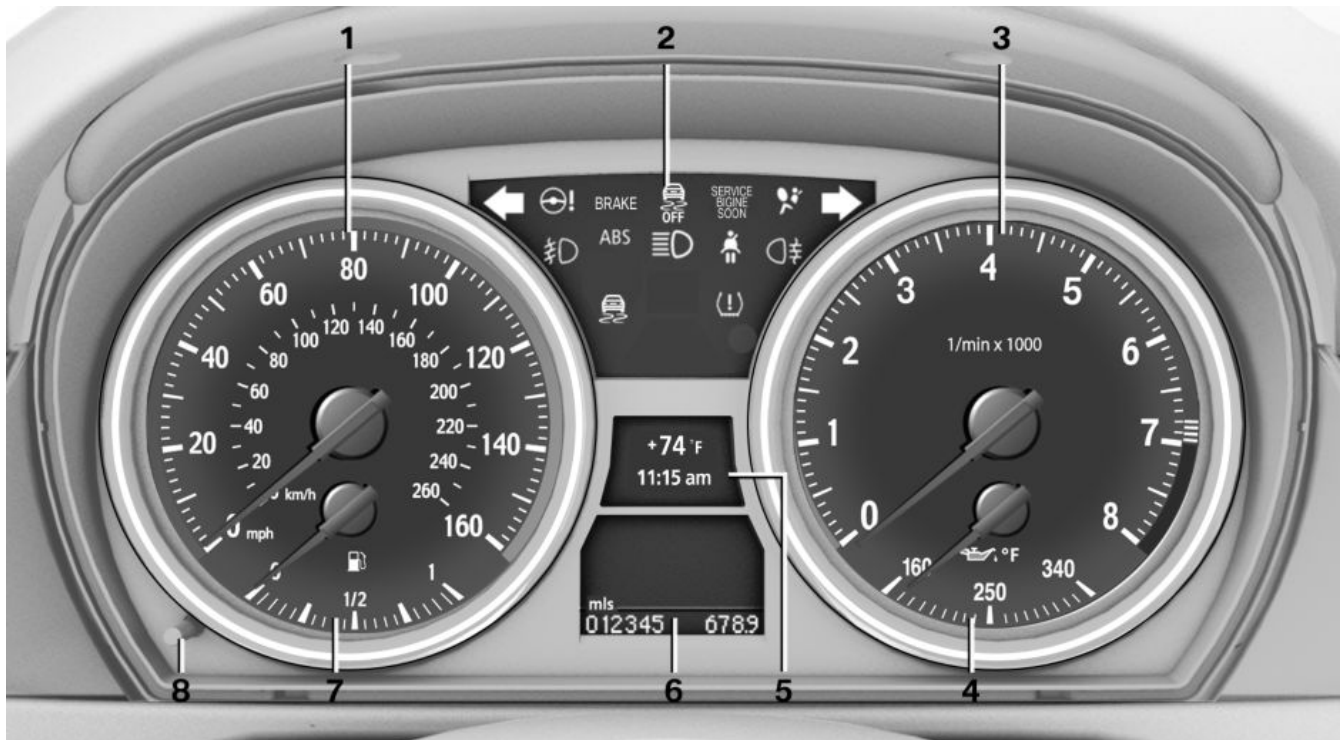

- 1 Speedometer
- 2 Indicator/warning lamps [17](#)
- 3 Tachometer [74](#)
- 4 Current fuel consumption [74](#)
Engine oil temperature [74](#)
- 5 Display for
 - ▷ Clock [73](#)
 - ▷ External temperature [73](#)
 - ▷ Indicator/warning lamps [17](#)
 - ▷ Cruise control [103](#)
- 6 Display for
 - ▷ Automatic transmission position [68](#)
- 7 Fuel gauge [74](#)
- 8 Resetting the trip odometer [73](#)
- ▷ Hill Descent Control [101](#)
- ▷ Computer [75](#)
- ▷ Date of next scheduled service, and remaining distance to be driven [80](#)
- ▷ Odometer and trip odometer [73](#)
- ▷ Resetting Tire Pressure Monitor [96](#)
- ▷ Checking engine oil level [243](#)
- ▷ Settings and information [76](#)
- ▷ **▲** Check Control message present [82](#)

Indicator/warning lights

The concept



The indicator and warning lights can light up in a variety of combinations and colors.

Several of the lights are checked for proper functioning when the engine is started or the ignition is switched on, and light up briefly.

Text messages

Text messages at the upper edge of the Control Display explain the meaning of the displayed indicator and warning lights.



Supplementary text messages







You can call up additional information, e.g., on the cause of a malfunction and on how to respond, via Check Control, refer to page 82.

In urgent cases, this information will be shown as soon as the corresponding light comes on.

Indicator lights without text messages





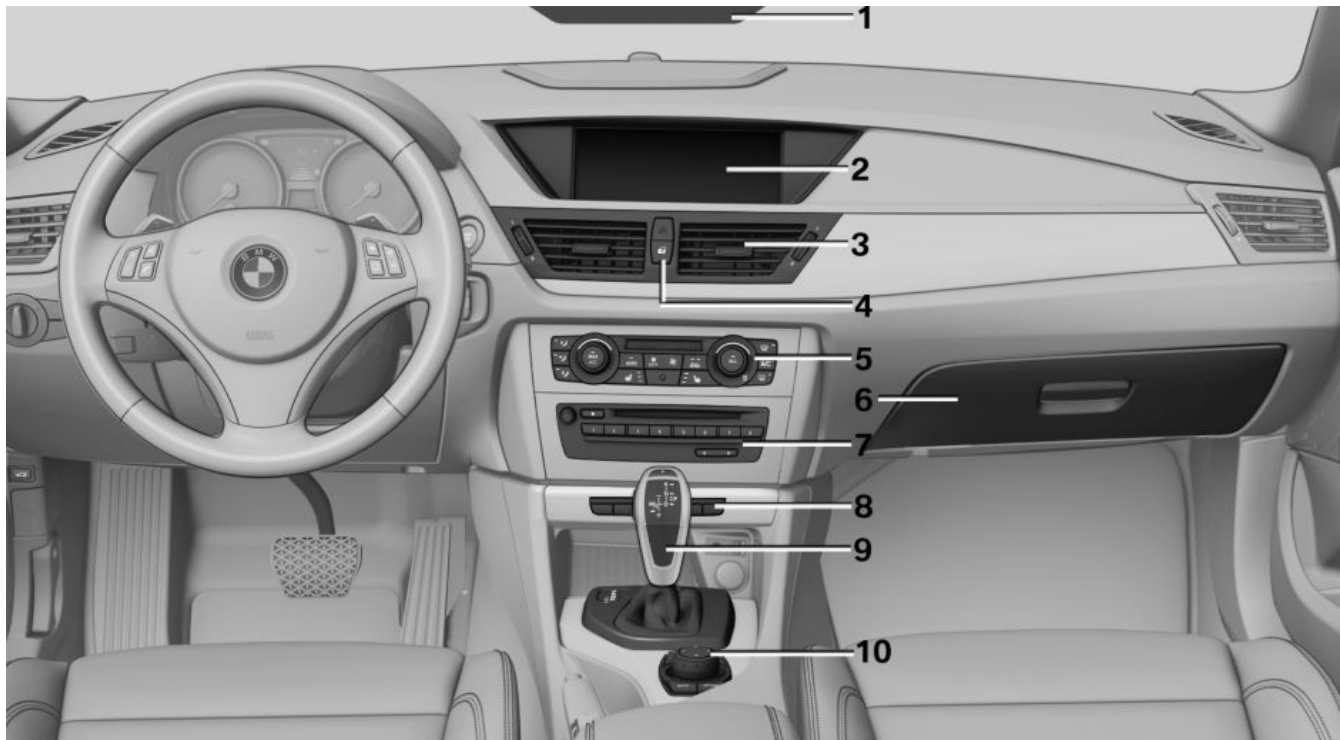

The following indicator lamps notify you that certain functions are active:

Symbol	Function or system
	Turn signals, refer to page 64
	High-beams/headlamp flasher, refer to page 87

Symbol	Function or system
	Front fog lamps, refer to page 88
	Lamp flashes: DSC or DTC is regulating the propulsive forces in order to maintain driving stability, refer to page 99
	The parking brake is set, refer to page 63
	Canada: the parking brake is set, refer to page 63
	Engine malfunction with adverse effect on emissions, refer to page 248
	Canada: engine malfunction with adverse effect on exhaust emissions, refer to page 248





All around the center console



- | | | | | |
|---|---|-----|---|--|
| 1 | Headliner | 19 | | |
| 2 | Control Display | 20 | | |
| 3 | Air vent | 113 | | |
| 4 |  Hazard warning system | 257 |  | Deactivate the Automatic Engine Start/Stop Function 61 |
| |  Central locking system | 37 |  | DSC Dynamic Stability Control 99 |
| | | | | DTC Dynamic Traction Control 100 |
| | | |  | ECO PRO 140 |
| 5 | Automatic climate control | 110 | | |
| 6 | Glove compartment | 125 | | |
| 7 | Radio and CD/DVD drive | 168 | | |
| | Programmable memory buttons | 24 | | |
| 8 |  PDC Park Distance Control | 105 | | 9 Selector lever with automatic transmission 67 |
| | rearview camera | 107 | | |
| |  HDC Hill Descent Control | 101 | | 10 Controller with buttons 20 |

All around the headliner



- | | | | | | |
|---|---|---|---|---|-----------------------------------|
| 1 |  | Emergency Request 257 | 4 |  | Reading lamps 89 |
| 2 |  | Panoramic glass sunroof 44 | 5 |  | Interior lamps 89 |
| 3 |  | Indicator lamp for the front passenger airbags 92 | | | |

iDrive

Vehicle equipment

This chapter describes all series equipment as well as country-specific and special equipment offered for this model series. Therefore, it also describes equipment that may not be found in your vehicle, for instance due to the selected special equipment or the country version. This also applies to safety-related functions and systems.

When using the features and systems described here, adhere to local regulations.

The concept

The iDrive combines the functions of a multitude of switches. Thus, these functions can be operated from a central location.

 Using the iDrive during a trip
To avoid becoming distracted and posing an unnecessary hazard to your vehicle's occupants and to other road users, never attempt to use the controls or enter information unless traffic and road conditions allow this. ◀

Controls at a glance

Controls



- 1 Control Display
- 2 Controller with buttons

The buttons can be used to open the menu directly. The controller can be used to select menu items and create the settings.

Control Display

Notes

- ▶ To clean the Control Display, follow the care instructions, refer to page 266.
- ▶ Do not place objects close to the Control Display; otherwise, the Control Display can be damaged.

Switching off

1.  Press the button.
2. "Switch off control display"

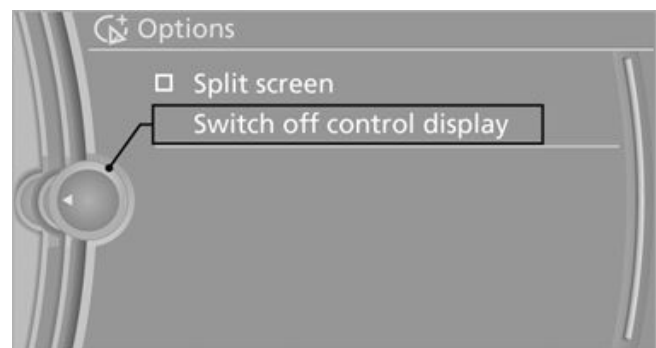

Switching on

Press the controller again to switch the screen back on.

Controller

Select menu items and create settings.

1. Turn.

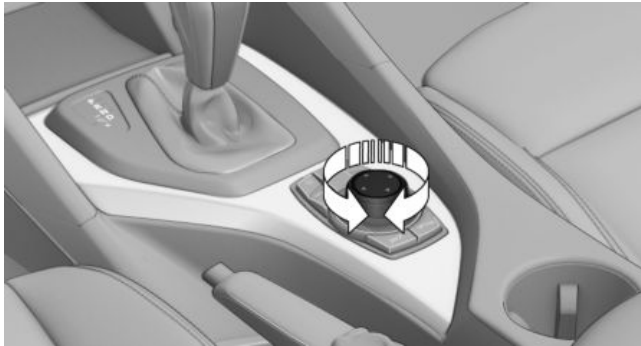

2. Press.



3. Move in four directions.

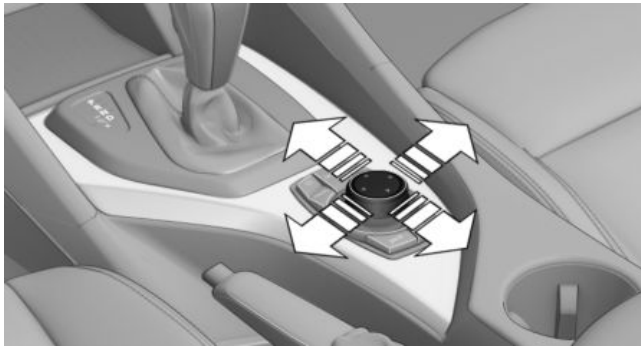

Buttons on controller

Press the button	Function
MENU	Opens the main menu.
RADIO	Opens the Radio menu.
MEDIA	Opens the CD/Multimedia menu.

Press the button	Function
NAV	Opens the Navigation menu.
TEL	Opens the Telephone menu.
BACK	Displays the previous panel.
OPTION	Opens the Options menu.

Operating concept

Opening the main menu

 Press the button.

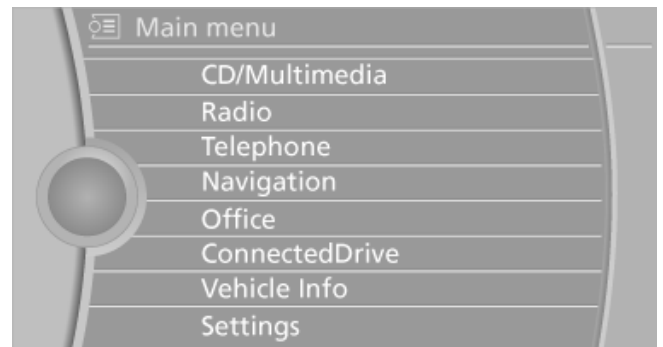

The main menu is displayed.

All iDrive functions can be called up via the main menu.

Selecting menu items

Menu items shown in white can be selected.

1. Turn the controller until the desired menu item is highlighted.

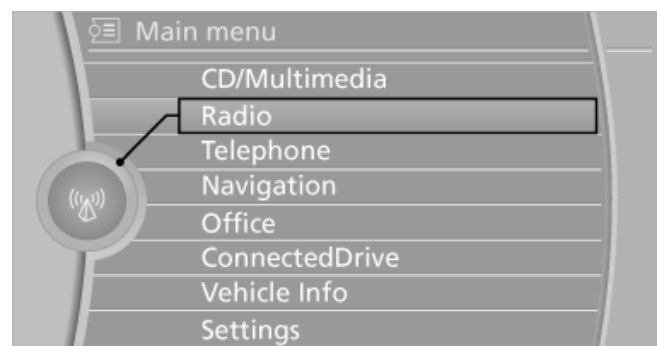

2. Press the controller.

Menu items in the Owner's Manual

In the Owner's Manual, menu items that can be selected are set in quotation marks, e.g., "Settings".

Changing between panels

After a menu item is selected, e.g., "Radio", a new panel is displayed. Panels can overlap.

- ▶ Move the controller to the left.

The current panel is closed and the previous panel is displayed.

The previous panel is opened again by pressing the BACK button. In this case, the current panel is not closed.
- ▶ Move the controller to the right.

A new panel is opened on top of the previous display.

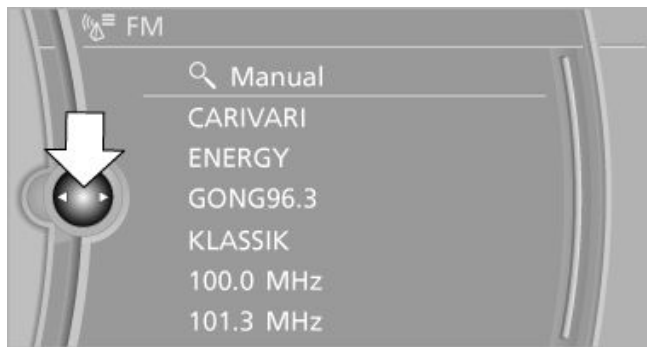

White arrows pointing to the left or right indicate that additional panels can be opened.

View of an opened menu

When a menu is opened, it generally opens with the panel that was last selected in that menu. To display the first panel of a menu:

- ▶ Move the controller to the left repeatedly until the first panel is displayed.
- ▶ Press the menu button on the controller twice.

Opening the Options menu



Press the button.

The "Options" menu is displayed.



Additional options: move the controller to the right repeatedly until the "Options" menu is displayed.

Options menu

The "Options" menu consists of various areas:

- ▶ Screen settings, e.g., "Switch off control display".
- ▶ Control options for the selected main menu, e.g., for "Radio".
- ▶ If applicable, further operating options for the selected menu, for instance "Store station".

Changing settings

1. Select a field.
2. Turn the controller until the desired setting is displayed.

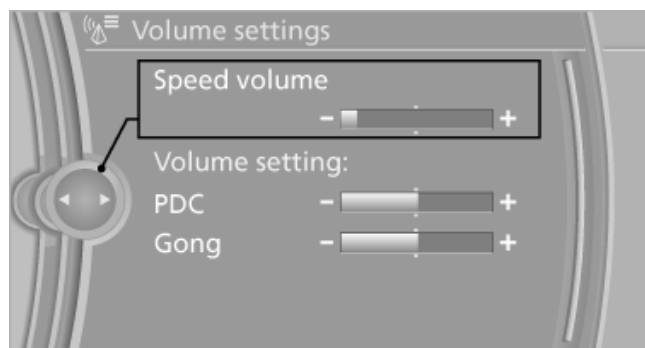

3. Press the controller.

Activating/deactivating the functions

Several menu items are preceded by a check-box. It indicates whether the function is activated or deactivated. Selecting the menu item activates or deactivates the function.

- Function is activated.
- The function is deactivated.

Example: setting the clock

Setting the clock

1.  Press the button. The main menu is displayed.
2. Turn the controller until "Settings" is highlighted, and then press the controller.

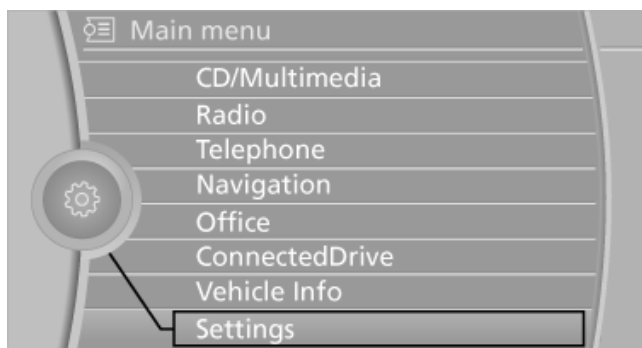

3. If necessary, move the controller to the left to display "Time/Date".
4. Turn the controller until "Time/Date" is highlighted, and then press the controller.



5. Turn the controller until "Time:" is highlighted, and then press the controller.



6. Turn the controller to set the hours and press the controller.
7. Turn the controller to set the minutes and press the controller.

Status information

Status field



The following information is displayed in the status field at the top right:

- ▷ Time.
- ▷ Current entertainment source.
- ▷ Sound output, on/off.
- ▷ Wireless network reception strength.
- ▷ Telephone status.
- ▷ Traffic bulletin reception.











Status field symbols

The symbols are grouped into various categories.







Radio symbols

Symbol	Meaning
	HD Radio™ is switched on.
	Satellite radio is switched on.



Telephone symbols

Symbol	Meaning
	Incoming or outgoing call.
	Missed call.
	Wireless network reception strength Symbol flashes: searching for network.
	Wireless network is not available.
	Bluetooth is switched on.
	Roaming is active.
	Text message, e-mail was received.
	Check the SIM card.
	SIM card is blocked.
	SIM card is missing.
	Enter the PIN.

Entertainment symbols

Symbol	Meaning
	CD/DVD player.
	Music collection.
	Gracenote® database.
	AUX-IN port.
	USB audio interface.
	Music interface for smartphones.

Additional symbols

Symbol	Meaning
	Spoken instructions are switched off.
	Request of the current vehicle position.

Split screen

General information

Additional information can be displayed on the right side of the split screen, e.g., information from the computer.

In the divided screen view, the so-called split screen, this information remains visible even when you change to another menu.

Switching the split screen on and off

-  Press the button.
- "Split screen"

Selecting the display

-  Press the button.
- "Split screen"
- Move the controller until the split screen is selected.
- Press the controller or select "Split screen content".
- Select the desired menu item.

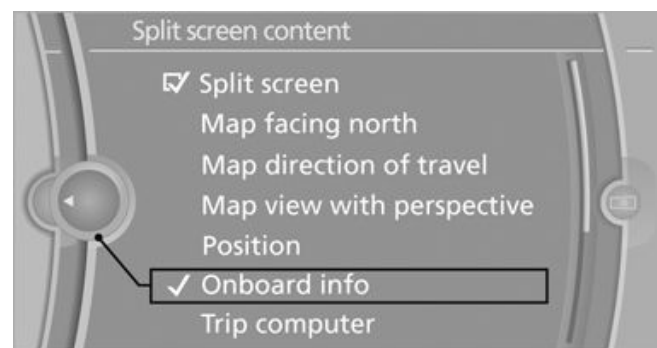

Programmable memory buttons

General information

The iDrive functions can be stored on the programmable memory buttons and called up directly, e.g., radio stations, navigation destina-

tions, phone numbers and entry points into the menu.

The settings are stored for the remote control currently in use.

Saving a function

1. Highlight the function via the iDrive.

2.  Press the desired button for more than two seconds.

Running a function

 Press the button.

The function will run immediately. This means, for example, that the number is dialed when a phone number is selected.

Displaying the button assignment

Use a finger to touch the buttons. Do not wear gloves or use objects.

The key assignment is displayed at the top edge of the screen.



- ▶ To display short information: touch the button.
- ▶ To display detailed information: touch the button for an extended period.

Entering letters and numbers

1. Turn the controller: select letters or numbers.

2. Select additional letters or numbers if needed.
3. "OK": confirm the entry.

Symbol	Function
←	Press the controller: delete the letter or number.
←	Press the controller for an extended period: delete all letters or numbers.
□	Enter a blank space.

Switching between letters and numbers

Depending on the menu, you can switch between entering letters and numbers.

Symbol	Function
A ^B C	Enter the letters.
1@+	Enter the numbers.

Switching between upper and lower case letters

Depending on the menu, you can switch between entering uppercase and lowercase letters.

Symbol	Function
▲ abc	Move the controller forward: switch from upper to lower case letters.
▲ ABC	Move the controller forward: switch from lower to upper case letters.

Entry comparison

Entry of names and addresses: the selection is narrowed down every time a letter is entered and letters may be added automatically.

The entries are continuously compared to the data stored in the vehicle.

- ▷ Only those letters are offered during the entry for which data is available.
- ▷ Destination search: town/city names can be entered using the spelling of language available on the Control Display.

Voice activation system

Vehicle equipment

This chapter describes all series equipment as well as country-specific and special equipment offered for this model series. Therefore, it also describes equipment that may not be found in your vehicle, for instance due to the selected special equipment or the country version. This also applies to safety-related functions and systems.

When using the features and systems described here, adhere to local regulations.

The concept

- ▶ Most functions that are displayed on the Control Display can be operated with the voice activation system using spoken commands. The system prompts you to make your entries.
- ▶ Functions that can only be used when the vehicle is stationary cannot be operated using the voice activation system.
- ▶ The system uses a special microphone located in the area of the interior rearview mirror.
- ▶ ›...‹ Verbal instructions in the Owner's Manual to use with the voice activation system.

Requirements

Via the Control Display, set a language that is also supported by the voice activation system so that the spoken commands can be identified.

Set the language, refer to page 79.

Using voice activation

Activating the voice activation system

1.  Press the button on the steering wheel.
2. Wait for the signal.
3. Say the command.
The command appears on the Control Display.

 The symbol on the Control Display indicates that the voice activation system is active. If no other commands are available, operate the function via iDrive in this case.

Terminating the voice activation system

 Briefly press the button on the steering wheel or ›Cancel‹.

Possible commands

Most menu items on the Control Display can be voiced as commands.

The available commands depend on the menu that is currently displayed on the Control Display.

The functions of the main menu have short commands.

Some list items, such as the phone book entries, can also be selected via the voice activation system. Say the list items exactly as they are displayed on the list.

Having possible commands read aloud

You can have the system read possible commands aloud: ›Voice commands‹.

For example, if the "Settings" menu is displayed, the commands for the settings are read out loud.

Executing functions using short commands

Functions on the main menu can be performed directly by means of short commands, usually irrespective of which menu item is currently selected, for instance ›Vehicle status‹.

List of short commands of the voice activation system, refer to page 272.

Help dialog for the voice activation system

Calling up help dialog: ›Help‹

Additional commands for the help dialog:

- ▶ ›Help with examples‹: information about the current operating options and the most important commands for them are announced.
- ▶ ›Help with voice activation‹: information about the principle of operation for the voice activation system is announced.

Example: playing back a CD

Via the main menu

The commands of the menu items are spoken out loud, in the same way as they are selected via the controller.

1. Switch on the Entertainment sound output if necessary.
2.  Press the button on the steering wheel.
3. ›C D and multimedia‹
The medium last played is played back.
4. ›C D‹
5. ›C D drive‹
The CD is played back.

6.  Press the button on the steering wheel again to select a specific track.

7. ›Track ...‹ e.g., CD track 4.

Via short commands

Playback of the CD can also be started using a short command.

1. Switch on the Entertainment sound output if necessary.

2.  Press the button on the steering wheel.

3. ›C D drive Track ...‹ e.g., CD track 4.

Setting the voice dialog

You can set whether the system should use the standard dialog or a shorter version.

In the shorter variant of the voice dialog, the announcements from the system are issued in an abbreviated form.

On the Control Display:

1. "Settings"
2. "Language/Units"
3. "Speech mode:"
4. Select the setting.

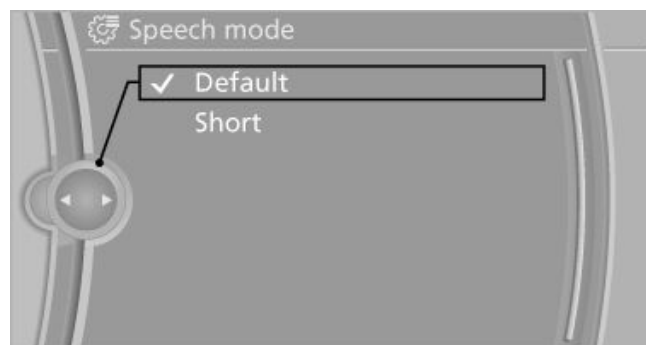

Adjusting the volume

Turn the volume button during the spoken instructions until the desired volume is set.

- ▷ The volume remains constant even if the volume of other audio sources is changed.
- ▷ The volume is stored for the remote control currently in use.

Notes on Emergency Requests

Do not use the voice activation system to initiate an Emergency Request. In stressful situations, the voice and vocal pitch can change. This can unnecessarily delay the establishment of a telephone connection.

Instead, use the SOS button, refer to page 257, in the vicinity of the interior mirror.

Environmental conditions

- ▷ Say the commands, numbers, and letters smoothly and with normal volume, emphasis, and speed.
- ▷ Always say commands in the language of the voice activation system.
- ▷ Keep the doors, windows, and glass sunroof closed to prevent noise interference.
- ▷ Avoid making other noise in the vehicle while speaking.



Controls

This chapter is intended to provide you with information that will give you complete control of your vehicle. All features and accessories that are useful for driving and your safety, comfort and convenience are described here.

Opening and closing

Vehicle equipment

This chapter describes all series equipment as well as country-specific and special equipment offered for this model series. Therefore, it also describes equipment that may not be found in your vehicle, for instance due to the selected special equipment or the country version. This also applies to safety-related functions and systems.

When using the features and systems described here, adhere to local regulations.

Remote control/key

Buttons on the remote control

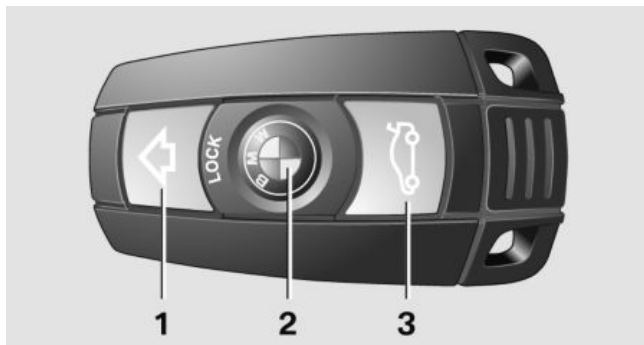

- 1 Unlocking
- 2 Locking
- 3 Opening tailgate

General information

The vehicle is supplied with two remote controls with keys.

Each remote control contains a rechargeable battery that is automatically recharged when it is in the ignition lock while the car is being driven. Use each remote control at least twice a year for longer road trips in order to maintain the batteries' charge status.

In vehicles equipped with Comfort Access, the remote control contains a replaceable battery, refer to page 41.

The settings called up and implemented when the vehicle is unlocked depend on which remote control is used to unlock the vehicle, refer to Personal Profile.

In addition, information about service requirements is stored in the remote control, Service data in the remote control, refer to page 247.

Integrated key

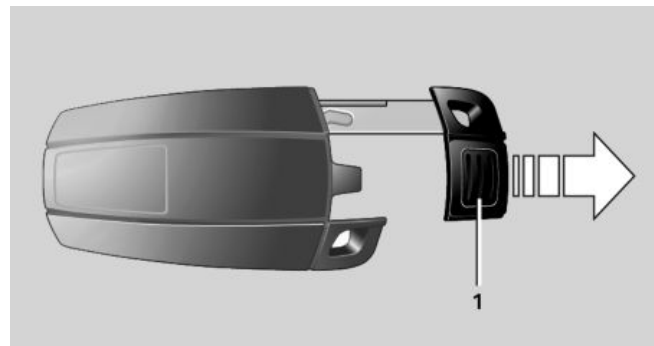

Press button 1 and pull out the key.

The integrated key fits the following locks:

- ▶ Driver's door, refer to page 36.

New remote controls

You can obtain new remote controls from your service center.

Loss of the remote controls

Lost remote controls can be blocked by your service center.

Personal Profile

The concept

You can set several of your vehicle's functions to suit your personal needs and preferences.

- ▶ The settings are automatically saved in the profile currently activated in the remote control.
- ▶ The remote control used is detected when the vehicle is unlocked and the stored profile is called up.
- ▶ Your personal settings will be recognized and called up again even if the vehicle has been used in the meantime by someone else with another remote control.

The individual settings are stored for a maximum of four remote controls. They are stored for two remote controls if Comfort Access is in use.

Personal Profile settings

The following functions and settings can be stored in a profile.

More information on the settings can be found under:

- ▶ Assigning the programmable memory buttons, refer to page 24.
- ▶ Response of the central locking system when the car is being unlocked, refer to page 34.
- ▶ Automatic locking of the vehicle, refer to page 37.
- ▶ Automatic call-up of the driver's seat position after unlocking, refer to page 35.
- ▶ Settings for the display on the Control Display and in the instrument cluster:
 - ▶ 12h/24h clock format, refer to page 78.
 - ▶ Date format, refer to page 79.
 - ▶ Brightness of the Control Display, refer to page 80.
 - ▶ Language on the Control Display, refer to page 79.
 - ▶ Units of measure for fuel consumption, distance covered/remaining distances, and temperature, refer to page 77.
- ▶ Show visual warning for the Park Distance Control PDC, refer to page 106.
- ▶ rearview camera:
 - ▶ Function selection, refer to page 107.
 - ▶ Type of display, refer to page 109.
- ▶ Light settings:
 - ▶ Triple turn signal activation, refer to page 64.
 - ▶ Welcome lights, refer to page 85.
 - ▶ Headlight courtesy delay feature, refer to page 86.
 - ▶ Daytime running lights, refer to page 86.
 - ▶ High-beam Assistant, refer to page 87.
- ▶ Automatic climate control: AUTO program, cooling function and automatic recirculated air control activated/deactivated, temperature, air flow rate and distribution, refer to page 110.
- ▶ Navigation:
 - ▶ Voice activation, refer to page 157.
 - ▶ Route criteria, refer to page 155.
 - ▶ Map view settings, refer to page 159.
- ▶ Entertainment:
 - ▶ Tone control, refer to page 166.
 - ▶ Radio, stored stations, refer to page 174.
 - ▶ CD/multimedia, audio source listened to last, refer to page 176.
- ▶ Telephone: volume, refer to page 202.

Central locking system

The concept

The central locking system becomes active when the driver's door is closed.

The system simultaneously engages and releases the locks on the following:

- ▷ Doors.
- ▷ Tailgate.
- ▷ Fuel filler flap.

Operating from the outside

- ▷ Via the remote control.
- ▷ In cars with Comfort Access, via the door handles on the driver's and front passenger sides.

The following takes place simultaneously when locking/unlocking the vehicle via the remote control:

- ▷ The welcome lamps, interior lamps and courtesy lamps are switched on and off.
- ▷ The alarm system is armed or disarmed, refer to page 41.

Operating from the inside

Via the button for the central locking system, refer to page 37.

If the vehicle is locked from the inside, the fuel filler flap remains unlocked.

If an accident of a certain severity occurs, the central locking system unlocks automatically.

The hazard warning system and interior lamps come on.

Opening and closing: from the outside

Using the remote control

General information



Take the remote control with you

People or animals left unattended in a parked vehicle can lock the doors from the inside. Always take the remote control with you when leaving the vehicle so that the vehicle can then be opened from the outside. ◀



Unlocking

 Press the button. The vehicle is unlocked. The welcome lamps, interior lamps, and courtesy lamps are switched on.

You can set how the vehicle is to be unlocked. The setting is stored for the remote control currently in use.

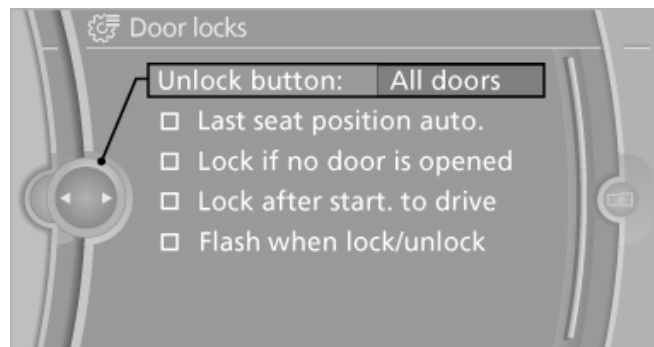
1. "Settings"
2. "Door locks"
3. "Unlock button:"



4. Select the desired function:
 - ▷ "All doors"
 -  The entire vehicle is unlocked.
 - ▷ "Driver's door only"
 -  Only the driver's door and the fuel filler flap are unlocked. Pressing again unlocks the entire vehicle.

Convenient opening

 Press and hold the button on the remote control.

The windows and the panoramic glass sunroof open.

Locking

 LOCK Press the button on the remote control.



Locking from the outside

Do not lock the vehicle from the outside if there are people in it, as the vehicle cannot be unlocked from inside without special knowledge. ◀

Switching on the interior lamps and courtesy lamps

 LOCK Press the button on the remote control with the vehicle locked.

Panic mode

You can trigger the alarm system if you find yourself in a dangerous situation.

 Press the button on the remote control for at least 3 seconds.

To switch off the alarm: press any button.

Unlocking tailgate

 Press the button on the remote control for approx. 1 second and release.

The tailgate will open slightly, regardless of whether it was previously locked or unlocked.

The tailgate pivots back and up when it opens.

Ensure that adequate clearance is available before opening.

To avoid locking yourself out of the vehicle, do not place the remote control into the cargo area. The tailgate is locked again as soon as it is pushed closed.

Before and after each trip, check that the tailgate has not been inadvertently unlocked.

Confirmation signals from the vehicle

1. "Settings"
2. "Door locks"

3. "Flash when lock/unlock"

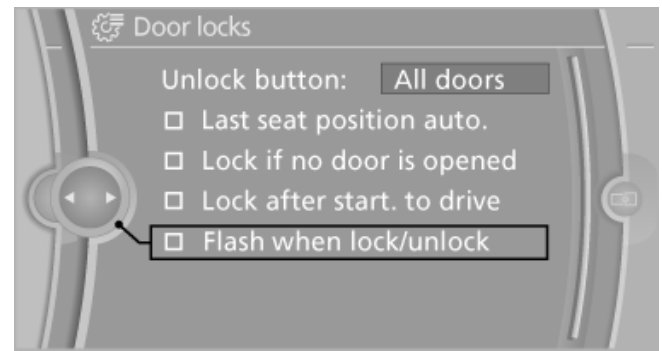

Retrieving the seat and mirror settings

The driver's seat and exterior mirror positions used last are stored for the remote control currently in use.

When the vehicle is being unlocked, these positions are automatically retrieved if the setting is activated.



Pinch hazard when moving back the seat

If this function is used, first make sure that the footwell behind the driver's seat is empty. Failure to do so could cause injury to persons or damage to objects behind the seat as a result of a rearward movement of the seat. ◀

The adjustment procedure is interrupted:

- ▶ When a seat position switch is pressed.
- ▶ When a button of the seat and mirror memory is pressed.

Selecting automatic activation

1. "Settings"
2. "Door locks"

3. "Last seat position auto."

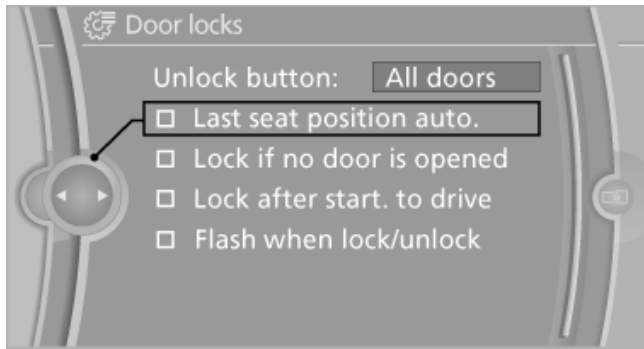

Malfunctions

Local radio waves may interfere with the remote control.

In this case, unlock and lock the car at the door lock with the integrated key.

If the car can no longer be locked with a remote control, the battery in the remote control is discharged. Use the remote control during an extended drive in order to recharge the battery, refer to page 32.

The remote control for Comfort Access contains a battery that may need to be replaced, refer to page 41.

For US owners only

The transmitter and receiver units comply with part 15 of the FCC/Federal Communication Commission regulations. Operation is governed by the following:

FCC ID:

LX8766S

LX8766E

LX8CAS

Compliance statement:

This device complies with part 15 of the FCC Rules. Operation is subject to the following two conditions:

- ▶ This device may not cause harmful interference, and

- ▶ this device must accept any interference received, including interference that may cause undesired operation.

Any unauthorized modifications or changes to these devices could void the user's authority to operate this equipment.

Using the door lock

General information

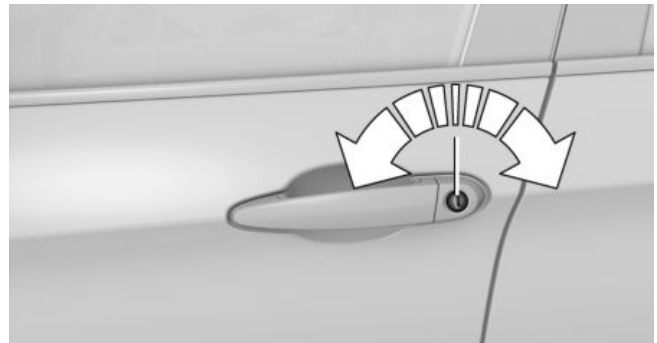

Locking from the outside

Do not lock the vehicle from the outside if there are people in it, as the vehicle cannot be unlocked from inside without special knowledge. ◀

The alarm system, refer to page 41, is not deployed when the vehicle is locked with the integrated key. The alarm system is triggered when the door is opened if the vehicle was unlocked via the door lock.

To stop the alarm, unlock the vehicle with the remote control or insert the remote control into the ignition lock all the way.

Only the driver's door can be locked via the door lock.

Locking the doors, the fuel filler flap, and the tailgate all at once

To lock all doors, the fuel filler flap, and the tailgate at once:

1. With the doors closed, lock the vehicle using the button for the central locking system in the interior, refer to page 37.

2. Unlock and open the driver's or front passenger door, refer to page 37.
3. Lock the vehicle as follows:
 - ▶ Press down the lock button of the front passenger door and close the door from the outside.
 - ▶ Lock the driver's door using the integrated key in the door lock.

Manual operation

If an electrical malfunction occurs, unlock or lock the driver's door using the integrated key in the door lock. The other doors must be unlocked or locked from the inside.

Opening and closing: from the inside



Locking and unlocking



Press the button in the vehicle.

The doors and the tailgate are locked or unlocked when the front doors are closed, but they are not secured against theft.

The fuel filler flap remains unlocked.

Automatic locking

The setting is stored for the remote control currently in use.

1. "Settings"
2. "Door locks"
3. Select the desired function:

- ▶ "Lock if no door is opened"
The vehicle locks automatically after a short period of time if a door is not opened.
- ▶ "Lock after start. to drive"
The vehicle locks automatically after you drive away.

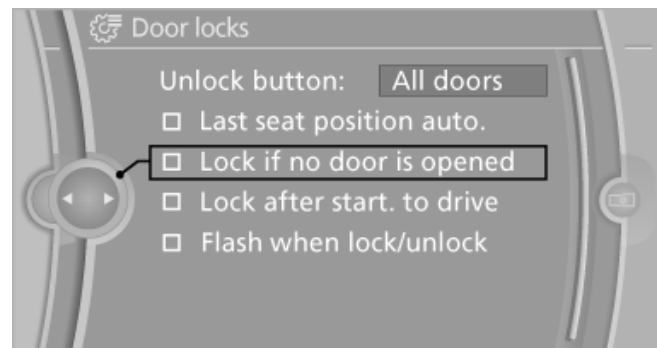

Unlocking and opening

- ▶  Press the button. The doors are unlocked. To open, pull the door handle above the armrest.
- ▶ Pull the door handle above the armrest twice: the door is unlocked the first time and opened the second time.

Locking

- ▶  Press the button. The doors are locked.
- ▶ Press the lock button of a door. To prevent you from being locked out, the opened driver's door cannot be locked using the lock button.



Take the remote control with you
People or animals left unattended in a parked vehicle can lock the doors from the inside. Always take the remote control with you when leaving the vehicle so that the vehicle can then be opened from the outside. ◀

Tailgate

Opening

The tailgate pivots back and up when it opens.

Ensure that adequate clearance is available before opening.



Provide edge protection

Sharp or angular objects can hit the rear window while driving and damage the heating wires of the rear window. Provide edge protection. ◀

Opening from the inside

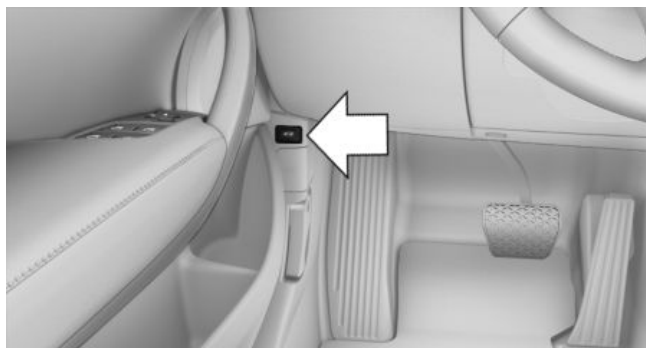

Press the button.

The tailgate is opened if the vehicle is stationary, provided that the tailgate has not been locked.

In some market-specific versions, this button does not exist.

Opening from the outside



▶ Press the button next to the tailgate.

▶  Press the remote control button for approx. 1 second and then release.

The tailgate opens slightly. It can be swung upward.

Opening manually

In case of an electrical malfunction:

1. Fold down the rear seat backrest, enlarge the cargo area, refer to page 121.
2. From the cargo area, press out the handle in the tailgate, see arrow, and pull out as far as possible. The tailgate is unlocked.



3. Open the tailgate from the outside and press in the handle.

The tailgate is locked again as soon as it is closed.

Closing



Recessed grips on the inside trim of the tailgate can be used to conveniently pull down the tailgate.

Before closing the tailgate, ensure that the cargo area floor panel is not raised, refer to page 123.



Keep the closing area clear

Make sure that the closing area of the tailgate is clear; otherwise, injuries or damage may result. ◀

Comfort Access

The concept

The vehicle can be accessed without activating the remote control.

All you need to do is to have the remote control with you, e.g., in your jacket pocket.

The vehicle automatically detects the remote control when it is nearby or in the passenger compartment.

Comfort Access supports the following functions:

- ▶ Unlocking/locking of the vehicle.
- ▶ Unlocking of the tailgate separately.
- ▶ Starting the engine.
- ▶ Convenient closing.

Functional requirement

- ▶ To lock the vehicle, the remote control must be located outside of the vehicle.
- ▶ The next unlocking and locking cycle is not possible until after approx. 2 seconds.
- ▶ The engine can only be started if the remote control is inside the vehicle.

Comparison with ordinary remote control

The functions can be controlled by pressing the buttons or via Comfort Access.

Unlocking

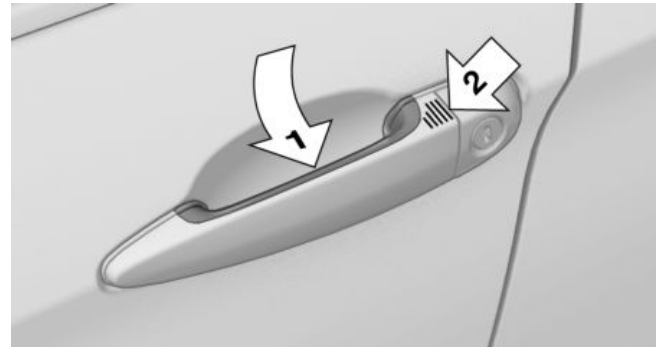

Grasp the handle on the driver's or front passenger door completely, arrow 1.

This corresponds to pressing the  button.

Locking

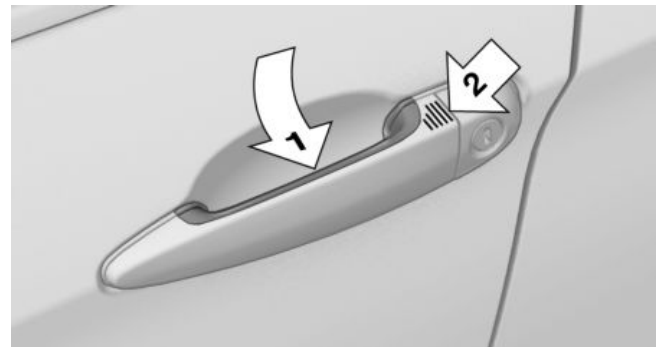

Touch the area on the door handle, arrow 2, with your finger for approx. 1 second.

This corresponds to pressing the  LOCK button.

To save battery power, ensure that the ignition and all electronic systems and/or power consumers are switched off before locking the vehicle.

If a remote control is detected within the vehicle, the vehicle does not lock or is unlocked again.

Convenient closing

Press the area, arrow 2, with your finger and hold.

In addition, the windows and the panoramic glass sunroof close.



Monitor the closing process

Watch during the closing process to be sure that no one is injured. Removing the hand from the door handle immediately stops the closing process. ◀

Unlocking the tailgate separately

Press the button on the exterior of the tailgate.

This corresponds to pressing the  button.

If a remote control accidentally left in the cargo area is detected in the locked vehicle, the tailgate opens again.

Ignition on

Pressing the Start/Stop button switches the ignition on.

When doing so, do not depress the brake pedal, otherwise the engine will start.

Starting the engine

The engine can be started or the ignition can be switched on when a remote control is inside the vehicle. It is not necessary to insert a remote control into the ignition lock, refer to page 59.

Switching off the engine in cars with automatic transmission

The engine can only be switched off with transmission position P engaged, refer to page 61.

To switch the engine off with transmission position N engaged, insert the remote control in the ignition lock.

Malfunction

The Comfort Access functions can be disturbed by local radio waves, such as by a mobile phone in the immediate vicinity of the remote control or when a mobile phone is being charged in the vehicle.

If this occurs, open or close the vehicle using the buttons on the remote control or use the integrated key in the door lock.

Mechanical activation using the integrated key only locks/unlocks the driver's door.

To start the engine afterward, insert the remote control into the ignition switch.

Warning lights



The warning light in the instrument cluster lights up when you attempt to start the engine: the engine cannot be started.

The remote control is not in the vehicle or has a malfunction. Take the remote control with you inside the vehicle or have it checked. If necessary, insert another remote control into the ignition switch.



The warning lamp in the instrument cluster lights up while the engine is running: the remote control is no longer inside the vehicle.

After switching off the engine, the engine can only be started again within approx. 10 seconds if no door has been opened.



The indicator lamp in the instrument cluster comes on and a message appears on the Control Display: replace the remote control battery.

Replacing the battery

The remote control for Comfort Access contains a battery that will need to be replaced from time to time.

1. Take the integrated key out of the remote control, refer to page 32.
2. Remove the cover.



3. Insert a new battery of the same type with the positive side facing upwards.
4. Press on the cover to close it.



Return used battery to a recycling center or to your service center.

Alarm system

The concept

The vehicle alarm system responds to:

- ▷ Opening of a door, the hood or the tailgate.
- ▷ Movements in the vehicle: interior motion sensor, refer to page 42.
- ▷ Changes in the vehicle tilt, e.g., during attempts to steal a wheel or tow the car.
- ▷ Interruptions in battery voltage.

The alarm system briefly indicates tampering:

- ▷ By sounding an acoustic alarm.
- ▷ By switching on the hazard warning system.
- ▷ By flashing the high beams.

Arming and disarming the alarm system

General information

When you lock or unlock the vehicle, either with the remote control or via Comfort Access, the alarm system is armed or disarmed at the same time.

Door lock and armed alarm system

The alarm system is triggered when the door is opened if the vehicle was unlocked via the door lock.

To stop this alarm, unlock the vehicle with the remote control or insert the remote control into the ignition lock all the way and switch on the ignition.

Tailgate and armed alarm system

The tailgate can be opened using the remote control, even if the alarm system is armed.



Press the button on the remote control.

After the tailgate is closed, it is locked and monitored again by the alarm system. The hazard warning system flashes once.

In some market-specific versions, the tailgate can only be opened using the remote control if the vehicle was unlocked first.

Switching off the alarm

- ▷ Unlock the vehicle using the remote control, refer to page 34.
- ▷ Insert the remote control all the way into the ignition lock.

Indicator lamp on the interior rearview mirror



- ▶ The indicator lamp flashes briefly every 2 seconds:
The system is armed.
- ▶ The indicator lamp flashes after locking:
The doors, hood or tailgate is not closed properly, but the rest of the vehicle is secured.
The indicator lamp flashes continuously after approx. 10 seconds. The interior motion sensor is not active.
- ▶ The indicator lamp goes out after unlocking:
The vehicle has not been tampered with.
- ▶ If the indicator lamp flashes after unlocking until the remote control is inserted in the ignition, but for no longer than approx. 5 minutes:
An alarm has been triggered.

Panic mode

In dangerous situations, trigger the alarm system:

 Press the button on the remote control for at least 3 seconds.

To switch off the alarm: press any button.

Tilt alarm sensor

The tilt of the vehicle is monitored.

The alarm system responds in situations such as attempts to steal a wheel or tow the car.

Interior motion sensor

For the sensor to function properly, the windows and panoramic glass sunroof must be closed.

Avoiding unintentional alarms

The tilt alarm sensor and interior motion sensor can be switched off together, such as in the following situations:

- ▶ In duplex garages.
- ▶ During transport on car-carrying trains, at sea or on a trailer.
- ▶ When animals are to remain in the vehicle.

Switching off the tilt alarm sensor and interior motion sensor

 **LOCK** Press the remote control button again within 10 seconds after the vehicle is locked.

The indicator lamp lights up for approx. 2 seconds and then flashes continuously.

The tilt alarm sensor and interior motion sensor remain switched off until the vehicle is locked again.



Power windows

General information



-  Take the remote control with you
- Take the remote control with you when leaving the vehicle so that children, for example, cannot operate the power windows and injure themselves. ◀



Opening

- ▶  Press the switch to the resistance point.
The window opens while the switch is held.
- ▶  Press the switch beyond the resistance point.
The window opens automatically.
Pressing again stops the motion.

Closing

-  **Danger of pinching**
Monitor the closing process and make sure that the closing path of the window is clear; otherwise, injuries may result. ◀
- ▶  Pull the switch to the resistance point.
The window closes while the switch is held.
- ▶  Pull the switch beyond the resistance point.
The window closes automatically.
Pressing the switch stops the motion.
Convenient operation via the remote control, refer to page 34.
Convenient operation via the door lock is not supported.
Convenient closing, refer to page 39, with Comfort Access.

After the ignition is switched off

When the remote control is removed or the ignition is switched off, the windows can continue to be operated for approx. 1 minute as long as no door is opened.

Pinch protection system

If the closing force exceeds a specific value as a window closes, the closing action is interrupted.

The window reopens slightly.

-  **Danger of pinching even with pinch protection**

Even with the pinch protection system, check that the window's closing path is clear; otherwise, the closing action may not stop in certain situations, e.g., if thin objects are present. ◀

-  **Do not use window accessories**
Do not install any accessories in the range of movement of the windows; otherwise, the pinch protection system will be impaired. ◀

Closing without the pinch protection system

For example, if there is an external danger or if ice on the windows prevents a window from closing normally, proceed as follows:

1. Pull the switch past the resistance point and hold it there.
Pinch protection is limited and the window reopens slightly if the closing force exceeds a certain value.
2. Pull the switch past the resistance point again within approx. 4 seconds and hold it there.
The window closes without pinch protection.

Safety switch

With the safety switch, the rear windows are prevented from being opened or closed via the switches in the rear passenger area, such as by children.

-  Press the button.

The LED lights up if the safety function is switched on.



Safety switch for rear operation

Press the safety switch when transporting children in the rear; otherwise, injury may result if the windows are closed without supervision. ◀

Panoramic glass sunroof

General information

The glass sunroof and the sliding visor can be operated together or separately using the switch.



Danger of pinching

Monitor the closing process and make sure that the closing path of the glass sunroof is clear; otherwise, injuries may result. ◀



Take the remote control with you

Take the remote control with you when leaving the vehicle so that children, for example, cannot operate the roof and injure themselves. ◀



Tilting the glass sunroof



Press the switch briefly.

- ▶ The closed roof is tilted and the sliding visor opens slightly.
- ▶ The opened roof closes until it is in its tilted position. The sliding visor stays completely open.

Pressing the switch again closes the sliding visor almost completely.



Do not use force to close the sliding visor

Do not use force to close the sliding visor with the glass sunroof in its tilted position, otherwise the mechanism will be damaged. ◀

Opening/closing the sliding visor



- ▶ Press the switch in the desired direction to the resistance point and hold it there.

The sliding visor moves while the switch is being held.

- ▶ Press the switch in the desired direction past the resistance point.

The sliding visor moves automatically. Pressing the switch again stops the motion.

Opening/closing the glass sunroof

With the sliding visor open, proceed as described under Sliding visor.

Opening/closing the glass sunroof and sliding visor together

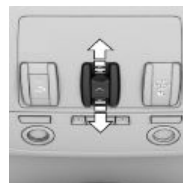

Press the switch twice in the desired direction past the resistance point.

The glass sunroof and sliding visor move together. Pressing the switch again stops the motion.

Convenient operation, refer to page 34, via the remote control or the door lock.

Convenient closing, refer to page 39, with Comfort Access.

Comfort position

In the comfort position, the roof is not fully open. This reduces wind noise in the passenger compartment.

Each time the glass sunroof is opened or closed all the way, it stops in the comfort position. If desired, continue the motion following this with the switch.

After the ignition is switched off

The roof can still be operated for approx. 1 minute, as long as no door has been opened.

Pinch protection system

If the closing force when closing the glass sunroof exceeds a certain value, the closing movement is stopped, beginning at approximately the middle of the opening in the roof, or from the tilted position during closing.

The glass sunroof opens again slightly.



Danger of pinching even with pinch protection

Despite the pinch protection system, check that the roof's closing path is clear; otherwise, the closing action may not be interrupted in certain extreme situations, such as when thin objects are present. ◀

Closing without the pinch protection system

For example, if there is an external danger, proceed as follows:

1. Press the switch forward beyond the resistance point and hold.
Pinch protection is limited and the roof re-opens slightly if the closing force exceeds a certain value.
2. Press the switch forward again beyond the resistance point and hold until the roof closes without pinch protection.

Initialization after a power failure

After a power failure, it may only be possible to tilt the roof.

Have the system initialized by your service center.

Adjusting

Vehicle equipment

This chapter describes all series equipment as well as country-specific and special equipment offered for this model series. Therefore, it also describes equipment that may not be found in your vehicle, for instance due to the selected special equipment or the country version. This also applies to safety-related functions and systems.

When using the features and systems described here, adhere to local regulations.

Sitting safely

The ideal seating position can make a vital contribution to relaxed, fatigue-free driving.

The seating position plays an important role in an accident in combination with:

- ▷ Safety belts, refer to page 48.
- ▷ Head restraints, refer to page 49.
- ▷ Airbags, refer to page 90.

Seats

Note before adjusting

 Do not adjust the seat while driving. Never attempt to adjust the driver's seat while driving. The seat could respond with unexpected movement and the ensuing loss of vehicle control could lead to an accident. ◀

 Do not incline the backrest too far to the rear.

Do not incline the backrest on the front passenger side too far to the rear during driving. Otherwise, there is the danger of sliding under the safety belt in an accident. This would elimi-

nate the protection normally provided by the belt. ◀

Adjusting manually

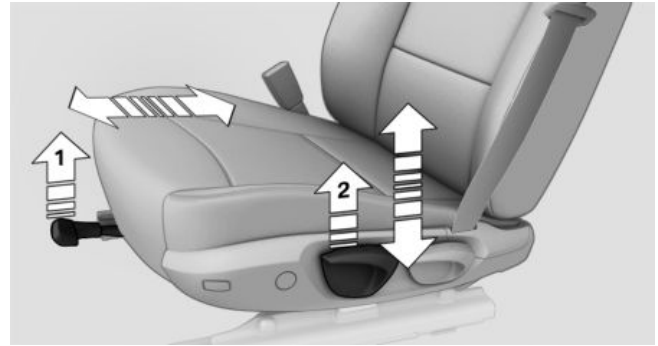

Forward/backward

Pull lever 1 and slide the seat into the desired position.

After releasing the lever, move the seat forward or back slightly to make sure it engages properly.

Height

Pull lever 2 and apply your weight to the seat or lift it off, as necessary.

Backrest tilt

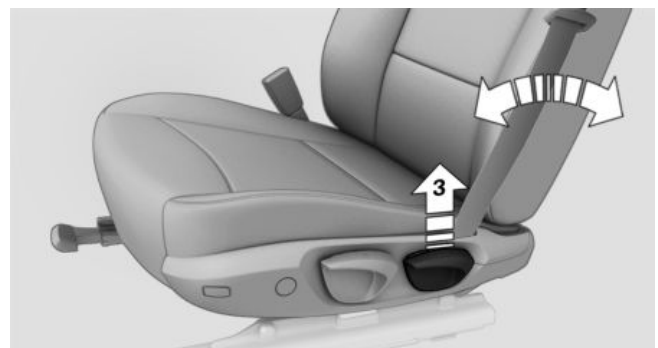

Pull lever 3 and apply your weight to the backrest or lift it off, as necessary.

Seat tilt

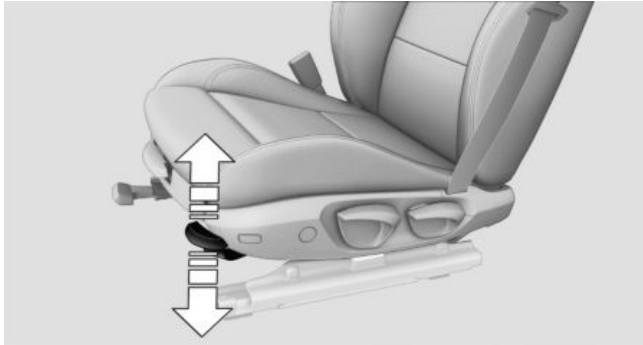

Pull the lever and apply your weight to the seat or lift it off, as necessary.

Thigh support

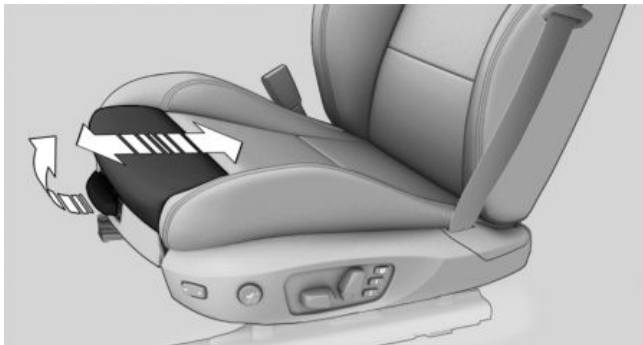

Pull the lever and move the thigh support forward or back.

Adjusting electrically

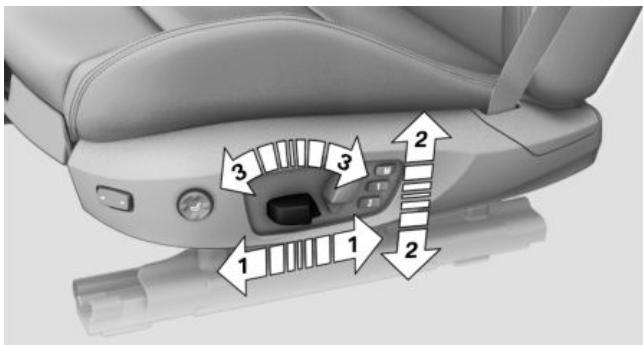

- 1 Forward/backward
- 2 Height
- 3 Seat tilt

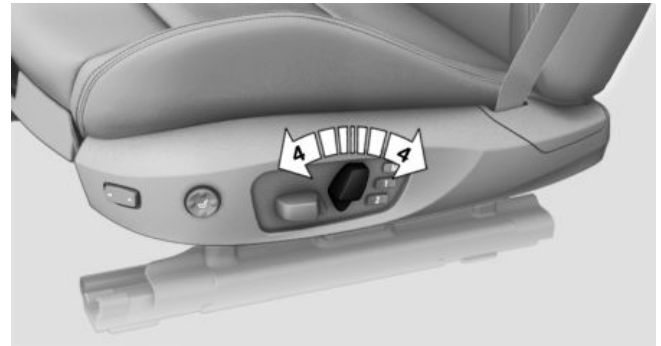

4 Backrest

The head restraint can be adjusted manually, refer Head restraints below.

Lumbar support



You can also adjust the contour of the backrest to obtain additional support in the lumbar region.

The upper hips and spinal column receive supplementary support to help you maintain a relaxed, upright sitting position.

- ▶ Increase or decrease curvature:
Press front or rear section of switch.
- ▶ Shift curvature up or down:
Press upper or lower section of switch.

Backrest width



The width of the backrest can be changed with the side wings to adjust the side support to your own needs.

Press front or rear section of switch.

The backrest width decreases or increases.

Adjusting the rear seat backrests

Adjusting the backrest tilt, refer to page 121.

Seat heating



Switching on



Press the button once for each temperature level.

The maximum temperature is reached when three LEDs are lit.

If the trip is continued within approx. 15 minutes, the seat heating is activated automatically with the temperature set last.

Switching off

Press the button longer.

The LEDs go out.

The temperature is reduced, if need be, down to no heat in order to reduce the load on the battery. The LEDs remain lit.

Safety belts

General information

Always make sure that safety belts are being worn by all occupants before driving away.

Although airbags enhance safety by providing added protection, they are not a substitute for safety belts.

Seats with safety belt

- ▶ The shoulder strap's anchorage point will be correct for adult seat occupants of every build if the seat is correctly adjusted.
- ▶ The two rear safety belt buckles integrated into the rear seat are for passengers sitting on the left and right.
- ▶ The belt buckle embossed with the word CENTER is intended exclusively for use by passengers riding in the center position.
- ▶ If the middle safety belt is used in the rear, the left backrest must be locked, refer to page 121; otherwise, the safety belt will not have a restraining effect.

Notes



One person per safety belt

Never allow more than one person to wear a single safety belt. Never allow infants or small children to ride on a passenger's lap. ◀



Putting on the belt

Lay the belt, without twisting, snugly across the lap and shoulders, as close to the body as possible. Make sure that the belt lies low around the hips in the lap area and does not press on the abdomen. Otherwise, the belt can slip over the hips in the lap area in a frontal impact and injure the abdomen.

The safety belt must not lie across the neck, rub on sharp edges, be routed over solid or breakable objects, or be pinched. ◀



Reduction of restraining effect

Avoid wearing clothing that prevents the belt from fitting properly, and pull the shoulder belt periodically to readjust the tension across your lap; otherwise, the retention effect of the safety belt may be reduced. ◀

Buckling the belt



Make sure you hear the latch plate engage in the belt buckle.

Unbuckling the belt

1. Hold the belt firmly.
2. Press the red button in the belt buckle.
3. Guide the belt back into its reel.

Safety belt reminder for the driver's and front passenger seat



The indicator lamp lights up and a signal sounds. In addition, a message appears on the Control Display.

Check whether the safety belt has been fastened correctly.

The safety belt reminder is active at speeds above approx. 5 mph/8 km/h. It can also be activated if objects are placed on the front passenger seat.

Damage to safety belts

In the case of strain caused by accidents or damage:

Have the safety belts, including the safety belt tensioners, replaced and have the belt anchors checked.



Checking and replacing safety belts

Have the work performed only by your service center; otherwise, it cannot be ensured that this safety feature will function properly. ◀

Head restraints

Correctly adjusted head restraints

A correctly adjusted head restraint reduces the risk of spinal injury in the event of an accident.



Adjusting the head restraint

Correctly adjust the head restraints of all occupied seats; otherwise, there is an increased risk of injury in an accident. ◀

Height

Adjust the head restraint so that its center is approx. at ear level.

Distance

Adjust the distance so that the head restraint is as close as possible to the back of the head.

Front

Height adjustment

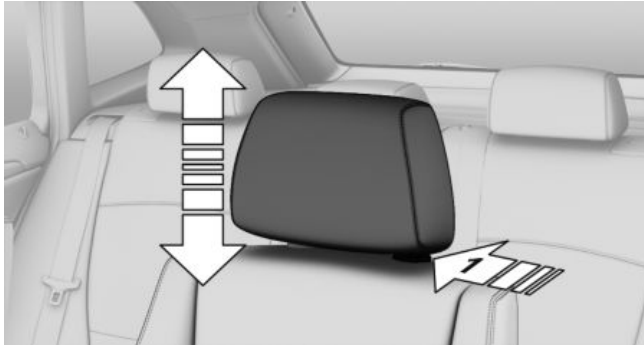

- ▷ To raise: pull.
- ▷ To lower: press the button, arrow 1, and push the head restraint down.

Rear

Height adjustment

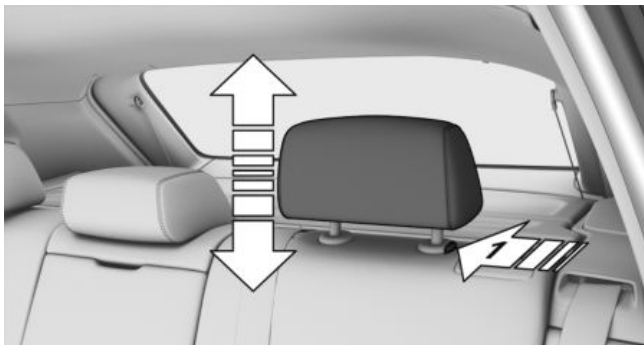

- ▷ To raise: pull.
- ▷ To lower: press button, arrow 1, and push headrest down.

The height of the middle head restraint cannot be adjusted.

Removing at the front and rear

Only remove the head restraint if no one will be sitting in the seat in question.

1. Pull upward as far as possible.
2. Press the button, arrow 1, and completely pull out the head restraint with the rear seat backrest folded forward slightly.



Before transporting passengers
Reinstall the head restraint before transporting anyone in the seat; otherwise, the protective function of the head restraint is unavailable. ◀

Seat and mirror memory

General information

Two different driver's seat and exterior mirror positions can be stored and retrieved.

The adjustment of the backrest width and the lumbar support is not stored in the memory.

Storing

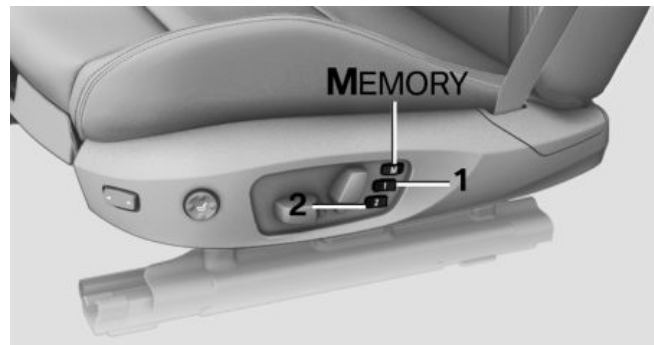

1. Switch on the radio ready state or the ignition, refer to page 59.
2. Adjust the seat and exterior mirrors to the desired positions.
3.  Press the button. The LED in the button lights up.
4. Press the desired memory button 1 or 2. The LED goes out.

If the M button is pressed accidentally:



Press the button again. The LED goes out.

Calling up settings



Do not retrieve the memory setting while driving

Do not retrieve the memory setting while driving, as an unexpected seat movement could result in an accident. ◀

Comfort function

1. Open the driver's door after unlocking or switch on the radio ready state, refer to page 59.
2. Briefly press the desired memory button 1 or 2.

The seat is automatically moved to the stored position.

The procedure stops when a switch for setting the seat or one of the memory buttons is pressed.

Safety mode

1. Close the driver's door and switch the ignition on or off, refer to page 59.
2. Press and hold the desired memory button 1 or 2 until the setting procedure is completed.

Mirrors

Exterior mirrors

General information

The mirror on the passenger side is more curved than the driver's mirror.



Estimating distances correctly

Objects reflected in the mirror are closer than they appear. Do not estimate the distance to the traffic behind you based on what you see in the mirror, as this will increase your risk of an accident. ◀

At a glance

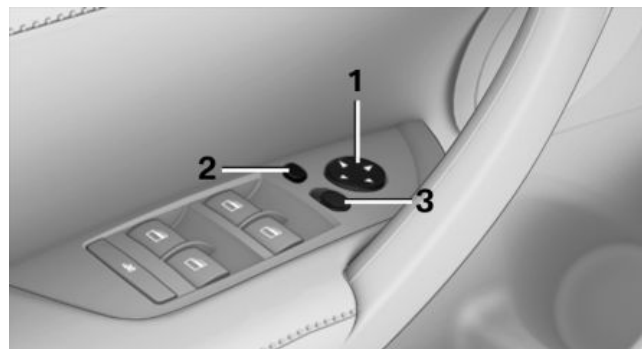

- 1 Adjusting
- 2 Fold in and out
- 3 Left/right, Automatic Curb Monitor

Selecting a mirror



To change over to the other mirror:

Slide the mirror changeover switch.

Adjusting electrically



The setting corresponds to the direction in which the button is pressed.

Saving positions

Seat and mirror memory, refer to page 50.

Adjusting manually

If an electrical malfunction occurs, for example, press the edges of the mirror glass.

Automatic Curb Monitor

When the reverse gear is engaged, the mirror glass tilts downward slightly on the front passenger side. This improves your view of the curb and other low-lying obstacles when parking, for example.

Activating



1. Slide the mirror changeover switch to the driver's side mirror position.

- Shift into reverse or engage transmission position R.

Deactivating

Slide the mirror changeover switch to the passenger side mirror position.

Fold in and out

Press button 2.

Possible up to approx. 15 mph/20 km/h.

For example, this is advantageous

- ▶ In car washes.
- ▶ In narrow streets.
- ▶ For folding back mirrors that were folded away manually.

Mirrors that were folded in are folded out automatically at a speed of approx. 25 mph/40 km/h.



Fold in the mirror in a car wash

Before entering an automatic car wash, fold in the exterior mirrors by hand or with the button; otherwise, they could be damaged, depending on the width of the vehicle. ◀

Automatic heating

Depending on the external temperature, both exterior mirrors are automatically heated when the engine is running or the ignition is switched on.

Interior rearview mirror

Reducing the blinding effect

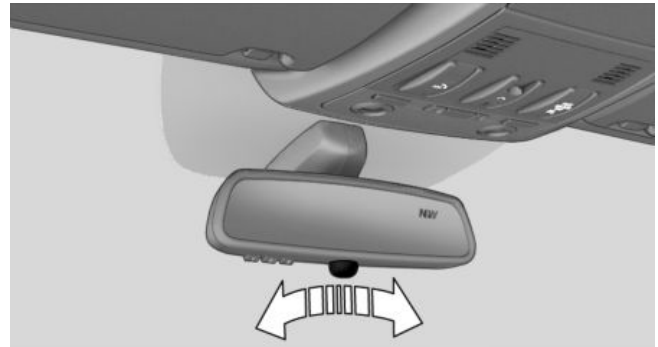

From behind when driving at night: turn the knob.

Interior and exterior mirrors, automatic dimming feature

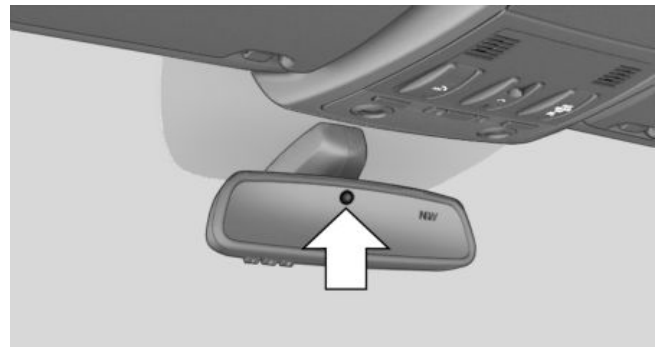

Two photocells are used for control:

- ▶ In the mirror glass, see arrow.
- ▶ On the back of the mirror.

For proper operation:

- ▶ Keep the photocells clean.
- ▶ Do not cover the area between the inside rearview mirror and the windshield.

Steering wheel

General information



Do not adjust while driving

Do not adjust the steering wheel while driving; otherwise, an unexpected movement could result in an accident. ◀

Adjusting

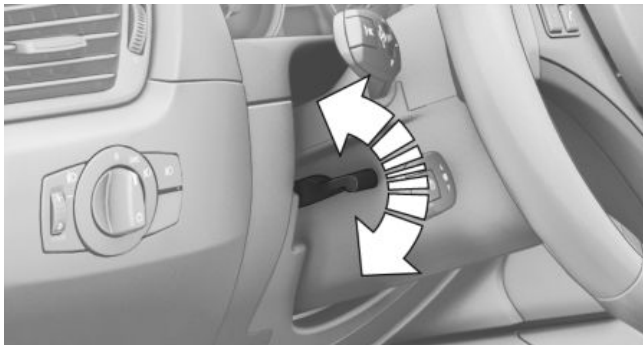

1. Fold the lever down.
2. Move the steering wheel to the preferred height and angle to suit your seating position.
3. Fold the lever back.



Do not use force to swing the lever back.

Do not use force to swing the lever back up; otherwise, the mechanism will be damaged. ◀

Steering wheel heating

Switching on/off



Press the button.

- ▷ On: the LED lights up.
- ▷ Off: the LED goes out.

Transporting children safely

Vehicle equipment

This chapter describes all series equipment as well as country-specific and special equipment offered for this model series. Therefore, it also describes equipment that may not be found in your vehicle, for instance due to the selected special equipment or the country version. This also applies to safety-related functions and systems.

When using the features and systems described here, adhere to local regulations.

The right place for children

Note

 Children in the vehicle
Do not leave children unattended in the vehicle; otherwise, they could endanger themselves and other persons, e.g., by opening the doors. ◀

Children should always be in the rear

Accident research shows that the safest place for children is on the rear seat.

 Transporting children in the rear
Transport children younger than 13 years of age or shorter than 5 ft/150 cm in the rear only, using child restraint fixing systems suitable for the age, weight, and height of the child; otherwise, there is an increased risk of injury in an accident.

Children 13 years of age or older must wear a safety belt as soon as a suitable child restraint fixing system can no longer be used, due to their age, weight and size. ◀

Children on the front passenger seat

Should it be necessary to use a child restraint fixing system on the front passenger seat, make sure that the front and side airbags on the front passenger side are deactivated. Automatic deactivation of front passenger airbags, refer to page 91.

 Deactivating the front passenger airbags
If a child restraint fixing system is used in the front passenger seat, the front passenger airbags must be deactivated; otherwise, there is an increased risk of injury to the child when the airbags are triggered, even with a child restraint fixing system. ◀

Installing child restraint fixing systems

Notes

 Manufacturer's information for child restraint fixing systems

To select, mount and use child restraint fixing systems, observe the information provided by the system manufacturer; otherwise, the protective effect can be impaired. ◀

On the front passenger seat

After installing a child restraint fixing system on the front passenger seat, ensure that the front and side airbags on the front passenger side are deactivated.

 Deactivating the front passenger airbags
If a child restraint fixing system is used in the front passenger seat, the front passenger airbags must be deactivated; otherwise, there is an increased risk of injury to the child when the airbags are triggered, even with a child restraint fixing system. ◀

Seat position and height

Before installing a child restraint fixing system, move the front passenger seat as far back as possible and adjust its height to the highest position to obtain the best possible position for the belt and to offer optimal protection in the event of an accident.

Do not change the seat position and height after this.

Backrest width

Before mounting a child restraint fixing system on the front passenger seat, open the backrest width, refer to page 48, completely. Do not change the backrest width after this.



Backrest width for the child seat

Before installing a child restraint fixing system in the front passenger seat, the backrest width must be opened completely. Do not change the adjustment after this; otherwise, the stability of the child seat will be reduced. ◀

Child seat security



The rear safety belts and the safety belt for the front passenger can be locked to prevent extension in order to permit attachment of child restraint fixing systems.

Locking the safety belt

1. Pull out the belt webbing completely.
2. Secure the child restraint fixing system with the belt.

3. Allow the belt webbing to be pulled in and pull it taut against the child restraint fixing system. The safety belt is locked.

Unlocking the safety belt

1. Open the belt buckle.
2. Remove the child restraint fixing system.
3. Allow the belt webbing to be pulled in completely.

LATCH child restraint fixing system

LATCH: Lower Anchors and Tether for Children.

Note



Manufacturer's information for LATCH child restraint fixing systems

To mount and use the LATCH child restraint fixing systems, observe the operating and safety information from the system manufacturer; otherwise, the level of protection may be reduced. ◀

Mounts for the lower LATCH anchors

The lower anchors may be used to attach the CRS to the vehicle seat up to a combined child and CRS weight of 65 lb/30 kg when the child is restrained by the internal harnesses.



Correctly engage the lower LATCH anchors

Make sure that the lower LATCH anchors have properly engaged and that the child restraint fixing system is resting snugly against the backrest; otherwise, the degree of protection offered may be reduced. ◀

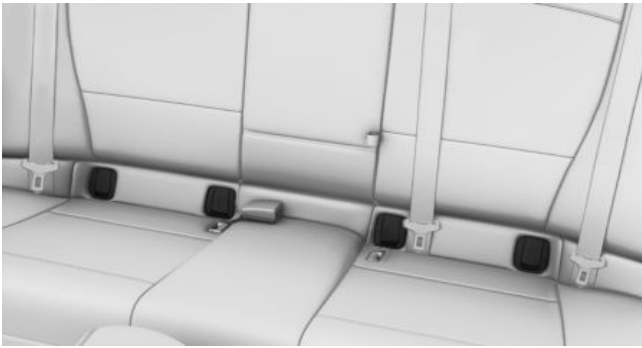

The mounts for the lower LATCH anchors are located behind the indicated cover caps.

Before mounting the LATCH child restraint fixing system, pull the belt away from the child restraint fixing system.

Mounting LATCH child restraint fixing systems

1. Mount the child restraint fixing system; refer to the operating instructions of the system.
2. Ensure that both LATCH anchors are properly connected.

Child restraint fixing system with a tether strap

Mounting points

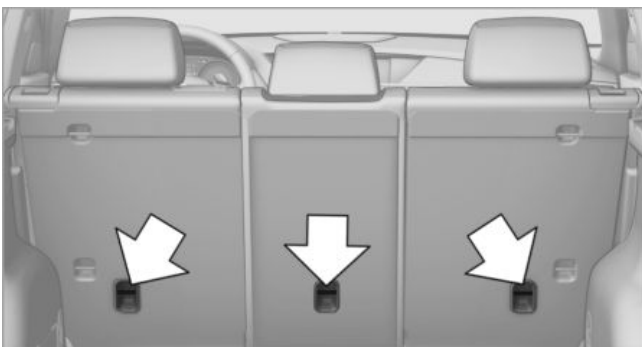

There are three mounting points, see arrows, for the upper retaining strap of LATCH child restraint fixing systems.



LATCH mounting points

Only use the mounting points for the upper LATCH retaining strap to secure child restraint systems; otherwise, the mounting points could be damaged. ◀

Retaining strap guide



Retaining strap

Make sure the upper retaining strap does not run over sharp edges and is not twisted as it passes to the top anchor. Otherwise, the strap will not properly secure the child restraint fixing system in the event of an accident. ◀

Outer rear seats

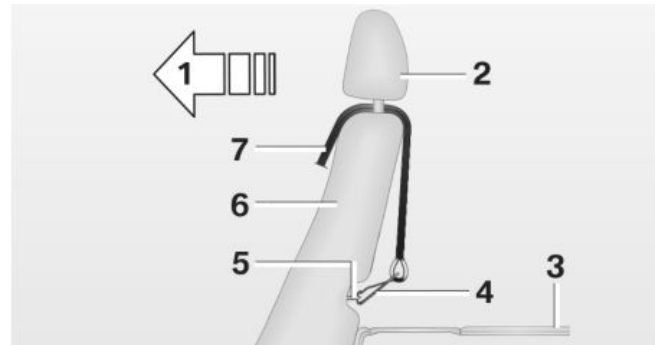

- 1 Direction of travel
- 2 Head restraint
- 3 Cargo area floor
- 4 Hook for upper retaining strap
- 5 Mounting point/eye
- 6 Backrest
- 7 Upper retaining strap

When using the cargo cover, pass the upper retaining strap between the rear seat backrest and the cargo cover.



MM/100200MA

Center rear seat

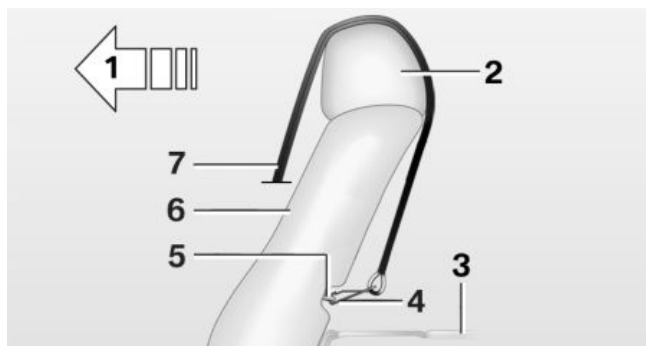

- 1 Direction of travel
- 2 Head restraint
- 3 Cargo area floor
- 4 Hook for upper retaining strap
- 5 Mounting point/eye
- 6 Backrest
- 7 Upper retaining strap

When using the cargo cover, pass the upper retaining strap between the rear seat backrest and the cargo cover.

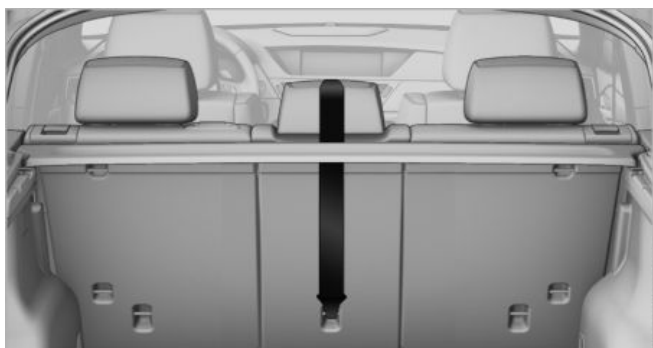

MM/100190MA

Attaching the upper retaining strap to the mounting point

On outer rear seats:

1. Slide the head restraint upward.
2. Guide the upper retaining strap between the supports of the head restraint.
3. Attach the hook of the retaining strap to the mounting eye.
4. Pull the retaining strap taut.

On center rear seat:

1. Route the upper retaining strap over the middle of the head restraint.
2. Attach the hook of the retaining strap to the mounting eye.
3. Pull the retaining strap taut until it compresses the cushion of the head restraint, thus preventing the strap from sliding off.

Locking the doors and windows

Rear doors

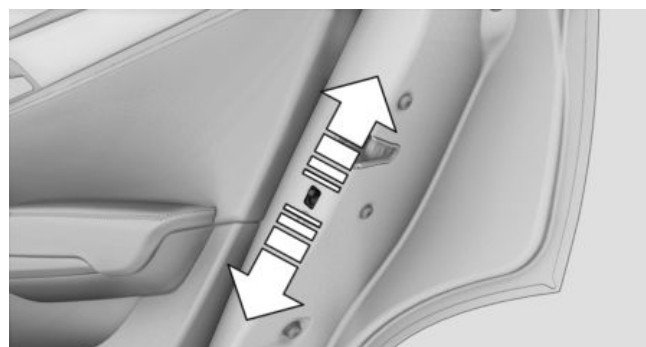

Push the locking lever on the rear doors down. The door can now be opened from the outside only.

Safety switch for the rear



Press the button on the driver's door if children are being transported in the rear.

This locks the rear window switches so that the windows cannot be operated from the rear: safety switch, refer to page [43](#).

Driving

Vehicle equipment

This chapter describes all series equipment as well as country-specific and special equipment offered for this model series. Therefore, it also describes equipment that may not be found in your vehicle, for instance due to the selected special equipment or the country version. This also applies to safety-related functions and systems.

When using the features and systems described here, adhere to local regulations.

Ignition lock

Insert the remote control into the ignition lock

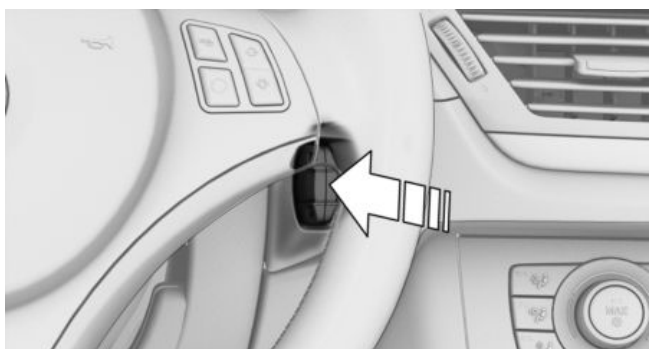

Insert the remote control all the way into the ignition lock.

- ▶ Radio ready state is switched on. Individual electrical consumers can operate.

Comfort Access

If the car is equipped with Comfort Access, only insert the remote control into the ignition lock, refer to page 39, under special circumstances.

Removing the remote control from the ignition lock



Do not forcibly pull the remote control out of the ignition lock

Do not forcibly pull the remote control out of the ignition lock as this may cause damage. ◀

Before removing the remote control, push it all the way in to release the locking mechanism.

- ▶ The ignition is switched off if it was on.

Automatic transmission

You can only take out the remote control if transmission position P is engaged: interlock.

Start/Stop button

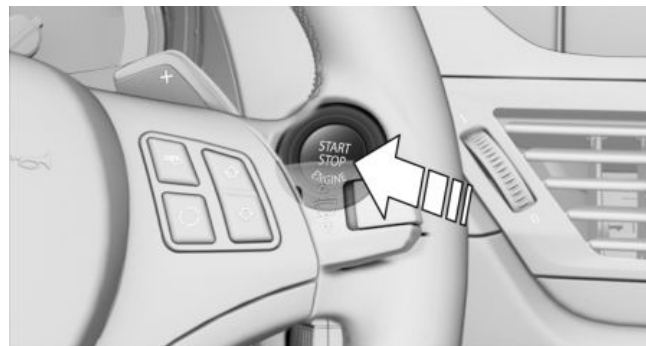

Pressing the Start/Stop button switches the ignition on or off and starts the engine.

The engine starts if the brake pedal is pressed when you press the Start/Stop button.

Radio ready state

Individual electrical consumers can operate. The time and the external temperature are displayed in the instrument cluster.

Radio ready state is switched off automatically:

- ▶ When the remote control is removed from the ignition lock.

- ▷ In cars with Comfort Access, refer to page 39, by touching the surface above the door lock.

Ignition on

All electrical consumers can operate. The odometer and trip odometer are displayed in the instrument cluster.

To save battery power when the engine is off, switch off the ignition and any unnecessary electronic systems/power consumers.

Radio ready state and ignition off

All indicator and warning lamps as well as displays in the instrument cluster go out.

Automatic transmission, 8-gear

In certain situations, transmission position P is engaged automatically. To make it possible for the vehicle to roll, such as in an automatic car wash, follow the instructions in Car washes, refer to page 263.

Starting the engine

General information



Enclosed areas

Do not let the engine run in enclosed areas; otherwise, breathing of exhaust fumes may lead to loss of consciousness and death. The exhaust gases contain carbon monoxide, an odorless and colorless but highly toxic gas. ◀



Unattended vehicle

Do not leave the car unattended with the engine running; otherwise, it presents a potential source of danger.

Before leaving the car with the engine running, shift to neutral or engage transmission position P and set the parking brake firmly; otherwise, the vehicle may begin to roll. ◀



Frequent starting in quick succession

Avoid repeated futile attempts at starting the car and avoid starting the car frequently in quick succession. Otherwise, the fuel is not burned or is inadequately burned, and there is the danger of overheating and damaging the catalytic converter. ◀

Do not wait for the engine to warm-up while the vehicle remains stationary. Start driving right away, but at moderate engine speeds.

Starting the engine

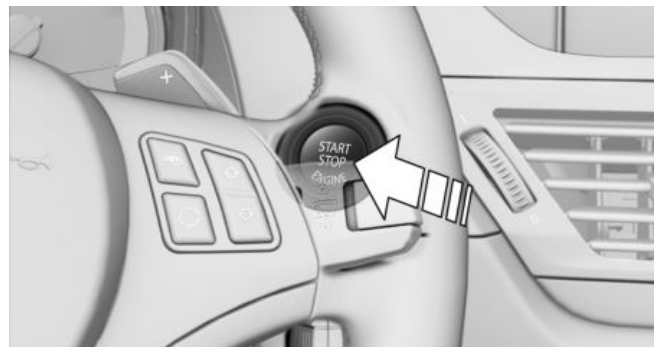

Automatic transmission

Remote control in the ignition lock or, with Comfort Access, inside the vehicle, refer to page 39.

1. Depress the brake pedal.
2. Engage transmission position P if necessary.
3. Press the Start/Stop button.

The ignition is activated automatically for a certain time and is stopped as soon as the engine starts.

Engine stop

General information



Take the remote control with you when leaving the vehicle so that children, for example, cannot operate the windows and injure themselves. ◀



Set the parking brake and further secure the vehicle as required

Set the parking brake firmly when parking; otherwise, the vehicle may roll. On steep upward and downward inclines, further secure the vehicle, for example, by turning the steering wheel in the direction of the curb. ◀

Before driving into a car wash

To make it possible for the vehicle to roll in an automatic car wash, follow the information on Washing in automatic car washes, refer to page 263.

Switching off the engine

Automatic transmission

1. Engage transmission position P with the vehicle stopped.
2. Press the Start/Stop button.
3. Set the parking brake firmly.
4. Remove the remote control from the ignition lock, refer to page 59.

Automatic Engine Start/Stop Function

The concept

The Auto Start/Stop function helps save fuel. The system switches off the engine during a stop, for instance in congestion or at traffic lights. The ignition remains switched on. The

engine starts automatically when you wish to drive away.

Automatic operation

The automatic engine Start/Stop function is operational after each engine start. It is activated whenever you drive forward faster than 3 mph/5 km/h.

Automatic engine stop

The engine is switched off automatically during a stop under the following conditions:

Automatic transmission:

- ▶ The selector lever is in transmission position D.
- ▶ The brake pedal remains depressed while the vehicle is at a standstill.
- ▶ The driver's safety belt is fastened or the driver's door is closed.

When the engine is switched off, the air volume of the automatic climate control is reduced.

Indicator light in the instrument cluster

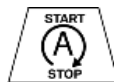

The indicator lamp lights up when the Auto Start/Stop function is ready to start the engine automatically.



The indicator lamp lights up if the requirements for an automatic engine stop are not fulfilled.

Note

The engine is not switched off automatically in the following situations:

- ▶ External temperature too low.
- ▶ High external temperature and operation of the automatic climate control.
- ▶ The interior is not yet heated or cooled as much as desired.

- ▷ The engine is not yet at operating temperature.
- ▷ Sharp steering angle or the steering wheel is being turned.
- ▷ After driving in reverse.
- ▷ Fogging of the windows when the automatic climate control is switched on.
- ▷ Vehicle battery charge is very low.
- ▷ Hood is unlocked.
- ▷ HDC is activated.
- ▷ Stop-and-go traffic.
- ▷ The selector lever is in position N or M/S.



The indicator lamp is lit.

Parking the vehicle during an automatic engine stop

The vehicle can be parked safely during an automatic engine stop, such as when you wish to leave the vehicle.

1. Press the Start/Stop button. The ignition is switched off. The Auto Start/Stop function is deactivated.

Automatic transmission: transmission position P is engaged automatically.

2. Set the parking brake.

Start the engine as usual using the Start/Stop button.

Automatic engine start

The engine starts automatically under the following conditions to enable the driver to drive away:

- ▷ Automatic transmission:
The brake pedal is released.

After the engine starts, accelerate as usual.

Safety mode

The engine does not start by itself after it is switched off automatically if any of the following conditions are fulfilled:

- ▷ The driver's safety belt is unfastened or the driver's door is open.
- ▷ Hood was unlocked.

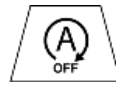

The indicator lamp lights up. A message appears on the Control Display.

The engine can only be started via the Start/Stop button.

Note

Even if you do not wish to drive away, the stopped engine still starts automatically in the following situations:

- ▷ The interior has heated up strongly with the cooling function switched on.
- ▷ The steering wheel is turned.
- ▷ The vehicle begins to roll.
- ▷ Automatic transmission: the transmission position is changed from D to N, R or M/S.
- ▷ Automatic transmission: the transmission position is changed from P to N, D, R or M/S.
- ▷ Fogging of the windows when the automatic climate control is switched on.
- ▷ Vehicle battery charge is very low.
- ▷ The interior has cooled down strongly with the heating switched on.
- ▷ Low braking pressure, such as from depressing the brake pedal a number of times consecutively.

Preventing automatic engine stop with an automatic transmission

The concept

To permit the driver to drive away especially quickly, such as at intersections, the automatic engine stop can be actively prevented.

Preventing the engine stop using the brake pedal

The engine stop can be actively prevented within one second after the vehicle comes to a standstill.

- ▶ Depress the brake pedal briefly and forcefully immediately after the vehicle comes to a standstill.
- ▶ Then continue depressing the brake pedal with normal braking force.

Activating/deactivating the system manually



Press the button.

- ▶ LED lights up: the Auto Start/Stop function is deactivated.
The engine is started during an automatic engine stop.
The engine can only be stopped or started via the Start/Stop button.
- ▶ LED goes out: the Auto Start/Stop function is activated.

Automatic deactivation

In certain situations, the Auto Start/Stop function is deactivated automatically in the interest of safety, for example if the driver's absence is detected.

Malfunction

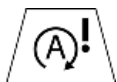

The indicator lamp lights up. The automatic engine start/stop function no longer switches of the engine auto-

atically. A message appears on the Control Display. It is possible to continue driving. Have the system checked.

Parking brake

The concept

The parking brake is primarily intended to prevent the vehicle from rolling while parked; it brakes the rear wheels.

Indicator lamp



The indicator lamp lights up and an acoustic signal sounds when driving away. The parking brake is still set.

Setting

The lever engages automatically.

Releasing

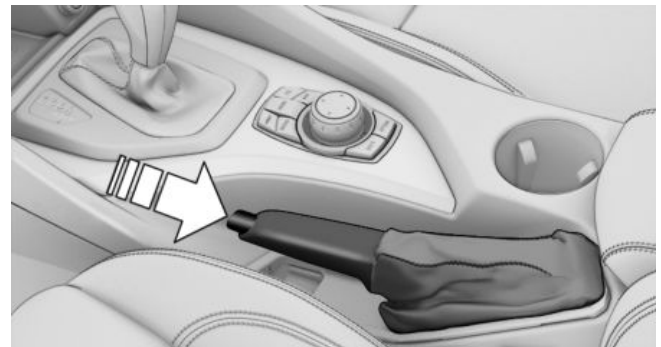

Pull up slightly, press the button, and lower the lever.

Notes



Using the parking brake while driving

If it should become necessary to use the parking brake while driving, do not pull the parking brake too forcefully. Keep the button on the parking brake lever pressed at all times.

Excessive application of the parking brake can block the rear wheels and lead to fishtailing of the vehicle. ◀

To prevent corrosion and uneven brake action, lightly apply the parking brake from time to time when coasting, traffic conditions permitting.

The brake lights do not light up when the parking brake is pulled.

Turn signal, high beams, headlamp flasher

Turn signal

 Do not fold in the exterior mirrors while driving and when using the turn signal/hazard warning flashers, do not fold in the exterior mirrors; otherwise, the additional turn signal lamps in the exterior mirrors will not be in the appropriate position and will be difficult to detect. ◀

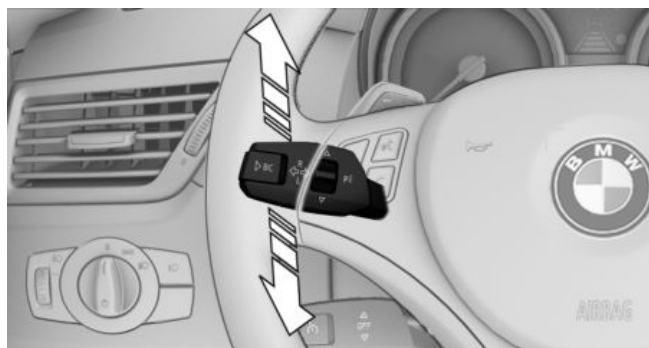

Press the lever beyond the resistance point.

To switch off manually, press the lever to the resistance point.

Unusually rapid flashing of the indicator lamp indicates that a turn signal bulb has failed.

When towing a trailer, the indicator lamp may also signal the failure of a turn signal bulb on the trailer.

Signaling a turn briefly

Press the lever to the resistance point and hold it there for as long as you want the turn signal to flash.

Triple turn signal activation

Press the lever to the resistance point.

The turn signal flashes three times.

This function can be activated or deactivated:

1. "Settings"
2. "Lighting"
3. "Triple turn signal"

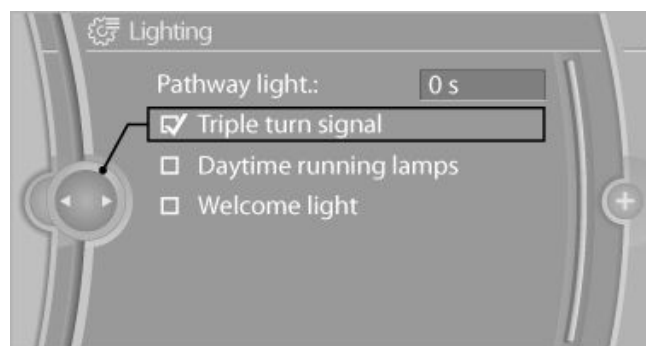

The setting is stored for the remote control currently in use.

High-beams, headlamp flasher

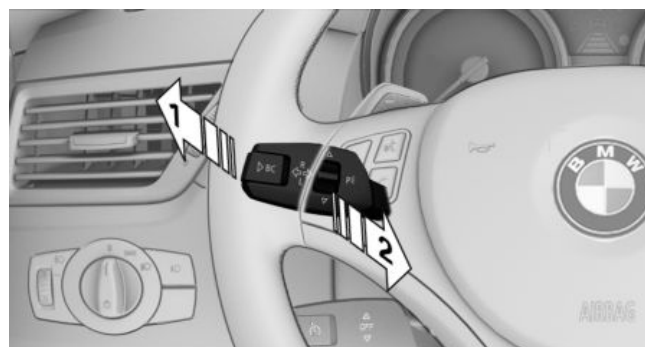

- 1 High-beams
- 2 Headlamp flasher

Washer/wiper system

Notes

 Do not switch on the wipers if frozen. Do not switch on the wipers if they are frozen onto the windshield; otherwise, the wiper blades and the windshield wiper motor may be damaged. ◀

 Do not use the wipers on a dry windshield

Do not use the wipers on a dry windshield; otherwise, the wiper blades may wear more rapidly or become damaged. ◀

At a glance

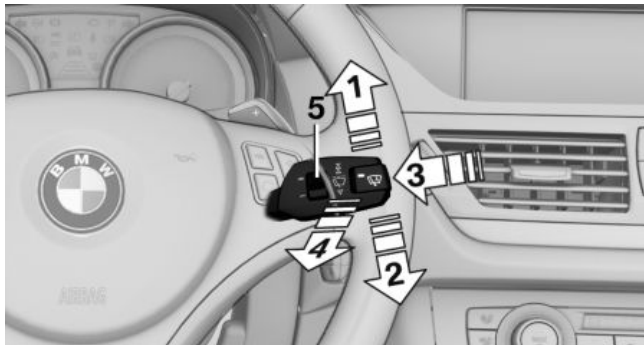

- 1 Switching on wipers
- 2 Switching off wipers or brief wipe
- 3 Activating/deactivating intermittent wipe or the rain sensor
- 4 Cleaning the windshield and headlights
- 5 Setting speed for intermittent wipe or sensitivity of the rain sensor

Switching on wipers

Press the wiper lever upward, arrow 1.

The lever automatically returns to its initial position when released.

Normal wiper speed

Press up once.

The system switches to operation in the intermittent mode when the vehicle is stationary.

Fast wiper speed

Press up twice or press once beyond the resistance point.

The system switches to normal speed when the vehicle is stationary.

Switching off wipers or brief wipe

Press the wiper lever down, arrow 2.

The lever automatically returns to its initial position when released.

- ▷ Brief wipe: press down once.
- ▷ To switch off normal wipe: press down once.
- ▷ To switch off fast wipe: press down twice.

Intermittent wipe or rain sensor

If the car is not equipped with a rain sensor, the intermittent-wipe time is a preset.

If the car is equipped with a rain sensor, the time between wipes is controlled automatically and depends on the intensity of the rainfall.

The rain sensor is mounted on the windshield, directly in front of the interior rearview mirror.

Activating intermittent wipe or the rain sensor

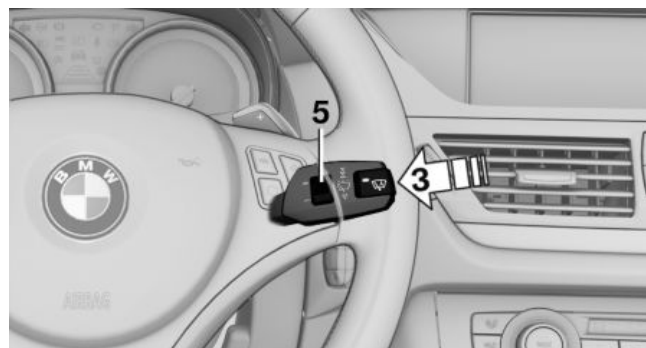

Press the button, arrow 3.

The LED in the steering wheel stalk lights up and a wiping cycle is started.

Setting intermittent wipe or the sensitivity of the rain sensor

Turn thumbwheel 5 up or down.

Deactivating intermittent wipe or the rain sensor

Press the button again, arrow 3.

The LED goes out.

 Deactivate the rain sensor in car washes
Deactivate the rain sensor when passing through an automatic car wash; otherwise, damage could be caused by undesired wiper activation. ◀

Cleaning the windshield and headlamps

Pull the lever, arrow 4.

The system sprays washer fluid on the windshield and activates the wipers briefly.

When the vehicle lighting system is switched on, the headlights are cleaned at regular and appropriate intervals.

 Do not use the washer system at freezing temperatures

Do not use the washers if there is any danger that the fluid will freeze on the windshield; otherwise, your vision could be obscured. For this reason, use antifreeze.

Avoid using the washer when the reservoir is empty; otherwise, you could damage the pump. ◀

Windshield washer nozzles

The windshield washer nozzles are heated automatically while the engine is running or the ignition is switched on.

Fold-out position of the wipers

Required when changing the wiper blades or under frosty conditions, for example.

1. Switch off the ignition.
2. Under frosty conditions, ensure that the wiper blades are not frozen onto the windshield.
3. Press the wiper lever up beyond the point of resistance and hold it for approx. 3 seconds, until the wiper remains in a nearly vertical position.

After the wipers are folded back down, the washer/wiper system, refer to page 64, must be reactivated.

 Fold the wipers back down
Before switching the ignition on, fold the wipers back down to the windshield; otherwise, the wipers may become damaged when they are switched on. ◀

1. Switch on the ignition.
2. Press the wiper levers down. The wipers move to their resting position and are ready for operation.

Rear window wiper



- 1 Intermittent wipe
When reverse gear is engaged, the system switches to continuous operation.
- 2 Cleaning the rear window

The rear window wiper does not move if the lever is in position 1 before the ignition is switched on.

To switch on the rear window wiper:

1. Move the lever to its basic position.
2. Select the required position again.

 Do not use the washing mechanisms when the washer fluid reservoir is empty

Do not use washing mechanisms when the washer fluid reservoir is empty, otherwise you will damage the washer pump. ◀

Washer fluid

General information



Antifreeze for washer fluid

Antifreeze is flammable and can cause injuries if used improperly.

Therefore, keep it away from sources of ignition.

Only keep it in the closed original container and inaccessible to children.

Follow the notes and instructions on the container.

United States: The washer fluid mixture ratio is regulated by the U.S. EPA and many individual states; do not exceed the allowable washer fluid dilution ratios limits that apply. Follow the usage instructions on the washer fluid container. Use BMW's Windshield Washer Concentrate or the equivalent. ◀

Washer fluid reservoir



Adding washer fluid

Only add washer fluid when the engine is cool, and then close the cover completely to avoid contact between the washer fluid and hot engine parts.

Otherwise, there is the danger of fire and a risk to personal safety if the fluid is spilled. ◀

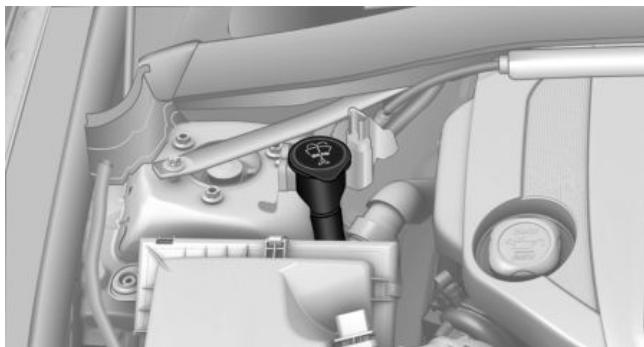

All washer nozzles are supplied from one reservoir.

The recommended minimum filling quantity is 0.2 US gal/1 liter.

Fill with a mixture of window washing concentrate and tap water; if needed, add antifreeze according to the manufacturer instructions.

Mix the washer fluid before adding to maintain the correct mixing ratio.

Do not fill in undiluted window washing concentrate and antifreeze and do not fill in pure water; this could damage the washer system.

Do not mix window washing concentrate from different manufacturers; this could cause the washer nozzles to clog.

Automatic transmission with Steptronic, 6-gear

In addition to the fully automatic mode, gears can also be shifted manually using Steptronic, refer to page 68.

Parking the vehicle



Secure the vehicle

Before leaving the vehicle with the engine running, move the selector lever to position P and set the handbrake; otherwise, the vehicle will begin moving. ◀

Disengaging the remote control

To remove the remote control from the ignition lock, first move the selector lever to position P and switch off the engine: interlock. Remove the remote control from the ignition lock, refer to page 59.

Selector lever positions

P R N D M/S + -

Displays in the instrument cluster



The selector lever position is displayed and the engaged gear, such as M4, is displayed in manual mode.

Changing selector lever positions

- ▶ With the ignition switched on or the engine running, the selector lever can be moved out of position P.
- ▶ When the vehicle is stationary, step on the brake before shifting out of P or N; otherwise, the selector lever is locked: shiftlock.



Press on the brake pedal until you start driving

To prevent the vehicle from creeping after you select a driving position, maintain pressure on the brake pedal until you are ready to start. ◀



A lock prevents you from inadvertently engaging selector lever positions R and P. To cancel the lock, press the button on the front of the selector lever, see arrow.

P Park

Select only when the vehicle is stationary. The rear wheels are locked.

R is Reverse

Select only when the vehicle is stationary.

N is Neutral

Use in automatic car washes, for example. The vehicle can roll.

D Drive, automatic position

Position for normal vehicle operation. All forward gears are selected automatically.

Under normal operating conditions, fuel consumption is lowest when you are driving in position D.

Kickdown

Kickdown is used to achieve maximum driving performance. Press on the accelerator beyond the resistance point at the full throttle position.

Sport program and manual mode M/S

Activating the Sport program



Move the selector lever from position D toward the left.

DS is displayed in the instrument cluster.

This position is recommended for a performance-oriented driving style.

To deactivate the Sport program or manual mode M/S, move the selector lever to the right into position D.

Activating the M/S manual mode

Move the selector lever from position D toward the left.

Push the selector lever forward or backward.

Manual mode becomes active and the gear is changed.

The engaged gear is displayed in the instrument cluster, e.g., M1.

- ▶ To shift down: press the selector lever forward.
- ▶ To shift up: press the selector lever backward.

The vehicle only shifts up or down at appropriate engine and road speeds, e.g., it does not shift down if the engine speed is too high. The selected gear is briefly displayed in the instrument panel, followed by the current gear.

Shifting gears using the shift paddles on the steering wheel

The shift paddles on the steering wheel allow you to shift gears quickly while keeping both hands on the steering wheel.

- ▶ When the shift paddles on the steering wheel are used to shift gears while in automatic mode, the transmission switches to manual mode.
- ▶ If the shift paddles are not used to accelerate or shift gears for a certain amount of time, the transmission switches back to automatic mode.

If the selector lever is in the M/S gear plane, manual mode remains active.

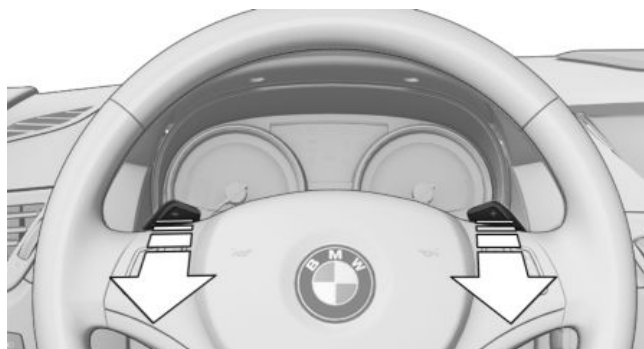

- ▶ Shift up: briefly pull right shift paddle +.
- ▶ Shift down: briefly pull left shift paddle -.

The vehicle only shifts up or down at appropriate engine and road speeds, e.g., it does not shift down if the engine speed is too high. The selected gear is briefly displayed in the instrument panel, followed by the current gear.

Overriding selector lever lock

If the selector lever is locked in position P although the ignition is switched on, the brake is depressed, and the button on the selector lever is pressed, the selector lever lock can be overridden:

1. Switch off the ignition.
2. Unclip the sleeve of the selector lever.
3. Pull the sleeve up over the selector lever until the sleeve is inside out.

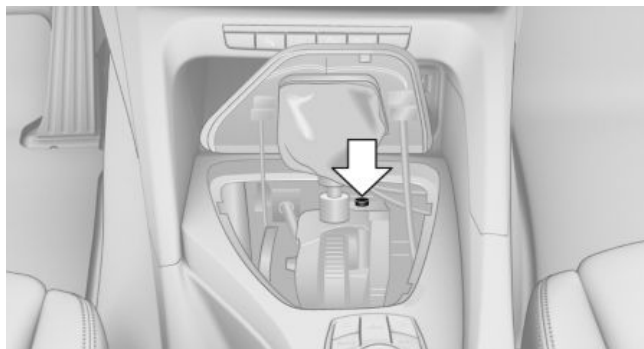

4. Using the screwdriver from the tool kit, refer to page 249, press the red lever while moving the selector lever to the desired position with the button pressed.

Automatic transmission with Steptronic, 8-gear

Transmission positions

D Drive, automatic position

Position for normal vehicle operation. All forward gears are available.

Under normal operating conditions, fuel consumption is lowest when you are driving in position D.

Kickdown

Kickdown is used to achieve maximum driving performance. Press on the accelerator beyond the resistance point at the full throttle position.

R is Reverse

Select only when the vehicle is stationary.

N is Neutral

The vehicle can roll.

N remains engaged after the engine is switched off if the remote control remains in the ignition lock. This function can be used in an automatic car wash, refer to page 263, for example. P is automatically engaged after approx. 30 minutes.

P Park

The drive wheels are blocked.

P is engaged automatically when the following conditions are met:

- ▶ The driver's door is opened while the engine is running, the safety belt is not fastened and neither the brake pedal nor the accelerator is activated.
- ▶ The engine is switched off unless N is engaged and the remote control is in the ignition lock.
- ▶ The remote control is removed from the ignition lock.

Before leaving the vehicle, ensure that the transmission position P is engaged; otherwise, the vehicle may begin to roll.

Engaging transmission position

- ▶ Transmission position P can only be disengaged if the engine is running and the brake pedal is pressed.
- ▶ With the vehicle stationary, press on the brake pedal before shifting out of P or N; otherwise, the shift command will not be executed: shift lock.



Press on the brake pedal until you start driving

To prevent the vehicle from creeping after you select a driving position, maintain pressure on the brake pedal until you are ready to start. ◀

Engaging transmission positions D, R, N



Briefly push the selector lever in the desired direction, beyond a resistance point if necessary. When shifting out of P or into R, simultaneously push the unlock button 1.

The engaged transmission position is displayed on the selector lever.

After releasing the selector lever, it returns to its center position.

Engaging transmission position P

Select only when the vehicle is stationary.



Press button P.

Sport program and manual mode M/S

Activating the Sport program



Push the selector lever to the left out of transmission position D.

The Sport program is activated and DS is displayed in the instrument cluster.

This position is recommended for a performance-oriented driving style.

Activating manual mode

Push the selector lever to the left out of transmission position D.

Push the selector lever forward or backward.

Manual mode becomes active and the gear is changed.

The engaged gear is displayed in the instrument cluster, e.g., M1.

- ▶ To shift down: press the selector lever forward.
- ▶ To shift up: press the selector lever backward.

The transmission only shifts up or down if the rpm and vehicle speed are appropriate. If the engine speed is too high, the transmission does not shift down.

The selected gear is briefly displayed in the instrument panel, followed by the current gear.

Ending the Sport program/manual mode

Push the selector lever to the right.

D is displayed in the instrument cluster.

Shifting gears using the shift paddles on the steering wheel

The shifting paddles make it possible to quickly change gears since both hands can remain on the steering wheel.

- ▶ If the shift paddles on the steering wheel are used to shift gears while in automatic mode D, the transmission temporarily switches to manual mode.
- ▶ If the shift paddles are not used to accelerate or shift gears for a certain amount of time, the transmission switches back to automatic mode D.

With the transmission position M/S selected, the manual mode remains active.

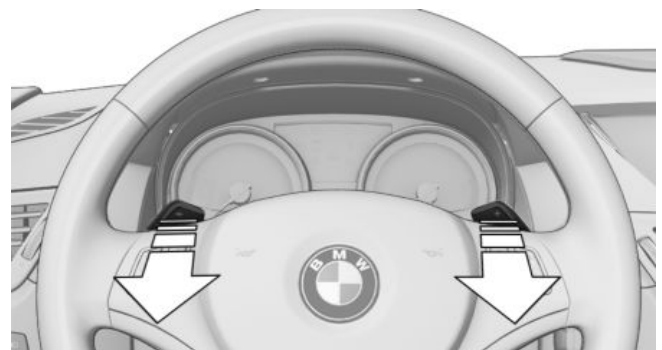

- ▶ Shift up: pull right shift paddle.
- ▶ Shift down: pull left shift paddle.

The vehicle only shifts up or down at appropriate engine and road speeds, e.g., it does not shift down if the engine speed is too high.

The selected gear is briefly displayed in the instrument cluster, followed by the current gear.

Displays in the instrument cluster



The transmission position is displayed and the engaged gear, such as M4, is displayed in manual mode.

Displays

Vehicle equipment

This chapter describes all series equipment as well as country-specific and special equipment offered for this model series. Therefore, it also describes equipment that may not be found in your vehicle, for instance due to the selected special equipment or the country version. This also applies to safety-related functions and systems.

When using the features and systems described here, adhere to local regulations.

Odometer, external temperature display, clock

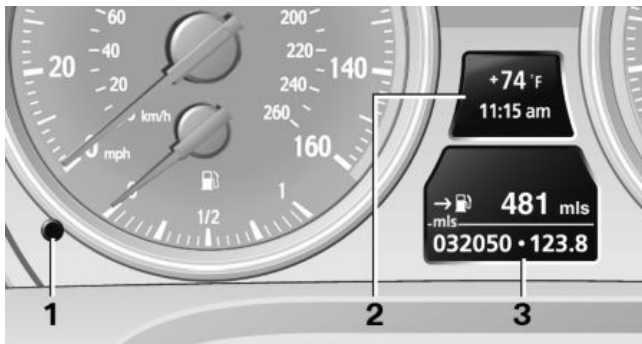

- 1 Knob in the instrument cluster
- 2 External temperature display and clock
- 3 Odometer and trip odometer

Knob in the instrument cluster

Press the knob.

- ▶ When the ignition is switched on, the trip odometer is reset.
- ▶ When the ignition is switched off, the time, external temperature and odometer are displayed.

Units of measure

To set the respective units of measure, miles or km for the odometer and °C or °F for the external temperature, refer to page 77.

The setting is stored for the remote control currently in use.

Time, external temperature display

Set the time, refer to page 77.

External temperature warning

If the display drops to +37 °F/+3 °C, a signal sounds and a warning lamp lights up. There is the increased danger of ice.



Ice on roads

Even at temperatures above +37 °F/+3 °C, there can be a risk of ice on roads.

Therefore, drive carefully on bridges and shady roads, for example, to avoid the increased danger of an accident. ◀

Odometer and trip odometer

Resetting trip odometer:

With the ignition switched on, press button 1 in the instrument cluster.

When the vehicle is parked

If you still want to view the time, external temperature and odometer reading briefly after the remote control has been taken out of the ignition lock:

Press button 1 in the instrument cluster.

Tachometer



Never force the engine speed up into the red warning field, see arrow. In this range, the fuel supply is interrupted to protect the engine.

Coolant temperature

A warning lamp will come on if the coolant, and therefore the engine, becomes too hot. In addition, a message will appear on the Control Display.

Check the coolant level, refer to page [246](#).

Current fuel consumption

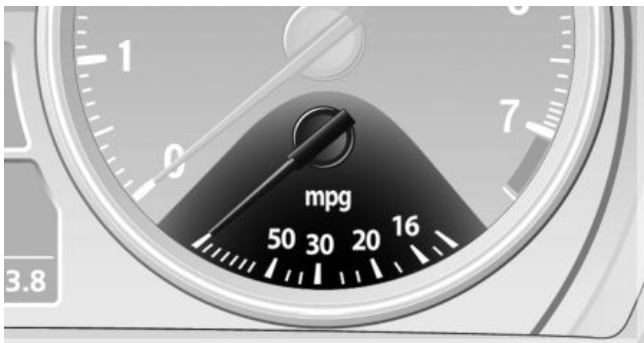

Displays the current fuel consumption. You can check whether you are currently driving in an efficient and environmentally-friendly manner.

Engine oil temperature



- ▶ Cold engine: the pointer is at the low temperature end. Drive at moderate engine and vehicle speeds.
- ▶ Normal operating temperature: the pointer is in the middle or in the right half of the temperature display.
- ▶ Hot engine: the pointer is at the high temperature end. Switch off the engine immediately and allow it to cool down.

If the engine oil temperature is too high, a message appears on the Control Display.

Check the oil level, refer to page [243](#).

Fuel gauge



The vehicle inclination may cause the display to vary.

The arrow on the fuel pump symbol indicates the side of the vehicle with the fuel filler flap.

Notes on refueling, refer to page [228](#).

Range

After the reserve range is reached:

- ▷ A message is briefly displayed on the Control Display.
- ▷ The remaining range is shown on the computer.
- ▷ When a dynamic driving style is used, such as when corners are taken rapidly, engine functions are not ensured.

The message appears continuously below a range of approx. 30 miles/50 km.



Refuel promptly

At the latest, refuel at a range below 30 miles/50 km; otherwise, the engine function is not ensured and damage may occur. ◀

Computer

Displaying information on the instrument panel



Press the computer button on the turn signal lever.

Information is displayed in the instrument cluster.

Overview of the information

Repeatedly pressing the button on the turn signal lever displays the information on the instrument cluster in the following order:

- ▷ Range.
- ▷ ECO PRO bonus range.
- ▷ Average speed.
- ▷ Average fuel consumption.

- ▷ Current fuel consumption.
- ▷ No information.

To set the corresponding units of measure, refer to page 77.

Information in detail

Range

Displays the estimated cruising range available with the remaining fuel.

It is calculated based on your driving style over the last 18 miles/30 km.

Average speed

Periods in which the vehicle was parked and the engine was switched off manually are not included in the average speed calculations.

With the trip computer, refer to page 76, you can have the average speed displayed for an additional distance.

To reset the average speed: press the button on the turn indicator lever for approx. 2 seconds.

Average fuel consumption

This is calculated for the period during which the engine is running.

The average consumption is computed based on the distance traveled since the last time the computer was reset.

You can have the average consumption for another trip displayed, refer to Displays on the Control Display below.

To reset the average consumption: press the button on the turn indicator lever for approx. 2 seconds.

Current fuel consumption

Displays the current fuel consumption. You can check whether you are currently driving in an efficient and environmentally-friendly manner.

Displays on the Control Display

Display the computer or trip computer on the Control Display.

1. "Vehicle Info"
2. "Onboard info" or "Trip computer"

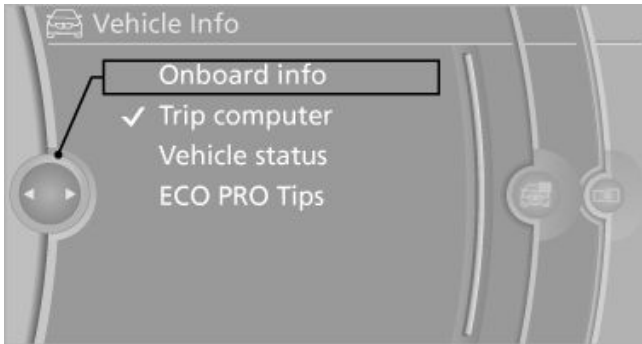

Displays on the "Onboard info":

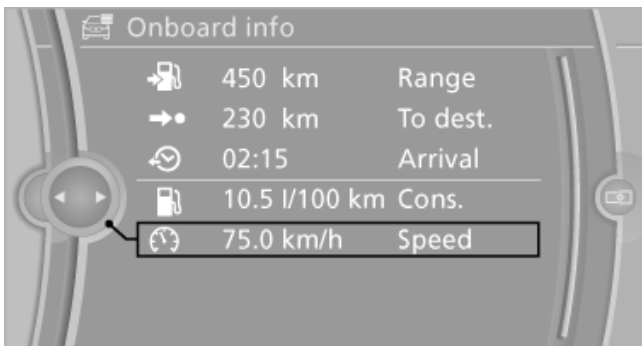

- ▷ Range.
- ▷ Distance to destination.
- ▷ Estimated time of arrival if a destination was entered in the navigation system, refer to page 146.

Displays on the "Trip computer":

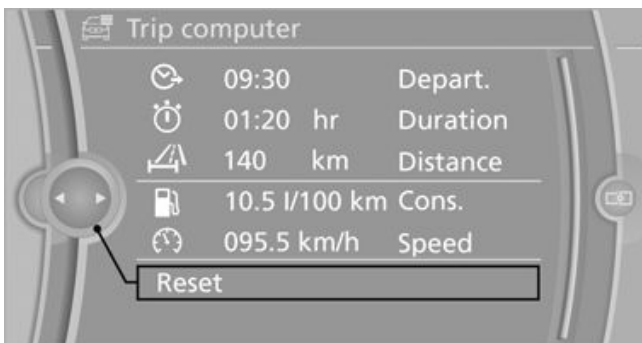

- ▷ Departure time.
- ▷ Trip duration.

- ▷ Trip distance.

Both displays show:

- ▷ Average fuel consumption and
- ▷ Average speed.

Resetting the fuel consumption and speed

Resetting the values for average speed and average fuel consumption:

1. Select the respective menu item and press the controller.
2. Press the controller again to confirm your selection.

Resetting the trip computer

Resetting all values:

1. "Vehicle Info"
2. "Trip computer"
3. "Reset"

Settings and information





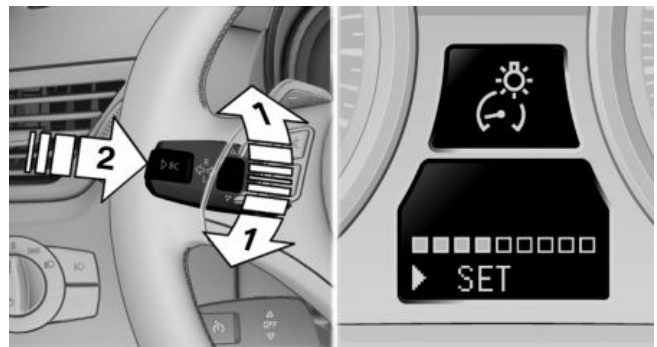

Operating concept

Certain settings and information can only be called up when the ignition is switched on. A number of settings cannot be made while driving.



- 1 Button for:
 - ▷ Selecting the display.
 - ▷ Setting values.
- 2 Button for:

- ▶ Confirming the selected display or set values.
- ▶ Calling up computer information 75.

Symbol	Function
	With the lights switched on: Dimming instrument lighting, refer to page 89
	Calling up Check Control, refer to page 82
	Checking the engine oil level, refer to page 243
	Setting the time, refer to page 77
	Setting the date, refer to page 78
	Viewing service requirement display, refer to page 80

Exiting displays

The external temperature reading and the time reappear when you press button 2 or if you make no entries within approx. 15 seconds. If required, complete the current setting first.

Units of measure

The units for fuel consumption, route/distance, temperature, and pressure can be changed.

1. "Settings"
2. "Language/Units"

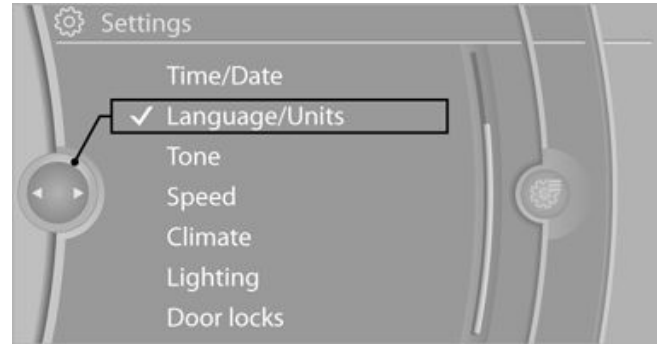

3. Select the desired menu item.
4. Select the desired unit.

The settings are stored for the remote control currently in use.

Clock

Setting the time

In the instrument cluster

To set the 12h/24h format, refer to Setting the time format below.

1. Press button 1 in the turn indicator lever up or down repeatedly until the appropriate symbol appears in the display, accompanied by the time and the word "SET".

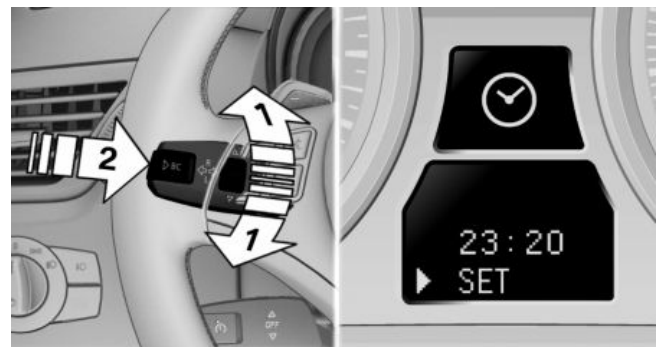

2. Press button 2.

3. Use button 1 to set the hours.
4. Press button 2 to confirm the entry.
5. Use button 1 to set the minutes.
6. Press button 2 to confirm the entry.
7. Press button 2.

The system accepts the new time.

Via the iDrive

1.  Press the button.
The main menu is displayed.

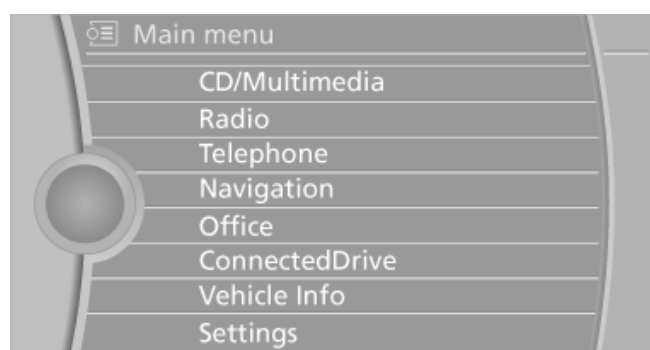

2. "Settings"

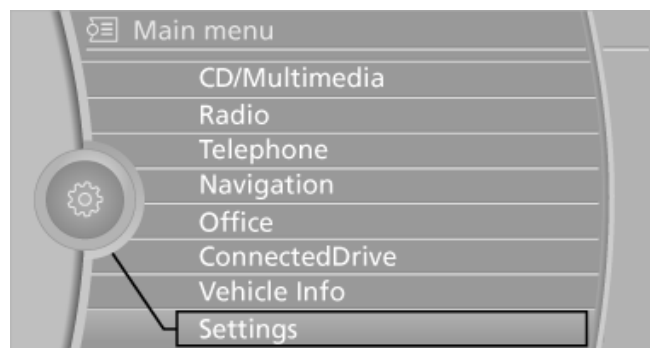

Setting the time zone

1. "Settings"
2. "Time/Date"
3. "Time zone:"
4. Select the desired time zone.

The time zone is stored.

Setting the time

1. "Settings"
2. "Time/Date"

3. "Time:"



4. Turn the controller until the desired hours are displayed, and then press the controller.
5. Turn the controller until the desired minutes are displayed, and then press the controller.

The time is stored.

Setting the time format

1. "Settings"
2. "Time/Date"
3. "Format:"
4. Select the desired format.

The time format is stored.

The settings are stored for the remote control currently in use.

Date

The settings are stored for the remote control currently in use, Personal Profile, refer to page 32.

Setting the date

In the instrument cluster

To set the dd/mm or mm/dd date format, refer to Setting the date format below.

1. Press button 1 in the turn indicator lever up or down repeatedly until the appropriate

symbol appears in the display, accompanied by the date and the word "SET".

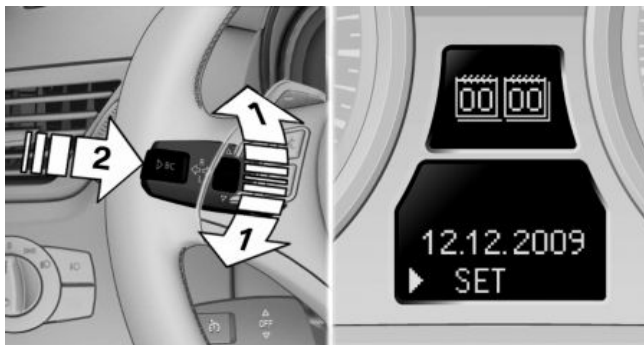

2. Press button 2.
3. Use button 1 to set the day of the month.
4. Press button 2 to confirm the entry.
5. Set the month and the year in the same way.
6. Press button 2.

The system stores the new date.

Via the iDrive

1. "Settings"
2. "Time/Date"
3. "Date:"
4. Turn the controller until the desired day is displayed, and then press the controller.
5. Make the necessary settings for the month and year.

The date is stored.

Setting the date format

1. "Settings"
2. "Time/Date"

3. "Format:"
4. Select the desired format.

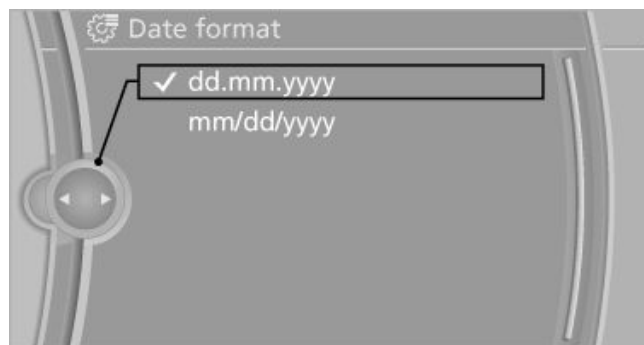

The date format is stored.

Settings on the Control Display

Language

Setting the language

1. "Settings"
2. "Language/Units"
3. "Language:"



4. Select the desired language.

The setting is stored for the remote control currently in use.

Setting the voice dialog

Voice dialog for the voice activation system, refer to page 28.

Brightness

Setting the brightness

The brightness is automatically adapted to the ambient lighting conditions. However, the basic setting can be adjusted.

1. "Settings"
2. "Control display"
3. "Brightness"

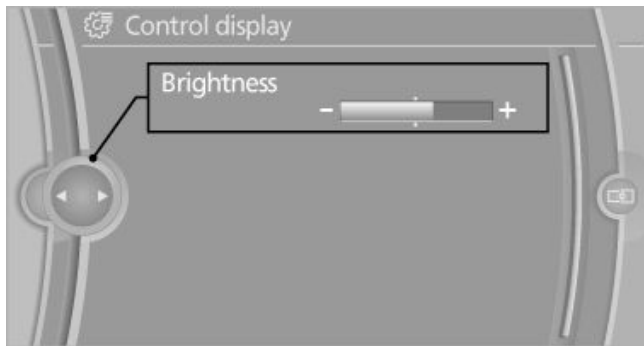

4. Turn the controller until the desired setting is selected.
5. Press the controller.

The setting is stored for the remote control currently in use.

Depending on the light conditions, the brightness control may not be clearly visible.

Service requirements



The remaining driving distance and the date of the next scheduled service are displayed briefly immediately after you start the engine or switch on the ignition.

The current service requirements can be read out from the remote control by the service specialist.



For certain maintenance operations, you can view the distance remaining or the due date for that operation in the instrument cluster.

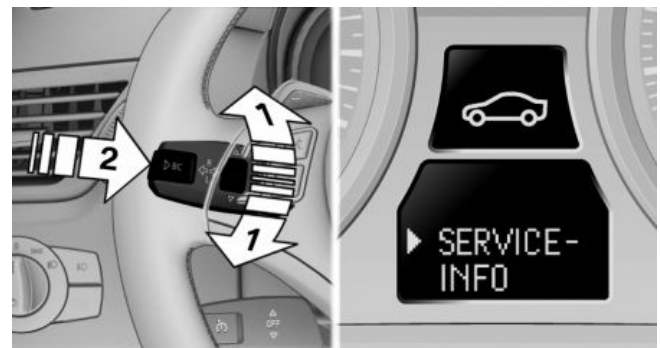



1. Switch on the ignition, refer to page 60.
2. Lightly press button 1 in the turn indicator lever up or down repeatedly until the appropriate symbol appears in the display, accompanied by the words "SERVICE INFO".



3. Press button 2.
4. Use button 1 to scroll through the individual service items.

Displays

Symbol	Function
	Service requirements
	Engine oil

Symbol	Function
	Roadworthiness test
	Front brake pads
	Rear brake pads
	Brake fluid

The sequence of displayed service items may vary. First the data for the next maintenance are displayed.

Detailed information on service requirements

More information on the scope of service required can be displayed on the Control Display.

1. "Vehicle Info"
2. "Vehicle status"

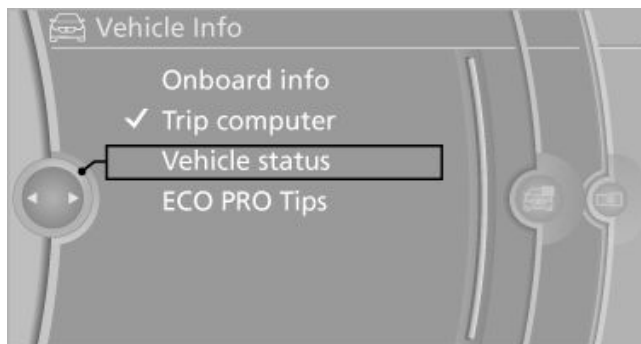

3.  "Service required"

Required maintenance procedures and legally mandated inspections are displayed.



Additional information can be displayed on each entry:

Select the entry and press the controller.

To exit from the menu:

Move the controller to the left.

Symbols

Symbols	Description
	No service is currently required.
	The deadline for scheduled maintenance or a legally mandated inspection is approaching.
	The service deadline has already passed.

Entering dates

Enter the dates for the required inspections.

Make sure the date on the Control Display is set correctly, refer to page 78.

1. "Vehicle Info"
2. "Vehicle status"
3.  "Service required"
4. "§ Vehicle inspection"

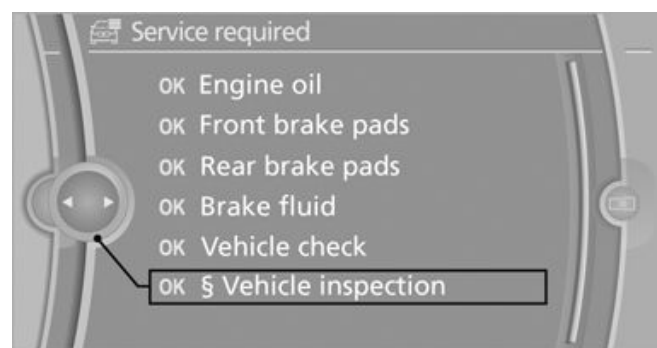

5. Open the menu for entering the deadline.

6. "Date:"
7. Create the settings.
8. Press the controller to apply the setting. The year is highlighted.
9. Turn the controller to make the adjustment.
10. Press the controller to apply the setting. The date entry is stored.

To exit from the menu:

Move the controller to the left.

Automatic Service Request

Data regarding the maintenance status or legally mandated inspections of the vehicle are automatically transmitted to your service center before a service due date.

You can check when your service center was notified.

1. "Vehicle Info"
2. "Vehicle status"
3. Open "Options".
4. "Last Service Request"

Check Control

The concept

The Check Control monitors vehicle functions and alerts you to any malfunctions in the systems monitored.

A Check Control message consists of indicator and warning lamps in the instrument cluster and, in some circumstances, an acoustic signal and text messages at the top of the Control Display.

Indicator/warning lamps



The indicator and warning lamps can light up in a variety of combinations and colors.

Several of the lamps are checked for proper functioning and light up temporarily when the engine is started or the ignition is switched on.

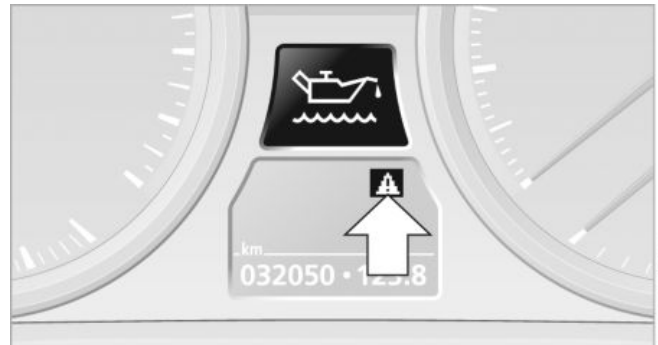

⚠ The symbol indicates that Check Control messages have been stored. The Check Control messages can be displayed later.

Text messages

Text messages at the upper edge of the Control Display in combination with a symbol in the instrument cluster explain a Check Control message and the meaning of the indicator and warning lamps.



Supplementary text messages

Additional information, such as on the cause of a fault or the required action, can be called up via Check Control.

In urgent cases, this information will be shown as soon as the corresponding lamp comes on.

Symbols

The following functions can be selected within the supplementary text message, depending on the Check Control message.

- ▶  "Service request"
Contact the service partner.
- ▶  "Roadside Assistance"
Contact Roadside Assistance.

Hiding Check Control messages

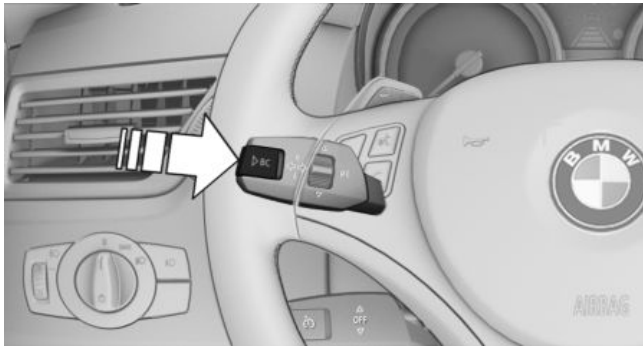

Press the computer button in the turn signal lever.

Some Check Control messages are displayed until the malfunctions have been rectified. They cannot be hidden.

If several malfunctions occur at once, the messages are displayed consecutively.



They are marked with the symbol shown here.

Other Check Control messages are hidden automatically after approx. 20 seconds. However, they are stored and can be displayed again later.



They are marked with the symbol shown here.

Viewing stored Check Control messages

1. Lightly press button 1 in the turn indicator lever up or down repeatedly until the appropriate symbol appears in the display,

accompanied by the words "CHECK CONTROL".

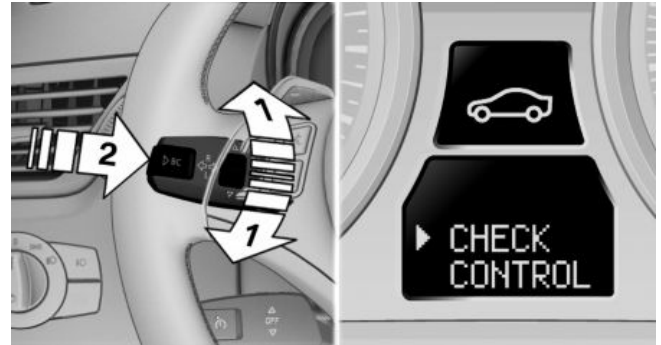

2. Press button 2.

If there is no Check Control message, this is indicated by "CHECK OK". If a Check Control message has been stored, the corresponding lamp comes on. It is accompanied by a text message on the Control Display.

3. Press button 1 to check for other messages.
4. Press button 2.

The display again shows the external temperature and the time.

Displaying stored Check Control messages

1. "Vehicle Info"
2. "Vehicle status"
3.  "Check Control"
4. Select the text message.

Messages after trip completion

Special messages that were displayed during a trip are displayed again after the ignition is switched off.

Speed limit

Entry of a speed limit which, when reached, should cause a Check Control message to be issued.

Renewed warning if the vehicle speed drops below the set speed limit once by at least 3 mph/5 km/h.

Displaying, setting or changing the limit

1. "Settings"
2. "Speed"
3. "Warning at:"

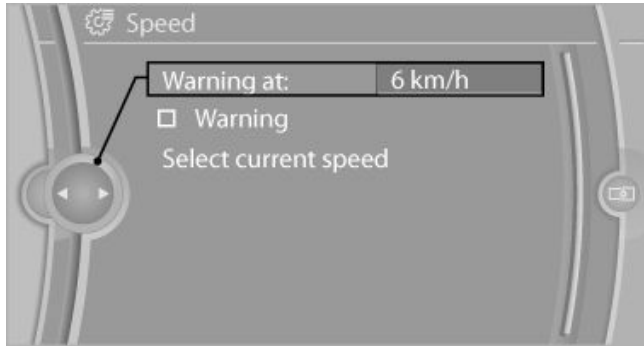

4. Turn the controller until the desired limit is displayed.
 5. Press the controller.
- The speed limit is stored.

Applying your current speed as the limit

1. "Settings"
2. "Speed"
3. "Select current speed"

The system adopts your current speed as the limit.

Activating/deactivating the limit

1. "Settings"
2. "Speed"
3. "Warning"

Lamps

Vehicle equipment

This chapter describes all series equipment as well as country-specific and special equipment offered for this model series. Therefore, it also describes equipment that may not be found in your vehicle, for instance due to the selected special equipment or the country version. This also applies to safety-related functions and systems.

When using the features and systems described here, adhere to local regulations.

At a glance

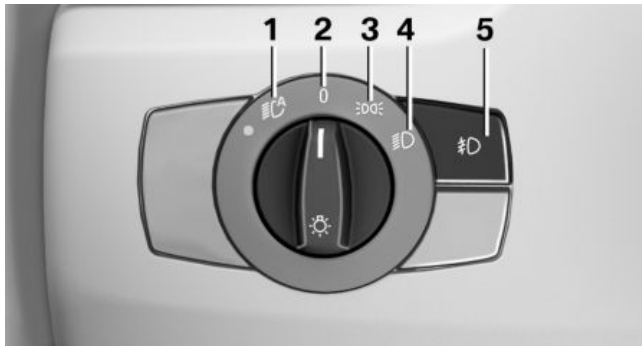

- 1 Automatic headlamp control / Adaptive Light Control / High-beam Assistant / welcome lamps / daytime running lights
- 2 Lamps off / daytime running lights
- 3 Parking lamps / daytime running lights
- 4 Low beams/welcome lamps
- 5 Fog lights

Parking lights/low beams, headlight control

General information

If the driver's door is opened while the ignition is switched off, the exterior lighting is switched

off automatically in the following switch settings:

0, , 

Parking lamps

Switch position  : the vehicle lamps light up on all sides, e.g., for parking.



Do not use the parking lamps for extended periods; otherwise, the battery may become discharged and it would then be impossible to start the engine.

When parking, it is preferable to switch on the one-sided roadside parking lamps, refer to page 87.

Low beams

Switch position  with the ignition switched on: the low beams light up.

Welcome lights

When parking the vehicle, leave the switch in position  or  : the parking and interior lamps light up briefly when the vehicle is unlocked.

Activating/deactivating the welcome lamps

1. "Settings"
2. "Lighting"
3. "Welcome light"

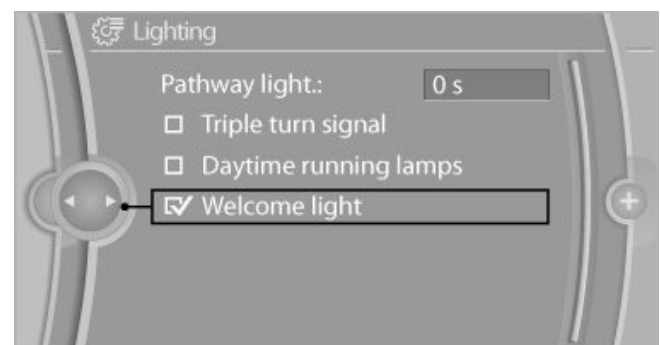

The setting is stored for the remote control currently in use.

Headlight courtesy delay feature

The low beams stay lit for a short while after the ignition is switched off, if the lights are switched off and the headlight flasher is switched on.

Setting the duration

1. "Settings"
2. "Lighting"
3. "Pathway light.: s"

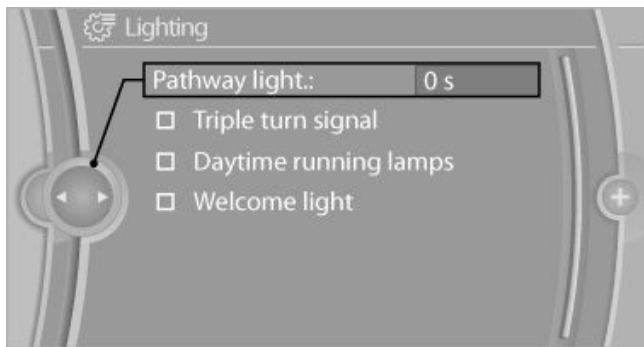

4. Set the duration.

The setting is stored for the remote control currently in use.

Automatic headlamp control

Switch position  : the low beams are switched on and off automatically, e.g., in tunnels, in twilight or if there is precipitation. The LED next to the symbol lights up.

A blue sky with the sun low on the horizon can cause the lights to be switched on.

The low beams remain switched on independent of the ambient lighting conditions when you switch on the front fog lamps.





Personal responsibility

The automatic headlamp control cannot serve as a substitute for your personal judgment in determining when the lamps should be switched on in response to ambient lighting conditions.

For example, the sensors are unable to detect fog or hazy weather. To avoid safety risks, you should always switch on the lamps manually under these conditions. ◀

Daytime running lights

The daytime running lights light up in position 0,  and . After the ignition is switched off, the parking lamps light up in position .

Activating/deactivating

In some countries, driving with daytime running lights is mandatory; for this reason, daytime running lights cannot be deactivated in these cases.

1. "Settings"
2. "Lighting"
3. "Daytime running lamps"



The setting is stored for the remote control currently in use.

Adaptive Light Control

The concept

Adaptive Light Control is a variable headlamp control system that enables dynamic illumination of the road surface.

Depending on the steering angle and other parameters, the light from the headlamp follows the course of the road.

In sharp curves, e.g. serpentines, or during turning, up to a certain speed one of the two

front fog lamps is switched on as a turning lamp. This provides improved illumination of the area inside the curve.

Controls

Activating

Switch position  with the ignition switched on.

The turning lamps are automatically switched on depending on the steering angle or the use of turn signals.

To avoid blinding oncoming traffic, the Adaptive Light Control does not swivel to the driver's side when the vehicle is at a standstill.

When driving in reverse, both turning lamps are active.

Malfunction



The warning lamp lights up. A message appears on the Control Display. Adaptive Light Control is malfunctioning or has failed. Have the system checked as soon as possible.

High-beams/roadside parking lights

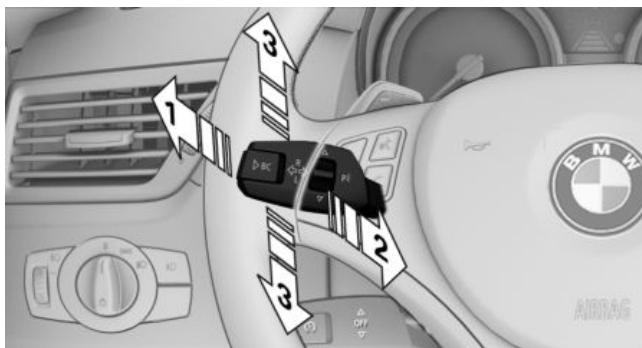

- 1 High-beams
- 2 Headlamp flasher
- 3 Roadside parking lamps

Left and right roadside parking lamps

The vehicle can be illuminated on one side.

Switching on

After parking the vehicle, press the lever up or down beyond the resistance point for approx. 2 seconds, arrow 3.

The roadside parking lights drain the battery. Therefore, do not leave them on for unduly long periods of time; otherwise, the battery might not have enough power to start the engine.

Switching off

Briefly press the lever in the opposite direction to the pressure point, arrow 3.

High-beam Assistant

The concept

When the lights are switched on, this system automatically switches the high beams on and off. The procedure is controlled by a sensor on the front of the interior rearview mirror. The assistant ensures that the high beams are switched on whenever the traffic situation allows. The driver can intervene at any time and switch the high beams on and off as usual.

Activating the High-beam Assistant

1. Turn the light switch to .
2. With the low beams switched on, briefly push the turn indicator lever in the direction of the high beam.



The indicator lamp in the instrument cluster lights up. The high beams are switched on and off automatically.

The system responds to light from oncoming traffic and traffic driving ahead of you, and to adequate illumination, e.g., in towns and cities.

Switching the high beams on and off manually

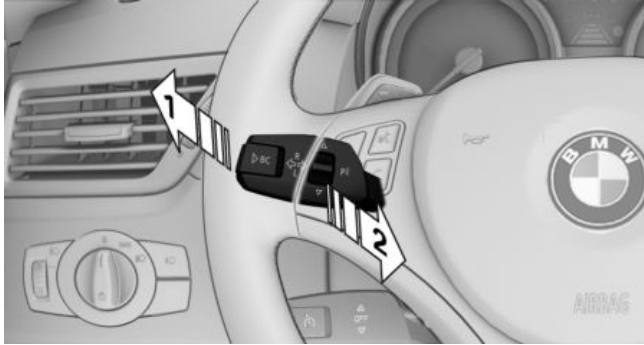

- ▷ High beams on, arrow 1.
- ▷ High beams off/headlamp flasher, arrow 2.

To reactivate the High-beam Assistant, briefly push the turn indicator lever toward the high beams.

Activating/deactivating via iDrive

1. "Settings"
2. "Lighting"
3. "High beam assistant"

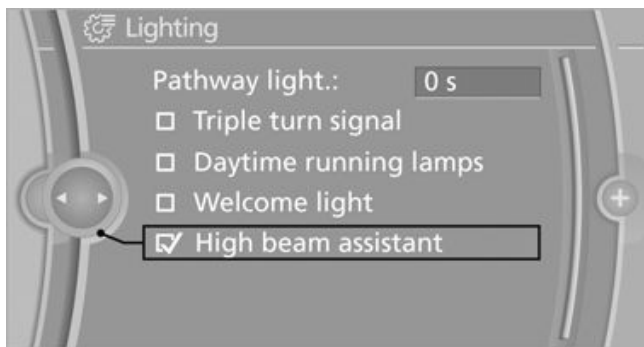

The setting is stored for the remote control currently in use.

System limits



Personal responsibility

The High-beam Assistant cannot serve as a substitute for the driver's personal judgment of when to use the high beams. Therefore, manually switch off the high beams in situations where this is required to avoid a safety risk. ◀

The system is not fully functional in situations such as the following, and driver intervention may be necessary:

- ▷ In very unfavorable weather conditions, such as fog or heavy precipitation.
- ▷ In detecting poorly-lit road users, such as pedestrians, cyclists, horseback riders and wagons; when driving close to train or ship traffic; and at animal crossings.
- ▷ In tight curves, on hilltops or in depressions, in cross traffic or half-observed oncoming traffic on freeways.
- ▷ In poorly-lit towns and cities and in the presence of highly reflective signs.
- ▷ At low speeds.
- ▷ When the windshield in front of the interior rearview mirror is fogged over, dirty or covered with stickers, etc.
- ▷ If the sensor view field is dirty.

The view field of the sensor is located on the front of the interior rearview mirror.

Do not cover this area with stickers, etc.

Clean the sensor view field with a cloth moistened with a small amount of glass cleaner.

Fog lights

Front fog lamps

The low beams must be switched on.



Press the button. The green indicator lamp in the instrument cluster lights up.

If the automatic headlamp control, refer to page 86, is activated, the low beams will come on automatically when you switch on the fog lamps.

Instrument lighting

The parking lamps or low beams must be switched on to adjust the brightness.

1. Push button 1 up or down repeatedly until the appropriate symbol appears in the display, accompanied by the brightness setting and the word "SET".

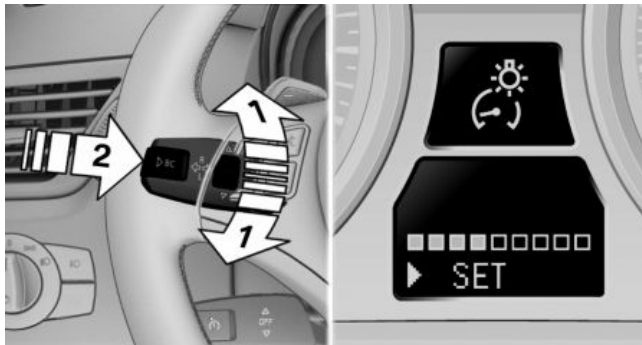

2. Press button 2.
3. Push button 1 up or down to select the desired brightness level.

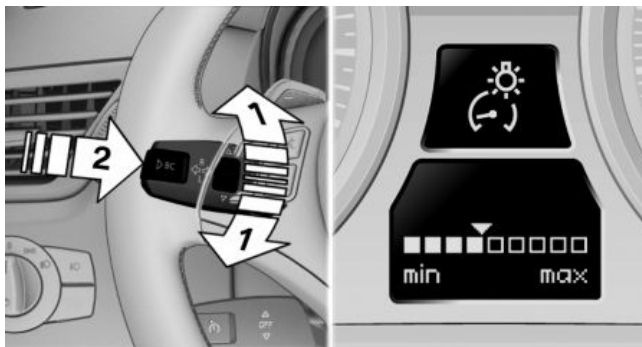

4. Press button 2.
The display again shows the external temperature and the time.

Interior lights

General information

The interior lights, footwell lights, cargo area lights, and courtesy lights are controlled automatically.

The LEDs for the courtesy lights are set in the door handles and illuminate the ground in front of the doors.

To avoid draining the battery, all lights inside the car are switched off about 8 minutes after the ignition is switched off, Start/Stop button, refer to page 59.



Switching the interior lights on and off



Press the button.

To switch off permanently: press the button for approx. 3 seconds.

To clear this setting: briefly press the button.

Reading lights



Press the button.

Reading lights are located at the front and rear next to the interior lights.



Danger of burns

Do not reach into the opening of the lamps; otherwise, there is a risk of burns. ◀

Ambient lighting

Depending on the equipment, the interior lighting can be set individually for some lights.

Selecting the color scheme

1. "Settings"
2. "Lighting"
3. "Ambient:"
4. Select the desired setting.

Safety

Vehicle equipment

This chapter describes all series equipment as well as country-specific and special equipment offered for this model series. Therefore, it also describes equipment that may not be found in your vehicle, for instance due to the selected

special equipment or the country version. This also applies to safety-related functions and systems.

When using the features and systems described here, adhere to local regulations.

Airbags

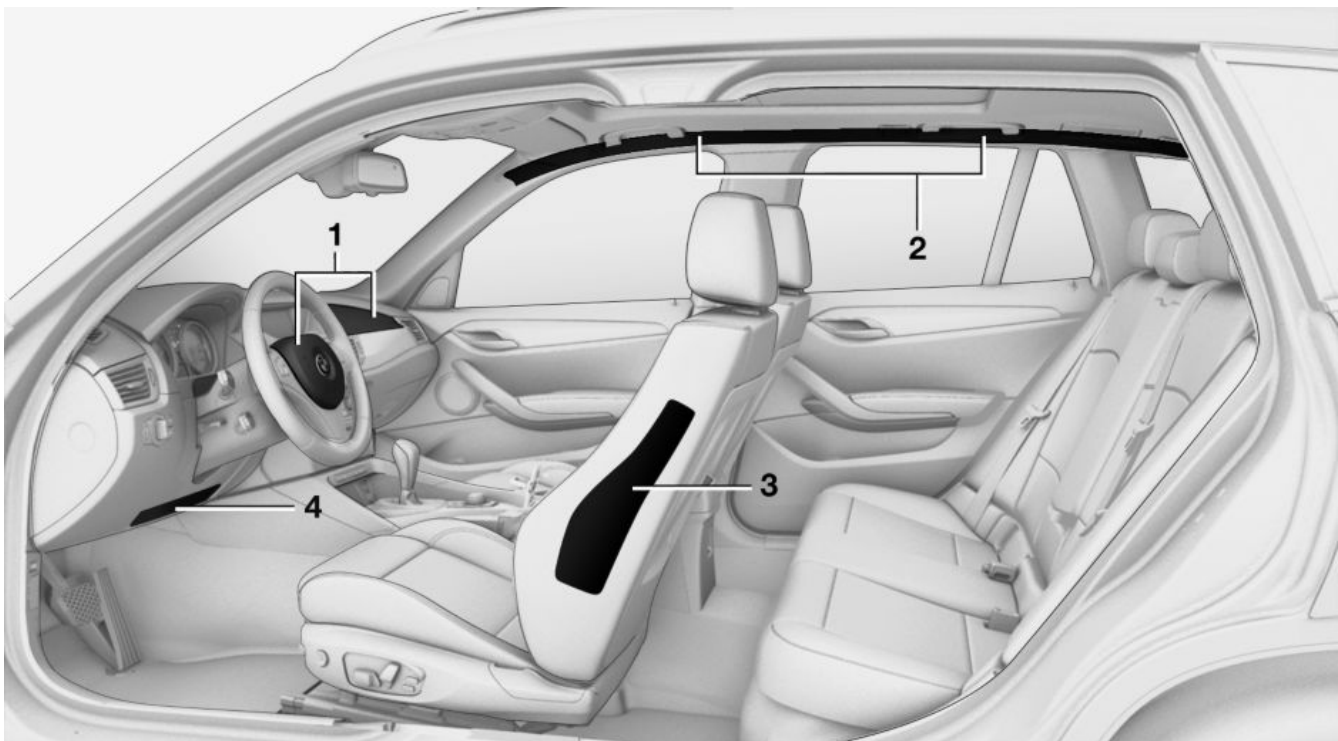

1 Front airbags

2 Head airbags

3 Side airbags

4 Knee airbag

Front airbags

Front airbags help protect the driver and front passenger by responding to frontal impacts in which safety belts alone cannot provide adequate restraint.

Side airbags

In a lateral impact, the side airbag supports the side of the body in the chest and lap area.

Head airbags

In a lateral impact, the head airbag supports the head.

Knee airbag

The knee airbag supports the legs in a frontal impact.

Protective action

Airbags are not triggered in every impact situation, e.g., in less severe accidents or rear-end collisions.



Information on how to ensure the optimal protective effect of the airbags

- ▶ Keep at a distance from the airbags.
- ▶ Always grasp the steering wheel on the steering wheel rim, holding your hands at the 3 o'clock and 9 o'clock positions, to keep the danger of injury to your hands or arms as low as possible if the airbag is triggered.
- ▶ There should be no people, animals, or objects between an airbag and a person.
- ▶ Do not use the cover of the front airbag on the front passenger side as a storage area.
- ▶ Keep the dashboard and window on the front passenger side clear, i.e., do not cover with adhesive labels or coverings, and do not attach holders or cables such as for navigation instruments and mobile phones.
- ▶ Make sure that the front passenger is sitting correctly, i.e., keeps his or her feet and legs in the footwell; otherwise, leg injuries can occur if the front airbag is triggered.
- ▶ Do not place slip covers, seat cushions or other objects on the front passenger seat that are not approved specifically for seats with integrated side airbags.
- ▶ Do not hang pieces of clothing, such as jackets, over the backrests.
- ▶ Make sure that occupants keep their heads away from the side airbag and do not rest against the head airbag; otherwise, injuries can occur if the airbags are triggered.
- ▶ Do not remove the airbag restraint system.
- ▶ Do not remove the steering wheel.
- ▶ Do not apply adhesive materials to the airbag cover panels, cover them or modify them in any way.

- ▶ Never modify either the individual components or the wiring in the airbag system. This also applies to steering wheel covers, the dashboard, the seats, the roof pillars and the sides of the headliner. ◀

Even when all instructions are followed closely, injury from contact with the airbags cannot be ruled out in certain situations.

The ignition and inflation noise may lead to short-term and, in most cases, temporary hearing impairment in sensitive individuals.



In the case of a malfunction, deactivation and after triggering of the airbags

Do not touch the individual components immediately after the system has been triggered; otherwise, there is the danger of burns.

Only have the airbags checked, repaired or dismantled and the airbag generator scrapped by your service center or a workshop that has the necessary authorization for handling explosives.

Non-professional attempts to service the system could lead to failure in an emergency or undesired triggering of the airbag, either of which could result in injury. ◀

Warnings and information on the airbags are also found on the sun visors.

Automatic deactivation of the front passenger airbags

The system determines whether the front passenger seat is occupied by measuring the resistance of the human body.

The front and side airbags on the front passenger side are activated or deactivated accordingly by the system.

The indicator lamp above the interior rearview mirror shows the current status of the front passenger airbags, deactivated or activated, refer to Front passenger airbag indicator lamp below.



Leave feet in the footwell

Make sure that the front passenger keeps his or her feet in the footwell; otherwise, the front passenger airbags may not function properly. ◀



Child restraint fixing system in the front passenger seat

Before transporting a child on the front passenger seat, refer to the safety notes and instructions under Children on the front passenger seat, refer to page 54. ◀

Malfunction of the automatic deactivation system

When transporting older children and adults, the front passenger airbags may be deactivated in certain sitting positions. In this case, the indicator lamp for the front passenger airbags lights up.

In this case, change the sitting position so that the front passenger airbags are activated and the indicator lamp goes out.

If it is not possible to activate the airbags, have the person sit in the rear.

To make sure that occupation of the seat cushion can be detected correctly:

- ▶ Do not attach seat covers, seat cushion padding, ball mats or other items to the passenger seat unless they are specifically recommended by BMW.
- ▶ Do not place electronic devices on the passenger seat if a child restraint fixing system is mounted on the seat.
- ▶ Do not place objects under the seat that could press against the seat from below.

Indicator lamp for the front passenger airbags



The indicator lamp for the front passenger airbags indicates the operating state of the front passenger airbags.

The lamp indicates whether the airbags are activated or deactivated.



- ▶ The indicator lamp lights up when a child who is properly seated in a child restraint fixing system intended for that purpose is detected on the seat or the seat is empty. The airbags on the front passenger side are not activated.
 - ▶ The indicator lamp does not light up when, for example, a correctly seated person of sufficient size is detected on the seat. The airbags on the front passenger side are activated.
- Most child seats are detected by the system, Especially the child seats required by NHTSA at the time that the vehicle was manufactured. After installing a child seat, make sure that the indicator lamp for the front passenger airbags lights up. This indicates that the child seat has been detected and the front passenger airbags are not activated.

Operational readiness of airbag system



 When the ignition is switched on, refer to page 60, the warning lamp comes on briefly to indicate that the entire airbag system and the belt tensioners are operational.

Airbag system malfunction

- ▶ The warning lamp does not light up after the ignition is switched on.
- ▶ Warning light remains permanently on.

 Have the airbag system checked without delay if there is a malfunction

In the event of a malfunction in the airbag system, have it checked without delay; otherwise, there is the risk that the system will not function as intended even if a sufficiently severe accident occurs. ◀

FTM Flat Tire Monitor

The concept

The system does not measure the actual inflation pressure in the tires.

It detects a pressure loss in a tire by comparing the rotational speeds of the individual wheels while moving.

In the event of a pressure loss, the diameter and therefore the rotational speed of the corresponding wheel change. This is detected and reported as a flat tire.

Functional requirements

The system must have been initialized when the tire inflation pressure was correct; otherwise, reliable signaling of a flat tire is not ensured. Initialize the system after each correction of the tire inflation pressure and after every tire or wheel change.

System limits



Sudden tire damage

Sudden serious tire damage caused by external influences cannot be indicated in advance. ◀

A natural, even pressure loss in all four tires cannot be detected. Therefore, check the tire inflation pressure regularly.

The system could be delayed or malfunction in the following situations:

- ▶ When the system has not been initialized.
- ▶ When driving on a snowy or slippery road surface.
- ▶ Sporty driving style: slip in the drive wheels, high lateral acceleration.
- ▶ When driving with snow chains.

Status display

The current status of the Flat Tire Monitor can be displayed on the Control Display, e.g., whether or not the FTM is active.

1. "Vehicle Info"
2. "Vehicle status"
3.  "Flat Tire Monitor"

The status is displayed.

Initialization

The initialization process adopts the set inflation tire pressures as reference values for the detection of a flat tire. Initialization is started by confirming the inflation pressures.

Do not initialize the system when driving with snow chains.

1. "Vehicle Info"
2. "Vehicle status"
3.  "Reset"
4. Start the engine - do not drive away.
5. Start the initialization with "Reset".
6. Drive away.

The initialization is completed while driving, which can be interrupted at any time.

The initialization automatically continues when driving resumes.

Indication of a flat tire



The warning lamp lights up red. A message appears on the Control Display. In addition, a signal sounds.

There is a flat tire or a major loss in tire inflation pressure.

Reduce your speed and stop cautiously. Avoid sudden braking and steering maneuvers.



Do not continue driving without run-flat tires

Do not continue driving if the vehicle is not equipped with run-flat tires; continued driving may result in serious accidents. ◀

When a flat tire is indicated, DSC Dynamic Stability Control is switched on if necessary.

Actions in the event of a flat tire

Run-flat tires

Maximum speed

You can continue driving with a damaged tire at speeds up to 50 mph/80 km/h.

Continued driving with a flat tire

If continuing to drive with a damaged tire:

1. Avoid sudden braking and steering maneuvers.
2. Do not exceed a speed of 50 mph/80 km/h.
3. At the next opportunity, check the inflation pressure in all four tires.

If the tire inflation pressure in all four tires is correct, the Flat Tire Monitor may not have been initialized. In this case, initialize the system.

Possible driving distance with complete loss of tire inflation pressure:

The possible driving distance after a loss of tire inflation pressure depends on the cargo load and the driving style and conditions.

For a vehicle containing an average load, the possible driving distance is approx. 50 miles/80 km.

When the vehicle is driven with a damaged tire, its handling characteristics change, e.g., reduced lane stability during braking, a longer braking distance, and altered self-steering properties. Adjust your driving style accordingly. Avoid abrupt steering maneuvers or driving over obstacles, e. g., curbs, potholes, etc.

Because the possible driving distance depends on how the vehicle is used during the trip, the actual distance may be smaller or greater depending on the driving speed, road conditions, external temperature, cargo load, etc.



Continued driving with a flat tire

Drive moderately and do not exceed a speed of 50 mph/80 km/h.

A loss of tire inflation pressure results in a change in the handling characteristics, e.g., reduced lane stability during braking, a longer braking distance and altered self-steering properties. ◀

**Final tire failure**

Vibrations or loud noises while driving can indicate the final failure of the tire. Reduce speed and stop; otherwise, pieces of the tire could come loose and cause an accident. Do not continue driving, and contact your service center. ◀

Tire Pressure Monitor TPM

The concept

The system monitors the tire pressure in the four mounted tires. The system issues a warning if there is a significant loss of pressure in one or more tires. Sensors in the tire valves measure the tire pressure.

Notes



Tire damage caused by external influences

Sudden tire damage caused by external influences cannot be indicated in advance. ◀

To operate the system, also note the additional information and instructions contained under Tire inflation pressure, refer to page 232.

Functional requirements

The system must have been reset while the inflation pressure was correct; otherwise, reliable signaling of pressure loss is not ensured.

Reset the system after adjusting the tire inflation pressure and after changing a tire or wheel.

Always use wheels with TPM electronics to ensure that the system will operate properly.

Status display

1. "Vehicle Info"
2. "Vehicle status"
3.  "TPM"

The status is displayed.

Status indicator on the Control Display

The tire and system status is indicated by the color of the tires.

A change in the tire inflation pressure during driving is taken into account.

All wheels are green

The system is active and issues warnings in case of deviations from the tire inflation pressures stored last.

"TPM active" appears on the Control Display.

One wheel is yellow

Flat tire or major drop in inflation pressure in the indicated tire. A message appears on the Control Display.

All wheels are yellow

- ▶ Flat tire or major drop in inflation pressure in several tires.
- ▶ The system was not reset after a wheel change and issues warnings when the tire pressure deviates from the tire inflation pressures stored last.
- ▶ A flat tire in one or more tires while the system is being reset.

A message appears on the Control Display.

The wheels are gray

The system cannot detect a flat tire.

Possible reasons for this:

- ▶ TPM is being reset.
- ▶ Disturbance by systems or devices with the same radio frequency.
- ▶ Malfunction.

Status information

The status control display additionally shows the current tire inflation pressures. It shows the actual values read; they may vary depending on driving style or weather conditions.

Resetting the system

Reset the system after adjusting the tire inflation pressure and every time a tire or wheel is changed.

1. "Vehicle Info"
2. "Vehicle status"
3. "Reset"
4. Start the engine, but do not start driving.
5. Start the system reset with "Reset".
6. Drive away.

The tires are shown in gray and "Resetting TPM..." is displayed.

After a short trip at over 30 km/h, the set tire inflation pressures are adopted as target values. The system reset is completed as you drive, and can be interrupted at any time. When driving resumes, the reset is continued automatically. On the Control Display, the tires are shown in green and "TPM active" is displayed again.

The trip can be interrupted at any time. When driving resumes, the reset is continued automatically.

If a flat tire is detected while the system is resetting, all tires on the Control Display are displayed in yellow. The message "Low tire!" is shown.

Low tire pressure message



The small warning light lights up yellow and the large warning light lights up red. A message appears on the Control Display. In addition, a signal sounds.

- ▶ There is a flat tire or a major loss in tire inflation pressure.
- ▶ The system was not reset. The system therefore issues warnings in case of deviations from the tire inflation pressures stored last.

Reduce your speed and stop cautiously. Avoid sudden braking and steering maneuvers.



Do not continue driving without run-flat tires

Do not continue driving if the vehicle is not equipped with run-flat tires; continued driving may result in serious accidents. ◀

When a flat tire is indicated, DSC Dynamic Stability Control is switched on if necessary.

Actions in the event of a flat tire

Run-flat tires

Maximum speed

You can continue driving with a damaged tire at speeds up to 50 mph/80 km/h.

Continued driving with a flat tire

If continuing to drive with a damaged tire:

1. Avoid sudden braking and steering maneuvers.
2. Do not exceed a speed of 50 mph/80 km/h.
3. Check the air pressure in all four tires at the next opportunity.

If the tire inflation pressure in all four tires is correct, the Tire Pressure Monitor may not have been reset. Reset the system.

Possible driving distance with complete loss of tire inflation pressure:

The possible driving distance after a loss of tire inflation pressure depends on the cargo load and the driving style and conditions.

For a vehicle containing an average load, the possible driving distance is approx. 50 miles/80 km.

When the vehicle is driven with a damaged tire, its handling characteristics change, e.g., reduced lane stability during braking, a longer braking distance, and altered self-steering properties. Adjust your driving style accord-

ingly. Avoid abrupt steering maneuvers or driving over obstacles, e. g., curbs, potholes, etc.

Because the possible driving distance depends on how the vehicle is used during the trip, the actual distance may be smaller or greater depending on the driving speed, road conditions, external temperature, cargo load, etc.



Continued driving with a flat tire

Drive moderately and do not exceed a speed of 50 mph/80 km/h.

A loss of tire inflation pressure results in a change in the handling characteristics, e.g., reduced lane stability during braking, a longer braking distance and altered self-steering properties. ◀



Final tire failure

Vibrations or loud noises while driving can indicate the final failure of the tire. Reduce speed and stop; otherwise, pieces of the tire could come loose and cause an accident. Do not continue driving, and contact your service center. ◀

Message when the system was not reset



The yellow warning light lights up. A Check Control message is displayed. The system may not have been reset although a wheel was changed.

Check the tire inflation pressure and reset the system, refer to page 96.

System limits

The system does not function properly if it has not been reset, e.g., it may identify a tire as flat in spite of the fact that the tire is filled to the correct inflation pressure.

The tire pressure depends on the temperature of the tire. An increase in the tire temperature, e.g., while driving or due to sunlight, increases the tire inflation pressure. The tire pressure

decreases when the tire temperature drops. In case of severe temperature drops, this behavior may lead to a warning on account of the defined warning limits.

Malfunction



The small warning light flashes in yellow and then lights up continuously; the larger warning light comes on in yellow. On the Control Display, the tires are shown in gray and a message appears. No flat tire can be detected.

Display in the following situations:

- ▶ A wheel without TPM electronics is fitted: have the service center check it if necessary.
- ▶ Malfunction: have the system checked by your service center.
- ▶ TPM could not be fully reset. Reset the system again.



The small warning light flashes in yellow and then lights up continuously; the larger warning light comes on in yellow. On the Control Display, the tires are shown in gray and a message appears. No flat tire can be detected.

Display in the following situations:

- ▶ Disturbance by systems or devices with the same radio frequency: after leaving the area of the disturbance, the system automatically becomes active again.

Declaration according to NHTSA/FMVSS 138 Tire Pressure Monitoring Systems

Each tire, including the spare (if provided) should be checked monthly when cold and inflated to the inflation pressure recommended by the vehicle manufacturer on the vehicle placard or tire inflation pressure label (If your vehicle has tires of a different size than the size indicated on the vehicle placard or tire inflation pressure label, you should determine the proper tire inflation pressure for those tires.).

As an added safety feature, your vehicle has been equipped with a tire pressure monitoring system (TPMS) that illuminates a low tire pressure telltale when one or more of your tires is significantly under-inflated. Accordingly, when the low tire pressure telltale illuminates, you should stop and check your tires as soon as possible, and inflate them to the proper pressure. Driving on a significantly under-inflated tire causes the tire to overheat and can lead to tire failure. Under-inflation also reduces fuel efficiency and tire tread life, and may affect the vehicle's handling and stopping ability.

Please note that the TPMS is not a substitute for proper tire maintenance, and it is the driver's responsibility to maintain correct tire pressure, even if under-inflation has not reached the level to trigger illumination of the TPMS low tire pressure telltale.

Your vehicle has also been equipped with a TPMS malfunction indicator to indicate when the system is not operating properly. The TPMS malfunction indicator is combined with the low tire pressure telltale. When the system detects a malfunction, the telltale will flash for approximately one minute and then remain continuously illuminated. This sequence will continue upon subsequent vehicle startups as long as the malfunction exists. When the malfunction indicator is illuminated, the system may not be able to detect or signal low tire pressure as intended. TPMS malfunctions may occur for a variety of reasons, including the installation of replacement or alternate tires or wheels on the vehicle that prevent the TPMS from functioning properly. Always check the TPMS malfunction telltale after replacing one or more tires or wheels on your vehicle to ensure that the replacement or alternate tires and wheels allow the TPMS to continue to function properly.

Brake force display

The concept

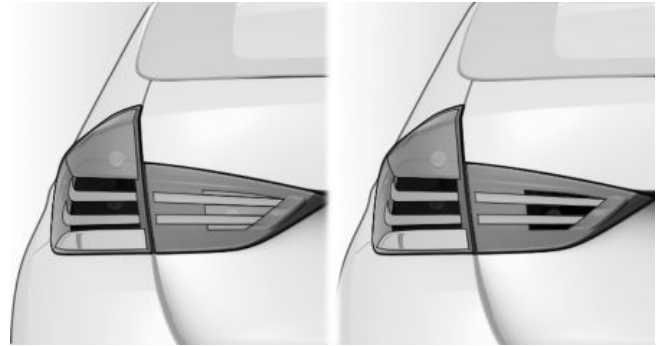

- ▶ During normal brake application, the outer brake lamps light up.
- ▶ During heavy brake application, the inner brake lamps light up in addition.

Driving stability control systems

Vehicle equipment

This chapter describes all series equipment as well as country-specific and special equipment offered for this model series. Therefore, it also describes equipment that may not be found in your vehicle, for instance due to the selected special equipment or the country version. This also applies to safety-related functions and systems.

When using the features and systems described here, adhere to local regulations.

Antilock Brake System ABS

ABS prevents locking of the wheels during braking.

The vehicle remains steerable even during full brake applications, thus increasing active safety.

ABS is operational every time you start the engine.

Electronic brake-force distribution

The system controls the brake pressure in the rear wheels to ensure stable braking behavior.

Brake assistant

When you apply the brakes rapidly, this system automatically produces the maximum braking force boost. It thus helps to achieve the shortest possible braking distance during full braking. This system utilizes all of the benefits provided by ABS.

Do not reduce the pressure on the brake pedal for the duration of the full braking.

Dynamic Stability Control DSC

The concept

DSC prevents traction loss in the driving wheels when driving away and accelerating.

DSC also recognizes unstable vehicle conditions, such as fishtailing or nose-diving. Subject to physical limits, DSC helps to keep the vehicle on a steady course by reducing engine speed and by applying brakes to the individual wheels.



Adjust your driving style to the situation

An appropriate driving style is always the responsibility of the driver.

The laws of physics cannot be repealed, even with DSC.

Do not reduce the additional safety margin with a risky driving style, as otherwise there is a risk of an accident. ◀

Deactivating DSC: DSC OFF

When DSC is deactivated, driving stability is reduced during acceleration and when driving in bends.

To increase vehicle stability, activate DSC again as soon as possible.

Deactivating DSC





Press and hold the button, but not longer than approx. 10 seconds, until the indicator lamp for DSC lights up in the instrument cluster and DSC OFF is displayed. DTC Dynamic Traction Control and DSC are deactivated together.

In the interest of better forward momentum, brake intervention is performed in the manner of a differential lock when the drive wheels spin quickly even if DSC is deactivated.

Activating DSC



Press the button.

DSC OFF and the indicator lamp in the instrument cluster go out.

For better control



The indicator lamp flashes: DSC controls the drive forces and brake forces.

The indicator lamp lights up: DSC and DTC has failed.

DSC deactivated:



The indicator lamp lights up and DSC OFF appears in the instrument cluster.

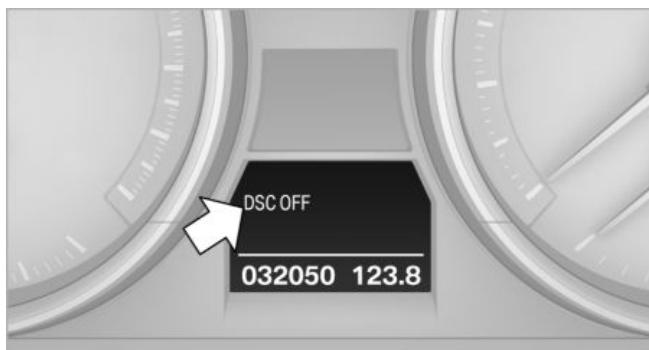

DSC and DTC deactivated.

Dynamic Traction Control DTC

The concept

The DTC system is a version of the DSC in which forward momentum is optimized.

The system ensures maximum forward momentum on special road conditions, e.g., unplowed snowy roads, but driving stability is limited.

It is therefore necessary to drive with appropriate caution.

You may find it useful to briefly activate DTC under the following special circumstances:

- ▶ When driving in sand, on snowy inclines, in slush, or on unplowed, snow-covered road surfaces
- ▶ When rocking a vehicle free or starting off in deep snow, sand, or on loose ground
- ▶ When driving with snow chains.

Deactivating/activating DTC Dynamic Traction Control

Activating the Dynamic Traction Control DTC provides maximum traction on loose ground. Driving stability is limited during acceleration and when driving in bends.

Activating DTC



Press the button.

TRACTION is displayed in the instrument cluster and the indicator lamp for DSC OFF lights up.

Deactivating DTC



Press the button again.

TRACTION and the indicator lamp in the instrument cluster go out.

For better control



The indicator lamp flashes: DTC controls the drive forces and brake forces.

The indicator lamp lights up: DSC and DTC has failed.

DTC activated:



The indicator lamp lights up and TRACTION appears in the instrument cluster.



DTC is activated.

Performance Control

Performance Control enhances the agility of your vehicle. To enhance performance during sporty driving, the rear wheel on the inside of the curve is braked while the resulting braking effect is largely compensated by engine intervention.

xDrive

xDrive is the all-wheel-drive system of your vehicle. The combined effects of xDrive and DSC further optimize the traction and dynamic driving characteristics. The 4-wheel drive system xDrive variably distributes the drive forces to

the front and rear axle depending on the driving situation and prevailing road conditions.

Hill Descent Control HDC

The concept

HDC is a downhill driving assistant that automatically controls vehicle speed on steep downhill gradients. Without requiring brake application, the vehicle moves at slightly more than twice walking speed.

You can activate the Hill Descent Control at speeds below approx. 22 mph/35 km/h. When driving downhill at below approx. 22 mph/35 km/h, the vehicle reduces its speed to approx. twice walking speed and keeps it constant.

While you are actively braking, the system is on standby. The system does not brake the vehicle during this time.

Increasing or reducing speed

The speed can be changed in the range from roughly twice walking speed to approx. 15 mph/25 km/h by pressing the accelerator or brake pedal lightly.

A target speed within the same range can be specified using the lever of the cruise control.

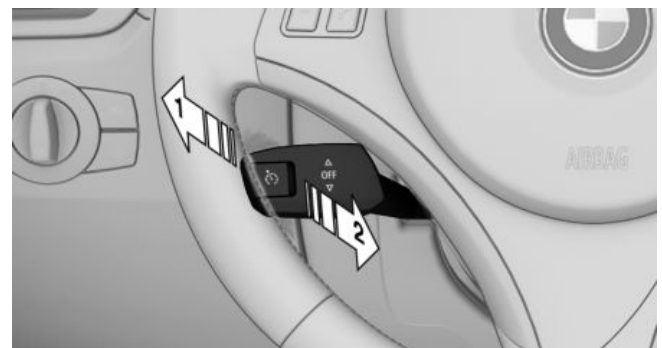

- 1 Increasing speed
- 2 Decreasing speed

Activating HDC



 Press the button; the LED above the button lights up.

The LED flashes when the brakes are applied automatically.

Deactivating HDC

 Press the button again; the LED goes out. HDC is automatically deactivated above approx. 37 mph/60 km/h.

Using HDC

HDC can be used in every driving position.

Displays in the instrument cluster



- 1 Display for target speed
- 2 HDC display

Malfunction

If the HDC display goes out during HDC operation or is not displayed: HDC is not available due to high brake temperatures or DSC has failed.

Drive-off assistant

This system supports driving away on gradients. The parking brake is not required.

1. Hold the vehicle in place with the foot brake.
2. Release the foot brake and drive away without delay.

Depending on the vehicle load, the vehicle may roll back slightly.

 Driving off without delay

After releasing the foot brake, start driving without delay, since the drive-off assistant will not hold the vehicle in place for more than approx. 2 seconds and the vehicle will begin rolling back. ◀

Servotronic

The concept

The Servotronic varies the steering force required to turn the wheels depending on the speed at which you are driving.

Power steering provides strong support at low speeds, which means that less effort is needed to turn the wheels. Power steering support lessens as your speed increases.

Malfunction

 The warning lamp lights up. A message appears on the Control Display. Servotronic is malfunctioning or has failed. Have the system checked as soon as possible.

Driving comfort

Vehicle equipment

This chapter describes all series equipment as well as country-specific and special equipment offered for this model series. Therefore, it also describes equipment that may not be found in your vehicle, for instance due to the selected special equipment or the country version. This also applies to safety-related functions and systems.

When using the features and systems described here, adhere to local regulations.

Cruise control

The concept

The system is functional at speeds beginning at approx. 20 mph/30 km/h.

The speed specified using the lever on the steering column is maintained.

The system brakes on downhill gradients if engine braking action is insufficient.



Do not use cruise control

Do not use the system if unfavorable conditions make it impossible to drive at a constant speed, for instance:

- ▶ On curvy roads.
- ▶ In heavy traffic.
- ▶ On slippery roads, in fog, snow or rain, or on a loose road surface.

Otherwise, you could lose control of the vehicle and cause an accident. ◀

One lever for all functions

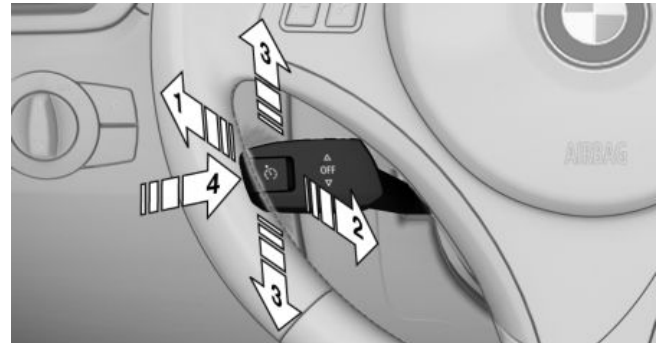

- 1 Storing and maintaining speed or accelerating
- 2 Storing and maintaining speed or decelerating
- 3 Deactivating cruise control
- 4 Resuming a speed stored beforehand

Maintaining current speed

Push, arrow 1, or pull, arrow 2, the lever to the resistance point.

The car's current speed is stored and maintained. It is displayed on the speedometer and briefly in the instrument cluster.

On uphill gradients, it may prove impossible to maintain the set speed if current engine power output is insufficient. If the engine braking effect is insufficient on downhill slopes, the system will brake the vehicle slightly.

Increasing desired speed

Repeatedly press the lever to the resistance point or beyond, arrow 1, until the desired speed is reached.

- ▶ Each time the lever is pressed to the point of resistance, the desired speed increases by approx. 1 mph/1 km/h.
- ▶ Each time the lever is pressed beyond the resistance point, the desired speed is increased by up to 5 mph/10 km/h.

The system stores and maintains the speed.

Accelerating using the lever

Accelerating slightly:

Press the lever to the resistance point, arrow 1, until the desired speed is reached.

Accelerating significantly:

Press the lever beyond the resistance point, arrow 1, until the desired speed is reached.

The vehicle accelerates without pressure on the accelerator pedal. The system stores and maintains the speed.

Decreasing speed

Repeatedly pull the lever to the resistance point or beyond, arrow 2, until the desired speed is displayed.

- ▶ Each time the lever is pulled to the resistance point, the desired speed is decreased by approx. 1 mph/1 km/h.
- ▶ Each time the lever is pulled beyond the resistance point, the desired speed is reduced by up to 5 mph/10 km/h until the minimum speed of 20 mph/30 km/h is achieved.

The system stores and maintains the speed.

Deactivating cruise control

Push the lever upwards or downwards, arrow 3.

The displays in the speedometer go out.

In addition, the system is automatically deactivated when:

- ▶ The brakes are applied.
- ▶ Selector lever position N is engaged or transmission position D is disengaged.
- ▶ When DTC is activated or DSC is deactivated.
- ▶ When DSC or ABS is intervening.

Cruise control is not deactivated by depressing the accelerator pedal. Once the accelerator

pedal is released, the stored speed is achieved again and maintained.

Warning light



The warning lamp comes on when cruise control has been deactivated as a result of DSC intervention, for example. A message appears on the Control Display.

Resuming a speed stored beforehand

Press the button, arrow 4. The last stored speed is resumed and maintained.

In the following cases, the stored speed value is deleted and cannot be called up again:

- ▶ When driving stability control systems intervene.
- ▶ When selector lever position N is engaged or transmission position D is disengaged.
- ▶ When the ignition is switched off.

Displays in the instrument cluster



- 1 Stored speed
- 2 Selected speed is displayed briefly

If the display --- mph or --- km/h appears briefly, conditions may not be adequate to operate the system.

Call up Check Control messages, refer to page [83](#).

Malfunction

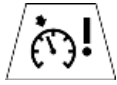

The warning light lights up. The system is malfunctioning or has failed.

A message appears on the Control Display. More information, refer to page 82.

Park Distance Control PDC

The concept

In addition to the PDC Park Distance Control, the backup camera, refer to page 107, can be switched on.

PDC supports you when parking. A slow approach to an object in front of or behind your vehicle is announced by:

- ▷ Signal tones.
- ▷ Visual display.

Measurement

Measurements are made by ultrasound sensors in the bumpers.

The range is approx. 6 ft/2 m.

An acoustic warning is first given:

- ▷ By the front sensors and two rear corner sensors at approx. 24 in/60 cm.
- ▷ By the rear middle sensors at approx. 5 ft/1.50 m.

System limits



Check the traffic situation as well

PDC cannot serve as a substitute for the driver's personal judgment of the traffic situation. Check the traffic situation around the vehicle with your own eyes. Otherwise, an accident could result from road users or objects located outside of the PDC detection range.

Loud noises from outside and inside the vehicle may prevent you from hearing the PDC's signal tone. ◀



Avoid driving quickly with PDC

Avoid approaching an object quickly.

Avoid driving away quickly while PDC is not yet active.

For technical reasons, the system may otherwise be too late in issuing a warning. ◀

Limits of ultrasonic measurement

The detection of objects can reach the physical limits of ultrasonic measurement, for instance:

- ▷ With tow bars and trailer hitches.
- ▷ With thin or wedge-shaped objects.
- ▷ With low objects.
- ▷ With objects with corners and sharp edges.

Low objects already displayed, e.g., curbs, can move into the blind area of the sensors before or after a continuous tone sounds.

High, protruding objects such as ledges may not be detected.

False warnings

PDC may issue a warning under the following conditions even though there is no obstacle within the detection range:

- ▷ In heavy rain.
- ▷ When sensors are very dirty or covered in ice.
- ▷ When sensors are covered in snow.
- ▷ On rough road surfaces.
- ▷ In large buildings with right angles and smooth walls, e.g., in underground garages.
- ▷ In heavy exhaust.
- ▷ Due to other ultrasound sources, e.g., sweeping machines, high pressure steam cleaners or neon lights.

Switching on automatically

With the engine running or the ignition switched on, shift the selector lever into position R.

Switching off automatically when driving forward

The system switches off when a certain distance or speed is exceeded.

Switch on the system again if necessary.

Switching on/off manually



Press the button.

- ▷ On: the LED lights up.
- ▷ Off: the LED goes out.

Signal tones

When approaching an object, an intermittent tone is sounded that indicates the position of the object. For example, if an object is detected behind the vehicle, a signal tone sounds from the rear speakers.

The shorter the distance to the object becomes, the shorter the intervals.

If the distance to a detected object is less than approx. 12 in/30 cm, a continuous tone is sounded.

If objects are located both in front of and behind the vehicle, an alternating continuous signal is sounded.

The intermittent tone is interrupted after approx. 3 seconds:

- ▷ If the vehicle stops in front of an object that is detected by only one of the corner sensors.
- ▷ If moving parallel to a wall.

The signal tone is switched off:

- ▷ When the vehicle moves away from an object by more than approx. 4 in/10 cm.
- ▷ When transmission position P is engaged.

Volume

You can set the volume of the PDC signal tone, refer to page 167.

The setting is stored for the remote control currently in use.

Visual warning

The approach to an object can be shown on the Control Display. Objects that are farther away are displayed on the Control Display before a signal tone sounds.

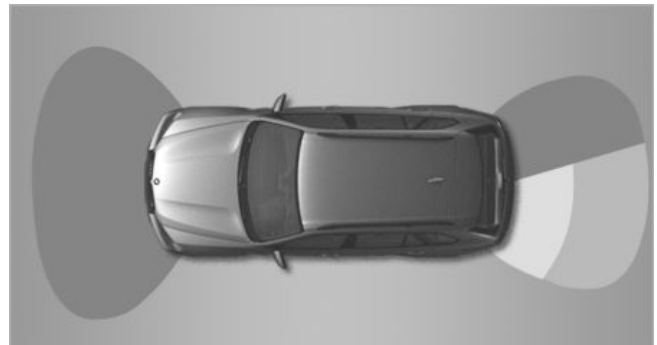

The display appears as soon as PDC is activated.

If the last image selected was the rearview camera, this is displayed again. To switch to PDC:

 "Switch off rear view camera"

The setting is stored for the remote control currently in use.

Image on the Control Display

Switching on the rear view camera using iDrive

With PDC activated:

"Rear view camera"

The image of the rear view camera is displayed. The setting is stored for the remote control currently in use.

Malfunction

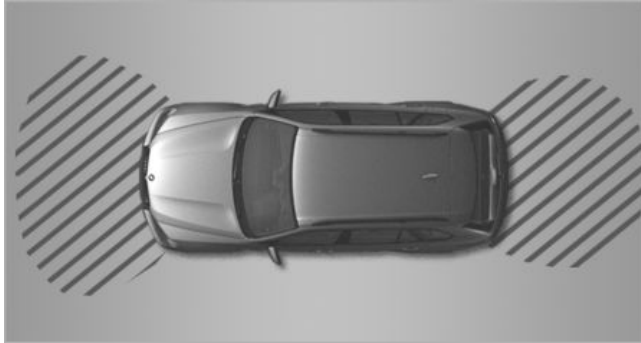

A Check Control message, refer to page 82, is displayed in the instrument cluster.

The areas in front of and behind the vehicle appear in shaded form on the Control Display. PDC has failed. Have the system checked.

To ensure full operability:

- ▷ Keep the sensors clean and free of ice.
- ▷ When using high-pressure washers, do not spray the sensors for long periods and maintain a distance of at least 12 in/30 cm.

Rear view camera

The concept

The rear view camera assists you when parking and maneuvering in reverse. To accomplish this, the region behind your vehicle is shown on the Control Display.

System limits



Check the traffic situation as well

Check the traffic situation around the vehicle with your own eyes. Otherwise, an accident could result from road users or objects located outside the picture area of the backup camera. ◀



Detection of objects

High, protruding objects such as ledges may not be detected by the backup camera. ◀

Switching on automatically

With the engine running or the ignition switched on, shift the selector lever into position R.

The image of the rear view camera is displayed when the system has been switched on using iDrive.

Switching off automatically when driving forward

The system switches off when a certain distance or speed is exceeded.

Switch on the system again if necessary.

Switching on/off manually



Press the button.

- ▷ On: the LED lights up.
- ▷ Off: the LED goes out.

If PDC is displayed, switch on the backup camera via the iDrive, refer to page 106.

Assistance functions

Functional requirement

- ▷ Rear view camera is switched on.
- ▷ Tailgate is completely closed.

Pathway lines

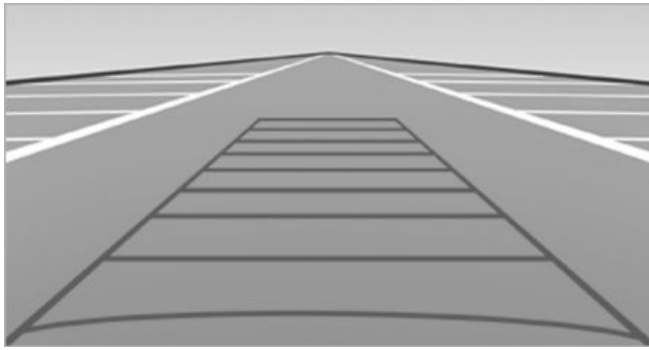

- ▶ Can be displayed in the image of the rear view camera when the transmission is in reverse.
- ▶ Help estimate the required amount of space when parking and maneuvering on a flat road surface.
- ▶ Depend on the current steering angle and are continuously adapted to movements of the steering wheel.

Show the parking aid lines via the iDrive, refer to page 109.

Turning lines

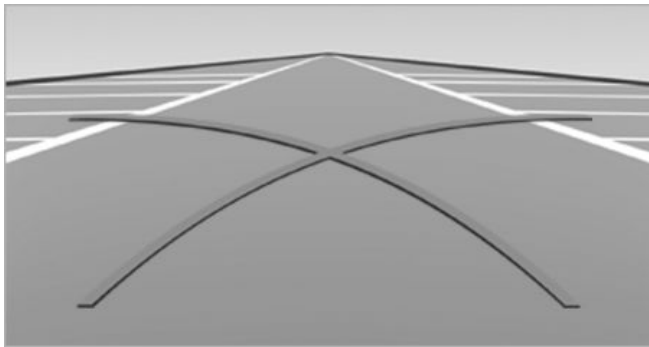

- ▶ Can be displayed in the image of the rear view camera.
- ▶ Show the path of the smallest turning circle on a flat road surface.
- ▶ When the steering wheel is turned, only one turning line is displayed.

Show the parking aid lines via the iDrive, refer to page 109.

Parking using pathway and turning lines

1. Position the vehicle so that the turning lines lead into the margins of the parking space.

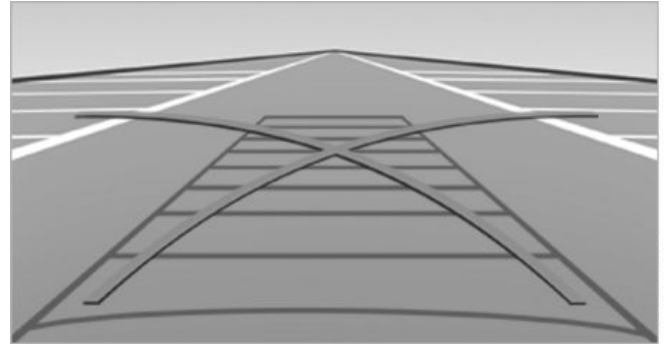

2. Turn the steering wheel to the point where the pathway line covers the corresponding turning circle line.

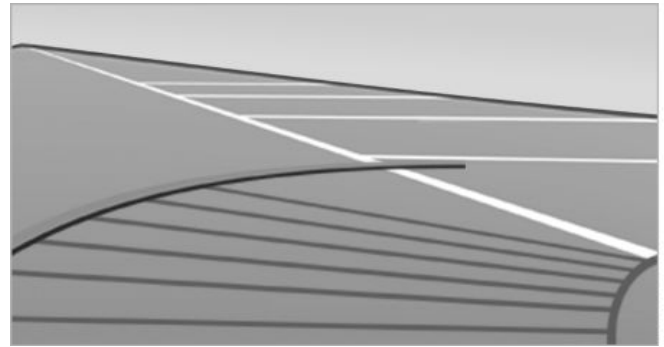

Obstacle marking

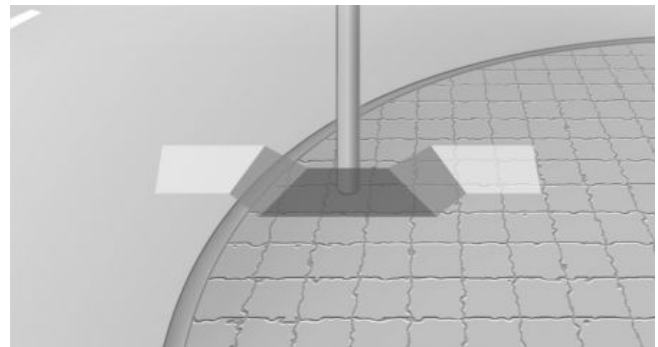

- ▶ Three-dimensionally shaped markings can be displayed in the image of the rear view camera.

Their color gradation corresponds to the markings in PDC. This helps estimate the distance to the object pictured.

Show the obstacle marking via the iDrive, refer to page 109.

Activating assistance functions

Several assistance functions can be active at the same time.

Showing the parking aid lines

 "Parking aid lines"

Pathway and turning lines are displayed.

Showing the obstacle marking

 "Obstacle marking"

Three-dimensionally-shaped markings are displayed.

Image on the Control Display

Switching on the rear view camera using iDrive

With PDC activated:

 "Rear view camera"

The image of the rear view camera is displayed. The setting is stored for the remote control currently in use.

Brightness

With the rear view camera switched on:

1.  Select the symbol.
2. Turn the controller until the desired setting is reached and press the controller.

Contrast

With the rear view camera switched on:

1.  Select the symbol.
2. Turn the controller until the desired setting is reached and press the controller.

Camera

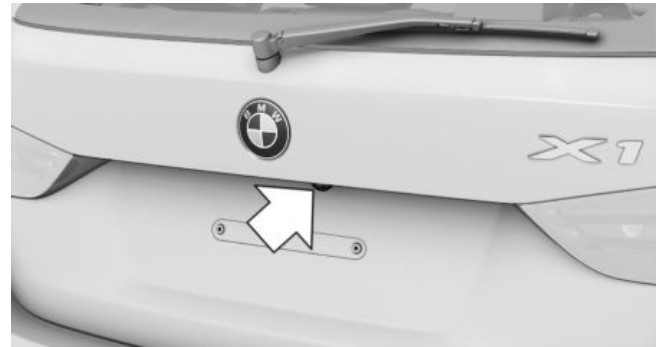

The lens of the rearview camera is under the grasping lip of the tailgate.

The presence of dirt can impair image quality. Clean the lens with a moist, nonabrasive cloth.

Climate

Vehicle equipment

This chapter describes all series equipment as well as country-specific and special equipment offered for this model series. Therefore, it also describes equipment that may not be found in your vehicle, for instance due to the selected

special equipment or the country version. This also applies to safety-related functions and systems.

When using the features and systems described here, adhere to local regulations.

Automatic climate control

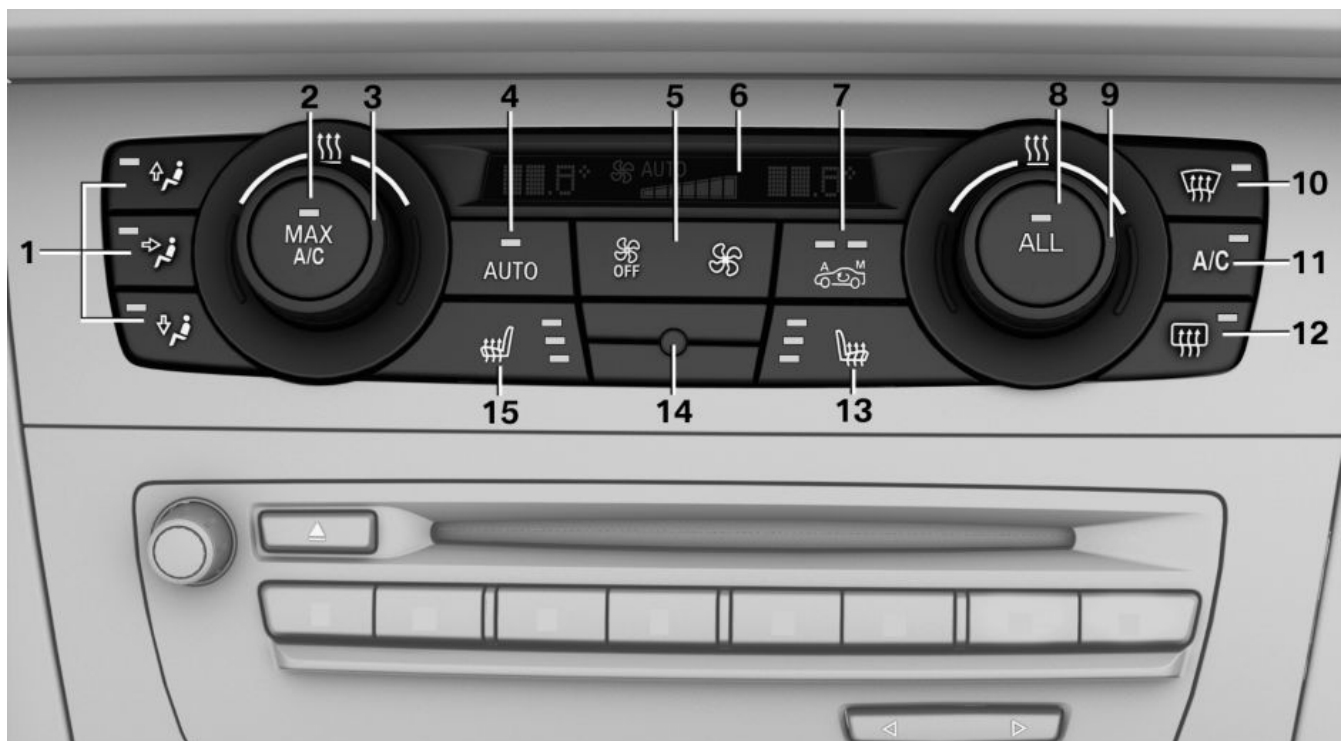

- | | |
|--|---|
| 1 Manual air distribution | 9 Temperature, right |
| 2 Maximum cooling | 10 Defrosting windows and removing condensation |
| 3 Temperature, left | 11 Switching cooling function on/off manually |
| 4 AUTO program | 12 Rear window defroster |
| 5 Manual air flow rate, AUTO intensity | 13 Seat heating, right 48 |
| 6 Display | 14 Interior temperature sensor, please keep clear |
| 7 Automatic recirculated air control/recirculated air mode | 15 Seat heating, left 48 |
| 8 ALL program | |

Note



Sufficient ventilation

When remaining in the vehicle for an extended period of time, ensure sufficient external ventilation. Do not continuously use recirculated-air mode; otherwise the air quality in the interior continuously worsens. ◀

Comfortable interior climate



For almost all conditions, the AUTO program 4 offers the optimum air distribution and air flow rate, refer to AUTO program below. Select a comfortable interior temperature only.

The following sections contain more detailed information on the available setting options.

Most of these settings are stored for the remote control currently in use, Personal Profile settings, refer to page 33.

Manual air distribution

Press the buttons repeatedly to select a program:

- ▷  Windows.
- ▷  Upper body region.
- ▷  Footwell.

The programs can be combined as necessary.

Temperature



Turn the wheel to set the desired temperature.

The automatic climate control achieves this temperature as quickly as possible, if necessary with the maximum cooling or heating capacity, and then keeps it constant.

Avoid rapidly switching between different temperature settings. The automatic climate control will not have sufficient time to adjust the set temperature.

Maximum heating power can be obtained with the highest setting, regardless of the external temperature.

At the lowest setting, cooling is continuous, regardless of the external temperature.

Maximum cooling



Press the button.

The system is set to the lowest temperature, maximum air volume and recirculated-air mode.

Air flows out of the vents for the upper body region. Open them for this purpose.

Air is cooled as quickly as possible:

- ▷ At an external temperature of approx. 32 °F/0 °C.
- ▷ When the engine is running.

AUTO program



Press the button.

Air volume, air distribution, and temperature are controlled automatically.

Depending on the selected temperature, AUTO intensity, and outside influences, the air is directed to the windshield, side windows, upper body, and into the footwell.

The cooling function is switched on automatically with the AUTO program.

At the same time, a condensation sensor controls the program in such a way that window condensation is prevented as much as possible.

To switch off the program: press the button again or manually adjust the air distribution.

Intensity of the AUTO program

With the AUTO program switched on, automatic control of the air volume and air distribution can be adjusted:



Press the left or right side of the button: decrease or increase the intensity.

The selected intensity is shown on the display of the automatic climate control.

Air volume, manual

To be able to manually adjust the air volume, switch off the AUTO program first.



Press the left or right side of the button: decrease or increase air volume.

The selected air volume is shown on the display of the automatic climate control.

The air volume of the automatic climate control may be reduced automatically to save battery power.

Automatic recirculated air mode/ recirculated air mode

You can respond to unpleasant odors or pollutants in the immediate environment by temporarily suspending the supply of outside air. The system then recirculates the air currently within the vehicle.



Press the button repeatedly to select an operating mode:

- ▷ LEDs off: outside air flows in continuously.
- ▷ Left LED on, automatic recirculated-air control: a sensor detects pollutants in the outside air and controls the shutoff automatically.
- ▷ Right LED on, recirculated air mode: the supply of outside air into the vehicle is permanently blocked.

If the windows are fogged over, switch off the recirculated-air mode and press the AUTO button to utilize the condensation sensor. Make sure that air can flow onto the windshield.

Via the button on the steering wheel

A button on the steering wheel can be used to quickly switch between recirculated air mode and the previous setting.

ALL program



Press the button.

The current temperature setting for the driver's side is transferred to the front passenger side.

If the temperature setting is changed on the driver's side, the temperature on the front passenger side changes as well.

The program is switched off if the setting is changed on the front passenger side or the button is pressed again.

Defrosting and defogging windows



Press the button.

Ice and condensation are quickly removed from the windshield and the front side windows.

For this purpose, also switch on the cooling function.

Cooling function

The passenger compartment can only be cooled with the engine running.



Press the button.

The air is cooled and dehumidified and – depending on the temperature setting – warmed again.

Depending on the weather, the windshield may fog up briefly when the engine is started.

The cooling function is switched on automatically with the AUTO program.

When using the automatic climate control, condensation water, refer to page 134, develops that exits underneath the vehicle.

Rear window defroster



Press the button.

The rear window defroster switches off automatically after a certain period of time.

Switching the system on/off

Switching off



Press and hold the left button or, with the setting at the lowest level, press the left button.

All displays are cleared except for the rear window defroster if it is switched on.

When the automatic climate control is switched off, the supply of outside air is suspended. If the air quality deteriorates or the window fogs over, switch the system back on and increase the air flow rate.

Switching on

Press any button, except for the buttons for the ALL program or rear window heating.

Ventilation

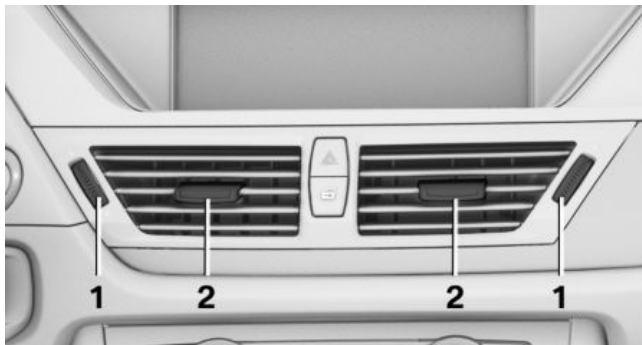

- 1 Use the thumbwheels to smoothly open and close the air vents
- 2 Use the lever to change the direction of the air flow

Ventilation for cooling

Adjust the vent to direct the air in your direction, e.g., if the vehicle interior is hot from the sun.

Draft-free ventilation

Adjust the vent to let the air flow past you.

Microfilter/activated-charcoal filter

The microfilter traps dust and pollen in the incoming air.

The activated-charcoal filter removes gaseous pollutants from the outside air that enters the vehicle.

Your service center replaces this combined filter during routine maintenance.

Parked-car ventilation

The concept

The parked-car ventilation blows air into the passenger compartment to lower interior temperatures.

The system can be switched on and off at any external temperature, either directly or by using a preset switch-on time. It remains switched on for 30 minutes.

Since the system uses a substantial amount of electrical current, refrain from activating it twice in succession without allowing the battery to be recharged in normal operation between use.

Open the vents to allow air to flow out.

They can be operated via iDrive.

Switching on/off directly

1. "Settings"
2. "Climate"

3. "Activate parked-car vent."

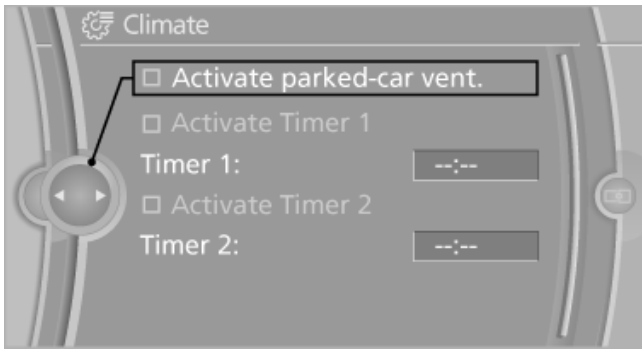

☞ The symbol on the automatic climate control flashes if the system is switched on.

Preselecting activation times

1. "Settings"
2. "Climate"
3. "Activate Timer 1" or "Activate Timer 2"
4. "Timer 1:" or "Timer 2:"

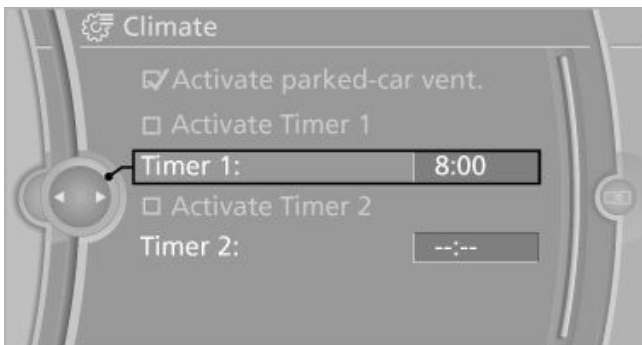

5. Set the desired time.

☞ The symbol on the automatic climate control lights up when the switch-on time is activated.

☞ The symbol on the automatic climate control flashes when the system has been switched on.

The system will only be switched on within the next 24 hours. After that, it needs to be reactivated.

Interior equipment

Vehicle equipment

This chapter describes all series equipment as well as country-specific and special equipment offered for this model series. Therefore, it also describes equipment that may not be found in your vehicle, for instance due to the selected special equipment or the country version. This also applies to safety-related functions and systems.

When using the features and systems described here, adhere to local regulations.

Universal garage door opener

The concept

The universal garage door opener can be used to operate up to 3 functions in remote-controlled systems, such as garage door drives or lighting systems. The universal garage door opener replaces up to 3 different hand-held transmitters. To operate it, the buttons on the interior rearview mirror must be programmed for the desired functions. The hand-held transmitter for the system is needed for the programming procedure.



During programming

During programming and before activating a device using the Universal Garage Door Opener, ensure that there are no people, animals, or objects in the range of movement of the remote-controlled device; otherwise, there is a risk of injury or damage.

Also follow the safety instructions of the hand-held transmitter. ◀

Before selling the vehicle, delete the stored functions for security reasons.

Compatibility



If this symbol is printed on the packaging or in the operating instructions of the system being operated, the system is generally compatible with the universal garage door opener.

If you have any questions, please contact:

- ▷ Your service center.
- ▷ www.homelink.com on the Internet.

HomeLink is a registered trademark of the Gentex Corporation.

Controls on the interior rearview mirror

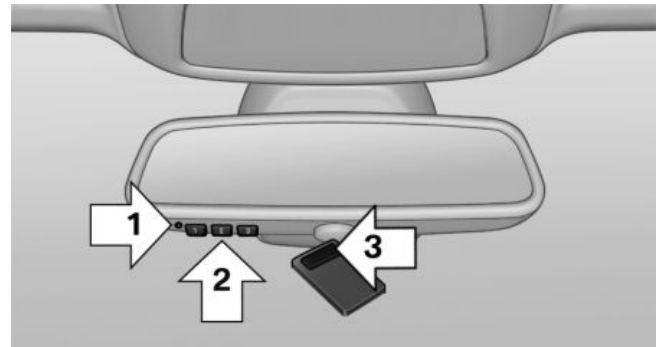

- 1 LED
- 2 Buttons
- 3 Hand-held transmitter, required for programming.

Programming

General information

1. Switch on the ignition.
2. Initial setup:

Press the right and left buttons on the interior rearview mirror simultaneously for approx. 20 seconds until the LED on the interior rearview mirror begins to flash. All programmed settings of the buttons on the interior rearview mirror are deleted.

3. Hold the hand-held transmitter of the system to be operated a distance of approx. 1 to 3 in/2.5 to 8 cm away from the buttons on the interior rearview mirror. The required distance depends on the particular hand-held transmitter.
4. Press the button of the desired function on the hand-held transmitter and the button being programmed on the interior rearview mirror simultaneously and hold. The LED on the interior rearview mirror flashes slowly at first.
5. When the LED flashes more rapidly, release both buttons. Rapid flashing indicates that the button on the interior rearview mirror has been programmed.
If the LED does not flash faster after 60 seconds, change the distance between the interior rearview mirror and the hand-held transmitter and repeat the step. Multiple trials at different distances may be necessary. Wait at least 15 seconds between trials.
6. To program additional functions on other buttons, repeat steps 3 to 5.

The systems can be operated with the buttons on the interior rearview mirror.

Special characteristics of alternating-code radio systems

If the system cannot be operated after repeated programming, check whether the system to be operated uses an alternating-code system.

Read the operating instructions of the system or press and hold the programmed button on the interior rearview mirror. If the LED on the interior rearview mirror flashes rapidly at first and then lights up continuously for 2 seconds, the system is equipped with an alternating-code system. This flashing LED pattern repeats itself for approx. 20 seconds.

In systems with an alternating-code system, the universal garage door opener and the system must be additionally synchronized.

Please obtain additional information on synchronization in the operating instructions of the system being set up.

The systems will be easier to synchronize with the aid of a second person.

Synchronization:

1. Park the vehicle within range of the remote-controlled system.
2. Program the corresponding button on the interior rearview mirror as described.
3. Identify and press the synchronization button on the system being set up. You have approx. 30 seconds for the next step.
4. Press and hold the button on the interior rearview mirror for approx. 3 seconds and then release it. Repeat this step up to three times if necessary to complete the synchronization procedure. When synchronization is completed, the programmed function is executed.

Reprogramming individual buttons

1. Switch on the ignition.
2. Hold the hand-held transmitter at a distance of approx. 1 to 3 in/2.5 to 8 cm from the memory buttons.

The required distance depends on the particular hand-held transmitter.

3. Press the memory button of the universal garage door opener.
4. If the LED flashes slowly after approx. 20 seconds, press the transmit button on the hand-held transmitter.
5. Release both buttons when the LED flashes rapidly.

If the LED does not flash rapidly after approx. 60 seconds, change the distance and repeat the step.

Canada: if the LED does not flash rapidly after approx. 60 seconds, change the distance and repeat the step. If programming was aborted by the hand-held transmitter, hold down the memory button and press and release the button on the hand-held transmitter several times for 2 seconds.

Controls



Prior to operation

Before operating a unit with the Universal Garage Door Opener, ensure that there are no people, animals, or objects in the range of movement of the system; otherwise, there is a risk of injury or damage.

Also follow the safety instructions of the hand-held transmitter. ◀

The system, such as the garage door, can be operated using the button on the interior rearview mirror with the engine running or the ignition switched on. When you are within the reception range of the system, press and hold the button until the function is initiated. The LED on the interior rearview mirror lights up continuously while the radio signal is being transmitted.

Deleting stored functions

Press the right and left buttons on the interior rearview mirror simultaneously for approx. 20 seconds until the LED flashes rapidly. All stored functions are deleted. The functions cannot be deleted individually.

Digital compass

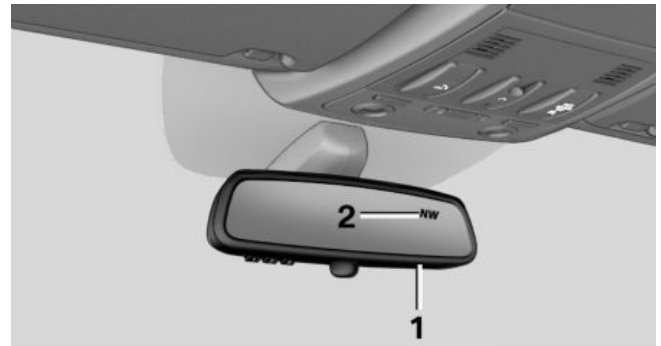

- 1 Adjustment button
- 2 Display

The display shows you the main or secondary compass direction in which you are driving.

Operating concept

Various functions can be called up by pressing the adjustment button with a pointed object such as a pen. The following adjustment options are displayed one after the other, depending on how long the adjustment button is pressed:

- ▷ Press briefly: switch the display on/off.
- ▷ 3 to 6 seconds: set the compass zone.
- ▷ 6 to 9 seconds: calibrate the compass.
- ▷ 9 to 12 seconds: set left-hand/right hand steering.
- ▷ 12 to 15 seconds: set the language.

Setting compass zones

Set the compass zone corresponding to the vehicle's geographic location so that the compass can function correctly; refer to the world map with compass zones.

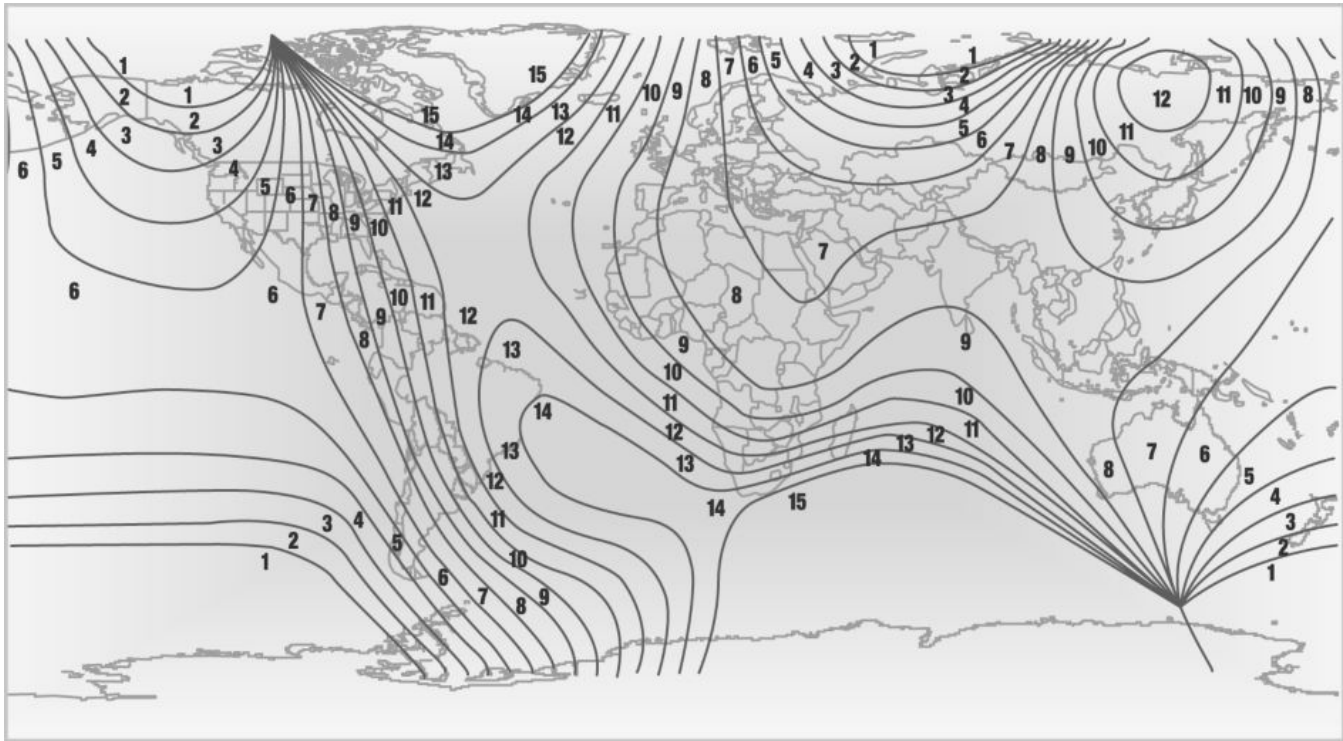

MV07192CMA

Press the adjustment button for 3-4 seconds. The number of the compass zone set is shown in the display.

To change the zone setting, briefly press the adjustment button repeatedly until the display shows the number of the compass zone corresponding to the current location.

The compass is operational again after approx. 10 seconds.

Calibrating the digital compass

The digital compass must be calibrated in the following situations:

- ▶ An incorrect compass direction is shown.
- ▶ The cardinal direction displayed does not change even if the direction of travel changes.
- ▶ Not all compass directions are shown.

Procedure

1. Make sure that there are no large metal objects or overhead power lines in the vicinity of the vehicle and that there is enough space to drive in a circle.

2. Set the currently valid compass zone.
3. Press the adjustment button for 6-7 seconds to call up C. Then drive at least one full circle at a maximum speed of 4 mph/7 km/h. When the system is calibrated, the C is replaced by the compass directions.

Right-hand/left-hand steering

The digital compass is set for right-hand or left-hand steering at the factory.

Setting the language

Press the adjustment button for 12-13 seconds. Briefly press the adjustment button again to switch between English "E" and German "O".

The setting is automatically saved after approx. 10 seconds.

Sun visor

Glare protection

Folding down

Fold the sun visor down.

Folding up

Fold the sun visor up.

Glare protection from the side

Folding down

1. Fold the sun visor down.
2. Detach from the holder and pivot sideways to the side window.

Folding up

To close the sun visor, proceed in reverse order.

Vanity mirror

A vanity mirror is located behind a cover on each sun visor. The mirror lighting comes on when the cover is opened.

Ashtray/cigarette lighter

Opening

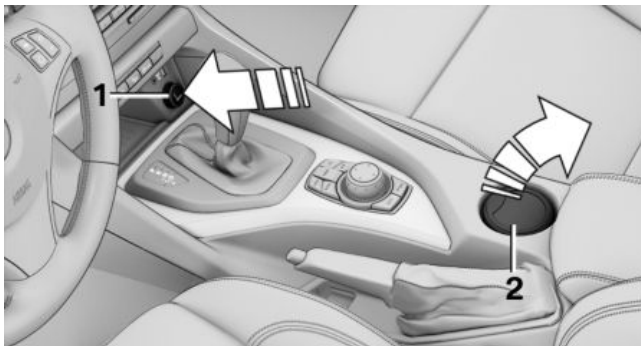

Pull cover 2 up.

Emptying

Take out the insert.

Lighter

With the engine running or the ignition switched on, press in the cigarette lighter 1.

The lighter can be removed as soon as it pops back out.



Danger of burns

Only hold the hot lighter by its head; otherwise, there is the danger of getting burned.

Switch off the ignition and take the remote control with you when leaving the vehicle so that children cannot use the lighter and burn themselves. ◀



Replace the cover after use

Replace the lighter or socket cover after use; otherwise, objects that fall into the lighter socket or power socket could cause a short circuit. ◀

Connecting electrical devices

Note



Do not connect the charger to the socket

Do not connect the battery charger to the socket installed in the vehicle at the factory as this could damage the battery. ◀

Sockets

The lighter socket can be used as a socket for electrical equipment while the engine is running or when the ignition is switched on. The total load of all sockets must not exceed 140 watts at 12 volt.

Avoid damaging the sockets by attempting to insert plugs of unsuitable shape or size.

Front center console



Remove the cover or cigarette lighter.

Rear center console



Remove the cover or cigarette lighter.

In storage compartment under center armrest

To access the socket: remove the cover.

In cargo area

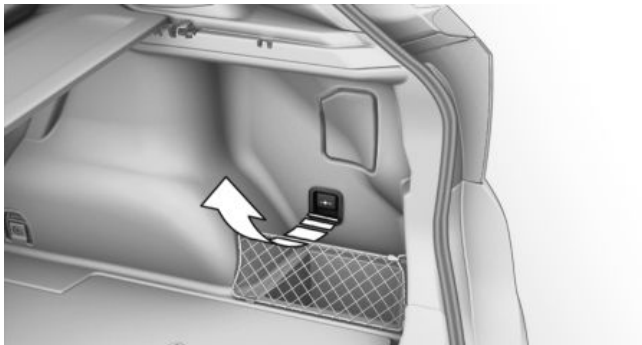

Fold open the cover.

Cargo area

Cargo covers



Do not place objects on the covers

Do not place objects on the cover; if you do so, they may pose a danger to vehicle occupants during braking or evasive maneuvers or damage the cover. ◀

To load bulky luggage, the covers can be removed.

Rear cover

1. Detach the securing straps from the tailgate.
2. Lift the cover slightly, arrow 1, and pull it back and out of the brackets, arrows 2.

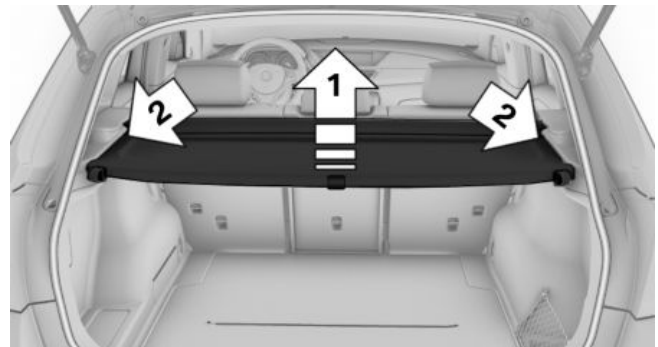

Front cover

1. Push the cover up and out of the brackets on both sides, arrow 1.

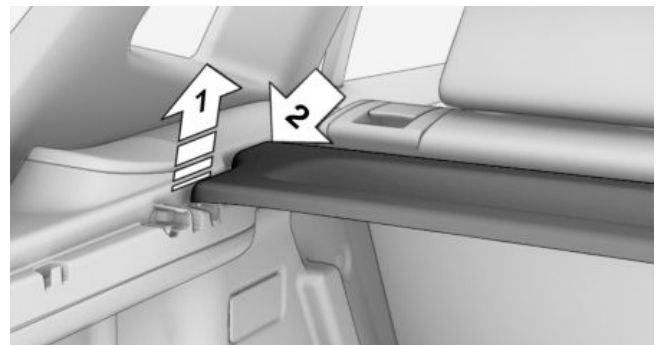

2. Pull the cover back, up and out of the lateral brackets on both sides, arrow 2.

Enlarging the cargo area

General information

The cargo area can be enlarged by folding down the rear seat backrests.

The rear seat backrest is divided at a ratio of 40-20-40.

The backrests can be adjusted to 10 different positions between the comfort and transport positions and they can be folded down.

In the comfort position, the backrests are tilted back to the greatest possible angle and in the transport position they are nearly vertical.

Before mounting a child restraint fixing system, note the instructions, refer to page 54.



Danger of pinching

Before folding down the rear seat backrests, ensure that path of movement of the backrests is clear. Especially when the middle section is folded down, ensure that no one is located in or reaches into the path of movement of the rear seat backrests. Otherwise, injuries or damage may result. ◀



Observe the instructions concerning the safety belt

Observe the instructions concerning the safety belt, refer to page 48. Otherwise, personal protection may be compromised. ◀

Adjusting the outer backrests

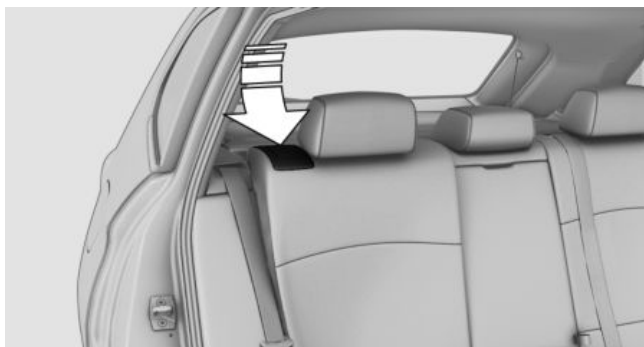

1. Reach into the recess and pull the lever toward the front.

2. Engage the backrest in the desired position or fold it down.

On the left side, the outer and center backrests are adjusted jointly toward the front if both backrests are engaged in the same lock-in position.

The backrests can be adjusted separately toward the rear. Note that the center backrest cannot be tilted farther down than the left backrest.

Adjusting only the center backrest

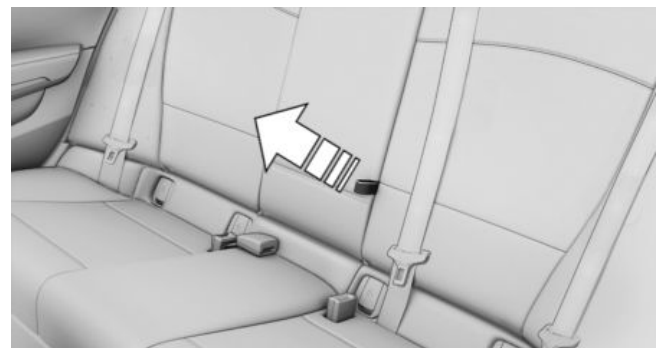

1. Pull the loop, arrow.
2. Engage the backrest in the desired position or fold it down.

Folding the backrests back up

When the backrests are folded back up, they engage in the transport position.

To set the desired backrest tilt or comfort position, pull the lever of the left/right backrest or the loop of the center backrest forward.



Locking the backrest

Before letting passengers ride in the rear, engage the seat backrests, locking them in place. Otherwise, there is the danger of an accident due to unexpected seat movement. ◀

Partition net



Firmly attach the partition net

Make sure that the partition net is firmly attached; otherwise, injuries may result. ◀

The partition net can be attached behind the front or rear seats.

Before installing

1. Remove the pouch with the partition net from the storage compartment under the cargo floor panel in the cargo area.
2. Take the partition net out of the pouch, unroll it, and unfold it.

After use, fold and roll up the partition net in the same manner and place it in the pouch so that it can be stowed back under the cargo floor panel.

Ensure that hooks and tensioning buckles do not rest on the rod elements.

3. Unfold the partition net to the point where the rod elements engage.

Mounting eyes

Four mounting eyes are located on the back of the rear seat backrests.

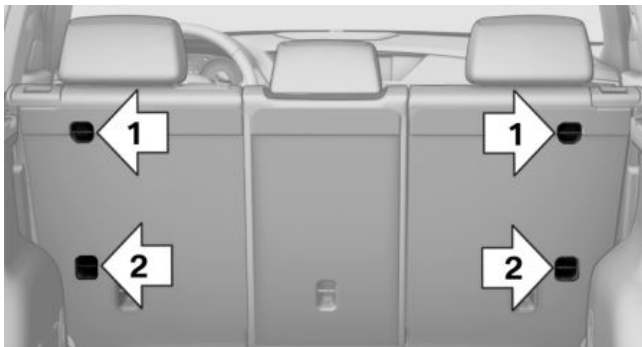

- ▶ Installation behind the front seats, arrows 1.
- ▶ Installation behind the rear seats, arrows 2.

Label

Ensure that the partition net is correctly positioned, i.e., do not reverse front and back.

The partition net is labeled accordingly.

Installation behind the rear seats

1. If necessary, tilt the rear seat backrests forward and remove the front cargo cover, refer to page 120.
2. Fold open the cover caps 1 of the rear brackets in the headliner to the point where they engage.
3. Insert the rods of the partition net 2 all the way into the holders on both sides and slide forward.

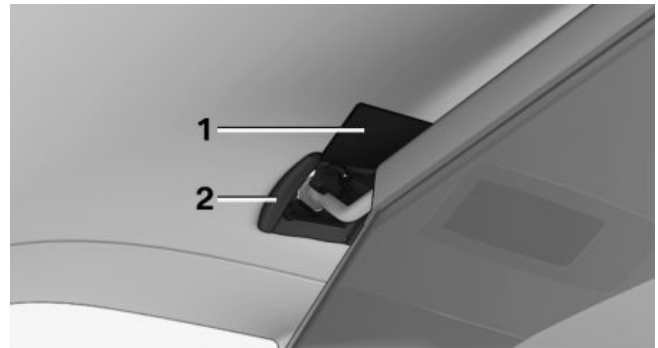

4. Attach the hooks 1 at the bottom of the retaining straps into the eyelets on the rear seat backrest, arrow, on both sides.

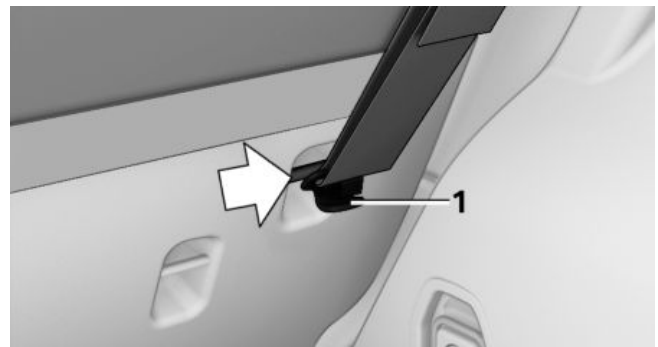

5. Lash the partition net tightly. To do this, tighten the retaining straps using the tensioning buckles.

Installation behind the front seats



1. Fold down the rear seat backrests, refer to Enlarging the cargo area.
2. Fold open the cover caps of the front brackets in the headliner to the point where they engage.
3. Insert the rods of the partition net all the way into the holders on both sides and slide forward.
4. Attach the hooks at the bottom of the retaining straps into the upper eyelets on the rear seat backrest on both sides.
5. Lash the partition net tightly. To do this, tighten the retaining straps using the tensioning buckles.

Removing

To remove and stow the partition net, proceed in reverse order.

To fold up, press both release buttons, arrows.

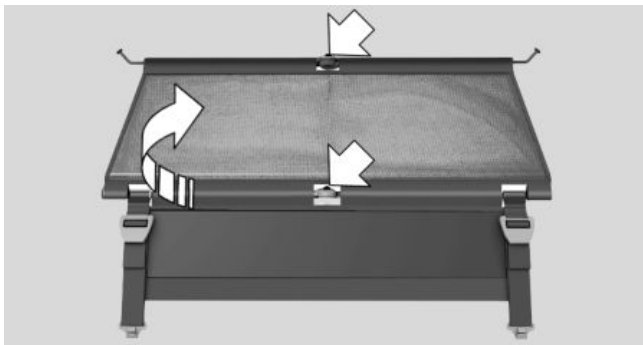

Cargo floor panel

Compartment in floor

 Note the maximum permissible load
Do not exceed a maximum load of 55 lbs/25 kg in the storage compartment beneath the cargo floor panel; otherwise, damage may result. ◀

To access the tool kit, for example, lift the storage compartment at the rear.

To lift, reach into the recess on the rear edge of the storage compartment.

The storage compartment can be removed if necessary.

Raising the cargo floor panel



Reach under the cargo floor panel on the left, right and at the rear. Fold the panel up and forward, pressing it into the gap between the cargo area floor and the rear seat backrest.

 Do not apply pressure to the cargo floor panel when it is upright.

Do not apply pressure to the cargo floor panel when it is upright, do not press up or down on it, and do not adjust the rear seat backrests; otherwise, damage may result. ◀

Before closing the tailgate, fold down the cargo floor panel. To do this, pull the cargo floor panel toward the rear, raising it up and out of the gap.

The cargo floor panel can be removed if necessary.

Lashing eyes

To secure pieces of luggage with nets or draw straps, lashing eyes are available in the cargo area, refer to page 137.

Multi-function hooks



A multi-function hook is located on each side of the cargo area, arrow.



Do not hang heavy items from the hooks

Only hang light bags or suitable objects from the holders. Otherwise, there is a danger of objects flying about during braking and evasive maneuvers.

Only transport heavy luggage in the trunk if it has been appropriately secured. ◀

Ski and snowboard bag

General information

The ski and snowboard bag is contained in a protective jacket in the cargo area.

Follow the installation and operation instructions included in the protective jacket.

Storage compartments

Vehicle equipment

This chapter describes all series equipment as well as country-specific and special equipment offered for this model series. Therefore, it also describes equipment that may not be found in your vehicle, for instance due to the selected special equipment or the country version. This also applies to safety-related functions and systems.

When using the features and systems described here, adhere to local regulations.

Notes



No loose objects in the passenger compartment

Do not stow any objects in the passenger compartment without securing them; otherwise, they may present a danger to occupants for instance during braking and avoidance maneuvers. ◀



No non-slip mats on the dashboard

Do not use non-slip materials, such as non-slip mats, on the dashboard, or it could be damaged by the substances in the materials. ◀

Glove compartment

Opening

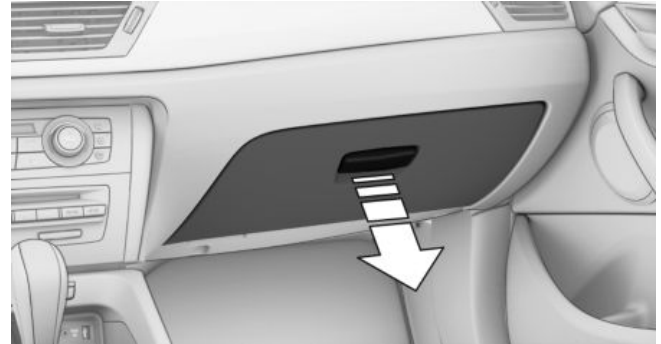

Pull the handle.

The light in the glove compartment switches on.



Close the glove compartment again immediately

Close the glove compartment immediately after use while driving; otherwise, injury may occur during accidents. ◀

Closing

Fold up the cover.

USB interface for data transfer

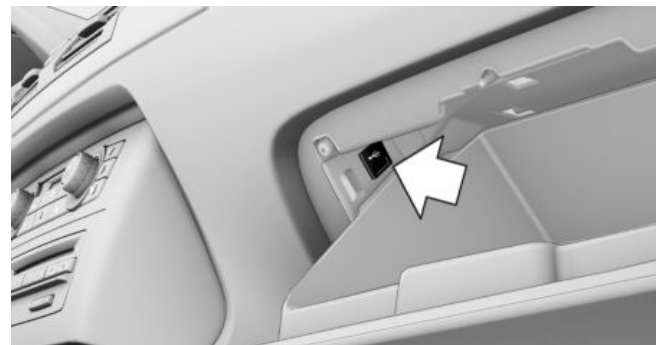

Port for importing and exporting data, such as music collections, refer to page 181, on USB devices.

Observe the following when connecting:

- ▷ Do not use force when plugging the connector into the USB interface.
- ▷ Do not connect devices such as fans or lights to the USB interface.
- ▷ Do not connect a USB hard drive.
- ▷ Do not use the USB interface to recharge external devices.

Center armrest front

Storage compartment

The center armrest between the front seats contains a compartment with cupholders or the cover for the snap-in adapter, depending on the version.

Details on this mobile phone cradle, refer to page [207](#).

Opening



Pull the center armrest upward.

Adjusting



Slide the center armrest into the desired position.

Center armrest, rear



Pull the center armrest forward at the strap.

When folding up, push the center armrest firmly back into the rear seat backrest.

Connection for an external audio device

This can be used to connect an external audio device, such as a CD or MP3 player.

- ▷ AUX-IN port, refer to page [186](#).
- ▷ USB audio interface, refer to page [187](#).

Storage compartments

Storage compartments

Interior

- ▷ Glove compartment, refer to page 125.
- ▷ Compartments in the center console.
- ▷ Compartments in the doors.
- ▷ Bottle holders in the doors, cupholders, refer to page 127.

Cargo area

- ▷ Lashing eyes, refer to page 137.
- ▷ Storage compartment under the cargo floor panel, refer to page 123.
- ▷ Left and right storage compartments.
- ▷ Multi-function hook, refer to page 124.

Storage compartment package

For your comfort:

Interior

- ▷ Insertable cupholder, refer to page 128.
- ▷ Front center armrest, refer to page 126.
- ▷ Nets on the backrests of the front seats.
- ▷ Retaining straps in the front door compartments.
- ▷ Rear center armrest with integrated cupholders.

Cargo area

- ▷ Retaining strap on the left side panel for securing small items.
- ▷ Retaining straps on the cargo area floor.
- ▷ Insertable partition elements for the storage compartment under the cargo floor panel, used to variably subdivide the storage compartment.

With partition net: arrange the partition elements in such a way that there is enough

space at the rear of the storage compartment for the partition net.

- ▷ Storage net next to the storage compartment on the right in the cargo area.

Clothes hooks

The clothes hooks are located at the grab handles in the rear.



Do not obstruct view

When suspending clothing from the hooks, ensure that it will not obstruct the driver's vision. ◀



No heavy objects

Do not hang heavy objects from the hooks; otherwise, they may present a danger to passengers during braking and evasive maneuvers. ◀

Cupholders

Notes



Shatter-proof containers and no hot drinks

Use light and shatter-proof containers and do not transport hot drinks. Otherwise, there is the increased danger of injury in an accident. ◀



Unsuitable containers

Do not forcefully push unsuitable containers into the cupholders. This may result in damage. ◀

Front

- ▷ In the front door compartments as a bottle holder for 1-quart/1 liter bottles, for example.

Insert the bottle into the bottle holder with the bottom slanted toward the front.

- ▷ In the center console.

Insertable cupholder

The insertable cupholder is located in the compartment below the center armrest.



Insert the cupholder in the holder on the center console.

Rear

- ▷ In the front door compartments as a bottle holder for 25-ounce/0.75 liter bottles, for example.

Insert the bottle into the bottle holder with the bottom slanted toward the front.

- ▷ In the center armrest.

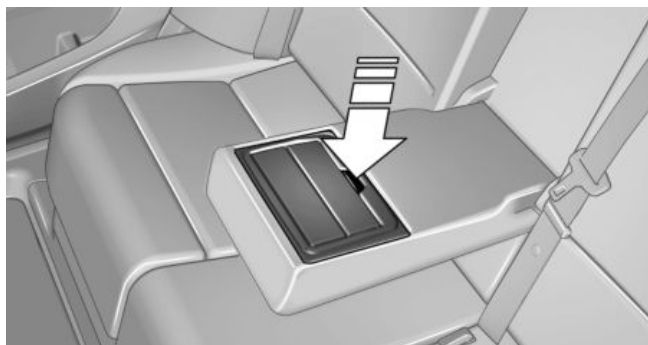

Pull the center armrest forward at the strap.

To open: press the button.

To close: push both covers back in, one after the other.



Driving tips

This section provides you with information useful in dealing with specific driving and operating conditions.

Things to remember when driving

Vehicle equipment

This chapter describes all series equipment as well as country-specific and special equipment offered for this model series. Therefore, it also describes equipment that may not be found in your vehicle, for instance due to the selected special equipment or the country version. This also applies to safety-related functions and systems.

When using the features and systems described here, adhere to local regulations.

Breaking-in period

General information

Moving parts need to be broken in to adjust to each other.

The following instructions will help achieve a long vehicle life and good economy.

Engine and differential

Always obey all official speed limits.

Up to 1,200 miles/2,000 km

Do not exceed the maximum engine and road speeds:

- ▶ 4,500 rpm and 100 mph/160 km/h.

Avoid full-throttle operation and use of the transmission's kickdown mode for the initial miles.

From 1,200 miles/2,000 km

The engine and vehicle speed can gradually be increased.

Tires

Due to technical factors associated with their manufacture, tires do not achieve their full

traction potential until after an initial breaking-in period.

Drive conservatively for the first 200 miles/300 km.

Brake system

Brakes require an initial break-in period of approx. 300 miles/500 km to achieve optimized contact and wear patterns between brake pads and discs. Drive cautiously during this break-in period.

Following part replacement

The same breaking in procedures should be observed if any of the components mentioned above have to be renewed in the course of the vehicle's operating life.

General driving notes

Closing tailgate



Drive with the tailgate closed

Only drive with the tailgate closed; otherwise, passengers and other road users may be endangered or the vehicle may be damaged if an accident occurs or during braking or evasive maneuvers. In addition, exhaust fumes may enter the passenger compartment. ◀

If, despite this, the vehicle must be driven with the tailgate open:

- ▶ Drive moderately.
- ▶ Close all windows and the panoramic glass sunroof.
- ▶ Greatly increase the blower speed.

Hot exhaust system



Hot exhaust system

High temperatures are generated in the exhaust system.

Do not remove the heat shields installed and never apply undercoating to them. Make sure that flammable materials, e. g. hay, leaves, grass, etc. do not come in contact with the hot exhaust system during driving, while in idle position mode, or when parked. Such contact could lead to a fire, and with it the risk of serious personal injury as well as property damage.

Do not touch hot exhaust pipes; otherwise, there is the danger of getting burned. ◀

Mobile communication devices in the vehicle



Mobile communication devices in the vehicle

It is not recommended to use mobile phones, such as mobile phones without a direct connection to an external aerial in the vehicle's passenger compartment. Otherwise, the vehicle electronics and mobile communication devices can interfere with each other. In addition, there is no assurance that the radiation generated during transmission will be discharged from the vehicle interior. ◀

Hydroplaning

On wet or slushy roads, a wedge of water can form between the tires and road surface.

This phenomenon is referred to as hydroplaning. It is characterized by a partial or complete loss of contact between the tires and the road surface, ultimately undermining your ability to steer and brake the vehicle.



Hydroplaning

When driving on wet or slushy roads, reduce your speed to prevent hydroplaning. ◀

The risk of hydroplaning increases as the tire tread depth decreases. Minimum tread depth, refer to page 239.

Driving through water

Drive through calm water only if it is not deeper than 12 inches/30 cm and at this height, no faster than walking speed, up to 6 mph/10 km/h.



Adhere to water depth and speed limitations

Do not exceed this water depth and walking speed; otherwise, the vehicle's engine, the electrical systems and the transmission may be damaged. ◀

Braking safely

Your vehicle is equipped with ABS as a standard feature.

Applying the brakes fully is the most effective way of braking in situations when this is necessary.

The vehicle maintains steering responsiveness. You can still avoid any obstacles with a minimum of steering effort.

Pulsation of the brake pedal and sounds from the hydraulic circuits indicate that ABS is in its active mode.



Do not let your foot rest on the brake pedal

Do not drive with your foot resting on the brake pedal. Even light but consistent pedal pressure can lead to high temperatures, brake wear and possibly even brake failure. ◀

Objects in the area around the pedals



No objects in the area around the pedals

Keep floor mats, carpets, and any other objects out of the area of motion of the pedals; otherwise, the function of the pedals could be impeded while driving

Do not place additional floor mats over existing mats or other objects.

Only use floor mats that have been approved for the vehicle and can be properly fixed in place.

Ensure that the floor mats are securely fastened again when they are returned after being removed, such as for cleaning. ◀

Driving in wet conditions

When roads are wet or there is heavy rain, briefly exert gentle pressure on the brake pedal every few miles.

Ensure that this action does not endanger other road users.

The heat generated in this process helps dry the brake discs and pads.

In this way braking efficiency will be available when you need it.

Hills

Drive long or steep downhill gradients in the gear in which the least braking is required. Otherwise, the brake system may overheat, resulting in a reduction in the brake system efficiency.

You can increase the engine's braking effect by shifting down, going all the way to first gear, if necessary.

Downshifting in manual mode of the automatic transmission, refer to page 68.

 Avoid load on the brakes
Avoid placing excessive load on the brake system. Light but consistent brake pressure can lead to high temperatures, brake wear and possibly even brake failure. ◀

 Do not drive in neutral
Do not drive in neutral or with the engine stopped, as doing so disables engine braking. In addition, steering and brake assist are unavailable with the engine stopped. ◀

Brake disc corrosion

Corrosion on the brake discs and contamination on the brake pads are furthered by:

- ▶ Low mileage.
- ▶ Extended periods when the vehicle is not used at all.
- ▶ Infrequent use of the brakes.

Corrosion occurs when the minimum pressure that must be exerted by the pads during brake applications to clean the discs is not reached.

Should corrosion form on the brake discs, the brakes will tend to respond with a pulsating effect that generally cannot be corrected.

Condensation under the parked vehicle

When using the automatic climate control, condensation water develops that exits underneath the vehicle.

Therefore, traces of condensed water under the vehicle are normal.

Driving on poor roads

BMW X1 combines an all-wheel drive system with the advantages of a normal passenger car.

 Do not drive on unpaved terrain
Do not drive on unpaved terrain, as otherwise the vehicle may be damaged. ◀

For your own safety and the safety of passengers and the vehicle, adhere to the following points:

- ▶ Familiarize yourself with the vehicle before driving; never take risks.
- ▶ Adjust speeds according to road conditions. The steeper and rougher the road surface is, the lower the speed should be.
- ▶ When driving on steep uphill and downhill grades: the engine oil and coolant should be filled nearly to the MAX mark.

- ▷ Use Hill Descent Control HDC, refer to page 101, on steep downhill grades.
- ▷ Watch for stones, holes, and other obstacles and drive around these where possible.
- ▷ On bumps and rough roads, avoid contact between the vehicle body and the ground. The maximum ground clearance is 8 inches/20 cm and may vary with the loaded cargo.
- ▷ When driving through water, do not exceed the maximum water height of 12 inches/30 cm and drive at walking speed.
- ▷ After driving through water, press on the brake pedal several times at low speeds to dry the brakes.
- ▷ Depending on the prevailing terrain, activate Dynamic Traction Control DTC, refer to page 100, briefly.
- ▷ When the wheels spin, accelerate to enable the driving stability control systems to distribute the drive force to the individual wheels.

After driving on poor roads

Adhere to the following points to ensure vehicle safety:

- ▷ Remove excessive accumulations of dirt and mud from the vehicle body.
- ▷ Clear mud, snow, ice, etc., from the wheels and tires and check for damage.

Loading

Vehicle equipment

This chapter describes all series equipment as well as country-specific and special equipment offered for this model series. Therefore, it also describes equipment that may not be found in your vehicle, for instance due to the selected special equipment or the country version. This also applies to safety-related functions and systems.

When using the features and systems described here, adhere to local regulations.

General information



Overloading the vehicle

To avoid exceeding the approved carrying capacity of the tires, never overload the vehicle. Overloading can lead to overheating and increases the rate at which damage develops inside the tires. This could result in a sudden loss of tire inflation pressure. ◀



No fluids in the cargo area

Make sure that fluids do not leak into the cargo area; otherwise, the vehicle may be damaged. ◀

Determining the load limit



1. Locate the following statement on your vehicle's placard:

▷ The combined weight of occupants and cargo should never exceed XXX kg or YYY lbs. Otherwise, damage to the vehicle and unstable driving situations may result.

2. Determine the combined weight of the driver and passengers that will be riding in your vehicle.
3. Subtract the combined weight of the driver and passengers from XXX kilograms or YYY pounds.
4. The resulting figure equals the available amount of cargo and luggage load capacity.

For example, if the YYY amount equals 1,000 lbs and there will be four 150 lbs passengers in your vehicle, the amount of available cargo and luggage load capacity is 400 lbs: 1,000 lbs minus 600 lbs = 400 lbs.

5. Determine the combined weight of luggage and cargo being loaded on the vehicle. That weight may not safely exceed the available cargo and luggage load capacity calculated in Step 4.
6. If your vehicle will be towing a trailer, load from your trailer will be transferred to your vehicle. Consult the manual for transporting a trailer to determine how this may reduce the available cargo and luggage load capacity of your vehicle.

Load

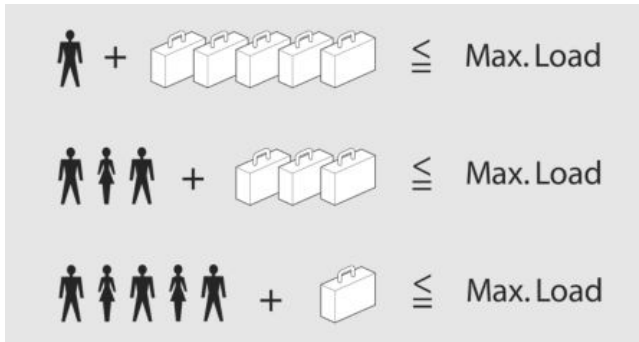

The maximum load is the sum of the weight of the occupants and the cargo.

The greater the weight of the occupants, the less cargo that can be transported.

Stowing cargo

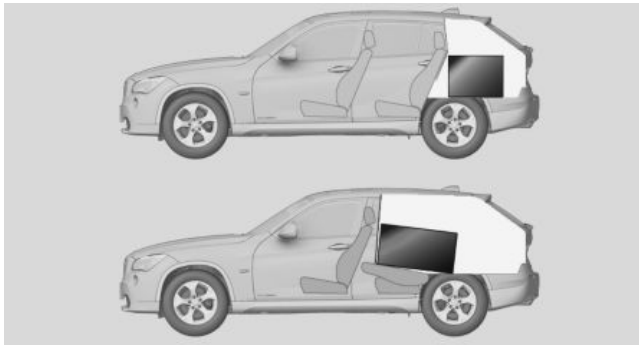

- ▶ Very heavy cargo: when the rear seat is not occupied, secure each of the outer safety belts in the opposite buckle.
- ▶ Heavy cargo: stow as far forward and as low as possible, ideally directly behind the backrests.
- ▶ Cover sharp edges and corners.
- ▶ Do not pile cargo higher than the top edge of the backrests.
- ▶ If necessary, fold down the rear backrests to stow cargo.
- ▶ Use the partition net, refer to page 121, to protect passengers. Make sure that objects cannot penetrate the partition net.
- ▶ Place protective material around any sharp-edged or pointed objects that could

bump against the rear window while the vehicle is in motion.

Securing cargo

Lashing eyes in the cargo area

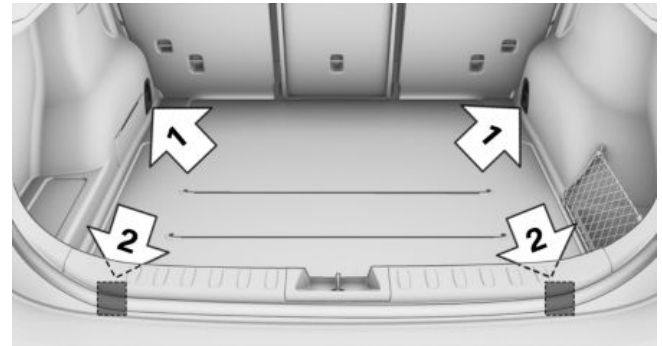

Securing cargo

- ▶ Smaller and lighter items: secure with retaining straps, a cargo net or draw straps.
- ▶ Larger and heavy objects: secure with cargo straps.

Cargo straps can be attached to two lashing eyes on the cargo area side panel, arrows 1, and two lashing eyes on the cargo area rear panel, arrows 2.



Securing cargo

Stow and secure the cargo as described above; otherwise it may present a danger to the occupants, for instance during braking and avoidance maneuvers.

Do not stow any heavy and hard objects in the passenger compartment without securing them; otherwise, they may present a danger to occupants, for instance during braking and avoidance maneuvers.

Never exceed either the approved gross vehicle weight or either of the approved axle loads, as excessive loads can pose a safety hazard, and may also place you in violation of traffic safety laws.

Use only the lashing eyes pictured to fasten the heavy-duty cargo straps. Do not secure cargo using the upper top tether, refer to page 55, mounting points; otherwise, these may become damaged. ◀

Roof-mounted luggage rack

Notes

A special rack system is available as an optional accessory.

Anchorage points

The anchorage points are located on the roof railing.

Attachment

Follow the installation instructions for the roof-mounted luggage rack.

Be sure that adequate clearance is maintained for tilting and opening the panoramic glass sunroof.

Loading

Because roof racks raise the vehicle's center of gravity when loaded, they have a major effect on vehicle handling and steering response.

Therefore, note the following when loading and driving:

- ▶ Do not exceed the approved roof/axle loads and the approved gross vehicle weight.
- ▶ Distribute the roof load uniformly.
- ▶ The roof load should not be too large in area.
- ▶ Always load the heaviest pieces on the bottom.
- ▶ Fasten the roof-mounted luggage securely, for instance using lashing straps.

- ▶ Do not let objects project into the opening path of the tailgate.
- ▶ Drive smoothly. Avoid sudden acceleration and braking maneuvers. Take corners gently.

Rear luggage rack

Notes

A special rear rack is available as an optional accessory. It does not require a trailer hitch.

Follow the installation instructions for the rear rack.

Anchorage points

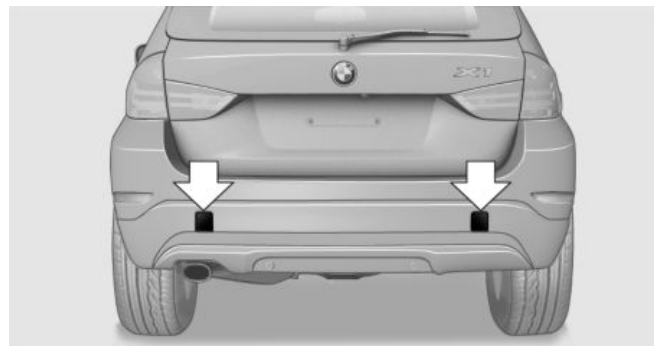

The anchorage points are under the covers in the bumper. Remove the covers, refer to page 262.

Saving fuel

Vehicle equipment

This chapter describes all series equipment as well as country-specific and special equipment offered for this model series. Therefore, it also describes equipment that may not be found in your vehicle, for instance due to the selected special equipment or the country version. This also applies to safety-related functions and systems.

When using the features and systems described here, adhere to local regulations.

General information

Your vehicle contains advanced technology for the reduction of fuel consumption and emissions.

Fuel consumption depends on a number of different factors.

The implementation of certain measures, driving style and regular maintenance, refer to page 247, can have an influence on fuel consumption and on the environmental impact.

Remove unnecessary cargo

Additional weight increases fuel consumption.

Remove attached parts following use

Remove unneeded auxiliary mirrors, roof or rear luggage racks after use.

Attached parts on the vehicle impair the aerodynamics and increase the fuel consumption.

Closing the windows and panoramic glass sunroof

Driving with the panoramic glass sunroof and windows open results in increased air resistance and raises fuel consumption.

Check the tire inflation pressure regularly

Check and, if necessary, correct the tire inflation pressure, refer to page 232, at least twice a month and before starting on a long trip.

Low tire inflation pressure increases rolling resistance and thus raises fuel consumption and tire wear.

Drive away without delay

Do not wait for the engine to warm-up while the vehicle remains stationary. Start driving right away, but at moderate engine speeds.

This is the fastest way for the cold engine to reach its operating temperature.

Look well ahead when driving

Avoid unnecessary acceleration and braking.

By maintaining a suitable distance to the vehicle driving ahead of you.

Driving smoothly and looking ahead reduces fuel consumption.

Avoid high engine speeds

Driving at a low engine speed reduces fuel consumption and minimizes wear.

Use coasting conditions

When approaching a red light, take your foot off the accelerator and let the vehicle coast to a halt.

On a downhill gradient, take your foot off the accelerator and let the vehicle roll.

The flow of fuel is interrupted while coasting.

Switch off the engine during longer stops

Switch off the engine during longer stops, e.g., at traffic lights, railroad crossings or in traffic congestion.

Automatic Engine Start/Stop Function

The Automatic Start/Stop Function of your vehicle automatically switches off the engine during a stop. Additional information on the Automatic Engine Start/Stop Function, refer to page 61.

If the engine is stopped and then started again, fuel consumption and emissions drop compared to an engine that runs permanently. Stopping the engine even for just a few seconds can result in savings.

Use of this system can cause premature wear on certain vehicle components.

In addition, fuel consumption depends on other factors as well, such as driving style, road conditions, maintenance, and environmental factors.

Switch off any functions that are not currently needed

Functions such as seat heating and the rear window defroster require a lot of energy and consume additional fuel, especially in city and stop-and-go traffic.

Therefore, switch off these functions if they are not actually needed.

Have maintenance carried out

Have vehicles maintained regularly to achieve optimal vehicle economy and operating life. Have the maintenance carried out by your service center.

Please also note the BMW Maintenance System, refer to page 247.

ECO PRO

The concept

ECO PRO supports the driver in achieving high fuel economy. Engine control and comfort functions, such as the climate control system, are adjusted accordingly.

In addition, situation-related information can be displayed that helps the driver achieve lower fuel consumption.

The resulting range extension can be displayed in the instrument cluster.

Activating ECO PRO

 Press the button; the LED above the button lights up.

ECO PRO appears in the instrument cluster and DSC is activated if necessary.

Displays in the instrument cluster



After activation, ECO PRO and the bonus range are displayed in the instrument cluster.

ECO PRO bonus range

The vehicle's cruising range can be extended by adjusting your driving style.

This extended range can be displayed as a bonus range in the instrument cluster.

The bonus range is indicated in the range display.

The bonus range is automatically reset after refueling.

Driving style

ECO PRO displays the efficiency of the current driving style in the instrument cluster.

- ▷ ECO PRO not highlighted: efficient driving style.
- ▷ ECO PRO highlighted: adjust your driving style, for example by accelerating less quickly.

To drive efficiently:

- ▷ Accelerate less quickly.
- ▷ Brake in advance.
- ▷ Reduce speed to the ECO PRO speed of 80 mph/130 km/h.
- ▷ Automatic transmission: shift from S to D, or avoid shifting manually.

ECO PRO tip

Situation-related tips that indicate measures to achieve optimum fuel economy can be displayed.

A reminder is displayed when the ECO PRO speed of 80 mph/130 km/h is exceeded.

Displaying the ECO PRO tip

1. "Vehicle Info"
2. "ECO PRO Tips"

ECO PRO climate control

Climate control is adjusted for optimum fuel economy.

To achieve better fuel economy, the actual temperature may vary slightly from the set temperature and the passenger compartment may be heated or cooled more slowly.

Deactivating ECO PRO



Press the button again.

The LED above the button and the ECO PRO display in the instrument cluster go out.



Navigation

This chapter contains various examples of how the navigation system can guide you reliably to your destination.



Navigation system

Vehicle equipment

This chapter describes all series equipment as well as country-specific and special equipment offered for this model series. Therefore, it also describes equipment that may not be found in your vehicle, for instance due to the selected special equipment or the country version. This also applies to safety-related functions and systems.

When using the features and systems described here, adhere to local regulations.

General information

The navigation system can determine the precise position of the vehicle, with the aid of satellites and vehicle sensors, and can reliably guide you to every entered destination.



Entries in stationary vehicle

Enter data only when the vehicle is stationary, and always give priority to the applicable traffic regulations in the event of any contradiction between traffic and road conditions and the instructions issued by the navigation system. Failure to take to this precaution can place you in violation of the law and put vehicle occupants and other road users in danger. ◀

Opening the navigation system

1.  Press the button on the controller.
2. "Navigation"



The navigation system can also be called up directly using the button on the controller.

Navigation data

Information on navigation data

1. "Navigation"
2. Open "Options".
3. "Navigation system version"

Information is displayed on the data version.

Updating the navigation data

General information

Navigation data are stored in the vehicle and can be updated.

Current navigation data and the authorization code are available from your service center.

- ▶ Depending on the data volume, a data update may take several hours.
- ▶ Update during the trip to preserve battery.
- ▶ During the update, only the basic functions of the navigation system are available.
- ▶ The status of the update can be viewed.
- ▶ After the updating process is complete, the system restarts.
- ▶ Remove the medium with the navigation data after the update.

Performing an update

1. Insert the navigation DVD into the DVD player with the labeled side facing up.
2. Follow the instructions on the Control Display.
3. Enter the authorization code of the navigation DVD.
4. Change the DVD if necessary.

After the trip is interrupted, follow the instructions on the Control Display.

Viewing the status

1. Open "Options".
2. "Navigation update"

Removing navigation DVD

1.  Press button 1.

The DVD emerges slightly from the drive.

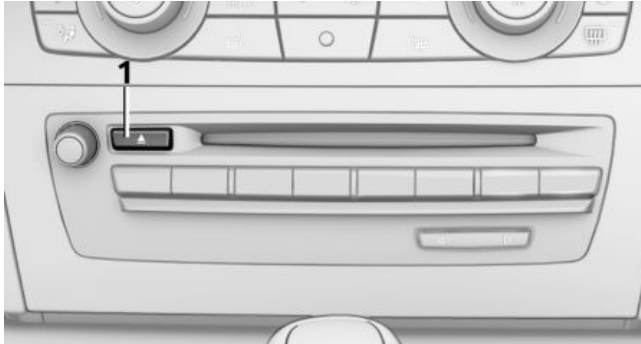

2. Remove the DVD.

Destination entry

Vehicle equipment

This chapter describes all series equipment as well as country-specific and special equipment offered for this model series. Therefore, it also describes equipment that may not be found in your vehicle, for instance due to the selected special equipment or the country version. This also applies to safety-related functions and systems.

When using the features and systems described here, adhere to local regulations.

At a glance

In entering your destination you can select from the following options:

- ▶ Enter the destination manually, see below.
- ▶ Select the destination from the address book, refer to page 148.
- ▶ Last destinations, refer to page 149.
- ▶ Special destinations, refer to page 149.
- ▶ Destination entry via map, refer to page 151.
- ▶ Using the home address as the destination, refer to page 149.
- ▶ Destination entry by voice, refer to page 152.
- ▶ Destination entry via the Concierge service, refer to page 151.

You can also store a navigation destination on the programmable memory buttons, refer to page 24.

 **Entries in stationary vehicle**
Enter data only when the vehicle is stationary, and always give priority to the applicable traffic regulations in the event of any contradiction between traffic and road conditions and the instructions issued by the navigation

system. Failure to take to this precaution can place you in violation of the law and put vehicle occupants and other road users in danger. ◀

Manual destination entry

General information

The system supports you in entering street names and house numbers by automatically completing the entry and providing entry comparisons, refer to page 25.

Stored town/city and street names can be called up quickly.

- ▶ If the existing entries should not be changed, the entries for the state/province and town/city can be skipped.
- ▶ Destination guidance is started to the town/city center if no street is entered.

Entering a state/province

1.  Press the button.
2. "Navigation"
3. "Enter address"

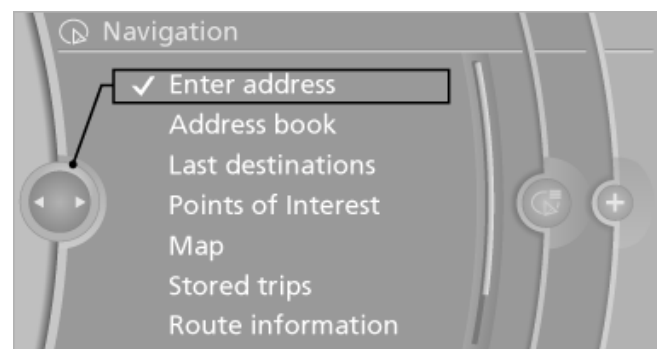

4. Select "State/Province" or the displayed state/province.

Entering a town/city

1. Select "Town/City/Postal Code" or the displayed town/city.

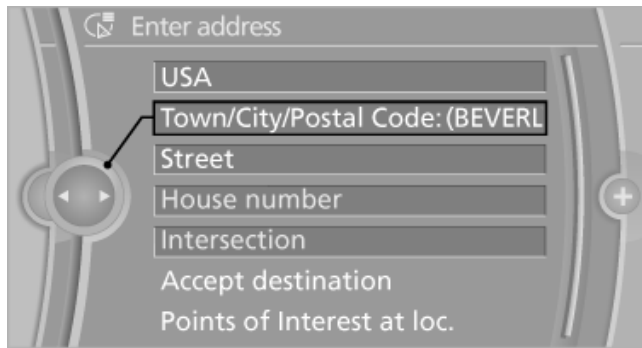

2. Select letters, if necessary.
The list is narrowed down further with each entry.
3. Move the controller to the right.
4. Select the name of the town/city from the list.

If there are several towns/cities with the same name:

1. Change to the list of town/city names.
2. Highlight the town/city.
3. Select the town/city.

Entering the postal code

1. Select "Town/City/Postal Code" or the displayed town/city.
2. \uparrow @+ Select the symbol.
3. Select the numbers.
4. Change to the list of postal codes and towns/cities.
5. Highlight the entry.
6. Selecting an entry.

Entering a street and intersection

1. Select "Street" or the displayed street.
2. Enter a street and intersection in the same way as you would enter a town/city.

If there are several streets with the same name:

1. Change to the list of street names.
2. Highlight the street.
3. Select the street.

Alternative: enter the street address and house number

1. Select "Street" or the displayed street.
2. Enter the street as you would the town/city.
3. "House number"
4. Select the numbers.
5. Change to the list of house numbers.
6. Select a house number or range of house numbers.

Street does not exist in the destination city/town

The desired street does not exist in the specified city/town because it belongs to another part of the city/town.

1. "Navigation"
2. "Enter address"
3. Select "Street" or the displayed street.
4. Change to the list of street names.
5. Select "In" with the state/province currently displayed.

All streets of the selected state/province are offered. The associated town/city is displayed after the street name.

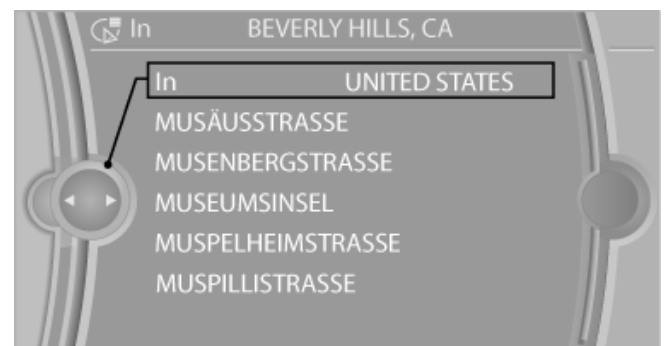

6. Select the letters.
7. Change to the list of street names.
8. Highlight the street.
9. Select the street.

Starting destination guidance after entering the destination

1. "Accept destination"
2. "Start guidance" or "Add as another destination"

Add, refer to page 153, a destination as a further destination.

Address book

Create contacts, refer to page 218.

Selecting a destination from the address book

1. "Navigation"
2. "Address book"

Contacts with addresses are displayed if these addresses have been checked as destinations in the contacts.

If the contacts with addresses from the mobile phone are not displayed, they first need to be checked as destinations, refer to page 219.

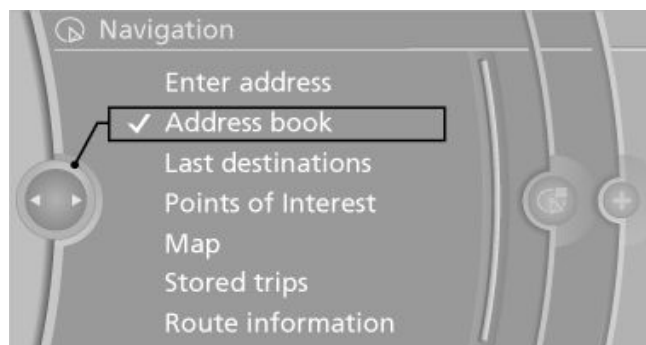

3. Select a contact in the list or, if desired, with "A-Z search".
4. "Business address" or "Home address"

Storing the destination in the address book

After entering the destination, store the destination in the address book.

1. "Navigation"
2. "Map"
3. "Guidance"
4. Open "Options".
5. "Store as new contact" or "Add to existing contact"

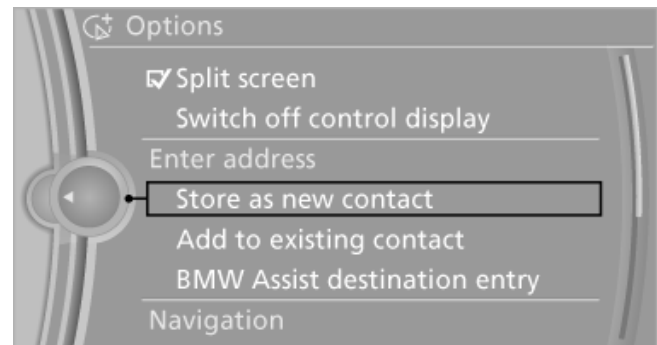

6. Select an existing contact, if available.
7. "Business address" or "Home address"
8. Enter "Last name" and, if necessary, "First name".
9. "Store in vehicle"

Storing the position

The current position can be stored in the address book.

1. "Navigation"
2. Open "Options".
3. "Store position as contact" or "Add position to contact"

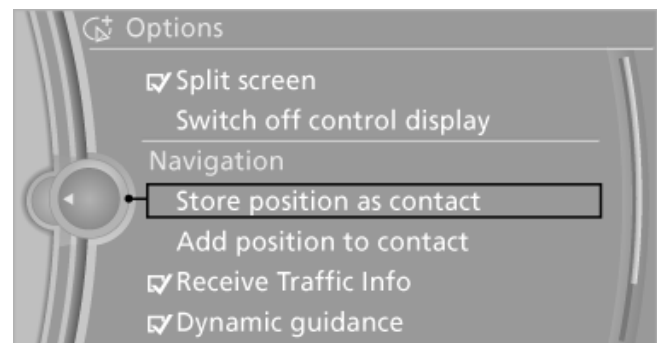

4. Depending on the selection, choose an existing contact from the list. Select the type of address and enter the first and last name.
5. "Store in vehicle"

Editing or deleting an address

1. "Navigation"
2. "Address book"
3. Highlight the entry.
4. Open "Options".
5. "Edit in Contacts" or "Delete entry"

Using the home address as the destination

The home address must be stored. Specify the home address, refer to page 211.

1. "Navigation"
2. "Address book"
3. "Home"

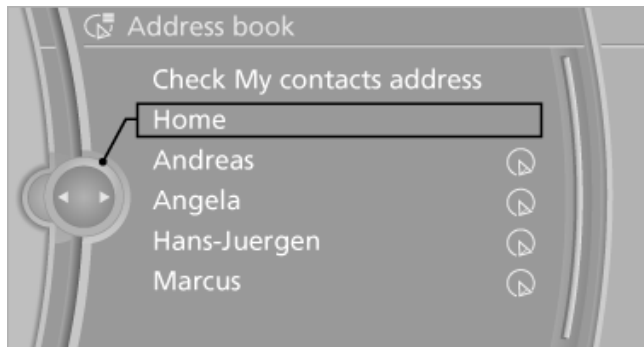

4. "Start guidance"

Last destinations

At a glance

The destinations previously entered are stored automatically.

These destinations can be called up and used as a destination for destination guidance.

Calling up the last destination

1. "Navigation"
2. "Last destinations"

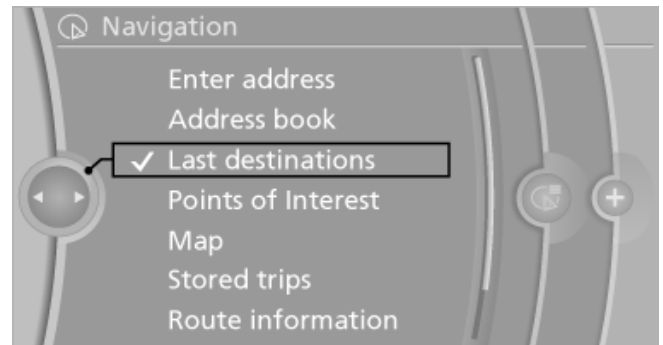

Starting destination guidance

1. "Navigation"
2. "Last destinations"
3. Select the destination.
4. "Start guidance"

Editing the destination

1. "Navigation"
2. "Last destinations"
3. Highlight the destination.
4. Open "Options".
5. "Edit destination"

Deleting the last destinations

1. "Navigation"
2. "Last destinations"
3. Highlight the destination.
4. Open "Options".
5. "Delete entry" or "Delete all last destinations"

Special destinations

General information

Even with the latest navigation data, information on specific Points of Interest may have

changed; for example, gas stations might not be in operation.

Opening the search for Points of Interest

Selection of Points of Interest, such as hotels or tourist attractions.

1. "Navigation"
2. "Points of Interest"
3. Select the search function.

Online Search

1. "Google™ Local Search"
2. Select a special destination.
3.  Select the symbol.
4. "Start guidance"

A-Z search

1. "A-Z search"
2. "Town/City"
3. Select or enter the town/city.
4. "Category"
5. Select the category.
6. "Category details"

For some Points of Interest, multiple category details can be selected. Move the controller to the left to leave the category details.
7. "Keyword"
8. Enter the keyword.

A list of the Points of Interest is displayed.
9. Select a special destination.

Details are displayed.

If multiple details are stored, you can leaf through the pages.

If a phone number is available, a connection can be established if necessary.
10.  Select the symbol.
11. "Start guidance" or "Add as another destination"

Add a destination as a further destination, refer to page [153](#).

"Start search": if a search term is not entered, the search is repeated with the previous search term.

Category search

1. "Category search"
2. "Town/City"
3. Select or enter the town/city.
4. "Category"
5. Select the category.
6. "Category details"

For some Points of Interest, multiple category details can be selected. Move the controller to the left to leave the category details.
7. "Start search"

A list of the Points of Interest is displayed.
8. Select a special destination.

Details are displayed.

If multiple details are stored, you can leaf through the pages.

If a phone number is available, a connection can be established if necessary.
9.  Select the symbol.
10. "Start guidance" or "Add as another destination"

Add a destination as a further destination, refer to page [153](#).

Display of Points of Interest

List of Points of Interest: Points of Interest are arranged by distance and appear with a directional arrow pointing to the special destination. In the splitscreen, Points of Interest of the selected category are displayed in the map view as symbols. The display depends on the scale of the map and the category.

Destination entry via the Concierge service

A connection is established to the Concierge service, refer to page [221](#).

1. "Navigation"
2. "Enter address"
3. Open "Options".
4. "BMW Assist dest. entry"

Displaying Points of Interest in the map

To display symbols of the Points of Interest in the map view:

1. "Navigation"
2. "Map"
3. Open "Options".
4. "Display Points of Interest"
5. Select the setting.

Destination entry by map

Selecting the destination

1. "Navigation"
2. "Map"

The current position of the vehicle is displayed on the map.

3.  "Interactive map"

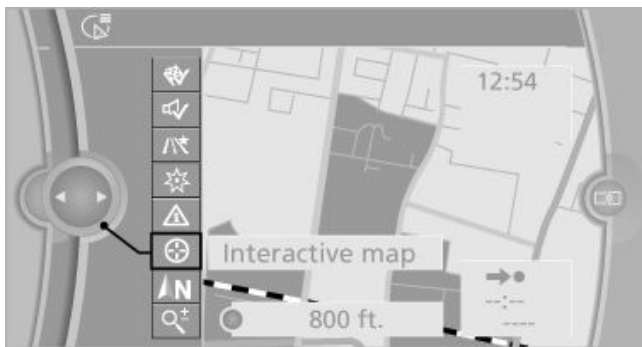

4. Select the destination with crosshairs.
 - ▷ To change the scale: turn the controller.

- ▷ To shift the map: move the controller in the required direction.
- ▷ To shift the map diagonally: move the controller in the required direction and turn it.

Specifying the street

If the system does not recognize the street, one of the following pieces of information is displayed:

- ▷ A street name in the vicinity.
- ▷ The county.
- ▷ The coordinates of the destination.

Additional functions

Additional functions are available on the interactive map after the controller is pressed:

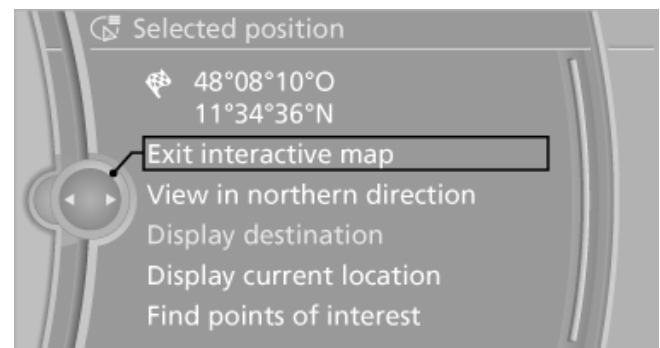

- ▷  Select the symbol. "Start guidance" or "Add as another destination"
 - Add a destination as a further destination, refer to page [153](#).
- ▷ "Exit interactive map": return to the map view.
- ▷ "View in northern direction" or "View in driving direction"
- ▷ "Display destination": the map section around the destination is displayed.
- ▷ "Display current location": the map section around your current location is displayed.
- ▷ "Find points of interest": the search for Points of Interest is started.

Destination entry by voice

General information

- ▶ Instructions for voice activation system, refer to page 27.
- ▶ When making a destination entry by voice, you can change between voice operation and iDrive.
- ▶ To have the available spoken instructions read out loud: ›Voice commands‹.

Saying the entries

- ▶ The town/city, street, and house number can be entered using a single command.
- ▶ Countries, towns and cities, streets, and intersections can be said as whole words or spelled in the language of the system, refer to page 79.
Example: to enter a destination in a US state as a whole word, the system language must be English.
- ▶ Spell the entry if the spoken language and the language of the system differ.
- ▶ Say the letters smoothly, and avoid exaggerating the pronunciation and inserting lengthy pauses between the letters.
- ▶ The methods of entry depend on the navigation data in use and the country and language settings.

Entering the address in a command

1.  Press the button on the steering wheel.
2. ›Enter address‹
3. Wait for a request from the system.
4. Say the address in the suggested order.
5. Continue making the entry as prompted by the system.

If necessary, individually name the separate components of the address, e.g., the town/city.

Entering a town/city separately

The town/city can be said as a complete word.
With the destination entry menu displayed:

1.  Press the button on the steering wheel.
2. ›City‹ or ›Spell city‹
3. Wait for the system to prompt you for the town/city.
4. Say the name of the town/city, or name at least the first three letters.

Depending on the entry, up to 20 towns/cities may be suggested.

5. Select a location:
 - ▶ Select a recommended town/city: ›Yes‹.
 - ▶ Select a different town/city: ›New entry‹.
 - ▶ Select an entry: ›Entry ...‹, for instance, entry 2.
 - ▶ Spell an entry: ›Spell city‹.
6. Continue making the entry as prompted by the system.

If there are several towns/cities with the same name:

Towns/cities of the same name are grouped in a list and displayed as one location followed by an ellipsis.

1. Select an entry: ›Yes‹ or ›Entry ...‹, e. g., Entry 2.
2. Select the desired town/city.

Entering a street or intersection separately

Enter a street and intersection in the same way as you would enter a town/city.

Entering a house number separately

Depending on the data in the navigation system, house numbers up to number 2,000 can be entered.

1. ›House number‹
2. Say the house number.
Say each digit separately.
3. Continue making the entry as prompted by the system.

Starting destination guidance

›Start guidance‹

Planning a trip with intermediate destinations

New trip

A trip can be planned with several intermediate destinations.

1. "Navigation"
2. "Map"
3. Move the controller to the left if necessary.
4.  "Guidance"
5. "Enter new destination"
6. Select the type of destination entry.

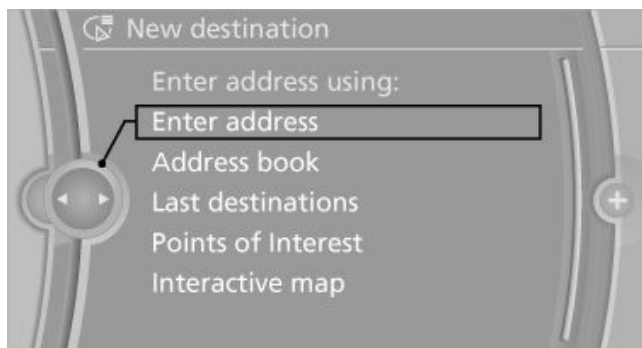

7. Enter the intermediate destination.
8. "Start guidance"

Entering intermediate destinations

A maximum of 30 intermediate destinations can be entered for a trip.

1. "Enter new destination"
2. Select the type of destination entry.
3. Enter the intermediate destination.
4. "Add as another destination"
The intermediate destination is entered in the destination list and is highlighted.
5. Turn the controller until the intermediate destination is located at the desired location in the list.
6. Press the controller.

Starting the trip

1. After all intermediate destinations are entered, highlight the first destination.
If the second destination, for example, is highlighted when destination guidance is started, the first destination is skipped.
2. "Start guidance"
 This symbol marks the active leg of the trip.

Storing a trip

Up to 30 trips can be stored in the trip list. If necessary, delete existing trips to be able to store new trips.

1. Open "Options".
2. "Store trip"
3. Enter a name for the trip.
4. "OK"

Selecting a stored trip

1. "Navigation"
2. "Stored trips"
3. Select a stored trip.
4. "Start guidance"

Changing the trip direction

Intermediate destinations are displayed in reverse order in the list.

1. "Map"
2.  "Guidance"
3. Open "Options".
4. "Reverse order of trip dest."

Intermediate destination options

1. "Map"
2.  "Guidance"
3. "Display all trip destinations"
4. Select an intermediate destination.
 - ▷ "Edit destination"
 - ▷ "Reposition dest. in the trip": move an intermediate destination to another position in the list.
 - ▷ "Delete dest. in the trip"
 - ▷ "Go to next dest. in the trip"

Some options are not available for certain trips.

Deleting a stored trip

1. "Navigation"
2. "Stored trips"
3. Highlight the desired trip.
4. Open "Options".
5. "Delete all trips" or "Delete trip"

Opening the last trip

1. "Navigation"
2. "Stored trips"
3. "Last trip"
4. "Start guidance"

Destination guidance

Vehicle equipment

This chapter describes all series equipment as well as country-specific and special equipment offered for this model series. Therefore, it also describes equipment that may not be found in your vehicle, for instance due to the selected special equipment or the country version. This also applies to safety-related functions and systems.

When using the features and systems described here, adhere to local regulations.

Starting destination guidance

1. "Navigation"
2. Make a destination entry, refer to page 146.
3. "Accept destination"
4. "Start guidance"

The route is shown on the Control Display.

The distance to the destination/intermediate destination and the estimated time of arrival are displayed in the map view.

Terminating destination guidance

1. "Navigation"
2. "Map"
3.  "Guidance"
4. "Stop guidance"

Continuing destination guidance

If the destination was not reached during the last trip, destination guidance can be resumed.





"Resume guidance"

Route criteria

General information

- ▷ The route calculated can be influenced by selecting certain criteria.
- ▷ The route criteria can be changed when the destination is entered and during destination guidance.
- ▷ Road types are part of the navigation data and are taken into consideration when planning a route, e.g., avoid highways.
- ▷ The recommended route may differ from the route you would take based on personal experience.
- ▷ The settings are stored for the remote control currently in use.
- ▷ Destination guidance with traffic bulletins, refer to page 161.

Changing the route criteria

1. "Navigation"
2. "Map"
3.    "Route preference"
4. Select the criterion:
 - ▷  "Fast route": time-optimized route, being a combination of the shortest possible route and the fastest roads.
 - ▷  "ECO PRO route" or "Efficient route": optimized combination of the fastest and shortest possible route.

- ▶  "Short route": short distance, irrespective of how fast or slow progress will be.
- ▶ "Alternative routes": if available, alternative routes are suggested during active destination guidance.
The individual suggestions are highlighted in color.

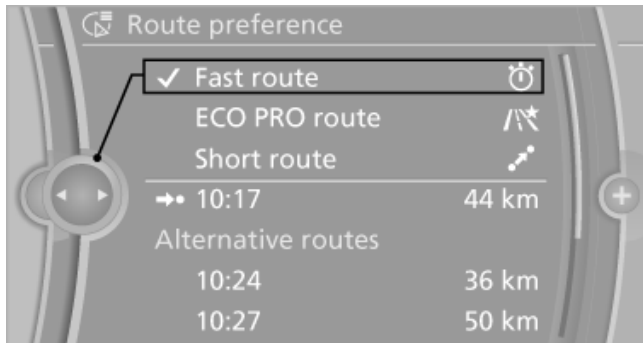

5. Specify additional criteria for the route, if necessary:
 - ▶ "Avoid highways": highways are avoided wherever possible.
 - ▶ "Avoid toll roads": toll roads are avoided wherever possible.
 - ▶ "Avoid ferries": ferries are avoided where possible.

Route

Different views of the route are available during destination guidance:

- ▶ Arrow view.
- ▶ List of route sections.
- ▶ Map view, refer to page [157](#).

Arrow view

The following information is displayed during destination guidance:

- ▶ Large arrow: indicates the current direction of travel.
- ▶ Street name of the currently traveled street.

- ▶ Small arrow: indicates the next change in direction.
- ▶ Intersection view.
- ▶ Lane information.
- ▶ Traffic bulletins.
- ▶ Distance to the next change in direction.
- ▶ Street name at the next change in direction.

Lane information

On multilane roads, the recommended lanes are marked in the arrow view by a triangle.

- ▶ Solid triangle: best lane.
- ▶ Empty triangle: possible lane. However, another lane change may be needed shortly.

Displaying list of route sections

When destination guidance is activated, a list of route sections can be displayed. The driving distance and traffic bulletins are displayed for each route section.

1. "Navigation"
2. "Route information"
3. Highlight route section.

The route section is displayed on the split screen.

Bypassing a section of the route

Calculate a new route for a route section.

1. "Navigation"
2. "Route information"

3. "New route for"

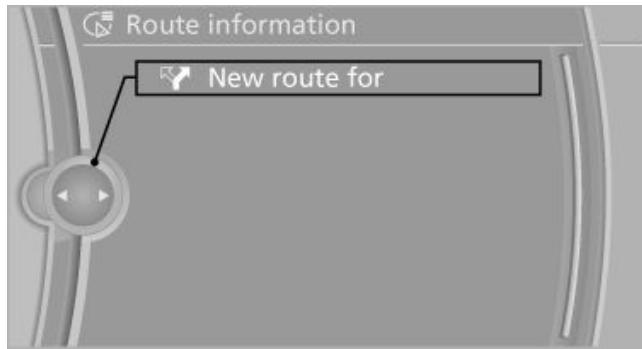

4. Turn the controller. Enter the number of kilometers within which you would like to return to the original route.
5. Press the controller.

Resuming the original route

If the route section should no longer be bypassed:

1. "Navigation"
2. "Route information"
3. "New route for:"
4. "Remove blocking"

Gas station recommendation

The remaining range is calculated, and if needed gas stations along the route are displayed.

Even with the latest navigation data, information on individual Points of Interest may have changed; for example, gas stations might not be in operation.

1. "Navigation"
2. "Route information"
3. "Recommended refuel"

A list of the gas stations is displayed.

4. Highlight a gas station.

The location of the gas station is displayed on the split screen.

5. Select the gas station.

6.  Select the symbol.



7. "Start guidance": destination guidance to the selected gas station is started.

"Add as another destination": the gas station is added to the route.

Destination guidance through voice instructions

Switching spoken instructions on/off

Settings are stored for the remote control currently in use.

1. "Navigation"
2. "Map"
3.   "Voice instructions"

Repeating a spoken instruction

1. "Navigation"
2. "Map"
3.  Highlight the symbol.
4. Press the controller twice.

Volume of spoken instructions

Turn the volume button during the spoken instructions until the desired volume is set.

Settings are stored for the remote control currently in use.

Saving the spoken instructions on the programmable memory buttons

The function for switching the spoken instructions on/off can be stored on a programmable memory button, refer to page 24, for quick access.

Map view

Selecting the map view

1. "Navigation"
2. "Map"

At a glance

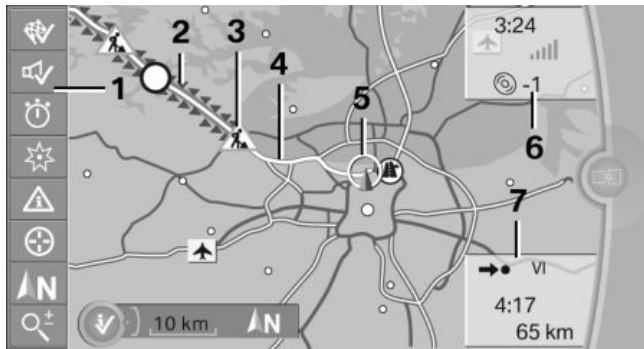

- 1 Function bar
- 2 Route section with traffic obstruction
- 3 Traffic sign for traffic obstruction
- 4 Planned route
- 5 Current location
- 6 Upper status field
- 7 Lower status field

Lines in the map

Streets and routes are displayed in different colors and styles depending on their classification. Dashed lines represent railways and ferry connections. Country borders are indicated by thin lines.

Traffic obstructions

Small triangles along the planned route indicate route sections with traffic obstructions, depending on the map scale. The direction of the triangles indicates the direction of the obstruction.

The traffic signs indicate the significance of the obstruction.

- ▶ Red traffic sign: the obstruction affects the planned route or direction.
- ▶ Grey traffic sign: the obstruction does not affect the planned route or direction.

Traffic bulletins, refer to page [159](#).

Planned route

After destination guidance is started, the planned route is displayed on the map.

Status fields

Show/hide: press the controller.

- ▶ Upper status field: time, telephone, and entertainment details.
- ▶ Lower status field: symbol for active destination guidance, status of traffic bulletins, time of arrival, and distance to destination.

Function bar

The following functions are available in the function bar:

Symbol	Function
	Start/end destination guidance.
	Switch spoken instructions on/off.
	Change the route criteria.
	Search for a special destination.
	Display traffic bulletins.
	Open the interactive map.
	Set the map view.
	Change the scale.

To change to the function bar, move the controller to the left.

Changing the map section

"Interactive map"

- ▶ To shift the map: move the controller in the required direction.
- ▶ To shift the map diagonally: move the controller in the required direction and turn it.

Changing the scale

1. Select the symbol.
2. To change the scale: turn the controller.

Automatically scaled map scale

In the map view facing north, turn the controller in any direction until the AUTO scale is displayed. The entire route between the current location and the destination is displayed on the map.

Settings for the map view

The settings are stored for the remote control currently in use.

1. "Navigation"
2. "Map"
3. Open "Options".
4. "Settings"
5. To set the map view:
 - ▷ "Day/night mode"

Select and create the necessary settings depending on the light conditions.

"Traffic conditions/gray map" active: the setting is disregarded.

- ▷ "Satellite images"

Depending on availability and resolution, satellite images are displayed at scales of approx. 1 mile to 600 miles/2 km to 1,000 km.
- ▷ "Perspective view in 3D"

Prominent areas that are contained in the navigation data are displayed on the map in 3D.
- ▷ "Traffic conditions/gray map"

The map is optimized for displaying traffic bulletins, refer to page 160.

Symbols for the Points of Interest are no longer displayed.

Map view for splitscreen

The map view can be selected for the split screen independently from the main screen:

1. Open "Options".
2. "Split screen"

3. Move the controller to the right repeatedly until the split screen is selected.
4. Select "Split screen content" or the scale.
5. Select the map view.
 - ▷ "Arrow display"
 - ▷ "Map facing north"
 - ▷ "Map direction of travel"
 - ▷ "Map view with perspective"
 - ▷ "Position"
 - ▷ "Exit ramp view": selected blind driveways are displayed three dimensionally.
 - ▷ "Traffic conditions/gray map"
6. To change the scale: select the split screen and turn the controller.

Traffic bulletins

At a glance

- ▷ Display the traffic bulletins from radio stations that broadcast the TI Traffic Information of a traffic information service. Information on traffic obstructions and hazards is updated continuously.

Certain BMW models equipped with navigation have the capability to display real-time traffic information. If your system has this capability the following additional terms and conditions apply:

An End-User shall no longer have the right to use the Traffic Data in the event that the End-User is in material breach of the terms and conditions contained herein.

A. Total Traffic Network, a division of Clear Channel Broadcasting, Inc. ("Total Traffic Network") holds the rights to the traffic incident data and RDS-TMC network through which it is delivered. You may not modify, copy, scan or use any other method to reproduce, duplicate, republish, transmit or distribute in any way any por-

tion of traffic incident data. You agree to indemnify, defend and hold harmless BMW of North America, LLC. ("BMW NA") and Total Traffic Network, Inrix, Inc (and their affiliates) against any and all claims, damages, costs or other expenses that arise directly or indirectly out of (a) your unauthorized use of the traffic incident data or the RDS-TMC network, (b) your violation of this directive and/or (c) any unauthorized or unlawful activities by you in connection herewith.

B. Total Traffic Network traffic data is informational only. User assumes all risk of use. Total Traffic Network, BMW NA, and their suppliers make no representations about content, traffic and road conditions, route usability, or speed.

C. The licensed material is provided to licensee "as is," and "where is". Total Traffic Network, including, but not limited to, any and all third party providers of any of the licensed material, expressly disclaims, to the fullest extent permitted by law, all warranties or representations with respect to the licensed material (including, without limitation, that the licensed material will be error-free, will operate without interruption or that the traffic data will be accurate), express, implied or statutory, including, without limitation, the implied warranties of merchantability, non-infringement fitness for a particular purpose, or those arising from a course of dealing or usage of trade.

D. Neither Total Traffic Network, Inrix, Inc. or BMW NA will be liable to you for any indirect, special, consequential, exemplary, or incidental damages (including, without limitation, lost revenues, anticipated revenues, or profits relating to the same) arising from any claim relating directly or indirectly to use of the traffic data, and even if Total Traffic Network, Inrix, Inc., or BMW NA are aware of the possibility of such damages. These limitations apply to all claims, including, without limitation, claims in con-

tract and tort (such as negligence, product liability and strict liability). Some states do not allow the exclusion or limitation of incidental or consequential damages, so those particular limitations may not apply to you.

- ▶ The traffic bulletins are indicated on the map by symbols.
- ▶ The traffic bulletins for the surrounding area are stored in a list.

 The symbol in the function bar of the map view turns red if there are traffic bulletins that affect the calculated route.

Switching the reception on/off

1. "Navigation"
2. Open "Options".
3. "Receive Traffic Info"

Opening the list of traffic bulletins

1. "Navigation"
2. "Map"
3.  "Traffic Info"

First, traffic bulletins for the calculated route are displayed.

The traffic bulletins are sorted by their distance from the current position of the vehicle.

4. Select a traffic bulletin.
 -  "More information": display additional information.
5. Scroll to the next or previous traffic bulletin if required.

Traffic bulletins on the map

"Traffic conditions/gray map" active:

The Control Display changes to a black and white display. This enables a better view of the traffic bulletins. The day/night mode is disre-

garded in this setting. Symbols and Points of Interest are not displayed.

1. "Navigation"
2. "Map"
3. Open "Options".
4. "Settings"
5. "Traffic conditions/gray map"

Symbols in the map view

Depending on the scale of the map and the location of the traffic obstruction along the route, the symbols for the traffic obstructions are displayed.

Additional information in the map view

Depending on the map scale, a traffic obstruction's length, direction, and impact are displayed in the map using triangles or gray bars along the calculated route.

- ▶ Red: traffic congestion
- ▶ Orange: stop-and-go traffic
- ▶ Yellow: heavy traffic
- ▶ Green: clear roads
- ▶ Gray: general traffic bulletins such as road construction

The displayed information depends on the particular traffic information service.

Filtering traffic bulletins

You can set which traffic bulletins appear on the map.

1. "Navigation"
2. "Map"
3. Open "Options".

4. "Traffic Info categories"
5. Select the desired category.

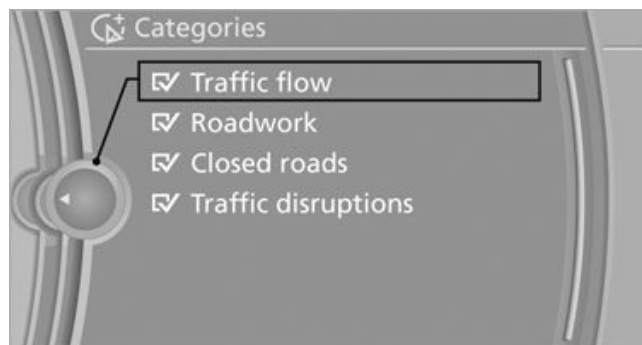

Traffic bulletins of the selected category are displayed on the map.

- ▶ Traffic bulletins that are relevant to the route are always shown.
- ▶ For your own safety, traffic bulletins that notify you of potentially dangerous situations, such as wrong-way drivers, cannot be hidden.

Destination guidance with traffic bulletins

General information

Detour suggestions from the navigation system can be manually accepted when using semi-dynamic destination guidance. When using dynamic destination guidance, they are automatically accepted for route guidance.

Semi-dynamic destination guidance

When traffic bulletin reception is switched on, semi-dynamic destination guidance is active.

The destination guidance system takes the available traffic bulletins into account. A message is displayed depending on the route, the traffic bulletins, and the possible detour routes. If possible, a detour is offered in case of traffic obstructions.

The upper part of the message shows:

- ▶ Symbol of the first traffic obstruction, possibly with the distance to the beginning of the obstruction.

- ▷ Total length of the traffic obstructions on the route.
- ▷ Time by which the trip is extended due to the traffic obstructions.

The lower part of the message shows:

- ▷ Detour recommendation with the distance to the beginning of the detour.
- ▷ Difference between the length of the new route compared to the original route.
- ▷ Time gained if the detour is taken compared to the original route with the traffic obstructions.



Both the original route, shown in white, and the detour are displayed on the split screen.

Accepting the detour

"Detour"

In the event of special hazards, e. g., objects on the road, a message is displayed without a detour suggestion.

Detours can also be accepted if the traffic messages are called up in the list.

1. "Navigation"
2. "Map"
3.  "Traffic Info"
4. "Detour information"
5.  "Detour"

Dynamic destination guidance

The route is automatically changed in the event of traffic obstructions.

- ▷ The system does not point out traffic obstructions along the original route.
- ▷ Traffic bulletins continue to be displayed on the map.
- ▷ Depending on road type and the kind and extent of the traffic obstruction, the calculated route may lead through the traffic obstruction.
- ▷ Dangerous situations are displayed regardless of the setting.

Activating dynamic destination guidance

1. "Navigation"
2. Open "Options".
3. "Dynamic guidance"

What to do if...

- ▶ The current transmission position cannot be displayed?

The vehicle is located in an unrecognized region, is in a poor reception area, or the system is currently determining the position. Reception is usually best when you have an unobstructed view of the sky.

- ▶ The destination without street information is not used for route guidance?

When city has been input, no downtown can be determined. Input any street in the selected city and start destination guidance.

- ▶ The destination is not used for route guidance?

The destination data is not contained in the navigation data. Select a destination that is as close as possible to the original.

- ▶ Letters for destination input cannot be selected?

The stored data do not contain the data of the destination. Select a destination that is as close as possible to the original.

- ▶ Is the map displayed in shades of gray?
"Traffic conditions/gray map" active:

The Control Display changes to a black and white display. This enables a better view of the traffic bulletins.

- ▶ Spoken instructions are no longer output during route guidance in front of intersections?

The area has not yet been fully recorded, or you have left the recommended route and the system requires a few seconds to calculate a new route suggestion.



Entertainment

This chapter helps assure your enjoyment when receiving radio stations and playing CDs, DVDs, and tracks from the music collection.



Tone

Vehicle equipment

This chapter describes all series equipment as well as country-specific and special equipment offered for this model series. Therefore, it also describes equipment that may not be found in your vehicle, for instance due to the selected special equipment or the country version. This also applies to safety-related functions and systems.

When using the features and systems described here, adhere to local regulations.

General information

The sound settings are stored for the remote control currently in use.

Treble, bass, balance, and fader

- ▷ "Treble": treble adjustment.
- ▷ "Bass": depth adjustment.
- ▷ "Balance": left/right volume distribution.
- ▷ "Fader": front/rear volume distribution.

Setting treble, bass, balance, and fader

1. "CD/Multimedia", "Radio" or "Settings"
2. "Tone"



3. Select the desired tone settings.

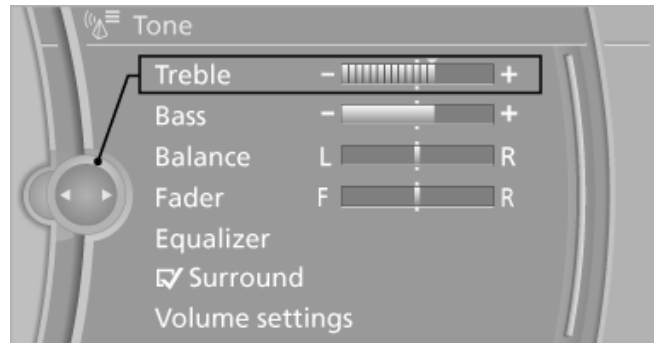

4. To adjust: turn the controller.
5. To store: press the controller.

Equalizer

Setting for individual audio frequency ranges.

Adjusting the equalizer

1. "CD/Multimedia", "Radio" or "Settings"
2. "Tone"
3. "Equalizer"
4. Select the desired setting.

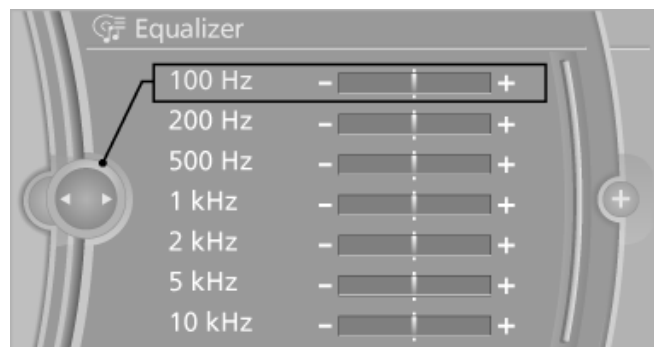

5. To adjust: turn the controller.
6. To store: press the controller.

Multi-channel playback, surround

Choose between stereo and multi-channel playback, surround.

Setting multi-channel playback, surround

1. "CD/Multimedia", "Radio" or "Settings"
2. "Tone"
3. "Surround"

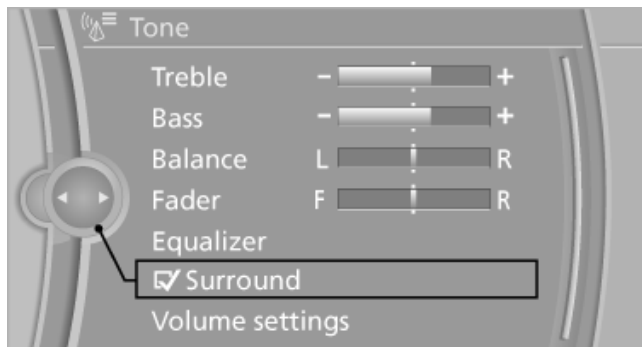

When surround is activated, multi-channel playback is simulated when a stereo audio track is played.

Volume

- ▷ "Speed volume": speed-dependent volume control.
- ▷ "PDC": volume of the PDC signal compared to the entertainment sound output.
- ▷ "Gong": volume of the signal, such as the safety belt reminder, compared to the entertainment sound output.
- ▷ "Microphone": volume of the microphone during a phone call.
- ▷ "Loudspeak.": volume of the loudspeakers during a phone call.

The following volumes are only stored for the respective paired telephone: "Microphone", "Loudspeak.".

Adjusting the volume

1. "CD/Multimedia", "Radio" or "Settings"
2. "Tone"
3. "Volume settings"
4. Select the desired volume setting.

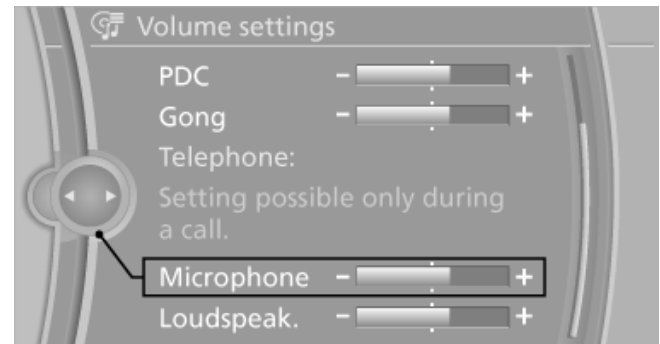

5. To adjust: turn the controller.
6. To store: press the controller.

Resetting the tone settings

All tone settings can be reset to the default setting.

1. "CD/Multimedia", "Radio" or "Settings"
2. "Tone"
3. "Reset"

Radio

Vehicle equipment

This chapter describes all series equipment as well as country-specific and special equipment offered for this model series. Therefore, it also describes equipment that may not be found in your vehicle, for instance due to the selected special equipment or the country version. This also applies to safety-related functions and systems.

When using the features and systems described here, adhere to local regulations.

Controls

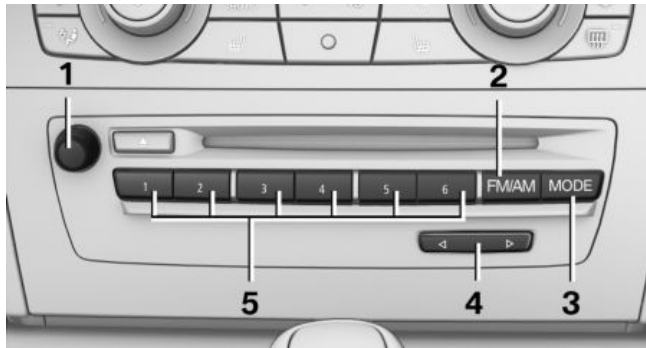

- 1 Volume, on/off
- 2 Change wave band
- 3 Change entertainment sources
- 4 Change station/track
- 5 Programmable memory buttons

Sound output

Switching on/off

When the ignition is switched off: press ON/OFF button on the radio.

Muting

When the ignition is switched on or the engine is running: press the ON/OFF button on the radio.

AM/FM station

Selecting a station

1. "Radio"
2. "FM" or "AM"
3. Select the desired station.

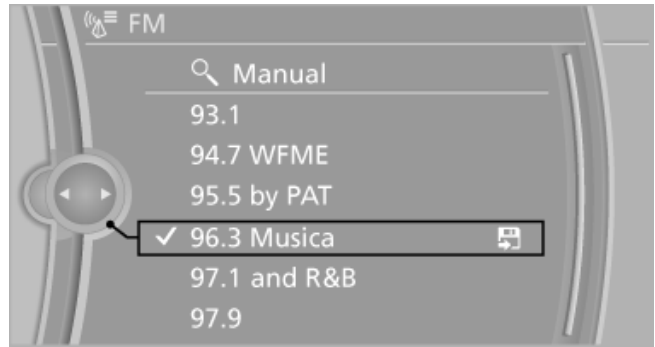

All saved stations are stored for the remote control currently in use.

Changing the station

Turn the controller and press it
or



Press the button

or

Press the buttons on the steering wheel, refer to page 14.

Storing a station

1. "Radio"
2. "FM" or "AM"

3. Highlight the desired station.

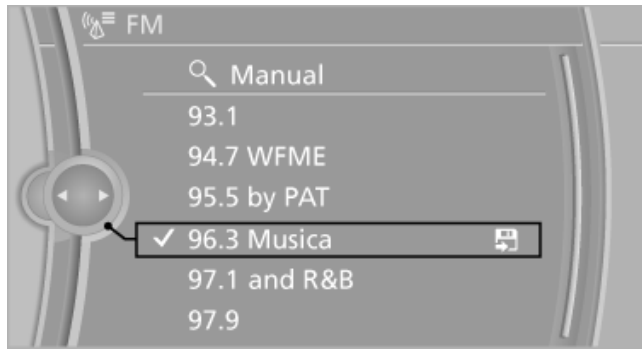

4. Press the controller for an extended period.
5. Select the desired memory location.

The stations are stored for the remote control currently in use.

The stations can also be stored on the programmable memory buttons, refer to page 24.

Selecting a station manually

Station selection via the frequency.

1. "Radio"
2. "FM" or "AM"
3. "Manual"
4. To select the frequency: turn the controller.

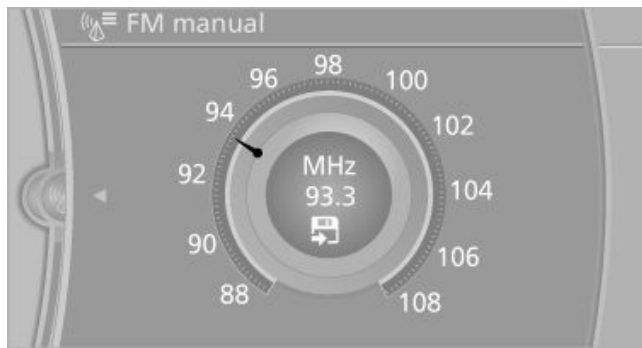

To store the station: press the controller for an extended period.

Renaming a station

An FM station with changing station names can be renamed.

1. "Radio"
2. "FM"

3. Select the desired station.
4. Open "Options".
5. "Rename to:"
If necessary, wait for the desired name to be displayed.

The selected station name is added to the list of current stations and stored stations.

RDS

RDS broadcasts additional information, such as the station name, in the FM wave band.

Switching the RDS on/off

1. "Radio"
2. "FM"
3. Open "Options".
4. "RDS"

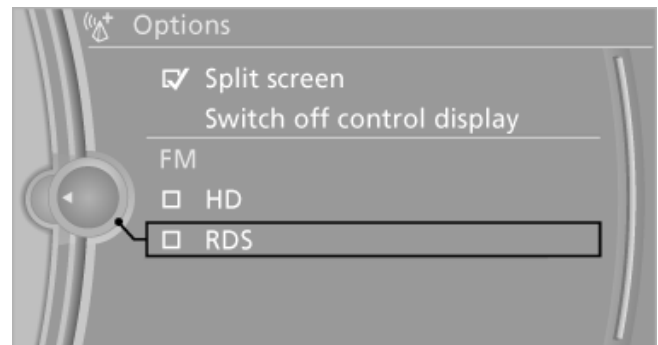

The setting is stored for the remote control currently in use.

HD Radio™ reception

Many stations broadcast both analog and digital signals.

License conditions

HD Radio Technology manufactured under license from iBiquity Digital Corporation. U.S. and Foreign Patents. HD Radio™ and the HD, HD Radio, and Arc logos are proprietary trademarks of iBiquity Digital Corp.

Activating/deactivating digital radio reception

1. "Radio"
2. "FM" or "AM"
3. Open "Options".
4. "HD Radio Reception"

The setting is stored for the remote control currently in use.

 This symbol is displayed in the status line when the audio signal is digital.

When tuning to a station with a digital signal, it may take several seconds for the station to be played back in digital quality.

Note on HD stations whose station name ends in ...HD or with ...HD1:

In areas in which the station is not continuously received in digital mode, the playback switches between analog and digital reception. In this case, switch off digital radio reception.

Note on HD multicast stations whose station name ends in ...HD2, ...HD3, ...:

In areas in which the station is not continuously received in digital mode, the audible signal may be interrupted for several seconds. This is reception related.

Displaying additional information

Some stations broadcast additional information on the current track, such as the name of the artist.

1. Select the desired station.
2. Open "Options".
3. "Station info"

Selecting a substation

 This symbol indicates that a main station also broadcasts additional substations. The station name of the main station ends in HD1. Station names of the substations end in HD2, HD3, etc.

1. Select the desired station.

2. Press the controller.
3. Select the substation.







When reception is poor, the substation is muted.

Satellite radio

General information

The channels are offered in predefined packages. The packages must be enabled by telephone.

Navigation bar overview

Symbol	Function
	Change the list view.
	Select the category.
	Direct channel entry
	Timeshift
	Open the My Favorites category/open a favorite.
	Manage the favorites.
	Traffic Jump

The functions of the navigation bar symbols can also be stored on the programmable memory buttons, refer to page 24.

Managing a subscription

To be able to enable or unsubscribe from the channels, you must have reception. It is usually at its best when you have an unobstructed view of the sky. The channel name is displayed in the status line.

Enabling channels

The Unsubscribed Channels category contains all disabled channels.

1. "Radio"
2. "Satellite radio"
3.  "Category"



4. Select the Unsubscribed Channels category.
5. Select the desired channel.
The phone number and an electronic serial number, ESN, are displayed.
6. Select the phone number to have the channel enabled.



You can unsubscribe from the channels again via this phone number.

Unsubscribing from channels

1. "Radio"
2. "Satellite radio"
3. Open "Options".

4. "Manage subscription"

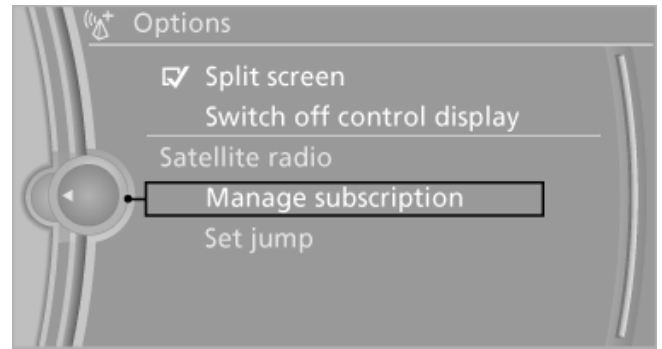

5. The phone number and an electronic serial number, ESN, are displayed.
6. Call Sirius to unsubscribe from the channels.

Selecting channels

You can only listen to enabled channels.

The selected channel is stored for the remote control currently in use.

Via the iDrive

1. "Radio"
2. "Satellite radio"
3. Select "All channels" or the desired category.
4. Select the desired channel.



Via the button on the radio



Press the button.

The next channel is selected.

Via direct channel entry

1. "Radio"
2. "Satellite radio"
3.  "Set channel"
4. Turn the controller until the desired channel is reached and press the controller.

Storing a channel

1. "Radio"
2. "Satellite radio"
3. If necessary, open "All channels" or the desired category.
4. Select the desired channel.
5. Press the controller again.
6. Press the controller again to confirm the highlighted channel.

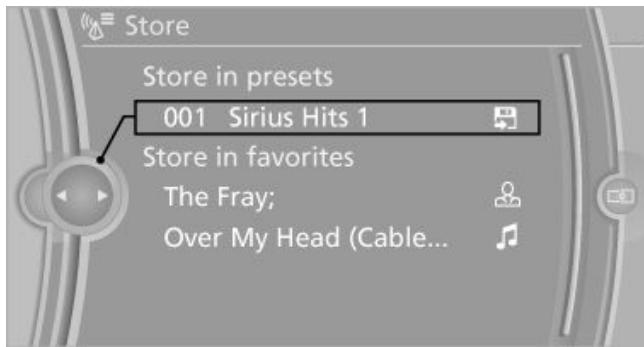

7. Select the desired memory location.



The channels are stored for the remote control currently in use.

The channels can also be stored on the programmable memory buttons, refer to page 24.

Changing the list view

The list view changes every time the first symbol on the navigation bar is pressed.

Information on the channel is displayed.

Symbol	Meaning
	Channel name
	Artist
	Track

Selecting a category

1. "Radio"
2. "Satellite radio"
3.  "Category"
4. Select the desired category.

Timeshift

Approx. one hour of the program being broadcast on the channel currently being listened to is stored in a buffer. Prerequisite: the signal must be available.

The stored audio track can be played with a delay following the live broadcast. When the buffer is full, the older tracks are overwritten. The buffer is cleared when a new channel is selected.

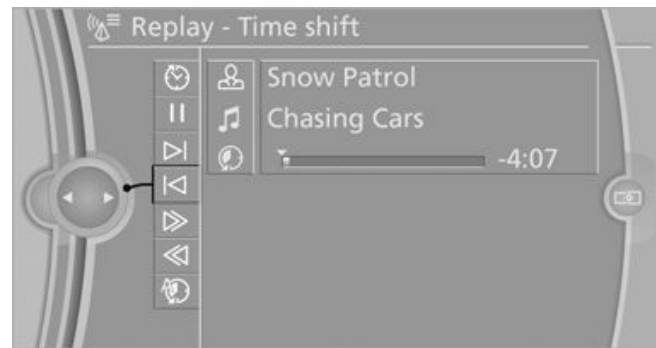

Opening the timeshift function

1. "Radio"
2. "Satellite radio"
3.  "Replay - Time shift"



- ▶ The red arrow shows the current playback position.
- ▶ The time difference to the live broadcast is displayed next to the buffer bar.
- ▶ For live transmissions "live".

Timeshift menu

Symbol	Function
	Go to the live broadcast
	Playback/pause

Symbol	Function
▷	Next track
◁	Previous track
⏭	Fast forward
⏮	Reverse
	Automatic timeshift deactivated/activated



Automatic timeshift

When the function is activated, audio playback is stopped automatically in the event of:

- ▷ Incoming and outgoing telephone calls.
- ▷ Activation of the voice activation system.
- ▷ Muting.

The audio playback then continues with a time delay.

To activate:

1. "Radio"
2. "Satellite radio"
3.  "Replay - Time shift"
4.  "Automatic time shift"

To deactivate:

-  "Automatic time shift"

Storing favorites

Up to 30 favorites can be stored in the favorites list. Available favorites are artist, track, game, league, and team.

Storing the artist, track, or game

It is only possible to store favorites that are currently being broadcast. The channel information must be available.

1. "Radio"
2. "Satellite radio"
3. If necessary, open "All channels" or the desired category.

4. Select the desired channel.
5. Press the controller again.
6. Select the artist, track, or game.

Storing the league or team

Leagues or teams can be added to the favorites from a selection list.

1. "Radio"
2. "Satellite radio"
3.  "Manage favorites"
4. "Add sports information"

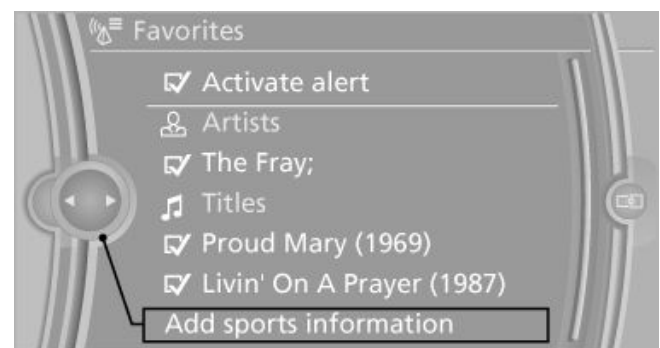

5. Select the league.
6. Select "Add all teams" or the desired team.

Opening the favorites

If an activated favorite is played back, the following message appears for approx. 20 seconds "Favorite alert!".

 "Favorites"

Select the symbol while the message is shown.



The displayed favorite is played.

If there is no message, the system changes to the My Favorites category. All favorites currently being broadcast can be selected from a list.

Managing the favorites

Activating/deactivating the favorites

Favorites can be activated and deactivated globally and individually.

1. "Satellite radio"
2. ☆+ "Manage favorites"
3. Select "Activate alert" or the desired favorites.

The setting is stored for the remote control currently in use.

Deleting favorites

1. "Satellite radio"
2. ☆+ "Manage favorites"
3. Highlight the desired favorite.
4. Open "Options".
5. "Delete entry"

Traffic Jump

Traffic and weather information for a selected region is broadcast every few minutes.

Selecting a region

1. "Radio"
2. "Satellite radio"
3. Open "Options".
4. "Set jump"
5. Select the desired region.

The region is stored for the remote control currently in use.



Activating/deactivating the jump

1. "Radio"
2. "Satellite radio"
3. ↶ "Jump to:"

Information for the selected region is broadcast as soon as it is available.

A new panel opens.

Canceling the Traffic Jump: "Cancel".

Symbol	Meaning
	Information will be broadcast shortly.
	Information is currently being broadcast.

Select one of the symbols to deactivate Traffic Jump.

Automatic update

About twice a year, Sirius performs an update of the channel names and positions. The update takes place automatically and may take several minutes.

Notes

- ▶ Reception may not be available in some situations, such as under certain environmental or topographic conditions. The satellite radio has no influence on this.
- ▶ The signal may not be available in tunnels or underground garages; next to tall buildings; or near trees, mountains or other powerful sources of radio interference.

Stored stations

General information

It is possible to store up to 40 stations.

Calling up a station

1. "Radio"
2. "Presets"
3. Select the desired station.

Storing a station

The station currently selected is stored.

1. "Radio"
2. "Presets"
3. "Store station"



4. Select the desired memory location.

The list of stored stations is stored for the remote control currently in use.

The stations can also be stored on the programmable memory buttons, refer to page [24](#).

Deleting a station

1. "Radio"
2. "Presets"
3. Select the desired station.
4. Open "Options".
5. "Delete entry"

CD/multimedia

Vehicle equipment

This chapter describes all series equipment as well as country-specific and special equipment offered for this model series. Therefore, it also describes equipment that may not be found in your vehicle, for instance due to the selected special equipment or the country version. This also applies to safety-related functions and systems.

When using the features and systems described here, adhere to local regulations.

Controls



- 1 Volume, on/off
- 2 Eject CD/DVD
- 3 CD/DVD drive
- 4 Change the entertainment source
- 5 Change station/track
- 6 Programmable memory buttons

Sound output

Switching on/off

When the ignition is switched off: press ON/OFF button on the radio.

Muting

When the ignition is switched on or the engine is running: press the ON/OFF button on the radio.

CD/DVD

Playback

Loading the CD/DVD player

Insert the CD/DVD with the printed side up. Playback begins automatically.

Reading can take a few minutes with compressed audio files.

Starting playback

A CD/DVD is contained in the CD/DVD player.

1. "CD/Multimedia"
2. "CD/DVD"
3. Select the desired CD or DVD.



Symbol	Meaning
	CD/DVD player

Playable formats

- ▶ DVD: DVD-ROM, DVD-R, DVD+R, DVD-RW, DVD+RW, DVD-R DL, DVD+R DL, DVD audio (video part only), DVD video.

- ▷ CD: CD-ROM, CD-R, CD-RW, CD-DA.
- ▷ Compressed audio files: MP3, WMA, AAC, M4A.

Audio playback

Selecting the track using the button

 Press the button for the appropriate direction as often as necessary until the desired track is played back.

Selecting the track using the iDrive

Audio CDs

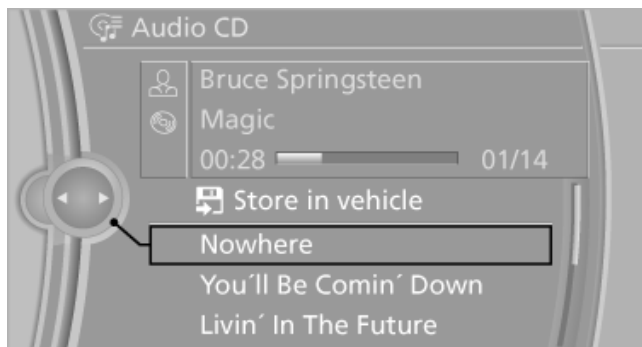

Select the desired track to begin playback.

CDs/DVDs with compressed audio files

Depending on the data, some letters and numbers of the CD/DVD may not be displayed correctly.

1. Select the directory if necessary.
To change to a higher level directory: move the controller to the left.



2. Select the desired track to begin playback.

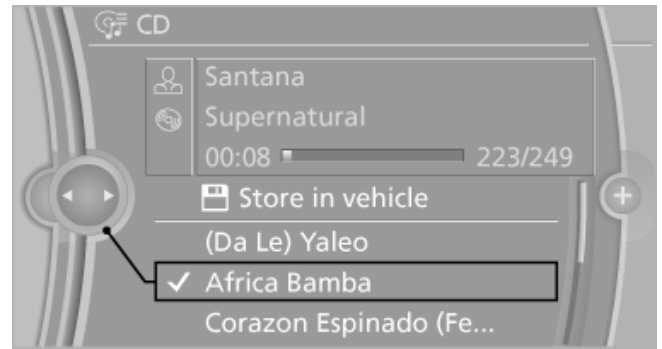

Displaying information on the track

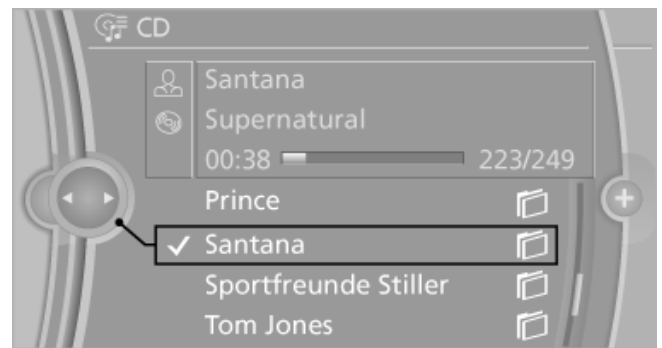

If information about a track has been stored, it is displayed automatically:

- ▷ Artist.
- ▷ Album track.
- ▷ Number of tracks on the CD/DVD.
- ▷ File name of track.

Random playback

1. "CD/Multimedia"
2. "CD/DVD"
3. Select the desired CD or DVD.

4. Open "Options".
5. "Random"

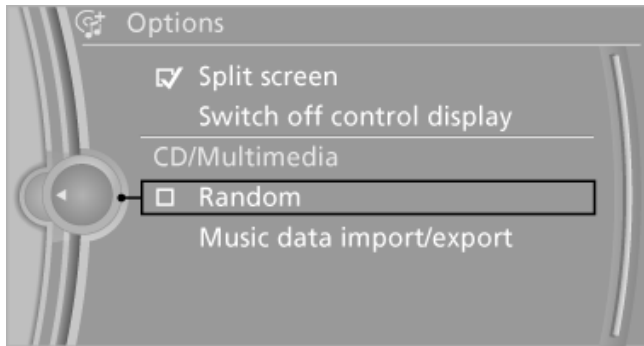

CDs/DVDs with compressed audio files: all tracks within the selected directory are played in random order.

Random mode is switched off when the audio source is changed and the ignition is switched off.

Fast forward/reverse



Press and hold the button.

Video playback

Country codes

Only DVDs with the code of the home region can be played back; also refer to the information on the DVD.

Code	Region
1	USA, Canada
2	Japan, Europe, Middle East, South Africa
3	Southeast Asia
4	Australia, Central and South America, New Zealand
5	Northwest Asia, North Africa
6	China
0	All regions

Playback

The video image is displayed on the Control Display up to a speed of approx. 2 mph/3 km/h; in some countries, it is only displayed while the parking brake is set or the automatic transmission is in position P.

DVD video

1. "CD/Multimedia"
2. "CD/DVD"
3. Select a DVD with video content.
4.  "DVD menu"











5. Start the DVD via the DVD menu.

Video menu

To open the video menu: turn the controller during playback.

Press the controller when "Back" is displayed.

Symbol	Function
	Open DVD menu
	Starting playback
	Pause
	Stop
	Next chapter
	Previous chapter
	Fast forward
	Reverse

In fast forward/reverse: the speed increases every time the controller is pressed. To stop, start playback.

DVD menu

1. If necessary, turn the controller to open the video menu.
2. **DVD** "DVD menu"

The DVD menu is displayed. The display depends on the contents of the DVD.

3. To select menu items: move the controller and press it.

To change to the video menu: turn the controller and press it.

DVD settings

For some DVDs, settings can only be made via the DVD menu; refer also to the information on the DVD.

Selecting the language

The languages that are available depend on the DVD.

1. Turn the controller during playback.
2. Open "Options".
3. "Audio/language"

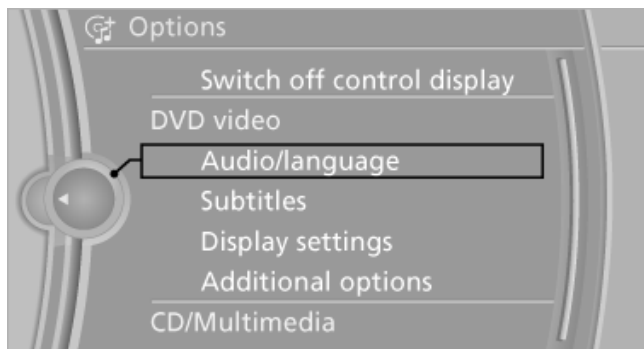

4. Select the desired language.

Selecting the subtitles

The subtitles that are available depend on the DVD.

1. Turn the controller during playback.
2. Open "Options".
3. "Subtitles"
4. Select the desired language or "Do not display subtitles".

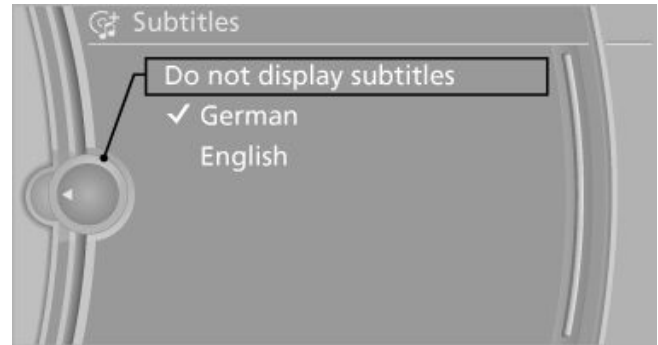

Setting the brightness, contrast and color

1. Turn the controller during playback.
2. Open "Options".
3. "Display settings"
4. "Brightness", "Contrast" or "Color"

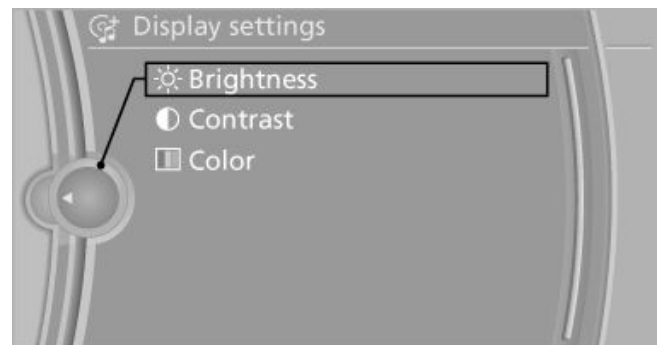

5. Turn the controller until the desired setting is reached and press the controller.

Selecting the zoom

Display the video image on the entire screen.

1. Turn the controller during playback.
2. Open "Options".

3. "Additional options"
4. "Zoom mode"

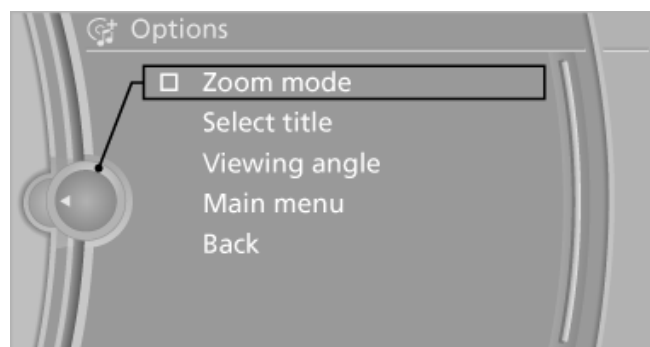

Selecting a track

DVD video:

1. Turn the controller when the DVD menu is displayed.
2. Open "Options".
3. "Additional options"
4. "Select title"
5. Select the desired track.

Selecting the camera angle

The availability of a different camera angle depends on the DVD and the current DVD track.

1. Turn the controller during playback.
2. Open "Options".
3. "Additional options"
4. "Viewing angle"
5. Select the desired camera angle.

Opening the main menu, back

These functions are not contained on every DVD. Therefore, they may not be available for use.

Notes

CD/DVD player



Do not remove the cover

BMW CD/DVD players and changers are officially designated Class 1 laser products. Do not operate if the cover is damaged; otherwise, severe eye damage can result. ◀

CDs and DVDs



Use of CDs/DVDs

- ▶ Do not use self-recorded CDs/DVDs with labels applied, as these can become detached during playback due to heat buildup and can cause irreparable damage to the device.
- ▶ Only use round CDs/DVDs with a standard diameter of 4.7 in/12 cm and do not play CDs/DVDs with an adapter, e.g., single CDs; otherwise, the CDs or the adapter may jam and no longer eject.
- ▶ Do not use combined CDs/DVDs, e.g., DVD Plus, as the CDs/DVDs can jam and will no longer eject. ◀

General malfunctions

- ▶ CD/DVD players have been optimized for performance in vehicles. In some instances they may be more sensitive to faulty CDs/DVDs than stationary devices would be.
- ▶ If a CD/DVD cannot be played, first check whether it has been inserted correctly.

Humidity

High levels of humidity can lead to condensation on the CD/DVD or the laser's scan lens, and temporarily prevent playback.

Malfunctions involving individual CDs/DVDs

If malfunctions occur only with particular CDs/DVDs, this can be due to one of the following causes:

Self-recorded CDs/DVDs

- ▷ Possible reasons for malfunctions with self-recorded CDs/DVDs are inconsistent data creation or recording processes, or poor quality or old age of the blank CD/DVD.
- ▷ Only label CDs/DVDs on the upper side with a pen intended for this purpose.

Damage

- ▷ Avoid fingerprints, dust, scratches and moisture.
- ▷ Store CDs/DVDs in a sleeve.
- ▷ Do not subject CDs/DVDs to temperatures over 122 °F/50 °C, high humidity or direct sunlight.

CDs/DVDs with copy protection

CDs/DVDs are often provided with a copy protection feature by the manufacturer. This can mean that some CDs/DVDs cannot be played or can only be played to a limited extent.

MACROVISION

This product contains copyrighted technology that is based on multiple registered US patents and the intellectual property of the Macrovision Corporation and other manufacturers. The use of this copy protection must be approved by Macrovision. Media protected by this product - unless otherwise agreed with Macrovision - may only be used for private purposes. Copying of this technology is prohibited.

DTS Digital Surround™



Manufactured under license under U.S. Patent Numbers: 5,451,942; 5,956,674; 5,974,380; 5,978,762; 6,487,535 & and other patents granted and registered in the USA and worldwide. DTS and the logo are registered trademarks & DTS Digital Surround and the DTS logos are trademarks of DTS Inc. © DTS, Inc. All rights reserved.

Music collection

Storing music

General information

Music tracks from CDs/DVDs and USB devices can be stored in the music collection on a hard disc in the vehicle and played from there.

- ▷ Audio CD: tracks are converted into a compressed audio format. If available, information on the album, such as the artist, is stored as well.
- ▷ CD/DVD or USB device with compressed audio files: the entire content of the CD/DVD or the USB device is stored in the vehicle as an album. The WMA, MP3, M4A, and AAC formats are stored. Individual tracks and directories can be deleted later. Deleting a track and directory, refer to page 185.

Tracks with DRM copy protection can be stored but cannot be played back.



Backing up music data

Regularly back up the music data; otherwise, it could be lost if there is a fault on the hard disc. ◀



Music recognition technology and related data are provided by Gracenote®. Gracenote is the industry standard in music recognition technology and related content delivery. For more information, please visit www.gracenote.com

CD and music-related data from Gracenote, Inc., copyright © 2000, Gracenote up to now. Gracenote-Software Copyright 2000, Gracenote up to now. This product and service may practice one or more of the following U.S. Patents: #5,987,525; #6,061,680; #6,154,773, #6,161,132, #6,230,192, #6,230,207, #6,240,459, #6,330,593, and other patents issued or pending. Some services supplied under license from Open Globe, Inc. for U.S. Patent: #6,304,523.

Storing from a CD/DVD

1. Insert a CD or DVD into the CD/DVD player.
2. "CD/Multimedia"
3. "CD/DVD"
4.  Select the symbol for the CD/DVD player.
5. "Store in vehicle"



The music collection is displayed and the first track of the CD/DVD is played back. During the storage process, the tracks are played in sequence.

Observe the following during the storage process:

Do not switch to the CD/DVD player and do not remove the CD/DVD from the CD/DVD player as this will interrupt the storage process. You can switch to the other audio sources without interrupting the storage process. Tracks from the current CD/DVD that have already been stored can be called up.

Interrupting storage

1. "CD/Multimedia"
2. "CD/DVD"

3. "Storing..."



4. "Cancel storing"

The storage process is interrupted and can be continued at any time.

Continuing the storage process

1. "CD/Multimedia"
2. "CD/DVD"
3.  Select the symbol for the CD/DVD player.
4. "Continue storing"

Storage of the CD/DVD continues at the beginning of the track at which storage was interrupted.

Album information

During storage, information such as the name of the artist is stored with the track, if this information is available in the vehicle database or on the CD.

To update the database, contact your service center.

Storing from a USB device

To store music, a suitable device must be connected to the USB interface in the glove compartment.

- ▶ Suitable devices: USB mass storage devices, such as USB flash drives or MP3 players with a USB interface.
- ▶ Unsuitable devices: USB hard drives, USB hubs, USB memory card readers with multiple inserts, Apple iPod/iPhone. Music from the Apple iPod/iPhone can be played

via the USB audio interface in the center armrest.

- ▶ File systems: standard file systems for USB devices are supported. The FAT 32 format is recommended.
1. Connect the USB device to the USB interface in the glove compartment, refer to page 125.
 2. "CD/Multimedia"
 3. "Music collection"
 4. Open "Options".
 5. "Music data import/export"
 6. "Import music (USB)"

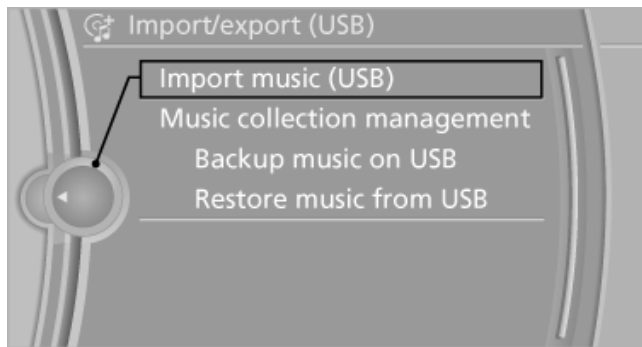

Playing music

Music search

All tracks for which additional information has been stored can be accessed by the music search. Tracks without additional information can be called up via the corresponding album, refer to page 184.

1. "CD/Multimedia"
2. "Music collection"

3. "Music search"



4. Select the desired category.

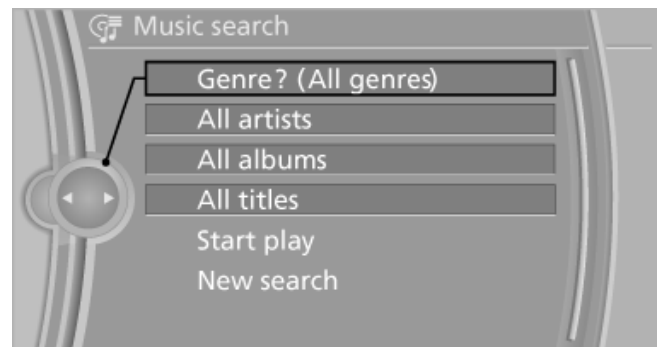

5. Select the desired entry.

- ▶ Select "A-Z search", refer to page 25, and input the desired entry.
- ▶ Select the desired entry from the list.

6. Select other categories if you wish.

The tracks found are listed in alphabetical order.

Not all categories need to be selected. For example, to search for all tracks by a certain artist, call up that artist only. All of the tracks by that artist are then displayed.

7. "Start play"

The list of tracks is repeated automatically.

Restarting the music search

"New search"

Music search by voice

Instructions for voice activation system, refer to page 27.

1.  Press the button on the steering wheel.
2. ›Music search‹
3. Open the desired category, e. g., ›Select artist‹.
4. Say the desired entry in the list.
5. Select other categories if you wish.

To select a track directly: ›Title ...‹

Say the voice command and the name of the desired track in a single command.

Current playback

The list of tracks that was generated last by the music search, or the album that was selected last.

1. "CD/Multimedia"
2. "Music collection"
3. "Current playback"

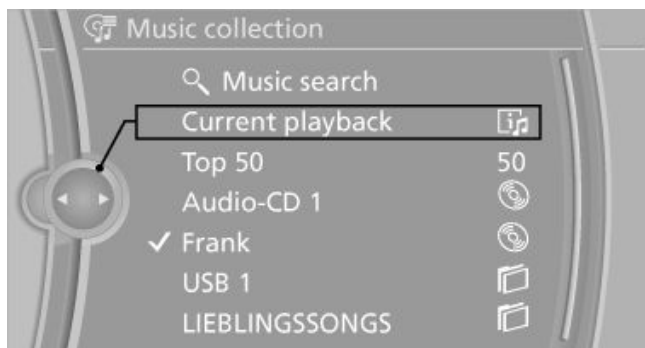

4. Select the desired track, if necessary.



Top 50

The 50 most frequently played tracks.

1. "CD/Multimedia"
2. "Music collection"
3. "Top 50"
4. Select the desired track, if necessary.

Albums

All stored albums, listed in order of their storage dates.

Symbol	Format
	Audio CD
	Compressed audio files

1. "CD/Multimedia"
2. "Music collection"
3. Select the desired album.

Depending on the album, the tracks or the subdirectories of the album are displayed. The first track is played automatically, if possible.

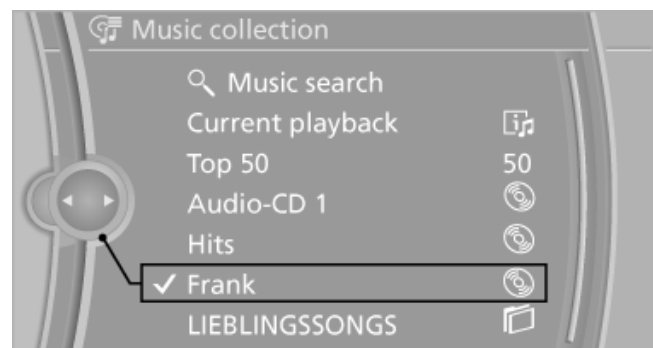

4. Change directories if needed to select tracks.

To go up a level in the directory: move the controller to the left.

Random playback

All tracks of the selection are played back in random order.

1. "CD/Multimedia"
2. "Music collection"

3. Open "Options".
4. "Random"



Managing music

Albums

Renaming an album

The name of the album, if available, is automatically entered when the album is stored. If the name is not available, it can be changed later if desired.

1. "CD/Multimedia"
2. "Music collection"
3. Highlight the desired album.
4. Open "Options".
5. "Rename album"

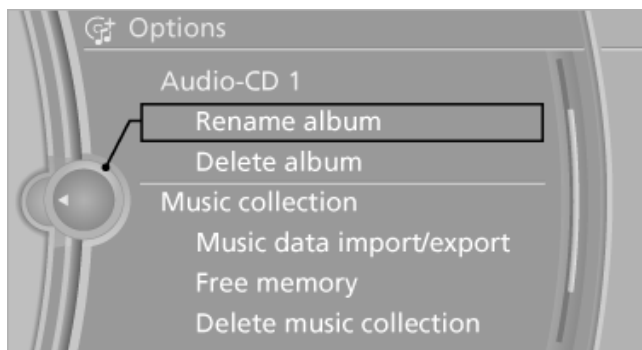

6. Select the letters individually.

Deleting an album

An album cannot be deleted while a track from that album is being played.

1. "CD/Multimedia"
2. "Music collection"
3. Highlight the desired album.
4. Open "Options".
5. "Delete album"

Deleting a track and directory

A track cannot be deleted while it is being played.

A directory cannot be deleted while a track from that directory is being played.

1. "CD/Multimedia"
2. "Music collection"
3. Highlight the directory or track.
4. Open "Options".
5. "Delete folder" or "Delete track"

Free memory capacity

Display the free memory capacity in the music collection.

1. "CD/Multimedia"
2. "Music collection"
3. Open "Options".
4. "Free memory"

Music collection

Backing up the music collection

The entire music collection can be stored on a USB device. Make sure there is enough free memory capacity on the USB device.

Depending on the number of tracks, backing up the music collection may take several

hours. Therefore, it is best to perform the backup during a long trip.

1. Starting the engine.
2. Connect the USB device to the USB interface in the glove compartment, refer to page 125.
3. "CD/Multimedia"
4. "Music collection"
5. Open "Options".
6. "Music data import/export"

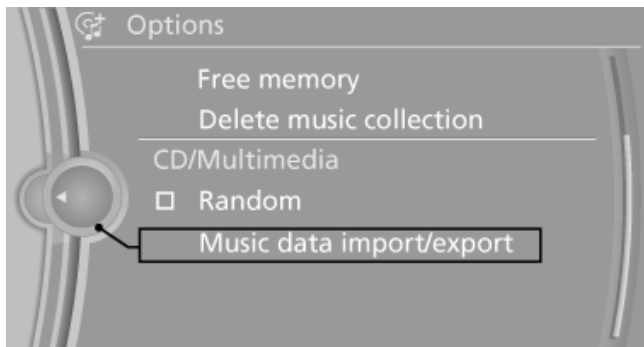

7. "Backup music on USB"

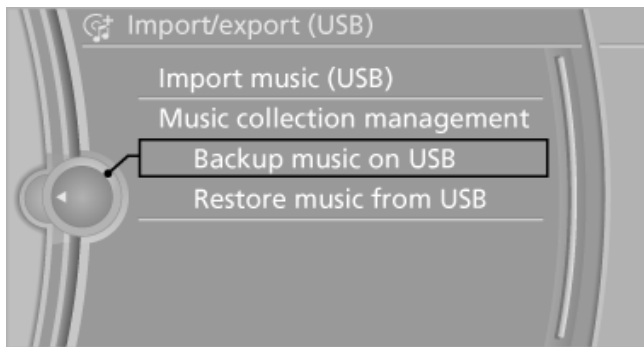

Storing the music collection in the vehicle

When storing from the USB device, the existing music collection in the vehicle is replaced.





1. "CD/Multimedia"
2. "Music collection"
3. Open "Options".
4. "Music data import/export"
5. "Restore music from USB"

Deleting the music collection

1. "CD/Multimedia"
2. "Music collection"
3. Open "Options".
4. "Delete music collection"

External devices

At a glance

Symbol	Meaning
	AUX-IN port
	USB audio interface
	Music interface for smartphones
	Bluetooth audio

AUX-IN port

At a glance

- ▶ For connecting audio devices, e.g., MP3 player. The sound is output on the vehicle loudspeakers.
- ▶ Recommendation: use medium tone and volume settings on the audio device. The tone depends on the quality of the audio files.

Connecting



The AUX-IN port is in the center console.

Connect the headphone connector or line-out connector of the device to the AUX-IN port.

Playback

1. Connect the audio device, switch it on and select a track on the audio device.
2. "CD/Multimedia"
3. If necessary, "External devices"
4.  "AUX front"

Sound is output on the vehicle loudspeakers.

Volume

The volume of the sound output is dependent on the audio device. If this volume differs markedly from the volume of the other audio sources, it is advisable to adjust the volumes.

Adjusting the volume

1. "CD/Multimedia"
2. If necessary, "External devices"
3.  "AUX front"
4. "Volume"

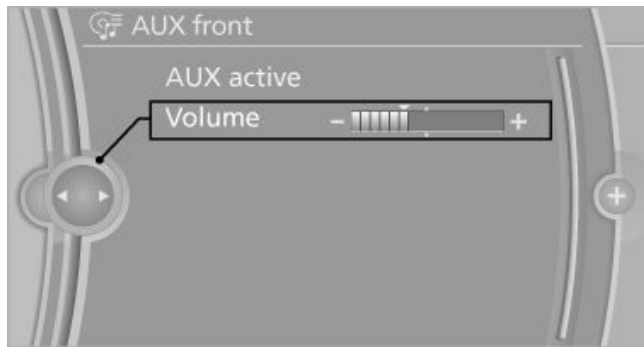

5. Turn the controller until the desired volume is set and press the controller.

USB audio interface/music interface for smartphones

At a glance

It is possible to connect external audio devices. They can be operated via iDrive. The sound is output on the vehicle loudspeakers.

Connectors for external devices

- ▶ Connection via USB audio interface: Apple iPod/iPhone, USB devices, e.g., MP3 players, USB flash drives, or mobile phones that are supported by the USB audio interface.
- ▶ Connection via snap-in adapter, refer to page 207, when equipped with the music interface for smartphones: Apple iPhone or mobile phones.

Playback is only possible if no audio device is connected to the analog AUX-IN port.

Due to the large number of different audio devices available on the market, it cannot be ensured that every audio device/mobile phone is operable on the vehicle.

Ask your service center about suitable audio devices/mobile phones.

Audio files

Standard audio files can be played back:

- ▶ MP3.
- ▶ WMA.
- ▶ WAV (PCM).
- ▶ AAC, M4A.
- ▶ Playback lists: M3U, WPL, PLS.

File system

Standard file systems for USB devices are supported. The FAT 32 format is recommended.

Connecting



The USB audio interface is in the center console.

Connection of Apple iPod/iPhone via USB audio interface

Connect using a flexible adapter cable.

Connect the Apple iPod/iPhone to the USB interface.

The Apple iPod/iPhone menu structure is supported by the USB audio interface.

Connection of a USB device via the USB audio interface

Connect using a flexible adapter cable to protect the USB audio interface and the USB device against physical damage.

Connect the USB device to the USB interface.

After connecting for the first time

Information on all music tracks, e.g. artist or type of music, as well as playback lists are transmitted into the vehicle. This may take some time, depending on the USB device and the number of tracks.

During transmission, the tracks can be called up via the file directory.



Number of tracks

Information from up to four USB devices or for approx. 36,000 tracks can be stored in the vehicle. If a fifth device is connected or if more than 36,000 tracks are stored, information on existing tracks may be deleted.

Copy protection

Music tracks with integrated Digital Rights Management (DRM) cannot be played.

Playback

1. "CD/Multimedia"
2. "External devices"
3. Select the  or  symbol.



The playback starts with the first track.

The CD cover belonging to the track may appear on the Control Display after several seconds.



Track search

Selection is possible via:

- ▶ Playback lists.
- ▶ Information: type of music, artist, and, if available, composer, album, track.
- ▶ Additionally for USB devices: file directory, composer.

Tracks are displayed if they have been saved in the Latin alphabet.

Starting the track search

1. "CD/Multimedia"
2. "External devices"
3. Select the  or  symbol.
4.  "Search"
5. Select the desired category, e.g., "Genre" or "Artist".

All entries are displayed in a list.

- ▶ Open "A-Z search" and input the desired entry. When a letter is entered, the results are filtered using this letter as the first letter. If multiple letters are entered, all results that contain that sequence are displayed.
- ▶ Select the desired entry from the list.

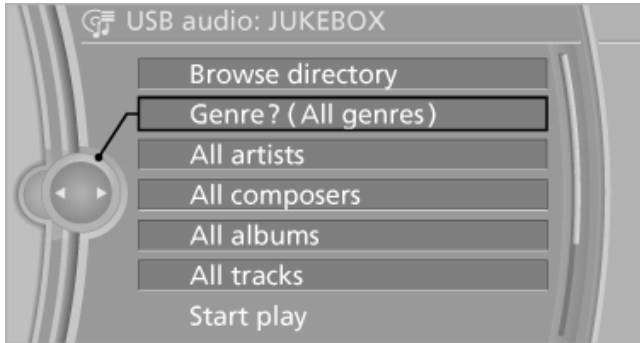



6. Select other categories if you wish. Not all categories need to be selected. For example, if all of the tracks by a certain artist are to be displayed, call up that artist only. All of the tracks by that artist are then displayed.
7. "Start play"

Restarting a track search

"New search"



Playback lists

Calling up playback lists.

1. "CD/Multimedia"
2. "External devices"
3. Select the  or  symbol.
4.  "Playlists"

Current playback

List of tracks currently being played.

1. "CD/Multimedia"
2. "External devices"
3. Select the  or  symbol.
4.  "Current playback"

Random playback

The current list of tracks is played back in random order.

1. "CD/Multimedia"
2. "External devices"
3. Open "Options".
4. "Random"

Fast forward/reverse



Press and hold the button.

Notes

Do not expose the audio device to extreme environmental conditions, such as very high temperatures; refer to the audio device operating instructions.

Depending on the configuration of the audio files, e.g., bit rates greater than 256 kbit/s, the files may not play back correctly in each case.

Information on connection

- ▶ The connected audio device is supplied with a max. power of 500 mA if supported by the device. Therefore, do not additionally connect the device to a socket in the vehicle; otherwise, playback may be compromised.
- ▶ Do not use force when plugging the connector into the USB interface.
- ▶ Do not connect devices such as fans or lamps to the USB audio interface.
- ▶ Do not connect USB hard drives.
- ▶ Do not use the USB audio interface to recharge external devices.

Bluetooth audio

At a glance

- ▶ Music files on external devices such as audio devices or mobile phones can be played back via Bluetooth.

Use of a mobile phone as an audio source, refer to page 200.

- ▶ Bluetooth® is a registered trademark of Bluetooth® SIG, Inc.
- ▶ The sound is output on the vehicle loudspeakers.
- ▶ The volume of the sound output is dependent on the device. If necessary, adjust the volume on the device.
- ▶ Up to four external devices can be paired with the vehicle.

Requirements

- ▶ The device is suitable. Details can be found at www.bmwusa.com/bluetooth
- ▶ The device is ready for operation.
- ▶ The ignition is switched on.
- ▶ Bluetooth is activated on the vehicle, refer to page 199.
- ▶ Bluetooth is activated on the vehicle.
- ▶ Bluetooth presettings must be made on the device, such as for a connection without confirmation or visibility; refer to the device operating instructions.
- ▶ A number with at least four and a maximum of 16 digits is defined as the Bluetooth passkey. It is only required once for pairing.

Pairing and connecting



Pairing a device

To avoid becoming distracted and posing an unnecessary hazard both to your own vehicle's occupants and to other road users, only pair the device while the vehicle is stationary. ◀

1. "CD/Multimedia"
2. "Bluetooth® (audio)"
3. If necessary, "Bluetooth® audio"
4. "Add new phone"

The Bluetooth name of the vehicle is displayed.



5. Perform additional steps on the device, refer to the device operating instructions: for instance, search for or connect the Bluetooth device or a new device.

The Bluetooth name of the vehicle appears on the device display.

6. Select the Bluetooth name of the vehicle on the device display.

You are prompted by the iDrive or device to enter the same Bluetooth passkey.

7. Enter the passkey and confirm.

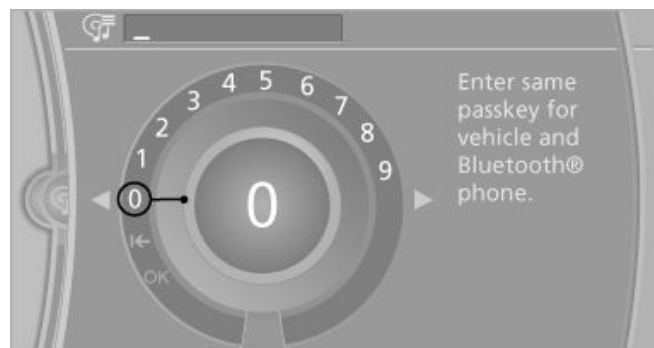

8. Select the desired functions with which the device is to be connected, for instance "Audio".
9. "OK"

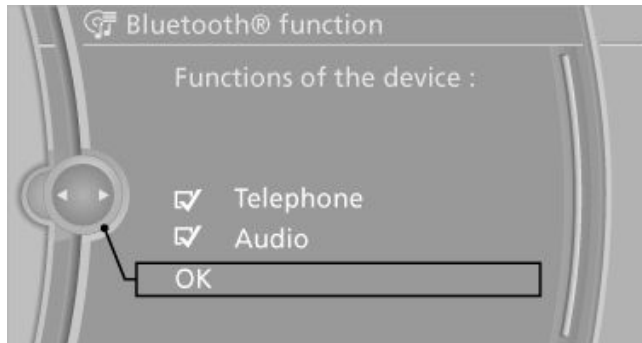

If pairing was successful, the device is displayed as connected.

White symbol  : the device is active as an audio source.

If pairing was unsuccessful: What to do if..., refer to page [192](#).

Connecting a specific device

A device that has already been paired can be connected as an active audio source.

Connecting is not possible when data is exchanged via a mobile phone connected via Bluetooth.

Requirements

If necessary, activate the audio connection of the desired device from the list of paired devices.

1. "CD/Multimedia"
2. "Bluetooth® (audio)"
3. If necessary, "Bluetooth® audio"
4. Select the desired device from the list of paired devices.
5. Open "Options".
6. "Configure phone"
7. Activate "Audio".
8. "OK"

Connecting the device

1. "CD/Multimedia"
2. "Bluetooth® (audio)"
3. If necessary, "Bluetooth® audio"
4. Select the desired device from the list of paired devices.



White symbol  : the device is active as an audio source.

Playback

General information

- ▶ The display of music track information depends on the device.
- ▶ Operation can take place on the device or iDrive.
- ▶ Playback is interrupted when data is exchanged via a mobile phone connected via Bluetooth.

Starting playback

1. Connect the device.
2. "CD/Multimedia"
3. "External devices"

4. Select the symbol.

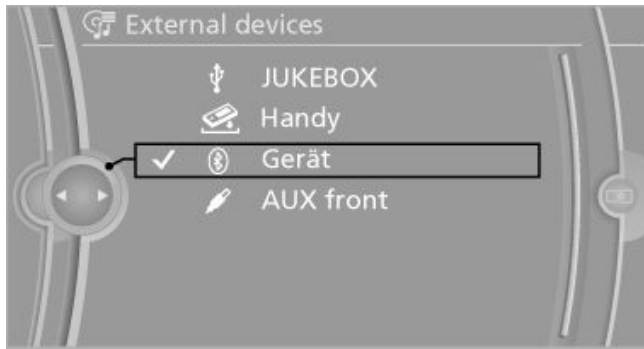

5. Select the desired track from the list, if necessary.

Playback menu

Depending on the particular device, some of the functions may not be available.

Symbol	Function
▶	Next track Fast forward: press and hold the symbol.
◀	Previous music track Reverse: press and hold the symbol.

Disconnecting the audio connection

1. "CD/Multimedia"
2. "Bluetooth® (audio)"
3. Highlight the desired device.
4. Open "Options".
5. "Configure phone"
6. "Audio"
7. "OK"

Unpairing a device

1. "CD/Multimedia"
2. "Bluetooth® (audio)"
3. If necessary, "Bluetooth® audio"
4. Highlight the device that is to be unpaired.

5. Open "Options".
6. "Remove phone from list"

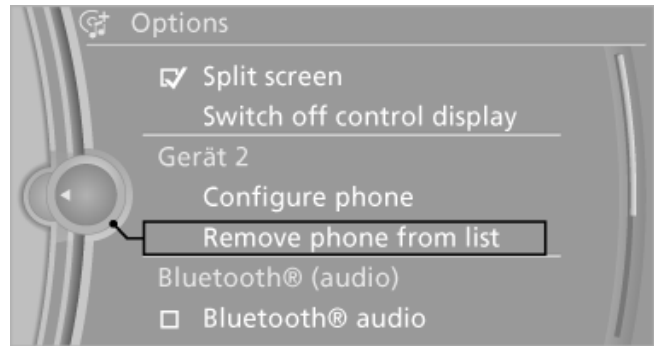

What to do if...

Information on suitable devices can be found at www.bmwusa.com/bluetooth

Suitable mobile phones, refer to page 198.

The device is not supported by the vehicle.

- ▶ Perform a software update, refer to page 193, if needed.

The device could not be paired or connected.

- ▶ Do the Bluetooth passkeys on the device and the vehicle match? Enter the same passkey on the device and via iDrive.
- ▶ Did it take longer than 30 seconds to enter the passkey? Repeat the pairing procedure.
- ▶ Are too many Bluetooth devices connected to the device or vehicle? Delete connections with other devices if necessary.
- ▶ Is the mobile phone in power-save mode or does it have only a limited remaining battery life? Charge the mobile phone in the snap-in adapter or via a charging cable.
- ▶ Depending on the mobile phone, it is possible that only one device can be connected to the vehicle. Unpair the connected device from the vehicle and pair and connect only one device.
- ▶ The device no longer reacts? Switch the device off and on again.
- ▶ Repeat the pairing procedure.

Music cannot be played back.

- ▶ Start the program for playing back music data on the device and select a track on the device if necessary.
- ▶ Switch the radio on and off again.

Music files can only be played back softly.

- ▶ Adjust the volume settings on the device.

Playback is disturbed when buttons are pressed or by other messages on the device.

- ▶ Switch off the button tones and other signal tones on the device.

Playback is interrupted by a telephone call or traffic bulletin and is not resumed automatically.

- ▶ Switch the radio on and off again.

Playback is not possible if the mobile phone is connected via Bluetooth Audio while it is also connected via the USB interface or the snap-in adapter.

- ▶ Disconnect one of the two connections; for example, disconnect the audio connection, refer to page 192. Start playback again.

If all points in this list have been checked and the required function is still not available, please contact the hotline or service center.

Software Update

The vehicle supports various external devices depending on the current software version. With a software update, the vehicle can support new mobile phones or new external device, for example.

- ▶ USB.
Software updates and related current information is available at www.bmw.com/update.

Displaying the current version

The currently installed software is displayed.

1. "Settings"
2. "Software update"

3. "Show current version"

Select desired version to display additional information.

Updating software via USB

The software may only be updated when the vehicle is stationary.

1. Store the file for the software-update in the main director of a USB flash drive.
2. Insert the USB flash drive into the USB audio interface in the center console. An update via the USB interface in the glove compartment is not possible.
3. "Settings"
4. "Software update"
5. "Update software"

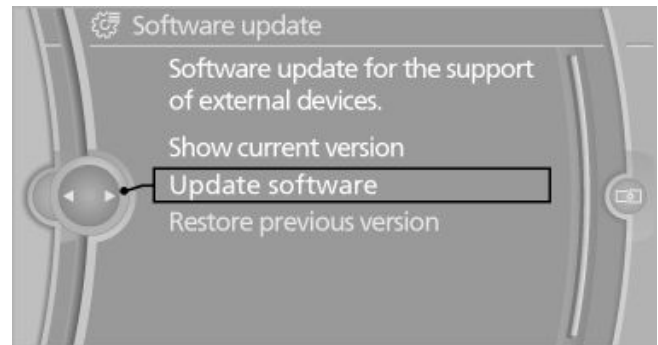

6. "Start update"
7. "OK"

All listed software updates are installed.

Restoring the previous version

The software version prior to the last software update can be restored.

The previous version can only be restored when the vehicle is stationary.

1. "Settings"
2. "Software update"
3. "Restore previous version"
4. "OK" Double-click.

All listed software updates are removed.

Note

While the software is being updated or a previous version is being restored, BMW Assist, Office functions, and the connected devices are temporarily unavailable. Wait several minutes for the functions to become available again.



Communication

All of the options available to you for mobile communication with family, friends, business partners, and service providers are described in this chapter.

Telephone

Vehicle equipment

This chapter describes all series equipment as well as country-specific and special equipment offered for this model series. Therefore, it also describes equipment that may not be found in your vehicle, for instance due to the selected special equipment or the country version. This also applies to safety-related functions and systems.

When using the features and systems described here, adhere to local regulations.

At a glance

The concept

Mobile phones or other external devices such as audio players can be connected to the vehicle via Bluetooth.

Bluetooth® is a registered trademark of Bluetooth® SIG, Inc.

After these devices are paired once, they are recognized automatically when the ignition is switched on as soon as they are in the vehicle and can then be operated via iDrive, the buttons on the steering wheel, and via voice activation.

Depending on their functionality, external devices can be used via the vehicle as a telephone or as an audio source. The telephone functions are described in the following. Operating the audio functions, refer to page 189.

Up to four external devices can be paired.

Certain functions may need to be enabled by the mobile phone provider or service provider.



Using the mobile phone while driving

Make entries only when traffic and road conditions allow. Do not hold the mobile phone in your hand while you are driving; use the hands-free system instead. If you do not ob-

serve this precaution, you can endanger the vehicle occupants and other road users. ◀

Snap-in adapter

The snap-in adapter is used to:

- ▶ Hold the mobile phone.
- ▶ Recharge the battery.
- ▶ Connect the mobile phone to an outside antenna of the vehicle.

This provides for better network reception and consistent sound quality.

Approved mobile phones

Details on which mobile phones and external devices with a Bluetooth interface are supported by the mobile phone preparation package can be obtained at www.bmwusa.com/bluetooth.

Displaying the vehicle identification number and software part number

The vehicle identification number and software part number are needed to determine which mobile phones are supported by the mobile phone preparation package. The software version of the mobile phone may also be required.

1. "Telephone"
2. Open "Options".
3. "Bluetooth® info"
4. "Display system information"

These approved mobile phones with a certain software version, support the vehicle functions described below.

Malfunions may occur with other mobile phones or software versions.

Do not operate a mobile phone that is connected to the vehicle on the mobile phone keypad, as this may lead to a malfunction.

A software update, refer to page 193, can be performed if necessary.

Notes

At high temperatures, the charging function of the mobile phone may be limited and functions may not be executed.

When using the mobile phone via the vehicle, note the operating instructions of the mobile phone.

Pairing/unpairing the mobile phone

General information

The following functions are available:

- ▷ Use of a mobile phone as a telephone.
- ▷ Use of a mobile phone as an additional telephone.
- ▷ Use of a mobile phone as an audio source.
- ▷ Use of an audio device as an audio source, refer to page 189.

Requirements

- ▷ The mobile phone is suitable, refer to page 198.
- ▷ The mobile phone is ready for operation.
- ▷ Bluetooth is activated in the vehicle and on the mobile phone.
- ▷ Bluetooth presettings may need to be made on the mobile phone, e.g., for a connection without confirmation or visibility, refer to the mobile phone operating instructions.
- ▷ Deactivate Bluetooth audio if necessary.
- ▷ A number with at least four and a maximum of 16 digits was defined as the Bluetooth passkey. It is only required once for pairing.
- ▷ The ignition is switched on.

Activating/deactivating Bluetooth

Bluetooth is not permitted everywhere.

1. "Telephone"
2. Open "Options".
3. "Bluetooth®"

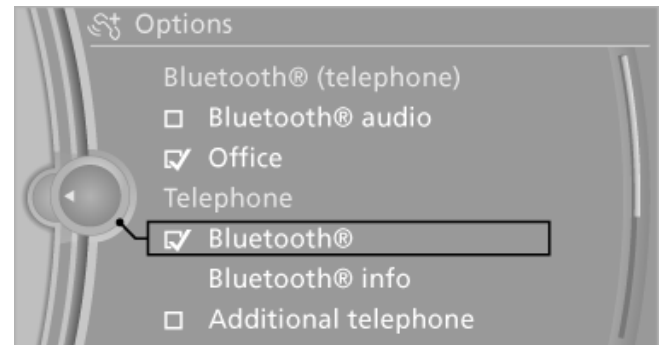

Additional functions

Activating/deactivating the additional functions

Activate the functions before pairing to be able to use them in the vehicle. Information on suitable mobile phones, refer to page 198, that support this function.

1. "Telephone"
2. "Bluetooth® (phone)"
3. Open "Options".
4. "Configure Bluetooth®"
5. Select the desired additional function.
 - ▷ "Additional telephone"
 - ▷ "Office"
 - ▷ "Bluetooth® audio"
6. "OK"

An additional function cannot be assigned to a telephone while it is deactivated.

Additional telephone

A mobile phone can be used as an additional telephone.

The additional telephone can be used to accept incoming calls, refer to page 202. While a call is active on the additional telephone, re-

ceived calls are displayed on the Control Display.

Audio source

A mobile phone can be used as an audio source.

Pairing and connecting a mobile phone



Pairing the mobile phone

To avoid becoming distracted and posing an unnecessary hazard both to your own vehicle's occupants and to other road users, only pair the mobile phone while the vehicle is stationary. ◀

1. "Telephone"
2. "Bluetooth® (phone)"
3. "Add new phone"

The Bluetooth name of the vehicle is displayed.

4. To perform additional steps on the mobile phone, refer to the mobile phone operating instructions: for instance, search for or connect the Bluetooth device or a new device.

The Bluetooth name of the vehicle appears on the mobile phone display.

5. Select the Bluetooth name of the vehicle on the mobile phone display.
6. You are prompted by the iDrive or mobile phone to enter the same Bluetooth passkey. Enter the passkey and confirm.

or

Compare the control number on the vehicle display with the control number on the mobile phone display. Confirm the control number on the mobile phone and in the vehicle.

"OK"



7. Select the functions for which the mobile phone is to be used.
8. "OK"

If the pairing was successful, the mobile phone appears at the top of the list of mobile phones.

The functions supported by the mobile phone and audio device are displayed as symbols when paired.

White symbol: the function is active.

Gray symbol: the function is inactive.

Symbol	Function
	Telephone.
	Additional telephone.
	Audio source.

Four mobile phones can be paired with the vehicle at once. Three mobile phones can be connected with the vehicle at once.

If pairing was unsuccessful: What to do if..., refer to page 201.

Following the initial pairing

- ▶ The mobile phone is detected/connected in the vehicle within a short period of time when the engine is running or the ignition is switched on.
- ▶ The phone book entries of the telephone stored on the SIM card or mobile phone are transmitted to the vehicle after detection, depending on the mobile phone.
- ▶ Four mobile phones can be paired.
- ▶ Specific settings may be necessary in some mobile phones, e.g., authorization or a secure connection; refer to the mobile phone operating instructions.

Connecting a particular mobile phone

1. "Telephone"
2. "Bluetooth® (phone)"
3. Select the mobile phone that is to be connected.

The functions assigned to the mobile phone before unpairing are assigned to the mobile

phone when it is reconnected. These functions are deactivated in a mobile phone that is already connected.

Configuring the mobile phone

Additional functions can be activated or deactivated for paired and connected mobile phones.

1. "Telephone"
2. "Bluetooth® (phone)"
3. Highlight the mobile phone to be configured.
4. Open "Options".
5. "Configure phone"
6. At least one function must be selected.
 - ▷ "Telephone"
 - ▷ "Additional telephone"
 - ▷ "Audio"
7. "OK"

If a function has already been assigned to another connected mobile phone, the function is deactivated in that mobile phone and the mobile phone is unpaired when the function is assigned to a new mobile phone.

Swapping the telephone and additional telephone

The function of the telephone and additional telephone can be swapped automatically.

1. "Telephone"
2. "Bluetooth® (phone)"
3. "Swap phone/addit. phone"

Unpairing the mobile phone

1. "Telephone"
2. "Bluetooth® (phone)"
3. Highlight the mobile phone that is to be unpaired.

4. Open "Options".
5. "Remove phone from list"

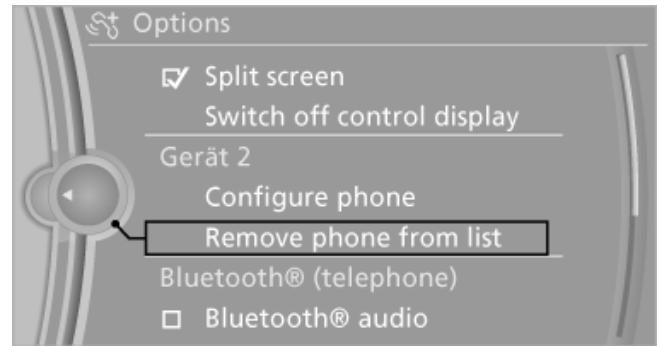

What to do if...

Information on suitable mobile phones, refer to page 198.

The mobile phone could not be paired or connected.

- ▷ Is Bluetooth activated in the vehicle and on the mobile phone? Activate Bluetooth in the vehicle and on the mobile phone.
- ▷ Do the Bluetooth passkeys on the mobile phone and the vehicle match? Enter the same passkey on the mobile phone and via iDrive.
- ▷ Did it take longer than 30 seconds to enter the passkey? Repeat the pairing procedure.
- ▷ Are too many Bluetooth devices connected to the mobile phone or vehicle? Delete connections with other devices if necessary.
- ▷ Is the audio connection activated? Deactivate the audio connection.
- ▷ Is the mobile phone in power-save mode or does it have only a limited remaining battery life? Charge the mobile phone in the snap-in adapter or via the charging cable.
- ▷ Depending on the mobile phone, it is possible that only one mobile phone can be connected to the vehicle. Unpair the connected mobile phone from the vehicle and pair and connect only one mobile phone.

The mobile phone no longer reacts.

- ▶ Switch the mobile phone off and on again.
- ▶ Is the ambient temperature too high or low? Do not expose the mobile phone to extreme environmental conditions.

The telephone functions are not available.

- ▶ Is the mobile phone paired as an additional telephone and is the additional telephone function deactivated? Activate the function.
- ▶ Is an outgoing call not possible? Connect the mobile phone as a telephone.

No phone book entries or only some phone book entries are displayed, or they are incomplete.

- ▶ Transmission of the phone book entries is not yet complete.
- ▶ It is possible that only the phone book entries of the mobile phone or the SIM card are transmitted.
- ▶ It may not be possible to display phone book entries with special characters.
- ▶ The number of phone book entries to be stored is too high.
- ▶ Is the data volume of the contact too large, e. g., due to stored information such as notes? Reduce the data volume of the contact.
- ▶ Is the mobile phone connected as an audio source or additional telephone? The mobile phone must be connected as a telephone.

The phone connection quality is poor.

- ▶ The strength of the Bluetooth signal on the mobile phone can be adjusted, depending on the mobile phone.
- ▶ Insert the mobile phone into the snap-in adapter or place it in the area of the center console.
- ▶ Adjust the volume of the microphone and loudspeakers separately.

If all points in this list have been checked and the required function is still not available, contact Customer Relations or the service center.

Controls

Adjusting the volume

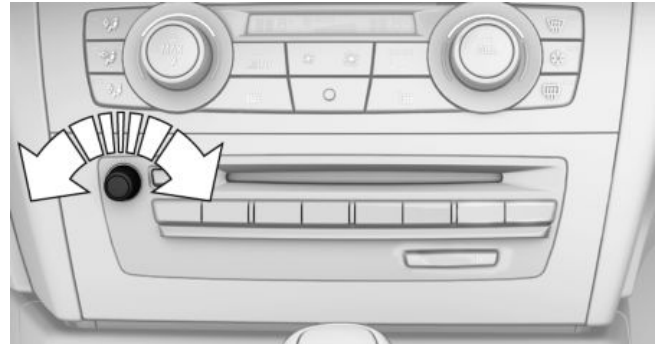

Turn the knob until the desired volume is selected. The setting is stored for the remote control currently in use.

The vehicle automatically adjusts the volume of the microphone on the telephone and the volume of the called party. Depending on the mobile phone, the volumes may need to be adjusted. The settings can only be created during a call and must be adjusted separately for each telephone. The settings are deleted when the telephone is unpaired.

1. "Settings"
2. "Tone"
3. "Volume settings"
4. Select the desired setting: "Microphone" or "Loudspeak."
5. To adjust: turn the controller.
6. To store: press the controller.

Incoming call

Receiving calls

If the number of the caller is stored in the phone book and is transmitted by the network, the name of the contact is displayed. Otherwise, only the phone number is displayed.

If more than one phone number is assigned to a contact, only the name of the contact is displayed.

For calls on the additional telephone, the number is only displayed if it is transmitted by the network.

An incoming call to one of the telephones is automatically rejected if there is an active call on the other telephone.

Accepting a call



Press the button on the steering wheel.

or

 "Accept"

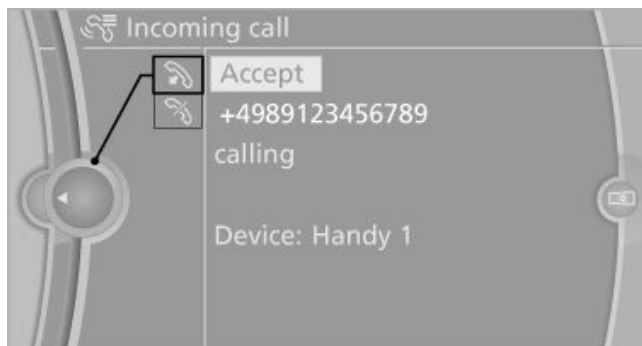

Rejecting a call

 "Reject"

Ending a call



Press the button on the steering wheel.

or

1. "Telephone"

2.  "End call"

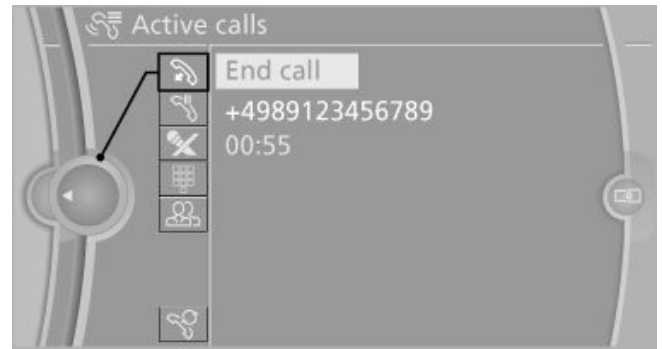

Entering a phone number

Dialing a number

1. "Telephone"
2. "Dial number"
3. Select the digits individually.
4.  Select the symbol.



The phone number can also be entered by voice.

Calls with multiple parties

General information

You can switch between calls or connect two calls to a single conference call. These functions must be supported by the mobile phone and service provider.

Accepting a call while speaking to another party

This function might have to be activated by the service provider and the mobile phone must be adjusted accordingly.

If a second call comes in during an ongoing call, a call waiting signal is sounded.

 "Accept"

The call is accepted and the existing call is put on hold.

Establishing a second call

Establish an additional call during an active call.

1. "Telephone"
2. "Active calls"
3.  "Hold"

The existing call is put on hold.

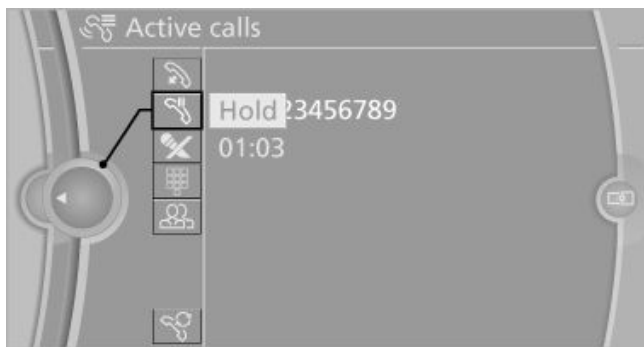

4. Dial the new phone number or select it from a list.

 "Return"

The call on hold is resumed.

Switching between two calls, hold call

The active call is displayed in color.

The call on hold is displayed in gray.

 "Swap calls"

The call on hold is resumed.

Establishing a conference call

Two calls can be connected to a single telephone conference call.

1. Establish two calls.
2.  "Conference call"

When terminating a conference call, both calls are ended. If one call is terminated by another party, the other call can be continued.

Switching the microphone to mute

When a call is active, the microphone can be muted.

1. "Telephone"
2. "Active calls"
3.  "Microphone mute"

A microphone that has been switched to mute is automatically reactivated:

- ▶ When a new connection is established.
- ▶ When switching between call parties.

DTMF suffix dialing

DTMF suffix dialing can be used for gaining access to network services or for controlling devices, e.g., to make a remote inquiry of an answering machine. The DTMF code is needed for this purpose.

1. "Telephone"
2. Select the contact from a list or "Dial number".
3.  "Keypad dialing"
4. Enter the DTMF code via iDrive.

Phone book

Displays

The phone book accesses the contacts and shows all contacts for which a phone number has been stored. The entries can be selected to make a call.

1. "Telephone"
2. "Phone book"

A symbol indicates the storage location of the contacts.

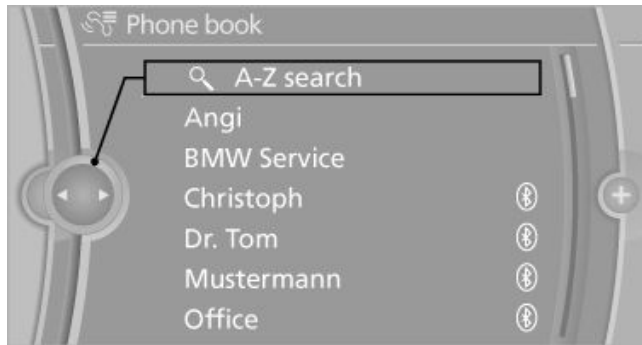

Calling a contact

Symbol	Meaning
	Contact with one stored phone number.
	Contact with more than one stored phone number.
	Call not possible; mobile phone without reception or network, or Service Request is active.

For contacts with one stored phone number: select the required contact. The connection is being established.

For contacts with more than one stored phone number: select the required contact and the phone number. The connection is being established.

Editing a contact

Changing the entries in "Contacts". When a contact is changed, the changes are not stored on the mobile phone. A copy of the entry is stored in the vehicle.

1. Highlight the contact.
2. Open "Options".
3. "Edit entry"

The contact can be edited.

Redialing

General information

The list of dialed numbers in the mobile phone is transmitted to the vehicle depending on the mobile phone. Possibly only those numbers are displayed that were dialed from the vehicle.

The 20 phone numbers dialed last are displayed. The sorting order of the phone numbers depends on the particular mobile phone.

Dialing a number via the instrument cluster

This is possible if a call is not currently active.

1. Press the button on the steering wheel.
2. Select the desired phone number.
The connection is established.

Dialing the number via the iDrive

1. "Telephone"
2. "Redial"

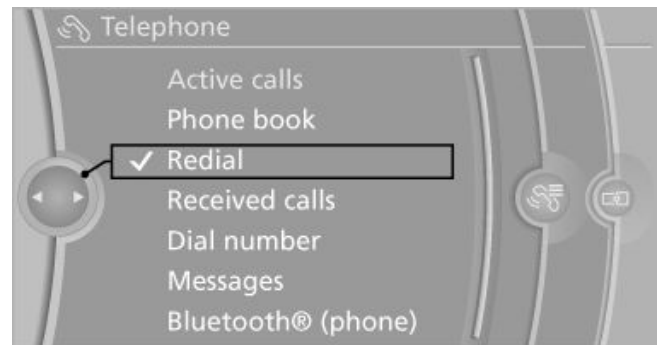

3. Select the desired entry and the phone number if necessary.

The connection is established.

Deleting a single entry or all entries

The deletion of entries depends on your particular mobile phone.

1. Highlight the entry.
2. Open "Options".
3. "Delete entry" or "Delete list"

Saving an entry in the contacts

1. Highlight the entry.
2. Open "Options".
3. "Store as new contact" or "Add to existing contact"
4. Select the contact if necessary.
5. Select the type of number: "Home", "Business", "Mobile" or "Other"
6. Complete the entries if necessary.
7. "Store contact"

Received calls

Displaying calls

The 20 calls that were last received are displayed.

1. "Telephone"
2. "Received calls"

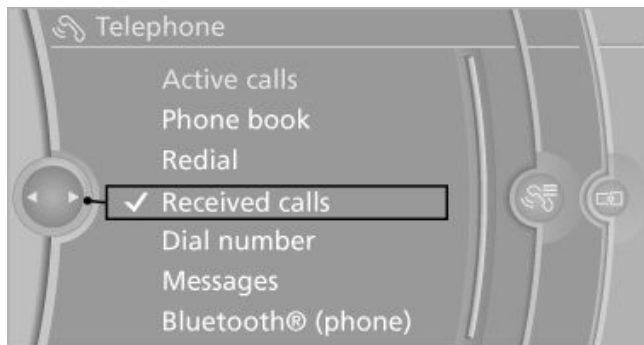

Calling a number from the list

Selecting an entry.

The connection is established.

Deleting a single entry or all entries

The deletion of entries depends on your particular mobile phone.

1. Highlight the entry.
2. Open "Options".
3. "Delete entry" or "Delete list"

Saving an entry in the contacts

1. Highlight the entry.
2. Open "Options".
3. "Store as new contact" or "Add to existing contact"
4. Select the contact if necessary.
5. Select the type of number: "Home", "Business", "Mobile" or "Other"
6. Complete the entries if necessary.
7. "Store contact"

Hands-free system

General information

Calls that are being made on the hands-free system can be continued on the mobile phone and vice versa.

From the mobile phone to the hands-free system

Calls that were begun outside of the Bluetooth range of the vehicle can be continued on the hands-free system with the ignition switched on.

Depending on the mobile phone, the system automatically switches to the hands-free system.

If the system does not switch over automatically, follow the instructions on the mobile phone display; refer also to the mobile phone operating instructions.

From the hands-free system to the mobile phone

Calls that are made on the hands-free system can in some cases be continued on the mobile phone; this depends on the mobile phone.

Follow the instructions on the mobile phone display; refer also to the mobile phone operating instructions.

Snap-in adapter

General information

More information on compatible snap-in adapters that support the functions of the mobile phone is available at the service center.

Notes

At high temperatures, the charging function of the mobile phone may be limited and functions may not be executed.

When using the mobile phone via the vehicle, note the operating instructions of the mobile phone.

Installation position

In the center armrest.

Inserting/removing the snap-in adapter

1. Press button 1 and remove the cover.

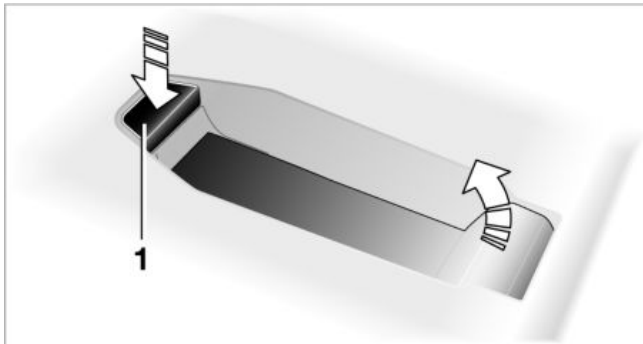

2. Insert the snap-in adapter at the front, arrow 1, and press down, arrow 2, until it engages.

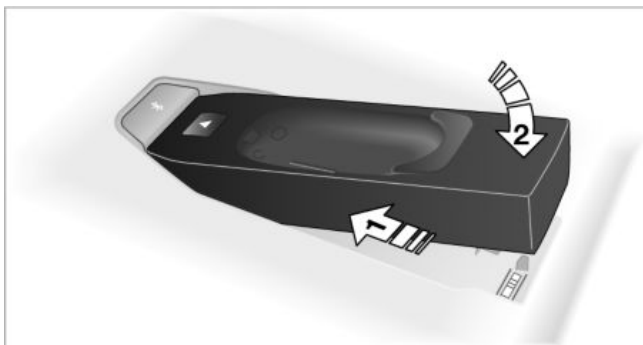

3. To remove the snap-in adapter: press button 1.

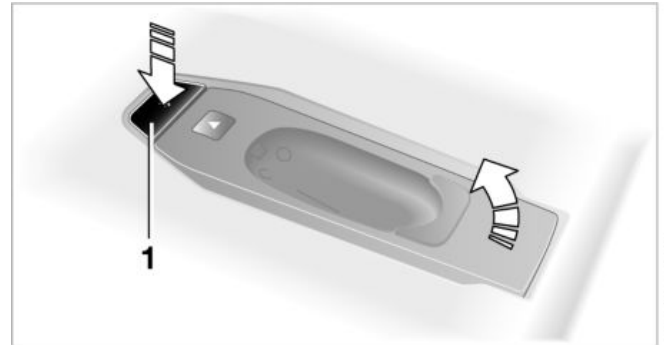

Inserting the mobile phone

1. Depending on the mobile phone, remove the protective cap from the antenna connector and from the USB connection of the mobile phone.
2. With the buttons facing up, slide the mobile phone up toward the electrical contacts and press it down until it engages.

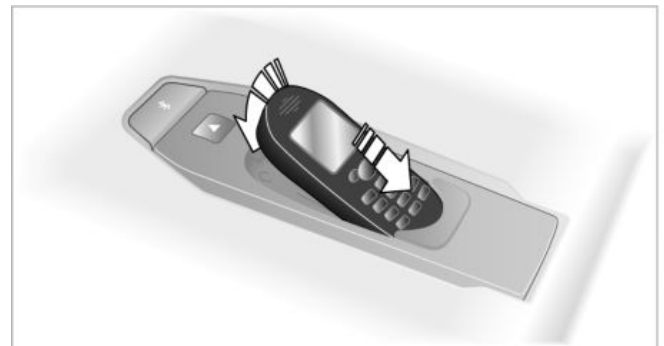

The battery is charged beginning with the radio ready state of the vehicle.

Removing the mobile phone

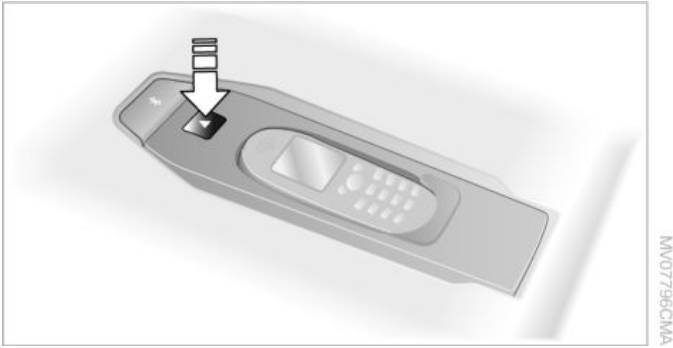

Press the button and remove the mobile phone.

Office

Vehicle equipment

This chapter describes all series equipment as well as country-specific and special equipment offered for this model series. Therefore, it also describes equipment that may not be found in your vehicle, for instance due to the selected special equipment or the country version. This also applies to safety-related functions and systems.

When using the features and systems described here, adhere to local regulations.

At a glance

General information

Contacts, appointments, tasks, notes, text messages, and e-mails from the mobile phone can be displayed on the Control Display if the mobile phone provides compatible support of these functions and the necessary Bluetooth standards.

Information about which mobile phones support Office functions can be found at www.bmwusa.com/bluetooth. A limited number of compatible mobile phones is available for Office.

Contents are only displayed in full length when the vehicle is stationary.

The mobile phone has read-access only.



Do not use Office while driving

To avoid becoming distracted and posing an unnecessary hazard to your vehicle's occupants and to other road users, never attempt to use the controls or enter information unless traffic and road conditions allow this. ◀

Requirements

- ▶ A suitable mobile phone is paired with the vehicle and connected. In some mobile

phones, data access must be confirmed on the mobile phone.

- ▶ The time, time zone, and date, refer to page 77, are correctly set on the Control Display and on the mobile phone, for instance to correctly display appointments.
- ▶ Office is activated, refer to page 199.

Updating

Data are updated every time the mobile phone is connected to the vehicle. Appointment entries, tasks, notes and reminders can be updated separately.

1. "Office"
2. "Current office", "Calendar", "Tasks", "Notes" or "Reminders"
3. Open "Options".
4. "Update data"

Mobile phone data are transmitted again to the vehicle.

Office information

The number of unread messages and active tasks as well as the upcoming appointments are displayed.

1. "Office"
2. "Current office"
3. Select the desired entry to display details.

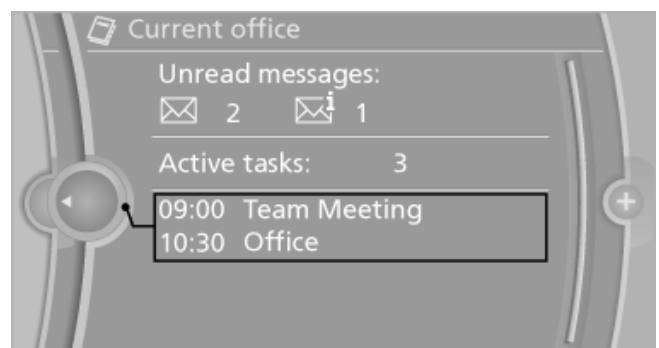

Contacts

Note

Equipment version with the mobile phone preparation package.

At a glance

Contacts can be created and edited. The contacts from the mobile phone are displayed as well if this function is supported by the mobile phone. The addresses can be adopted as destinations for navigation and the phone numbers can be dialed.

Displaying contacts

General information

1. "Office"
2. "Contacts"



All contacts are listed in alphabetical order. Depending on the number of contacts, an A-Z search is offered, refer to page 25.

A symbol indicates the storage location of the contacts.

Symbol	Storage location
No symbol	In the vehicle; the address has not been checked as a destination.
	In the vehicle; the address has been checked as a destination.
	Mobile phone.

Dialing phone numbers

1. Select the desired contact.
2. Select the phone number.
The connection is established.

Editing a contact

1. Select the desired contact.
2. "Edit contact"

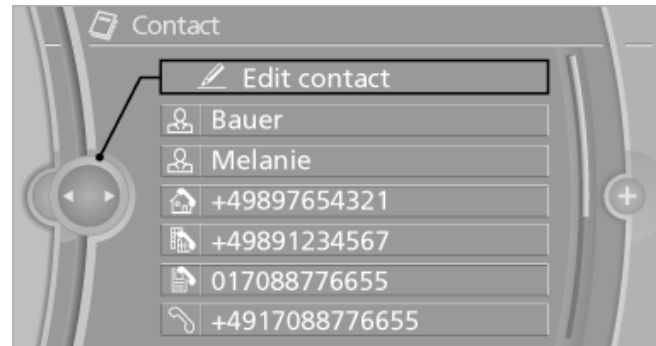

3. Change the entries.
4. "Store contact in vehicle"

When a contact is edited, the changes are not stored on the mobile phone. A copy of the entry is stored in the vehicle.

Selecting the contact as a navigation destination

1. Select the desired contact.
2. Select the address.

When contacts from the mobile phone are used, the address may need to be matched to the navigation data contained in the vehicle. In this case:

Correct the address.

3. "Start guidance" or "Add as another destination"

Checking the address as a destination

An address that is to be used for destination guidance must match the navigation data con-

tained in the vehicle. The address can be checked for this purpose.

1. Select the desired contact and highlight the address.
2. Open "Options".
3. "Check as destination"
4. Correct and store the address if necessary.

If the address is corrected and stored, a copy of it is stored in the vehicle. The address is not changed on the mobile phone.

New contact

General information

A contact can have up to 8 phone numbers, 2 addresses, 3 e-mail addresses and one Internet address.

1. "Office"
2. "Contacts"
3. Open "Options".
4. "New contact"

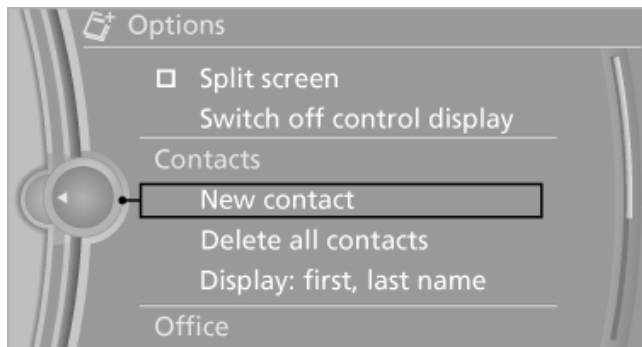







5. The entry fields are still filled with the previous entries: "Delete input fields"
6. Fill in the entry fields: select the symbol next to the entry field.
7. Enter the text and assign the contact type.
8. If the vehicle is equipped with a navigation system: enter the address. Only addresses contained in the navigation data in the vehicle can be entered. This ensures that destination guidance is possible for all addresses.

If necessary, "Accept address"

9. "Store contact in vehicle"

Contact types

Various contact types can be assigned to phone numbers and addresses.

Symbol	Meaning
	Home phone number.
	Business phone number.
	Mobile phone number.
	Other phone number.
	Home address.
	Business address.

Specifying the home address

A home address can be stored. It appears at the top of the contact list.

1. "Office"
2. "Contacts"
3. "Home"
4. Create a contact.
5. "Store contact in vehicle"

Selecting the sorting order of the names

Names can be displayed in a different order.

1. "Office"
2. "Contacts"
3. Open "Options".
4. "Display: last, first name" or "Display: first, last name"

Depending on how the contacts were stored on the mobile phone, the sorting order of the names may differ from the selected sorting order.

Show contact pictures

Pictures stored with the contacts are stored in the vehicle when the mobile phone is connected to the vehicle. The number of transmitted pictures depends on the mobile phone. The mobile phone must support this function.

1. "Office"
2. "Contacts"
3. Open "Options".
4. "Configure Bluetooth®"
5. "Show images"

Display of all contact pictures is activated or deactivated.

Deleting contacts

Only contacts that are stored in the vehicle are deleted. The contacts on the mobile phone cannot be deleted.

1. "Office"
2. "Contacts"
3. Highlight the contact.
4. Open "Options".
5. "Delete contact" or "Delete all contacts"
6. If necessary. "Yes"

Messages





General information

Whether or not text messages and e-mails from the mobile phone are displayed depends on whether transmission from the mobile phone to the vehicle is supported. Text messages and e-mails may not be supported by the service provider, or the function may need to be enabled separately. After the mobile phone is first paired, transmission may take several minutes. Messages are only displayed in full length when the vehicle is stationary. Messages from the additional telephone are not transmitted.

Displaying messages

1. "Office"
2. "Messages"

A symbol identifies the type of message.

Symbol	Message type
	Text messages.
	My Info
	Message from the Concierge service.
	E-mail from mobile phone.

Filtering the message list

The message list can be filtered if more than one type of message exists.

1. "Filter:"



2. Select the type of message.
 - ▷ "All"

All messages are displayed.
 - ▷ "E-mail"

Only e-mails from the mobile phone are displayed.
 - ▷ "Service message"

Only messages from the BMW Assist Concierge service and My Info are displayed.
 - ▷ "Text message"

Only text messages from the mobile phone are displayed.

Deleting messages

Messages from the Concierge service and My Info can be deleted.

Delete a message:

1. "Office"
2. "Messages"
3. Select the desired message.
4. Open "Options".
5. "Delete message"

Delete all messages:

1. "Office"
2. "Messages"
3. Open "Options".
4. "Delete all messages" or "Delete service messages"

Text messages

Calling the sender of a text message

1. Select the desired message.
2.  Select the symbol.

Saving the sender in the contacts

1. Highlight the desired message.
2. Open "Options".
3. "Store as new contact" or "Add to existing contact"

Using contact data

Contact data from appointments, tasks, text messages, e-mails, and notes can be saved or selected, refer to page [216](#).



Reading the text message out loud

Read the text message out loud, refer to page [216](#).

My Info

Selecting additional functions

Additional functions are available when a message is selected.

Sym- bol	Function
	"Start guidance" or "Add as another destination"
	"Call" If the message contains a number, the connection is established.
	"Select phone number" If the message contains more than one number, select the desired number from the list. The connection is established.



Message from the Concierge service



Storing an address

1. Select the desired message.
2. Open "Options".
3. "Store contact in vehicle"

Selecting additional functions

Additional functions are available when a message is selected:

Sym- bol	Function
	"Start guidance" or "Add as another destination"
	"Call" If the message contains a number, the connection is established.

Sym- bol	Function
	"Select phone number" If the message contains more than one number, select the desired number from the list. The connection is established.
	"Further information" Display additional information.

E-mail

Displaying e-mails

1. "Office"
2. "Messages"
3. Select the desired e-mail.

Displaying e-mail contacts

If the sender and recipient of an e-mail are transmitted by the mobile phone, this information is displayed in the e-mail.

"Sender/Recipient"

If the e-mail addresses are stored in the contacts, the contact is displayed. Select the contact to display details.

If the e-mail addresses are not stored in the contacts, only the e-mail address is displayed.

Using contact data

Contact data from appointments, tasks, text messages, e-mails, and notes can be saved or selected, refer to page 216.

Deactivating the full display

When an e-mail is opened in the vehicle, the e-mail is fully transmitted to the vehicle. This may result in charges.

1. "Office"
2. "Messages"

3. Open "Options".
4. "Fully download e-mails"

Only a part of the e-mail from the mobile phone is loaded into the vehicle.

Reading the e-mail out loud

Read the e-mail out loud, refer to page 216.

Calendar

Display the calendar

Appointments during the last 20 days and the next 50 days can be displayed.

1. "Office"
2. "Calendar"

The appointments on the current day are displayed.

Selecting the calendar day

1. Select the date.

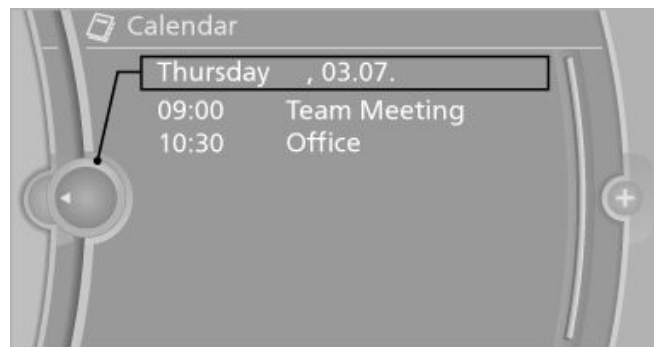

2. Select the desired day or date.
 - ▷ "Next day"
 - ▷ "Date:"
 - ▷ "Previous day"
 - ▷ "Today"

Display the appointment

1. Select the desired appointment.
2. Scroll through the appointment if necessary:
 - ▷ Turn the controller.

- ▷   Select the symbol.

Using contact data

Contact data from appointments, tasks, text messages, e-mails, and notes can be saved or selected, refer to page 216.

Reading the appointment out loud

Read the appointment out loud, refer to page 216.

Tasks

Displaying the task list

Display tasks that are due within the next 90 days.

1. "Office"
2. "Tasks"

Sorting the task list

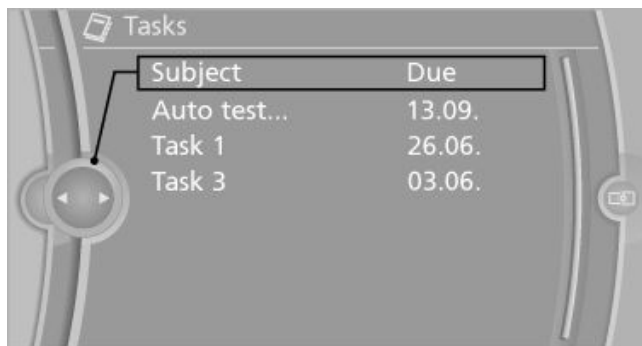

1. Select the header in the task list.



2. Select the sorting criterion:

- ▷ "Priority (!)"
- ▷ "Subject"
- ▷ "Due date"

Displaying the task

1. Select the desired task.
2. Scroll in the task if necessary:
 - ▷ Turn the controller.
 - ▷   Select the symbol.

Using contact data

Contact data from appointments, tasks, text messages, e-mails, and notes can be saved or selected, refer to page 216.

Reading the task out loud

Read the task out loud, refer to page 216.

Notes



Displaying notes

1. "Office"
2. "Notes"
 - All notes are displayed.

Displaying the note

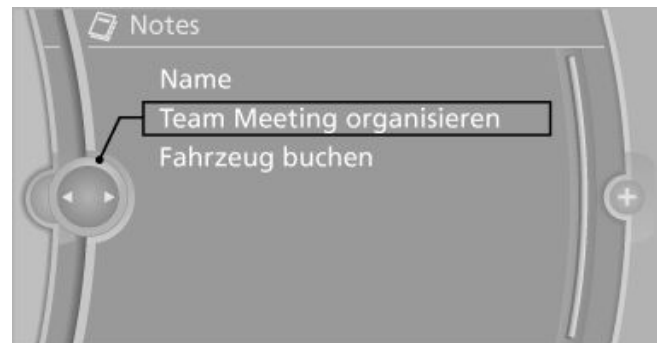
1. Select the desired note.



2. Scroll in the note if necessary:
 - ▷ Turn the controller.
 - ▷   Select the symbol.

Using contact data

Contact data from appointments, tasks, text messages, e-mails, and notes can be saved or selected, refer to page 216.

Reading the note out loud

Read the note out loud, refer to page 216.

Reminders

Displaying reminders

Reminders of pending appointments and tasks are displayed. After an appointment or after a task is due, the reminder is no longer displayed.

1. "Office"
2. "Reminders"
3. Select the desired reminder.

The corresponding appointment or the task are displayed.

Using contact data

At a glance

Contact data from appointments, tasks, text messages, emails, and notes can be stored or selected.

Displaying contact or selecting phone number

1.  "Use contact data"
2. Display the contact or select the phone number:
 - ▶ Select the contact to display contact details.
 - ▶ Select the phone number to establish a connection directly.

Storing contact data





1.  "Use contact data"
2. Highlight the phone number or e-mail address.
3. Open "Options".
4. "Add to existing contact" or "Store as new contact"

Reading out loud

Text messages, e-mails, appointment entries, tasks, and notes can be read out loud.

1. Select the desired message, appointment, task, or note.
2.  Select the symbol.

The following options are available during reading:

- ▶  "Pause"
Interrupt reading. Select again to restart reading.
- ▶  "Back to beginning"
Start reading the message again from the beginning.
- ▶  Select the symbol.
Go back one paragraph.
- ▶  Select the symbol.
Skip a paragraph.
- ▶ To end reading, turn the controller to the left.

What to do if...

Information on suitable mobile phones, refer to page 198.

Appointments, tasks, notes, text messages, or e-mails from the mobile phone are not displayed.

- ▶ The mobile phone is not capable of the missing function or is not connected correctly.
- ▶ The Office function is deactivated.
- ▶ The mobile phone is connected as an additional phone.
- ▶ Appointments are older than 20 days or are more than 50 days in the future.
- ▶ The tasks have been marked as completed or have a due date that lies more than 90 days in the future.

- ▷ Depending on the number of stored appointments, task notes, and messages in the mobile phone, not all are displayed in the vehicle.

Not all appointments and tasks from the mobile phone are displayed at the right time?

- ▷ The time zone, time, or date is incorrectly set on the Control Display and mobile phone.

The e-mail attachment is not displayed.

- ▷ E-mails are transmitted without an attachment.

Entries are not displayed in full length.

- ▷ Text were already transmitted from the mobile phone in a shortened form.
- ▷ Synchronization between the mobile phone and vehicle may take several minutes.

The contact pictures are not being displayed?

- ▷ Up to 200 contact pictures can be stored in the vehicle.

The E-mail is displayed with a delay?

- ▷ Check the e-mail settings on the telephone and adjust if necessary.

If all points in this list have been checked and the required function is still not available, please contact the hotline or service center.

Contacts

Vehicle equipment

This chapter describes all series equipment as well as country-specific and special equipment offered for this model series. Therefore, it also describes equipment that may not be found in your vehicle, for instance due to the selected special equipment or the country version. This also applies to safety-related functions and systems.

When using the features and systems described here, adhere to local regulations.

Note

Equipment version without the mobile phone preparation package.

General information

Contacts can be created and edited. The contacts from the mobile phone are displayed as well if this function is supported by the mobile phone. The addresses can be adopted as destinations for navigation and the phone numbers can be dialed.

New contact

1. "Contacts"
2. "New contact"



3. The entry fields are still filled with the previous entries: "Delete input fields"
4. Fill in the entry fields: select the symbol next to the entry field.



5. Enter the text, refer to page 25.
In vehicles equipped with a navigation system: it is only possible to enter addresses that are contained in the vehicle navigation data. This ensures that destination guidance is possible for all addresses.
6. If necessary, "Store"
7. "Store contact in vehicle"

Specifying the home address

A home address can be stored. It appears at the top of the contact list.

1. "Home"
2. Create a contact.
3. "Store contact in vehicle"

My contacts

General information

List of all contacts stored in the vehicle.

Displaying contacts



1. "Contacts"

2. "My contacts"



All contacts are listed in alphabetical order. Depending on the number of contacts, an A-Z search is offered, refer to page 25.

A symbol indicates the storage location of the contacts:

Symbol	Storage location
No symbol	In the vehicle; the address has not been checked as a destination.
	In the vehicle; the address has been checked as a destination.
	Mobile phone.

Dialing a phone number

1. Select the desired contact.
2. Select the phone number.
The connection is established.

Editing a contact

1. Select the desired contact.
2. "Edit contact"



3. Change the entries.

4. Move the controller to the left.
5. "Yes"

If a contact from the mobile phone is edited, the changes are not stored on the mobile phone. A copy of the entry is stored in the vehicle, and only this copy is displayed. Under certain circumstances, a contact entry with the same name is created.

Selecting the contact as a navigation destination

1. Select the desired contact.
2. Select the address.

When contacts from the mobile phone are used, the address may need to be matched to the navigation data contained in the vehicle. In this case:

Correct the address.

3. "Start guidance" or "Add as another destination"

Checking the address as a destination

An address that is to be used for destination guidance must match the navigation data contained in the vehicle. The address can be checked for this purpose.

1. Select the desired contact and highlight the address.
2. Open "Options".
3. "Check as destination"
4. Correct and store the address if necessary.

If the address is corrected and stored, a copy of it is stored in the vehicle. The address is not changed on the mobile phone.

Selecting the sorting order of the names

Names can be displayed in a different order.

1. "My contacts"
2. Open "Options".

3. "Display: last, first name" or "Display: first, last name"

Depending on how the contacts were stored on the mobile phone, the sorting order of the names may differ from the selected sorting order.

Deleting contacts

Only contacts that are stored in the vehicle are deleted. The contacts on the mobile phone cannot be deleted.

1. "My contacts"
2. Highlight the contact.
3. Open "Options".
4. "Delete contact" or "Delete all contacts"

ConnectedDrive

Vehicle equipment

This chapter describes all series equipment as well as country-specific and special equipment offered for this model series. Therefore, it also describes equipment that may not be found in your vehicle, for instance due to the selected special equipment or the country version. This also applies to safety-related functions and systems.

When using the features and systems described here, adhere to local regulations.

TeleService

General information

TeleService supports communication with your service center.

- ▶ Data on the vehicle's service requirements can be sent directly to the service center. In this way, the service center can plan its work in advance. This shortens the duration of the service appointment.
- ▶ In the event of a breakdown, data on the vehicle's condition can be sent directly to Roadside Assistance.
- ▶ The service varies by country.
- ▶ Connection costs may ensue.
- ▶ Services may be restricted abroad.

Requirements

Different variants of TeleService may be implemented in the vehicle. The following conditions must always be met:

- ▶ Wireless reception is available.
- ▶ The ignition is switched on.
- ▶ A current ConnectedDrive subscription or a vehicle equipped with intelligent Emergency Request.

Concierge service

General information

The Concierge service offers information on events, gas stations, and hotels, and provides phone numbers and addresses. Hotels can be booked directly using the Concierge service. The Concierge service is part of the optional Convenience Plan.

Starting the Concierge service

1. "BMW Assist" or "ConnectedDrive"
2. "Concierge"



3. "Start service"

A voice connection is established with the Concierge service. Phone numbers and addresses can be transmitted to the vehicle.

Messages

Information on messages, refer to page [212](#).

Roadside Assistance

At a glance

BMW Roadside Assistance can be contacted if assistance is needed in the event of a breakdown.

Roadside Assistance can also be contacted via a Check Control message, refer to page [82](#).

Starting Roadside Assistance without TeleService

1. "BMW Assist" or "ConnectedDrive"
2. "Roadside Assistance"

The Roadside Assistance number is displayed. If the mobile phone is paired, a connection is established to Roadside Assistance.



Starting Roadside Assistance with TeleService

General information

In vehicles equipped with TeleService, support is first offered by TeleService Diagnosis and then, if necessary, by TeleService Help.

1. "BMW Assist" or "ConnectedDrive"
2. "Roadside Assistance"
3. "Start service"

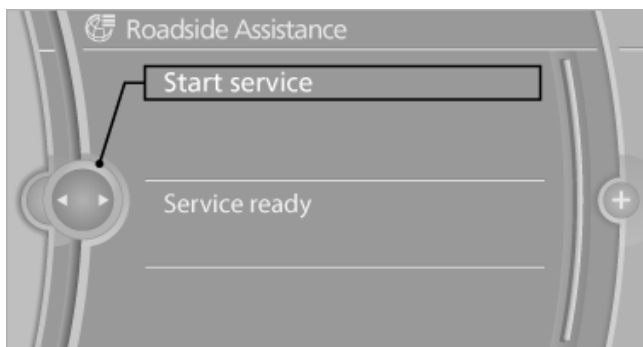

TeleService Diagnosis

TeleService Diagnosis enables the wireless transmission of detailed vehicle data that are important for vehicle diagnosis. These data are transmitted automatically.

After the data are transmitted, the voice connection to Roadside Assistance is re-established.

BMW Online

At a glance

A business search can be opened via BMW Online.

License conditions

This product contains NetFront Browser software of ACCESS Co., Ltd. Copyright © 2007 ACCESS Co., Ltd. All rights reserved.

NetFront is a trademark or registered trademark of ACCESS CO., LTD., in Japan and other countries.

This software is based in part on the work of the Independent JPEG Group.

Requirements

- ▶ Subscription to the optional Convenience Plan.
- ▶ The date setting on the Control Display is current.
- ▶ The vehicle is located within wireless network coverage.

Starting BMW Online

1. "BMW Assist" or "ConnectedDrive"
2. "BMW Online"

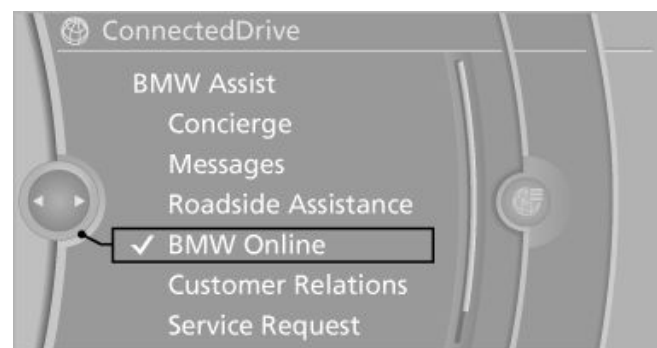

3. If necessary, "OK"

The BMW Online home page is displayed.

Operating BMW Online

To start a search:

- ▷ Turn the controller to highlight an element.
- ▷ Press the controller to display an element.

Opening the start page

1. Open "Options".
2. "Display start page"

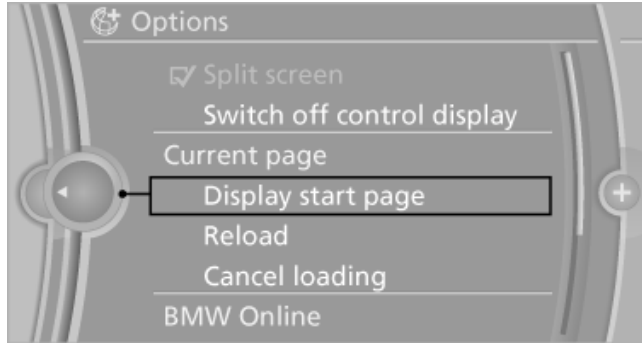

Loading a new page

1. Open "Options".
2. "Reload"

Cancel

1. Open "Options".
2. "Cancel loading"

Customer Relations

At a glance

Contact Customer Relations for information on all aspects of your vehicle.

Calling Customer Relations

Vehicle not equipped with TeleService

1. "BMW Assist" or "ConnectedDrive"
2. "Customer Relations"

The Customer Relations phone number is displayed. If the mobile phone is paired, a connection is established to Customer Relations.

Vehicle equipped with TeleService

1. "BMW Assist" or "ConnectedDrive"
2. "Customer Relations"
3. "Start service"

Service Request

At a glance

Sends information to your service partner to request the arrangement of a service appointment. The TeleService data is transmitted during a Service Request. If possible, your service partner will establish contact with you.

Starting a Service Request

1. "BMW Assist" or "ConnectedDrive"
2. "Service Request"
3. "Start service"



A Service Request can be started via a Check Control message, refer to page 82.

Automatic Service Request

The TeleService data necessary for servicing the vehicle are automatically sent to your service partner prior to the service deadline. If possible, the service partner will contact you and a service appointment can be arranged.

To check when your service partner was notified:

1. "Vehicle Info"
2. "Vehicle status"

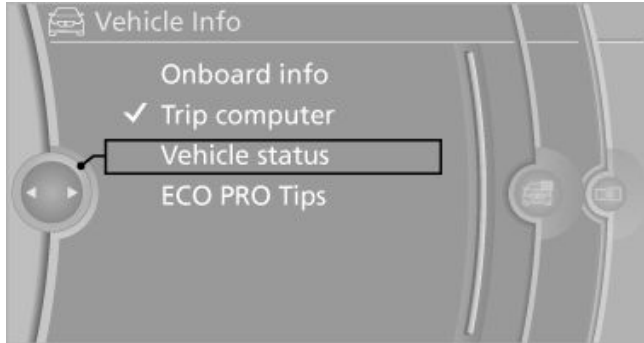

3. Open "Options".
4. "Last Service Request"

TeleService Report

Transmits technical data when needed from your vehicle to BMW at regular intervals; these are evaluated for the continued development of BMW products.

TeleService Report is activated in vehicles that meet certain technical conditions and that have a current ConnectedDrive subscription; it is free of charge.

Neither personal nor position data are transmitted.

To check when your service partner was notified:

1. "Vehicle Info"
2. "Vehicle status"
3. "Options"
4. "Last Teleservice Info"

Services status

Displaying available services

Display of all services available in the vehicle.

1. "BMW Assist" or "ConnectedDrive"
2. "Service Status"

3. "Available services"

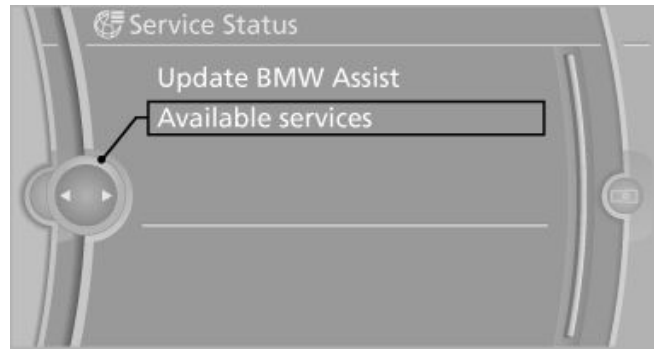

Updating BMW Assist

Manual update of TeleService.

1. "BMW Assist" or "ConnectedDrive"
2. "Service Status"
3. "Update BMW Assist"

Data transfer

During the updating of BMW services, display the status of the data transfer.

1. "BMW Assist" or "ConnectedDrive"
2. Open "Options".
3. "Data transfer"

Apps

At a glance

Certain software applications of a suitable mobile phone can be integrated in the vehicle.

These software applications are displayed on the Control Display.

They are operated via iDrive.

Requirements

- ▶ The mobile phone is suitable.
- ▶ The mobile phone operating system supports the software applications of Apps.
- ▶ Software applications are installed on the mobile phone and ready to use.

- ▶ Corresponding mobile wireless contract. Any additionally incurred costs are not a part of Apps.
- ▶ Use only BMW approved software applications; otherwise, it may result in malfunctions.

Information about suitable mobile phones, available software applications and their installation can be found at www.bmw.com/connected or at the service center.



Create the entries.

Make entries only when traffic and road conditions allow. Otherwise, the vehicle occupants and other road users may be put in danger because of the distraction from driving.

For reasons of safety, some software applications are usable only while the vehicle is stationary. ◀

Operating Apps

1. Connect the mobile phone via the snap-in adapter or via the USB audio interface.
2. "ConnectedDrive"
3. Select the desired software application.

Displaying status

Information about the currently available software applications can be displayed.

1. "ConnectedDrive"
2. "BMW apps"

Notes

- ▶ The ranges of Apps that can be displayed on the Control Display depend on the range of installed software applications on the mobile phone.
- ▶ The data transmission of the software applications from the mobile phone to the vehicle can last some time. Some software applications depend on the speed of the available Internet connection of the mobile phone.

- ▶ Some mobile phones cannot simultaneously use Apps and the Bluetooth hands-free system.

If necessary, restart the software application on the mobile phone after a phone conversation.

Remote Services

With Remote Services, a connection can be established between a mobile phone and the vehicle. This connection can be used, for example, to lock and unlock the vehicle.

Depending on the vehicle, additional functions may be available.

To be able to use the functions, the My BMW Remote app must be downloaded. Operation takes place via the app.

Alternatively, the functions can also be used via the ConnectedDrive Hotline.

The operating instructions for the My BMW Remote app can be found on the ConnectedDrive portal or at www.bmw.com.



Mobility

In order to always ensure your mobility, you will find important information on operating fluids, wheels and tires, maintenance and Roadside Assistance in the following.



Refueling

Vehicle equipment

This chapter describes all series equipment as well as country-specific and special equipment offered for this model series. Therefore, it also describes equipment that may not be found in your vehicle, for instance due to the selected special equipment or the country version. This also applies to safety-related functions and systems.

When using the features and systems described here, adhere to local regulations.

General information

 Refuel promptly
At the latest, refuel at a range below 30 miles/50 km; otherwise, the engine function is not ensured and damage may occur. ◀

Notes

 Switch off the engine before refueling
Always switch off the engine before refueling; otherwise, fuel cannot be added to the tank and a message will be displayed. ◀

 Observe when handling fuel

- ▶ Take all precautionary measures and observe all applicable regulations when handling fuel.
- ▶ Do not carry any spare fuel containers in your vehicle. They can develop a leak and cause an explosion or cause a fire in the event of an accident. ◀

Fuel cap

Opening

1. Briefly press the rear edge of the fuel filler flap.



2. Turn the fuel cap counterclockwise.
3. Place the fuel cap in the bracket attached to the fuel filler flap.



Closing

1. Fit the fuel cap and turn it clockwise until you clearly hear a click.
2. Close the fuel filler flap.

 Do not pinch the retaining strap
Do not pinch the retaining strap attached to the cap; otherwise, the cap cannot be closed properly and fuel vapors can escape. ◀

A message is displayed if the cap is loose or missing.

Manually unlocking fuel filler flap

In the event of a malfunction, the fuel filler flap can be released manually:

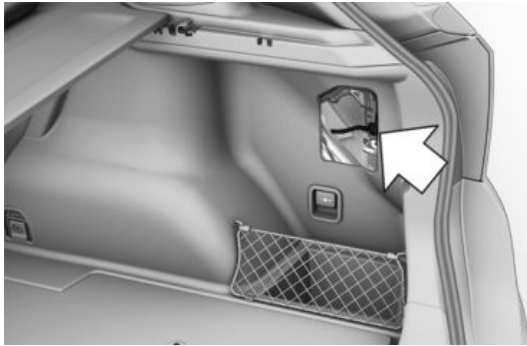

1. Press the cover out of the cargo area side panel at the rear and remove it.
2. Take the button with the fuel pump symbol out of the holder toward the front and pull. This releases the fuel filler flap.

Fuel tank capacity

Fuel tank capacity: approx. 16.6 US gal/
63 liters.

Observe the following when refueling

When refueling, insert the filler nozzle completely into the filler pipe. Lifting up the fuel pump nozzle during refueling causes:

- ▷ Premature pump shutoff.
- ▷ Reduced efficiency in the fuel-vapor recovery system.

The fuel tank is full when the filler nozzle clicks off the first time.



Do not overfill the fuel tank

Do not overfill the fuel tank; otherwise, escaping fuel may harm the environment or damage the vehicle. ◀



Handling fuels

Follow the safety instructions provided at gas stations; otherwise, there is a danger of personal injury and property damage. ◀

Fuel

Fuel recommendation

Vehicle equipment

This chapter describes all series equipment as well as country-specific and special equipment offered for this model series. Therefore, it also describes equipment that may not be found in your vehicle, for instance due to the selected special equipment or the country version. This also applies to safety-related functions and systems.

When using the features and systems described here, adhere to local regulations.

Gasoline

For the best fuel economy, the gasoline should be sulfur-free or very low in sulfur content.

Do not use fuels that are labeled at the fuel pump as containing metals.

 Only refuel with lead-free gasoline without metal additives

Do not refuel with leaded gasoline or gasoline with metal additives, e. g., manganese or iron; otherwise, the catalytic converter and other components will be permanently damaged. ◀

Fuels with a maximum ethanol content of 10 %, i.e., E10, may be used for refueling.

The ethanol should fulfill the following quality standards:

US: ASTM 4806–xx

CAN: CGSB-3.511–xx

xx: always adhere to the currently applicable standard.

 Do not refuel with ethanol E85

Do not refuel with E85, i.e., fuel with an ethanol content of 85 %, or with Flex Fuel, as this would damage the engine and fuel supply system. ◀

The engine is knock controlled. Therefore, you can refuel with different recommended fuel grades.

Recommended fuel grade

BMW recommends AKI 91.

Minimum fuel grade

BMW recommends AKI 89.



Minimum fuel grade

Do not fill up with fuel below the specified minimum quality; otherwise, the engine may not run properly. ◀

If you use gasoline with this minimum AKI rating, the engine may produce knocking sounds when starting at high outside temperatures. This has no effect on the engine life.



Minimum fuel grade

The use of poor-quality fuels may result in harmful engine deposits or damage. Additionally, problems relating to drivability, starting and stalling, especially under certain environmental conditions such as high ambient temperature and high altitude, may occur.

If drivability problems are encountered, we recommend switching to a high quality gasoline brand and a higher octane grade — AKI number — for a few tank fills. To avoid harmful engine deposits, it is highly recommended to purchase gasoline from BP or Top Tier retailers.

Failure to comply with these recommendations may result in the need for unscheduled maintenance. ◀

BMW recommends BP fuels 

Wheels and tires

Vehicle equipment

This chapter describes all series equipment as well as country-specific and special equipment offered for this model series. Therefore, it also describes equipment that may not be found in your vehicle, for instance due to the selected special equipment or the country version. This also applies to safety-related functions and systems.

When using the features and systems described here, adhere to local regulations.

Tire inflation pressure

Safety information

It is not merely the tires' service life, but also driving comfort and, to a great extent, driving safety that depend on the condition of the tires and the maintenance of the specified tire pressure.

Checking the pressure

Tires naturally lose pressure uniformly across all four tires.

Only check the tire inflation pressure when the tires are cold. This means after a maximum of 1.25 miles/2 km driving or when the vehicle has been parked for at least 2 hours. When the tires are warm, the tire inflation pressure is higher.



Check the tire inflation pressure regularly

Regularly check the tire inflation pressure and correct it as needed: at least twice a month and before a long trip. If you fail to observe this precaution, you may be driving on tires with incorrect tire pressures, a condition that may not only compromise your vehicle's driving stability, but also lead to tire damage and the risk of an accident. ◀

Tires heat up while driving, and the tire inflation pressure increases along with the tire's temperature. The tire inflation pressure specifications apply to cold tires or tires at ambient temperature.

Only check the tire inflation pressure when the tires are cold. This means after a maximum of 1.25 miles/2 km driving or when the vehicle has been parked for at least 2 hours.

The values displayed by tire inflation stations may be up to 0.1 bar, 2 psi too low.

For the Flat Tire Monitor: after adjusting the tire inflation pressure to a new value, reinitialize the Flat Tire Monitor, refer to page 93.

For the Tire Pressure Monitor: after adjusting the tire inflation pressure to a new value, reset the Tire Pressure Monitor, refer to page 96.

Pressure specifications

The tables below provide all the correct inflation pressures for the specified tire sizes at ambient temperature.

The inflation pressures apply to the tire sizes approved and tire brands recommended by BMW; a list of these is available from your service center.

For correct identification of the right tire inflation pressures, observe the following:

- ▶ Tire sizes of your vehicle.
- ▶ Maximum permitted driving speed.

Tire inflation pressures for driving up to 100 mph or 160 km/h

For normal driving up to 100 mph/160 km/h, adjust pressures to the respective tire inflation pressures listed on the following pages in the column for traveling speeds up to 100 mph/160 km/h to achieve optimum driving comfort.

These tire inflation pressures can also be found on the driver's side door pillar when the driver's door is open.



 Do not exceed the maximum permissible speed

The permissible maximum speed for these tire inflation pressures is 100 mph/160 km/h. Do

not exceed this speed or else there is a risk of tire damage and accidents. ◀

Tire inflation pressures for driving above 100 mph or 160 km/h

 Adjust the tire inflation pressures
To drive at maximum speeds in excess of 100 mph/160 km/h, adjust pressures to the respective tire inflation pressures listed on the following pages in the column for traveling speeds including those exceeding 100 mph or 160 km/h. Otherwise, tire damage and accidents could occur. ◀

Observe all national and local maximum speed limits; otherwise, violations of the laws could occur.

Tire inflation pressures X1 sDrive28i

Tire inflation pressure values up to 100 mph/160 km/h

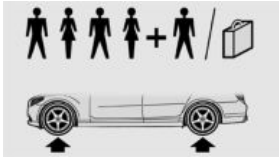
Tire size	Pressure specifications in bar/PSI	
<p>All pressure specifications in the table are indicated in bar/PSI with cold tires. Cold = ambient temperature</p>		
225/50 R 17 94 H M+S A/S RSC 225/50 R 17 94 V 225/50 R 17 94 H M+S RSC	2.2/32	2.6/38
225/45 R 18 91 V M+S A/S RSC 225/45 R 18 91 V RSC 225/45 R 18 91 H M+S RSC	2.4/35	2.8/41
Front: 225/45 R 18 91 V RSC Rear: 255/40 R 18 95 V RSC	2.4/35 -	- 2.6/38

Tire size	Pressure specifications in bar/PSI	
Front: 225/40 R 19 89 W RSC	2.6/38	-
Rear: 255/35 R 19 92 W RSC	-	2.8/41
Compact wheel: T 135/80 R 17 102 M	Speed up to a max. of 50 mph / 80 km/h 4.2/60	

Tire inflation pressure values over 100 mph/160 km/h

Without high-speed tuning feature

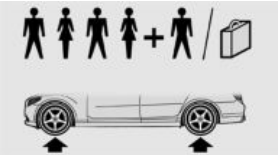
Tire size	Pressure specifications in bar/PSI	
<p>All pressure specifications in the table are indicated in bar/PSI with cold tires.</p> <p>Cold = ambient temperature</p>		
		
225/50 R 17 94 H M+S A/S RSC	2.4/35	2.9/42
225/45 R 18 91 V M+S A/S RSC		
225/50 R 17 94 V		
225/45 R 18 91 V RSC		
225/50 R 17 94 H M+S RSC		
225/45 R 18 91 H M+S RSC		
Front: 225/45 R 18 91 V RSC	2.4/35	-
Rear: 255/40 R 18 95 V RSC	-	2.9/42
Front: 225/40 R 19 89 W RSC	2.6/38	-
Rear: 255/35 R 19 92 W RSC	-	2.9/42
Compact wheel: T 135/80 R 17 102 M	Speed up to a max. of 50 mph / 80 km/h 4.2/60	

With high-speed tuning feature

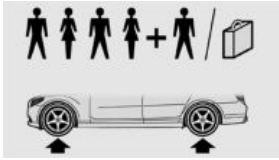
Tire size	Pressure specifications in bar/PSI	
All pressure specifications in the table are indicated in bar/PSI with cold tires. Cold = ambient temperature		
225/50 R 17 94 V	2.4/35	2.9/42
225/50 R 17 94 H M+S RSC		
225/45 R 18 91 W RSC	2.6/38	3.1/45
225/45 R 18 91 H M+S RSC		
Front: 225/45 R 18 91 V RSC	2.6/38	-
Rear: 255/40 R 18 95 V RSC	-	2.9/42
Front: 225/40 R 19 89 W RSC	2.8/41	-
Rear: 255/35 R 19 92 W RSC	-	3.1/45
Compact wheel: T 135/80 R 17 102 M	Speed up to a max. of 50 mph / 80 km/h 4.2/60	

Tire inflation pressures X1 xDrive28i/X1 xDrive35i

Tire inflation pressure values up to 100 mph/160 km/h

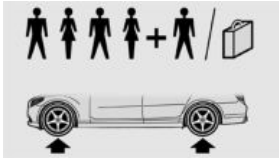
Tire size	Pressure specifications in bar/PSI	
All pressure specifications in the table are indicated in bar/PSI with cold tires. Cold = ambient temperature		
225/50 R 17 94 H M+S A/S RSC	2.2/32	2.6/38
225/50 R 17 94 H RSC		
225/50 R 17 94 H M+S RSC		
225/45 R 18 91 V M+S A/S RSC	2.4/35	2.8/41
225/45 R 18 91 V RSC		
225/45 R 18 91 H M+S RSC		

Tire size	Pressure specifications in bar/PSI	
Front: 225/45 R 18 91 V RSC	2.4/35	-
Rear: 255/40 R 18 95 V RSC	-	2.6/38
Front: 225/40 R 19 89 W RSC	2.6/38	-
Rear: 255/35 R 19 92 W RSC	-	2.8/41
Compact wheel: T 135/80 R 17 102 M	Speed up to a max. of 50 mph / 80 km/h 4.2/60	

Tire inflation pressure values over 100 mph/160 km/h

Without high-speed tuning feature

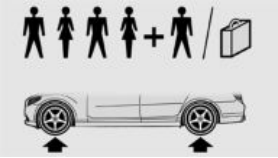
Tire size	Pressure specifications in bar/PSI	
All pressure specifications in the table are indicated in bar/PSI with cold tires. Cold = ambient temperature		
225/50 R 17 94 H M+S A/S RSC	2.4/35	2.9/42
225/50 R 17 94 H RSC		
225/50 R 17 94 H M+S RSC		
225/45 R 18 91 V M+S A/S RSC	2.6/38	3.1/45
225/45 R 18 91 V RSC		
225/45 R 18 91 H M+S RSC		
Front: 225/45 R 18 91 V RSC	2.6/38	-
Rear: 255/40 R 18 95 V RSC	-	2.9/42
Front: 225/40 R 19 89 W RSC	2.6/38	-
Rear: 255/35 R 19 92 W RSC	-	2.9/42
Compact wheel: T 135/80 R 17 102 M	Speed up to a max. of 50 mph / 80 km/h 4.2/60	

With high-speed tuning feature

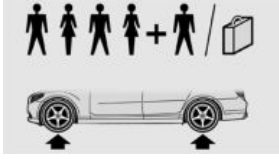
Tire size	Pressure specifications in bar/PSI	
All pressure specifications in the table are indicated in bar/PSI with cold tires. Cold = ambient temperature		
225/50 R 17 94 V	2.6/38	3.0/44
225/50 R 17 94 H M+S RSC		
225/45 R 18 91 W RSC	2.8/41	3.2/46
225/45 R 18 91 H M+S RSC		
Front: 225/45 R 18 91 V RSC	2.8/41	-
Rear: 255/40 R 18 95 V RSC	-	3.0/44
Front: 225/40 R 19 89 W RSC	3.0/44	-
Rear: 255/35 R 19 92 W RSC	-	3.2/46
Compact wheel: T 135/80 R 17 102 M	Speed up to a max. of 50 mph / 80 km/h 4.2/60	

Tire identification marks

Knowledge of the labeling on the side of the tire makes it easier to identify and choose the right tires.

Tire size

Example: 225/45 R 17 91 V

225: nominal width in mm

45: aspect ratio in %

R: radial tire code

17: rim diameter in inches

91: load rating, not for ZR tires

V: speed rating, before the R on ZR tires

Speed letter

Q = up to 100 mph/160 km/h

T = up to 118 mph/190 km/h

H = up to 131 mph/210 km/h

V = up to 150 mph/240 km/h

W = up to 167 mph/270 km/h

Y = up to 186 mph/300 km/h

Tire Identification Number

Tires with DOT codes meet the guidelines of the U.S. Department of Transportation.

DOT code:

DOT xxxx xxx 2313

xxxx: manufacturer code for the tire brand

xxx: tire size and tire design

2313: tire age

Tire age

The tire manufacturing date is contained in the tire identification mark: DOT ... 2313 means that the tire was manufactured in the week 23 of 2013.

BMW recommends that you replace all tires after 6 years at most, even if some tires may last for 10 years.

Uniform Tire Quality Grading

Quality grades can be found where applicable on the tire sidewall between tread shoulder and maximum section width. For example:

Treadwear 200 Traction AA

Temperature A

DOT Quality Grades

Treadwear

Traction AA A B C

Temperature A B C



Conform to Federal Safety Requirements

All passenger car tires must conform to Federal Safety Requirements in addition to these grades. ◀

Treadwear

The treadwear grade is a comparative rating based on the wear rate of the tire when tested under controlled conditions on a specified government test course. For example, a tire graded 150 would wear one and one-half (1 1/2) times as well on the government course as a tire graded 100. The relative performance of tires depends upon the actual conditions of their use, however, and may depart significantly from the norm due to variations in driving habits, service practices and differences in road characteristics and climate.

Traction

The traction grades, from highest to lowest, are AA, A, B, and C.

Those grades represent the tire's ability to stop on wet pavement as measured under controlled conditions on specified government test surfaces of asphalt and concrete. A tire marked C may have poor traction performance.

The traction grade assigned to this tire is based on straight-ahead braking traction tests, and does not include acceleration, cornering, hydroplaning, or peak traction characteristics.

Temperature

The temperature grades are A, the highest, B, and C, representing the tire's resistance to the generation of heat and its ability to dissipate heat when tested under controlled conditions on a specified indoor laboratory test wheel. Sustained high temperature can cause the material of the tire to degenerate and reduce tire life, and excessive temperature can lead to sudden tire failure. The grade C corresponds to a level of performance which all passenger car tires must meet under the Federal Motor Vehicle Safety Standard No. 109. Grades B and A represent higher levels of performance on the laboratory test wheel than the minimum required by law.



Temperature grade for this tire

The temperature grade for this tire is established for a tire that is properly inflated and not overloaded. Excessive speed, underinflation, or excessive loading, either separately or in combination, can cause heat buildup and possible tire failure. ◀

RSC – Run-flat tires

The symbol identifying run-flat tires is a circle with the letters RSC on the sidewall, refer to page 241.

M+S

Winter and all-season tires.

These have better winter properties than summer tires.

XL

Designation for specially reinforced tires.

Tire tread

Summer tires

Do not drive with a tire tread depth of less than 0.12 in/3 mm.

There is an increased danger of hydroplaning if the tread depth is less than 0.12 in/3 mm.

Winter tires

Do not drive with a tire tread depth of less than 0.16 in/4 mm.

Below a tread depth of 0.16 in/4 mm, tires are less suitable for winter operation.

Minimum tread depth

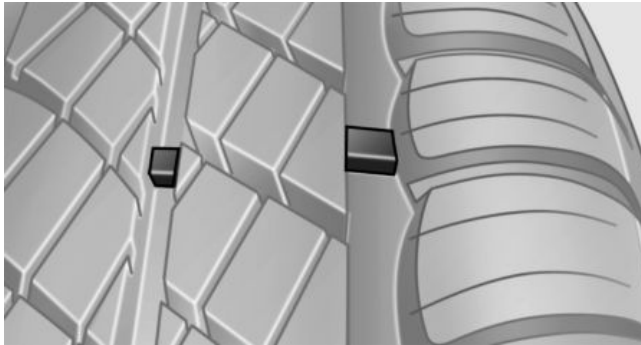

Wear indicators are distributed around the tire's circumference and have the legally required minimum height of 0.063 in/1.6 mm.

They are marked on the side of the tire with TWI, Tread Wear Indicator.

Tire damage

General information

Inspect your tires often for damage, foreign objects lodged in the tread, and tread wear.

Notes

Driving over rough or damaged road surfaces, as well as debris, curbs and other obstacles can cause serious damage to wheels, tires and suspension parts. This is more likely to occur with low-profile tires, which provide less cushioning between the wheel and the road. Be careful to avoid road hazards and reduce your speed, especially if your vehicle is equipped with low-profile tires.

Indications of tire damage or other vehicle defects:

- ▷ Unusual vibrations during driving.
- ▷ Unusual handling such as a strong tendency to pull to the left or right.

Damage can be caused by driving over curbs, road damage and similar situations.



In case of tire damage

If there are indications of tire damage, reduce your speed immediately and have the wheels and tires checked right away; otherwise, there is the increased risk of an accident.

Drive carefully to the next service center or tire shop.

If necessary, have the vehicle towed.

Otherwise, tire damage can present a life-threatening hazard to vehicle occupants and other road users. ◀



Repair of tire damage

For safety reasons, the manufacturer of your vehicle recommends that you do not have damaged tires repaired; they should be replaced. Otherwise, damage can occur as a result. ◀

Changing wheels and tires

Mounting



Information on mounting tires

Have mounting and balancing performed only by a service center or tire specialist.

If this work is not carried out properly, there is the danger of subsequent damage and related safety hazards. ◀

Wheel and tire combination

Information on the right wheel and tire combination and rim version for your vehicle can be obtained from the service center.

Incorrect wheel and tire combinations impair the function of a variety of systems such as ABS or DSC.

To maintain good handling and vehicle response, use only tires with a single tread configuration from a single manufacturer.

Following tire damage, have the original wheel and tire combination remounted on the vehicle as soon as possible.



Approved wheels and tires

The manufacturer of your vehicle recommends that you use only wheels and tires that have been approved for your particular vehicle model.

For example, despite having the same official size ratings, variations can lead to body contact and with it, the risk of severe accidents.

The manufacturer of your vehicle cannot evaluate non-approved wheels and tires to determine if they are suited for use, and therefore cannot ensure the operating safety of the vehicle if they are mounted. ◀

Wheels with electronics for TPM Tire Pressure Monitor

When mounting new tires or changing from summer to winter tires or vice versa, only use wheels with TPM electronics; otherwise, the Tire Pressure Monitor will not be able to detect a flat tire, refer to page 95. Your service center will be glad to advise you.

Recommended tire brands



For each tire size, the manufacturer of your vehicle recommends certain tire brands. These can be identified by a star on the tire sidewall. With proper use, these tires meet the highest standards for safety and handling.

Retreaded tires

The manufacturer of your vehicle does not recommend the use of retreaded tires.



Retreaded tires

Possibly substantial variations in the design and age of the tire casing structures can limit service life and have a negative impact on road safety. ◀

Winter tires

The manufacturer of your vehicle recommends winter tires for winter roads or at temperatures below +45 °F/+7 °C.

Although so-called all-season M+S tires do provide better winter traction than summer tires, they do not provide the same level of performance as winter tires.

Maximum speed of winter tires

If the maximum speed of the vehicle is higher than the permissible speed for the winter tires, then display a corresponding sign in the field of vision. You can obtain this sign from the tire specialist or from your service center.



Maximum speed for winter tires

Do not exceed the maximum speed for the winter tires; otherwise, tire damage and accidents can occur. ◀

Run-flat tires

For your own safety, only use run-flat tires. Your service center will be glad to advise you.

Rotating wheels between axles

The manufacturer of your vehicle advises against swapping wheels between the front and rear axles.

This can impair the handling characteristics.

Rotating the tires is not permissible when using different types of tires.

Storage

Store wheels and tires in a cool, dry place with as little exposure to light as possible.

Always protect tires against all contact with oil, grease and fuels.

Do not exceed the maximum tire inflation pressure indicated on the side wall of the tire.

Run-flat tires

Label



RSC label on the tire sidewall.

The wheels are composed of special rims and tires that are self-supporting, to a limited degree.

The support of the sidewall allows the tire to remain drivable to a restricted degree in the event of a pressure loss.

Driving with a damaged tire:

- ▷ Flat Tire Monitor FTM, refer to page 93
- ▷ Tire Pressure Monitor TPM, refer to page 95

Changing run-flat tires

For your own safety, only use run-flat tires. No spare tire is available in the case of a flat tire. Your service center will be glad to advise you.

Snow chains

Only certain fine-link snow chains have been tested by BMW, classified as safe for use and recommended. Consult your service center for more information.

Snow chains must be mounted in pairs and on the rear wheels only.

Observe the manufacturer's instructions when mounting snow chains. Do not exceed a speed of 30 mph/50 km/h when using snow chains.

Do not reset the Tire Pressure Monitor if snow chains are mounted; otherwise, the instrument might issue an incorrect reading.

Do not initialize the Flat Tire Monitor or reset the Tire Pressure Monitor if snow chains are mounted; otherwise, the instrument might issue an incorrect reading.

When driving with snow chains, it can be beneficial to temporarily activate DTC, refer to page 100.

Engine compartment

Vehicle equipment

This chapter describes all series equipment as well as country-specific and special equipment offered for this model series. Therefore, it also describes equipment that may not be found in your vehicle, for instance due to the selected

special equipment or the country version. This also applies to safety-related functions and systems.

When using the features and systems described here, adhere to local regulations.

Important features in the engine compartment

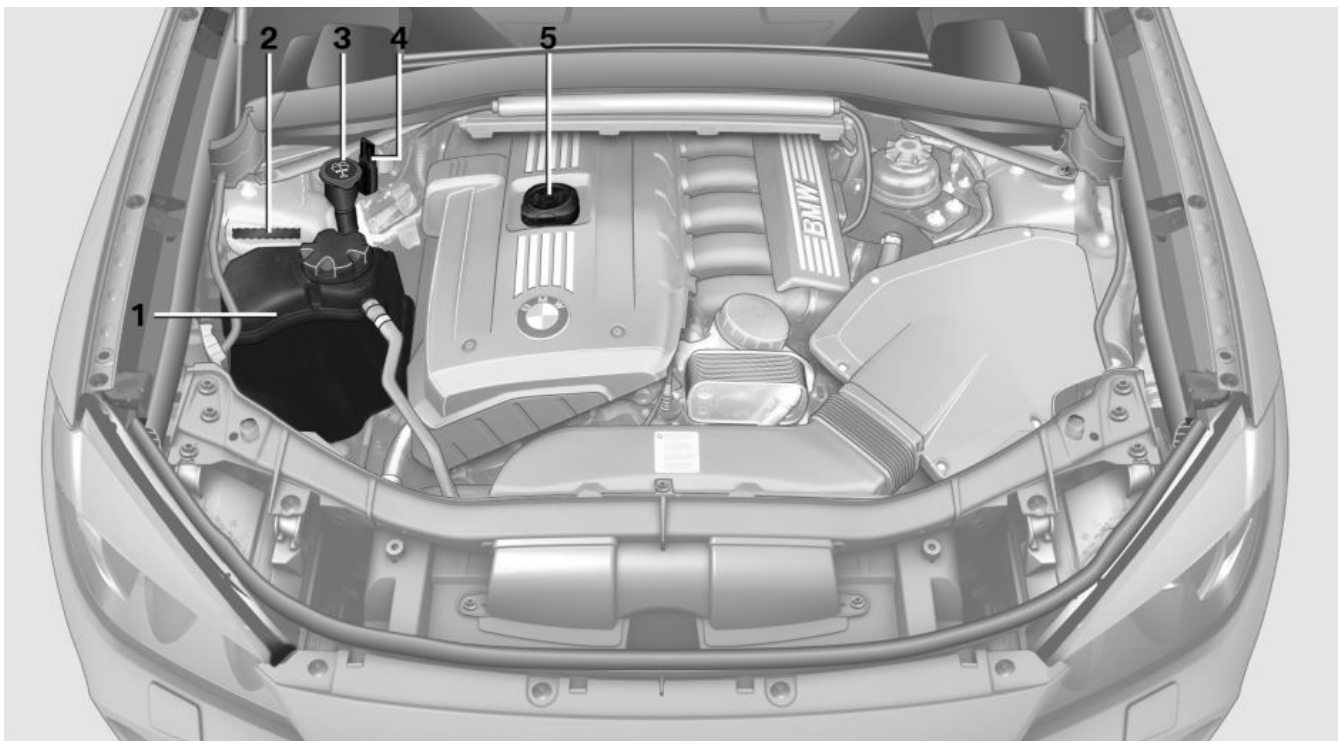

- | | |
|--|---|
| 1 Coolant expansion tank 246 | 4 Jump-starting, positive terminal |
| 2 Vehicle identification number | 5 Filler neck for engine oil, refer to Adding engine oil |
| 3 Filler neck for washer fluid for the headlamp and window washer system 67 | |

Hood

Opening the hood



Working in the engine compartment

Never attempt to perform any service or repair operations on your vehicle without the necessary professional technical training.

If you are unfamiliar with the statutory guidelines, have any work on the vehicle performed only by a service center.

If this work is not carried out properly, there is the danger of subsequent damage and related safety hazards. ◀



Risk of damage

Before opening the hood, ensure that the wiper arms with wiper blades are folded onto the window; otherwise, damage may occur. ◀

1. Pull the lever.

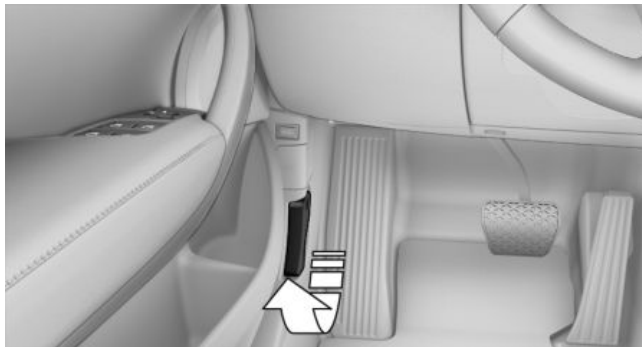

2. Lift the hood all the way.
3. Press the release handle and open the hood.

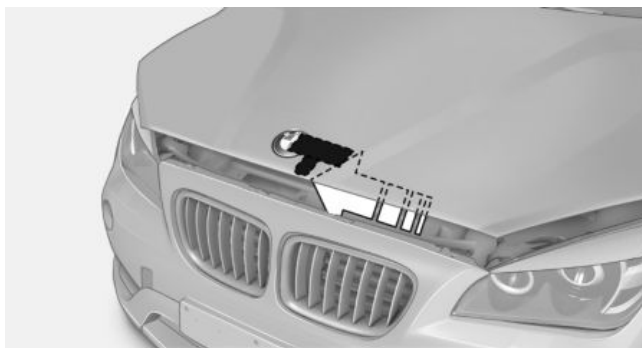

Closing the hood



Drop the hood from a height of approx. 16 in/40 cm. It must be clearly heard to engage.



Hood open when driving

If you see any signs that the hood is not completely closed while driving, pull over immediately and close it securely. ◀



Danger of pinching

Make sure that the closing path of the hood is clear; otherwise, injuries may result. ◀

Engine oil

General information

Engine oil consumption depends on the driving style and the conditions of use. A highly sporty driving style, for example, results in considerably higher engine oil consumption.

Therefore, regularly check the engine oil level after refueling.

Depending on the engine, the vehicle uses electronic oil measurement or dip stick measurement.

Checking the engine oil level

Your car is equipped with an electronic engine oil level check.

Requirements

- ▶ The engine must be running and warm after the vehicle has been driven for at least 6.2 miles/10 km.
- ▶ The vehicle is stopped or being driven on a level roadway.



Display in the instrument cluster

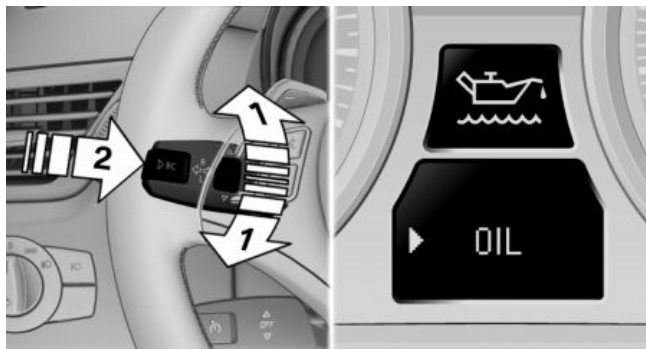

1. Lightly press button 1 in the turn indicator lever up or down repeatedly until the appropriate symbol appears in the display, accompanied by the word "OIL".



2. Press button 2 in the turn indicator lever. The oil level is checked and the reading displayed.

Possible displays

Symbol	Function
	Oil level OK.
	Oil level is being checked. This can take about 3 minutes if the car is at a standstill on a level surface, or about 5 minutes while the car is on the move.

Symbol	Function
	Oil at minimum level: Add a maximum quantity of 1 US quart/1 liter of engine oil, refer to page 245, at the next opportunity.
	Oil level is too high. Overfilling oil damages the engine. Have the vehicle checked immediately.
	The oil level sensor is defective. Do not add engine oil. It is possible to continue driving. Note the newly calculated remaining mileage until the next oil service, refer to page 80. Have the system checked as soon as possible.

Display via iDrive

1. "Vehicle Info"
2. "Vehicle status"

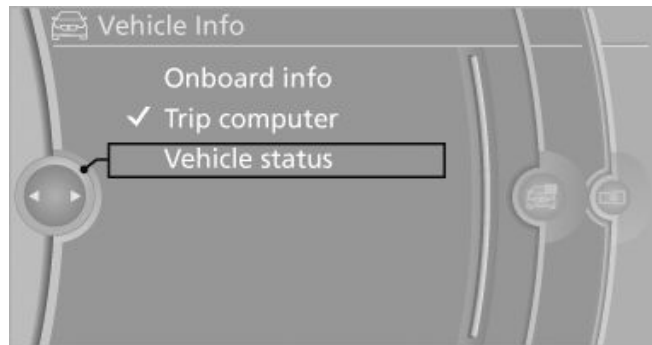

3.  "Engine oil level"

Possible messages

- ▶ "Engine oil level OK"
- ▶ "Measurement not possible at this time."
- ▶ "Measuring engine oil level..."

Duration with the engine running: approx. 3 minutes.

Duration while driving: approx. 5 minutes.

If engine oil was added, it may take up to 30 minutes to obtain an oil level reading.

- ▶ "Engine oil level below minimum. Add 1 quart!"

Add a maximum quantity of 1 US quart/1 liter of engine oil at the next opportunity, refer also to Adding engine oil below.

- ▶ "Engine oil level too high! Have this checked."

 Too much engine oil
Have the vehicle checked immediately; otherwise, surplus oil can lead to engine damage. ◀

- ▶ "Measurement inactive. Have this checked." Do not add engine oil. It is possible to continue driving. Note the newly calculated remaining mileage until the next oil service, refer to page 80. Have the system checked as soon as possible.

Adding engine oil

Filler neck

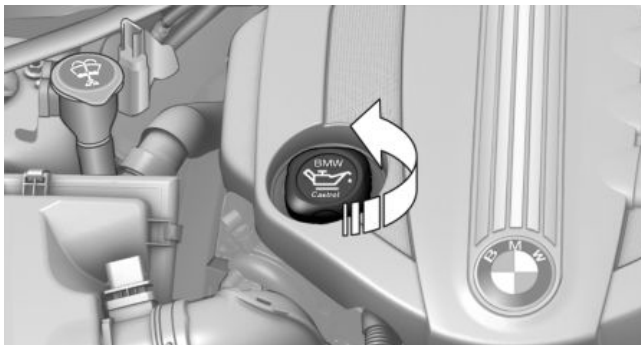

Add a maximum quantity of 1 US quart/1 liter of oil only after a corresponding message appears on the Control Display.

 Add oil promptly
Add oil within the next 125 miles/200 km; otherwise, engine damage could result. ◀

 Too much engine oil
Have the vehicle checked immediately; otherwise, surplus oil can lead to engine damage. ◀

 Protect children
Keep oil, grease, etc., out of reach of children and heed the warnings on the containers to prevent health risks. ◀

Oil types for refilling

Notes

 No oil additives
Do not use oil additives as these may cause engine damage. ◀

 Viscosity classes of engine oils
When selecting an engine oil, ensure that the engine oil belongs to one of the SAE viscosity classes 0W-40, 0W-30, 5W-40, or 5W-30, or malfunctions or engine damage may occur. ◀

The engine oil quality is critical for the life of the engine.

Due to national regulations, some oil types are not available in every country.

Approved oil types

Gasoline engine

BMW High Performance SAE 5W-30

BMW Longlife-01

BMW Longlife-01 FE

Further information on approved oil types can be obtained from the service center.

Alternative oil types

If the approved engine oils are not available, up to 1 US quart/liter of an oil with the following specification can be used:

Gasoline engine

API SM or a higher quality standard

Oil change

The manufacturer of your vehicle recommends having the engine oil changed by a service center.

BMW recommends
Original BMW Engine Oil.

Coolant

General information

 Danger of burns from hot engine
Do not open the cooling system while the engine is hot; otherwise, escaping coolant may cause burns. ◀

 Suitable additives
Only use suitable additives; otherwise, engine damage may occur. The additives are harmful to your health. ◀

Coolant consists of water and additives. Not all commercially available additives are suitable for your vehicle. Ask your service center for suitable additives.

Checking the coolant level

1. Do not open the hood until the engine has cooled down.
2. Turn the expansion tank cap counterclockwise slightly to allow any accumulated

pressure to escape; then continue turning to open.

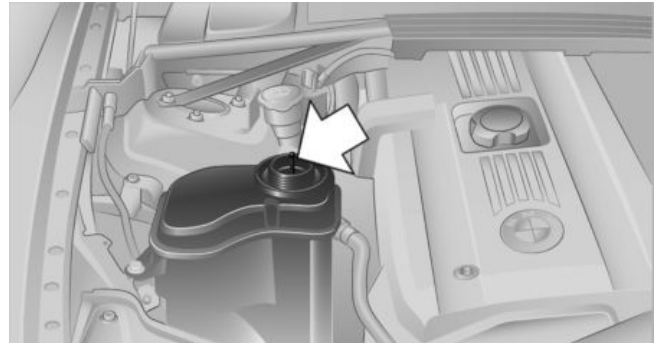

3. The filling level indicator 1 in the filler neck indicates the coolant level. The coolant level is correct if it is between the arrows of the respective reservoir label 2.

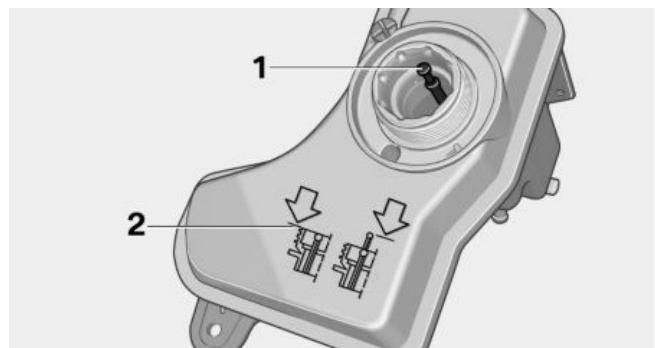

4. If the coolant is low, slowly add coolant up to the specified level; do not overfill.
5. Turn the cap until there is an audible click.
6. Have the cause of the coolant loss eliminated as soon as possible.

Disposal

 Comply with the appropriate environmental protection regulations when disposing of coolant additives.

Maintenance

Vehicle equipment

This chapter describes all series equipment as well as country-specific and special equipment offered for this model series. Therefore, it also describes equipment that may not be found in your vehicle, for instance due to the selected special equipment or the country version. This also applies to safety-related functions and systems.

When using the features and systems described here, adhere to local regulations.

BMW Maintenance System



The maintenance system provides information on required maintenance measures and thus provides support in maintaining road safety and the operational reliability of the vehicle.

Service scopes and intervals may vary with the country version. Replacement work, spare parts, fuels and lubricants and wear materials are calculated separately. Additional information can be obtained from the service center.

Condition Based Service CBS

Sensors and special algorithms take into account the driving conditions of your vehicle. Based on this, Condition Based Service determines the maintenance requirements.

The system makes it possible to adapt the amount of maintenance you need to your user profile.

Details on the service requirements, refer to page 80, can be displayed on the Control Display.

On the Control Display, the remaining distances and times for selected maintenance requirements and any legally required deadlines can be displayed individually, refer to page 80.

Service data in the remote control

Information on the required maintenance is continuously stored in the remote control. Your service center will read out this data and suggest the right array of service procedures for your vehicle.

Therefore, hand your service specialist the remote control that you used most recently.



Setting the correct date

Make sure the date is set correctly, refer to page 78; otherwise, the effectiveness of CBS Condition Based Service is not ensured. ◀

Storage periods

Storage periods during which the vehicle battery was disconnected are not taken into account.

If this occurs, have a service center update the time-dependent maintenance procedures, such as checking brake fluid and, if necessary, changing the engine oil and the microfilter/activated-charcoal filter.

Service and Warranty Information Booklet for US models and Warranty and Service Guide Booklet for Canadian models

Please consult your Service and Warranty Information Booklet for US models and Warranty and Service Guide Booklet for Canadian models for additional information on service requirements.

Maintenance and repair should be performed by your service center. Make sure to have regular maintenance procedures recorded in the vehicle's Service and Warranty Information Booklet for US models, and in the Warranty and Service Guide Booklet for Canadian models. These entries are proof of regular maintenance.

Socket for OBD Onboard Diagnosis



Socket for Onboard Diagnosis

The socket for Onboard Diagnosis may only be used by the service center, by workshops that operate according to the specifications of the vehicle manufacturer with appropriately trained personnel, and by other authorized persons. Otherwise, its use may lead to vehicle malfunctions. ◀

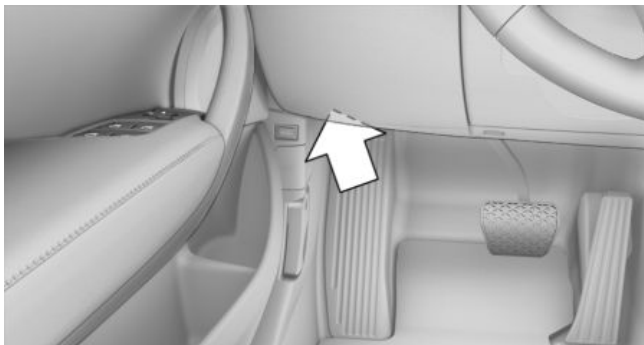

On the driver's side is an OBD socket for checking the primary components in the vehicle emissions.

Emissions



- ▷ The warning light lights up: Emissions are deteriorating. Have the vehicle checked as soon as possible.
- ▷ The warning light flashes under certain circumstances:

This indicates that there is excessive misfiring in the engine.

Reduce the vehicle speed and have the system checked immediately; otherwise, serious engine misfiring within a brief period can seriously damage emission control components, in particular the catalytic converter.



Display of the previously described malfunctions on Canadian models.

Fuel cap

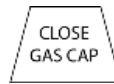

The indicator lamp lights up.

If the fuel cap is not properly tightened, the OBD system may conclude that fuel vapor is escaping. If the cap is then tightened, the display should go out in a short time.

Replacing components

Vehicle equipment

This chapter describes all series equipment as well as country-specific and special equipment offered for this model series. Therefore, it also describes equipment that may not be found in your vehicle, for instance due to the selected special equipment or the country version. This also applies to safety-related functions and systems.

When using the features and systems described here, adhere to local regulations.

Tool kit



The tool kit is stowed under the cargo floor panel and storage compartment in the cargo area.

Wiper blade replacement



Do not fold down the wipers without wiper blades

Do not fold down the wipers if wiper blades have not been installed; this may damage the windshield. ◀

Front

1. To change the wiper blades, fold up the wiper arms, refer to page 66.

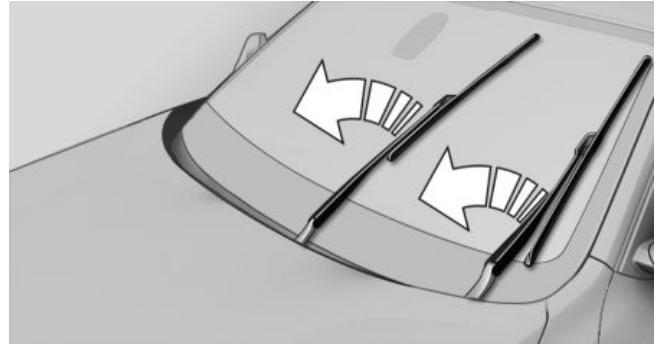

2. Fold up and hold the wiper arm.

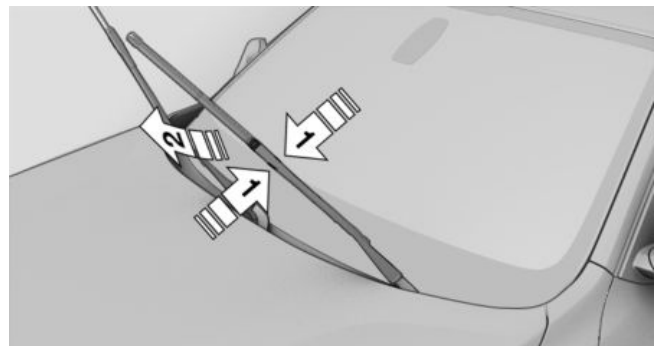

3. Squeeze the locking spring, arrows 1, and fold out the wiper blade, arrow 2.
4. Take the wiper blade out of the catch mechanism toward the front.
5. Insert the new wiper blade in reverse order, making sure it engages.



Risk of damage

Before opening the hood, ensure that the wiper arms with wiper blades are folded onto the window; otherwise, damage may occur. ◀

Rear

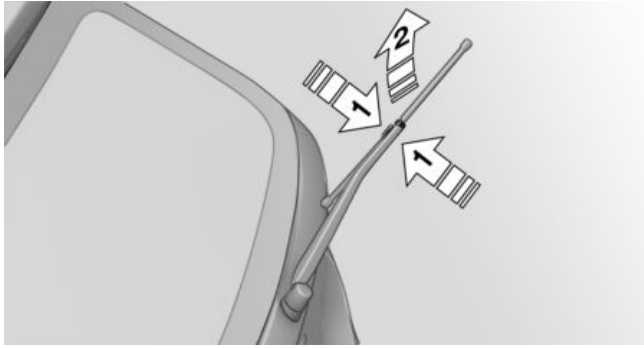

1. Fold up and hold the wiper arm.
2. Squeeze the locking spring, arrows 1, and fold out the wiper blade, arrow 2.
3. Take the wiper blade out of the catch mechanism toward the front.

Lamp and bulb replacement

Notes

Lamps and bulbs

Lamps and bulbs make an essential contribution to vehicle safety.

The manufacturer of the vehicle recommends that you entrust corresponding procedures to the service center if you are unfamiliar with them or they are not described here.

You can obtain a selection of replacement bulbs at the service center.

Danger of burns

Only change bulbs when they are cool; otherwise, there is the danger of getting burned. ◀

Working on the lighting system

When working on the lighting system, you should always switch off the lights affected to prevent short circuits.

To avoid possible injury or equipment damage when replacing bulbs, observe any instructions provided by the bulb manufacturer. ◀

Do not perform work/bulb replacement on xenon headlamps

Have any work on the xenon lighting system, including bulb replacement, performed only by a service center.

Due to the high voltage present in the system, there is the danger of fatal injuries if work is carried out improperly. ◀

Do not touch the bulbs

Do not touch the glass of new bulbs with your bare hands, as even minute amounts of contamination will burn into the bulb's surface and reduce its service life.

Use a clean tissue, cloth or something similar, or hold the bulb by its base. ◀

Light-emitting diodes LED

Light-emitting diodes installed behind translucent lenses serve as the light source for many of the controls, displays and other equipment in your vehicle.

These light-emitting diodes, which operate using a concept similar to that applied in conventional lasers, are officially designated as Class 1 light-emitting diodes.

Do not remove the covers

Do not remove the covers, and never stare into the unfiltered light for several hours; otherwise, irritation of the retina could result. ◀

Headlamp glass

Condensation can form on the inside of the headlamps in cool or humid weather. When you drive with the lights switched on, the condensation evaporates after a short time. The headlamps do not need to be changed.

If the condensation in the headlamps does not evaporate after trips with the lights switched on, and the amount of moisture in the headlamps increases, for example if water droplets form, have them checked by your service center.

Headlight setting

Changing the bulbs and lights may influence the headlight settings. Have the headlight setting checked by a service center and corrected if necessary after changing bulbs or lights.

Removing the headlight cover

The high-beam bulbs can be replaced via the engine compartment, and the low beam and turn signal bulbs can be replaced via a folding cover in the wheel arch.

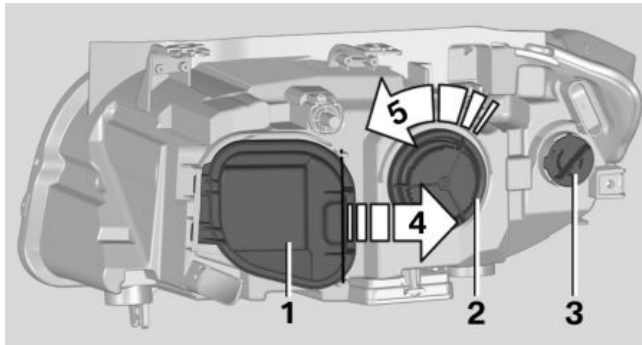

- 1 High-beam cover
- 2 Low beam cover
- 3 Turn signal bulb socket

To remove the covers:

- ▶ High-beams: fold out the bracket, arrow 4, and take the cover out of the guide.
- ▶ Low beams: unscrew the cover, arrow 5.



Attach the covers carefully

When attaching the covers, proceed carefully; otherwise, leaks may occur, causing damage to the headlamp system. ◀

Proceed in reverse order when attaching the covers.

Access via the wheel arch

For low beams and turn signals only:

1. Turn the wheel inward.
2. Open the folding cover in the wheel arch. To open the locks, turn them counter-

clockwise all the way using a coin, for example.

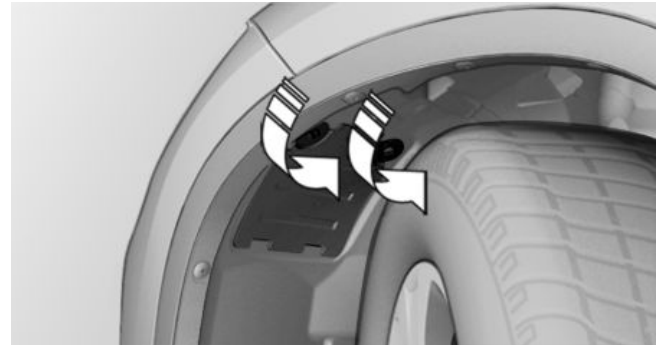

Halogen headlights

At a glance

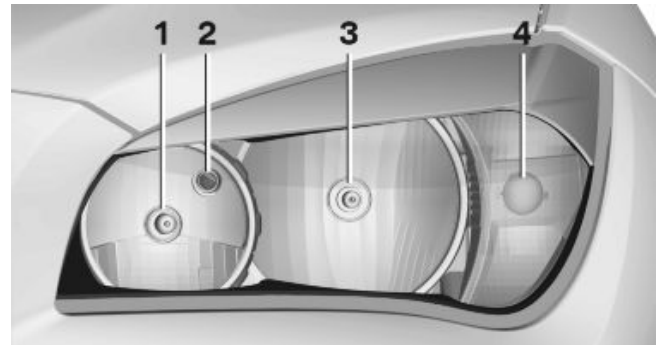

- 1 High-beams/headlight flasher
- 2 Parking lights
- 3 Low beams
- 4 Turn signal

Low beams and high-beams



Wear protective goggles and gloves

Halogen bulbs are pressurized. Therefore, wear protective goggles and gloves. Otherwise, there is a danger of injuries if the bulb is accidentally damaged during replacement. ◀

The low beams and high-beams have separate covers.

H7 bulb, 55 watt

1. Switch off the lights and take the remote control out of the ignition lock.
2. Low beam: open the folding cover in the wheel arch, refer to page 251.
3. Remove the corresponding cover, refer to page 251.
4. Unplug the connector from the bulb.
5. Slide the wire bracket sideways out of the anchor, arrow 1, and fold down, arrow 2.

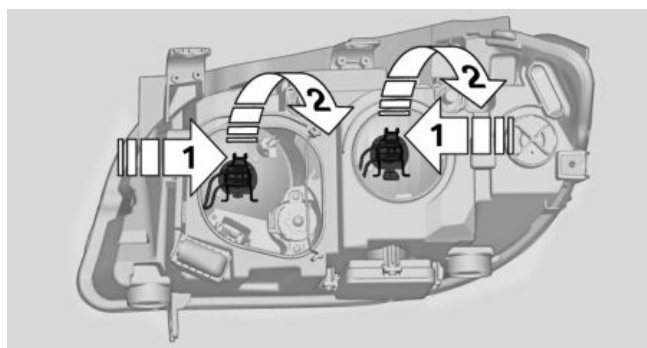

6. Remove the bulb.
7. Insert the new bulb.
8. Fold up the wire bracket and lock it.
9. Mount the connector.
10. Reattach the cover.
11. Low beam: attach the folding cover in the wheel arch.

Parking and roadside parking lights

5-watt bulb, W5W

1. Switch off the lights and take the remote control out of the ignition lock.
2. Remove the high-beam cover, refer to page 251.

3. Pull out the bulb socket, see arrow.

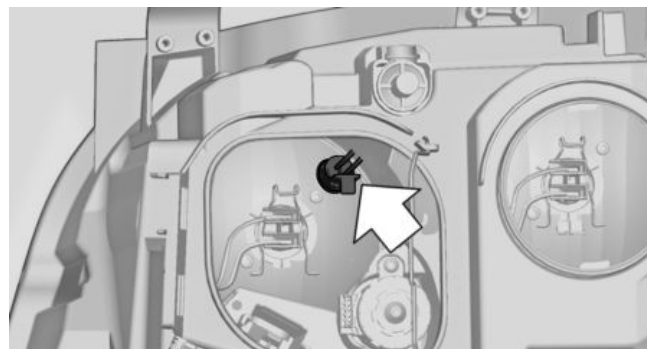

4. Pull off the bulb and replace it.
5. Insert the bulb socket.
6. Reattach the cover.

Xenon headlights

Xenon headlights

At a glance

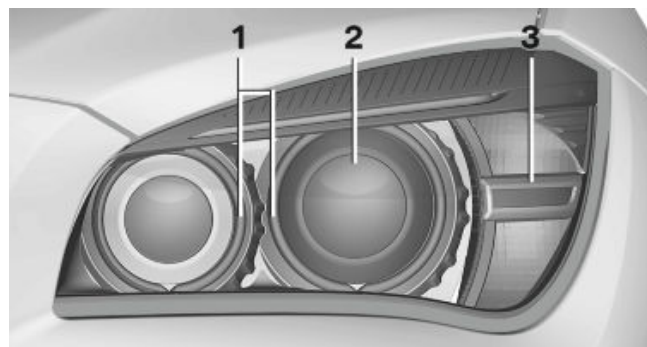

- 1 Parking lights / daytime running lights
- 2 Low beams/high-beams/headlight flasher
- 3 Turn signal

Because of the long life of these bulbs, the likelihood of failure is very low. Switching the lights on and off frequently shortens their life.



Do not perform work/bulb replacement on xenon headlamps

Have any work on the xenon lighting system, including bulb replacement, performed only by a service center.

Due to the high voltage present in the system, there is the danger of fatal injuries if work is carried out improperly. ◀

Adhere to the general instructions, refer to page 250.

With Xenon headlights, the following lights are designed with LED technology:

- ▶ Parking and roadside parking lights.
- ▶ Daytime running lights.

Contact your service center in the event of a malfunction.

Parking lights and roadside parking lights, daytime running lights

H8 bulb, 35 watt

1. Switch off the lights and take the remote control out of the ignition lock.
2. Remove the high-beam cover, refer to page 251.
3. Turn the bulb by approx. 90°, see arrow, and pull it out.

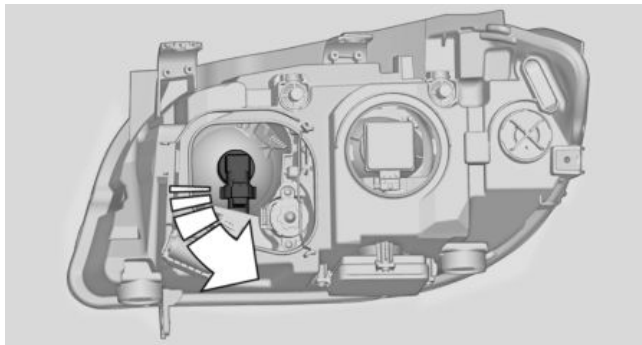

4. Disconnect the plug, change the bulb and reconnect the plug.
5. Insert the bulb and turn it until it stops.
6. Reattach the cover.

Turn signals, front

21-watt bulb, PY21W

1. Switch off the lights and take the remote control out of the ignition lock.
2. Open the folding cover in the wheel arch, refer to page 251.

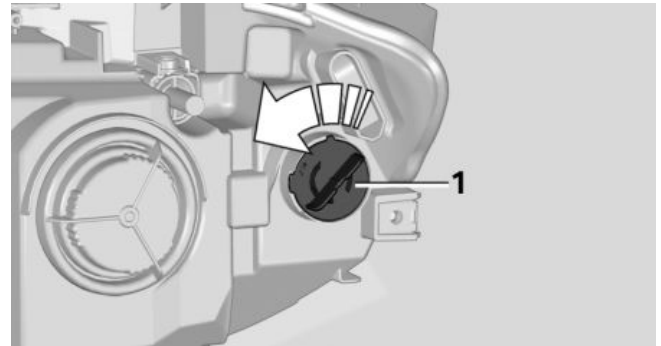

3. Turn the turn signal bulb socket 1 to the left and remove it.
4. Apply gentle pressure to the bulb while turning it to the left for removal and replacement.
5. Insert the turn signal bulb socket 1 and turn it all the way to the right.
6. Attach the folding cover in the wheel arch.

Turn signal in exterior mirror

Follow the general instructions on lights and bulbs, refer to page 250.

Contact your service center in the event of a malfunction.

Tail lights

The tail lights consist of two parts. One part is in the tailgate and the other is in the fender.

P21W bulbs, 21 watt

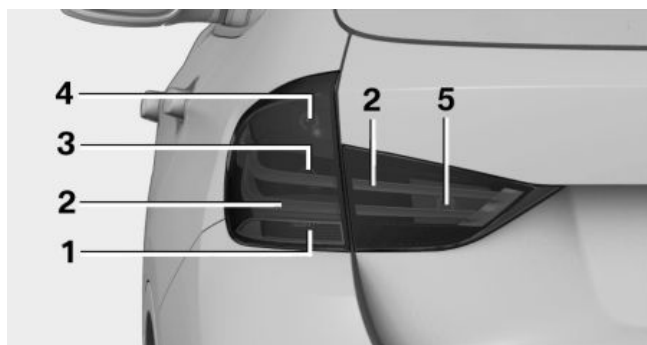

- 1 Backup light
- 2 Roadside parking light/tail light LED
- 3 Brake light
- 4 Turn signal
- 5 Inner brake light

Contact your service center in the event of a faulty roadside parking lamp/tail lamp.

Lamps in the fender

All bulbs are integrated in a central bulb holder.

- 1. Switch off the lights and take the remote control out of the ignition lock.
- 2. Press the cover out of the cargo area side panel at the rear and remove it.

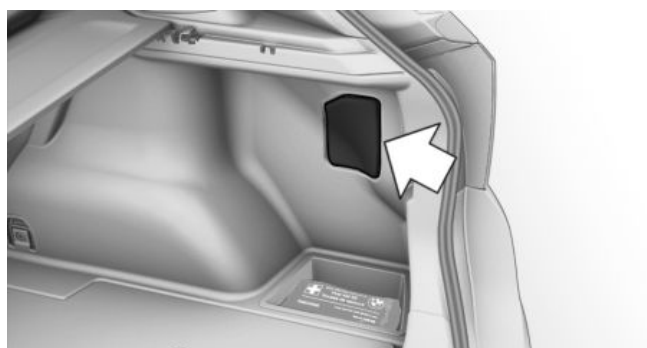

- 3. Disengage the bulb holder by pressing down the upper clip, arrow 1.

On the right side, take the button with the fuel pump symbol out of the holder toward the front if necessary.

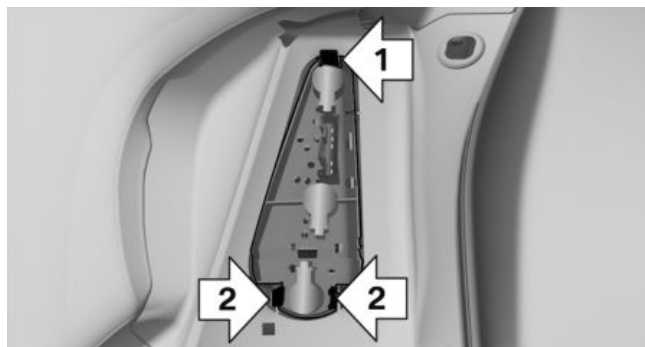

- 4. Squeeze the lower clips, arrows 2, and take out the bulb holder.
- 5. Apply gentle pressure to the bulb while turning it to the left for removal and replacement.
- 6. Re-engage the bulb holder so that it audibly clicks into place.
- 7. Replace the cover.

Inside brake lights in the tailgate

- 1. Switch off the lights and take the remote control out of the ignition lock.
- 2. Take the warning triangle out of the bracket, refer to page 258.
- 3. Release the screws of the tailgate panel, arrows.

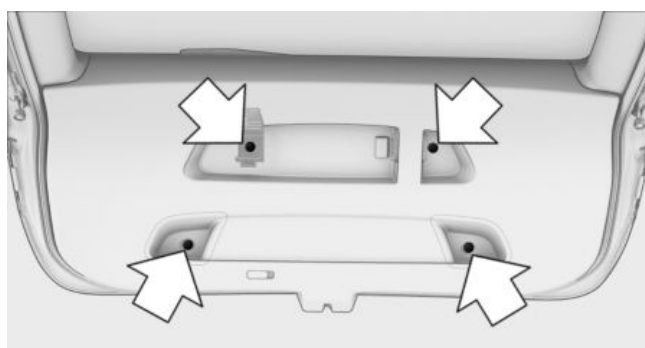

- 4. Unclip the tailgate panel by pulling it downward.
- 5. Push out the handle for opening manually in the event of an electrical malfunction, refer to page 38, insert it through the opening, and take off the panel.

- Release the bulb holder with the clip, see arrows, and remove it.

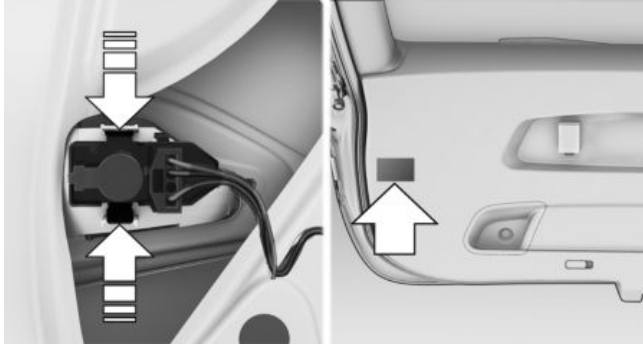

- Apply gentle pressure to the bulb while turning it to the left for removal and replacement.
- Re-engage the bulb holder so that it audibly clicks into place.
- Insert the handle for opening manually through the tailgate panel opening and press it in.
- Reattach the tailgate panel.

License plate lamp, center brake lamp, and roadside parking lamp/tail lamp

These lamps are made using LED technology. Contact your service center in the event of a malfunction.

Changing wheels

Notes

Your vehicle is equipped with run-flat tires, refer to page 241, as standard equipment.

They do not need to be replaced immediately in the event of a puncture.

No spare tire is available in the case of a flat tire.

When mounting new tires or changing from summer to winter tires or vice versa, use run-flat tires for your own safety.

Suitable tools for changing the wheels are available from the service center as an accessory.

Jacking points for the vehicle jack

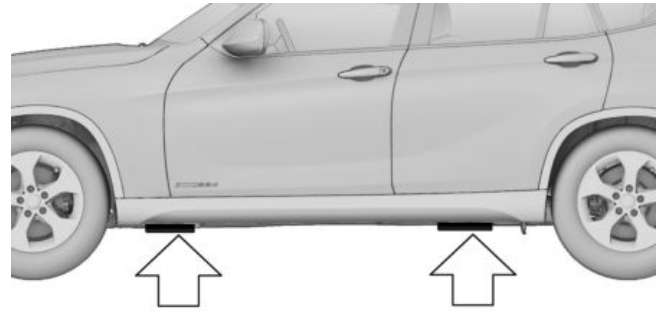

The jacking points for the vehicle jack are located in the positions shown.

Vehicle battery

Maintenance

The battery is maintenance-free, i.e., the electrolyte will last for the life of the battery.

Your service center will be glad to advise you on questions regarding the battery.

Battery replacement



Use approved vehicle batteries

Only use vehicle batteries that have been approved for your vehicle by the manufacturer; otherwise, the vehicle could be damaged and systems or functions may not be fully available. ◀

After a battery replacement, have the battery registered on the vehicle by your service center to ensure that all comfort functions are fully available.

Charging the battery

Note



Do not connect the charger to the socket

Do not connect the battery charger to the socket installed in the vehicle at the factory as this could damage the battery. ◀

General information

Ensure that the battery is sufficiently charged to achieve the full battery life.

It may be necessary to charge the battery in the following cases:

- ▶ When the vehicle is frequently used to drive short distances.
- ▶ When the vehicle has not been driven for more than one month.

Starting aid terminals

Only charge using the starting aid terminals, refer to page 259, in the engine compartment while the engine is switched off.

Power failure

After a temporary power loss, some equipment needs to be reinitialized.

Individual settings need to be reprogrammed:

- ▶ Seat and mirror memory: store the positions again, refer to page 50.
- ▶ Time: update, refer to page 77.
- ▶ Date: update, refer to page 78.
- ▶ Radio station: save again, refer to page 168.
- ▶ Navigation system: wait for the navigation system to be operational.
- ▶ Panoramic glass sunroof: it may only be possible to tilt the roof. Have the system initialized by the service center.
- ▶ Digital compass: recalibrate, refer to page 117.
- ▶ xDrive: the system automatically initializes as you drive. During this time, indicator lamps light up. If the lamps do not disappear during the current trip, have the system checked.

Disposing of old batteries



Have old batteries disposed of by your service center or bring them to a recycling center.

Maintain the battery in an upright position for transport and storage. Secure the battery so that it does not tip over during transport.

Fuses



Replacing fuses

Never attempt to repair a blown fuse and do not replace a defective fuse with a substitute of another color or amperage rating; this could lead to a circuit overload, ultimately resulting in a fire in the vehicle. ◀

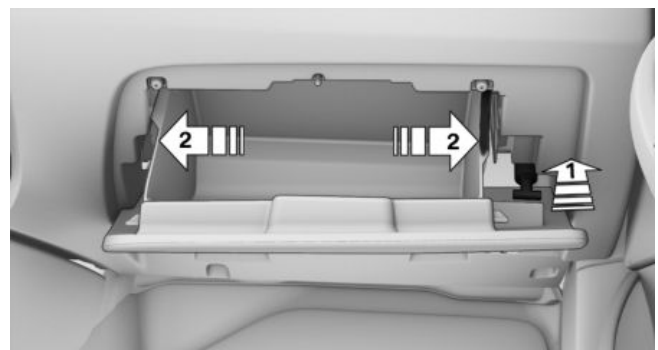

Access to fuse box:

1. Open the glove compartment.
2. Release the damper from the bottom holder by applying pressure toward the front, arrow 1.
3. Unlock the glove compartment by pressing on both tabs, arrows 2, and fold down.

A pair of plastic tweezers is found on the current distributor.

Information on the fuses can be found on the back of the cover.

Spare fuses are available from the service center.

Breakdown assistance

Vehicle equipment

This chapter describes all series equipment as well as country-specific and special equipment offered for this model series. Therefore, it also describes equipment that may not be found in your vehicle, for instance due to the selected special equipment or the country version. This also applies to safety-related functions and systems.

When using the features and systems described here, adhere to local regulations.

Hazard warning flashers



The button for the hazard warning system is located on the center console.



Do not fold in the exterior mirrors

While driving and when using the turn signal/hazard warning flashers, do not fold in the exterior mirrors; otherwise, the additional turn signal lamps in the exterior mirrors will not be in the appropriate position and will be difficult to detect. ◀

Intelligent Emergency Request

Requirements

- ▶ Radio readiness is switched on.

- ▶ The Assist system is operable.
 - ▶ The SIM card integrated in the vehicle is activated.
 - ▶ ConnectedDrive subscription is available.
- Only press the SOS button in an emergency.



Emergency Request not guaranteed

For technical reasons, the Emergency Request cannot be guaranteed under unfavorable conditions. ◀

Initiating an Emergency Request

1. Press the cover briefly to open it.



2. Press the SOS button until the LED in the button lights up.
- ▶ The LED lights up: an Emergency Request was initiated.

If the circumstances allow this, remain in the vehicle until the connection has been established.

- ▶ The LED flashes if the connection to the BMW Assist Response Center has been established.

Once the BMW Response Center has received your Emergency Request, the BMW Response Center contacts you and takes further steps to help you.

Even if you are unable to respond, the BMW Response Center can take further steps to help you under certain circumstances.

For this purpose, data that are used to determine the necessary rescue measures, such as the current position of the vehicle if it can be established, are transmitted to the BMW Response Center.

- ▶ If the LED is flashing but the BMW Response Center cannot be heard on the hands-free system, the hands-free system may be malfunctioning. However, the BMW Response Center may still be able to hear you.

Initiating an Emergency Request automatically

Under certain conditions, an Emergency Request is automatically initiated immediately after a severe accident. Automatic Collision Notification is not affected by pressing the SOS button.

Warning triangle

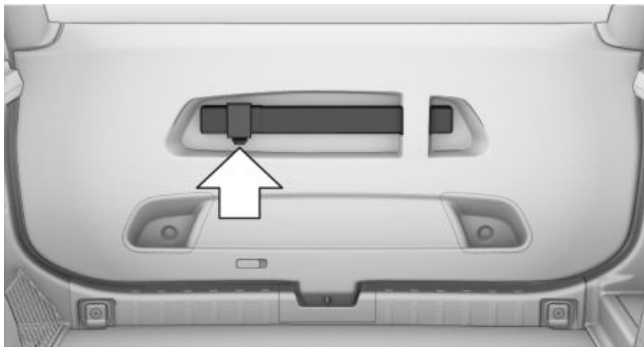

On the inside of the tailgate. To remove, press on the tab, arrow.

First aid kit

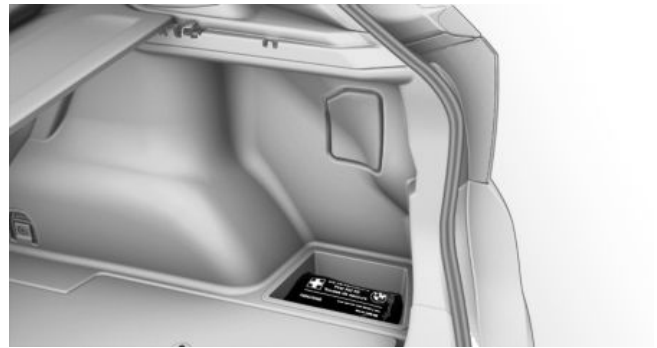

The first aid kit is located in a storage compartment on the right side in the cargo area.

Some of the articles contained in the first aid pouch have a limited service life.

Check the expiration dates of the contents regularly and replace any items promptly.

Jump-starting

Notes

If the battery is discharged, an engine can be started using the battery of another vehicle and two jumper cables. Only use jumper cables with fully insulated clamp handles.

To prevent personal injury or damage to both vehicles, adhere strictly to the following procedure.



Do not touch live parts

To avoid the risk of potentially fatal injury, always avoid all contact with electrical components while the engine is running. ◀

Preparation

1. Check whether the battery of the other vehicle has a voltage of 12 volts and approximately the same capacitance in Ah. This information can be found on the battery.
2. Switch off the engine of the assisting vehicle.
3. Switch off any electronic systems/power consumers in both vehicles.

-  Bodywork contact between vehicles
There must not be any contact between the bodies of the two vehicles, otherwise there is a danger of shorting.◀

Starting aid terminals

-  Connecting order
Connect the jumper cables in the correct order; otherwise, there is the danger of injury from sparking.◀

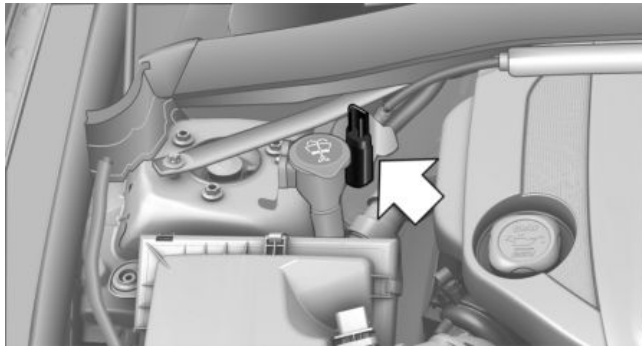

The so-called starting aid terminal in the engine compartment acts as the battery's positive terminal. Pull the cover up and off.

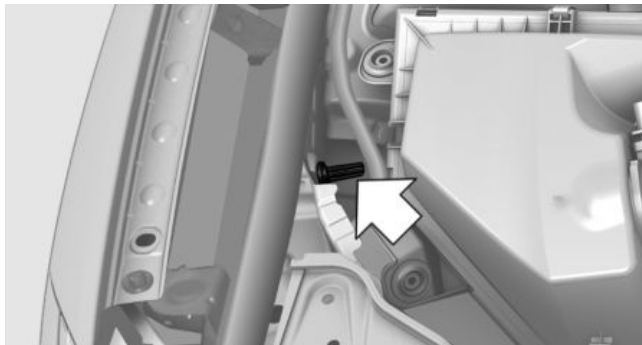

The body ground or a special nut acts as the negative terminal.

Connecting jumper cables

1. Pull off the cap of the BMW starting aid terminal.
2. Attach one terminal clamp of the positive jumper cable to the positive terminal of the battery, or to the corresponding starting

aid terminal of the vehicle providing assistance.

3. Attach the other end of the cable to the positive terminal of the battery, or to the corresponding starting aid terminal of the vehicle to be started.
4. Attach one terminal clamp of the negative jumper cable to the negative terminal of the battery, or to the corresponding engine or body ground of the vehicle providing assistance.
5. Attach the other end of the cable to the negative terminal of the battery, or to the corresponding engine or body ground of the vehicle to be started.

Starting the engine

Never use spray fluids to start the engine.



1. Start the engine of the assisting vehicle and let it run for several minutes at an increased idle speed.
2. Start the engine of the vehicle being started in the usual way.



If the first starting attempt is not successful, wait a few minutes before making another attempt in order to allow the discharged battery to recharge.

3. Let both engines run for several minutes.
4. Disconnect the jumper cables in the reverse order.

Check the battery and recharge if necessary.

Tow-starting and towing

-  Observe applicable laws and regulations
 Observe applicable laws and regulations for tow-starting and towing.◀

-  No additional passengers
 Do not transport any passengers other than the driver in a vehicle that is being towed.◀

Automatic transmission, 8-gear: transporting your vehicle

Note

Your vehicle is not permitted to be towed. Therefore, contact a service center in the event of a breakdown.

-  Do not have the vehicle towed
- Have your vehicle transported on a loading platform only; otherwise, damage may occur. ◀

Tow truck

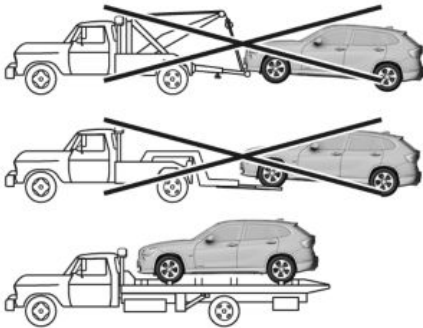



-  Do not lift the vehicle
- Do not lift the vehicle by the tow fitting or body and chassis parts; otherwise, damage may result. ◀

Use the tow fitting screwed in at the front for maneuvering the vehicle only.

Towing your vehicle

Observe before towing your vehicle

-  Light towing vehicle
- The towing vehicle must not be lighter than your vehicle, or it will not be possible to control vehicle response. ◀
-  Attaching the tow bar/tow rope correctly
- Attach the tow bar or tow rope to the tow fitting; connecting it to other vehicle parts may cause damage. ◀

Automatic transmission, 6-gear

Selector lever in position N.

-  Adhere to the towing speed and distance
- Do not exceed a towing speed of 40 mph/70 km/h and a towing distance of 90 miles/150 km or damage to the transmission can occur. ◀

Being towed

-  Follow the towing instructions
- Follow all towing instructions, or vehicle damage or accidents may occur. ◀

- ▶ Make sure that the ignition is switched on; otherwise, the low beams, tail lights, turn signals, and windshield wipers may be unavailable.
- ▶ Do not tow the vehicle with the rear axle tilted, as the front wheels could turn.
- ▶ When the engine is stopped, there is no power assist. Consequently, more force needs to be applied when braking and steering.
- ▶ Larger steering wheel movements are required.
- ▶ Switch on the hazard warning system, depending on local regulations.
- ▶ If the electrical system has failed, clearly identify the vehicle being towed by placing a sign or a warning triangle in the rear window.

Tow truck

sDrive

Vehicles with automatic transmission, 6-gear.

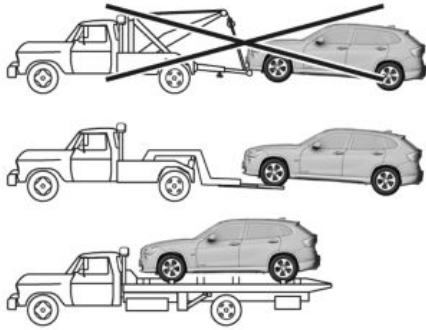

Have your vehicle transported with a tow truck with a so-called lift bar or on a flat bed.

xDrive

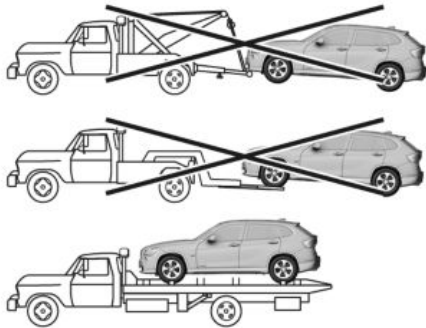

Towing a vehicle with xDrive

Do not tow a vehicle with xDrive with just the front or rear axle raised; otherwise, the wheels could lock up and the transfer case could be damaged. ◀

Towing other vehicles

General information



Light towing vehicle

Your vehicle must not be lighter than the vehicle being towed; otherwise, it will not be possible to control vehicle response. ◀



Attaching the tow bar/tow rope correctly

Attach the tow bar or tow rope to the tow fitting; connecting it to other vehicle parts may cause damage. ◀

- ▶ Switch on the hazard warning system, depending on local regulations.

- ▶ If the electrical system has failed, clearly identify the vehicle being towed by placing a sign or a warning triangle in the rear window.

Towing methods



Do not lift the vehicle

Do not lift the vehicle by the tow fitting or body and chassis parts; otherwise, damage may result. ◀

Tow bar

The tow fittings used should be on the same side on both vehicles.

Should it prove impossible to avoid mounting the tow bar at an offset angle, please observe the following:

- ▶ Clearance and maneuvering capability will be sharply limited during cornering.
- ▶ The tow bar will generate lateral forces if it is attached offset.

Tow rope

When starting to tow the vehicle, make sure that the tow rope is taut.

To avoid jerking and the associated stresses on the vehicle components when towing, always use nylon ropes or nylon straps.



Attaching the tow rope correctly

Only secure the tow rope on the tow fitting; otherwise, damage can occur when it is secured on other parts of the vehicle. ◀

Tow fitting

The screw-in tow fitting should always be carried in the vehicle. It can be screwed in at the front or rear of the BMW.

It is located in the tool kit under the cargo floor cover and storage compartment in the cargo area, refer to page 249.

It is stored with the tool kit under the cargo floor cover in the cargo area, refer to page 249.



Tow fitting, information on use

- ▷ Use only the tow fitting provided with the vehicle and screw it all the way in.
- ▷ Use the tow fitting for towing on paved roads only.
- ▷ Avoid lateral loading of the tow fitting, e.g., do not lift the vehicle by the tow fitting.

Otherwise, damage to the tow fitting and the vehicle can occur. ◀

Screw thread

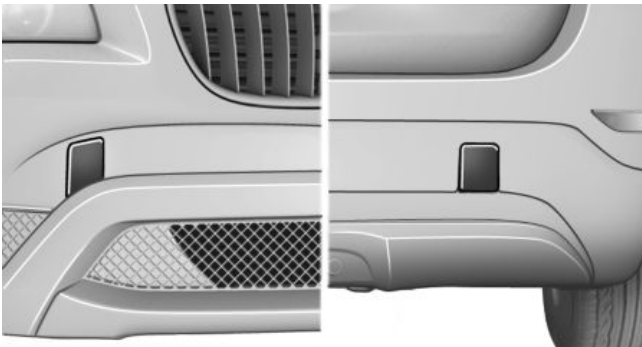

Press on the lower part of the cover. The cover is pushed out at the top edge and can be pulled out.

Tow-starting

Note

Do not tow-start your vehicle.

Due to the automatic transmission, the engine cannot be started by tow-starting.

Have the cause of the starting difficulties remedied.

Care

Vehicle equipment

This chapter describes all series equipment as well as country-specific and special equipment offered for this model series. Therefore, it also describes equipment that may not be found in your vehicle, for instance due to the selected special equipment or the country version. This also applies to safety-related functions and systems.

When using the features and systems described here, adhere to local regulations.

Car washes

Notes



Steam jets or high-pressure washers

When using steam jets or high-pressure washers, hold them a sufficient distance away and use a maximum temperature of 140 °F/60 °C.

Holding them too close or using excessively high pressures or temperatures can cause damage or preliminary damage that may then lead to long-term damage.

Follow the operating instructions for the high-pressure washer. ◀

Do not direct steam or high-pressure washers toward the decorative labels applied by the manufacturer; otherwise, damage may result.



Cleaning sensors/cameras with high-pressure washers

When using high-pressure washers, do not spray the exterior sensors and cameras, for Park Distance Control or the backup camera, for instance, for extended periods of time and only from a distance of at least 12 in/30 cm. ◀

Regularly remove foreign bodies, such as leaves, from the area below the windshield when the hood is open.

Wash your vehicle frequently, particularly in winter.

Intense soiling and road salt can damage the vehicle.

Washing in automatic car washes

Give preference to cloth car washes or those that use soft brushes in order to avoid paint damage.

Notes

Note the following:

- ▶ Make sure that the wheels and tires are not damaged by the transport mechanisms.
- ▶ Fold in the exterior mirrors; otherwise, they may be damaged, depending on the width of the vehicle.
- ▶ Deactivate the rain sensor, refer to page 65, to avoid unintentional wiper activation.
- ▶ Move the rear window wiper to its resting position, deactivate it, and protect it against damage. Ask the car wash operator about any necessary protective measures.
- ▶ Remove additional attachments, for instance a spoiler or telephone antenna, if there is a risk that these may be damaged.



Guide rails in car washes

Avoid car washes with guide rails higher than 4 in/10 cm; otherwise, the vehicle body could be damaged. ◀

Before driving into a car wash

The vehicle is able to roll if the following steps are taken.

Automatic transmission

1. Release the parking brake, refer to page 63.
2. Drive into the car wash.
3. Depress the brake pedal if necessary.
4. Engage the selector lever or transmission position N.
5. Switch the engine off.
6. Leave the remote control in the ignition lock so that the vehicle can roll.

In 8-gear automatic transmissions, transmission position P is engaged automatically:

- ▶ Automatically after approx. 30 minutes.
- ▶ When the remote control is removed from the ignition lock.

Headlights

- ▶ Do not rub dry and do not use abrasive or caustic cleansers.
- ▶ Soak areas that have been soiled e.g. due to insects, with shampoo and wash off with water.
- ▶ Thaw ice with de-icing spray; do not use an ice scraper.

After washing the vehicle

After washing the vehicle, apply the brakes briefly to dry them; otherwise, braking action can be reduced and corrosion of the brake discs can occur.

Fully remove any residue from the windows to prevent obstruction of view from streaking, wiping noises, and wiper wear.

Vehicle care

Car care products

BMW recommends using cleaning and care products from BMW, since these have been tested and approved.



Car care and cleaning products

Follow the instructions on the container.

When cleaning the interior, open the doors or windows.

Only use products intended for cleaning vehicles.

Cleansers can contain substances that are dangerous and harmful to your health. ◀

Vehicle paint

Regular care contributes to driving safety and value retention. Environmental influences in areas with high air pollution or natural contaminants, such as tree resin or pollen, can have an impact on the vehicle paint. Tailor the frequency and extent of your car care to these influences.

Immediately remove aggressive substances, such as spilled fuel, oil, grease, or bird droppings, to prevent damage to or discoloration of the paintwork.

Leather care

Remove dust from the leather often, using a cloth or vacuum cleaner.

Otherwise, particles of dust and road grime chafe in pores and folds, and lead to increased wear and premature degradation of the leather surface.

To guard against discoloration, such as from clothing, provide leather care roughly every two months.

Clean light-colored leather more frequently as dust and dirt are more noticeable.

Use leather care products; otherwise, dirt and grease will gradually break down the protective layer of the leather surface.

Suitable care products are available from the service center.

Upholstery material care

Vacuum regularly with a vacuum cleaner.

If they are very dirty, e.g., beverage stains, use a soft sponge or microfiber cloth with a suitable interior cleaner.

Clean the upholstery down to the seams using large sweeping motions. Avoid rubbing the material vigorously.



Damage from Velcro® fasteners

Open Velcro® fasteners on pants or other articles of clothing can damage the seat covers. Ensure that any Velcro® fasteners are closed. ◀

Caring for special components

Light-alloy wheels

When cleaning the wheels on the vehicle, only use a neutral wheel rim cleaner with a pH value of 5 to 9. Do not use abrasive cleaners or a steam jet hotter than 140 °F/60 °C; otherwise, damage may result. Adhere to the manufacturer instructions.

Aggressive, acidic, or alkaline cleaners may destroy the protective coating of neighboring components such as the brake disc.

Chrome surfaces

Carefully clean components such as the radiator grille or door handles with an ample supply of water, possibly with shampoo added, particularly when they have been exposed to road salt.

Rubber components

Aside from water, treat only with rubber cleansers.

When cleaning rubber seals, do not use any silicon-containing car care products in order to avoid damage or reduced noise damping.

Fine wood parts

Clean fine wood facing and fine wood components only with a moist rag. Then dry with a soft cloth.

Plastic components

These include:

- ▷ Imitation leather surfaces.
- ▷ Headliner.
- ▷ Lamp lenses.
- ▷ Instrument cluster cover.
- ▷ Matte black spray-coated components.
- ▷ Painted parts in the interior.

Clean with a microfiber cloth.

Moisten the cloth lightly with water if necessary.

Do not soak the headliner.



Do not use cleansers that contain alcohol or solvents

Do not use cleansers that contain alcohol or solvents, such as lacquer thinners, heavy-duty grease removers, fuel, or such; this could lead to surface damage. ◀

Safety belts

Dirty belt straps impede the reeling action and thus have a negative impact on safety.



No chemical cleaning

Do not clean chemically; this can destroy the webbing. ◀

Use only a mild soapy solution, with the safety belts clipped into their buckles.

Do not allow the reels to retract the safety belts until they are dry.

Carpets and floor mats



No objects in the area around the pedals

Keep floor mats, carpets, and any other objects out of the area of motion of the pedals; otherwise, the function of the pedals could be impeded while driving

Do not place additional floor mats over existing mats or other objects.

Only use floor mats that have been approved for the vehicle and can be properly fixed in place.

Ensure that the floor mats are securely fastened again when they are returned after being removed, such as for cleaning. ◀

Floor mats can be removed from the passenger compartment for cleaning.

When returning the floor mats, secure them again to prevent slipping.

If the floor carpets are very dirty, clean with a microfiber cloth and water or a textile cleaner. To prevent matting of the carpet, rub back and forth in the direction of travel only.

Sensors/cameras

To clean sensors or cameras, use a cloth moistened with a small amount of glass cleaner.

Displays/screens

Clean the displays with an anti-static microfiber cloth.



Cleaning displays

Do not use chemical or household cleansers.

Keep all fluids and moisture away from the unit.

Otherwise, they could affect or damage surfaces or electrical components.

Avoid pressing too hard when cleaning and do not use abrasive materials; otherwise, damage can result. ◀

Long-term vehicle storage

Your service center can advise you on what to consider when storing the vehicle for longer than three months.



Reference

This chapter contains technical data, short commands for the voice activation system, and an index that will quickly take you to the information you need.

Technical data

Vehicle equipment

This chapter describes all series equipment as well as country-specific and special equipment offered for this model series. Therefore, it also describes equipment that may not be found in your vehicle, for instance due to the selected special equipment or the country version. This also applies to safety-related functions and systems.

When using the features and systems described here, adhere to local regulations.

Note

The technical data and specifications in the Owner's Manual serve as guidelines. Detailed values can be obtained from your registration documents, from labels in your vehicle, or from the service center.

Dimensions

BMW X1		
Width without mirrors	inches/mm	70.8 / 1,798
Width with mirrors	inches/mm	81.0/2,058
Height	inches/mm	60.8/1,545
Length	inches/mm	176.5/4,484
Wheelbase	inches/mm	108.7/2,760
Smallest turning circle dia.	ft/m	37.1/11.3
Smallest turning circle dia. with all-wheel drive	ft/m	38.7/11.8

Weights

BMW X1		X1 sDrive28i	X1 xDrive28i	X1 xDrive35i
Approved gross vehicle weight	lbs/kg	4,497/2,040	4,707/2,135	4,861/2,205
Load	lbs/kg	904/410	904/410	904/410
Approved front axle load	lbs/kg	2,116/960	2,326/1,055	2,425/1,100

BMW X1		X1 sDrive28i	X1 xDrive28i	X1 xDrive35i
Approved rear axle load	lbs/kg	2,546/1,155	2,590/1,175	2,646/1,200
Approved roof load capacity	lbs/kg	165/75	165/75	165/75
Cargo area capacity	cu ft/liter	25.0-56.0/420-1,350	25.0-56.0/420-1,350	25.0-56.0/420-1,350

Capacities

BMW X1		Notes	
Fuel tank	US gal/liters	Approx. 16.6/63	Fuel specifications, refer to page 230

Short commands for voice activation system

Vehicle equipment

This chapter describes all series equipment as well as country-specific and special equipment offered for this model series. Therefore, it also describes equipment that may not be found in your vehicle, for instance due to the selected special equipment or the country version. This also applies to safety-related functions and systems.

When using the features and systems described here, adhere to local regulations.

General information

Instructions for voice activation system, refer to page 27.

To have the available spoken instructions read out loud: ›Voice commands‹

The following short commands apply to vehicles equipped with a voice activation system. They have no function in vehicles in which only the mobile phone is operated using the voice.

Adjusting

Vehicle

Function	Command
Opens the main menu.	›Main menu‹
Open the options.	›Options‹
Open the settings.	›Settings‹
Settings on the Control Display.	›Control display‹
Open the time and date.	›Time and date‹
Open the language and units.	›Language and units‹
Open the speed limit.	›Speed‹
Open the light.	›Lighting‹
Open the door lock.	›Door locks‹

Vehicle information

Computer

Function	Command
Open the computer.	›Onboard info‹
Open the trip computer.	›Trip computer‹

Vehicle

Function	Command
Open the vehicle information.	›Vehicle info‹
Open the vehicle status.	›Vehicle status‹

Navigation

General information

Function	Command
Navigation menu.	›Navigation‹
Open the destination entry.	›Enter address‹
Enter the address.	›Enter address‹
Enter the town/city.	›City‹
Enter the country.	›State‹
Enter the postal code.	›Postal Code‹
Open destination guidance.	›Guidance‹
Start destination guidance.	›Start guidance‹
Terminate destination guidance.	›Stop guidance‹
Open the home address.	›Home address‹
Open the route criteria.	›Route preference‹
Open the route.	›Route information‹
Switch on the spoken instruction.	›Switch on voice instructions‹

Function	Command
Repeat the spoken instruction.	›Repeat voice instructions‹
Switch off the spoken instruction.	›Switch off voice instructions‹
Display the address book.	›Address book‹
Display the most recent destinations.	›Last destinations‹
Open the traffic bulletins.	›Traffic Info‹
Points of Interest.	›Points of interest‹

Map

Function	Command
Display the map.	›Map‹
Map facing north.	›Map facing north‹
Map facing the direction of travel.	›Map in direction of travel‹
Perspective map.	›Map perspective view‹
Automatic scaling of the map.	›Map with automatic scaling‹
Scale...feet.	›Map scale ... feet‹
Scale...meters.	›Map scale ... meters‹ e.g., map scale 100 meters
Scale...kilometers.	›Map scale ... kilometers‹ e.g., map scale 5 kilometers
Scale...miles.	›Map scale ... miles‹ e.g., map scale 5 miles

Split screen settings

Function	Command
Split screen.	›Switch on splitscreen‹
Switch off the split screen.	›Turn off split screen‹
Adjust the split screen.	›Split screen content‹
Split screen, map facing north.	›Split screen map facing north‹
Split screen, current position.	›Split screen current position‹

Function	Command
Split screen, facing the direction of travel.	›Split screen map in direction of travel‹
Split screen, perspective.	›Split screen perspective‹
Split screen, expanded intersection zoom.	›Splitscreen Exit ramp view‹
Split screen scale...feet.	›Split screen scale ... feet‹ e.g., split screen scale 100 feet
Split screen scale...meters.	›Split screen scale ... meters‹ e.g., split screen scale 100 meters
Split screen scale...kilometers.	›Split screen scale ... kilometers‹ e.g., split screen scale 5 kilometers
Split screen scale...miles.	›Split screen scale ... miles‹ e.g., split screen scale 5 miles
Split screen, highlight the traffic situation.	›Split screen, Traffic conditions‹
Split screen, computer.	›Split screen on board info‹
Split screen, trip computer.	›Splitscreen trip computer‹
Split screen, scale automatically.	›Split screen automatic scaling‹

Destination guidance with intermediate destinations

Function	Command
Enter a new destination.	›Enter address‹
Trip list.	›Stored trips‹

Radio

FM

Function	Command
Open a frequency.	›Frequency ... megahertz‹ e.g., 93.5 megahertz or frequency 93.5
Open the radio.	›Radio‹
Open the FM stations.	›F M‹

Function	Command
Open the manual search.	›Manual‹
Select a frequency range.	›Select frequency‹
Open a station.	›Select station‹

AM

Function	Command
Open a frequency.	›Frequency ... Kiloherzt‹ e.g., frequency 753 or 753 kilohertz
Open the AM stations.	›A M‹
Open the manual search.	›Manual‹

Satellite radio

Function	Command
Open the satellite radio.	›Satellite radio‹
Switch on the satellite radio.	›Satellite radio on‹
Select a satellite radio channel.	›Select satellite radio‹, e.g., satellite radio channel 2

Stored stations

Function	Command
Open the stored stations.	›Presets‹
Choose a stored station.	›Select preset‹
Select a stored station.	›Preset ...‹ e.g., stored station 2

CD/multimedia

CD/DVD drive

Function	Command
Select a track.	›Track ...‹ e.g., track 5 or ›C D track ...‹ e. g., CD track 5
Play back a CD.	›C D on‹
Select a CD.	›Select C D‹
Select a CD and track.	›C D ... track ...‹ e.g., CD 3 track 5
Open the CD and Multimedia menu.	›C D and multimedia‹
CD and DVD.	›C D‹
Select a DVD.	›D V D ...‹ e.g., DVD 3
Display the entertainment details on a split screen.	›Entertainment details‹

Music collection

Function	Command
Search for music, open a menu.	›Music search‹
Open the current playback.	›Current playback‹
Open the music collection.	›Music collection‹
Play back the music collection.	›Music collection on‹
Play back the most frequently played tracks.	›Top fifty‹

External devices

Function	Command
Open the external devices.	›External devices‹
Open the Bluetooth devices.	›Bluetooth‹

Tone

Function	Command
Open the tone settings.	›Tone‹

Telephone

Function	Command
Dial a phone number.	›Dial number‹
Open the Telephone menu.	›Telephone‹
Display the phone book.	›Phonebook‹
Redialing.	›Redial‹
Display received calls.	›Received calls‹
List of messages.	›Messages‹
Open the Bluetooth devices.	›Bluetooth‹

Office

Function	Command
Open the Office menu.	›Office‹
Display Office Today.	›Current office‹
Display the contacts.	›Contacts‹
Display the messages.	›Messages‹
Display the calendar.	›Calendar‹
Display the tasks.	›Tasks‹
Display the reminders.	›Reminders‹

Contacts

Function	Command
Select a name.	›Choose name‹
My contacts.	›My contacts‹
Open the contacts.	›Contacts‹
New contact.	›New contact‹

ConnectedDrive or BMW Assist

Function	Command
Open BMW Assist.	›B M W Assist‹
Open ConnectedDrive.	›Connected Drive‹
Open BMW Online.	›B M W Online‹

Everything from A to Z

Index

A

- ABS, Antilock Brake System 99
- Accident, refer to Emergency Request, initiating 257
- Acoustic signal, refer to Check Control 82
- Activated charcoal filter with automatic climate control 113
- Adaptive brake lights, refer to Brake force display 98
- Adaptive Light Control 86
- Additional telephone 198
- Additives, coolant 246
- Additives, engine oil 245
- After washing vehicle 264
- Airbags 90
- Airbags, indicator/warning light 93
- Air circulation, refer to Recirculated air mode 112
- Air conditioning mode, automatic climate control 110
- Air conditioning mode, ventilation 113
- Air distribution, automatic 111
- Air distribution, manual 111
- Air drying, refer to Cooling function 112
- Air flow rate 112
- Airing, refer to Ventilation 113
- Air pressure, refer to Tire inflation pressure 232
- Air supply, automatic climate control 110
- Air supply, ventilation 113
- Air vents, refer to Ventilation 113
- Alarm system 41
- Alarm system, avoiding unintentional alarms 42
- Alarm system, ending an alarm 41
- Alarm system, interior motion sensor 42
- Alarm system, tilt alarm sensor 42
- All around the headliner 19
- ALL program 112
- All-season tires, refer to Winter tires 240
- All-wheel drive, refer to xDrive 101
- Alternating-code hand-held transmitter 116
- AM/FM station 168
- Announcement, navigation, see Spoken instructions 157
- Antifreeze, coolant 246
- Antifreeze, washer fluid 67
- Antilock Brake System, ABS 99
- Anti-slip control, refer to Dynamic Stability Control DSC 99
- Anti-theft protection 34
- Appointments 214
- Approved axle loads, refer to Weights 270
- Approved engine oils 245
- Approved gross vehicle weight, refer to Weights 270
- Armrest, refer to Center armrest 126
- Arrival time, refer to Computer 76
- Ashtray 119
- Assistance with driving off, refer to Drive-off assistant 102
- Assistance with starting engine, refer to Jump-starting 258
- Audio device, external 126
- Audio playback 177
- Audio playback, Bluetooth 189
- Automatic, air distribution 111
- Automatic, air flow rate 111
- Automatic car wash 263
- Automatic climate control 110
- Automatic climate control, automatic air distribution 111
- Automatic, cruise control 103
- Automatic Curb Monitor 51
- Automatic headlight control 86
- Automatic recirculated air control 112
- Automatic Start/Stop function 61
- Automatic transmission with Steptronic 67, 70
- Automatic transmission with Steptronic, interlock 67
- Automatic transmission with Steptronic, kickdown 68, 70
- Automatic transmission with Steptronic, overriding selector lever lock 69
- AUTO program with automatic climate control 111

AUX-IN port [186](#)
 Average fuel consumption [75](#)
 Average fuel consumption, setting the unit [77](#)
 Average speed [75](#)
 Average speed, refer to Computer [75](#)
 Axle loads, refer to Weights [270](#)

B

Backrest curvature, refer to Lumbar support [47](#)
 Backrests, refer to Seats [46](#)
 Backrest width adjustment [48](#)
 Back seats, adjusting the backrest tilt [121](#)
 Backup camera [107](#)
 Backup camera, obstacle marking [108](#)
 Backup camera, pathway lines [108](#)
 Backup camera, turning lines [108](#)
 Backup lamps, bulb replacement [254](#)
 Balance [166](#)
 Band-aids, refer to First aid kit [258](#)
 Bass [166](#)
 Battery disposal [256](#)
 Battery, refer to Vehicle battery [255](#)
 Battery, remote control [32](#)
 Battery replacement, remote control for vehicle [41](#)
 Before entering the car wash [263](#)
 Being towed [260](#)
 Belts, refer to Safety belts [48](#)
 Belt tensioners, refer to Safety belts [48](#)
 Beverage holder, refer to Cupholder [127](#)
 Black and white map display [160](#)
 Blower, refer to Air flow rate [112](#)
 Bluetooth audio [189](#)
 Bluetooth connection, activating/deactivating [199](#)
 BMW Apps [224](#)
 BMW Driver's Guide App [6](#)
 BMW EfficientDynamics, refer to Saving fuel [139](#)
 BMW Homepage [6](#)
 BMW Internet page [6](#)
 BMW maintenance system [247](#)
 BMW Online [222](#)
 Bottle holder, refer to Cupholder [127](#)
 Brake assistant [99](#)
 Brake discs, breaking in [132](#)
 Brake fluid, refer to Service requirements [80](#)
 Brake force display [98](#)
 Brake force distribution, electronic [99](#)
 Brake lamps, brake force display [98](#)
 Brake lamps, bulb replacement [254](#)
 Brake lights, adaptive [98](#)
 Brake pads, breaking in [132](#)
 Brake, refer to Parking brake [63](#)
 Brakes, BMW maintenance system [247](#)
 Brakes, service requirements [80](#)
 Brake system, BMW maintenance system [247](#)
 Braking, notes [133](#)
 Braking, parking brake [63](#)
 Breakdown assistance, refer to Roadside Assistance [221](#)
 Breakdown, transporting the vehicle [260](#)
 Breaking in [132](#)

Brightness on the Control Display [80](#)
 Bulb replacement, refer to Lamp and bulb replacement [250](#)
 Button for starting the engine, refer to Start/Stop button [59](#)

C

Calendar [214](#)
 California Proposition 65 Warning [7](#)
 Camera, care [266](#)
 Camera, refer to Backup camera [107](#)
 Can holder, refer to Cupholder [127](#)
 Car battery, refer to Vehicle battery [255](#)
 Car care products [264](#)
 Care [263](#)
 Care, displays [266](#)
 Care, vehicle [264](#)
 Cargo [136](#)
 Cargo area [120](#)
 Cargo area, capacities [270](#)
 Cargo area, Comfort Access [40](#)
 Cargo area, cover [120](#)
 Cargo area, enlarging [121](#)
 Cargo area, folding up the cargo floor panel [123](#)
 Cargo area lid, refer to Tailgate [38](#)
 Cargo area light, refer to Interior lights [89](#)
 Cargo area, multi-function hook [124](#)
 Cargo area, opening from the inside [38](#)
 Cargo area, opening from the outside [38](#)
 Cargo area, partition net [121](#)

- Cargo floor panel, folding up [123](#)
- Cargo floor panel, raising [123](#)
- Cargo net, refer to Partition net [121](#)
- Cargo straps, securing cargo [137](#)
- Car key, refer to Integrated key/remote control [32](#)
- Carpet, care [265](#)
- Car phone, installation location, refer to Center armrest [126](#)
- Car phone, refer to Telephone [198](#)
- Car vacuum cleaner, connecting, refer to Connecting electrical devices [119](#)
- Car wash [263](#)
- Catalytic converter, refer to Hot exhaust system [133](#)
- CBS Condition Based Service [247](#)
- CD/DVD [176](#)
- CD notes [180](#)
- CDs, storing [181](#)
- Cell phone, installation location, refer to Center armrest [126](#)
- Center armrest, front [126](#)
- Center armrest, rear [126](#)
- Center brake lamp, bulb replacement [255](#)
- Center console, refer to Around the center console [18](#)
- Central locking, Comfort Access [39](#)
- Central locking from the inside [37](#)
- Central locking from the outside [33](#)
- Central locking, setting the unlocking characteristics [34](#)
- Central screen, refer to Control Display [20](#)
- Changes, technical, refer to Safety [7](#)
- Changing wheels/tires [239](#)
- Check Control [82](#)
- Children, transporting [54](#)
- Child restraint fixing system LATCH [55](#)
- Child restraint fixing systems [54](#)
- Child restraint fixing systems, mounting [54](#)
- Child safety locks [57](#)
- Child seat, mounting [54](#)
- Child seats, refer to Transporting children safely [54](#)
- Chrome parts, care [265](#)
- Cigarette lighter, connecting electrical devices [119](#)
- Cigarette lighter, refer to Lighter [119](#)
- Cigarette lighter socket [119](#)
- Circulation of air, refer to Recirculated air mode [112](#)
- Cleaning, displays [266](#)
- Cleaning your BMW, refer to Care [263](#)
- Clock [73](#)
- Clock, 12h/24h format [78](#)
- Clock, setting the time and date [78](#)
- Clock, setting the time zone [78](#)
- Closing from the inside [37](#)
- Closing from the outside [34](#)
- Clothes hooks [127](#)
- Cockpit [14](#)
- Cold start, refer to Starting the engine [60](#)
- Combination instrument, refer to Instrument cluster [16](#)
- Combination switch, refer to Turn signal/high beams/headlamp flasher [64](#)
- Combination switch, refer to Washer/wiper system [64](#)
- Comfort Access [39](#)
- Comfort Access, battery replacement [41](#)
- Comfort area, refer to Around the center console [18](#)
- Compact wheel, inflation pressure [232](#)
- Compartment for remote control, refer to Ignition lock [59](#)
- Compartment in floor [123](#)
- Compartments, refer to Storage compartments [125](#)
- Compass, digital [117](#)
- Computer [75](#)
- Computer, displaying information [75](#)
- Computer, displays on the Control Display [76](#)
- Concierge service [221](#)
- Condensation under the vehicle [134](#)
- Condition Based Service CBS [247](#)
- Confirmation signals [35](#)
- Connecting, mobile phone, refer to Pairing the mobile phone [199](#)
- Consumption, refer to Average fuel consumption [75](#)
- Contacts [210](#)
- Control Display [20](#)
- Control Display, care [266](#)
- Control Display, settings [79](#)
- Controller [21](#)
- Controls and displays [14](#)
- Control systems, driving stability [99](#)
- Convenient operation, glass sunroof [34](#)
- Convenient operation, window [34](#)
- Coolant [246](#)
- Coolant, checking the level [246](#)
- Coolant temperature [74](#)

Cooling function, switching on and off [112](#)
 Cooling, maximum [111](#)
 Cooling system, refer to Coolant [246](#)
 Corrosion on brake discs [134](#)
 Courtesy lights, refer to Interior lights [89](#)
 Cradle for telephone or mobile phone, refer to Snap-in adapter [207](#)
 Cruise control [103](#)
 Cruise control, malfunction [105](#)
 Cupholder [127](#)
 Curb weight, refer to Weights [270](#)
 Current fuel consumption [74](#)
 Current location, storing [148](#)
 Curve lights, refer to Adaptive Light Control [86](#)

D

Dashboard lighting, refer to Instrument lighting [89](#)
 Dashboard, refer to Cockpit [14](#)
 Data, technical [270](#)
 Date, date format [79](#)
 Date, setting [78](#)
 Daytime running lights [86](#)
 Daytime running lights, bulb replacement [253](#)
 Defroster, rear window [113](#)
 Destination entry via the address book [148](#)
 Destination guidance [155](#)
 Destination guidance with intermediate destinations [153](#)
 Destination input, navigation [146](#)
 Digital clock [73](#)
 Digital compass [117](#)
 Digital radio [169](#)
 Dimming mirrors [52](#)
 Directional indicators, refer to Turn signals [64](#)
 Display lighting, refer to Instrument lighting [89](#)
 Displays and controls [14](#)
 Displays, care [266](#)
 Displays, cleaning [266](#)
 Displays, refer to Instrument cluster [16](#)
 Disposal, coolant [246](#)
 Disposal, vehicle battery [256](#)
 Distance warning, refer to Park Distance Control PDC [105](#)
 Divided rear seat backrest, refer to Cargo area, enlarging [121](#)
 Divided screen view, split screen [24](#)
 Door key, refer to Remote control with integrated key [32](#)
 Door lock [36](#)
 Doors, manual operation [37](#)
 Doors, unlocking and locking, confirmation signals [35](#)
 Doors, unlocking and locking from the inside [37](#)
 Doors, unlocking and locking from the outside [34](#)
 DOT Quality Grades [238](#)
 Downhill control [101](#)
 Draft-free ventilation [113](#)
 Drive-off assistant [102](#)
 Driving away on inclines, refer to Drive-off assistant [102](#)
 Driving notes, breaking in [132](#)
 Driving notes, general [132](#)
 Driving on poor roads [134](#)
 Driving stability control systems [99](#)
 Driving through water [133](#)
 Driving tips, refer to Driving notes [132](#)

Dry air, refer to Cooling function [112](#)
 DSC Dynamic Stability Control [99](#)
 DTC Dynamic Traction Control [100](#)
 DTMF suffix dialing [204](#)
 DVD/CD [176](#)
 DVDs, storing [181](#)
 DVD, video [178](#)
 Dynamic destination guidance [162](#)
 Dynamic Stability Control DSC [99](#)
 Dynamic Traction Control DTC [100](#)

E

ECO PRO [140](#)
 ECO PRO display [140](#)
 ECO PRO driving mode [140](#)
 ECO PRO mode [140](#)
 EfficientDynamics, refer to Saving fuel [139](#)
 Electrical malfunction, door lock [37](#)
 Electrical malfunction, driver's door [37](#)
 Electrical malfunction, fuel filler flap [229](#)
 Electrical malfunction, tailgate [38](#)
 Electric seat adjustment [47](#)
 Electronic brake-force distribution [99](#)
 Electronic engine oil level check [243](#)
 Electronic Stability Program ESP, refer to Dynamic Stability Control DSC [99](#)
 Emergency operation, automatic transmission, refer to Overriding selector lever lock [69](#)

- Emergency operation, door lock, refer to Manual operation [37](#)
- Emergency operation, fuel filler flap, unlocking manually [229](#)
- Emergency Request [257](#)
- Energy-conscious driving, refer to Current fuel consumption [74](#)
- Energy, saving, Automatic Start/Stop function [61](#)
- Energy, saving, refer to Saving fuel [139](#)
- Engine, breaking in [132](#)
- Engine compartment [242](#)
- Engine coolant, refer to Coolant [246](#)
- Engine oil, adding [245](#)
- Engine oil, additives, refer to Approved engine oils [245](#)
- Engine oil, alternative oil types [245](#)
- Engine oil, BMW maintenance system [247](#)
- Engine oil change intervals, refer to Service requirements [80](#)
- Engine oil, checking the level [243](#)
- Engine oil, filling capacity [271](#)
- Engine oil temperature [74](#)
- Engine oil types, alternative [245](#)
- Engine oil types, approved [245](#)
- Engine, overheating, refer to Coolant temperature [74](#)
- Engine start, assistance [258](#)
- Engine, starting [60](#)
- Engine, starting, Comfort Access [39](#)
- Engine, starting, Start/Stop button [59](#)
- Engine, stopping, Start/Stop button [59](#)
- Engine, switching off [61](#)
- Environmentally friendly driving, refer to Current fuel consumption [74](#)
- Equalizer [166](#)
- Equipment, interior [115](#)
- ESP Electronic Stability Program, refer to Dynamic Stability Control DSC [99](#)
- Exchanging wheels/tires [239](#)
- Exhaust system [133](#)
- Exterior mirrors [51](#)
- Exterior mirrors, adjusting [51](#)
- Exterior mirrors, automatic dimming [52](#)
- Exterior mirrors, automatic heating [52](#)
- Exterior mirrors, folding in and out [52](#)
- External audio device [126](#)
- External devices [186](#)
- External temperature display [73](#)
- External temperature display, changing the unit of measure [77](#)
- External temperature display, on computer [77](#)
- External temperature warning [73](#)
- Eyes for securing cargo [137](#)
- ## F
- Fader [166](#)
- Failure messages, refer to Check Control [82](#)
- False alarm, avoiding unintentional alarms [42](#)
- False alarm, ending an alarm [41](#)
- Fastening safety belts, refer to Safety belts [48](#)
- Fault messages, refer to Check Control [82](#)
- Filling capacities [271](#)
- Filter, refer to Microfilter/activated-charcoal filter with automatic climate control [113](#)
- Fine wood, care [265](#)
- First aid kit [258](#)
- Fitting for towing [261](#)
- Flashing when locking/unlocking [35](#)
- Flat Tire Monitor FTM [93](#)
- Flat Tire Monitor FTM, snow chains [241](#)
- Flat tire, run-flat tires [241](#)
- Flat tire, Tire Pressure Monitor TPM [95](#)
- Flat tire, warning light [94](#), [96](#)
- Flat tire, wheel change [255](#)
- Flooding, refer to Driving through water [133](#)
- Floor carpet, care [265](#)
- Floor mats, care [265](#)
- FM/AM station [168](#)
- Fog lamps, indicator lamp [88](#)
- Fog lights [88](#)
- Foldable rear seat backrest [121](#)
- Folding sun visor [119](#)
- Foot brake [133](#)
- Footwell lights, refer to Interior lights [89](#)
- For your own safety [7](#)
- Four-wheel drive, refer to xDrive [101](#)
- Front airbags [90](#)
- Front fog lights [88](#)
- Front passenger airbags, deactivating [91](#)
- FTM Flat Tire Monitor [93](#)
- Fuel [230](#)
- Fuel, additives [230](#)
- Fuel, average consumption [75](#)
- Fuel cap [228](#)
- Fuel cap, closing [228](#)

Fuel consumption display, average fuel consumption [75](#)
 Fuel consumption display, current fuel consumption [74](#)
 Fuel-efficient driving, refer to Current fuel consumption [74](#)
 Fuel filler flap [228](#)
 Fuel filler flap, closing [228](#)
 Fuel filler flap, opening [228](#)
 Fuel filler flap, unlocking in case of an electrical malfunction [229](#)
 Fuel gauge [74](#)
 Fuel, refer to Average fuel consumption [75](#)
 Fuel, saving [139](#)
 Fuel tank capacity, refer to Filling capacities [271](#)
 Fuel tank contents, refer to Filling capacities [271](#)
 Fuel tank, refer to Filling capacities [271](#)
 Fuse [256](#)

G

Garage door opener, refer to Integrated universal remote control [115](#)
 Gasoline [230](#)
 Gasoline gauge, refer to Fuel gauge [74](#)
 Gas station recommendation [157](#)
 Gear change, automatic transmission with Steptronic [68](#), [71](#)
 Gear change, via shift paddles [71](#)
 Gear display, automatic transmission with Steptronic [67](#)
 General driving notes [132](#)
 Glare protection [119](#)

Glass sunroof, electric, operation [34](#)
 Glass sunroof, refer to Panoramic glass sunroof [44](#)
 Glove compartment [125](#)
 Glove compartment, lighting [125](#)
 GPS navigation, refer to Navigation system [144](#)
 Gross vehicle weight, refer to Weights [270](#)

H

Halogen headlamps, bulb replacement [251](#)
 Handbrake, refer to Parking brake [63](#)
 Hand-held transmitter, alternating code [116](#)
 Hands-free microphone [18](#)
 Hazard warning system [257](#)
 HDC Hill Descent Control [101](#)
 HD Radio [169](#)
 Head airbags [90](#)
 Headlamp control, refer to Parking lamps/low beams [85](#)
 Headlamp flasher [64](#)
 Headlamps, bulb replacement [251](#)
 Headlamps, care [264](#)
 Headlamps, cleaning [66](#)
 Headlight control, automatic [86](#)
 Headlight courtesy delay feature [86](#)
 Headlight cover, removing [251](#)
 Headlight flasher, indicator lamp [17](#)
 Headlights [85](#)
 Headlights, cleaning, washer fluid [67](#)
 Headliner [19](#)

Head restraints [49](#)
 Head restraints, adjusting the height [49](#)
 Head restraints, removing [50](#)
 Heatable mirrors [52](#)
 Heatable rear window [113](#)
 Heatable seats [48](#)
 Heating, mirrors [52](#)
 Heating, seats [48](#)
 Heavy cargo, refer to Stowing cargo [137](#)
 Height adjustment, seats [46](#)
 Height, refer to Dimensions [270](#)
 High-beam Assistant [87](#)
 High-beams [87](#)
 High beams/low beams, automatic, refer to High-beam Assistant [87](#)
 High beams, bulb replacement [251](#)
 High-beams, indicator lamp [17](#)
 High-pressure washers [263](#)
 Hill Descent Control HDC [101](#)
 Hill drive-off assistant, refer to Drive-off assistant [102](#)
 Hills [134](#)
 Holder for beverages [127](#)
 Holder for remote control, refer to Ignition lock [59](#)
 Homepage [6](#)
 Hood [243](#)
 Hood, opening [243](#)
 Horn [14](#)
 Hot exhaust system [133](#)
 Hotline [223](#)
 House number, entering for navigation [147](#)
 Hydraulic brake assistant [99](#)
 Hydroplaning [133](#)

- I**
- Ice warning, refer to External temperature warning [73](#)
 - Icy roads, refer to External temperature warning [73](#)
 - Identification marks, tires [237](#)
 - Identification number, refer to Engine compartment [242](#)
 - iDrive [20](#)
 - iDrive, changing settings [79](#)
 - iDrive, changing the date and time [78](#)
 - iDrive, changing the language [79](#)
 - iDrive, changing the units of measure and display format [77](#)
 - iDrive, setting the brightness [80](#)
 - Ignition [60](#)
 - Ignition key position 1, refer to Radio ready state [59](#)
 - Ignition key position 2, refer to Ignition on [60](#)
 - Ignition key, refer to Remote control with integrated key [32](#)
 - Ignition lock [59](#)
 - Ignition, switched off [60](#)
 - Ignition, switched on [60](#)
 - Indication of a flat tire [94](#), [96](#)
 - Indicator and warning lights [17](#)
 - Individual settings, refer to Personal Profile [32](#)
 - Inflation pressure monitor, refer to Flat Tire Monitor [93](#)
 - Inflation pressure, refer to Tire inflation pressure [232](#)
 - Information on the navigation data [144](#)
 - Initialization after power failure [256](#)
 - Initializing
 - Refer to Setting the time and date [78](#)
 - Initializing, compass, refer to Calibrating [118](#)
 - Initializing, Flat Tire Monitor FTM [93](#)
 - Initializing panoramic glass sunroof [45](#)
 - Initializing, Tire Pressure Monitor TPM [96](#)
 - Inside brake lamps, bulb replacement [254](#)
 - Installation location, telephone [126](#)
 - Instrument cluster [16](#)
 - Instrument lighting [89](#)
 - Instrument panel, refer to Instrument cluster [16](#)
 - Instruments, refer to Cockpit [14](#)
 - Integrated key [32](#)
 - Integrated universal remote control [115](#)
 - Interactive map [151](#)
 - Interior equipment [115](#)
 - Interior lights [89](#)
 - Interior lights, remote control [35](#)
 - Interior mirror [52](#)
 - Interior motion sensor [42](#)
 - Interior rearview mirror, automatic dimming [52](#)
 - Interior rearview mirror, compass [117](#)
 - Interior temperature, setting, automatic climate control [110](#)
 - Interlock, refer to Disengaging the remote control [67](#)
 - Intermediate destinations [153](#)
 - Internet page [6](#)
 - Intersection, entering for navigation [147](#)
- J**
- Jacking points for the vehicle jack [255](#)
 - Jack, refer to Vehicle jack [255](#)
 - Joystick, refer to Selector lever [70](#)
 - Jump-starting [258](#)
- K**
- Keyless Go, refer to Comfort Access [39](#)
 - Keyless opening and closing, refer to Comfort Access [39](#)
 - Key Memory, refer to Personal Profile [32](#)
 - Key, refer to Integrated key/remote control [32](#)
 - Kickdown, automatic transmission with Steptronic [68](#), [70](#)
 - Knee airbag [90](#)
 - Knocking control [230](#)
- L**
- Label, run-flat tire [241](#)
 - Lamp and bulb replacement, light replacement [250](#)
 - Lamps [85](#)
 - Lamps, automatic headlight control [86](#)
 - Lamps, High-beam Assistant [87](#)
 - Lamps, replacing, refer to Lamp and bulb replacement [250](#)
 - Language, changing on the Control Display [79](#)
 - Lap-and-shoulder belt, refer to Safety belts [48](#)
 - Lashing eyes, securing cargo [137](#)

- LATCH child restraint fixing system [55](#)
- Leather, care [264](#)
- LEDs, light-emitting diodes [250](#)
- Length, refer to Dimensions [270](#)
- Letters and numbers, entering [25](#)
- License plate lamp, bulb replacement [255](#)
- Light-alloy wheels, care [265](#)
- Light-emitting diodes, LEDs [250](#)
- Lighter [119](#)
- Lighting
- Instruments [89](#)
- Lighting, light and bulb replacement [250](#)
- Lighting, vehicle, refer to Lamps [85](#)
- Lights, parking lamps/low beams [85](#)
- Light switch [85](#)
- Limit, refer to Speed limit [83](#)
- Load [137](#)
- Loading [136](#)
- Lock buttons, doors, refer to Locking [37](#)
- Locking from the inside [37](#)
- Locking from the outside [34](#)
- Locking, setting the confirmation signals [35](#)
- Locking the vehicle from the inside [37](#)
- Locking without remote control, refer to Comfort Access [39](#)
- Locks, doors, and windows [57](#)
- Longlife oils, alternative oil types [245](#)
- Longlife oils, refer to Approved engine oils [245](#)
- Low beams [85](#)
- Low beams, automatic [86](#)
- Low beams, automatic, refer to High-beam Assistant [87](#)
- Low beams, bulb replacement [251](#)
- Lower back support, refer to Lumbar support [47](#)
- Luggage rack, rear luggage rack [138](#)
- Luggage rack, refer to Roof-mounted luggage rack [138](#)
- Lumbar support [47](#)
- ## M
- Main inspection, refer to Service requirements [80](#)
- Maintenance [247](#)
- Maintenance, refer to Service booklet
- Maintenance, refer to Service requirements [80](#)
- Maintenance requirements [247](#)
- Maintenance system
- BMW [247](#)
- Makeup mirror [119](#)
- Malfunction, automatic transmission with Steptronic [69](#)
- Malfunction, door lock [37](#)
- Malfunction, fuel filler flap [229](#)
- Malfunction, tailgate [38](#)
- Malfunction warnings, refer to Check Control [82](#)
- Manual air distribution [111](#)
- Manual mode, automatic transmission with Steptronic [68](#), [71](#)
- Manual operation, door lock [37](#)
- Manual operation, driver's door [37](#)
- Manual operation, fuel filler flap [229](#)
- Manual operation, selector lever lock, automatic transmission [69](#)
- Manual seat adjustment [46](#)
- Map, destination entry [151](#)
- Map display in black and white [160](#)
- Map in split screen [159](#)
- Map view [157](#)
- Marking on approved tires [240](#)
- Master key, refer to Remote control with integrated key [32](#)
- Maximum cooling [111](#)
- Maximum speed, winter tires [240](#)
- Medical kit, refer to First aid kit [258](#)
- Memory, refer to Seat and mirror memory [50](#)
- Menus, operating, iDrive [20](#)
- Menus, refer to iDrive operating concept [21](#)
- Message list, traffic bulletins [159](#)
- Messages [212](#)
- Microfilter, with automatic climate control [113](#)
- Minimum tread, tires [239](#)
- Mirror, memory, refer to Seat and mirror memory [50](#)
- Mirrors [51](#)
- Mirrors
- Automatic Curb Monitor [51](#)
- Mirrors, folding in and out [52](#)
- Mirrors, heating [52](#)
- Mirrors, interior mirror [52](#)
- Mobile communication devices in the vehicle [133](#)
- Mobile phone, installation location, refer to Center armrest [126](#)
- Mobile phone, refer to Telephone [198](#)
- Modifications, technical, refer to Safety [7](#)

Monitor, refer to Control Display 20
Mounting of child restraint fixing systems 54
MP3 player 186
Multimedia 176
Music collection 181
Music search 183
Music, storing 181

N

Navigation 144
Navigation data 144
Navigation data, updating 144
Navigation system, destination entry by voice 152
Neck restraints, refer to Head restraints 49
Nets, refer to Storage compartments 127
Neutral cleaner, care 265
New wheels and tires 239
Notes 6, 215
Nozzles, refer to Ventilation 113

O

OBD Onboard Diagnostics 248
OBD socket, refer to Socket for OBD Onboard Diagnosis 248
Octane number, refer to Fuel quality 230
Octane rating, refer to Recommended fuel grade 230
Odometer 73
Office 209
Oil additives 245
Oil consumption 243
Oil, refer to Engine oil 243
Oil types, alternative 245
Oil types, approved 245

Old batteries, disposal 256
Onboard Diagnostics OBD 248
Onboard monitor, refer to Control Display 20
Onboard vehicle tool kit 249
Opening and closing, Comfort Access 39
Opening and closing from the inside 37
Opening and closing from the outside 34
Opening and closing using the door lock 36
Opening and closing using the remote control 34
Operating concept, iDrive 20
Outside-air mode, automatic climate control 112
Outside air, refer to Recirculated air mode 112
Overheating of engine, refer to Coolant temperature 74

P

Paint, vehicle 264
Pairing, mobile phone 199
Panic mode 35
Panoramic glass sunroof 44
Panoramic glass sunroof, convenient operation 34
Panoramic glass sunroof, initializing 45
Panoramic glass sunroof, opening/closing 44
Panoramic glass sunroof, pinch protection 45
Panoramic glass sunroof, power failure 45
Panoramic glass sunroof, remote control 34
Panoramic glass sunroof, tilting 44
Park Distance Control PDC 105

Parked-car ventilation 113
Parked vehicle, condensation 134
Parking aid, refer to Park Distance Control PDC 105
Parking assistant, refer to Park Distance Control PDC 105
Parking brake 63
Parking lamps 85
Parking lamps/low beams 85
Parking lights, bulb replacement 252
Partition net 121
Passenger side mirror, tilting 51
PDC Park Distance Control 105
Performance Control 101
Personal information 209
Personal Profile 32
Pinch protection, panoramic glass sunroof 45
Pinch protection, windows 43
Plastic, care 265
Pollen, refer to Microfilter/activated-charcoal filter with automatic climate control 113
Poor road operation 134
Position, storing 148
Postal code, entering in navigation 147
Power failure 256
Power windows, opening and closing 43
Power windows, refer to Windows 42
Power windows, safety switch 43
Prescribed engine oils, refer to Approved engine oils 245
Pressure, tires 232
Pressure warning, tires 93

Profile depth, refer to Minimum tread depth [239](#)
Profile, tires [238](#)
Programmable memory buttons, iDrive [24](#)
Protection function, refer to Pinch protection, panoramic glass sunroof [45](#)
Protective function, refer to Pinch protection system, windows [43](#)
Push-and-turn switch, refer to Controller [21](#)

R

Radiator fluid, refer to Coolant [246](#)
Radio-operated key, refer to Remote control with integrated key [32](#)
Radio ready state [59](#)
Radio ready state, switched off [60](#)
Radio ready state, switched on [59](#)
Radio setting, refer to Radio ready state [59](#)
Rain sensor [65](#)
Random [177](#)
Random playback [177](#)
Range [75](#)
RDS [169](#)
Reading lights [89](#)
Reading out loud [216](#)
Rear lights, refer to Tail lights [253](#)
Rear luggage rack [138](#)
Rear seat backrest, foldable [121](#)
Rear seats, adjusting the backrest tilt [121](#)
Rear seats, adjusting the head restraints [50](#)
Rear seats, folding down [121](#)
Rear seats, folding down the backrests [121](#)
Rear socket [120](#)
Rearview camera, cleaning [109](#)
Rearview mirror, refer to Mirrors [51](#)
Rear window defroster [113](#)
Rear window, washing [66](#)
Rear window wiper [66](#)
Recirculated air mode [112](#)
Recommended fuel grade [230](#)
Recommended tire brands [240](#)
Redialing [205](#)
Refueling [228](#)
Remaining distance to destination, refer to Computer [76](#)
Remaining range for service, refer to Service requirements [80](#)
Remaining range, refer to Range [75](#)
Reminders [216](#)
Remote app [225](#)
Remote control [32](#)
Remote control, battery replacement [41](#)
Remote control, Comfort Access [39](#)
Remote control, garage door opener [115](#)
Remote control, malfunction [36](#)
Remote control, removing from the ignition lock [59](#)
Remote control, service data [247](#)
Remote control, tailgate [35](#)
Remote control, universal [115](#)
Remote inquiry [204](#)
Remote Services [225](#)
Replacement fuse [256](#)
Replacement remote control [32](#)
Replacing wheels/tires [239](#)
Reporting safety defects [9](#)
Reserve warning, refer to Fuel gauge [74](#)
Reservoir for washer fluid, refer to Washer fluid reservoir [67](#)
Resetting, Tire Pressure Monitor TPM [96](#)
Restraining systems, refer to Safety belts [48](#)
Restraint systems for children [54](#)
Retaining straps, securing cargo [137](#)
Retreaded tires [240](#)
Reverse gear, automatic transmission with Steptronic [68](#)
Rim cleaner, care [265](#)
Road, avoiding [155](#)
Road detour [155](#)
Roadside Assistance [221](#)
Roadside parking lamp, bulb replacement [253](#)
Roadside parking lights [87](#)
RON recommended fuel grade [230](#)
RON, refer to Fuel quality [230](#)
Roof load capacity [270](#)
Roof-mounted luggage rack [138](#)
Rope, refer to Towing [261](#)
Route [156](#)
Route criteria, route [155](#)
Route, displaying [156](#)
Route section, bypassing [156](#)
RSC Runflat System Component, refer to Run-flat tires [241](#)
Rubber components, care [265](#)

Run-flat tires [241](#)
Run-flat tires, tire inflation pressure [232](#)

S

Safe braking [133](#)
Safety [7](#)
Safety belts, care [265](#)
Safety belts, damage [49](#)
Safety belts, indicator/warning lamp [49](#)
Safety belts, reminder [49](#)
Safety switch for rear windows [43](#)
Safety systems, airbags [90](#)
Safety systems, safety belts [48](#)
Safety tires, refer to Run-flat tires [241](#)
Satellite radio [170](#)
Saving fuel [139](#)
Scale, changing during navigation [158](#)
Screen, refer to Control Display [20](#)
Search, refer to BMW Online [222](#)
Seat adjustment, electric [47](#)
Seat adjustment, manual [46](#)
Seat and mirror memory [50](#)
Seat belts [48](#)
Seat heating [48](#)
Seats [46](#)
Seats, adjusting [46](#)
Seats, memory, refer to Seat and mirror memory [50](#)
Seats, sitting safely [46](#)
Selector lever, automatic transmission with Steptronic [68](#), [70](#)
Selector lever lock, overriding [69](#)
Selector lever lock, refer to Changing the selector lever positions, shiftlock [68](#)
Selector lever lock, releasing [70](#)
Selector lever positions, automatic transmission with Steptronic [68](#)
Sensors, care [266](#)
Service and warranty [8](#)
Service data in the remote control [247](#)
Service interval display, refer to Condition Based Service CBS [247](#)
Service interval display, refer to Service requirements [80](#)
Service requirements [80](#)
Service requirements, CBS Condition Based Service [247](#)
Services, remote [225](#)
Servotronic [102](#)
Settings and information [76](#)
Settings, changing on the Control Display [79](#)
Settings, clock, 12h/24h mode [78](#)
Settings, DVD [179](#)
Settings, language [79](#)
Settings, refer to Personal Profile [32](#)
Shifting, automatic transmission with Steptronic [68](#), [71](#)
Shift lever, automatic transmission with Steptronic [68](#)
Shift paddles [71](#)
Shift paddles on the steering wheel [69](#)
Short commands, voice activation [272](#)
Side airbags [90](#)
Side windows, refer to Windows [42](#)
Sitting safely [46](#)
Size, refer to Dimensions [270](#)
Ski bag, refer to Ski and snowboard bag [124](#)
Slide/tilt glass roof, refer to Panoramic glass sunroof [44](#)
Slot for remote control [59](#)
Smokers' package, refer to Ashtray [119](#)
Snap-in adapter, mobile phone [207](#)
Snap-in adapter, refer to Storage compartment of center armrest [126](#)
Snow chains [241](#)
Socket, OBD Onboard Diagnosis [248](#)
Socket, refer to Connecting electrical devices [119](#)
Software applications, iPhone [224](#)
Software part number [198](#)
Software update [193](#)
SOS, refer to Emergency Request, initiating [257](#)
Spare fuse [256](#)
Special destinations, navigation [149](#)
Special equipment, series equipment [6](#)
Speed, average [75](#)
Speed limit [83](#)
Speed limit, setting [84](#)
Speedometer [16](#)
Speed, with winter tires [240](#)
Split screen [24](#)
Split screen map settings [159](#)
Spoken instructions, navigation [157](#)
Sport program, automatic transmission with Steptronic [68](#), [71](#)
Spray nozzles, refer to Cleaning the windshield and headlamps [66](#)
Spray nozzles, refer to Windshield washer nozzles [66](#)
Stability control systems [99](#)
Start/Stop button [59](#)

- Start/Stop button, starting the engine [60](#)
- Start/Stop button, switching off the engine [61](#)
- Starting the engine [60](#)
- Start problems, refer to Jump-starting [258](#)
- State/province, selecting for navigation [146](#)
- Stations, stored [174](#)
- Station, storing [168](#)
- Status information, iDrive [23](#)
- Status of Owner's Manual [6](#)
- Steam jets [263](#)
- Steering wheel [53](#)
- Steering wheel, adjusting [53](#)
- Steering wheel lock [59](#)
- Steering wheel, shift paddles [69](#)
- Steptronic, refer to Automatic transmission with Steptronic [67](#)
- Steptronic, refer to Sport program and manual mode M/S [71](#)
- Stopping, engine [61](#)
- Storage compartment nets [127](#)
- Storage compartments [125](#)
- Storage, tires [241](#)
- Storing the vehicle [266](#)
- Street, entering for navigation [147](#)
- Summer tires, refer to Wheels and tires [232](#)
- Summer tires, tread [238](#)
- Sun visor [119](#)
- Switches, refer to Cockpit [14](#)
- Switching off, engine [61](#)
- Switching off, vehicle [61](#)
- Switch-on times, parked-car ventilation [114](#)
- Symbols [6](#)
- ## T
- Tachometer [74](#)
- Tailgate [38](#)
- Tailgate, Comfort Access [40](#)
- Tailgate emergency operation, refer to Opening manually [38](#)
- Tailgate, opening from the inside [38](#)
- Tailgate, opening from the outside [38](#)
- Tailgate, opening manually [38](#)
- Tailgate, remote control [35](#)
- Tail lamp, bulb replacement [255](#)
- Tail lamps, bulb replacement [254](#)
- Tail lights [253](#)
- Tank gauge, refer to Fuel gauge [74](#)
- Tasks [215](#)
- Technical changes, refer to Safety [7](#)
- Technical data [270](#)
- Telephone [198](#)
- Telephone, adjusting the volume [202](#)
- Telephone, installation location, refer to Center armrest [126](#)
- TeleService [221](#)
- Temperature, automatic climate control [111](#)
- Temperature, changing the unit of measure [77](#)
- Temperature, coolant, refer to Coolant temperature [74](#)
- Temperature display – External temperature warning [73](#)
- Temperature display, external temperature [73](#)
- Temperature display, setting the units [77](#)
- Temperature, engine oil [74](#)
- Temperature warning [73](#)
- Text messages [212](#)
- Theft alarm system, refer to Alarm system [41](#)
- Thigh support adjustment [47](#)
- Third brake lamp, refer to Center brake lamp [255](#)
- Tilt alarm sensor [42](#)
- Tilting the passenger side mirror [51](#)
- Time, setting the time [77](#)
- Tire age [237](#)
- Tire identification marks [237](#)
- Tire inflation pressure [232](#)
- Tire inflation pressure, checking [232](#)
- Tire pressure monitor, refer to Flat Tire Monitor [93](#)
- Tire Pressure Monitor TPM [95](#)
- Tire Quality Grading [238](#)
- Tires, breaking in [132](#)
- Tires, changing [239](#)
- Tires, condition [238](#)
- Tires, damage [239](#)
- Tire size [237](#)
- Tires, minimum tread [239](#)
- Tires, retreaded tires [240](#)
- Tires, run-flat tires [241](#)
- Tires, storage [241](#)
- Tire tread [238](#)
- Toll roads, route [155](#)
- Tone [166](#)
- Tool kit, refer to Onboard vehicle tool kit [249](#)
- Tools, refer to Onboard vehicle tool kit [249](#)
- Tow bar [261](#)
- Tow fitting [261](#)
- Towing [259](#)
- Towing with automatic transmission [260](#)
- Town/city, navigation [147](#)
- Tow rope [261](#)
- Tow-starting [262](#)

- TPM Tire Pressure Monitor [95](#)
- Traction control [100](#)
- Traffic bulletins, navigation [159](#)
- Transmission, automatic transmission with Steptronic [67, 70](#)
- Transmission lock, refer to Changing the selector lever positions [68](#)
- Transmission lock, refer to P Park [68](#)
- Transmission, overriding selector lever lock in case of automatic transmission with Steptronic [69](#)
- Transmission positions, automatic transmission with Steptronic [70](#)
- Transporting children safely [54](#)
- Treble, tone [166](#)
- Trip computer, refer to Displays on the Control Display [76](#)
- Trip-distance counter, refer to Trip odometer [73](#)
- Triple turn signal activation [64](#)
- Trip odometer [73](#)
- Trips, planning [153](#)
- Trunk, refer to Cargo area [120](#)
- Turning circle, refer to Dimensions [270](#)
- Turning lamps, refer to Adaptive Light Control [86](#)
- Turn signal, bulb replacement [253](#)
- Turn signal, indicator/warning lamp [16](#)
- Turn signals [64](#)
- Turn signals, bulb replacement, front [253](#)
- Turn signals, triple turn signal activation [64](#)
- ## U
- Uniform Tire Quality Grading/UTQG [238](#)
- Unintentional alarms [42](#)
- Units, average fuel consumption [77](#)
- Units of measure, changing on the Control Display [77](#)
- Units, temperature [77](#)
- Universal remote control [115](#)
- Unlocking, from the inside [37](#)
- Unlocking, from the outside [34](#)
- Unlocking, hood [243](#)
- Unlocking, setting the unlocking characteristics [34](#)
- Unlocking the tailgate [40](#)
- Unlocking without remote control, refer to Comfort Access [39](#)
- Updates made after the editorial deadline [6](#)
- Update, software [193](#)
- Upholstery care [264](#)
- USB audio interface [187](#)
- USB interface [125](#)
- ## V
- Vacuum cleaner, connecting, refer to Connecting electrical devices [119](#)
- Vanity mirror [119](#)
- Vehicle battery, changing [255](#)
- Vehicle, breaking in [132](#)
- Vehicle care [264](#)
- Vehicle care, refer to Care [263](#)
- Vehicle equipment [6](#)
- Vehicle identification number [198](#)
- Vehicle identification number, refer to Identification number in the engine compartment [242](#)
- Vehicle jack [255](#)
- Vehicle paint [264](#)
- Vehicle storage [266](#)
- Vehicle, switching off [61](#)
- Vehicle wash [263](#)
- Ventilation [113](#)
- Ventilation, draft-free [113](#)
- Ventilation, refer to Parked-car ventilation [113](#)
- Version of the navigation data [144](#)
- Video playback [178](#)
- Voice activation, navigation [152](#)
- Voice activation, short commands [272](#)
- Voice activation system [27](#)
- Volume, setting [166](#)
- ## W
- Warning and indicator lamps [17](#)
- Warning messages, refer to Check Control [82](#)
- Warning signal volumes [167](#)
- Warning triangle [258](#)
- Washer/wiper system [64](#)
- Washer/wiper system, rain sensor [65](#)
- Washer/wiper system, washer fluid [67](#)
- Washer/wiper system, windshield washer nozzles [66](#)
- Washer fluid [67](#)
- Washer fluid reservoir [67](#)
- Washing, vehicle [263](#)
- Waste tray, refer to Ash-tray [119](#)
- Water on roads, refer to Driving through water [133](#)
- Weights [270](#)

- Welcome lights [85](#)
- Wheelbase, refer to Dimensions [270](#)
- Wheel change [255](#)
- Wheels and tires [232](#)
- Wheels, changing [239](#)
- Wheels, Flat Tire Monitor FTM [93](#)
- Wheels, Tire Pressure Monitor TPM [95](#)
- Width, refer to Dimensions [270](#)
- Window, convenient operation [34](#)
- Windows [42](#)
- Windows, defrosting and defogging, automatic climate control [112](#)
- Windows, pinch protection [43](#)
- Windows, safety switch [43](#)
- Windshield, cleaning [66](#)
- Windshield, defrosting, refer to Defrosting windows [112](#)
- Windshield wash [64](#)
- Windshield washer fluid [67](#)
- Windshield wash, rear window [66](#)
- Windshield wash, reservoir for washer fluid [67](#)
- Windshield wash, washer fluid [67](#)
- Windshield wash, washer nozzles [66](#)
- Windshield wiper blades, changing [249](#)
- Windshield wiper, refer to Washer/wiper system [64](#)
- Winter storage, care [266](#)
- Winter tires, setting the speed limit [84](#)
- Winter tires, suitable tires [240](#)
- Winter tires, tread [239](#)
- Wiper blades, changing [249](#)
- Wiper fluid [67](#)
- Wood, care [265](#)
- Word match concept, navigation [25](#)
- Working in the engine compartment [243](#)
- Wrench/screwdriver, refer to Onboard vehicle tool kit [249](#)

X

- xDrive [101](#)
- Xenon headlights, bulb replacement [252](#)

More about BMW



bmwusa.com

The Ultimate
Driving Machine®

01 40 2 954 052 ue



Information Provided by:

DEALER

INFORMATION