

Foreword

This manual was prepared to help you understand the operation and maintenance of your vehicle so that you may enjoy many kilometers (miles) of driving pleasure. Please read through this manual before operating your vehicle.

A separate Warranty Information & Maintenance Booklet explains details about the warranties covering your vehicle.

Your NISSAN dealer knows your vehicle best. When you require any service or have any questions, we will be glad to assist you with the extensive resources available for you.

IMPORTANT SAFETY INFORMATION

Reminders for safety!

Follow these important driving rules to help ensure a safe and complete trip for you and your passengers!

- **NEVER drive under the influence of alcohol or drugs.**
- **ALWAYS observe posted speed limits and never drive too fast for conditions.**
- **ALWAYS use your seat belts and appropriate child restraint systems. Preteen children should be seated in the rear seat.**
- **ALWAYS provide information about the proper use of vehicle safety features to all occupants of the vehicle.**
- **ALWAYS review this Owner's Manual for important safety information.**

When reading the manual

This manual includes information for all options available on this model. Therefore, you may find some information that does not apply to your vehicle.

All information, specifications and illustrations in this manual are those in effect at the time of printing. NISSAN reserves the right to change specifications or designs without notice and without obligation.

MODIFICATION OF YOUR VEHICLE

This vehicle should not be modified. Modification could affect its performance, safety or durability, and may even violate governmental regulations. In addition, damage or performance problems resulting from modifications may not be covered under NISSAN warranties.

Read first – then drive safely

Before driving your vehicle, read this Owner's Manual carefully. This will ensure familiarity with controls and maintenance requirements, assisting you in the safe operation of your vehicle.

Throughout this manual we have used the symbol  followed by the word **WARNING**. This is used to indicate the presence of a hazard that could cause death or serious personal injury. To avoid or reduce the risk, the procedures must be followed precisely.

The symbol  followed by the word **CAUTION** is also used throughout this manual to indicate the presence of a hazard that could cause minor or moderate personal injury or damages to your vehicle. To avoid or reduce the risk, the procedures must be followed carefully.

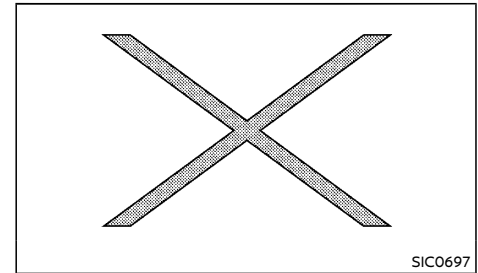

If you see this symbol, it means “**Do not do this**” or “**Do not let this happen**”.

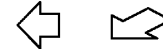

If you see a symbol similar to these in an illustration, it means the arrow points to the front of the vehicle.



Arrows in an illustration that are similar to these indicate movement or action.

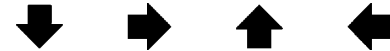

Arrows in an illustration that are similar to these call attention to an item in the illustration.



JVR0243X

"NEVER use a rearward facing child restraint on a seat protected by an ACTIVE AIRBAG in front of it, DEATH or SERIOUS INJURY to the CHILD can occur."

Be sure to read "Air bag warning labels" (P.1-23).

Bluetooth® is a trademark owned by Bluetooth SIG, Inc., and licensed to Visteon Corporation and Robert Bosch GmbH.



© 2018 NISSAN MOTOR CO., LTD.

Table of Contents

Illustrated table of contents	0
Safety – seats, seat belts and supplemental restraint system	1
Instruments and controls	2
Pre-driving checks and adjustments	3
Display screen, heater and air conditioner, and audio system	4
Starting and driving	5
In case of emergency	6
Appearance and care	7
Maintenance and do-it-yourself	8
Technical information	9
Index	10

0 Illustrated table of contents

Seats, seat belts and Supplemental Restraint System (SRS)	0-2	Instrument panel	0-7
Exterior front	0-3	Meters and gauges	0-8
Exterior rear	0-4	Engine compartment	0-9
Passenger compartment	0-5	QR25DE engine model	0-9
Cockpit	0-6	MR20DE engine model	0-10

SEATS, SEAT BELTS AND SUPPLEMENTAL RESTRAINT SYSTEM (SRS)

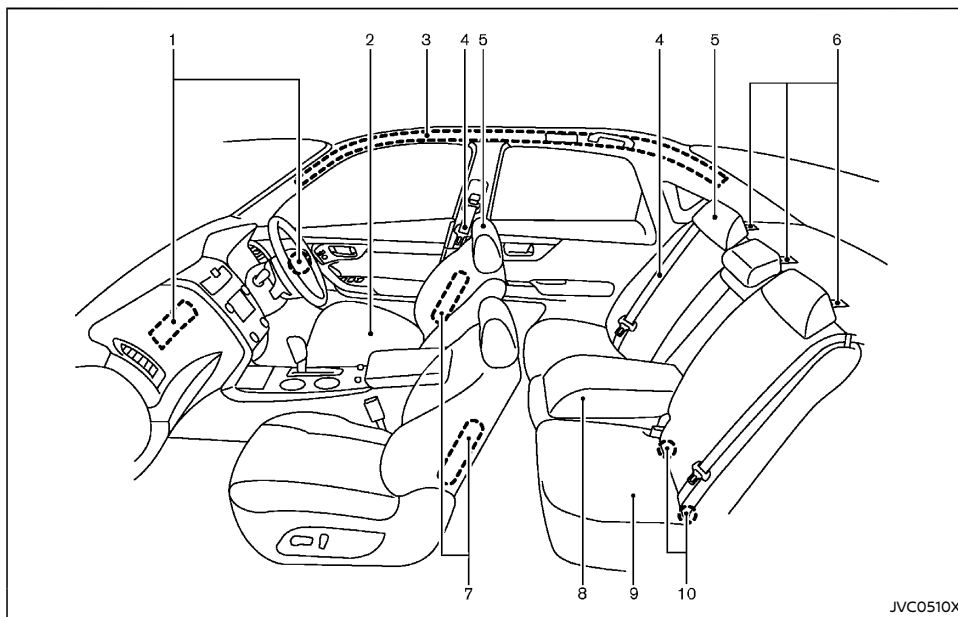

- | | |
|--|--|
| 1. Supplemental front-impact air bags (Page 1-20) | 7. Supplemental side-impact air bags (P.1-20) |
| 2. Front seats (P.1-2) | 8. Armrest (P.1-6) |
| 3. Supplemental curtain side-impact air bags (P.1-20) | 9. Rear seats (P.1-4)
— Child restraints (P.1-13) |
| 4. Seat belts (P.1-9)
— Pre-tensioner seat belt system* (P.1-27) | 10. ISOFIX child restraint system (P.1-13) |
| 5. Head restraints (P.1-6) | *: if equipped |
| 6. Child restraint anchor points (for top tether strap child restraint)* (P. 1-14) | |

EXTERIOR FRONT

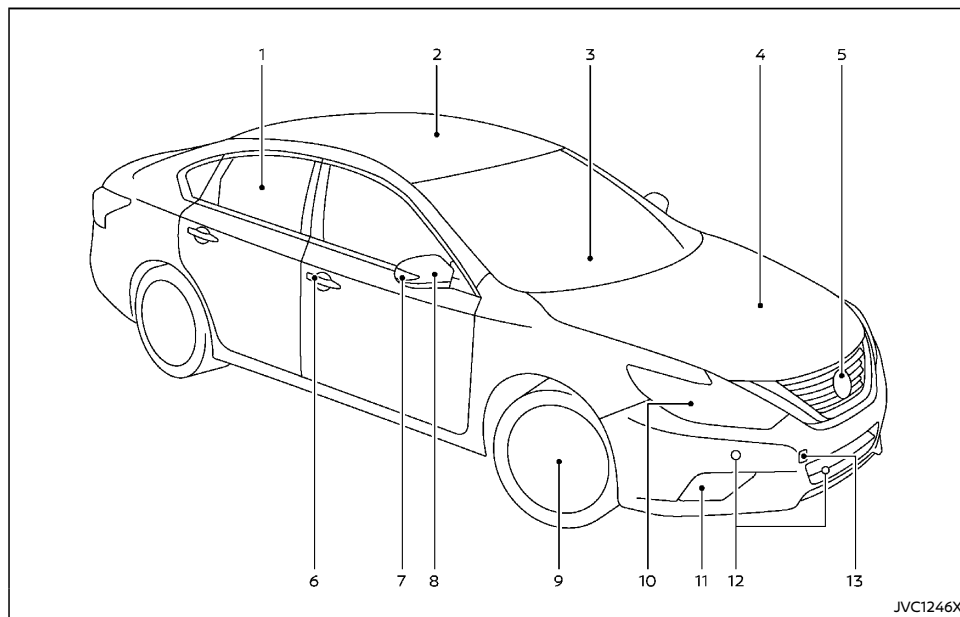

- | | |
|--------------------------------|--|
| 1. Power windows (P.2-24) | — Door locks (P.3-3) |
| 2. Sunroof* (P.2-26) | — Intelligent Key system (P.3-5) |
| 3. Windshield wiper and washer | — Security system (P.3-14) |
| — Switch operation (P.2-22) | 7. Side turn signal light (P.2-21, P.8-21) |
| — Blade replacement (P.8-14) | 8. Outside rearview mirrors (P.3-21) |
| — Window washer fluid (P.8-15) | — Side view camera* (P.4-10) |
| 4. Engine hood (P.3-17) | 9. Tires |
| 5. Front view camera* (P.4-10) | — Tires and wheels (P.8-23, P.9-6) |
| 6. Doors | — Flat tire (P.6-2) |
| — Keys (P.3-2) | — Tire placard (P.9-8) |

10. Headlights, clearance lights and turn signal lights (P.8-21)
— Switch operation (P.2-20)
11. Fog lights (P.8-21)
— Switch operation (P.2-22)
12. Parking sensor* (P.4-10, P.5-21)
13. Recovery hook (P.6-8)
- *: if equipped

EXTERIOR REAR

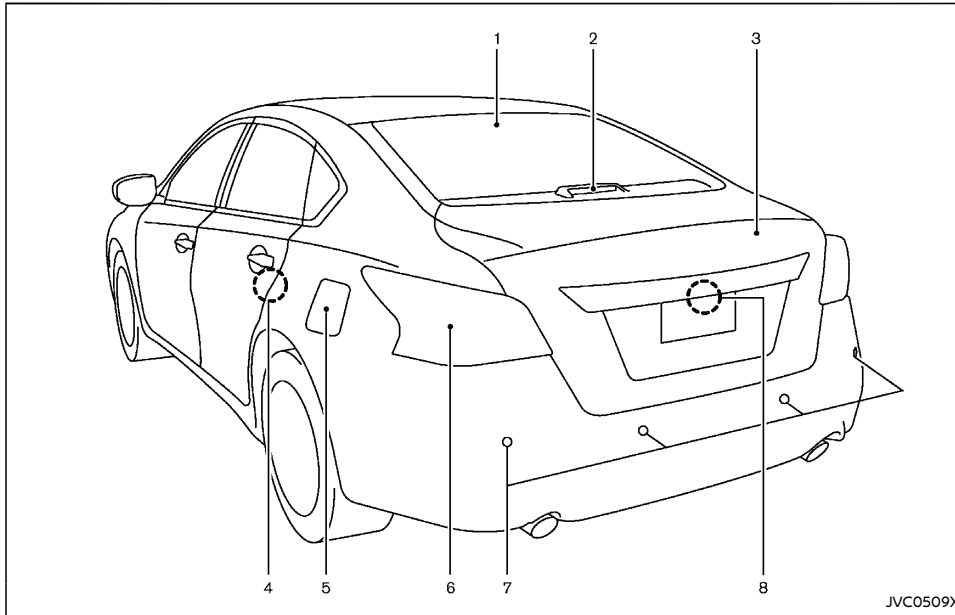

- | | |
|---|-------------------------------------|
| 1. Rear window | 6. Rear combination lights |
| – Rear window defogger (P.2-23) | – Switch operation (P.2-21) |
| – Antenna (P.4-29) | – Bulb replacement (P.8-21) |
| 2. High-mounted stop light (P.8-21) | 7. Parking sensor* (P.4-10, P.5-21) |
| 3. Trunk lid (P.3-18) | 8. Rear view camera (P.4-6, P.4-10) |
| – Intelligent Key system (P.3-5) | *: if equipped |
| 4. Child safety rear door locks (P.3-5) | |
| 5. Fuel-filler lid | |
| – Operation (P.3-19) | |
| – Fuel information (P.9-3) | |

PASSENGER COMPARTMENT

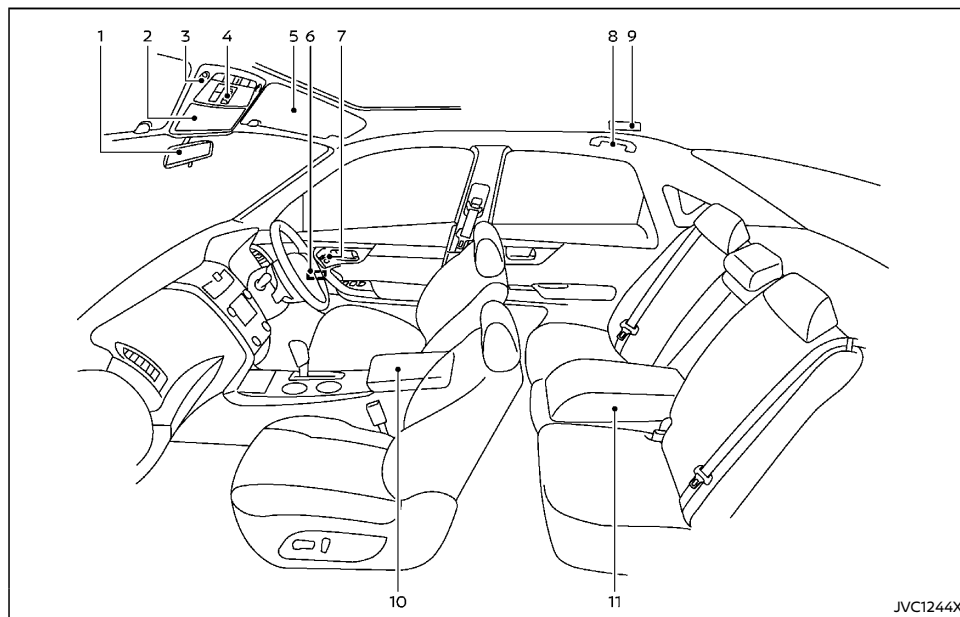

- | | |
|--|--|
| 1. Inside rearview mirror (P.3-20) | — Outside rearview mirror remote control switch (driver's side) (P.3-21) |
| 2. Sunglasses holder (P.2-29) | |
| 3. Map lights (P.2-31) | 8. Coat hook (driver's side) (P.2-30) |
| 4. Sunroof switch* (P.2-26) | 9. Rear personal lights (P.2-31) |
| 5. Sun visors (P.2-30, P.3-22) | 10. Console box (P.2-28) |
| 6. Automatic drive positioner* (P.3-23) | — Power outlet (P.2-27) |
| 7. Door armrest | 11. Rear armrest |
| — Power window switch (P.2-24) | — Cup holders (P.2-29) |
| — Power door lock switch (driver's side) (P.3-4) | *: if equipped |

COCKPIT

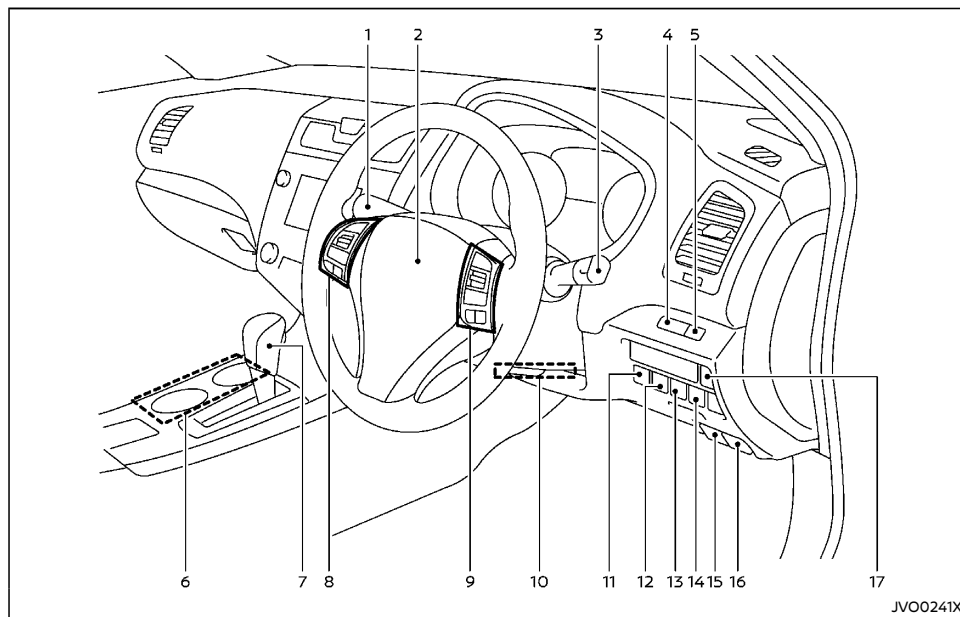

- | | |
|---|--|
| 1. Wiper and washer switch (P.2-22) | 4. Instrument brightness control (P.2-6) |
| 2. Steering wheel | 5. TRIP/RESET switch (P.2-4) |
| – Power steering (P.5-23) | 6. Cup holders (P.2-29) |
| – Horn (P.2-24) | 7. Shift lever |
| – Driver's supplemental front-impact air bag (P.1-20) | – Driving vehicle (P.5-7) |
| 3. Headlight, fog light and turn signal switch | – Rear view monitor* (P.4-6) |
| – Headlight (P.2-20) | – Intelligent Around View Monitor* (P.4-10) |
| – Turn signal (P.2-21) | 8. Steering-wheel-mounted controls (left side) |
| – Fog light (P.2-22) | |

- Audio control steering switch (P.4-41)
 - Vehicle information display control switch (P.2-11)
9. Steering-wheel-mounted controls (right side)
 - Cruise control main/set switch (P.5-16)
 - Bluetooth® Hands-Free Phone System switch (P.4-42, P.4-47)
 10. Tilting/telescopic steering wheel lock lever (P.3-20)
 11. Warning systems switch* (P.5-12)
 12. ECO switch (P.5-19)
 13. Rear sunshade switch* (P.2-27)
 14. Vehicle Dynamic Control (VDC) OFF switch (P.5-11)
 15. Hood release handle (P.3-17)
 16. Fuel-filler lid opener handle (P.3-19)
 17. Trunk lid opener (P.3-18)
- *: if equipped

INSTRUMENT PANEL

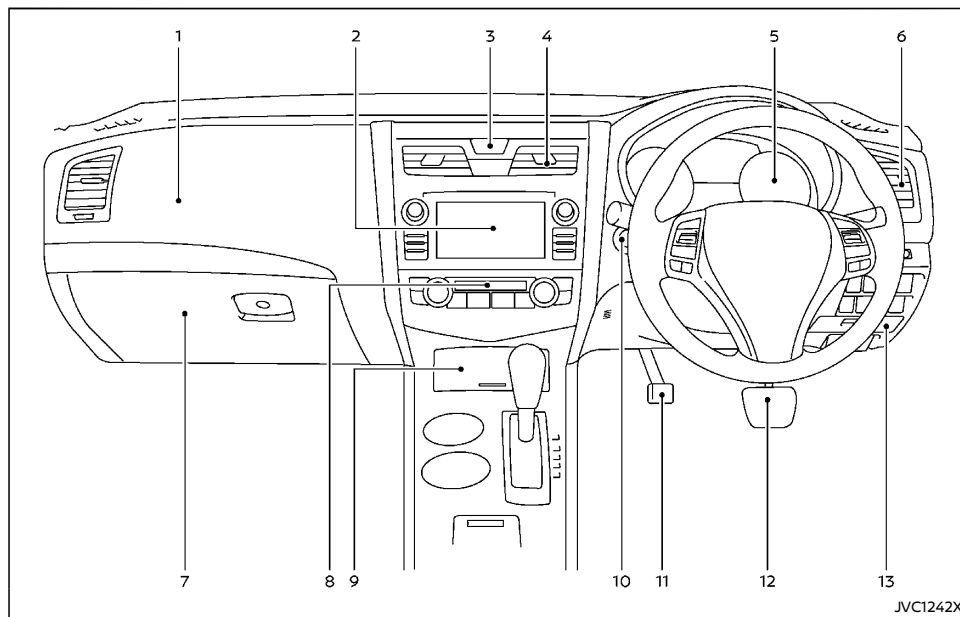

- | | |
|--|--|
| 1. Passenger's front-impact air bag (P.1-20) | 6. Side ventilator (P.4-19) |
| 2. Audio system (P.4-23) or center display (P.4-3)
— Rear view monitor* (P.4-6)
— Intelligent Around View Monitor* (P.4-10)
— Navigation system** | 7. Glove box (P.2-28) |
| 3. Hazard indicator flasher switch (P.6-2) | 8. Heater/air conditioner control (P.4-20)
— Defogger switch (P.2-23) |
| 4. Center ventilator (P.4-19) | 9. Power outlet (P.2-27)/USB connection port (P.4-39)/iPod connector (P.4-39)/AUX input jack* (P.4-40) |
| 5. Meters and gauges (P.2-4) | 10. Push-button ignition switch (P.5-4) |
| | 11. Parking brake
— Operation (P.3-22) |

- Parking (P.5-20)
 - Maintenance (P.8-11)
12. Brake pedal
— Brake system (P.5-23)
— Maintenance (P.8-11)
13. Fuse box cover (P.8-19)
- *: if equipped
- ** : Refer to the separate Navigation System Owner's Manual (if equipped).

METERS AND GAUGES

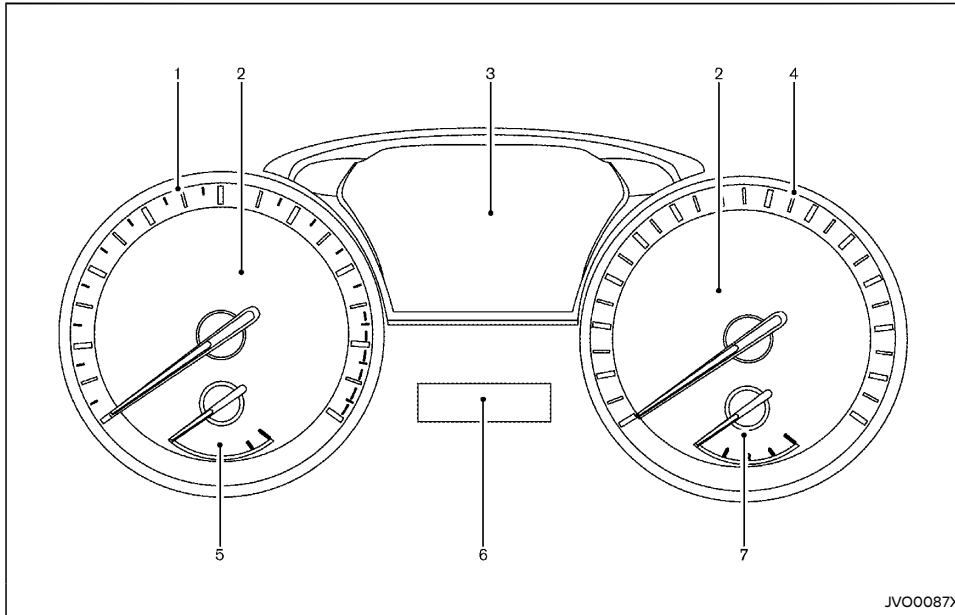

1. Tachometer (P.2-5)
2. Warning and indicator lights (P.2-7)
3. Vehicle information display (P.2-11)
 - Vehicle information display warnings and indicators (P.2-17)
 - ECO mode system (P.5-19)
 - Startup display (P.2-12)
 - Settings (P.2-12)
4. Speedometer (P.2-4)
5. Engine coolant temperature gauge (P.2-5)
6. Odometer/twin trip odometer (P.2-4)/Continuously Variable Transmission (CVT) position indicator (P.2-5, P.5-7)
7. Fuel gauge (P.2-5)

ENGINE COMPARTMENT

QR25DE ENGINE MODEL

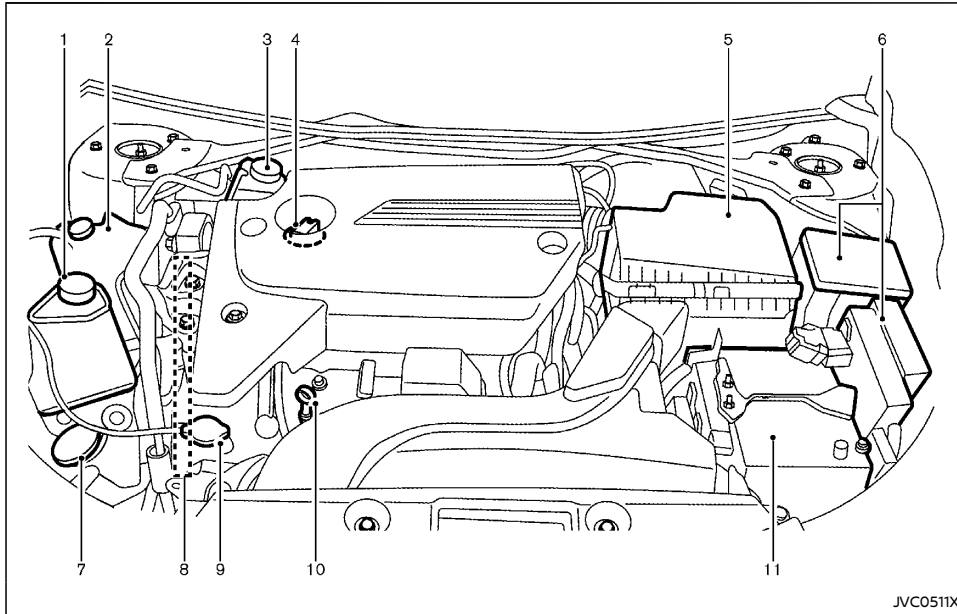

- | | |
|--|---------------------------------------|
| 1. Power steering fluid reservoir (P.8-13) | 8. Engine drive belt location (P.8-9) |
| 2. Engine coolant reservoir (P.8-6) | 9. Radiator filler cap (P.8-6) |
| 3. Brake fluid reservoir (P.8-12) | — Vehicle overheat (P.6-7) |
| 4. Engine oil filler cap (P.8-8) | 10. Engine oil dipstick (P.8-7) |
| 5. Air cleaner (P.8-13) | 11. Battery (P.8-16) |
| 6. Fuse/fusible link box (P.8-18) | — Jump starting (P.6-5) |
| 7. Window washer fluid reservoir (P.8-15) | |

MR20DE ENGINE MODEL

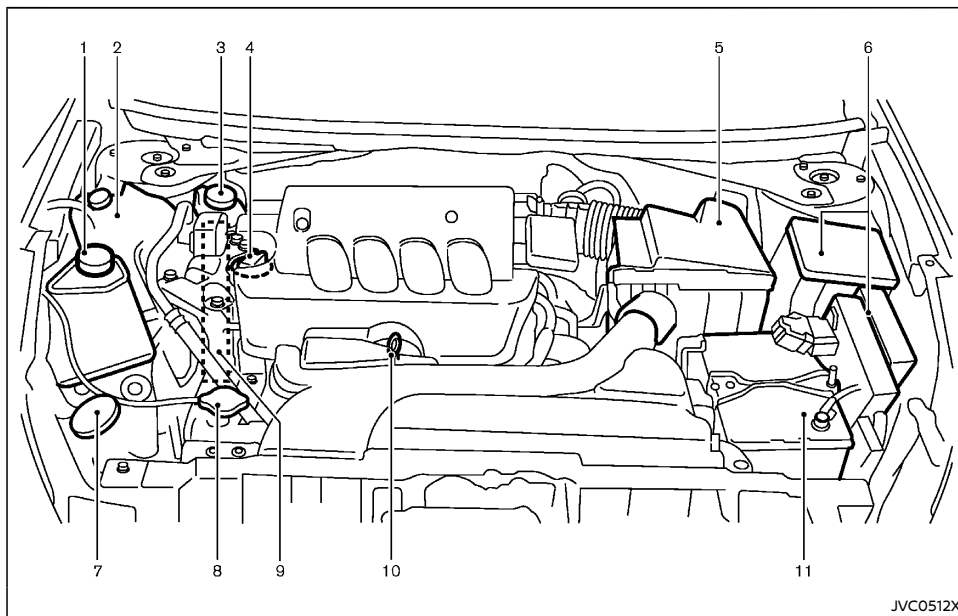

- | | |
|--|---------------------------------------|
| 1. Power steering fluid reservoir (P.8-13) | 9. Engine drive belt location (P.8-9) |
| 2. Engine coolant reservoir (P.8-6) | 10. Engine oil dipstick (P.8-7) |
| 3. Brake fluid reservoir (P.8-12) | 11. Battery (P.8-16) |
| 4. Engine oil filler cap (P.8-8) | — Jump starting (P.6-5) |
| 5. Air cleaner (P.8-13) | |
| 6. Fuse/fusible link box (P.8-18) | |
| 7. Window washer fluid reservoir (P.8-15) | |
| 8. Radiator cap (P.8-6) | |
| — Vehicle overheat (P.6-7) | |

1 Safety — seats, seat belts and supplemental restraint system

Seats	1-2	Three-point type seat belts	1-11
Front seats	1-2	Seat belt maintenance	1-12
Rear seats	1-4	Child restraints	1-13
Armrest	1-6	Precautions on child restraint usage	1-13
Head restraints	1-6	ISOFIX child restraint system	1-13
Adjustable head restraint components	1-7	Child restraint anchorage	1-14
Non-adjustable head restraint components	1-7	Child restraint installation using ISOFIX	1-15
Remove	1-7	Child restraint installation using three-point type seat belt	1-17
Install	1-7	Supplemental Restraint System (SRS)	1-20
Adjust	1-7	Precautions on Supplemental Restraint System (SRS)	1-20
Seat belts	1-9	Supplemental air bag systems	1-24
Precautions on seat belt usage	1-9	SRS air bag deployment conditions	1-25
Child safety	1-10	Pre-tensioner seat belt system	1-27
Pregnant women	1-11	Repair and replacement procedure	1-28
Injured persons	1-11		
Center mark on seat belts	1-11		

SEATS

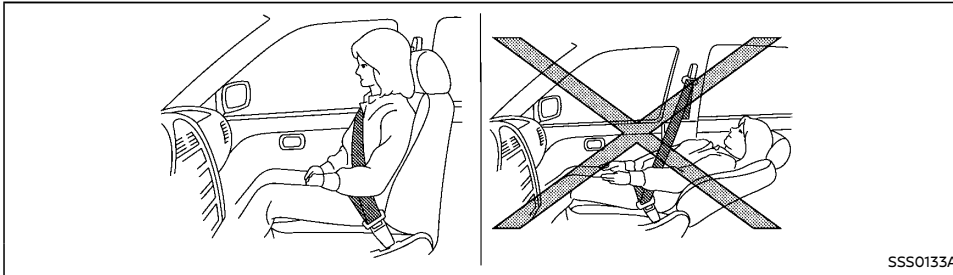

WARNING:

- Do not drive and/or ride in the vehicle with the seatback reclined. This can be dangerous. The shoulder belt will not be properly against the body. In an accident, you and your passengers could be thrown into the shoulder belt and receive neck or other serious injuries. You and your passengers could also slide under the lap belt and receive serious injuries.
- For the most effective protection while the vehicle is in motion, the seatback should be upright. Always sit well back and upright in the seat and adjust the seat properly. (See "Seat belts" (P.1-9).)
- Do not leave children unattended inside the vehicle. They could unknowingly activate switches or controls. Unattended children could become involved in serious accidents.
- To help avoid risk of injury or death through unintended operation of the vehicle and/or its systems, do not leave children, people who require the assistance of others or pets unattended in

your vehicle. Additionally, the temperature inside a closed vehicle on a warm day can quickly become high enough to cause a significant risk of injury or death to people and pets.

CAUTION:

When adjusting the seat positions, be sure not to contact any moving parts to avoid possible injuries and/or damages.

FRONT SEATS

WARNING:

Do not adjust the driver's seat while driving so that full attention may be given to vehicle operation.

Power seat adjustment

Operating tips:

- The power seat motor has an auto-reset overload protection circuit. If the motor stops during the seat adjustment, wait 30 seconds, then reactivate the switch.
- To avoid discharge of the battery, do not operate the power seats for a long period of time when the engine is not running.

For automatic seat positioner operation (if equipped), see "Automatic drive positioner" (P.3-23).

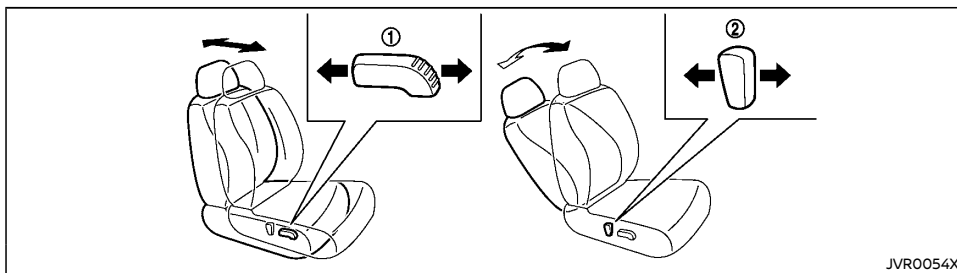

Forward and backward:

Move forward or backward the adjusting switch ① to the desired position.

Reclining:

Move forward or backward the adjusting switch ② to the desired position.

The reclining feature allows the adjustment of the seatback for occupants of different sizes to help obtain the proper seat belt fit. (See "Seat belts" (P.1-9).)

The seatback may be reclined to allow occupants to rest when the vehicle is parked.

Seat lifter (if equipped):

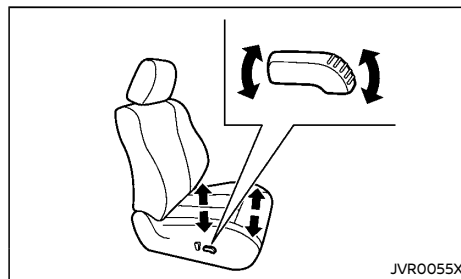

Type A

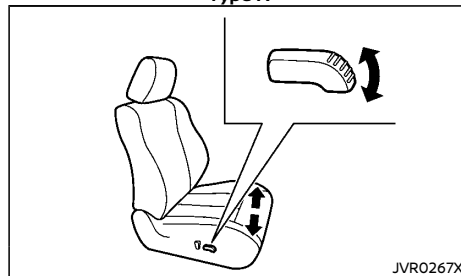

Type B

- Pull up or push down the adjusting switch to adjust the seat height until the desired position is achieved (if equipped).
- Tilt up or down the adjusting switch to adjust the seat angle until the desired position is achieved.

Lumbar support (if equipped):

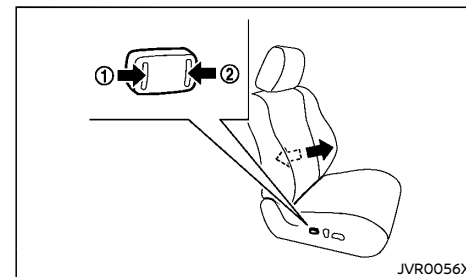

The lumbar support feature provides lower back support to the driver.

Push each side of the adjusting switch ① and ② to adjust the seat lumbar area until the desired position is achieved.

REAR SEATS

Folding



WARNING:

- Never allow anyone to ride in the cargo area or on the rear seat when it is in the fold-down position. Use of these areas by passengers without proper restraints could result in serious injury in an accident or sudden stop.

- Properly secure all cargo with ropes or straps to help prevent it from sliding or shifting. Do not place cargo higher than the seatbacks. In a sudden stop or collision, unsecured cargo could cause personal injury.
- When returning the seatbacks to the upright position, be certain they are completely secured in the latched position. If they are not completely secured, passengers may be injured in an accident or sudden stop.
- Closely supervise children when they are around cars to prevent them from playing and becoming locked in the trunk where they could be seriously injured. Keep the car locked, with the rear seatback and trunk lid securely latched when not in use, and prevent children's access to car keys.

The rear seatback can be folded according to the following procedure.

Before folding the seatback:

- Remove drink containers from the rear cup holder.

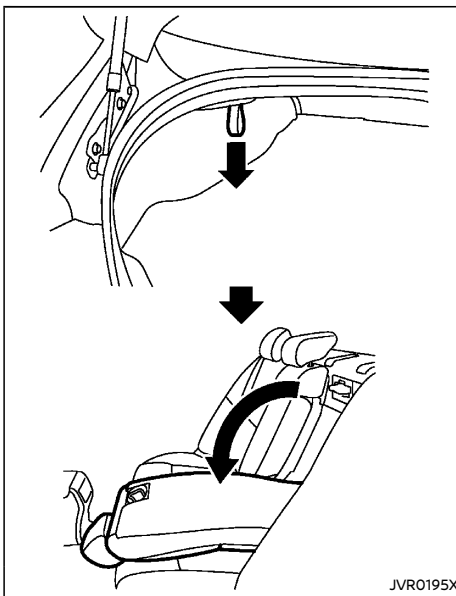

Type A

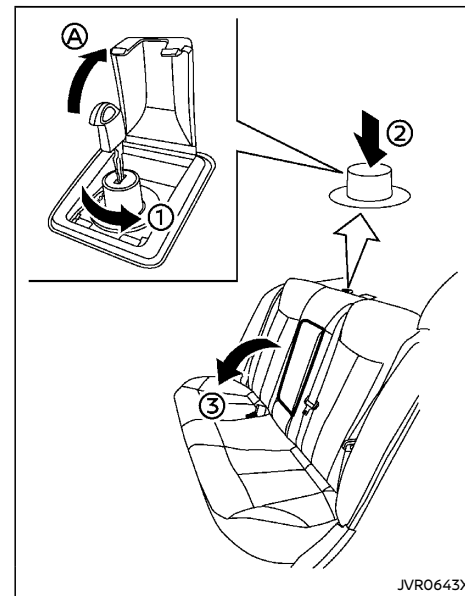

Type B

To fold the seatback (Type A):

1. Open the trunk lid.
2. Pull the strap located on the left and right side of the trunk. The rear seatback will be unlatched.
3. Fold the rear seatback down.

HEAD RESTRAINTS

To fold the seatback (Type B):

1. Move the driver's seat to the most forward position.
2. Open the cover ④ on the rear parcel shelf.
3. Insert the mechanical key (see "Mechanical key" (P.3-2)) to the key cylinder on the button and turn it to the "UNLOCK" position ①.
4. Push down the button ② on the rear parcel shelf.
5. Fold down the driver's side seatback ③.

To return the seatback:

1. Fold up the rear seatback.
2. Securely lock the seatback in position.

ARMREST

Rear

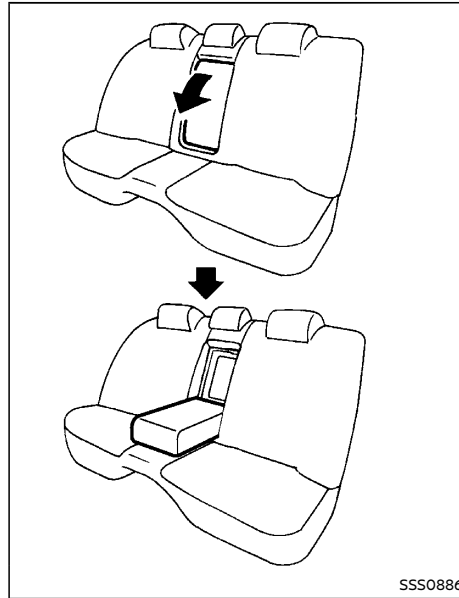

The rear center seatback can be folded down to make the rear armrest. Fold down the seatback until it becomes horizontal.



WARNING:

Head restraints supplement the other vehicle safety systems. They may provide additional protection against injury in certain rear end collisions. Adjustable head restraints must be adjusted properly, as specified in this section. Check the adjustment after someone else uses the seat. Do not attach anything to the head restraint stalks or remove the head restraint. Do not use the seat if the head restraint has been removed. If the head restraint was removed, reinstall and properly adjust the head restraint before an occupant uses the seating position. Failure to follow these instructions can reduce the effectiveness of the head restraint. This may increase the risk of serious injury or death in a collision.

- Your vehicle is equipped with a head restraint that may be integrated, adjustable or non-adjustable.
- Adjustable head restraints have multiple notches along the stalk to lock them in a desired adjustment position.
- The non-adjustable head restraints have a single locking notch to secure them to the seat frame.
- Proper Adjustment:
 - For the adjustable type, align the head restraint so the center of your ear is approximately level with the center of the head restraint.
 - If your ear position is still higher than the recommended alignment, place the head restraint at the highest position.
- If the head restraint has been removed, ensure that it is reinstalled and locked in place before riding in that designated

seating position.

ADJUSTABLE HEAD RESTRAINT COMPONENTS

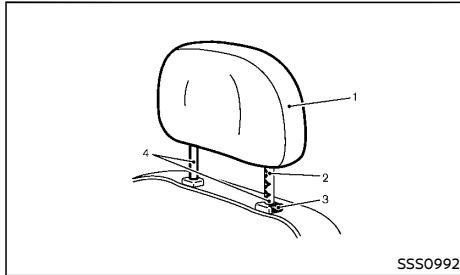

1. Removable head restraint
2. Multiple notches
3. Lock knob
4. Stalks

NON-ADJUSTABLE HEAD RESTRAINT COMPONENTS

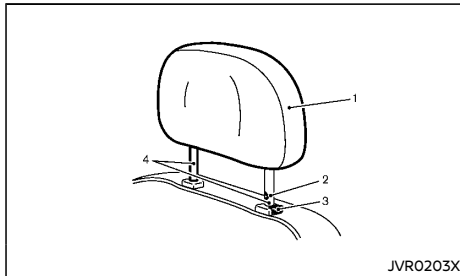

1. Removable head restraint

2. Single notch
3. Lock knob
4. Stalks

REMOVE

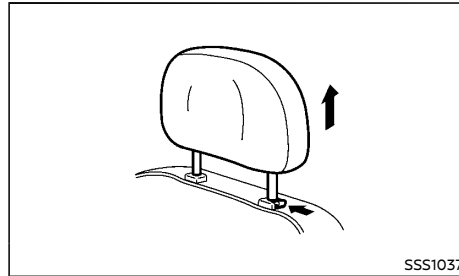

Use the following procedure to remove the head restraint.

1. Pull the head restraint up to the highest position.
2. Push and hold the lock knob.
3. Remove the head restraint from the seat.
4. Store the head restraint properly in a secure place so it is not loose in the vehicle.
5. Reinstall and properly adjust the head restraint before an occupant uses the seating position.

INSTALL

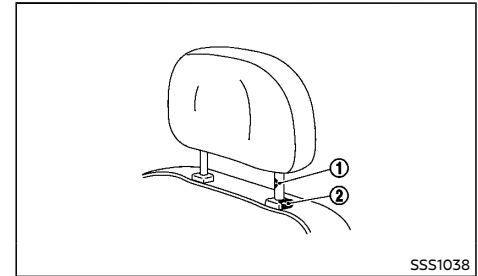

1. Align the head restraint stalks with the holes in the seat. Make sure that the head restraint is facing the correct direction. The stalk with the adjustment notch ① must be installed in the hole with the lock knob ②.
2. Push and hold the lock knob and push the head restraint down.
3. Properly adjust the head restraint before an occupant uses the seating position.

ADJUST

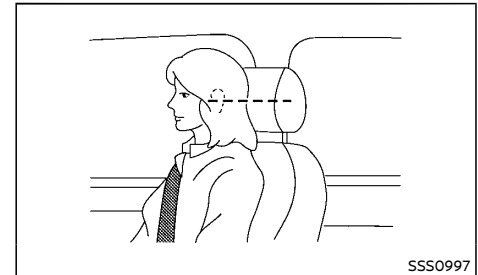

For adjustable head restraint

Adjust the head restraint so the center is level with the center of your ears. If your ear position is still higher than the recommended alignment, place the head restraint at the highest position.

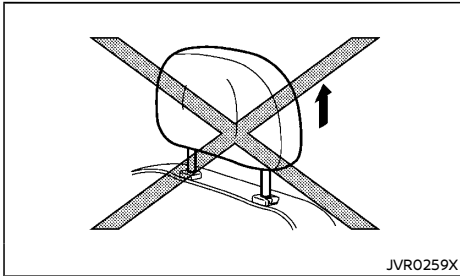

For non-adjustable head restraint

Make sure the head restraint is positioned from the stored position or any non-latch position so the lock knob is engaged in the notch before riding in that designated seating position.

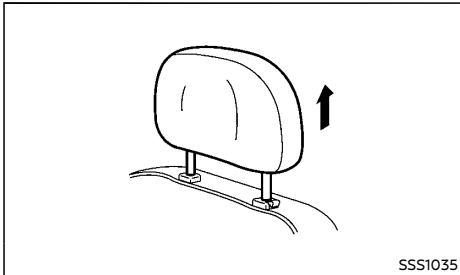

To raise the head restraint, pull it up.

Make sure the head restraint is positioned from the stored position or any non-latch position so the lock knob is engaged in the notch before riding in that designated seating position.

Lower

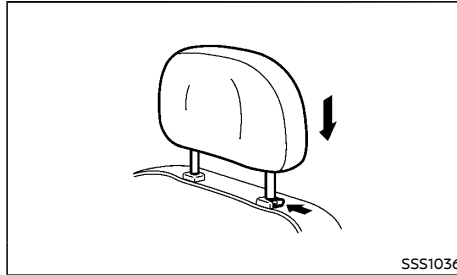

To lower, push and hold the lock knob and push the head restraint down.

Make sure the head restraint is positioned so the lock knob is engaged in the notch before riding in that designated seating position.

SEAT BELTS

PRECAUTIONS ON SEAT BELT USAGE

If you are wearing the seat belt properly adjusted and sitting upright and well back in the seat, chances of being injured or killed in an accident and/or the severity of injury may be greatly reduced. NISSAN strongly encourages you and all of your passengers to buckle up every time you drive, even if your seating position includes the supplemental air bag systems.

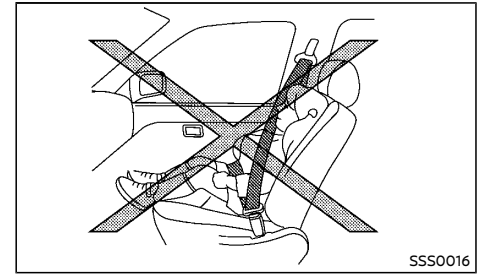
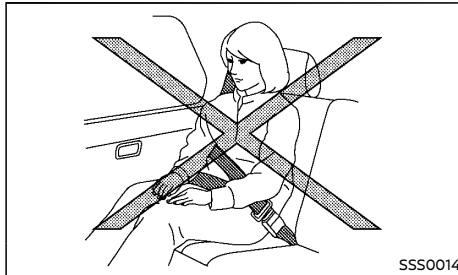
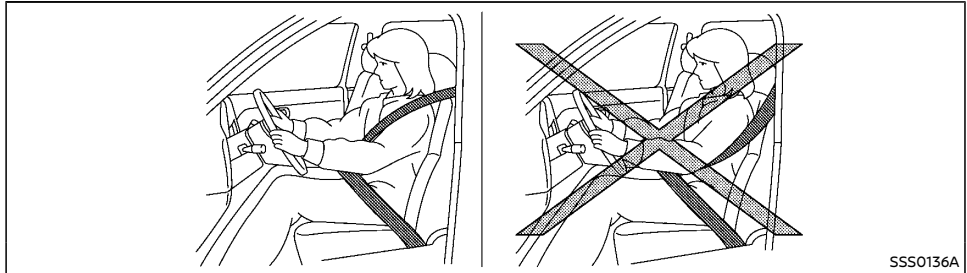
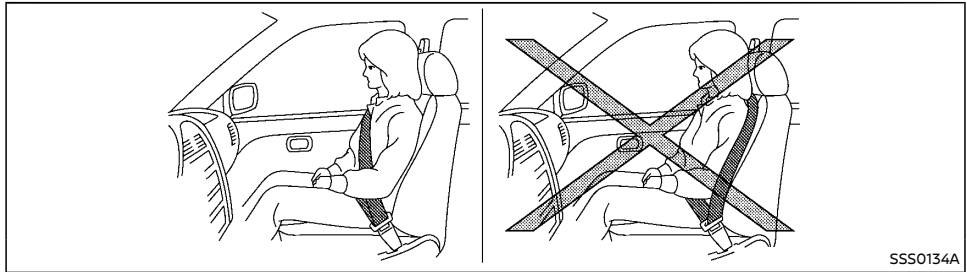



WARNING:

- Seatbelts are designed to bear upon the bony structure of the body, and should be worn low across the front of the pelvis or the pelvis, chest and shoulders, as applicable; wearing the lap section of the belt across the abdominal area must be avoided. Serious injury may occur if a seat belt is not worn properly.
- Position the lap belt as low and snug as possible around the hips, not the waist. A lap belt worn too high could increase the risk of internal injuries in an accident.
- Do not allow more than one person to use the same seat belt. Each belt assembly must only be used by one occupant; it is dangerous to put a belt around a child being carried on the occupant's lap.
- Never carry more people in the vehicle than there are seat belts.
- Never wear seat belts inside out. Belts should not be worn with straps twisted. Doing so may reduce their effectiveness.
- Seatbelts should be adjusted as firmly as possible, consistent with comfort, to provide the protection for which they have been designed. A slack belt will greatly reduce the protection afforded to the wearer.
- Every person who drives or rides in this vehicle should use a seat belt at all times. Children should be properly restrained in the rear seat and, if appropriate, in a child restraint system.
- Do not put the belt behind your back or under your arm. Always route the shoulder belt over your shoulder and across your chest. The belt should be

away from your face and neck, but not falling off your shoulder. Serious injury may occur if a seat belt is not worn properly.

- No modifications or additions should be made by the user which will either prevent the seat belt adjusting devices from operating to remove slack, or prevent the seat belt assembly from being adjusted to remove slack.
- Care should be taken to avoid contamination of the webbing with polishes, oils and chemicals, and particularly battery acid. Cleaning may safely be carried out using mild soap and water. The belt should be replaced if webbing becomes frayed, contaminated or damaged.
- All seat belt assemblies including retractors and attaching hardware should be inspected after any collision by a NISSAN dealer. NISSAN recommends that all seat belt assemblies in use during a collision be replaced unless the collision was minor and the belts show no damage and continue to operate properly. Seat belt assemblies not in use during a collision should also be inspected and, when necessary, replaced if either damage or improper operation is noted.
- It is essential to replace the entire assembly after it has been worn in a severe impact even if damage to the assembly is not obvious.
- Once the pre-tensioner seat belt has activated, it cannot be reused. It must be replaced together with the retractor. Contact a NISSAN dealer.
- Removal and installation of the pre-tensioner seat belt system components

should be done by a NISSAN dealer.

CHILD SAFETY



WARNING:

- Infants and children need special protection. The vehicle's seat belts may not fit them properly. The shoulder belt may come too close to the face or neck. The lap belt may not fit over their small hipbones. In an accident, an improperly fitted seat belt could cause serious or fatal injury.
- Always use an appropriate child restraint system.

Children need adults to help protect them. They need to be properly restrained. The proper restraint depends on the child's size.

Infants and small children

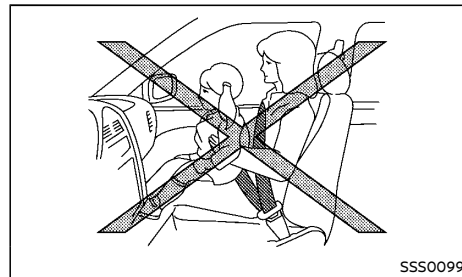

SSS0099

NISSAN recommends that infants and small children be seated in a child restraint system. You should choose a child restraint system that fits your vehicle and the child, and always follow the manufacturer's instructions for installation and use.

Large children

WARNING:

- **Never allow children to stand or kneel on any seats.**
- **Never allow children in the cargo areas while the vehicle is moving. A child could be seriously injured in an accident or sudden stop.**

Children who are too large for a child restraint system should be seated and restrained by the seat belts that are provided.

If the child's seating position has a shoulder belt that fits close to the face or neck, the use of a booster seat (commercially available) may help overcome this. The booster seat should raise the child so that the shoulder belt is properly positioned across the top, middle portion of the shoulder and the lap belt is low on the hips. The booster seat should also fit the vehicle seat. Once the child has grown so that the shoulder belt is no longer on or near the face or neck of the child, use the shoulder belt without the booster seat. In addition, there are many types of child restraint systems available for larger children that should be used for maximum protection.

PREGNANT WOMEN

NISSAN recommends that pregnant women use seat belts. The seat belt should be worn snug, and always position the lap belt as low as possible around the hips, not the waist. Place the shoulder belt over your shoulder and across your chest. Never put the lap/shoulder belt over your abdominal area. Contact your doctor for specific recommendations.

INJURED PERSONS

NISSAN recommends that injured persons use seat belts. Contact your doctor for specific recommendations.

CENTER MARK ON SEAT BELTS

Selecting correct set of seat belts

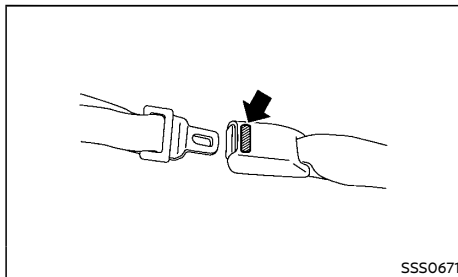

The center seat belt buckle is identified by the CENTER mark. The center seat belt tongue can be fastened only into the center seat belt buckle.

THREE-POINT TYPE SEAT BELTS

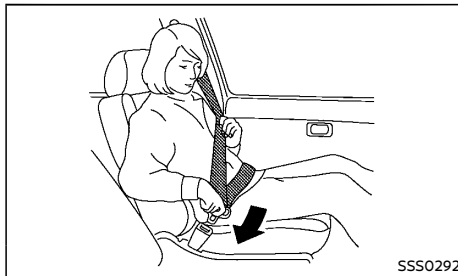

WARNING:

Every person who drives or rides in this vehicle should use a seat belt at all times.

Fastening seat belts

WARNING:

The seatback should not be in a reclined position any more than needed for comfort. Seat belts are most effective when the passenger sits well back and straight up in the seat.

1. Adjust the seat. (See "Seats" (P.1-2).)
2. Slowly pull the seat belt out of the retractor and insert the tongue into the buckle until you hear and feel the latch engage.
 - **The retractor is designed to lock during a sudden stop or on impact. A slow pulling motion permits the seat belt to move, and allows you some freedom of movement in the seat.**
 - **If the seat belt cannot be pulled from its fully retracted position, firmly pull the belt and release it. Then smoothly pull the belt out of the retractor.**

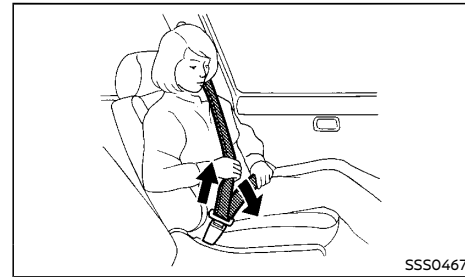

3. Position the lap belt portion low and snug on the hips as shown.
4. Pull the shoulder belt portion toward the retractor to take up extra slack. Be sure the shoulder belt is routed over your shoulder and is snug across your chest.

Shoulder belt height adjustment (for front seats)

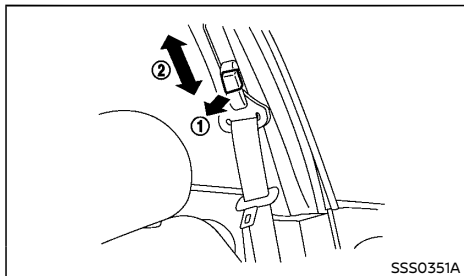

WARNING:

- **The shoulder belt anchor height should be adjusted to the position best for you. Failure to do so may reduce the effectiveness of the entire restraint system and increase the chance or severity of injury in an accident.**
- **The shoulder belt should rest on the middle of the shoulder. It must not rest against the neck.**
- **Be sure that the seat belt is not twisted in any way.**
- **Be sure that the shoulder belt anchor is secured by trying to move the shoulder belt anchor up and down after adjustment.**

The shoulder belt anchor height should be adjusted to the position best for you.

The belt should be away from your face and neck, but not falling off your shoulder.

To adjust, pull out the release button ① and move the shoulder belt anchor to the proper position ②, so that the belt passes over the center of the shoulder.

Release the button to lock the shoulder belt anchor into position.

Unfastening seat belts

Push the button on the buckle. The seat belt automatically retracts.

Checking seat belt operation

Seat belt retractors are designed to lock seat belt movement:

- When the seat belt is pulled quickly from the retractor.
- When the vehicle slows down rapidly.

To increase your confidence in the seat belts, check the operation by grasping the shoulder belt and pulling forward quickly. The retractor should lock and restrict further belt movement. If the retractor does not lock during this check, contact a NISSAN dealer immediately.

SEAT BELT MAINTENANCE

Periodically check that the seat belt and all the metal components, such as buckles, tongues, retractors, flexible wires and anchors, work properly. If loose parts, deterioration, cuts or other damage on the seat belt webbing is found, the entire seat belt assembly should be replaced.

If dirt builds up in the shoulder belt guide of the seat belt anchors, the seat belts may retract slowly. Wipe the shoulder belt guide with a

clean, dry cloth.

To clean the seat belt webbing, apply a mild soap solution or any solution recommended for cleaning upholstery or carpet. Then wipe with a cloth and allow the seat belts to dry in the shade. Do not allow the seat belts to retract until they are completely dry.

CHILD RESTRAINTS

PRECAUTIONS ON CHILD RESTRAINT USAGE

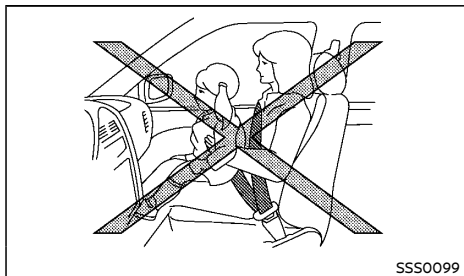

WARNING:

- Infants and small children should always be placed in an appropriate child restraint while riding in the vehicle. Failure to use a child restraint can result in serious injury or death.
- Infants and small children should never be carried on your lap. It is not possible for even the strongest adult to resist the forces of a severe accident. The child could be crushed between the adult and parts of the vehicle. Also, do not put the same seat belt around both your child and yourself.
- NISSAN recommends that the child restraints be installed in the rear seat. According to accident statistics, children are safer when properly restrained in the rear seat than in the front seat.
- Improper use or improper installation of a child restraint can increase the risk or severity of injury for both the child and other occupants of the vehicle and can

lead to serious injury or death in an accident.

- Follow all of the child restraint manufacturer's instructions for installation and use. When purchasing a child restraint, be sure to select one which will fit your child and vehicle. It may not be possible to properly install some types of child restraint in your vehicle.
- The direction of the child restraint, either front-facing or rear-facing, depends on the type of the child restraint and the size of the child. Refer to the child restraint manufacturer's instructions for details.
- After attaching a child restraint, test it before you place the child in it. Push it from side to side and tug it forward to make sure that it is held securely in place. The child restraint should not move more than 25 mm (1 in). If the restraint is not secure, tighten the belt as necessary, or install the restraint in another seat and test it again.
- When the child restraint is not in use, keep it secured with the ISOFIX child restraint system or a seat belt to prevent it from being thrown around in case of a sudden stop or accident.
- Never install a rear-facing child restraint on the front passenger's seat when the front passenger's air bag is available. Supplemental front-impact air bags inflate with great force. A rear-facing child restraint could be struck by the supplemental front-impact air bags in an accident and could seriously injure or kill your child.
- If the seat belt in the position where a child restraint is installed requires a locking device and if it is not used, injuries

could result from a child restraint tipping over during normal vehicle braking or cornering.



CAUTION:

Remember that a child restraint left in a closed vehicle can become very hot. Check the seating surface and buckles before placing your child in a child restraint.

NISSAN recommends that infants and small children be seated in a child restraint. You should choose a child restraint that fits your vehicle and always follow the manufacturer's instructions for installation and use. In addition, there are many types of child restraints available for larger children that should be used for maximum protection.

ISOFIX CHILD RESTRAINT SYSTEM

Your vehicle is equipped with special anchor points that are used with ISOFIX child restraint systems.

ISOFIX lower anchor point locations

The ISOFIX anchor points are provided to install child restraints in the rear outboard seating positions only. **Do not attempt to install a child restraint in the center position using the ISOFIX anchors.**

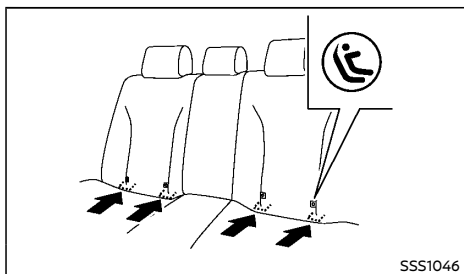

ISOFIX label location

SSS1046

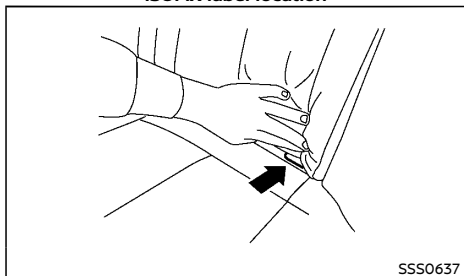

ISOFIX lower anchor location

SSS0637

The ISOFIX anchors are located at the rear of the seat cushion near the seatback. A label is attached to the seatback to help you locate the ISOFIX anchors.

ISOFIX child restraint anchor attachments

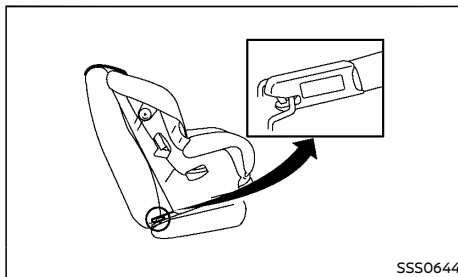

Anchor attachment

SSS0644

ISOFIX child restraints include two rigid attachments that can be connected to two anchors located in the seat. With this system, you do not have to use a vehicle seat belt to secure the child restraint. Check your child restraint for a label stating that it is compatible with the ISOFIX child restraints. This information may also be in the instructions provided by the child restraint manufacturer.

ISOFIX child restraints generally require the use of a top tether strap or other anti-rotation devices such as support legs. When installing ISOFIX child restraints, carefully read and follow the instructions in this manual and those supplied with the child restraints. (See "Child restraint installation using ISOFIX" (P.1-15).)

CHILD RESTRAINT ANCHORAGE

Your vehicle is designed to accommodate a child restraint system on the rear seat. When installing a child restraint system, carefully read and follow the instructions in this manual and those supplied with the child restraint system.



WARNING:

Child restraint anchorages are designed to withstand only those loads imposed by correctly fitted child restraints. Under no circumstances are they to be used for adult seat belts, harnesses or for attaching other items or equipment to the vehicle. Doing so could damage the child restraint anchorages. The child restraint will not be properly installed using the damaged anchorage, and a child could be seriously injured or killed in a collision.

Anchorage location

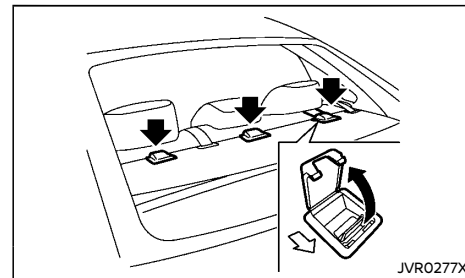

JVR0277X

The anchor points are located under the anchorage cover on the rear parcel shelf finisher.

Position the top tether strap between the head restraint and the seatback and secure it to the

tether anchorage that provides the straightest installation. Tighten the tether strap according to the manufacturer's instruction to remove any slack.

CHILD RESTRAINT INSTALLATION USING ISOFIX

WARNING:

- Attach ISOFIX child restraints only at the specified locations. For the ISOFIX lower anchor locations, see "ISOFIX child restraint system" (P.1-13). If a child restraint is not secured properly, your child could be seriously injured or killed in an accident.
- Do not install child restraints that require the use of a top tether strap to seating positions that do not have a top tether anchor.
- Do not secure a child restraint in the center rear seating position using the ISOFIX lower anchors. The child restraint will not be secured properly.
- Inspect the lower anchors by inserting your fingers into the lower anchor area and feeling to make sure there are no obstructions over the ISOFIX anchors, such as seat belt webbing or seat cushion material. The child restraint will not be secured properly if the ISOFIX anchors are obstructed.
- Child restraint anchorages are designed to withstand only those loads imposed by correctly fitted child restraints. Under no circumstances are they to be used for adult seat belts, harnesses or for attaching other items or equipment to the vehicle. Doing so could damage the child

restraint anchorages. The child restraint will not be properly installed using the damaged anchorage, and a child could be seriously injured or killed in a collision.

Installation on rear outboard seats

Front-facing:

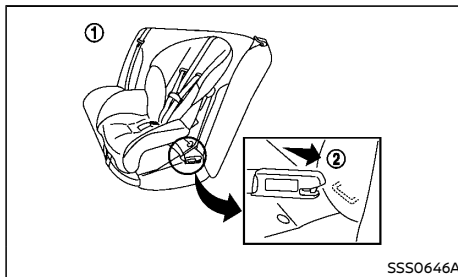

Front-facing: Steps 1 and 2

Be sure to follow the manufacturer's instructions for the proper use of your child restraint. Follow these steps to install a front-facing child restraint on the rear outboard seats using ISOFIX:

1. Position the child restraint on the seat ①.
2. Secure the child restraint anchor attachments to the ISOFIX lower anchors ②.
3. The back of the child restraint should be secured against the vehicle seatback.

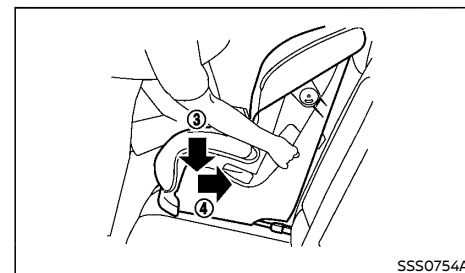

Front-facing: Step 4

4. Shorten the rigid attachment to have the child restraint firmly tightened; press downward ③ and rearward ④ firmly in the center of the child restraint with your knee to compress the vehicle seat cushion and seatback.
5. If the child restraint is equipped with a top tether strap, route the top tether strap and secure the tether strap to the tether anchor point. (See "Child restraint anchorage" (P.1-14).)
6. If the child restraint is equipped with other anti-rotation devices such as support legs, use them instead of the top tether strap following the child restraint manufacturer's instructions.

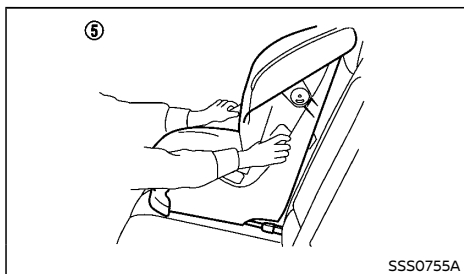

Front-facing: Step 7

7. Test the child restraint before you place the child in it ⑤. Push the child restraint from side to side and tug it forward to make sure that it is held securely in place.
8. Check to make sure that the child restraint is properly secured prior to each use. If the child restraint is loose, repeat steps 3 through 7.

Rear-facing:

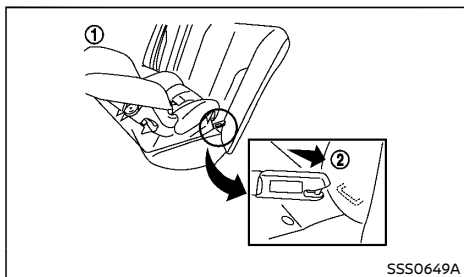

Rear-facing: Steps 1 and 2

Be sure to follow the manufacturer's instructions for the proper use of your child restraint. Follow these steps to install a rear-facing child restraint on the rear outboard seats using

ISOFIX:

1. Position the child restraint on the seat ①.
2. Secure the child restraint anchor attachments to the ISOFIX lower anchors ②.

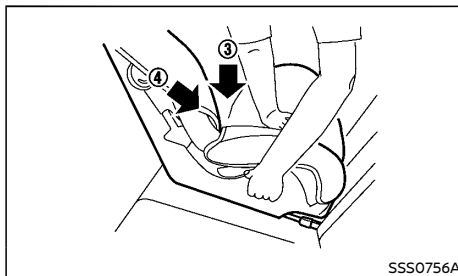

Rear-facing: Step 3

3. Shorten the rigid attachment to have the child restraint firmly tightened; press downward ③ and rearward ④ firmly in the center of the child restraint with your hand to compress the vehicle seat cushion and seatback.
4. If the child restraint is equipped with a top tether strap, route the top tether strap and secure the tether strap to the tether anchor point. (See "Child restraint anchorage" (P.1-14).)
5. If the child restraint is equipped with other anti-rotation devices such as support legs, use them instead of the top tether strap following the child restraint manufacturer's instructions.

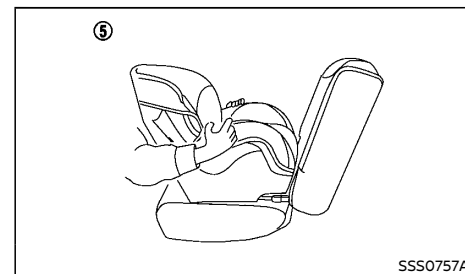

Rear-facing: Step 6

6. Test the child restraint before you place the child in it ⑤. Push the child restraint from side to side and tug it forward to make sure that it is held securely in place.
7. Check to make sure that the child restraint is properly secured prior to each use. If the child restraint is loose, repeat steps 3 through 6.

CHILD RESTRAINT INSTALLATION USING THREE-POINT TYPE SEAT BELT

Installation on rear seats

Front-facing:

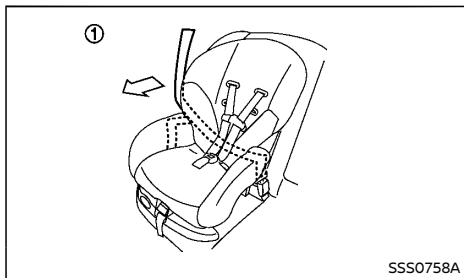

Step 1

Be sure to follow the manufacturer's instructions for the proper use of your child restraint. Follow these steps to install a front-facing child restraint on the rear seats using three-point type seat belt without automatic locking mode:

1. Position the child restraint on the seat ①.

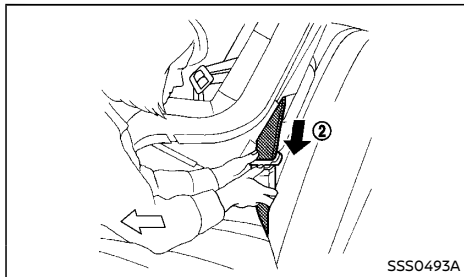

Step 2

2. Route the seat belt tongue through the child restraint and insert it into the buckle ② until you hear and feel the latch engage.
3. To prevent slack in the seat belt webbing, it is necessary to secure the seat belt in place with locking devices attached to the child restraint.

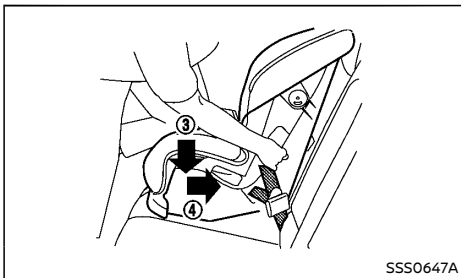

Step 4

4. Remove any additional slack from the seat belt; press downward ③ and rearward ④ firmly in the center of the child restraint with your knee to compress the vehicle seat cushion and seatback while pulling up on the seat belt.

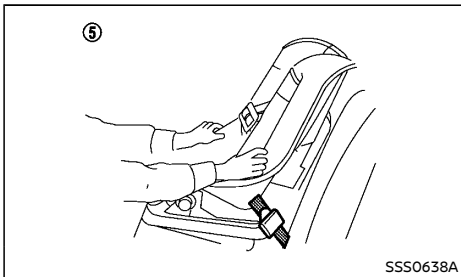

Step 5

5. Test the child restraint before you place the child in it ⑤. Push the child restraint from side to side and tug it forward to make sure that it is held securely in place.
6. Check to make sure that the child restraint is properly secured prior to each use. If the child restraint is loose, repeat steps 3 through 5.

Rear-facing:

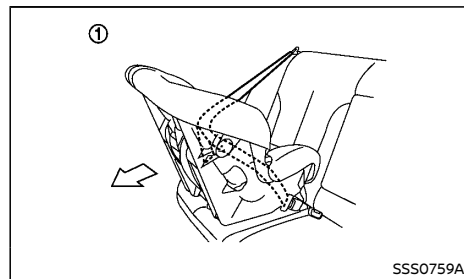

Step 1

Be sure to follow the manufacturer's instructions for the proper use of your child restraint. Follow these steps to install a rear-facing child restraint on the rear seats using three-point type seat belt without automatic locking mode:

1. Position the child restraint on the seat ①.

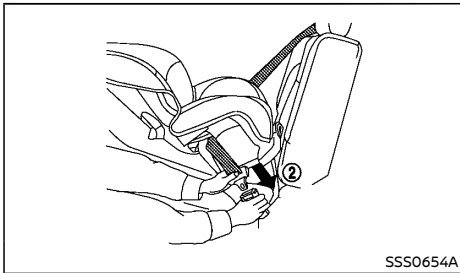

Step 2

2. Route the seat belt tongue through the child restraint and insert it into the buckle ② until you hear and feel the latch engage.
3. To prevent slack in the seat belt webbing, it is necessary to secure the seat belt in place with locking devices attached to the child restraint.

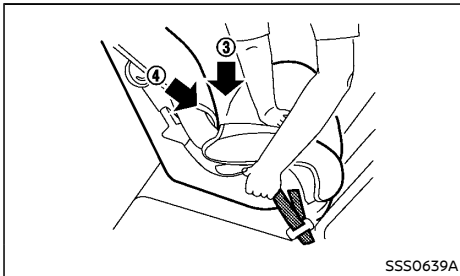

Step 4

4. Remove any additional slack from the seat belt; press downward ③ and rearward ④ firmly in the center of the child restraint with your hand to compress the vehicle seat cushion and seatback while pulling up on the seat belt.

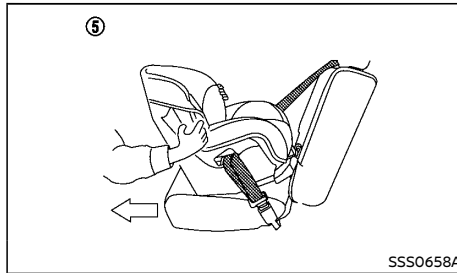

Step 5

5. Test the child restraint before you place the child in it ⑤. Push the child restraint from side to side and tug it forward to make sure that it is held securely in place.
6. Check to make sure that the child restraint is properly secured prior to each use. If the child restraint is loose, repeat steps 3 through 5.

Installation on front passenger's seat

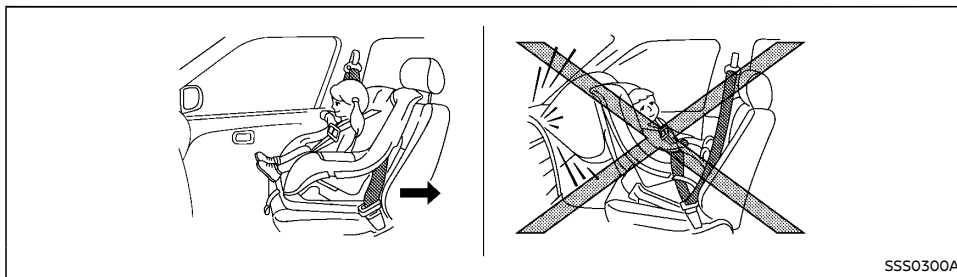

WARNING:

- Never install a rear-facing child restraint on the front passenger's seat when the front passenger's air bag is available. Supplemental front-impact air bags inflate with great force. A rear-facing child restraint could be struck by the supplemental front-impact air bags in an accident and could seriously injure or kill your child.
- Never install a child restraint with a top tether strap on the front seat.
- NISSAN recommends that a child restraint be installed on the rear seat. However, if you must install a child restraint on the front passenger's seat, move the passenger's seat to the rearmost position.
- Child restraints for infants must be used in the rear-facing direction and therefore must not be used on the front passenger's seat when the front passenger's air bag is available.

Front-facing:

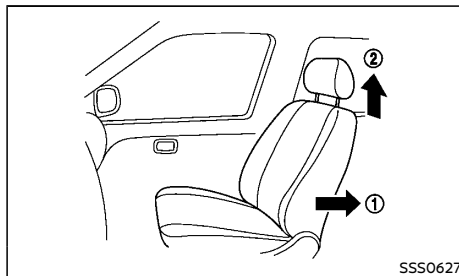

Steps 1 and 2

Be sure to follow the manufacturer's instructions for the proper use of your child restraint. Follow these steps to install a front-facing child restraint on the front passenger's seat using three-point type seat belt without automatic locking mode:

1. Move the seat to the rearmost position ①.
2. Adjust the head restraint to its highest position ②.

3. Position the child restraint in the seat.

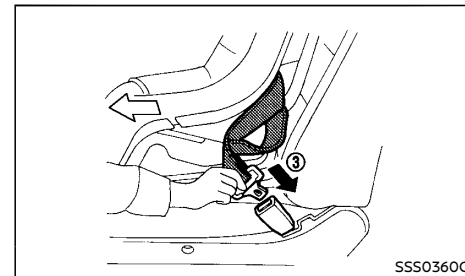

Step 4

4. Route the seat belt tongue through the child restraint and insert it into the buckle ③ until you hear and feel the latch engage.
5. To prevent slack in the seat belt webbing, it is necessary to secure the seat belt in place with locking devices attached to the child restraint.

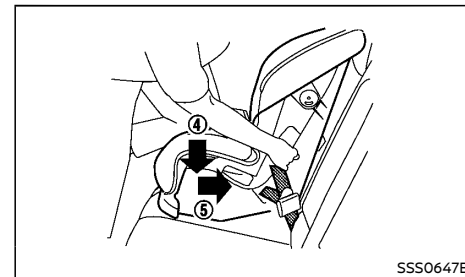

Step 6

6. Remove any additional slack from the seat belt; press downward ④ and rearward ⑤ firmly in the center of the child restraint with your knee to compress the vehicle seat cushion and seatback while pulling up

SUPPLEMENTAL RESTRAINT SYSTEM (SRS)

on the seat belt.

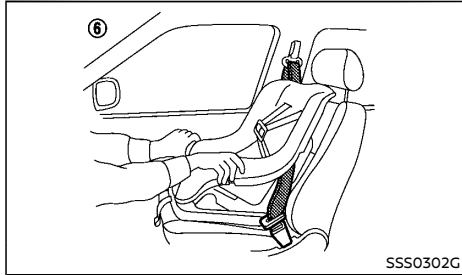

Step 7

7. Test the child restraint before you place the child in it ⑥. Push the child restraint from side to side and tug it forward to make sure that it is held securely in place.
8. Check to make sure that the child restraint is properly secured prior to each use. If the child restraint is loose, repeat steps 5 through 7.

PRECAUTIONS ON SUPPLEMENTAL RESTRAINT SYSTEM (SRS)

This Supplemental Restraint System (SRS) section contains important information concerning the driver's and passenger's supplemental front-impact air bags, supplemental side-impact air bags, supplemental curtain side-impact air bags and pre-tensioner seat belts.

Supplemental front-impact air bag system

This system can help cushion the impact force to the head and chest area of the driver and/or front passenger in certain frontal collisions. The supplemental front-impact air bag is designed to inflate on the front where the vehicle is impacted.

Supplemental side-impact air bag system

This system can help cushion the impact force to the chest and pelvis area of the driver and front passenger in certain side-impact collisions. The supplemental side-impact air bag is designed to inflate on the side where the vehicle is impacted.

Supplemental curtain side-impact air bag system

This system can help cushion the impact force to the head of the driver and passengers in front and rear outboard seating positions in certain side-impact collisions. The supplemental curtain side-impact air bag is designed to inflate on the side where the vehicle is impacted.

The SRS is designed to **supplement** the accident protection provided by the driver's and passenger's seat belts and **is not** designed to

substitute for them. The SRS can help save lives and reduce serious injuries. However, inflating air bags may cause abrasions or other injuries. Air bags do not provide protection to the lower body. Seat belts should always be correctly worn and the occupants should always be seated a suitable distance away from the steering wheel and instrument panel. (See "Seat belts" (P.1-9).) The air bags inflate quickly in order to help protect the occupants. The force of the air bags inflating can increase the risk of injury if the occupants are too close to, or are against, the air bag modules during inflation. The air bags will deflate quickly after deployment.

The SRS operates only when the ignition switch is in the "ON" position.

When the ignition switch is in the "ON" position, the SRS air bag warning light illuminates for about 7 seconds and then turns off. This indicates that the SRS air bag system is operational. (See "SRS air bag warning light" (P.1-24).)

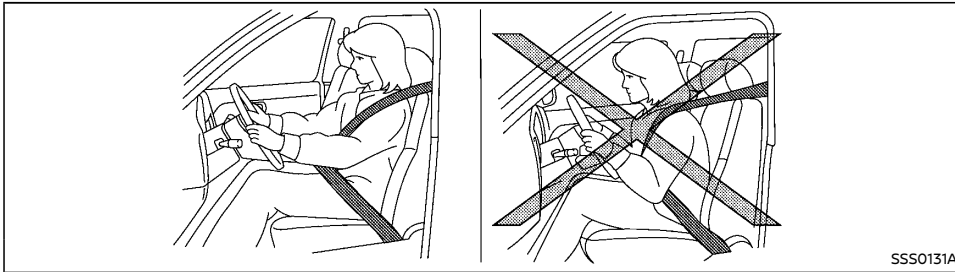

SSS0131A

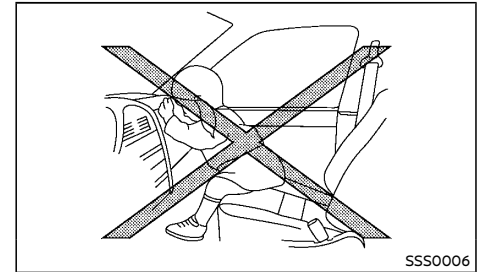

SSS0006

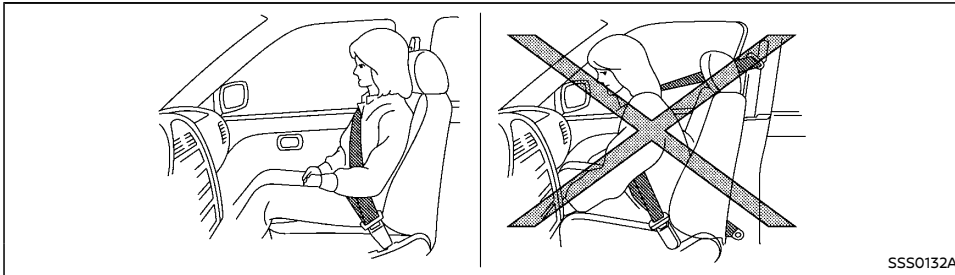

SSS0132A

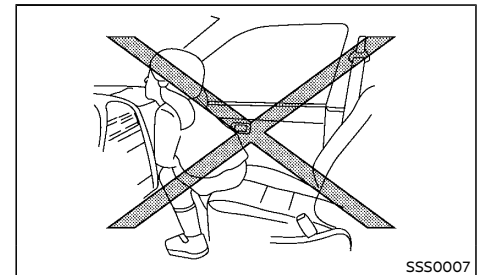

SSS0007



WARNING:

- The supplemental front-impact air bags ordinarily will not inflate in the event of a side impact, rear impact, rollover, or lower severity frontal collision. Always wear the seat belts to help reduce the risk or severity of injury in accidents.
- The seat belts and the supplemental front-impact air bags are most effective when you are sitting well back and upright in the seat. The front-impact air bags inflate with great force. If you and your passengers are unrestrained, leaning forward, sitting sideways, or out of

position in any way, you and your passengers are at greater risk of injury or death in an accident. You and your passengers may also receive serious or fatal injuries from the supplemental front-impact air bag if you are up against it when it inflates. Always sit back against the seatback and as far away as practical from the steering wheel or instrument panel. Always use the seat belts.

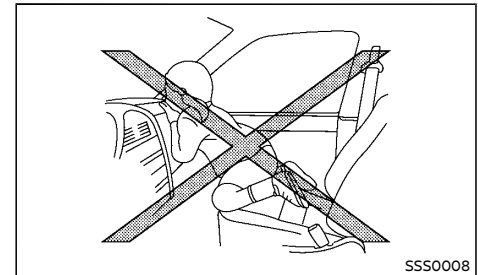

SSS0008

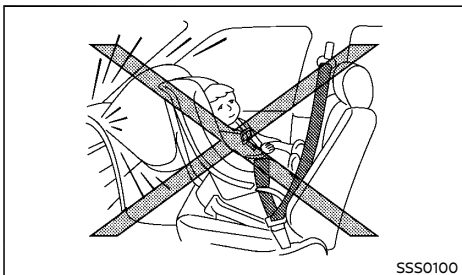
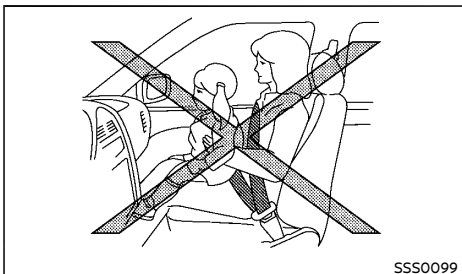
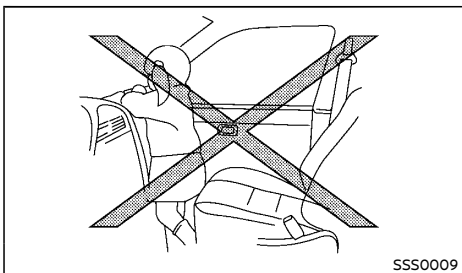

⚠ WARNING:

- Never let children ride unrestrained or extend their hands or face out of the window. Do not attempt to hold them in your lap or arms. Some examples of dangerous riding positions are shown in the illustrations.
- Children may be severely injured or killed when the supplemental front-impact air bags, supplemental side-impact air bags, or supplemental curtain side-impact air bags inflate if they are not properly restrained.
- Never install a rear-facing child restraint system on the front seat. An inflating supplemental front-impact air bag could seriously injure or kill your child. (See "Child restraints" (P.1-13).)

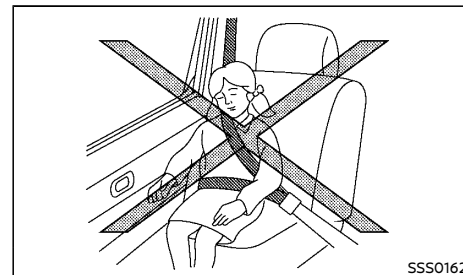
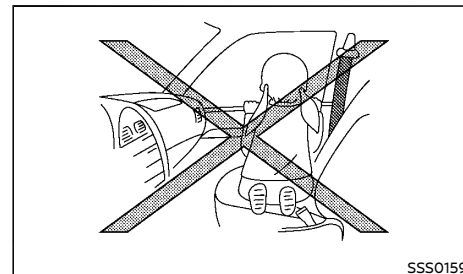
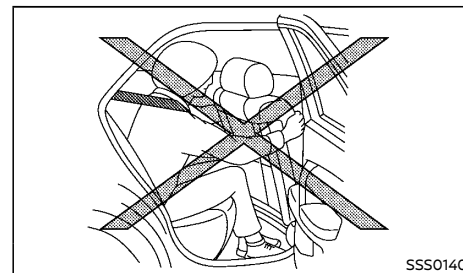
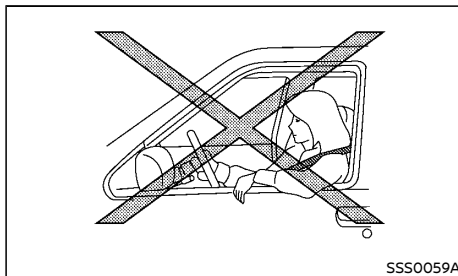



WARNING:

- The supplemental side-impact air bags and supplemental curtain side-impact air bags ordinarily will not inflate in the event of a front impact, rear impact, rollover, or lower severity side collision. Always wear the seat belts to help reduce the risk or severity of injury in accidents.
- The seat belts and the supplemental side-impact air bags and supplemental curtain side-impact air bags are most effective when you are sitting well back and upright in the seat. The supplemental side-impact air bags and supplemental curtain side-impact air bags inflate with great force. If you and your passengers are unrestrained, leaning forward, sitting sideways, or out of position in any way, you and your passengers are at greater risk of injury or death in an accident.
- Do not allow anyone to place their hands, legs, or face near the supplemental side-impact air bags and supplemental curtain side-impact air bags on the sides of the seatback of the front seats or near the side roof rails. Do not allow anyone sitting in the front seats or rear outboard seats to extend their hands out of the windows or lean against the doors. Some examples of dangerous riding positions are shown in the illustrations.
- When sitting in the rear seats, do not hold onto the seatback of the front seats. If the supplemental side-impact air bags and supplemental curtain side-impact air bags inflate, you may be seriously injured. Be especially careful with children, who should always be properly restrained.

- Do not use seat covers on the front seatbacks. They may interfere with the supplemental side-impact air bag inflations.

Pre-tensioner seat belt system (if equipped)

The pre-tensioner seat belt system may activate with the supplemental air bag system in certain types of collisions. Working with the seat belt retractor and anchor, it helps tighten the seat belt the instant the vehicle becomes involved in certain types of collisions, helping to restrain front seat occupants. (See "Pre-tensioner seat belt system" (P.1-27).)

Air bag warning labels

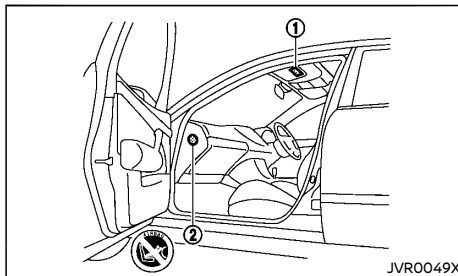

Warning labels about the supplemental air bag system are placed in the vehicle as shown in the illustration.

The warning label ① is located on the surface of the driver's and/or passenger's sun visor.

The warning label ② is located on the side of the passenger's side instrument panel.

The label(s) warn you not to fit a rear-facing child restraint system on the front passenger seat as such a restraint system used in this

position could cause serious injury to the infant in case of air bag deployment during a collision.



① Air bag warning label

The label ① warns:

"NEVER use a rearward facing child restraint on a seat protected by an ACTIVE AIRBAG in front of it, DEATH or SERIOUS INJURY to the CHILD can occur."

In vehicles equipped with a front-impact passenger air bag system, use a rear-facing child restraint system only on the rear seats.

When installing a child restraint system in your vehicle, always follow the child restraint system manufacturer's instructions for installation. For additional information, see "Child restraints" (P.1-13).

SRS air bag warning light



The supplemental air bag warning light, displaying  in the instrument panel, monitors the circuits for the air bag systems, pre-tensioner seat belt systems and all related wiring.

When the ignition switch is in the "ON" position, the SRS air bag warning light illuminates for about 7 seconds and then turns off. This indicates that the SRS air bag systems are operational.

If any of the following conditions occur, the air bag and/or pre-tensioner seat belt systems need servicing:

- The SRS air bag warning light remains on after approximately 7 seconds.
- The SRS air bag warning light flashes intermittently.
- The SRS air bag warning light does not illuminate at all.

Under these conditions, the air bag and/or the pre-tensioner seat belt systems may not operate properly. They must be checked and repaired. Contact a NISSAN dealer immediately.

SUPPLEMENTAL AIR BAG SYSTEMS

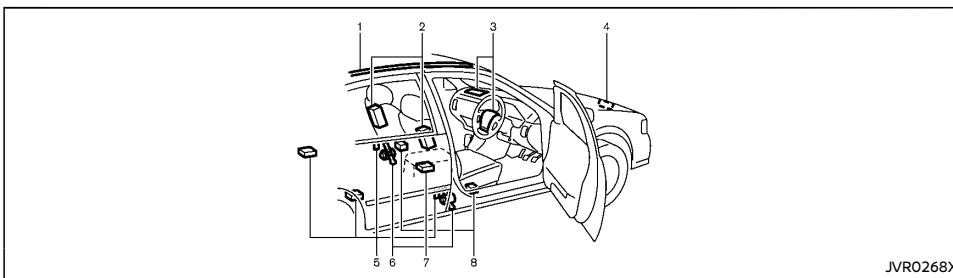

1. Supplemental curtain side-impact air bag modules
2. Supplemental side-impact air bag modules
3. Supplemental front-impact air bag modules
4. Crash zone sensor
5. Satellite sensors
6. Pre-tensioner seat belt retractors
7. Air bag Control Unit (ACU)
8. Lap outer pre-tensioner (driver's and/or passenger's side)



WARNING:

- **Do not place any objects on the steering wheel pad, on the instrument panel, and near the front door finishers and the front seats. Do not place any objects between any occupants and the steering wheel pad, on the instrument panel, and near the front door finishers and the front seats. Such objects may become dangerous projectiles and cause injury if a supplemental air bag inflates.**
- **Immediately after inflation, several supplemental air bag system components will be hot. Do not touch them: you may severely burn yourself.**
- **No unauthorized changes should be made to any components or wiring of the supplemental air bag systems. This is to prevent accidental inflation of the supplemental air bags or damage to the supplemental air bag systems.**
- **Do not make unauthorized changes to your vehicle's electrical system, suspension system, front end structure, and side panels. This could affect proper operation of the supplemental air bag systems.**
- **Tampering with the supplemental air bag systems may result in serious personal injury. Tampering includes changes to the steering wheel and the instrument panel by placing materials over the steering wheel pad and above, around or on the instrument panel or by installing additional trim materials around the supplemental air bag systems.**

- **Work around and on the supplemental air bag systems should be done by a NISSAN dealer. The SRS wiring should not be modified or disconnected. Unauthorized electrical test equipment and probing devices should not be used on the supplemental air bag systems.**
- **The SRS wiring harness connectors are yellow and/or orange for easy identification.**

When the air bags inflate, a fairly loud noise may be heard, followed by the release of smoke. This smoke is not harmful and does not indicate a fire. Care should be taken not to inhale it, as it may cause irritation and choking. Those with a history of a breathing condition should get fresh air promptly.

Supplemental front-impact air bag system

The driver's supplemental front-impact air bag is located at the center of the steering wheel. The passenger's supplemental front-impact air bag is located at the instrument panel above the glove box.

The supplemental front-impact air bag system is designed to inflate in higher severity frontal collisions, although it may inflate if the forces in another type of collision are similar to those of a higher severity frontal impact. It may not inflate in certain frontal collisions. Vehicle damage (or lack of it) is not always an indication of proper supplemental front-impact air bag system operation.

Supplemental side-impact air bag system

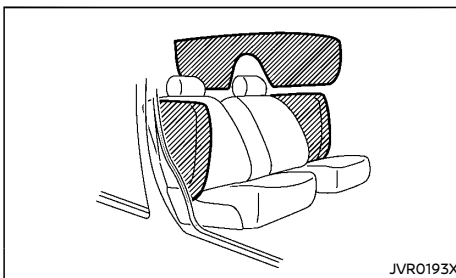

The supplemental side-impact air bag is located at the outside of the front seats' seat-backs.

The supplemental side-impact air bag system is designed to inflate in higher severity side collisions, although it may inflate if the forces in another type of collision are similar to those of a higher severity side impact. It may not inflate in certain side collisions. Vehicle damage (or lack of it) is not always an indication of proper supplemental side-impact air bag system operation.

Supplemental curtain side-impact air bag system

The supplemental curtain side-impact air bag is located at the roof rails.

The supplemental curtain side-impact air bag system is designed to inflate in higher severity side collisions, although it may inflate if the forces in another type of collision are similar to those of a higher severity side impact. It may not inflate in certain side collisions. Vehicle damage (or lack of it) is not always an indication of proper supplemental curtain side-im-

part air bag system operation.

SRS AIR BAG DEPLOYMENT CONDITIONS

The SRS air bags activate in the event of a front or side impact in which the vehicle occupants may be severely injured even if they are wearing the seat belts properly.

They may not activate when the crash energy is absorbed and/or distributed by the vehicle body. Vehicle damage (or lack of it) is not always an indication of proper SRS air bag system operation.

When the SRS air bag will deploy

Supplemental front-impact air bags:

The supplemental front-impact air bag system is designed to inflate in higher severity frontal collisions. Some examples are shown in the following illustrations.

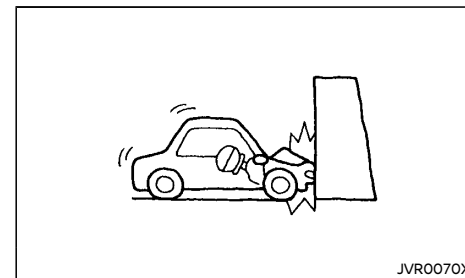

The supplemental front-impact air bag system will deploy in the event of an impact which exceeds a 25 km/h (16 MPH) frontal collision with a solid wall that does not move or deform.

The supplemental front-impact air bag system may also deploy when the vehicle receives

severe damage to the undercarriage.

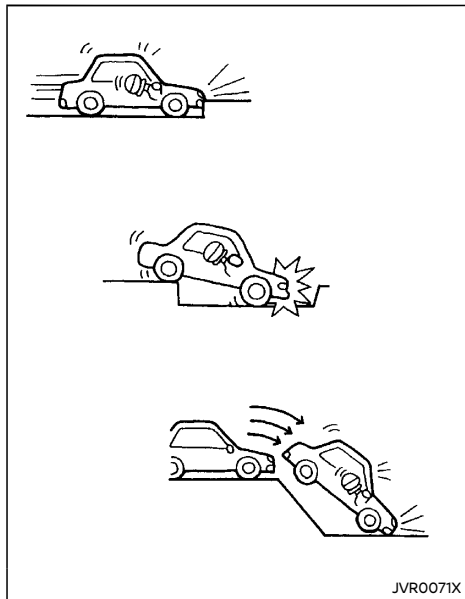

- Hitting a curb, pavement edge or hard surface at high speed
- Falling into a deep hole or ditch
- Landing hard on the ground after jumping

Supplemental side-impact and curtain side-impact air bags:

The supplemental side-impact and curtain side-impact air bag systems are designed to inflate in higher severity side collisions. Some examples are shown in the following illustrations.

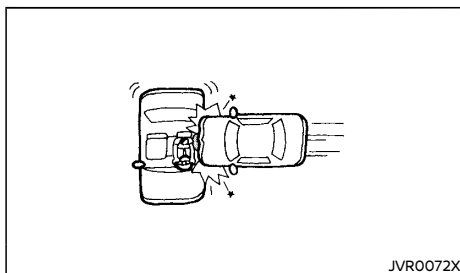

(supplemental side-impact air bag system)

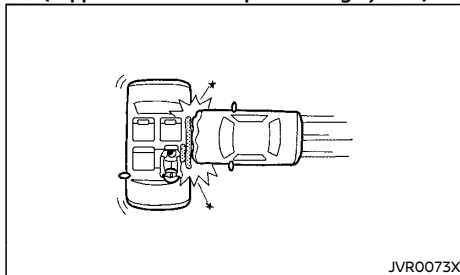

(supplemental curtain side-impact air bag system)

- The supplemental side-impact and curtain side-impact air bags will deploy in the event of a side impact with a normal passenger vehicle that exceeds at a speed of 25 km/h (16 MPH).

When the SRS air bag is unlikely to deploy

The SRS air bags may not deploy in cases where the impact is not forceful enough to inflate the SRS air bags.

For example, if the vehicle strikes an object, such as a parked vehicle or sign pole, which can move or deform on impact, the SRS air bags are

unlikely to deploy.

Supplemental front-impact air bags:

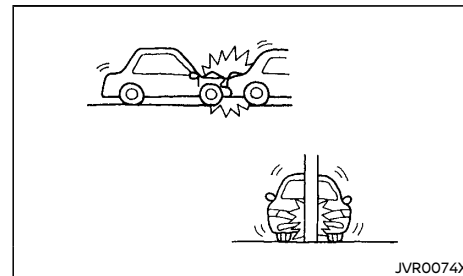

- Striking a vehicle of the same class that is parked
- Crashing into a solid utility pole

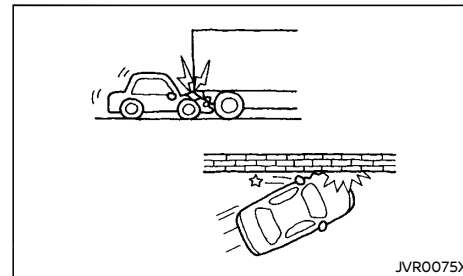

- Running under the tail gate of a truck
- A frontal offset impact to the guard rails

Supplemental side-impact and curtain side-impact air bags:

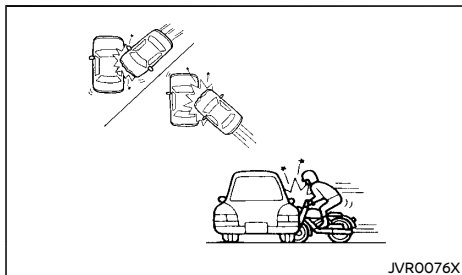

- A collision from the side at an angle
- A side impact with a two-wheeled vehicle

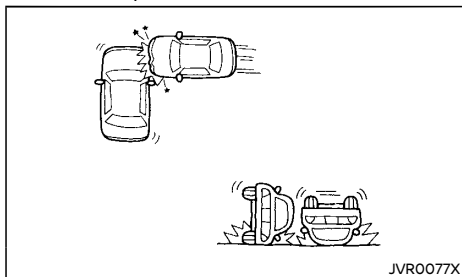

- A collision from the side impacting the vehicle engine room (trunk)
- Vehicle rollover

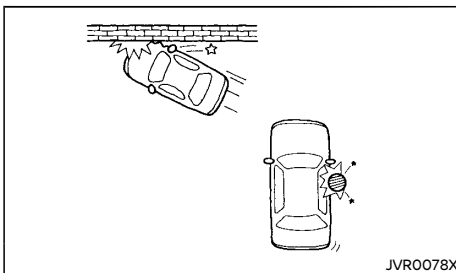

- A frontal offset impact to the guard rails
- A collision with a pole

When the SRS air bag will not deploy

Once the SRS air bag has inflated, the air bag module will not function again if your vehicle collides with another vehicle or an object.

Other examples where the SRS air bag will not deploy are shown in the following illustrations.

Supplemental front-impact air bags:

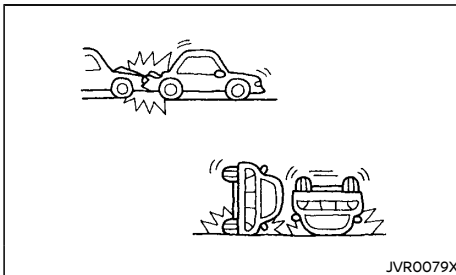

- A collision from the side or rear
- Vehicle rollover

Supplemental side-impact and curtain side-impact air bags:

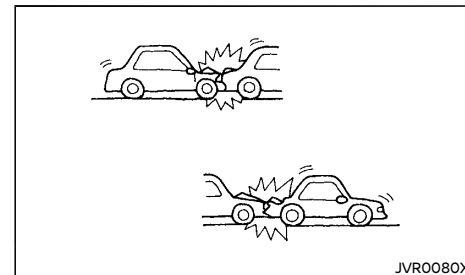

- A frontal collision with a parked or moving vehicle
- A rear collision

PRE-TENSIONER SEAT BELT SYSTEM



WARNING:

- The pre-tensioner seat belt cannot be reused after activation. It must be replaced together with the retractor and buckle as a unit.
- If the vehicle becomes involved in a collision but the pre-tensioner is not activated, be sure to have the pre-tensioner system checked and, if necessary, replaced by a NISSAN dealer.
- No unauthorized changes should be made to any components or wiring of the pre-tensioner seat belt system. This is to prevent accidental activation of the pre-tensioner seat belt or damage to the pre-tensioner seat belt system.

- **Work around or on the pre-tensioner seat belt system should be done by a NISSAN dealer. The SRS wiring should not be modified or disconnected. Unauthorized electrical test equipment and probing devices should not be used on the pre-tensioner seat belt system.**
- **If you need to dispose of the pre-tensioner seat belt system, or scrap the vehicle, contact a NISSAN dealer. Correct pre-tensioner disposal procedures are set forth in the appropriate NISSAN Service Manual. Incorrect disposal procedures could cause personal injury.**

The pre-tensioner system may activate with the supplemental air bag system in certain types of collisions. Working with the seat belt retractor, it helps tighten the seat belt when the vehicle becomes involved in certain types of collisions, helping to restrain front seat occupants.

The pre-tensioner is encased with the front seat belt's retractor and anchor. These seat belts are used the same as conventional seat belts.

When the pre-tensioner seat belt activates, a fairly loud noise may be heard, followed by the release of smoke. This smoke is not harmful and does not indicate a fire. Care should be taken not to inhale it, as it may cause irritation and choking. Those with a history of a breathing condition should get fresh air promptly.

REPAIR AND REPLACEMENT PROCEDURE



WARNING:

- **Once the air bags have been inflated, the air bag modules will not function and must be replaced. The air bag modules must be replaced by a NISSAN dealer. The inflated air bag modules cannot be repaired.**
- **The air bag systems should be inspected by a NISSAN dealer if there is any damage to the front end portion of the vehicle.**
- **If you need to dispose of the SRS or scrap the vehicle, contact a NISSAN dealer. Correct disposal procedures are set forth in the appropriate NISSAN Service Manual. Incorrect disposal procedures could cause personal injury.**

The air bags and pre-tensioner seat belts are designed to activate on a one-time-only basis. As a reminder, unless the SRS air bag warning light is damaged, the SRS air bag warning light remains illuminated after inflation has occurred. The repair and replacement of the SRS should be done only by a NISSAN dealer.

When maintenance work is required on the vehicle, information about the air bags, pre-tensioner seat belts and related parts should be pointed out to the person performing the maintenance. The ignition switch should always be in the "LOCK" position when working under the hood or inside the vehicle.

2 Instruments and controls

Cockpit	2-2	Wiper and washer switch	2-22
Instrument panel	2-3	Windshield wiper and washer switch	2-22
Meters and gauges	2-4	Rain-sensing auto wiper system (if equipped)	2-23
Speedometer	2-4	Defogger switch	2-23
Odometer	2-4	Horn	2-24
Continuously Variable Transmission (CVT) position indicator	2-5	Windows	2-24
Tachometer	2-5	Power windows	2-24
Engine coolant temperature gauge	2-5	Sunroof (if equipped)	2-26
Fuel gauge	2-5	Automatic sunroof	2-26
Instrument brightness control	2-6	Rear sunshade (if equipped)	2-27
Warning lights, indicator lights and audible reminders	2-7	Power outlet	2-27
Checking lights	2-8	Storage	2-28
Warning lights	2-8	Glove box	2-28
Indicator lights	2-10	Console box	2-28
Audible reminders	2-11	Cup holders	2-29
Vehicle information display	2-11	Sunglasses holder	2-29
How to use the vehicle information display	2-12	Coat hook	2-30
Startup display	2-12	Trunk hooks	2-30
Settings	2-12	Map pockets	2-30
Vehicle information display warnings and indicators	2-17	Sun visors	2-30
Headlight and turn signal switch	2-20	Interior lights	2-31
Headlight switch	2-20	Interior light switch	2-31
Automatic aiming control	2-21	Console light (if equipped)	2-31
Battery saver system	2-21	Map lights	2-31
Turn signal switch	2-21	Rear personal lights	2-31
Fog light switch	2-22	Trunk light	2-31
Front fog lights	2-22	Vanity mirror light	2-31
		Battery saver system	2-32

COCKPIT

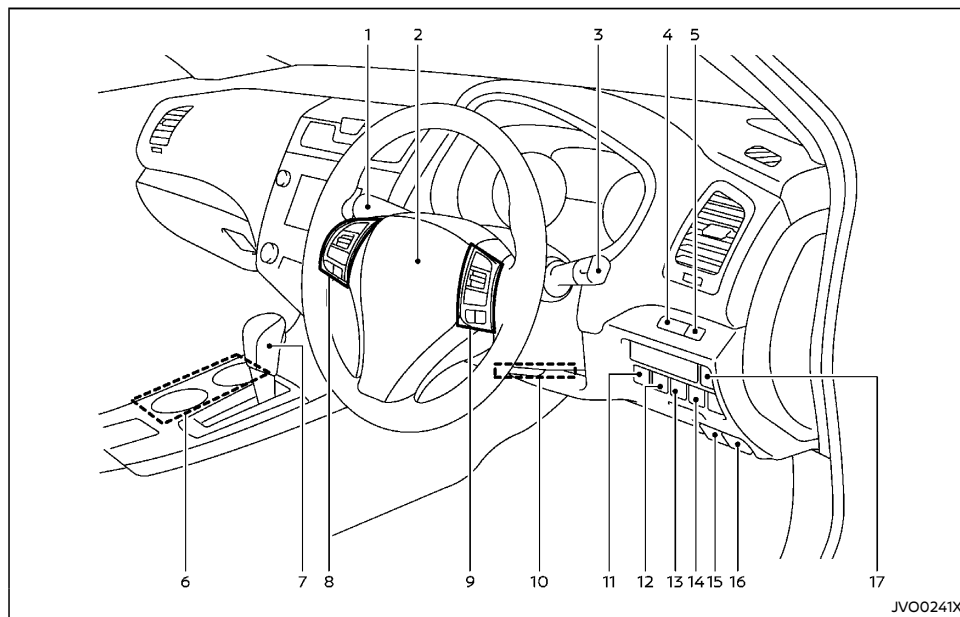

- | | |
|--|--|
| 1. Wiper and washer switch | 4. Instrument brightness control |
| 2. Steering wheel | 5. TRIP/RESET switch |
| – Power steering | 6. Cup holders |
| – Horn | 7. Shift lever |
| – Driver's supplemental front-impact air bag | – Driving vehicle |
| 3. Headlight, fog light and turn signal switch | – Rear view monitor* |
| – Headlight | – Intelligent Around View Monitor* |
| – Turn signal | 8. Steering-wheel-mounted controls (left side) |
| – Fog light | – Audio control steering switch |

- Vehicle information display control switch
9. Steering-wheel-mounted controls (right side)
- Cruise control main/set switch
 - Bluetooth® Hands-Free Phone System switch
10. Tilting/telescopic steering wheel lever
11. Warning systems switch*
12. ECO switch
13. Rear sunshade switch*
14. Vehicle Dynamic Control (VDC) OFF switch
15. Hood release handle
16. Fuel-filler lid opener handle
17. Trunk lid opener
- *: if equipped

INSTRUMENT PANEL

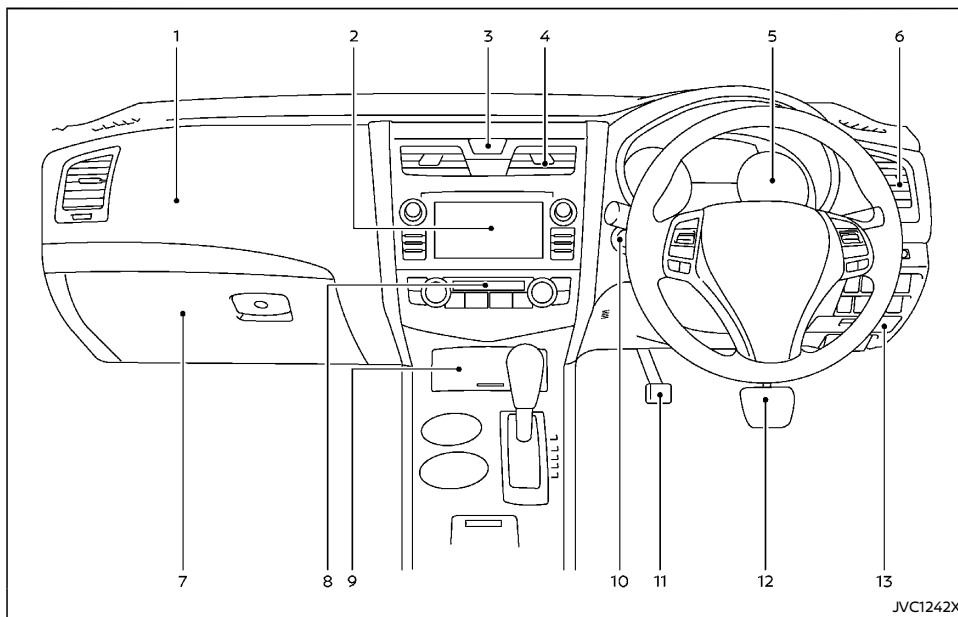

*: if equipped

**:
Refer to the separate Navigation System Owner's Manual (if equipped).

- | | |
|--|--|
| 1. Passenger's front-impact air bag | 7. Glove box |
| 2. Audio system or center display
— Rear view monitor*
— Intelligent Around View Monitor*
— Navigation system** | 8. Heater/air conditioner control
— Defogger switch |
| 3. Hazard indicator flasher switch | 9. Power outlet/USB connection port/iPod connector/AUX input jack* |
| 4. Center ventilator | 10. Push-button ignition switch |
| 5. Meters and gauges | 11. Parking brake |
| 6. Side ventilator | 12. Brake pedal |
| | 13. Fuse box cover |

METERS AND GAUGES

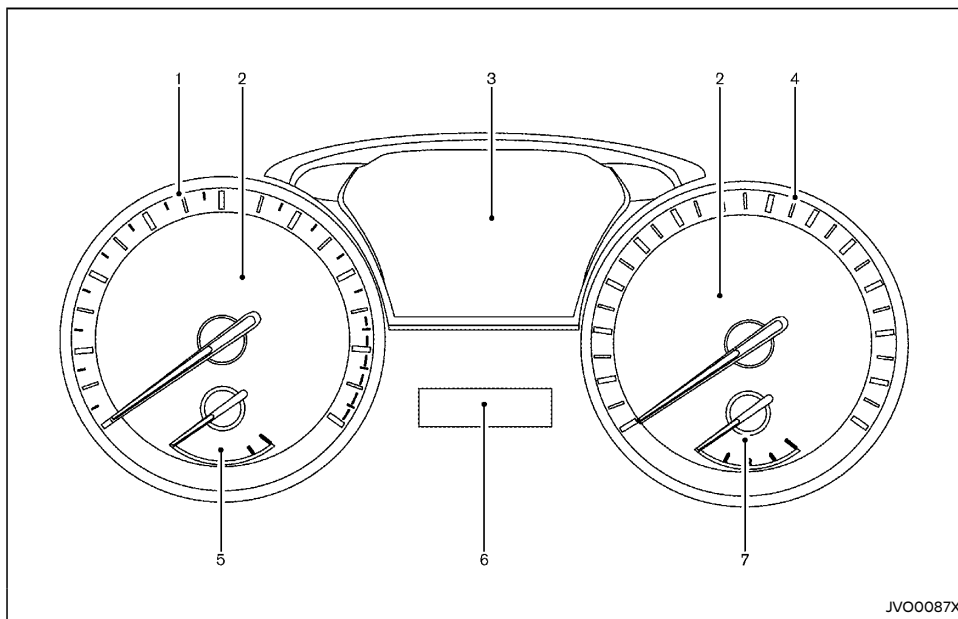

1. Tachometer
2. Warning and indicator lights
3. Vehicle information display
 - Vehicle information display warnings and indicators
 - ECO mode system
 - Startup display
 - Settings
4. Speedometer
5. Engine coolant temperature gauge
6. Odometer/twin trip odometer/Continuously Variable Transmission (CVT) position indicator
7. Fuel gauge

SPEEDOMETER

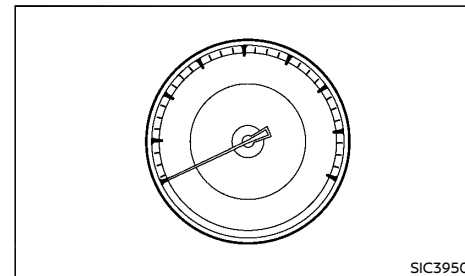

The speedometer indicates the vehicle speed.

ODOMETER

Odometer/Twin trip odometer

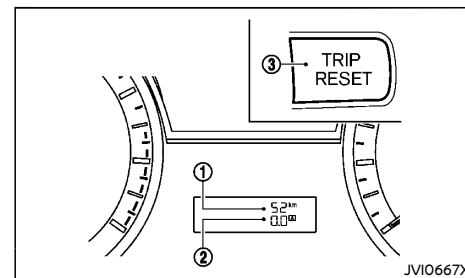

The odometer ① and the twin trip odometer ② are displayed below the vehicle information display when the ignition switch is placed in the "ON" position.

The odometer records the total distance the vehicle has been driven.

The twin trip odometer records the distance of individual trips.

Changing twin trip odometer display:

Push the TRIP/RESET switch ③ (located on the instrument panel) to change the display as follows:

TRIP A → TRIP B → TRIP A

Resetting twin trip odometer:

Push the TRIP/RESET switch ③ for more than 1 second to reset the trip odometer to zero.

CONTINUOUSLY VARIABLE TRANSMISSION (CVT) POSITION INDICATOR

The Continuously Variable Transmission (CVT) position indicator indicates the shift lever position when the ignition switch is in the "ON" position.

TACHOMETER

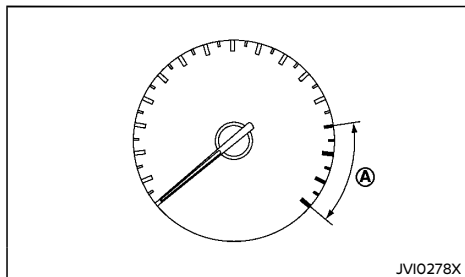

The tachometer indicates the engine speed in revolutions per minute (rpm). **Do not rev the engine into the red zone A.**

The red zone varies with models.

ENGINE COOLANT TEMPERATURE GAUGE

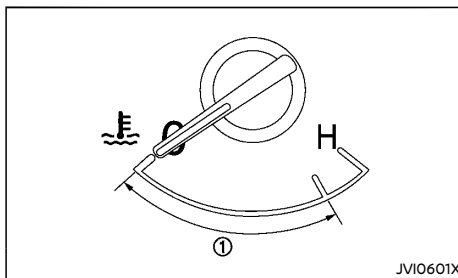

The engine coolant temperature gauge indicates the engine coolant temperature.

The engine coolant temperature is normal within the range ① shown in the illustration.

The engine coolant temperature will vary with the outside air temperature and driving conditions.

⚠ CAUTION:

- If the gauge indicates engine coolant temperature near the hot (H) end of the normal range, reduce vehicle speed to decrease temperature.
- If the gauge is over the normal range, stop the vehicle as soon as safely possible.
- If the engine is overheated, continued operation of the vehicle may seriously damage the engine. (See "If your vehicle overheats" (P.6-7) for immediate action required.)

FUEL GAUGE

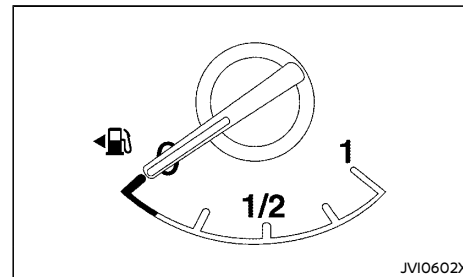

The fuel gauge indicates the approximate fuel level in the tank when the ignition switch is in the "ON" position.

The gauge may move slightly during braking, turning, accelerating, or going up and down hills due to movement of fuel in the tank.

The low fuel warning  appears on the vehicle information display when the fuel level in the tank is getting low. Refuel as soon as it is convenient, preferably before the gauge reads 0 (empty).

The arrow, , indicates the fuel-filler lid is located on the left side of the vehicle.

⚠ CAUTION:

Refuel before the gauge reads 0 (empty).

There is a small reserve of fuel in the tank when the fuel gauge reads 0 (empty).

INSTRUMENT BRIGHTNESS CONTROL

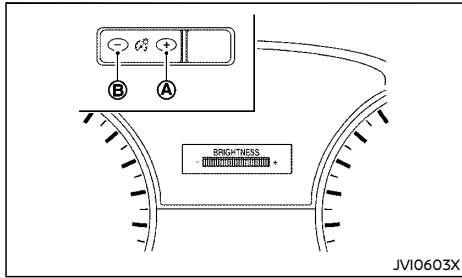

















Push the "+" side (A) to increase the brightness of meter panel lights.

Push the "-" side (B) to decrease the brightness of meter panel lights.

When the brightness level reaches the maximum or minimum, a beep will sound.



The vehicle information display returns to the normal display when the instrument brightness control switch is not operated for more than 5 seconds.





WARNING LIGHTS, INDICATOR LIGHTS AND AUDIBLE REMINDERS

	Anti-lock Braking System (ABS) warning light		Seat belt warning light		Security indicator light
	Brake warning light		Supplemental Restraint System (SRS) air bag warning light		Small light indicator light
	Charge warning light		Vehicle Dynamic Control (VDC) warning light		SPORT mode indicator light
	Hydraulic pump electric power steering warning light		Front fog light indicator light		Turn signals/hazard indicator lights
	Low fuel warning light		High beam indicator light		Vehicle Dynamic Control (VDC) off indicator light
	Master warning light		Malfunction Indicator Light (MIL)		

*: if equipped

CHECKING LIGHTS

With all doors closed, apply the parking brake, fasten the seat belts and place the ignition switch in the "ON" position without starting the engine. The following lights (if equipped) will come on: , , **PS**, .

The following lights (if equipped) will come on briefly and then go off: , , , **SPORT**,  .

If any light does not come on or operates in a way other than described, it may indicate a burned-out bulb and/or a system malfunction. Have the system checked, and if necessary repaired, by a NISSAN dealer promptly.

Some indicators and warnings are also displayed on the vehicle information display. (See "Vehicle information display" (P.2-11).)

WARNING LIGHTS

Anti-lock Braking System (ABS) warning light

When the ignition switch is in the "ON" position, the Anti-lock Braking System (ABS) warning light illuminates and then turns off. This indicates the ABS is operational.

If the ABS warning light illuminates while the engine is running, or while driving, it may indicate the ABS is not functioning properly. Have the system checked by a NISSAN dealer promptly.

If an ABS malfunction occurs, the anti-lock function is turned off. The brake system then operates normally, but without anti-lock assistance. (See "Brake system" (P.5-23).)

Brake warning light

WARNING:

- **If the brake fluid level is below the minimum mark on the brake fluid reservoir, do not drive the vehicle until the brake system has been checked by a NISSAN dealer.**
- **Even if you judge it to be safe, have your vehicle towed because driving it could be dangerous.**
- **Depressing the brake pedal without the engine running and/or with a low brake fluid level could increase the stopping distance and require greater pedal travel distance and effort.**

The brake warning light indicates the parking brake system operation, a low brake fluid level of the brake system and an Anti-lock Braking System (ABS) malfunction.

Parking brake warning indicator:

When the ignition switch is placed in the "ON" position, the brake warning light illuminates. When the engine is started and the parking brake is released, the brake warning light turns off.

If the parking brake is not fully released, the brake warning light remains on. Be sure that the brake warning light has turned off before driving. (See "Parking brake" (P.3-22).)

Low brake fluid warning indicator:

If the brake warning light illuminates while the engine is running, or while driving, and the parking brake is released, it may indicate the brake fluid level is low.

When the brake warning light illuminates while

driving, stop the vehicle safely as soon as possible. Stop the engine and check the brake fluid level. If the brake fluid level is at the minimum mark, add brake fluid as necessary. (See "Brake fluid" (P.8-12).)

If the brake fluid level is sufficient, have the brake system checked by a NISSAN dealer promptly.

Anti-lock Braking System (ABS) warning indicator:

When the parking brake is released and the brake fluid level is sufficient, if both the brake warning light and the Anti-lock Braking System (ABS) warning light illuminate, it may indicate the ABS is not functioning properly. Have the brake system checked, and if necessary repaired, by a NISSAN dealer promptly. (See "Anti-lock Braking System (ABS) warning light" (P.2-8).)

Charge warning light

When the ignition switch is in the "ON" position, the charge warning light illuminates. After starting the engine, the charge warning light turns off. This indicates the charging system is operational.

If the charge warning light illuminates while the engine is running, or while driving, it may indicate the charging system is not functioning properly and may need servicing.

When the charge warning light illuminates while driving, stop the vehicle safely as soon as possible. Stop the engine and check the alternator belt. If the alternator belt is loose, broken or missing, the charging system needs repair. (See "Drive belts" (P.8-9).)

If the alternator belt appears to be functioning correctly but the charge warning light remains

illuminated, have the charging system checked by a NISSAN dealer promptly.



CAUTION:

Do not continue driving if the alternator belt is loose, broken or missing.



Hydraulic pump electric power steering warning light

When the ignition switch is in the "ON" position, the hydraulic pump electric power steering warning light illuminates. After starting the engine, the hydraulic pump electric power steering warning light turns off. This indicates that the electric power steering is operational.

If the hydraulic pump electric power steering warning light illuminates while the engine is running, it may indicate the hydraulic pump electric power steering is not functioning properly and may need servicing. Have the hydraulic pump electric power steering checked by a NISSAN dealer. (See "Hydraulic pump electric power steering" (P.5-23).)



Low fuel warning light

This light illuminates when the fuel in the tank is getting low. Refuel as soon as it is convenient, preferably before the fuel gauge reaches the 0 (empty) position.

There will be a small reserve of fuel remaining in the tank when the fuel gauge reaches the 0 position.



Master warning light

When the ignition switch is in the "ON" position, the master warning light illuminates if any of the following are displayed on the vehicle information display.

- No Key Detected
- Key ID Incorrect
- Shift to Park
- Push ignition to OFF
- Release parking brake
- Low Fuel
- Low Washer Fluid
- Door Open
- Boot Open
- Door and Boot Open
- CVT Error
- Low Oil Pressure
- Key Registration Complete
- Transit Mode Re-insert Fuse
- I-Key System Error
- Parking Sensor Error (if equipped)
- Malfunction (if equipped for Driving Aids)

See "Vehicle information display" (P.2-11).



Seat belt warning light

When the ignition switch is in the "ON" position, the seat belt warning light illuminates. The light will continue to illuminate until the front seat belts are fastened.

When the vehicle speed exceeds 15 km/h (10 MPH), the chime will sound unless the front seat belts are securely fastened. The chime will continue to sound for about 90 seconds until the seat belt is fastened.

See "Seat belts" (P.1-9).



Supplemental Restraint System (SRS) air bag warning light

When the ignition switch is in the "ON" position, the Supplemental Restraint System (SRS) air bag warning light illuminates for about 7 seconds and then turns off. This indicates the SRS air bag system is operational.

If any of the following conditions occur, the SRS air bag system and pre-tensioner seat belt need servicing. Have the system checked, and if necessary repaired, by a NISSAN dealer promptly.

- The SRS air bag warning light remains illuminated after about 7 seconds.
- The SRS air bag warning light flashes intermittently.
- The SRS air bag warning light does not illuminate at all.

Unless checked and repaired, the SRS air bag system and/or pre-tensioner seat belt may not function properly. (See "Supplemental Restraint System (SRS)" (P.1-20).)



Vehicle Dynamic Control (VDC) warning light

When the ignition switch is in the "ON" position, the Vehicle Dynamic Control (VDC) warning light illuminates and then turns off.

The VDC warning light blinks when the VDC system is operating.

When the VDC warning light blinks while driving, the driving condition is slippery and the vehicle's traction limit is about to be exceeded.

If the VDC warning light illuminates when the ignition switch is placed in the "ON" position, it

may indicate that the VDC system is not functioning properly and may need servicing. Have the system checked, and if necessary repaired, by a NISSAN dealer promptly.

If a malfunction occurs in the system, the VDC system function will be canceled but the vehicle is still driveable.

See "Vehicle Dynamic Control (VDC) system" (P.5-10).

INDICATOR LIGHTS



Front fog light indicator light

The front fog light indicator light illuminates when the front fog lights are on. (See "Fog light switch" (P.2-22).)



High beam indicator light

The high beam indicator light illuminates when the headlight high beam is on. The indicator turns off when the low beam is selected. (See "Headlight and turn signal switch" (P.2-20).)



Malfunction Indicator Light (MIL)



CAUTION:

- **Continuing vehicle operation without proper servicing of the engine control system and/or CVT system could lead to poor driveability, reduced fuel economy, and damage to the engine control system, which may affect the vehicle's warranty coverage.**
- **Incorrect setting of the engine control system may lead to non-compliance of local and national emission laws and**

regulations.

When the ignition switch is in the "ON" position, the Malfunction Indicator Light (MIL) illuminates. After starting the engine, the MIL turns off. This indicates that the engine control system is operational.

If the MIL illuminates while the engine is running, it may indicate that the engine control system and/or CVT system is not functioning properly and may need servicing. Have the vehicle checked, and if necessary repaired, by a NISSAN dealer promptly.

If the MIL blinks (if equipped) while the engine is running, it may indicate a potential malfunction in the emission control system. In this case, the emission control system may not function properly and may need servicing. Have the system checked, and if necessary repaired, by a NISSAN dealer promptly.

Precautions:

To reduce or avoid possible damage to the engine control system when the MIL blinks:

- Avoid driving at speeds above 70 km/h (43 MPH).
- Avoid sudden acceleration or deceleration.
- Avoid going up steep uphill grades.
- Avoid carrying or towing unnecessary loads.



Security indicator light

The security indicator light blinks when the ignition switch is in the "ACC", "OFF" or "LOCK" position. This function indicates the security system equipped on the vehicle is operational.

If the security system is malfunctioning, this light will remain on while the ignition switch is in the "ON" position. (See "Security system" (P.3-14) for additional information.)



Small light indicator light

The small light indicator light illuminates when the front clearance lights, instrument panel lights, rear combination lights and license plate lights are on. The indicator light turns off when these lights are turned off.



SPORT mode indicator light

When the ignition switch is in the "ON" position, the SPORT mode indicator light illuminates and then turns off.

The SPORT mode indicator light illuminates when the SPORT mode is turned "ON". (See "Driving with Continuously Variable Transmission (CVT)" (P.5-7) for the use of the SPORT mode switch.)



Turn signals/hazard indicator lights

The turn signals/hazard indicator lights blink when the turn signal switch or hazard indicator flasher switch is turned on. (See "Headlight and turn signal switch" (P.2-20) or "Hazard indicator flasher switch" (P.6-2).)



Vehicle Dynamic Control (VDC) off indicator light

When the ignition switch is in the "ON" position, the Vehicle Dynamic Control (VDC) off indicator light illuminates and then turns off.

The VDC off indicator light illuminates when the VDC OFF switch is pushed to the "OFF" position.

When the VDC OFF switch is pushed to the "OFF" position, the VDC system is turned off.

See "Vehicle Dynamic Control (VDC) system"

(P.5-10).

AUDIBLE REMINDERS

Brake pad wear warning

The disc brake pads have audible wear warnings. When a brake pad requires replacement, it will make a high pitched scraping sound when the vehicle is in motion. This scraping sound will first occur only when the brake pedal is depressed. After more wear of the brake pad, the sound will always be heard even if the brake pedal is not depressed.

Have the system checked, and if necessary repaired, by a NISSAN dealer promptly. (See "Brakes" (P.8-11).)

Key reminder chime

The Intelligent Key door buzzer sounds if the Intelligent Key is left inside the vehicle when locking the doors. When the buzzer sounds, be sure to check both the vehicle and the Intelligent Key. See "Intelligent Key system" (P.3-5).

Light reminder chime

The light reminder chime will sound if the driver's side door is opened while the headlight switch is in either the ⌂ or ⌂ position and the ignition switch is in the "ACC", "OFF" or "LOCK" position.

Be sure to turn the light switch to the "OFF" or "AUTO" position when you leave the vehicle.

The chime will also sound for 2 seconds when the ignition switch is placed in the "OFF" position with the fog lights on while the headlight switch is in the "AUTO" position.

Parking brake reminder chime

The parking brake reminder chime will sound if the vehicle is driven at speeds more than 7 km/h (4 MPH) with the parking brake applied. Stop the vehicle and release the parking brake.

Seat belt warning chime

When the vehicle speed exceeds 15 km/h (10 MPH), the chime will sound unless the front seat belts are securely fastened. The chime will continue to sound for about 90 seconds until the seat belt is fastened.

VEHICLE INFORMATION DISPLAY

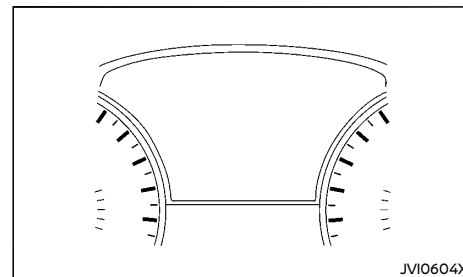



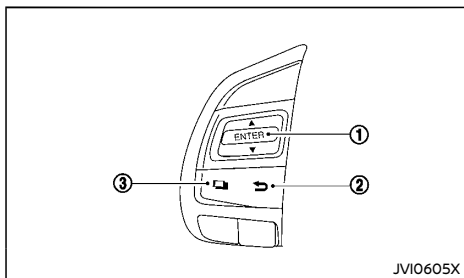

The vehicle information display is located on the left of the speedometer. It displays such items as:

- Vehicle settings
- Trip computer information
- Driver Assistance (if equipped)
- Cruise control system information
- Intelligent Key operation information
- Audio information
- Navigation - turn by turn (if equipped)
- Indicators and warnings
- Other information

HOW TO USE THE VEHICLE INFORMATION DISPLAY



The vehicle information display can be changed using the switches  ③ and ENTER ① located on the steering wheel.

- ①  - navigate through the items in vehicle information display
ENTER - change or select an item in the vehicle information display
- ②  - go back to the previous menu
- ③  - select/enter the Vehicle information menu items or to change from one display screen to the next (i.e. trip, Fuel economy)

The  switch ① also controls audio and control panel functions. For additional information, see "Steering-wheel-mounted controls for audio" (P.4-41).

STARTUP DISPLAY

When the ignition switch is placed in the "ON" or "ACC" position, the screens that display in the vehicle information include:

- Active system status (if equipped)
- Trip computer
- Fuel economy
- Warnings

Warnings will only display if there are any present, for more information on warnings and indicators, see "Vehicle information display warnings and indicators" (P.2-17).

To control what items display in the vehicle information display, see "Main Menu Selection" (P.2-14).

SETTINGS

The setting mode allows you to change the information displayed in the vehicle information display:

- Driver Assistance (if equipped)
- Vehicle Settings
- Main Menu Selection
- Body Color
- ECO Mode Settings
- Maintenance
- Alarms
- Units
- Welcome Effect
- Factory Reset

Driver Assistance (if equipped)

To change the status, warnings or turn on or off any of the systems/warnings displayed in the "Driver Assistance" menu:

Use the  switch ① to select and the ENTER ① to change a menu item:

- Driving Aids
- Parking Aids

Driving Aids:

To change the status, warnings or turn on or off any of the systems/warnings displayed in the "Driving Aids" menu.

Use the  switch ① to select and the ENTER ① to change a menu item:

- Lane
 - Lane Departure Warning (LDW) ON/OFF
- Blind Spot
 - Blind Spot Warning (BSW) ON/OFF

Parking Aids:

To change the status or turn on or off any of the systems displayed in the "Parking Aids" menu, use the  switch ① to select and the ENTER ① to change a menu item:



- Moving Object
 - Moving Object Detection (MOD) ON/OFF
- Sensor
 - Parking sensor ON/Fr only/OFF
- Display
 - Parking sensor display ON/OFF
- Volume
 - Parking sensor buzzer volume Low/Med./High
- Range

- Parking sensor detection range Far/Mid./Near

For additional information, see “Parking sensor system” (P.5-21) and “Intelligent Around View Monitor” (P.4-10).

Vehicle Settings

The vehicle settings allows the customer to change settings for interior lights, Intelligent Key settings, unlock settings and other vehicle settings.

The vehicle settings can be changed using the  ③,  ①, and the ENTER ① switches.

Auto Room Lamp:

The interior lights can be set to be ON or OFF if any door is unlocked. From the Vehicle Settings menu, select “Auto Room Lamp”. Use the ENTER ① to turn this feature ON or OFF.

Light Sensitivity:

The sensitivity of the Intelligent Auto Headlight can be adjusted. From the Vehicle Settings menu, select “Light Sensitivity”. Use the  switch ① and the ENTER ① to select the desired sensitivity. The following options are available:

- Turn on earliest.
- Turn on earlier.
- Turn on standard.
- Turn on later.

Light Off Delay:

The duration of the automatic headlights can be changed from 0 to 180 seconds. From the Vehicle Settings menu, select “Light Off Delay”. Use the ENTER ① to change the duration.

Wiper with Speed (if equipped):

The wiper with speed can be set to be ON or OFF. From the Vehicle Settings menu, select “Wiper with Speed”. Use the ENTER ① to turn this feature ON or OFF.

Rain Sensor (if equipped):

The rain sensor can be set to be ON or OFF. From the Vehicle Settings menu, select “Rain Sensor”. Use the ENTER ① to turn this feature ON or OFF.

I-Key Door Lock:

When this item is turned on, the request switch on the door is activated. From the Vehicle Settings menu, select “I-Key Door Lock”. Use the ENTER ① to turn this feature ON or OFF.

Auto Door Lock:

There are 3 submenus under the Auto Door Lock menu.

- Off:
The auto door lock function is deactivated.
- Vehicle Speed:
The auto door lock function automatically locks all the doors depending on the vehicle speed.
- Shift out of P:
The auto door lock function automatically locks all the doors when the shift lever is out from the “P” (Park) position.

Auto Door Unlock:

There are 3 submenus under the Auto Door Unlock menu.

- Off:
The auto door unlock function is deactivated.

- IGN Off:
The auto door unlock function automatically unlocks all the doors when the ignition switch is in the “OFF” position.
- Shift into P:
The auto door unlock function automatically unlocks all the doors when the shift lever is placed in “P” (Park) position.

Answer back horn:

When the answer back horn is on the horn will chirp and the hazard indicators will flash once when locking the vehicle with the Intelligent Key or remote keyless entry function.

Remote Start (if equipped):

When the remote engine start is turned on, the engine can be started remotely. See “Remote engine start” (P.3-16) for more information.

Battery Saver:

Activating the battery saver will automatically turn off the battery switch after a period of time when the ignition switch is placed in the “ACC” or “ON” position and the engine is not running. From the Vehicle Settings menu, select “Battery Saver”. Use the ENTER ① to enable/disable this function.

Exit Seat Slide (if equipped):

The exit seat slide function can be set to be ON or OFF. From the Vehicle Settings menu, select “Exit Seat Slide”. Use the ENTER ① to turn this feature ON or OFF.

Main Menu Selection

The items that display can be enabled/disabled when the ignition switch is placed in the "ON" position. To change the items that display.

Use the  switch ① to select and the ENTER ① to change a menu item:

- Driver assistance (if equipped)
- Trip Computer
- Audio
- Navigation (if equipped)
- Fuel Economy

Driver Assistance (if equipped):

The driver assistance can be enabled/disabled to display in the vehicle information display when the ignition switch is placed in the "ON" position.

From the "Main Menu Selection", select "Driver Assistance" to display in the vehicle information display when the ignition switch is placed in the "ON" position.

Trip Computer:

The trip computer can be enabled/disabled to display in the vehicle information display when the ignition switch is placed in the "ON" position.

From the "Main Menu Selection" select "Trip Computer" to display in the vehicle information display when the ignition switch is placed in the "ON" position.

Audio:

The audio information display can be enabled/disabled in the vehicle information display when the ignition switch is in the "ON" position.

From the "Main Menu Selection" select "Audio" to display in the vehicle information display when the ignition switch is placed in the "ON"

position.

Navigation (if equipped):

The navigation can be enabled/disabled to display in the vehicle information display when the ignition switch is placed in the "ON" position.

From the "Main Menu Selection" select "Navigation" to display in the vehicle information display when turn-by-turn is used and the ignition switch is placed in the "ON" position.



Fuel Economy:

The fuel economy can be enabled/disabled to display in the vehicle information display when the ignition switch is placed in the "ON" position.

From the "Main Menu Selection" select "Fuel Economy" to display in the vehicle information display when the ignition switch is placed in the "ON" position.



Body Color

The color of the vehicle that displays in the vehicle information display when the ignition switch is placed in the "ON" position can be changed.

1. Press the  switch ③ until the settings menu appears.
2. Use the  switch ① until "Body Color" is selected, and press ENTER ①.
3. Select the body color using the  switch ① and press ENTER ①.

ECO Mode Settings

This setting allows the customer to change the ECO mode system settings.

1. Press the  switch ③ until the settings menu appears.
2. Use the  switch ① until "ECO Mode Settings" is selected, and press ENTER ①.

ECO Indicator:

This setting allows the customer to enable/disable the ambient ECO indicator in the vehicle information display.

1. Use the  switch ① to select "ECO Indicator".
2. Press the ENTER ① to turn ON/OFF the ambient ECO in the vehicle information display.

Display:

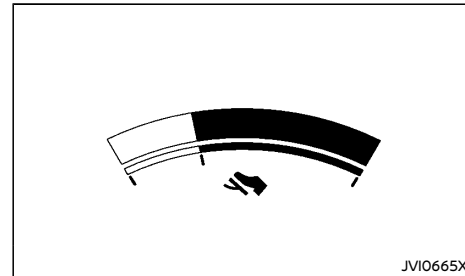

This setting allows the customer to enable/disable the ECO pedal guide function.

1. Use the  switch ① to select "Display".
2. Press the ENTER ① to select "Pedal" or "Fuel econ."

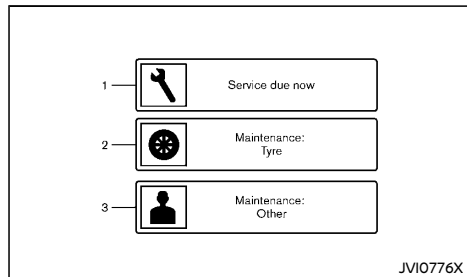

For detailed information, see "ECO mode system" (P.5-19).

Maintenance



1. Service
2. Tyre
3. Other

The maintenance mode allows you to set alerts for the reminding of maintenance intervals. To change an item:

1. Press the  switch ③ until the settings menu appears.
2. Select "Maintenance" using the  switch ① and press ENTER ①.

Service:

This indicator appears when the customer set distance comes for changing the engine oil and filter. You can set or reset the distance for checking or replacing these items. For scheduled maintenance items and intervals, see a separate maintenance booklet.

Tyre:

This indicator appears when the customer set distance comes for replacing tires. You can set or reset the distance for replacing tires.



WARNING:



The tire replacement indicator is not a substitute for regular tire checks, including tire pressure checks. See "Changing tires and wheels" (P.8-25). Many factors including tire inflation, alignment, driving habits and road conditions affect tire wear and when tires should be replaced. Setting the tire replacement indicator for a certain driving distance does not mean your tires will last that long. Use the tire replacement indicator as a guide only and always perform regular tire checks. Failure to perform regular tire checks, including tire pressure checks could result in tire failure. Serious vehicle damage could occur and may lead to a collision, which could result in serious personal injury or death.

Other:

This indicator appears when the customer set distance comes for checking or replacing maintenance items other than the engine oil, oil filter and tires. Other maintenance items can include such things as air filter or tire rotation. You can set or reset the distance for checking or replacing the items.

Alarms

This setting allows the customer to set alarms.

1. Press the  switch ③ until the settings menu appears.
2. Select "Alarms" using the  switch ① and press ENTER ①.



Outside Temp.:

This setting allows the customer to enable/disable the alert for low outside temperature in the vehicle information display.

1. Use the  switch ① to select "Outside Temp.".
2. Press the ENTER ① to turn ON/OFF the outside temperature in the vehicle information display.

Timer Alert:

This setting allows the customer to set an alert to notify the driver that the set time has been reached.

1. Use the  switch ① to select "Timer Alert".
2. Press the ENTER ①.
3. To change the timer amount, use the  switch ① and the ENTER ① to save the selected time amount.

Navigation (if equipped):



This setting allows the customer to enable/disable the alert for navigation in the vehicle information display.

1. Use the  switch ① to select "Navigation".
2. Press the ENTER ① to turn ON/OFF the alert.

Units

The units that are shown in the vehicle information display can be changed:

- Mileage
- Temperature

Use the  ③,  ①, and the ENTER ① switches to select and change the units of the vehicle information display. The units of the navigation screen can be changed independently of the vehicle information display. See "Vehicle information and settings (models with navigation system)" (P.4-5).

Mileage:

The unit for the mileage that displays in the vehicle information display can be changed.

Use the  ① and the ENTER ① switches to select and change the unit.

Temperature:



The temperature that displays in the vehicle information display can be changed from:

- °F (Fahrenheit)
- °C (Celsius)

Use the ENTER ① to toggle choices.



Welcome Effect

The welcome screen display can be turned ON/OFF to display when the ignition switch is placed in the "ACC" or "ON" position. To enable/disable the welcome screen:













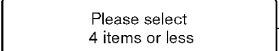





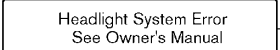





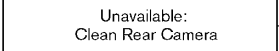

1. Press the  switch ③ until the settings menu appears.
2. Select "Welcome Effect" using the  switch ① and press ENTER ① to turn this function ON or OFF.

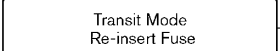
Factory Reset

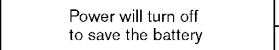
The settings in the vehicle information display can be reset back to the factory default. To reset the vehicle information display:

1. Press the  switch ③ until the settings menu appears.
2. Select "Factory Reset" using the  switch ① and press the ENTER ①.
3. Select "YES" to return all settings back to default by pressing the ENTER ①.

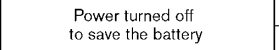
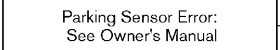
VEHICLE INFORMATION DISPLAY WARNINGS AND INDICATORS

 No Key Detected — 1	 Low Washer Fluid — 9	 CVT Error: See Owner's Manual — 17	 Please select 4 items or less — 25
 Key ID Incorrect — 2	 Door Open — 10	 Turn OFF the lights — 18	 BRAKE — 26
 Shift to Park — 3	 Boot Open — 11	 Headlight System Error See Owner's Manual — 19	 Unavailable: Select Driving Aids in Settings — 27
 Push ignition to OFF — 4	 Door and Boot Open — 12	 Low Oil Pressure: See Owner's Manual — 20	 Malfunction See Owner's Manual — 28
 Key low battery — 5	 Have a break ? — 13	 Key Registration Complete — 21	 Unavailable: Clean Rear Camera — 29
 Parking Sensor Error: See Owner's Manual — 24	 Low Outside Temperature — 14	 Transit Mode Re-insert Fuse — 22	 Unavailable: Clean Rear Camera — 29
 Release parking brake — 7	 Power will turn off to save the battery — 15	 I-Key System Error: See Owner's Manual — 23	 Unavailable: Clean Rear Camera — 29
 Low Fuel — 8	 Power turned off to save the battery — 16	 Parking Sensor Error: See Owner's Manual — 24	 Unavailable: Clean Rear Camera — 29

JV11906X

1. No Key Detected
2. Key ID Incorrect
3. Shift to Park
4. Push ignition to OFF
5. Key low battery
6. Engine start operation for Intelligent Key system
7. Release parking brake
8. Low Fuel
9. Low Washer Fluid
10. Door Open
11. Boot Open
12. Door and Boot Open
13. Have a break?
14. Low Outside Temperature
15. Power will turn off to save the battery
16. Power turned off to save the battery
17. CVT Error
18. Turn OFF the lights
19. Headlight System Error
20. Low Oil Pressure
21. Key Registration Complete
22. Transit Mode Re-insert Fuse
23. I-Key System Error
24. Parking Sensor Error (if equipped)
25. Please select 4 items or less
26. Engine start operation indicator
27. Unavailable: Select Driving Aids in Settings (if equipped)
28. Malfunction: See Owner's Manual (if equipped)

29. Unavailable: Clean Rear Camera (if equipped)
30. Steering lock release malfunction indicator

1. No Key Detected

This warning appears when the Intelligent Key is left outside the vehicle with the ignition switch is the "ON" or "ACC" position. Make sure the Intelligent Key is inside the vehicle.

2. Key ID Incorrect

This warning appears when the ignition switch is pushed from the "OFF" position and the Intelligent Key is not recognized by the system. You cannot start the engine with an unregistered key.

See "Intelligent Key system" (P.3-5) for more information.

3. Shift to Park

This warning appears when the ignition switch is in the "ACC" or "OFF" position and the shift lever is in any position other than "P" (Park) position. Also, a chime sounds when the ignition switch is in the "OFF" position.

If this warning appears, move the shift lever to the "P" (Park) position or start the engine.

For additional information about Intelligent Key, see "Intelligent Key system" (P.3-5).

4. Push ignition to OFF

This warning appears if the ignition switch is placed in the "ACC" position when the shift lever is moved to the "P" (Park) position.

To turn off this warning, place the ignition switch in the "ON" position and then in the "OFF" position.

5. Key low battery

This indicator appears when the Intelligent Key battery is running out of power.

If this indicator appears, replace the battery with a new one. See "Intelligent Key battery" (P.8-17).

6. Engine start operation for Intelligent Key system

This indicator appears when the battery of the Intelligent Key is low and when the Intelligent Key system and the vehicle are not communicating normally.

If this indicator appears, touch the ignition switch with the Intelligent Key while depressing the brake pedal. For more information, see "Intelligent Key system" (P.5-4).

7. Release parking brake

This warning appears when the vehicle is driven at speeds more than 7 km/h (4 MPH) with the parking brake applied.

8. Low Fuel

This warning appears when the fuel level in the fuel tank is getting low. Refuel as soon as it is convenient, preferably before the fuel gauge reaches 0 (Empty). There will be a small reserve of fuel in the tank when the fuel gauge needle reaches 0 (Empty).

9. Low Washer Fluid

This warning appears when the window washer fluid is at a low level. Add window washer fluid as necessary. See "Window washer fluid" (P.8-15).

10. Door Open

This warning appears when a door has been opened.

11. Boot Open

This warning appears when the trunk has been opened.

12. Door and Boot Open

This warning appears when a door and the trunk have been opened.

13. Have a break?

This indicator appears when the set time is reached. The time can be set up to 6 hours. For setting the timer, see "Alarms" (P.2-15).

14. Low Outside Temperature

This warning appears if the outside temperature is below 3°C (37°F). The temperature can be changed to display in Celsius or Fahrenheit. See "Units" (P.2-16).

15. Power will turn off to save the battery

This warning appears after a period of time if the shift lever has not been moved from the "P" (Park) position.

16. Power turned off to save the battery

This warning appears after the ignition switch is automatically turned OFF to save the battery.

17. CVT Error

This warning appears when there is a malfunction with the CVT system. If this warning appears, have the system checked by a NISSAN dealer.

18. Turn OFF the lights

This warning appears when the headlights are left in the "ON" position when exiting the vehicle. Place the headlight switch in the "OFF" or "AUTO" position. For additional information, see "Headlight and turn signal switch" (P.2-20).

19. Headlight System Error

This warning appears if the LED headlights are malfunctioning. Have the system checked by a NISSAN dealer.

20. Low Oil Pressure

This warning appears if low oil pressure is detected. This gauge is not designed to indicate low oil level. The low oil pressure warning is not designed to indicate a low oil level. Use the dipstick to check the oil level. See "Engine oil" (P.8-7).

21. Key Registration Complete

This appears when a new Intelligent Key is registered to the vehicle.

22. Transit Mode Re-insert Fuse (if equipped)

This warning may appear if the extended storage fuse switch is not pushed in (switched on). When this warning appears, push in (switch on) the extended storage fuse switch to turn off the warning. For more information, see "Extended storage fuse switch" (P.8-20).

23. I-Key System Error

This warning appears when there is a malfunction with the Intelligent Key system. If this warning appears, have the system checked by a NISSAN dealer.

24. Parking Sensor Error (if equipped)

This warning appears when there is a malfunction with the parking sensor system. If this warning appears, have the system checked by a NISSAN dealer.

25. Please select 4 items or less

This warning appears when the driver tries to select 5 or more items in the Main Menu Selection. Note that the driver can only choose 4 or less items for the main menu.

26. Engine start operation indicator

This indicator appears when the shift lever is in the "P" (Park) position.

This indicator also appears when the vehicle has been started using the remote engine start function (if equipped).

This indicator means that the engine will start by pushing the ignition switch with the foot brake pedal depressed. You can start the engine directly in any position of the ignition switch.

27. Unavailable: Select Driving Aids in Settings (if equipped)

This warning appears when the driver pushes the warning systems switch when the Driving Aids (Blind Spot Warning (BSW) system and/or Lane Departure Warning (LDW) system) have been turned off in the Driver Assistance menu. See "Driver Assistance" (P.2-12).

HEADLIGHT AND TURN SIGNAL SWITCH

28. Malfunction: See Owner's Manual (if equipped)

This warning appears when there is a malfunction with the Blind Spot Warning (BSW) system and/or the Lane Departure Warning (LDW) system. If this warning appears, stop the vehicle in a safe location, turn off and restart the engine. If the warning continues to appear, have the BSW and/or LDW system checked by a NISSAN dealer.

29. Unavailable: Clean Rear Camera (if equipped)

This warning appears if dirt, rain or snow accumulates on the rear camera and cannot be removed by the automatic washer and blower. See "Blind Spot Warning (BSW)/Lane Departure Warning (LDW) systems" (P.5-12).

30. Steering lock release malfunction indicator

This indicator appears when the steering wheel cannot be released from the "LOCK" position.

If this indicator appears, push the ignition switch while lightly turning the steering wheel right and left.

HEADLIGHT SWITCH

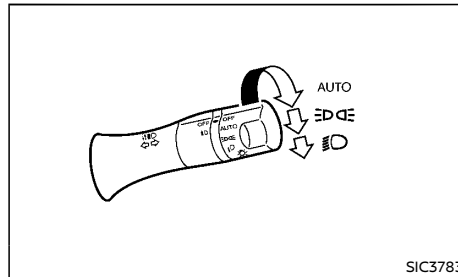

NISSAN recommends that you consult the local regulations concerning the use of lights.

AUTO position

When the ignition switch is in the "ON" position and the headlight switch is in the "AUTO" position, the headlights, front clearance lights, instrument panel lights, rear combination lights and other lights turn on automatically depending on the brightness of the surroundings.

The headlights will turn on automatically at twilight or in rainy weather (when the windshield wiper is operated continuously).

When the ignition switch is placed in the "OFF" position, the lights will turn off automatically.

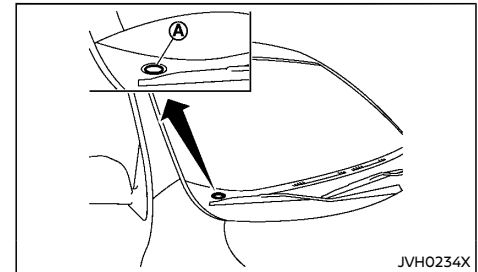

CAUTION:

Do not place any objects on top of the sensor (A). The sensor senses the brightness level and controls the Intelligent Auto Headlight function. If the sensor is covered, it reacts as if it is dark, and the headlights will illuminate.

Automatic headlights off delay:

You can keep the headlights on for 45 seconds after you place the ignition switch in the "OFF" position and open any door then close all the doors.

You can adjust the period of the automatic headlights off delay from 0 seconds (OFF) to 180 seconds. The factory default setting is 45 seconds. For automatic headlights off delay setting, see "Vehicle information display" (P.2-11).

☰ position

The ☰ position ② turns on the front clearance, tail, license plate and instrument panel lights.

☷ position

The ☷ ③ position turns on the headlights in addition to the other lights.

Headlight beam

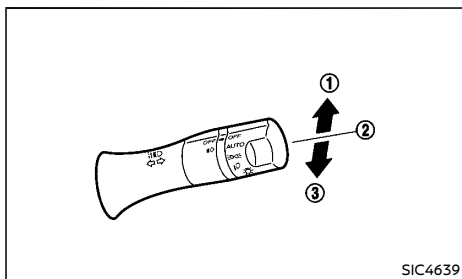

To turn on the high beam, push the lever towards the front position ①.

To turn off the high beam, return the lever to the neutral position ②.

To flash the headlights, pull the lever towards the rearmost position ③. The headlights can be flashed even when the headlights are not on.

Daytime running light system

Even if the headlights are off, the daytime running lights will turn on after starting the engine.

When the light switch is turned to the ☰ position, the daytime running light will turn off.

AUTOMATIC AIMING CONTROL

The headlights are equipped with the automatic leveling system. Headlight axis is controlled automatically.

BATTERY SAVER SYSTEM

The light reminder chime will sound if the headlight switch is in either the ☰ or ☷ position and when the driver's door is opened with the ignition switch in the "ACC", "OFF" or "LOCK" position.

If the ignition switch is placed in the "OFF" or "LOCK" position while the headlight switch is in the ☰ or ☷ position, the battery saver function will turn off the lights after a period of time to prevent the battery from being discharged.

⚠ CAUTION:

Do not leave the lights on when the engine is not running for extended periods of time to prevent the battery from being discharged.

TURN SIGNAL SWITCH

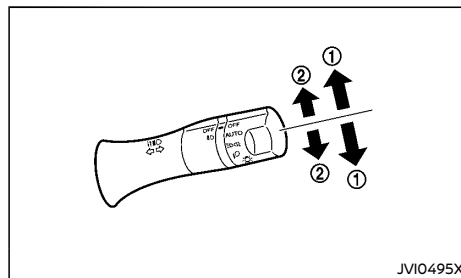

⚠ CAUTION:

The turn signal switch will not be cancelled automatically if the steering wheel turning angle does not exceed the preset amount. After the turn or lane change, make sure that the turn signal switch is returned to its original position.

Turn signal

To turn on the turn signals, move the lever up or down ① to the point where the lever latches. When the turn is completed, the turn signal cancels automatically.

Lane change signal

To turn on the lane change signals, move the lever up or down ② to the point where the light begins to flash.



If the lever is moved back to its original position right after moving up or down, the light will flash 3 times.

To cancel the flashing, move the lever to the opposite direction.

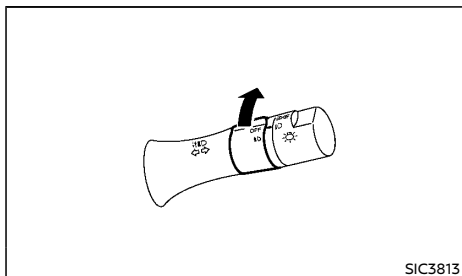
FOG LIGHT SWITCH



FRONT FOG LIGHTS

To turn on the front fog lights, turn the fog light switch to the  position with the headlight switch in the  or  position.

To turn off the fog lights, turn the fog light switch to the "OFF" position.

When the headlight switch is in the "AUTO" position, turning the fog light switch to the  position will turn on the headlights, fog lights and the other lights.

WIPER AND WASHER SWITCH



WARNING:

In freezing temperatures, the washer fluid may freeze on the windshield and obscure your vision. Warm the windshield with the defogger before you wash the windshield.



CAUTION:

- Do not operate the washer continuously for longer than 30 seconds.
- Do not operate the washer if the window washer reservoir is empty.
- If the wiper operation is interrupted by snow or ice, the wiper may stop moving to protect its motor. If this occurs, turn the wiper switch to the "OFF" position and remove the snow or ice on and around the wiper arms. In approximately 1 minute, turn the switch on again to operate the wiper.

WINDSHIELD WIPER AND WASHER SWITCH

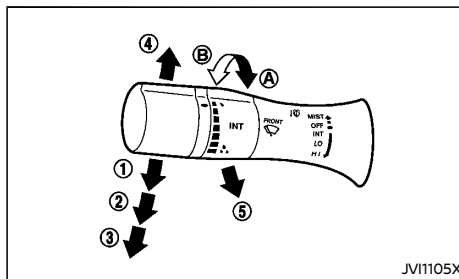

Type A

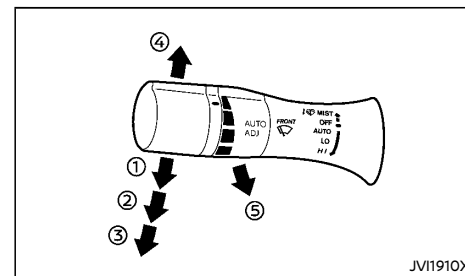

Type B

The windshield wiper and washer operate when the ignition switch is in the "ON" position.

Wiper operation

The lever position "INT" ① (Type A) operates the wiper intermittently.

- The intermittent operation can be adjusted by turning the adjustment control knob, (longer) ④ or (shorter) ③.
- The intermittent operation speed varies in accordance with the vehicle speed. (For example, when the vehicle speed is high, the intermittent operation speed will be faster.) This function can be turned off. See "Vehicle information display" (P.2-11).

The lever position "AUTO" ① (Type B) operates the rain-sensing auto wiper system. See "Rain-sensing auto wiper system" (P.2-23).

The lever position "LO" ② operates the wiper at low speed.

The lever position "HI" ③ operates the wiper at high speed.

To stop the wiper operation, move the lever up to the "OFF" position.

The lever position "MIST" ④ operates the wiper one sweep. The lever automatically returns to

its original position.

Washer operation

To operate the washer, pull the lever toward the rear of the vehicle ⑤ until the desired amount of washer fluid is spread on the windshield.

RAIN-SENSING AUTO WIPER SYSTEM (if equipped)

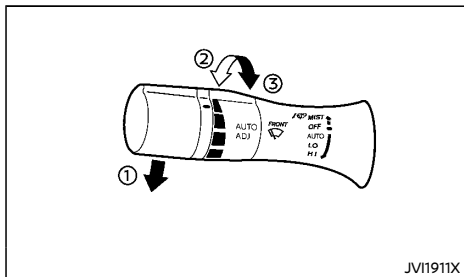

The rain-sensing auto wiper system can automatically turn on the wipers and adjust the wiper speed depending on the rainfall and the vehicle speed by using the rain sensor located on the upper part of the windshield.

To set the rain-sensing auto wiper system, push the lever down to the "AUTO" position ①. The wiper will sweep once while the ignition switch is in the "ON" position.

The rain sensor sensitivity level can be adjusted by turning the knob toward the front ② (High) or toward the rear ③ (Low).

- High — High sensitive operation
- Low — Low sensitive operation

To turn the rain-sensing auto wiper system off, push up the lever to the "OFF" position, or pull

down the lever to the "LO" (low speed) or "HI" (high speed) position.

CAUTION:

Do not touch the rain sensor and around it when the wiper switch is in the "AUTO" position and the ignition switch is in the "ON" position. The wipers may operate unexpectedly and cause an injury or a wiper damage.

- **The rain-sensing auto wipers are intended for use during rain. If the switch is left in the "AUTO" position, the wipers may operate unexpectedly when dirt, fingerprints, oil film or insects are stuck on or around the sensor. The wipers may also operate when exhaust gas or moisture affect the rain sensor.**
- **When the windshield glass is coated with water repellent, the speed of the rain-sensing auto wipers may be higher even though the amount of the rainfall is small.**
- **Be sure to turn off the rain-sensing auto wiper system when you use a car wash.**
- **The rain-sensing auto wipers may not operate if rain does not hit the rain sensor even if it is raining.**

DEFOGGER SWITCH

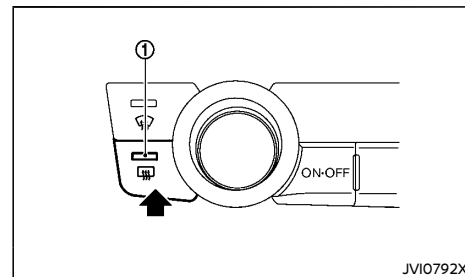

The defogger switch operates when the ignition switch is in the "ON" position.

The defogger is used to reduce the moisture, fog or frost on the rear window and outside door mirror surface (if equipped) to improve the rear view.

When the defogger switch is pushed, the indicator light ① illuminates and the defogger operates for approximately 15 minutes. After the preset time has passed, the defogger will turn off automatically.

To turn off manually, push the defogger switch again.

If the engine is started using the remote start function (if equipped) when the outside air temperature, the interior temperature and the engine coolant temperature are low, the rear window glass and outside mirror defogger may turn on automatically. For additional information about the remote engine start function, see "Remote engine start" (P.3-16).

CAUTION:

- **When operating the defogger continuously, be sure to start the engine. Otherwise, it may cause the battery to**

HORN

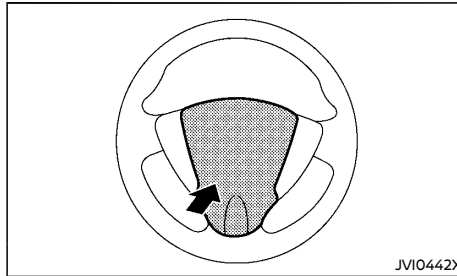

The horn switch  operates regardless of the ignition switch position except when the battery is discharged.

When the horn switch (pad area) is pushed and held, the horn will sound. Releasing the horn switch will cease the horn sound.

WINDOWS

POWER WINDOWS



WARNING:

- Make sure that all passengers have their hands, etc. inside the vehicle before operating the power windows.
- To help avoid risk of injury or death through unintended operation of the vehicle and or its systems, including entrapment in windows or inadvertent door lock activation, do not leave children, people who require the assistance of others or pets unattended in your vehicle. Additionally, the temperature inside a closed vehicle on a warm day can quickly become high enough to cause a significant risk of injury or death to people and pets.

The power windows operate when the ignition switch is in the "ON" position.

To open a window, push down the power window switch.

To close a window, pull up the power window switch.

Driver's window switch

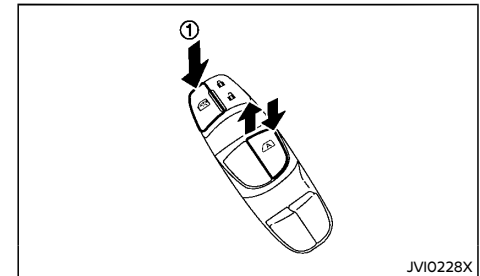

The driver's switch, the main switch, can control all windows.

Locking passengers' windows:

When the lock button ① is pushed in, the passengers' windows cannot be operated.

To cancel the passengers' windows lock, push the lock button ① again.

Passenger's window switch

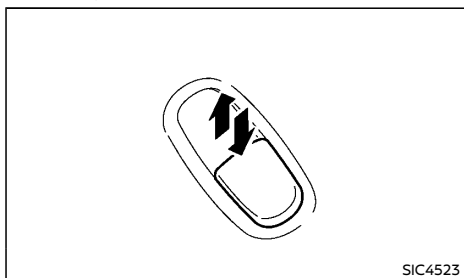

The passenger's switch can control its corresponding window.

When the passengers' windows lock button on the driver's switch is pushed in, the passenger's switch cannot be operated.

Automatic function

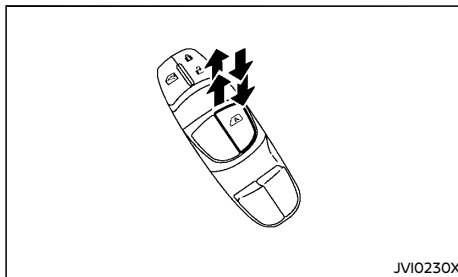

The automatic function is available for the switch that has an **A** mark on its surface.

The automatic function enables a window to fully open or close without holding the switch down or up.

To fully open the window, push the power window switch down to the second detent and release the switch. To fully close the window, pull the power window switch up to the second detent and release the switch. The switch does not have to be held during window operation.

To stop the window open/close operation during the automatic function, push down or pull up the switch in opposite directions.

Auto-reverse function:



WARNING:

There is a small distance just before the closed position which cannot be detected. Make sure that all passengers have their hands, etc. inside the vehicle before closing the windows.

The auto-reverse function enables a window to automatically reverse when something is

caught in the window as it is closing by the automatic function. When the control unit detects an obstacle, the window will be lowered immediately.

Depending on the environment or driving conditions, the auto-reverse function may activate if an impact or load similar to something being caught in the window occurs.

When power window switch does not operate

If the power window automatic function does not operate properly, perform the following procedure to initialize the power window functions.

1. Push the ignition switch to start the engine.
2. Close the door.
3. After starting the engine, open the window completely by operating the power window switch.
4. Pull the power window switch and hold it to close the window. Hold the switch for approximately 3 seconds after the window has been fully closed.
5. Release the power window switch. Operate the window by the automatic function to confirm that the initialization is complete.

If the power window functions do not operate properly after performing the procedure above, have your vehicle checked by a NISSAN dealer.

SUNROOF (if equipped)

WARNING:

- In an accident you could be thrown from the vehicle through an open sunroof. Adults should always use seat belts and children should always use seat belts or child restraint systems.
- Never allow anyone to stand up or extend any portion of their body out of the opening while the vehicle is in motion or while the sunroof is closing.

CAUTION:

- Remove water drops, snow, ice or sand from the sunroof before opening.
- Do not place any heavy objects on the sunroof or surrounding area.
- Do not push or pull on the sunshade. Doing so can damage the sunshade.

AUTOMATIC SUNROOF

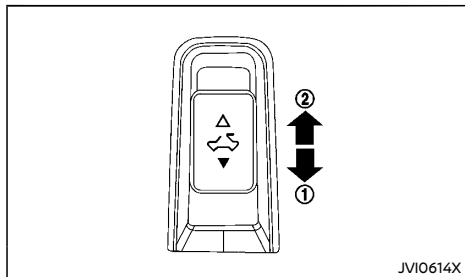

The sunroof will operate when the ignition switch is placed in the "ON" position.

Sunshade

Open and close the sunshade by sliding it forward or backward.

Sunroof

Tilting:

To tilt up, first close the sunroof, then push the switch to the TILT UP position ① and release it; it need not be held. To tilt down the sunroof, push the switch to the TILT DOWN position ②.

Sliding:

To fully open or close the sunroof, push the switch to the OPEN ② or CLOSE ① position and release it; it need not be held. The roof will automatically open or close all the way. To stop the roof, push the switch once more while it is opening or closing.

Sunroof timer:

The automatic sunroof is operational for a period of time, even if the ignition switch is placed in the "ACC" or "OFF" position. If the driver's door or the front passenger's door is opened during this period of time, the power to the sunroof is canceled.

Auto-reverse function

WARNING:

There are some small distances just before the closed position which cannot be detected. Make sure that all passengers have their hands, etc. inside the vehicle before closing the sunroof and sunshade.

The auto-reverse function can be activated when the sunroof is closed or tilted down by automatic operation when the ignition switch is placed in the "ON" position.

Depending on the environment or driving conditions, the auto-reverse function may activate if an impact or load similar to something being caught in the sunroof occurs.

When closing:

If the control unit detects something caught in the sunroof as it moves to the front, the sunroof will immediately open backward.

When tilting down:

If the control unit detects something caught in the sunroof as it tilts down, the sunroof will immediately tilt up.

If the auto-reverse function malfunctions and repeats opening or tilting up the sunroof, keep pushing the tilt down switch within 10 seconds after it happens; the sunroof will fully close gradually. Make sure nothing is caught in the sunroof.

If sunroof does not operate

If the sunroof and sunshades do not operate properly, perform the following procedure to initialize the operation system.

1. If the sunroof is open, close it fully by pushing the sunroof switch to the CLOSE ① position.
2. Push and hold the sunroof switch to the CLOSE ① position for 10 seconds.
3. Release the sunroof switch after the sunroof moves slightly to the closed position.
4. Within 4 seconds, push and hold the sunroof switch to the CLOSE ① position.
5. The sunroof will fully open and then fully close.
6. Check if the sunroof switch operates normally.

If the sunroof does not operate properly after

REAR SUNSHADE (if equipped)

performing the procedure above, have your vehicle checked by a NISSAN dealer.



WARNING:

- Never allow hands, fingers, or any part of your body within operating range of the rear sunshade. You could be injured.
- Never allow children near the rear sunshade system. They could be injured.
- Never place any objects on or near the rear sunshade system. Never manually pull or push the rear sunshade. These may cause an improper operation of or possible damages to the rear sunshade system.

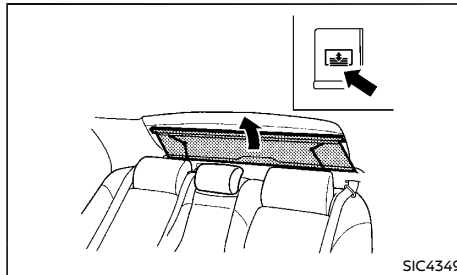

The rear sunshade operates when the ignition switch is in the "ON" position.

The rear sunshade switch is located on the lower side of the instrument panel.

To raise and lower the rear sunshade, push the switch on the instrument panel.

When the shift lever is moved to the "R" (Reverse) position, the rear sunshade automatically lowers.

POWER OUTLET

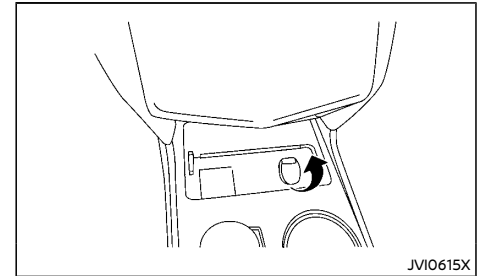

Instrument panel

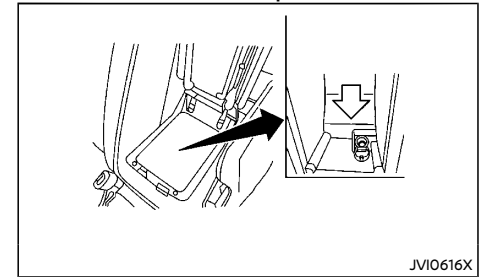

Console box

The power outlets are for powering electrical accessories such as cellular telephones. They are rated at 12 volt, 120W (10A) maximum.



CAUTION:

- The outlet and plug may be hot during or immediately after use.
- This power outlet is not designed for use with a cigarette lighter unit.
- Do not use with accessories that exceed a 12 volt, 120W (10A) power draw. Do not use double adapters or more than one electrical accessory.

STORAGE

- Use power outlet with the engine running to avoid discharging the vehicle battery.
- Avoid using power outlet when the air conditioner, headlights or rear window defogger is on.
- Before inserting or disconnecting a plug, be sure to turn off the power switch of the electrical accessory being used and the ignition switch.
- Push the plug in as far as it will go. If good contact is not made, the plug may overheat or the internal temperature fuse may blow.
- Do not allow water or any liquid to contact the outlet.
- When not in use, be sure to close the cap.



WARNING:

- The storages should not be used while driving so that the full attention may be given to vehicle operation.
- Keep the storage lids closed while driving to help prevent injury in an accident or sudden stop.

GLOVE BOX

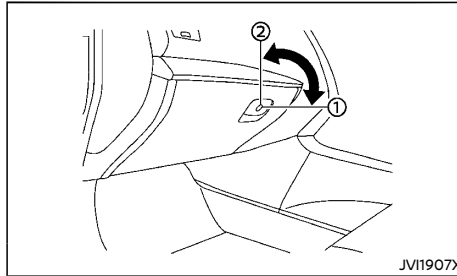

Open the glove box by pulling the handle. Use the mechanical key when locking ① or unlocking ② the glove box.

CONSOLE BOX

Upper half

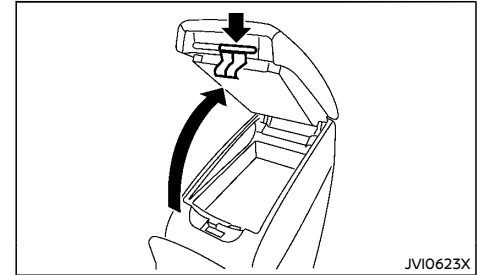

Pull up on the driver's side latch to open the upper half of the console box.

Lower half

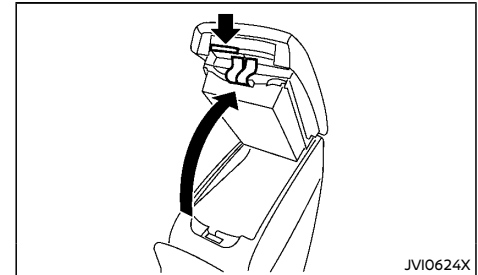

Pull up on the passenger's side latch to open the lower half of the console box. A power outlet is located inside the console box.

CUP HOLDERS

WARNING:

The driver must not remove or insert cups into the cup holder while driving so that full attention may be given to vehicle operation.

CAUTION:

- Avoid abrupt starting and braking especially when the cup holder is being used to prevent spilling the contents. If the contents are hot, they could scald you or your passengers.
- Use only soft cups in the cup holder. Hard objects can injure you in an accident.

Front

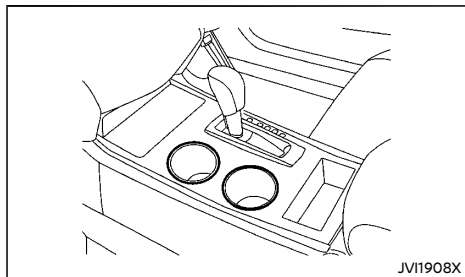

Rear

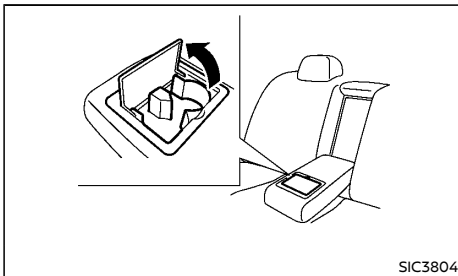

The rear cup holders are located in the rear fold-down armrest.

Soft bottle holder

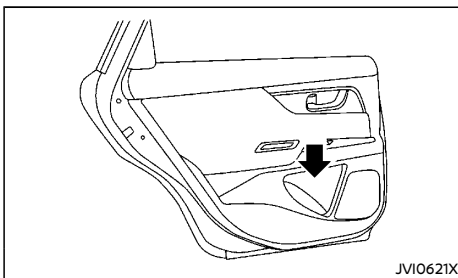

CAUTION:

- Do not use bottle holder for any other objects that could be thrown about in the vehicle and possibly injure people during sudden braking or an accident.
- Do not use bottle holder for open liquid containers.

SUNGLASSES HOLDER

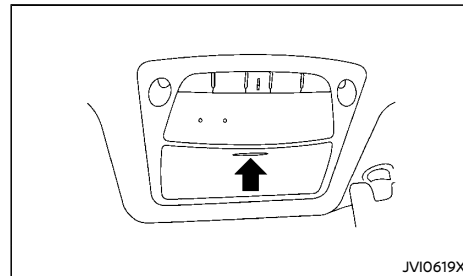

WARNING:

Keep the sunglasses holder closed while driving to avoid obstructing the driver's view and to help prevent an accident.

CAUTION:

- Do not use for anything other than sunglasses.
- Do not leave sunglasses in the sunglasses holder while parking in direct sunlight. The heat may damage the sunglasses.

To open the sunglasses holder, push and release. Only store one pair of sunglasses in the holder.

COAT HOOK

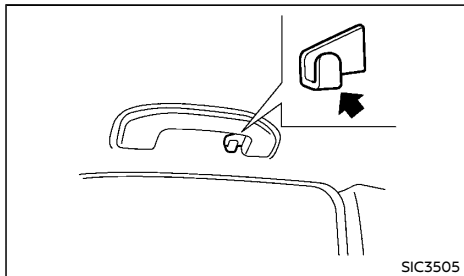

The coat hook is located above the rear side window (on the driver's side).

CAUTION:

Do not apply a total load of more than 1 kg (2 lb) to the hook.

TRUNK HOOKS

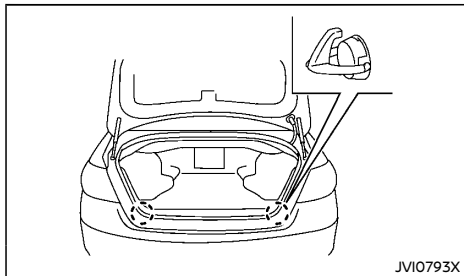

WARNING:

- Always make sure that the cargo is properly secured. Use the suitable ropes and hooks.
- Unsecured cargo can become dangerous in an accident or sudden stop.

CAUTION:

Do not apply a total load of more than 9 kg (20 lbs) to a single hook.

MAP POCKETS

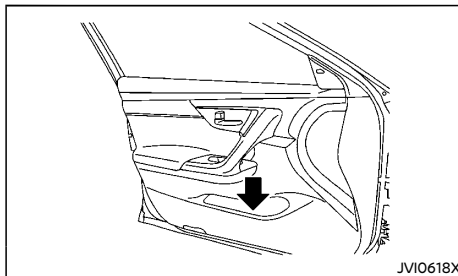

SUN VISORS

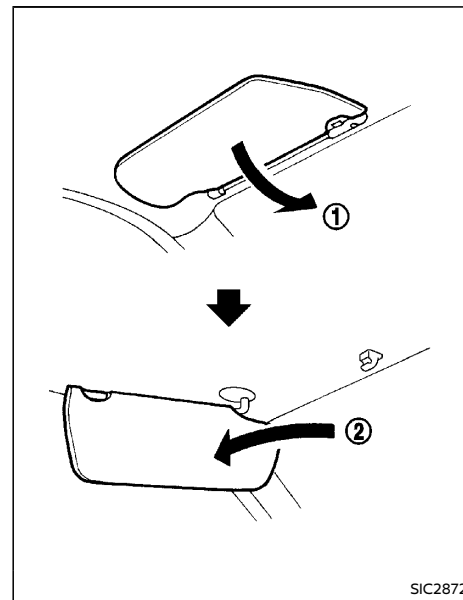

1. To block out glare from the front, swing down the sun visor ①.
2. To block glare from the side, remove the sun visor from the center mount and swing it to the side ②.

INTERIOR LIGHTS



CAUTION:

- Do not leave the light switch on when the engine is not running for extended periods of time to prevent the battery from being discharged.
- Turn off the lights when you leave the vehicle.

INTERIOR LIGHT SWITCH

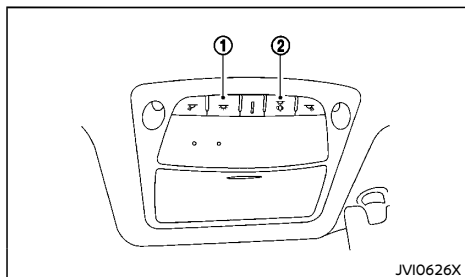

- ① The interior light can be turned ON regardless of door position. The light will go off after a period of time unless the ignition switch is placed in the "ON" position when any door is opened.
- ② The interior lights can be set to operate when the doors are opened. To turn off the interior lights when a door open, push the switch, the interior lights will not illuminate, regardless of door position. The lights will go off when the ignition switch is placed in the "ON" position, or the driver's door is closed and locked. The lights will also go off after a period of time when the doors are open.

CONSOLE LIGHT (if equipped)

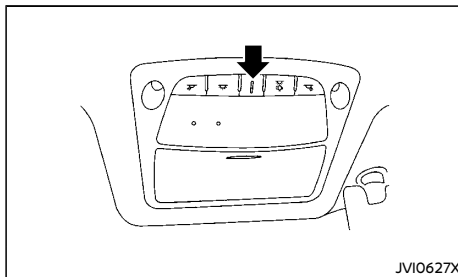

The console light will turn on whenever the clearance lights or headlights are illuminated.

MAP LIGHTS

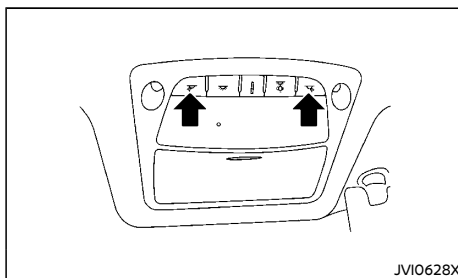

Push the button to turn the map lights on. To turn them off, push the button again.

REAR PERSONAL LIGHTS

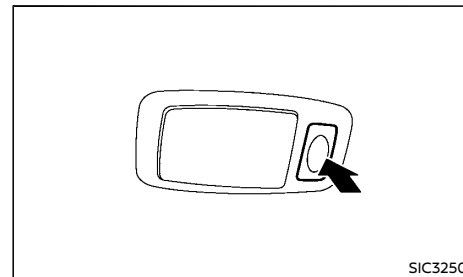

To turn the rear personal lights on, push the switch. To turn them off, push the switch again.

TRUNK LIGHT

The light illuminates when the trunk lid is opened. When the trunk lid is closed, the light goes off.

The light will go off after a period of time if the trunk lid is left open.

VANITY MIRROR LIGHT

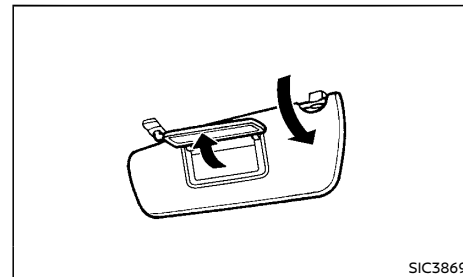

To access the vanity mirror, pull the sun visor down and flip open the mirror cover. Some

vanity mirrors are illuminated and turn on when the mirror cover is open.

BATTERY SAVER SYSTEM

When the interior lights stay on, they will automatically turn off after a period of time when the ignition switch has been placed in the "OFF" position (except for the vanity mirror lights). To turn on the lights again, place the ignition switch in the "ON" position.

3 Pre-driving checks and adjustments

Keys	3-2	Extending engine run time	3-16
Intelligent Key	3-2	Canceling a remote engine start	3-17
Doors	3-3	Conditions the remote engine start will not work	3-17
Locking with key	3-3	Hood	3-17
Locking with inside lock knob	3-3	Opening hood	3-18
Locking with power door lock switch	3-4	Closing hood	3-18
Vehicle speed sensing door lock mechanism	3-4	Trunk lid	3-18
Auto door lock releasing mechanism	3-4	Opening trunk lid	3-18
Impact sensing door lock releasing mechanism	3-5	Closing trunk lid	3-19
Child safety rear door lock	3-5	Fuel-filler lid	3-19
Intelligent Key system	3-5	Opening fuel-filler lid	3-19
Operating range	3-7	Fuel-filler cap	3-19
Using Intelligent Key system	3-7	Steering wheel	3-20
Battery saver system	3-9	Mirrors	3-20
Warning signals	3-9	Inside rearview mirror	3-20
Troubleshooting guide	3-10	Outside rearview mirrors	3-21
Using remote keyless entry system	3-11	Vanity mirror	3-22
Hazard indicator and horn operation	3-12	Parking brake	3-22
Security system	3-14	Automatic drive positioner (if equipped)	3-23
Theft warning system	3-14	Entry/exit function	3-23
NISSAN Anti-Theft System (NATS)	3-15	Memory storage	3-23
Remote engine start (if equipped)	3-16	System operation	3-24
Remote engine start operating range	3-16		
Remote starting the engine	3-16		

KEYS

Your vehicle can only be driven with the keys specific to your vehicle. A key number plate is supplied with your key. Record the key number and keep the key number plate in a safe place, except in the vehicle, in case of the need to duplicate the keys.

The key can only be duplicated using an original key or the original key number. The key number is required when you have lost all of the keys and do not have the original key to duplicate from. If the key is lost, or you need extra keys, provide an original key or the key number to a NISSAN dealer.



CAUTION:

Do not leave the keys inside the vehicle when leaving the vehicle.

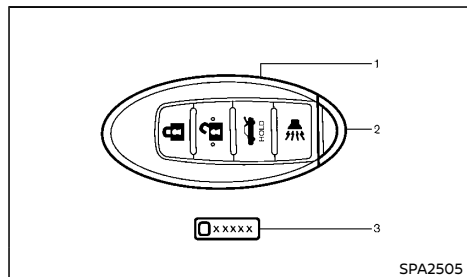

Type A

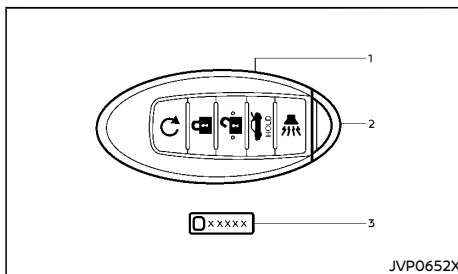

Type B

1. Master key (2)
2. Mechanical key (inside the key) (2)
3. Key number plate (1)

INTELLIGENT KEY

Your vehicle can only be driven with the Intelligent Keys, which are registered to your vehicle's Intelligent Key system components and NISSAN Anti-Theft System (NATS*) components. As many as 4 Intelligent Keys can be registered and used with one vehicle. The new keys must be registered by a NISSAN dealer prior to use with the Intelligent Key system and NATS of your vehicle. Since the registration process requires erasing all memory in the Intelligent Key components when registering new keys, be sure to take all Intelligent Keys that you have to the NISSAN dealer.



CAUTION:

- **Do not allow the Intelligent Key, which contains electrical components, to come into contact with water or salt water. This could affect the system function.**
- **Do not drop the Intelligent Key.**

- **Do not strike the Intelligent Key sharply against another object.**
- **If the outside temperature is below -10°C (14°F), the battery of the Intelligent Key may not function properly.**
- **Do not place the Intelligent Key for an extended period in an area where temperatures exceed 60°C (140°F).**
- **Do not attach the Intelligent Key with a key holder that contains a magnet.**
- **Do not place the Intelligent Key near equipment that produces a magnetic field, such as a TV, audio equipment and personal computers.**

*: Immobilizer

Mechanical key

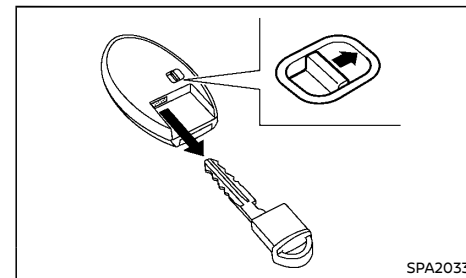

To remove the mechanical key, release the lock knob at the back of the Intelligent Key.

To install the mechanical key, firmly insert it into the Intelligent Key until the lock knob returns to the lock position.

Use the mechanical key to lock or unlock the doors and glove box. (See "Doors" (P.3-3) and "Storage" (P.2-28).)

DOORS

Valet parking:

When you have to leave a key with a valet, give them the Intelligent Key itself and keep the mechanical key with you to protect your belongings.

To prevent the glove box from being opened during valet parking, follow the procedures below.

1. Remove the mechanical key from the Intelligent Key.
2. Lock the glove box with the mechanical key.
3. Hand the Intelligent Key to the valet, keeping the mechanical key in your pocket or bag for insertion into the Intelligent Key when you retrieve your vehicle.



WARNING:

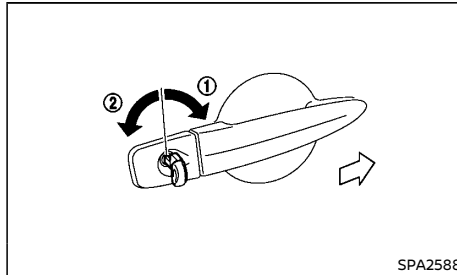

- Always look before opening any doors, to avoid an accident with oncoming traffic.
- To help avoid risk of injury or death through unintended operation of the vehicle and or its systems, including entrapment in windows or inadvertent door lock activation, do not leave children, people who require the assistance of others or pets unattended in your vehicle. Additionally, the temperature inside a closed vehicle on a warm day can quickly become high enough to cause a significant risk of injury or death to people and pets.

LOCKING WITH KEY



To lock the door, insert the mechanical key to the door key cylinder and turn the key to the front side of the vehicle ①. The driver's side door will lock.

To unlock the door, turn the key to the rear of the vehicle ②. The driver's side door will unlock.

To lock or unlock the other doors, use the power door lock switch or the "UNLOCK" button  or "LOCK" button  on the Intelligent

Key.

LOCKING WITH INSIDE LOCK KNOB

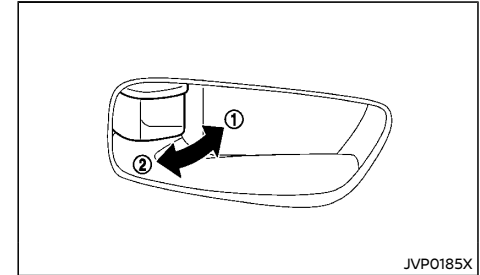

CAUTION:

- When locking the doors using the inside lock knob, be sure not to leave the key in the vehicle.
- When the Intelligent Key is left in the vehicle, and you try to lock the door using the driver's inside lock knob after getting out of the vehicle, the door will unlock automatically and a chime will sound after the door is closed.

To lock the front doors, push the inside lock knob to the lock position ①, and then close the door while pulling the door handle.

To lock the rear doors, push the inside lock knob to the lock position ① and then close the door.

To unlock, pull the inside lock knob to the unlock position ②.

When the driver's door is locked, you do not need to operate the inside lock knob. Just pull the inside door handle to open the driver's door.

LOCKING WITH POWER DOOR LOCK SWITCH

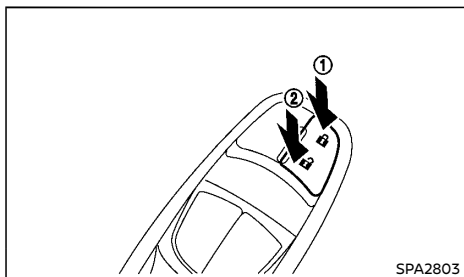

Operating the power door lock switch, located on the driver's door armrest, will lock or unlock all the doors.

To lock the doors, push the power door lock switch to the lock position ① with the driver's door open, then close the door while pulling the door handle. All doors will lock.



CAUTION:

- When locking the doors using the power door lock switch, be sure not to leave the key in the vehicle.
- When the Intelligent Key is left in the vehicle, and you try to lock the door using the power door lock switch after getting out of the vehicle, all the doors will unlock automatically after the door is closed.

To unlock, push the power door lock switch to the unlock position ②.

VEHICLE SPEED SENSING DOOR LOCK MECHANISM

All doors will be locked automatically when the vehicle speed reaches 10 km/h (6 MPH). Once the lock has been unlocked, while driving, the vehicle speed sensing door lock mechanism will not lock the door again unless one of the following is performed.

- Opening any doors.
- Placing the ignition switch in the "LOCK" position.

To activate or deactivate vehicle speed sensing door lock mechanism

To activate or deactivate the door lock mechanism, perform the following procedures.

1. Place the ignition switch in the "ON" position.
2. Within 20 seconds, push and hold the power door lock switch to the "LOCK" position for 5 seconds.
3. The hazard indicator light will flash as follows if the switching operation is successful:

- Twice - activated
- Once - deactivated

NOTE:

The automatic door lock function can be changed using the Vehicle Settings in the vehicle information display. The "Auto Door Lock" choices are:

- Off
- Vehicle Speed
- Shift out of P

AUTO DOOR LOCK RELEASING MECHANISM

All doors will be unlocked automatically when the ignition switch is moved from "ON" to "OFF" position.

To activate or deactivate auto door lock releasing mechanism

To activate or deactivate the auto door lock releasing mechanism, perform the following procedures.

1. Place the ignition switch in the "ON" position.
2. Within 20 seconds, push and hold the power door lock switch to the "UNLOCK" position for 5 seconds.
3. The hazard indicator light will flash as follows if the switching operation is successful:

- Twice - activated
- Once - deactivated

NOTE:

The automatic door unlock function can be changed using the Vehicle Settings in the vehicle information display. The "Auto Door Unlock" choices are:

- Off
- IGN OFF
- Shift into P

INTELLIGENT KEY SYSTEM

IMPACT SENSING DOOR LOCK RELEASING MECHANISM

All doors will be unlocked automatically when the impact sensors sense an impact while the ignition switch is in the "ON" position.

CHILD SAFETY REAR DOOR LOCK

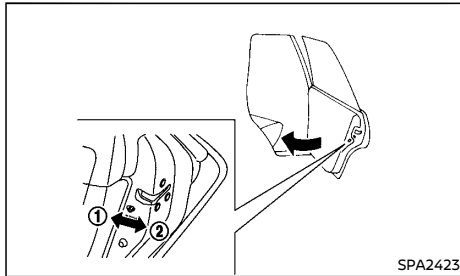

The child safety rear door locks help prevent rear doors from being opened accidentally, especially when small children are in the vehicle.

When the levers are in the lock position ①, the child safety rear door locks engage and the rear doors can only be opened by the outside door handles.

To disengage, move the levers to the unlock position ②.

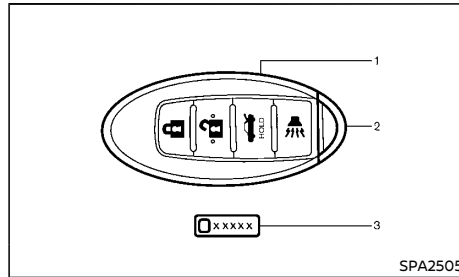

Type A

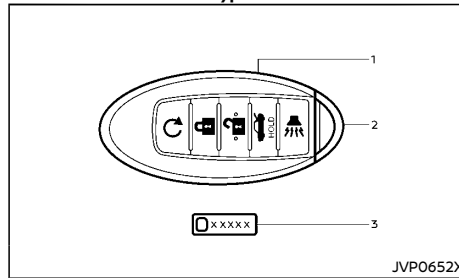

Type B

1. Intelligent Key
2. Mechanical key (inside the key)
3. Key number plate



WARNING:

- **Radio waves could adversely affect electric medical equipment. Those who use a pacemaker should contact the electric medical equipment manufacturer for the possible influences before use.**
- **The Intelligent Key transmits radio waves when the buttons are pushed. The radio waves may affect navigation and com-**

munication systems. Do not operate the Intelligent Key while on an airplane. Make sure the buttons are not operated unintentionally when the unit stored for a flight.

The Intelligent Key system can operate all the door locks and the trunk lid using the remote controller function or pushing the request switch on the vehicle without taking the key out from a pocket or purse. The operating environment and/or conditions may affect the Intelligent Key system operation.

Be sure to read the following before using the Intelligent Key system.



CAUTION:

- **Be sure to carry the Intelligent Key with you when operating the vehicle.**
- **Never leave the Intelligent Key in the vehicle when you leave the vehicle.**

The Intelligent Key is always communicating with the vehicle as it receives radio waves. The Intelligent Key system transmits weak radio waves. Environmental conditions may interfere with the operation of the Intelligent Key system under the following operating conditions.

- When operating near a location where strong radio waves are transmitted, such as a TV tower, power station and broadcasting station.
- When in possession of wireless equipment, such as a cellular telephone, transceiver, and CB radio.
- When the Intelligent Key is in contact with or covered by metallic materials.
- When any type of radio wave remote control is used nearby.

- When the Intelligent Key is placed near an electric appliance such as a personal computer.

In such cases, correct the operating conditions before using the Intelligent Key function or use the mechanical key.

Although the life of the battery varies depending on the operating conditions, the battery's life is approximately 2 years. If the battery is discharged, replace it with a new one.

When the Intelligent Key battery is almost discharged, see "Intelligent Key battery discharge" (P.5-6) to start the engine.

Since the Intelligent Key is continuously receiving radio waves, if the Intelligent Key is left near equipment which transmits strong radio waves, such as signals from a TV and personal computer, the battery life may become shorter.

For information regarding replacement of a battery, see "Battery" (P.8-16).

Because the steering wheel is locked electrically, unlocking the steering wheel with the ignition switch in the "LOCK" position is impossible when the vehicle battery is completely discharged. In this case, unlocking the steering wheel would be also impossible. Pay special attention that the vehicle battery is not completely discharged.

As many as 4 Intelligent Keys can be used with one vehicle. For information about the purchase and use of additional Intelligent Keys, contact a NISSAN dealer.



CAUTION:

- **Do not allow the Intelligent Key, which contains electrical components, to come into contact with water or salt water. This could affect the system function.**

- **Do not drop the Intelligent Key.**
- **Do not strike the Intelligent Key sharply against another object.**
- **Do not change or modify the Intelligent Key.**
- **Wetting may damage the Intelligent Key. If the Intelligent Key gets wet, immediately wipe until it is completely dry.**
- **If the outside temperature is below -10°C (14°F), the battery of the Intelligent Key may not function properly.**
- **Do not place the Intelligent Key for an extended period in an area where temperatures exceed 60°C (140°F).**
- **Do not attach the Intelligent Key with a key holder that contains a magnet.**
- **Do not place the Intelligent Key near equipment that produces a magnetic field, such as a TV, audio equipment and personal computers.**

If an Intelligent Key is lost or stolen, NISSAN recommends erasing the ID code of that Intelligent Key from the vehicle. This may prevent the unauthorized use of the Intelligent Key to operate the vehicle. For information regarding the erasing procedure, contact a NISSAN dealer.

The Intelligent Key function can be disabled. For information about disabling the Intelligent Key function, contact a NISSAN dealer.

OPERATING RANGE

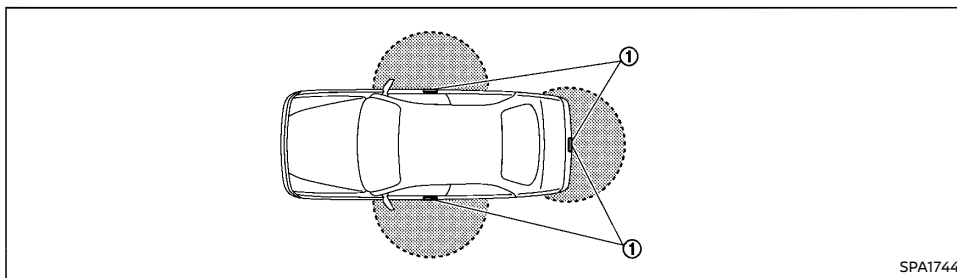

The Intelligent Key functions can only be used when the Intelligent Key is within the specified operating range from the request switch ①.

When the Intelligent Key battery is discharged or strong radio waves are present near the operating location, the Intelligent Key system's operating range becomes narrower, and the Intelligent Key may not function properly.

The operating range is within 80 cm (31.50 in) from each request switch ①.

If the Intelligent Key is too close to the door glass, handle or rear bumper, the request switches may not function.

When the Intelligent Key is within the operating range, it is possible for anyone, even someone who does not carry the Intelligent Key, to push the request switch to lock/unlock the doors and open the trunk lid.

USING INTELLIGENT KEY SYSTEM

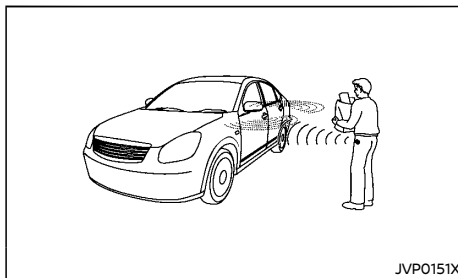

The request switch will not function under the following conditions:

- When the Intelligent Key is left inside the vehicle (only the unlock function operates).
- When the Intelligent Key is not within the operational range.
- When the doors are open or not closed securely (only the unlock function operates).

- When the Intelligent Key battery is discharged.
- When the engine is running.

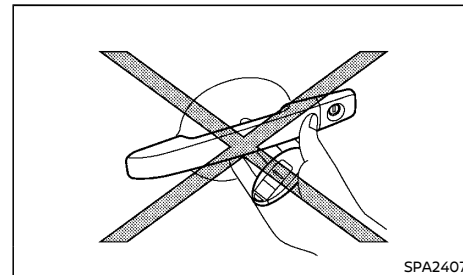

- Do not push the door handle request switch with the Intelligent Key held in your hand as illustrated. The close distance to the door handle will cause the Intelligent Key system to have difficulty recognizing that the Intelligent Key is outside the vehicle.
- After locking the doors using the door handle request switch, make sure that the doors have been securely locked by operating the door handles.
- The door handle request switch is operational only when the Intelligent Key has been detected by the Intelligent Key system.
- When locking the doors using the door handle request switch, make sure to have the Intelligent Key in your possession before operating the door handle request switch to prevent the Intelligent Key from being left in the vehicle.
- To prevent the Intelligent Key from being left inside the vehicle or the trunk, make sure you carry the key with you and then

- lock the doors.
- Do not pull the door handle before pushing the door handle request switch. The door will be unlocked but will not open. Release the door handle once and pull it again to open the door.

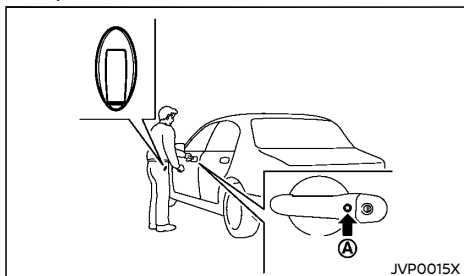

When you carry the Intelligent Key with you, you can lock or unlock all doors by pushing the door handle request switch (A) within the range of operation.

When you lock or unlock the doors or open the trunk lid, the hazard indicator will flash and the outside chime will sound as a confirmation. For details, see "Hazard indicator and horn operation" (P.3-12).

Request switches for all doors and trunk can be deactivated when the I-Key Door Lock is switched to OFF in the Vehicle Settings of the vehicle information display. See "Vehicle information display" (P.2-11).

Locking doors

1. Push the ignition switch to the "OFF" position and carry the Intelligent Key.
2. Close all doors.
3. Push the door handle request switch (A).
4. All doors will be locked.
5. Operate door handles to confirm that the doors have been securely locked.

Lockout protection:

To prevent the Intelligent Key from being accidentally locked in the vehicle, lockout protection is equipped with the Intelligent Key system.

When the driver's side door is open, the doors are locked, and then the Intelligent Key is put inside the vehicle and all the doors are closed; the lock will automatically unlock and the door buzzer sounds.

Doors do not lock with the door handle request switch with the Intelligent Key inside the vehicle and a beep sounds to warn you. However, when an Intelligent Key is inside the vehicle, doors can be locked with another Intelligent Key.



CAUTION:

The lockout protection may not function under the following conditions:

- When the Intelligent Key is placed on top of the instrument panel.
- When the Intelligent Key is placed on the top of the rear parcel shelf.
- When the Intelligent Key is placed inside of the glove box.

- When the Intelligent Key is placed inside of the door pockets.
- When the Intelligent Key is placed on or under the spare tire area.
- When the Intelligent Key is placed on the outer side of the trunk area.
- When the Intelligent Key is placed inside or near metallic materials.

The lockout protection may function when the Intelligent Key is outside the vehicle but is too close to the vehicle.

Unlocking doors

1. Carry the Intelligent Key with you.
2. Push the door handle request switch (driver's or front passenger's) (A).
3. All doors will be unlocked.
4. Operate the door handles to open the doors.

If a door handle is pulled while unlocking the doors, that door may not be unlocked. Returning the door handle to its original position will unlock the door. If the door does not unlock, after returning the door handle, push the door handle request switch to unlock the door.

Automatic relock:

All doors will be locked automatically unless one of the following operations is performed within 1 minute after pushing the request switch while the doors are locked.

- Opening any doors.
- Pushing the ignition switch.

If during the preset time period, the "UNLOCK" button on the Intelligent Key is pushed, all doors will be locked automatically after another 1 minute.

Opening trunk lid

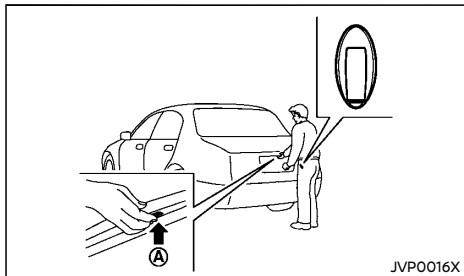

1. Carry the Intelligent Key.
2. Push the trunk open request switch (A) for more than 1 second.
3. The trunk will be unlatched and the outside chime sounds 4 times.
4. Raise the trunk lid to open the trunk.



CAUTION:

When closing the trunk, make sure to have the Intelligent Key in your possession before closing the trunk to prevent the Intelligent Key from being left in the trunk.

Lockout protection:

To prevent the Intelligent Key from being accidentally locked in the trunk, lockout protection is equipped with the Intelligent Key system.

When the trunk lid is closed with the Intelligent Key inside the trunk, a chime will sound and the trunk lid will open.



CAUTION:

The lockout protection may not function under the following conditions:

- **When the Intelligent Key is placed on or under the spare tire area.**
- **When the Intelligent Key is placed at the outer side of the trunk area.**
- **When the Intelligent Key is placed inside the metal box.**

BATTERY SAVER SYSTEM

When all the following conditions are met for a period of time, the battery saver system will cut off the power supply to prevent battery discharge.

- The ignition switch is in the "ACC" position, and
- All doors are closed, and
- The shift lever is in the "P" (Park) position.

WARNING SIGNALS

The Intelligent Key system is equipped with a function that is designed to minimize improper operations of the Intelligent Key and to help prevent the vehicle from being stolen. The warning buzzer sounds and the warning display appears on the vehicle information display when improper operations are detected.

See the troubleshooting guide on the next page. For warning and indicators on the vehicle information display, see "Vehicle information display" (P.2-11).



CAUTION:

When the buzzer sounds and the warning display appears, be sure to check both the vehicle and the Intelligent Key.

TROUBLESHOOTING GUIDE

Symptom		Possible cause	Action to take
When pushing the ignition switch to start the engine	The Key Battery Low indicator appears in the vehicle information display.	The battery charge is low.	Replace the battery with a new one. See "Battery" (P.8-16).
	The Key ID Incorrect warning appears in the vehicle information display.	The Intelligent Key is not in the vehicle.	Carry the Intelligent Key with you.
When pushing the ignition switch to stop the engine	The Shift to Park warning appears on the vehicle information display and the inside warning chime sounds continuously.	The shift lever is not in the "P" (Park) position.	Shift the shift lever to the "P" (Park) position.
When opening the driver's door to get out of the vehicle	The inside warning chime sounds continuously.	The ignition switch is in the "ACC" position.	Place the ignition switch in the "OFF" position.
When closing the door after getting out of the vehicle	The No Key Detected warning appears on the vehicle information display, the outside chime sounds 3 times and the inside warning chime sounds for approximately 3 seconds.	The ignition switch is in the "ACC" or "ON" position.	Place the ignition switch in the "OFF" position.
	The Shift to Park warning appears on the vehicle information display and the outside chime sounds continuously.	The ignition switch is in the "ACC" position and the shift lever is not in the "P" (Park) position.	Move the shift lever to the "P" (Park) position and place the ignition switch in the "OFF" position.
When closing the door with the inside lock knob turned to the lock position	The outside chime sounds for approximately 3 seconds and all the doors unlock.	The Intelligent Key is inside the vehicle or trunk.	Carry the Intelligent Key with you.
When pushing the door handle request switch to lock the door	The outside chime sounds for approximately 2 seconds.	The Intelligent Key is inside the vehicle or trunk.	Carry the Intelligent Key with you.
When closing the trunk lid	The outside chime sounds for approximately 10 seconds and the trunk lid opens.	The Intelligent Key is inside the trunk.	Carry the Intelligent Key with you.

USING REMOTE KEYLESS ENTRY SYSTEM

Operating range

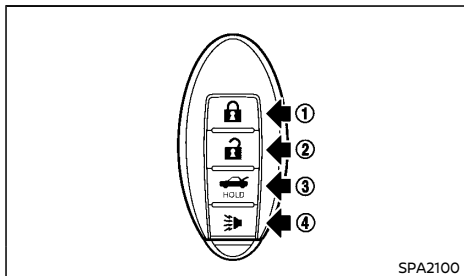

Type A

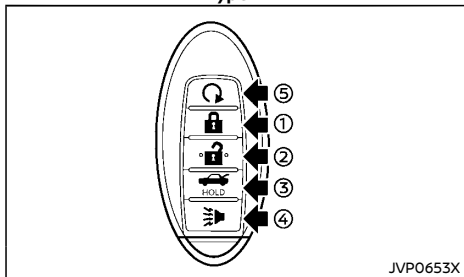

Type B

The remote keyless entry system can operate all door locks and the trunk lid. The remote keyless entry system can operate at a distance of approximately 1 m (3.3 ft) away from the vehicle. The operating distance depends upon the conditions around the vehicle.

The remote keyless entry system will not function under the following conditions:

- When the Intelligent Key is not within the operational range.
- When the doors are open. (The unlock function will operate.)
- When the Intelligent Key battery is discharged.
- When the ignition switch is in the "ACC" or "ON" position.

Locking doors

When you lock or unlock the doors or the trunk lid, the hazard indicator will flash and the horn (or the outside chime) will sound as a confirmation. For details, see "Hazard indicator and horn operation" (P.3-12).

1. Place the ignition switch in the "OFF" position and carry the Intelligent Key with you.
2. Close all doors.
3. Push the "LOCK"  button ① on the Intelligent Key.
4. All doors will be locked.
5. Operate the door handles to confirm that the doors have been securely locked.



CAUTION:

- **After locking the doors using the LOCK button on the Intelligent Key, be sure that the doors have been securely locked by operating the door handles.**
- **When locking the doors using the Intelligent Key, be sure not to leave the key in the vehicle.**

Unlocking doors

To change the door unlock mode from one to another, see "Vehicle information display" (P.2-11).

1. Push the "UNLOCK"  button ② on the Intelligent Key.
2. All doors will be unlocked.
3. Operate the door handle to open the door.

Automatic relock:

All doors will be locked automatically unless one of the following operations is performed within 1 minute after pushing the "UNLOCK"  button ② while the doors are locked.



- Opening any doors.
- Pushing the ignition switch.

Opening trunk lid

1. Push the "TRUNK"  button ③ on the Intelligent Key for more than 1 second.
2. The trunk will be unlatched.
3. Raise the trunk lid to open the trunk.

Using panic alarm

If you are near your vehicle and feel threatened, you may activate the alarm to call attention as follows:

1. Push the "PANIC"  button ④ on the Intelligent Key for more than 1 second.
2. The theft warning alarm will stay on for 25 seconds.
3. The panic alarm stops when:
 - It has run for 25 seconds, or
 - Any of the buttons on the Intelligent Key are pushed. (Note: "PANIC"  ④ or "TRUNK"  ③ button should be pushed for more than 1 second.)

Remote engine start (if equipped)

The remote engine start  button ⑤ is on the Intelligent Key if the vehicle has remote engine start function. This function allows the engine to start from outside the vehicle. See "Remote engine start" (P.3-16) for more details.

HAZARD INDICATOR AND HORN OPERATION

When you lock or unlock the doors or the trunk lid with the request switch or the remote keyless entry function, the hazard indicator will flash and the outside chime or the horn will sound as a confirmation.

The following descriptions show how the hazard indicator and chime/horn will activate when locking or unlocking the doors or trunk.

Hazard indicator and horn mode



Operation	DOOR LOCK	DOOR UNLOCK	TRUNK OPEN
Intelligent Key system (request switch)	HAZARD - twice OUTSIDE CHIME - twice	HAZARD - once OUTSIDE CHIME - once	HAZARD - none OUTSIDE CHIME - 4 times
Remote keyless entry system	HAZARD - twice HORN - once	HAZARD - once HORN - none	HAZARD - none HORN - none

SECURITY SYSTEM

Hazard indicator mode

Operation	DOOR LOCK	DOOR UNLOCK	TRUNK OPEN
Intelligent Key system (request switch)	HAZARD - twice	HAZARD - none	HAZARD - none
Remote keyless entry system	HAZARD - twice	HAZARD - none	HAZARD - none

Switching procedure

To switch the hazard indicator and horn (chime) operation, push the LOCK  ① and UNLOCK  ② buttons on the Intelligent Key simultaneously for more than 2.5 seconds.

- When the hazard indicator mode is set, the hazard indicator flashes 3 times.
- When the hazard indicator and horn mode are set, the hazard indicator flashes once and the horn chirps once.

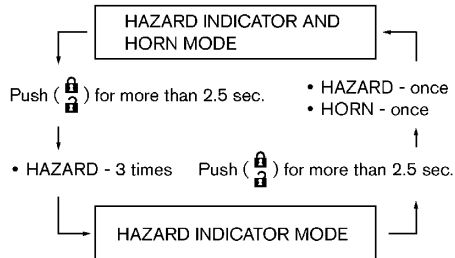

Your vehicle has the following security systems:

- Theft warning
- NISSAN Anti-theft System (NATS)*

The security condition will be shown by the security indicator light.

(* immobilizer)

THEFT WARNING SYSTEM

The theft warning system provides visual and audio alarm signals if parts of the vehicle are disturbed.

Security indicator light

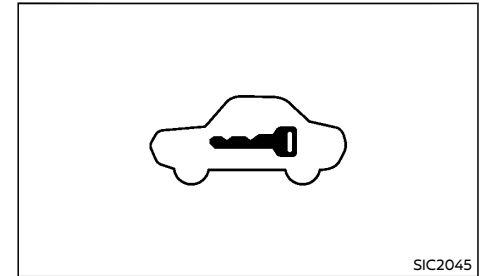

The security indicator light, located on the meter panel, operates whenever the ignition switch is in the "LOCK", "OFF" or "ACC" position. This is normal.

How to activate system

1. Close all windows.

The system can be activated even if the windows are open.

2. Push the ignition switch to the "OFF" position.
3. Close and lock all doors, the trunk and hood. The doors can be locked with the "LOCK" button  on the Intelligent Key or any request switch.
4. Confirm that the security indicator light comes on. The security indicator light glows for about 30 seconds and then blinks. The system is now activated. If, during this 30 second time period, the door is unlocked or the ignition switch is placed in the "ACC" or "ON" position, the system will not activate.

Even when the driver and/or passengers are in the vehicle, the system will activate with all doors locked and ignition switch off. Push the ignition switch to the "ACC" position to turn the system off.

Theft warning system operation

The warning system will give the following alarm:

- The hazard indicator blinks and the horn sounds intermittently.
- The alarm automatically turns off after the preset time has expired. However, the alarm reactivates if the vehicle is tampered with again.

The alarm is activated by:

- Opening the door without using the "UNLOCK" button  on the Intelligent Key or the request switch.

- Opening the trunk lid without using the  button on the Intelligent Key or the request switch.
- Opening the hood.

How to stop alarm

- The alarm will stop by unlocking a door with the "UNLOCK"  button on the Intelligent Key or the request switch.
- The alarm will stop when the ignition switch is placed in the "ACC" or "ON" position.

If the system does not operate as described above, have it checked by a NISSAN dealer.

NISSAN ANTI-THEFT SYSTEM (NATS)

The NISSAN Anti-Theft System (NATS) will not allow the engine to start without the use of the registered Intelligent Key.

Security indicator light

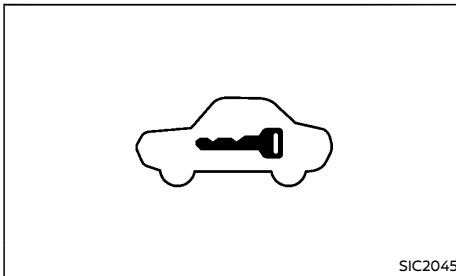

The security indicator light is located in the meter panel. It indicates the status of NATS.

The light operates whenever the ignition switch is in the "LOCK", "OFF" or "ACC" position. The security indicator light indicates that the security systems on the vehicle are operational.

If NATS is malfunctioning, this light will remain on while the ignition switch is in the "ON" position.

If the light remains on and/or the engine does not start, contact a NISSAN dealer for NATS service as soon as possible. Be sure to bring all registered Intelligent Keys that you have when visiting a NISSAN dealer for service.

REMOTE ENGINE START (if equipped)



WARNING:

To avoid risk of injury or death, do not use the remote engine start function when the vehicle is in an enclosed area such as a garage.

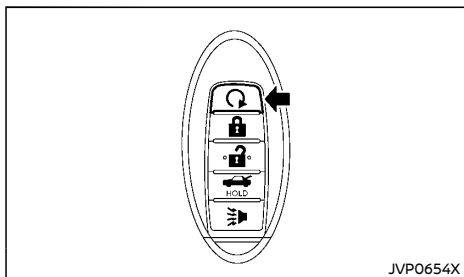

The remote engine start  button is on the Intelligent Key if the vehicle has remote engine start function. This function allows the engine to start from outside the vehicle.

Some systems, such as the air conditioner system, will turn on during a remote engine start, if the system was on the last time the ignition switch was turned off.

Laws in some local communities may restrict the use of remote engine starters. For example, some laws require a person using remote engine start to have the vehicle in view. Check local regulations for any requirements.

Other conditions may affect the remote engine start function. See "Conditions the remote engine start will not work" (P.3-17).

Other conditions can affect the performance of the Intelligent Key transmitter. See "Intelligent Key system" (P.3-5) for additional information.

REMOTE ENGINE START OPERATING RANGE



WARNING:

To help avoid risk of injury or death through unintended operation of the vehicle and/or its systems, do not leave children, people who require the assistance of others or pets unattended in your vehicle. Additionally, the temperature inside a closed vehicle on a warm day can quickly become high enough to cause a significant risk of injury or death to people and pets.



The remote engine start function can only be used when the Intelligent Key is within the specified operating range from the vehicle.

When the Intelligent Key battery is discharged or other strong radio wave sources are present near the operating location, the Intelligent Key operating range becomes narrower, and the Intelligent Key may not function properly.

The remote engine start operating range is approximately 60 m (197 ft) from the vehicle.

REMOTE STARTING THE ENGINE

To use the remote start function to start the engine, perform the following:

1. Aim the Intelligent Key at the vehicle.
2. Push the "LOCK"  button to lock all doors.
3. Within 5 seconds push and hold the remote engine start  button until the turn signal lights flash and the tail lights illuminate. If the vehicle is not within view, push and hold the remote engine start  button for at least 2 seconds.

The following events will occur when the

engine starts:

- The front clearance lights will turn on and remain on as long as the engine is running.
- The doors will be locked and the air conditioner system may turn on.
- The engine will continue to run for about 10 minutes. Repeat the steps to extend the time for an additional 10 minutes. See "Extending engine run time" (P.3-16).

Depress and hold the brake pedal, then place the ignition switch in the "ON" position before driving. For further instructions, see "Driving vehicle" (P.5-7).

EXTENDING ENGINE RUN TIME

The remote engine start function can be extended one time by performing the steps listed in "Remote starting the engine" (P.3-16). Run time will be calculated as follows:

- The first 10 minute run time will start when the remote engine start function is performed.
- The second 10 minutes will start immediately when the remote engine start function is performed. For example, if the engine has been running for 5 minutes, and 10 minutes are added, the engine will run for a total of 15 minutes.
- Extending engine run time will count towards the two remote engine start limit.

A maximum of two remote engine starts, or a single start with an extension, are allowed between ignition cycles.

The ignition switch must be cycled to the "ON" position and then back to the "OFF" position before the remote engine start procedure can be used again.

CANCELING A REMOTE ENGINE START

To cancel a remote engine start, perform one of the following:

- Aim the Intelligent Key at the vehicle and push and hold the remote engine start  button until the front clearance lights turn off.
- Turn on the hazard indicator flashers.
- Cycle the ignition switch "ON" and then "OFF".
- The extended engine run time has expired.
- The first 10 minute timer has expired.
- The engine hood has been opened.
- The shift lever is moved out of "P" (Park).
- The theft alarm sounds due to illegal entry into the vehicle.
- The ignition switch is pushed without an Intelligent Key in the vehicle.
- The ignition switch is pushed with an Intelligent Key in the vehicle but the brake pedal is not depressed.

CONDITIONS THE REMOTE ENGINE START WILL NOT WORK

The remote engine start will not operate if any of the following conditions are present:

- The ignition switch is placed in the "ON" position.
- The hood is not securely closed.
- The hazard indicator flashers are on.
- The engine is still running. The engine must be completely stopped. Wait at least 6 seconds if the engine goes from running to off. This is not applicable when extending engine run time.
- The remote engine start  button is not pushed and held for at least 2 seconds.

- The remote engine start  button is not pushed and held within 5 seconds of pushing the "LOCK" button.
- The brake pedal is depressed.
- The doors are not closed and locked.
- The trunk is open.
- The Intelligent Key warning message is displayed in the vehicle information display.
- An Intelligent Key is left inside the vehicle.
- The theft alarm sounds due to illegal entry into the vehicle.
- Two remote engine starts, or a single remote engine start with an extension, have already been used.
- The shift lever is not in the "P" (Park) position.
- The remote engine start function has been switched to the "OFF" position in vehicle settings of the vehicle information display. See "Remote Start" (P.2-13) for more information.

The remote engine start may display a warning or indicator in the vehicle information display. For an explanation of the warning or indicator, see "Vehicle information display warnings and indicators" (P.2-17).

HOOD



WARNING:

- **The hood must be closed and latched securely before driving. Failure to do so could cause the hood to fly open and result in an accident.**
- **Never open the hood if steam or smoke is coming from the engine compartment to avoid injury.**

OPENING HOOD

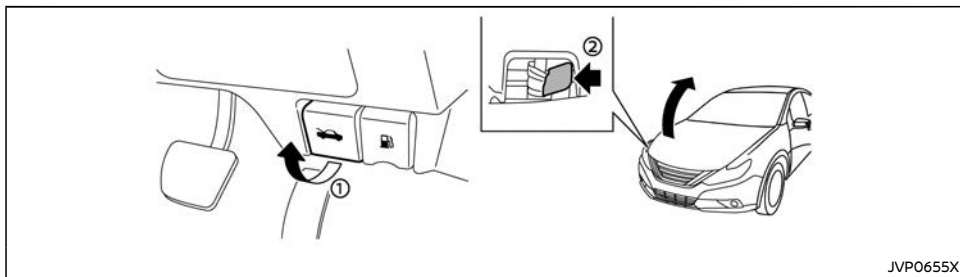

1. Pull the hood lock release handle ① located below the driver's side instrument panel; the hood springs up slightly.
2. Push the lever at the front of the hood ② as illustrated with your fingertips.
3. Raise the hood.

CLOSING HOOD

Slowly move the hood down to latch both the right and left locks. Push the hood down to lock the hood securely into place.

TRUNK LID



WARNING:

- The trunk lid must be closed securely before driving. An open trunk lid could allow dangerous exhaust gases to be drawn inside the vehicle.
- Closely supervise children when they are around your vehicle to prevent them from playing and becoming locked in the trunk where they could be seriously injured. Keep the vehicle locked, with the trunk closed, when not in use, and prevent children's access to vehicle keys.

OPENING TRUNK LID

The trunk lid can be opened by performing one of the following operations.

- Using the trunk opener
- Using the trunk open request switch while carrying the Intelligent Key
- Using the TRUNK  button on the Intelligent Key

Opener operation

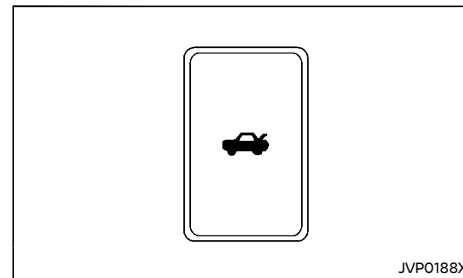

To open the trunk lid, push the opener switch for more than 1 second.

FUEL-FILLER LID

Trunk open request switch

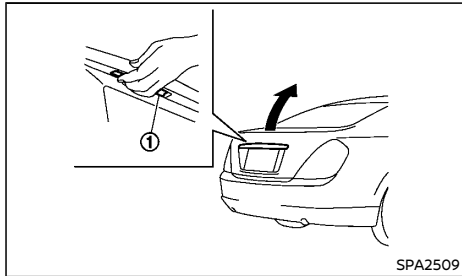

The trunk lid can be opened by pushing the trunk open request switch ① when the Intelligent Key is within the operating range of the trunk lock/unlock function. (See "Intelligent Key system" (P.3-5).)

Remote keyless operation

To open the trunk lid, push and hold the TRUNK  button on the Intelligent Key for longer than 1 second. (See "Using remote keyless entry system" (P.3-11).)

CLOSING TRUNK LID

To close the trunk lid, push the trunk lid down until it securely locks.

WARNING:

- Fuel is extremely flammable and highly explosive under certain conditions. You could be burned or seriously injured if it is misused or mishandled. Always stop the engine and do not smoke or allow open flames or sparks near the vehicle when refueling.
- Fuel may be under pressure. Turn the cap a half of a turn, and wait for any "hissing" sound to stop to prevent fuel from spraying out and possibly causing personal injury. Then remove the cap.
- Use only an original equipment type fuel-filler cap as a replacement. It has a built-in safety valve needed for proper operation of the fuel system and emission control system. An incorrect cap can result in a serious malfunction and possible injury.

OPENING FUEL-FILLER LID

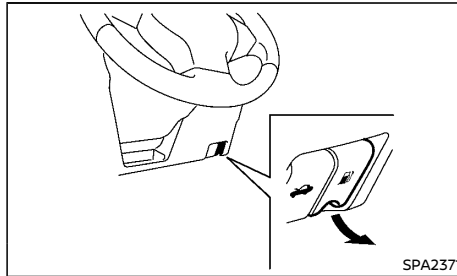

The fuel-filler lid release is located below the instrument panel. To open the fuel-filler lid, pull the release. To lock, close the fuel-filler lid securely.

FUEL-FILLER CAP

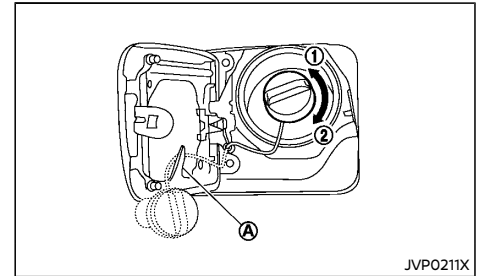

The fuel-filler cap is a ratcheting type. Turn the cap counterclockwise ① to remove. Tighten the cap clockwise ② until ratchet clicks, more than twice, after refueling.

Put the fuel-filler cap on the cap holder ④ while refueling.

CAUTION:

If fuel is spilled on the vehicle body, flush it away with water to avoid paint damage.

STEERING WHEEL

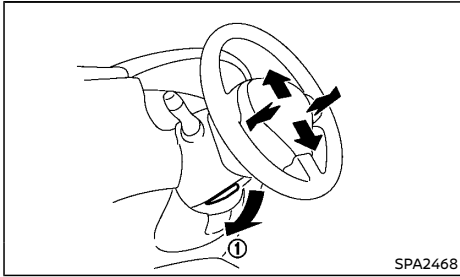

WARNING:

Never adjust the steering wheel while driving so that full attention may be given to vehicle operation.

Pull the lock lever ① down and adjust the steering wheel up, down, forward or rearward to the desired position. Push the lock lever up securely to lock the steering wheel in place.

MIRRORS

WARNING:

Adjust the position of all mirrors before driving. Do not adjust the mirror positions while driving so that full attention may be given to vehicle operation.

INSIDE REARVIEW MIRROR

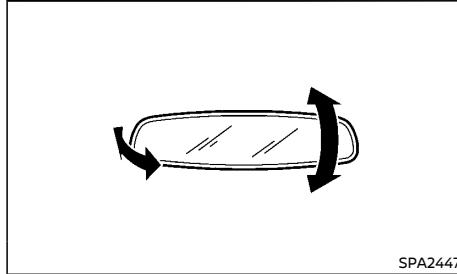

While holding the inside rearview mirror, adjust the mirror angles until the desired position is achieved.

Manual anti-glare type

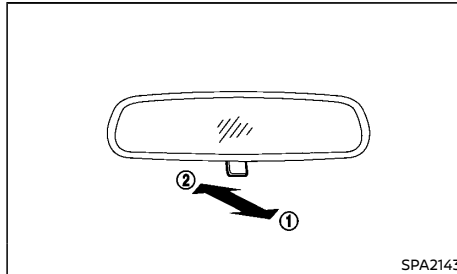

Pull the adjusting lever ① when the glare from

the headlights of the vehicle behind you obstructs your vision at night.

Push the adjusting lever ② during the day for the best rearward visibility.

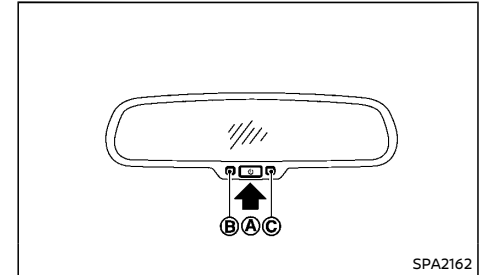

Automatic anti-glare type



The inside rearview mirror is designed so that it automatically changes reflection according to the intensity of the headlights of the vehicle following you.

The anti-glare system will be automatically turned on when you place the ignition switch in the "ON" position.

When the system is turned on, the indicator light ⑥ will illuminate and excessive glare from the headlights of the vehicle behind you will be reduced.

Push the  switch ④ to make the inside rearview mirror operate normally and the indicator light will turn off. Push the  switch again to turn the system on.

Do not hang any objects on the mirror or apply glass cleaner. Doing so will reduce the sensitivity of the sensor ③, resulting in improper operation.

OUTSIDE REARVIEW MIRRORS

WARNING:

- **Never touch the outside rearview mirrors while they are in motion. Doing so may pinch your fingers or damage the mirror.**
- **Never drive the vehicle with the outside rearview mirrors folded. This reduces rear view visibility and may lead to an accident.**
- **Objects viewed in the outside mirror are closer than they appear (if equipped).**
- **The picture dimensions and distance in the outside mirrors are not real.**

Adjusting

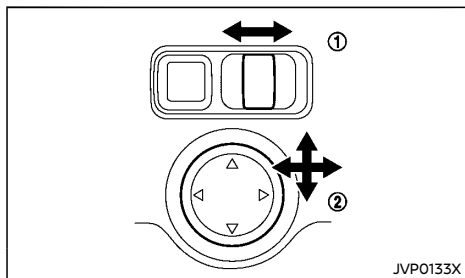

The outside rearview mirror remote control operates when the ignition switch is in the "ACC" or "ON" position.

1. Turn the switch to select the left (L) or right (R) mirror ①.
2. Adjust each mirror by pushing the switch until the desired position is achieved ②.

Defogging

The outside rearview mirrors will be heated when the rear window defogger switch is operated.

If the engine is started using the remote start function (if equipped) when the outside air temperature, the interior temperature and the engine coolant temperature are low, the rear window glass and outside mirror defogger may turn on automatically. For additional information about the remote engine start function, see "Remote engine start" (P.3-16).

Folding

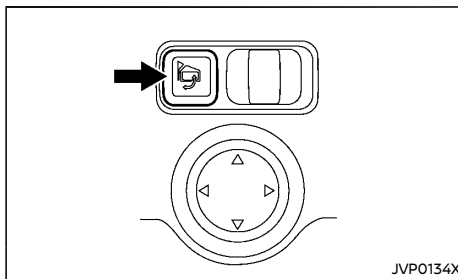

The outside rearview mirror remote control operates when the ignition switch is in the "ACC" or "ON" position.

The outside rearview mirrors automatically fold when the outside rearview mirror folding switch is pushed in. To unfold, push the switch again.

CAUTION:

- **Continuously performing the fold/unfold operation of the outside rearview mirror may cause the switch to stop the opera-**

tion.

- **Do not touch the mirrors while they are moving. Your hand may be pinched, and the mirror may malfunction.**
- **Do not drive with the mirrors stored. You will be unable to see behind the vehicle.**
- **If the mirrors were folded or unfolded by hand, there is a chance that the mirror will move forward or backward during driving. If the mirrors were folded or unfolded by hand, be sure to adjust them again electrically before driving.**

Reverse tilt-down feature (if equipped)

When backing up the vehicle, the right and left outside mirrors will turn downward automatically to provide better rear visibility.

1. Place the ignition switch in the "ON" position.
2. Move the shift lever to the "R" (Reverse) position.
3. Select the right or left outside mirror by operating the outside mirror control switch.
4. The outside mirror surfaces move downward.

When one of the following conditions has occurred, the selected outside mirror surface will return to its original position.

- The shift lever is moved to any position other than "R" (Reverse).
- The outside mirror control switch is set to the center position.
- The ignition switch is placed in the "OFF" position.

VANITY MIRROR

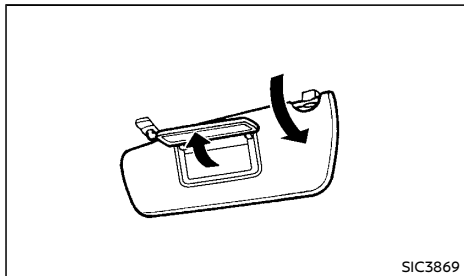

To access the vanity mirror, pull the sun visor down and flip open the mirror cover.

PARKING BRAKE



WARNING:

- **Never drive the vehicle with the parking brake applied. The brake will overheat and fail to operate and will lead to an accident.**
- **Never release the parking brake from outside the vehicle. If the vehicle moves, it will be impossible to push the foot brake pedal and will lead to an accident.**
- **Never use the shift lever in place of the parking brake. When parking, be sure the parking brake is fully applied.**
- **To help avoid risk of injury or death through unintended operation of the vehicle and/or its systems, do not leave children, people who require the assistance of others or pets unattended in your vehicle. Additionally, the temperature inside a closed vehicle on a warm day can quickly become high enough to cause a significant risk of injury or death to people and pets.**

the foot brake ② and then fully depress and release the parking brake pedal ①.

Before driving, be sure that the brake warning light has turned off.

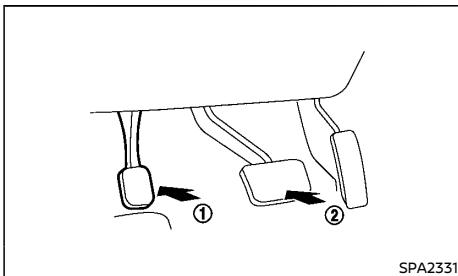

To apply the parking brake, firmly depress the parking brake pedal ①.

To release the parking brake, depress and hold

AUTOMATIC DRIVE POSITIONER (if equipped)

The automatic drive positioner system has the following features:

- Entry/exit function
- Memory storage

ENTRY/EXIT FUNCTION

This system is designed so that the driver's seat will automatically move when the shift lever is in the "P" (Park) position. This allows the driver to get into and out of the driver's seat more easily.

The driver's seat will slide backward when the driver's door is opened with the ignition switch in the "LOCK" position.

The driver's seat will return to the previous position when the ignition switch is placed in the "ACC" position.

The driver's seat will not return to the previous position if the seat adjusting switch is operated when the seat is at the exit position.

Activating or canceling entry/exit function

The shift lever must be in the "P" (Park) position with the ignition switch in the "OFF" position.

The entry/exit function can be activated or canceled by pushing and holding the SET switch for more than 10 seconds.

The entry/exit function can also be activated or canceled if the "Exit Seat Slide" key is turned to ON or OFF in the Vehicle Settings. (See "Vehicle information display" (P.2-11).)

Initializing entry/exit function

If the battery cable is disconnected, or if the fuse opens, the entry/exit function will not work though this function was set on before. In such a case, after connecting the battery or replacing with a new fuse, open and close the driver's door more than two times after the ignition switch is placed from the "ACC" position in the "LOCK" position. The entry/exit function will be activated.

MEMORY STORAGE

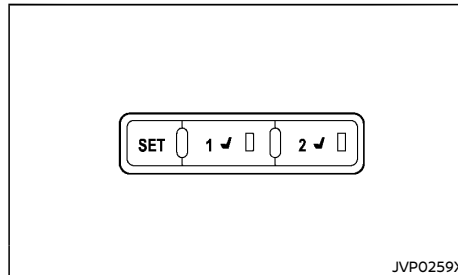

Two positions for the driver's seat and outside rearview mirrors can be stored in the automatic drive positioner memory. Follow these procedures to use the memory system.

1. Move the shift lever to the "P" (Park) position.
2. Place the ignition switch in the "ON" position.
3. Adjust the driver's seat to the desired position by manually operating each adjusting switch. (See "Seats" (P.1-2).)
4. Push the SET switch and, within 5 seconds, push the memory switch (1 or 2).

The indicator light for the pushed memory

switch will stay on for approximately 5 seconds after pushing the switch.

If memory is stored in the same memory switch, the previous memory will be deleted.

Linking Intelligent Key to a stored memory position

The Intelligent Key can be linked to a stored memory position with the following procedure.

1. Follow the steps for storing a memory position.
2. While the indicator light for the memory switch being set is illuminated for 5 seconds, push the  button on the Intelligent Key. If the indicator light blinks, the Intelligent Key is linked to that memory setting.

Function:

Place the ignition switch in the "OFF" position and push the "UNLOCK"  button on the Intelligent Key. The driver's seat and outside mirrors will move to the memorized position or to the exit position when the entry/exit function is set to active.

Confirming memory storage

- Place the ignition switch in the "ON" position and push the SET switch. If the main memory has not been stored, the indicator light will come on for approximately 0.5 seconds. When the memory has stored, the indicator light will stay on for approximately 5 seconds.
- If the battery cable is disconnected, or if the fuse opens, the memory will be canceled. In this case, reset the desired position using the previous procedure.

- If optional Intelligent Keys are added to your vehicle, the memory storage procedure to switch 1 or 2 and linking Intelligent Key procedure to a stored memory position should be performed again for each Intelligent Key. For additional Intelligent Key information, see "Keys" (P.3-2).
- When the seat has already been moved to the memorized position.
- When no position is stored in the memory switch.
- When the engine is started while moving the automatic drive positioner.
- When the shift lever is moved from the "P" (Park) position to any other position. (However, it will not be canceled if the shift lever is moved from the "P" (Park) position while the seat is returning to the previous position (entry/exit function).)
- For approximately 45 seconds after the driver's door was opened (the ignition switch is not in the "ON" position).

Selecting memorized position

1. Move the shift lever to the "P" (Park) position.
2. Use one of the following methods to move the driver's seat.
 - Place the ignition switch in the "ON" position and push the memory switch (1 or 2).
 - Within 45 seconds of opening the driver's door, push the memory switch (1 or 2).

The driver's seat will move to the memorized position or to the exit position when the entry/exit function is set to active with the indicator light flashing, and then the light will stay on for approximately 5 seconds.

SYSTEM OPERATION

The automatic drive positioner system will not work or will stop operating under the following conditions:

- When the vehicle speed is above 7 km/h (4 MPH) (entry/exit function).
- When the vehicle is driven (memory storage).
- When either the automatic drive positioner switch (SET switch, memory 1 or 2 switch) or the adjusting switch for the driver's seat is operated while the automatic drive positioner is operating.

4 Display screen, heater and air conditioner, and audio system

Safety precautions	4-3	Rear ventilators	4-20
Center multi-function control panel (models with navigation system)	4-3	Heater and air conditioner	4-20
How to use touch screen display	4-4	Operating tips	4-20
How to use brightness control/display on-off button	4-4	Dual zone automatic air conditioner	4-21
How to use ENTER/Scroll dial	4-4	Servicing air conditioner	4-22
How to use BACK button	4-4	Audio system	4-23
Vehicle information and settings (models with navigation system)	4-5	Audio operation precautions	4-23
How to use INFO button	4-5	Antenna	4-29
How to use SETUP button	4-5	FM-AM radio with Compact Disc (CD) player (models without navigation system)	4-29
Rear view monitor (if equipped)	4-6	FM-AM radio with Compact Disc (CD) player (models with navigation system)	4-35
How to read displayed lines	4-7	USB (Universal Serial Bus) connection port	4-39
Difference between predictive and actual distances	4-7	AUX (auxiliary) input jack (models with navigation system)	4-40
How to adjust screen	4-9	CD/USB device care and cleaning	4-40
Operating tips	4-9	Steering-wheel-mounted controls for audio	4-41
Intelligent Around View Monitor (if equipped)	4-10	Car phone and CB radio	4-42
How to switch the display	4-11	Bluetooth® Hands-Free Phone system (models without navigation system)	4-42
How to see each view	4-12	Regulatory information	4-43
Difference between predictive and actual distances	4-14	Using the system	4-43
Camera aiding parking sensor function (if equipped)	4-16	Bluetooth® Hands-Free Phone System (models with navigation system)	4-47
Moving Object Detection (MOD) function	4-16	Regulatory information	4-47
How to adjust the screen	4-17	Control buttons and microphone	4-47
View malfunction	4-18	Pairing procedure	4-48
Operating tips	4-19	Phonebook	4-48
Ventilators	4-19	Making a call	4-48
Center ventilators	4-19	Receiving a call	4-48
Side ventilators	4-19	During a call	4-48
		Ending a call	4-48

Bluetooth® settings	4-49
Telephone setup	4-49

SAFETY PRECAUTIONS



WARNING:

- Do not adjust the display controls, heater and air conditioner controls or audio controls while driving so that full attention may be given to vehicle operation.
- If you noticed any foreign objects entering the system hardware, spilled liquid on the system, or noticed smoke or fumes coming out from the system, or any other unusual operation is observed, stop using the system immediately and contact the nearest NISSAN dealer. Ignoring such conditions may lead to an accident, fire or electric shock.
- Do not disassemble or modify this system. If you do, it may lead to an accident, fire, or electric shock.
- Park the vehicle in a safe location and apply the parking brake to view images on the front center display screen.



CAUTION:

Do not use the system when the engine is not running for extended periods of time to prevent battery discharge.

CENTER MULTI-FUNCTION CONTROL PANEL (models with navigation system)

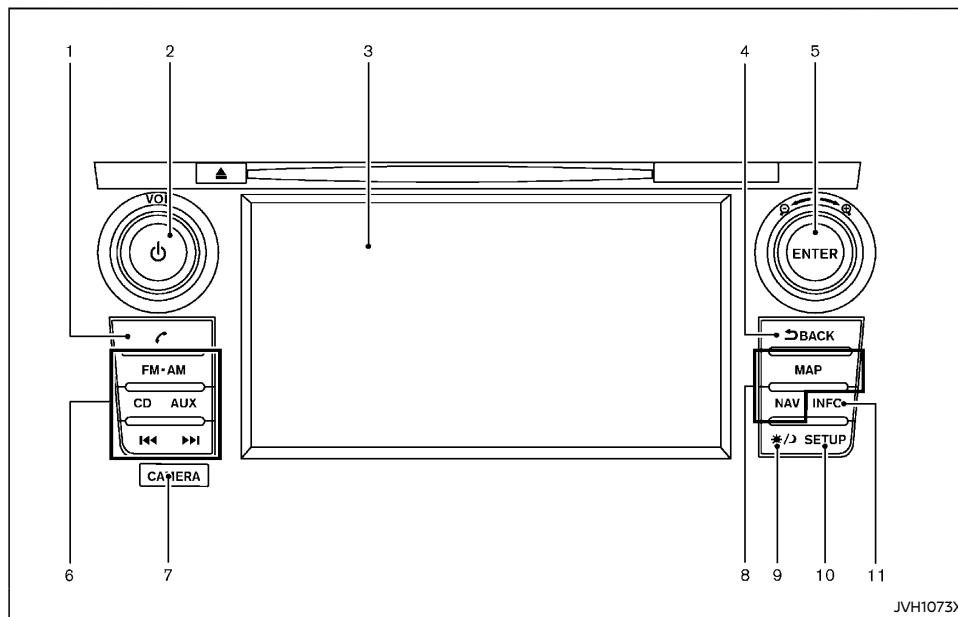

JVH1073X

1. Phone button (P.4-47)
2. Power/VOL (volume) dial (P.4-36)
3. Display screen (P.4-4)
4. BACK button (P.4-4)
5. ENTER/Scroll dial (P.4-4)
6. Audio control buttons (P.4-35)
7. CAMERA button (P.4-10)
8. For navigation system control buttons refer to the separate Navigation System Owner's Manual.
9. Brightness control/display on-off button (P. 4-4)
10. SETUP button (P.4-5)
11. INFO button (P.4-5)

HOW TO USE TOUCH SCREEN DISPLAY



WARNING:

- The glass display screen may break if it is hit with a hard or sharp object. If the glass screen breaks, do not touch it. Doing so could result in an injury.
- To clean the display, never use a rough cloth, alcohol, benzine, thinner or any kind of solvent or paper towel with a chemical cleaning agent. They will scratch or deteriorate the panel.
- Do not splash any liquid such as water or car fragrance on the display. Contact with liquid will cause the system to malfunction.

To help ensure safe driving, some functions cannot be operated while driving.

The on-screen functions that are not available while driving will be "grayed out" or muted.

Park the vehicle in a safe location and then operate the navigation system.



CAUTION:

- **ALWAYS** give your full attention to driving.
- **Avoid using vehicle features that could distract you. If distracted, you could lose control of your vehicle and cause an accident.**

Touch screen operation

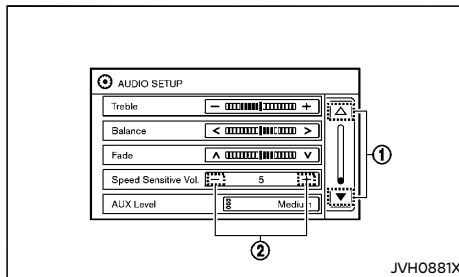

Selecting items:

Touch an item to select. For example, to select the "Treble" key, touch the "Treble" key on the screen. Touch up/down arrow ① on the screen to display the previous or the next page.

Adjusting items:

Touch the "+" or "-" ② key to adjust the settings of an item.

Entering characters:

Touch the letter or number key on the keyboard screen. Options below are available when inputting characters.

- **123/ABC:**
Changes the keyboard between numbers and alphabets.
- **Space:**
Inserts a space.
- **Delete:**
Deletes the last entered character with one touch. Touch and hold the "Delete" key to delete all of the characters.

- **OK:**

Completes the character input.

Touch screen maintenance

To clean the display screen, use a dry, soft cloth. If additional cleaning is necessary, use a small amount of neutral detergent with a soft cloth. Never spray the screen with water or detergent. Dampen the cloth first and then wipe the screen.

HOW TO USE BRIGHTNESS CONTROL/ DISPLAY ON-OFF BUTTON

Push the brightness control/display on-off "☀/🌙" button to change the display brightness between auto mode and night mode. While the mode is being displayed, the brightness can be adjusted using the ENTER/Scroll dial.

Push and hold the brightness control/display on-off "☀/🌙" button to turn the display off. Push the button again to turn the display on.

HOW TO USE ENTER/SCROLL DIAL

Turn the ENTER/Scroll dial to select items on the screen and to adjust the levels of setting items. Push the dial to confirm the selected item or setting.

HOW TO USE BACK BUTTON

Push the BACK button to return to the previous screen.

VEHICLE INFORMATION AND SETTINGS (models with navigation system)

Vehicle information can be checked and various settings can be adjusted on the display.

Designs and items displayed on the screen may vary depending on the models and specifications.

HOW TO USE INFO BUTTON

Push the INFO button to display the following information on the display screen.

Available items:

- Avoid Road Ahead
- Avoid Road in Route List
- Use Road Ahead
- Use Road in Route List
- Eco Score

See Navigation System Owner's Manual for details.

HOW TO USE SETUP BUTTON

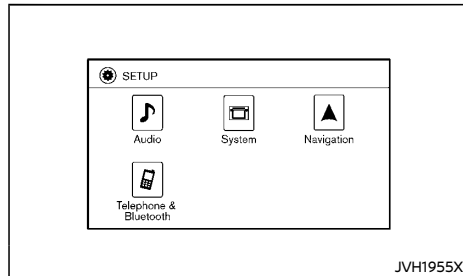

Example

Push the SETUP button to view and adjust the following setting items.

Available items:

- Audio

- System
 - Display
 - Clock
 - Language
 - Camera Settings
 - Temperature Unit
 - Touch Click
 - Beep Tones
 - Factory Settings
 - Software Licenses
 - System Software Version
- Navigation
- Telephone & Bluetooth

Audio settings

Audio settings can be adjusted from the audio setup screen.

1. Push the SETUP button.
2. Select the "Audio" key.
3. Select the item you wish to adjust.

Bass/Treble/Balance/Fade:

Touch the adjustment bar next to the corresponding keys on the display to adjust the tone quality and speaker balance.

The levels of these features can also be adjusted with the ENTER/Scroll dial. See "FM-AM radio with Compact Disc (CD) player (models with navigation system)" (P.4-35) for audio operations.

Speed Sensitive Vol.:

Speed sensitive volume function increases the volume of the audio system as the speed of the vehicle increases. Choose the desired effect level from 0 (OFF) to 5. The higher the setting, the more the volume increases in relation to vehicle speed.

AUX Level:

This feature controls the volume level of incoming sound when an auxiliary device is connected to the system. Select the level from "Quiet" (Low), "Medium", and "Loud" (High).

System settings

Various system settings can be adjusted from the system settings.

1. Push the SETUP button.
2. Select the "System" key.
3. Select the item you wish to adjust.

Display:

Select the corresponding keys to adjust the settings.

- **Brightness:**
Adjusts the brightness of the display.
- **Display Mode:**
Adjusts to fit the level of lighting in the vehicle. Touch the "Display Mode" key to cycle through options of the mode (Day, Night and Auto).
- **Scroll Direction:**
Adjusts the direction of the menu scroll. Choose either the up arrow or the down arrow.

Clock:

Select the corresponding keys to adjust the settings.

- **Time Format:**
The time setting can be selected from 12 hour and 24 hour formats.
- **Date Format:**
The day, month and year display can be selected.

- **Clock Mode:**

Select the clock mode from Manual, Time Zone and Auto.

When "Manual" is selected, you can set the clock mode manually from the "Set Clock Manually" screen.

Select "Auto" to automatically maintain the time using GPS.

- **Set Clock Manually:**

Mode (AM/PM) (if equipped), Hours, Minutes, Day, Month and Year can be set manually if "Manual" is selected in the Clock Mode setting.

- **Daylight Savings Time^{*}:**

Turns the daylight savings time on or off.

- **Time Zone^{*}:**

Select the applicable time zone from the list.

*: The setting operation is available only when "Time Zone" is selected among the "Clock Mode" setting menu.

Language:

Select a language to be displayed on the screen.

Camera Settings:

See "How to adjust the screen" (P.4-17) for details.

Temperature Unit:

Select the temperature unit from °C and °F.

Touch Click:

Turns the touch screen click feature on or off. When turned on, a click sound will be heard every time a key on the screen is touched.

Beep Tones:

Turns the beep tones feature on or off. When turned on, a beep sound will be heard as a pop-up message appears on the screen.

Factory Settings:

Select this key to return all settings to default.

Software Licenses:

Select this key to view software license information.

System Software Version:

This displays the software version your navigation system is currently running.

Navigation settings

Navigation settings can be changed. See Navigation System Owner's Manual for details.

Telephone & Bluetooth settings

Telephone & Bluetooth settings can be changed. See "Bluetooth® Hands-Free Phone System (models with navigation system)" (P.4-47) and "Bluetooth® audio player operation" (P.4-39) for details.

REAR VIEW MONITOR (if equipped)

When the shift lever is shifted into the "R" (Reverse) position, the monitor display shows the view to the rear of the vehicle.



WARNING:

Failure to follow the warnings and instructions for proper use of the rear view monitor could result in serious injury or death.

- **The rear view monitor is a convenience but it is not a substitute for proper backing. Always turn and look out the windows, and check mirrors to be sure that it is safe to move before operating the vehicle. Always back up slowly.**
- **The system is designed as an aid to the driver in showing large stationary objects directly behind the vehicle, to help avoid damaging the vehicle.**
- **The system cannot completely eliminate blind spots and may not show every object.**
- **Underneath the bumper and the corner areas of the bumper cannot be viewed on the rear view monitor because of its monitoring range limitation. The system will not show small objects below the bumper, and may not show objects close to the bumper or on the ground.**
- **Objects viewed in the rear view monitor differ from actual distance because a wide-angle lens is used.**
- **Objects in the rear view monitor will appear visually opposite than when viewed in the rearview and outside mirrors.**
- **Make sure that the trunk is securely closed when backing up.**

- Do not put anything on the rear view camera.
- When washing the vehicle with high-pressure water, be sure not to spray it around the camera. Otherwise, water may enter the camera unit causing water condensation on the lens, a malfunction, fire or an electric shock.
- Do not strike the camera. It is a precision instrument. Otherwise, it may malfunction or cause damage resulting in a fire or an electric shock.



CAUTION:

Do not scratch the camera lens when cleaning dirt or snow from the lens.

HOW TO READ DISPLAYED LINES

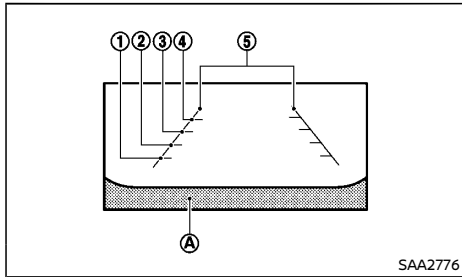

Guiding lines which indicate the vehicle width and distances to objects with reference to the bumper line (A) are displayed on the monitor.

Distance guide lines:

Indicate distances from the bumper.

- Red line ①: approx. 0.5 m (1.5 ft)
- Yellow line ②: approx. 1 m (3 ft)
- Green line ③: approx. 2 m (7 ft)
- Green line ④: approx. 3 m (10 ft)

Vehicle width guide lines ⑤:

Indicate the vehicle width when backing up.

DIFFERENCE BETWEEN PREDICTIVE AND ACTUAL DISTANCES

The distance guide line and the vehicle width guide line should be used as a reference only when the vehicle is on a level, paved surface. The distance viewed on the monitor is for reference only and may be different than the actual distance between the vehicle and displayed objects.

Moving to a steep uphill

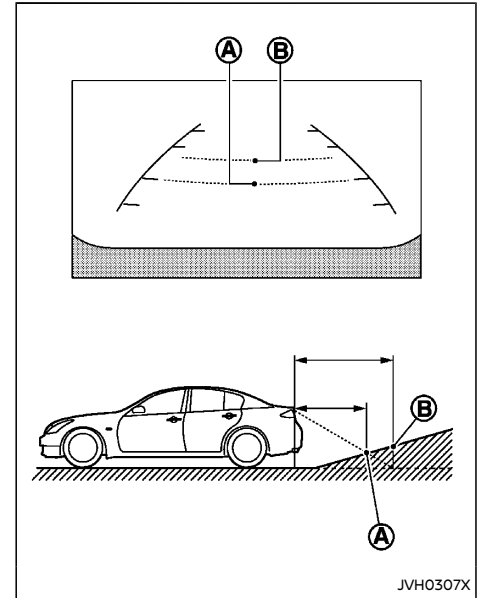

When moving the vehicle up a hill, the distance guide lines and the vehicle width guide lines are shown closer than the actual distance. For example, the display shows 1 m (3 ft) to the place (A), but the actual 1 m (3 ft) distance on the hill is the place (B). Note that any object on the hill is viewed in the monitor further than it appears.

Moving to a steep downhill

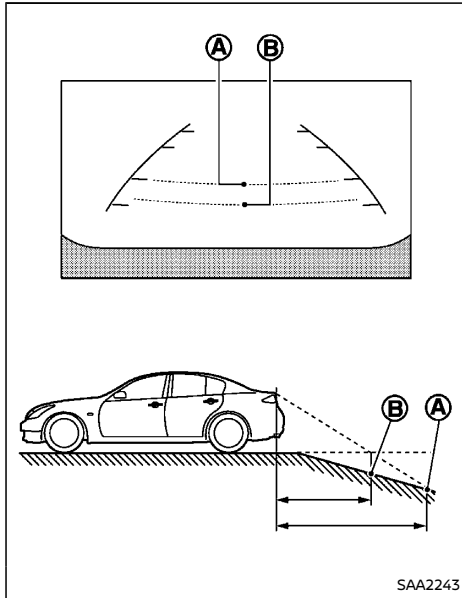

When moving the vehicle down a hill, the distance guide lines and the vehicle width guide lines are shown further than the actual distance. For example, the display shows 1 m (3 ft) to the place **A**, but the actual 1 m (3 ft) distance on the hill is the place **B**. Note that any object on the hill is viewed in the monitor closer than it appears.

Backing up near a projecting object

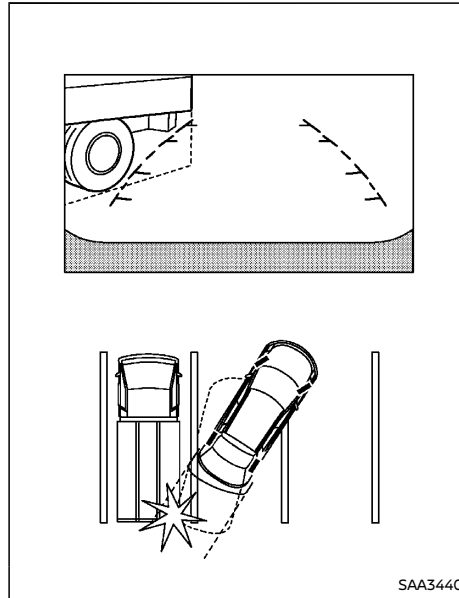

The vehicle may seem to nearly clear the object in the display. However, the vehicle may hit the object if it projects over the actual backing up course.

Backing up behind a projecting object

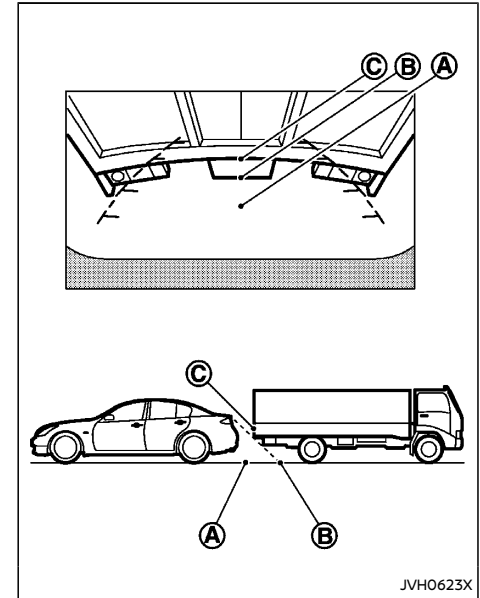

The position **C** is shown further than the position **B** in the display. However, the position **C** is actually at the same distance as the position **A**. The vehicle may hit the object when backing up to the position **A** if the object projects over the actual backing up course.

HOW TO ADJUST SCREEN

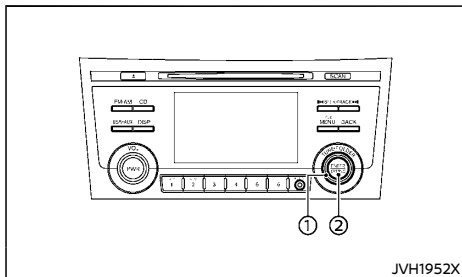

To set up the rear view monitor to your preferred settings, push the ENTER/SETTING button ② while the rear view monitor screen is displayed. Each time the ENTER/SETTING button ② is pushed, the next setting item is selected. Turn the TUNE-FOLDER control knob ① to adjust each item.

Available setting items:

- Brightness
- Contrast
- Language*

The setting items will disappear and the display will return to the original screen if ENTER/SETTING button ② is pushed when the last setting item is selected or if the screen is left without operation for some time.

*: Only the language of the warning messages on the camera screen can be switched.

OPERATING TIPS

- When the shift lever is shifted to the "R" (Reverse) position, the monitor screen automatically changes to the rear view monitor mode. However, the radio can be heard.
- It may take some time until the rear view monitor or the normal screen is displayed after the shift lever has been shifted to "R" from another position or to another position from "R". Objects may be distorted momentarily until the rear view monitor screen is displayed completely.
- When the temperature is extremely high or low, the screen may not clearly display objects. This is not a malfunction.
- When strong light directly enters the camera, objects may not be displayed clearly. This is not a malfunction.
- Vertical lines may be seen in objects on the screen. This is due to strong reflected light from the bumper. This is not a malfunction.
- The screen may flicker under fluorescent light. This is not a malfunction.
- The colors of objects on the rear view monitor may differ somewhat from those of the actual object.
- Objects on the monitor may not be clear in a dark place or at night. This is not a malfunction.
- If dirt, rain or snow attaches to the camera, the rear view monitor may not clearly display objects. Clean the camera.
- Do not use alcohol, benzine or thinner to clean the camera. This will cause discoloration. To clean the camera, wipe with a cloth dampened with diluted mild cleaning agent and then wipe with a dry cloth.

- Do not damage the camera as the monitor screen may be adversely affected.
- Do not use wax on the camera window. Wipe off any wax with a clean cloth dampened with mild detergent diluted with water.

INTELLIGENT AROUND VIEW MONITOR (if equipped)

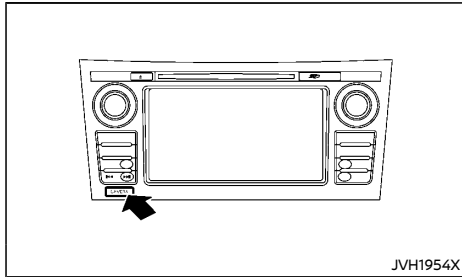

Models with navigation system

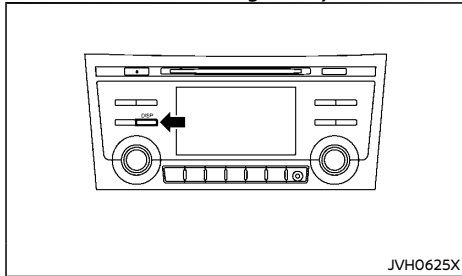

Models without navigation system

When you push the CAMERA (models with navigation system)/the DISP (models without navigation system) button or shift the shift lever into the "R" (Reverse) position while the ignition switch is in the "ON" position, the Intelligent Around View Monitor operates. The monitor displays various views of the position of the vehicle.

Available views:

- Bird's-eye view
The surrounding view of the vehicle.

- Front-side View
The view around and ahead of the front passenger's side wheel.
- Front View
The view to the front of the vehicle.
- Rear View
The view to the rear of the vehicle.

The system is designed as an aid to the driver in situations such as slot parking or parallel parking.

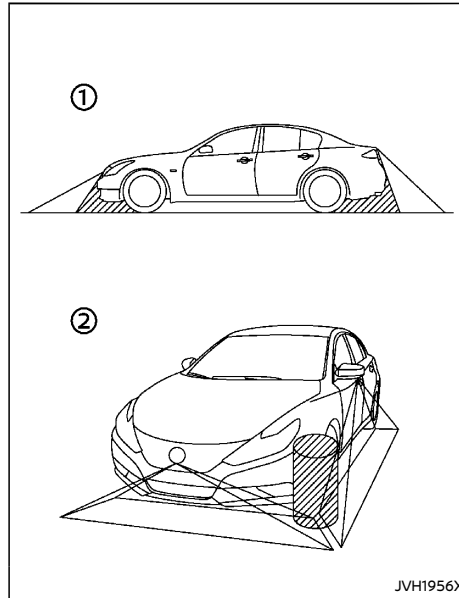

There are some areas where the system will not show objects. When in the front or the rear

view display, an object below the bumper or on the ground may not be viewed ①. When in the bird's-eye view, a tall object near the seam of the camera viewing areas will not appear in the monitor ②.



WARNING:

- The Intelligent Around View Monitor is a convenience but it is not a substitute for proper vehicle operation because it has areas where objects cannot be viewed. The four corners of the vehicle in particular, are blind spots where objects do not appear in the bird's-eye, front, or rear views. Always look out the windows and check with your own eyes to be sure that it is safe to move before operating the vehicle. Always operate the vehicle slowly.
- Do not use the Intelligent Around View Monitor with the outside mirror in the stored position, and make sure that the trunk is securely closed when operating the vehicle using the Intelligent Around View Monitor.
- The distance between objects viewed on the Intelligent Around View Monitor differs from the actual distance.
- The cameras are installed above the front grille, the outside mirrors and above the rear license plate. Do not put anything on the cameras.
- When washing the vehicle with high-pressure water, be sure not to spray it around the cameras. Otherwise, water may enter the camera unit causing water condensation on the lens, a malfunction, fire or an electric shock.

- Do not strike the cameras. They are precision instruments. Doing so could cause a malfunction or cause damage resulting in a fire or an electric shock.

CAUTION:

Do not scratch the lens when cleaning dirt or snow from the front of the camera.

HOW TO SWITCH THE DISPLAY

The Intelligent Around View Monitor display consists of the left and the right screens. You can see a combination of different views on the screens as illustrated.

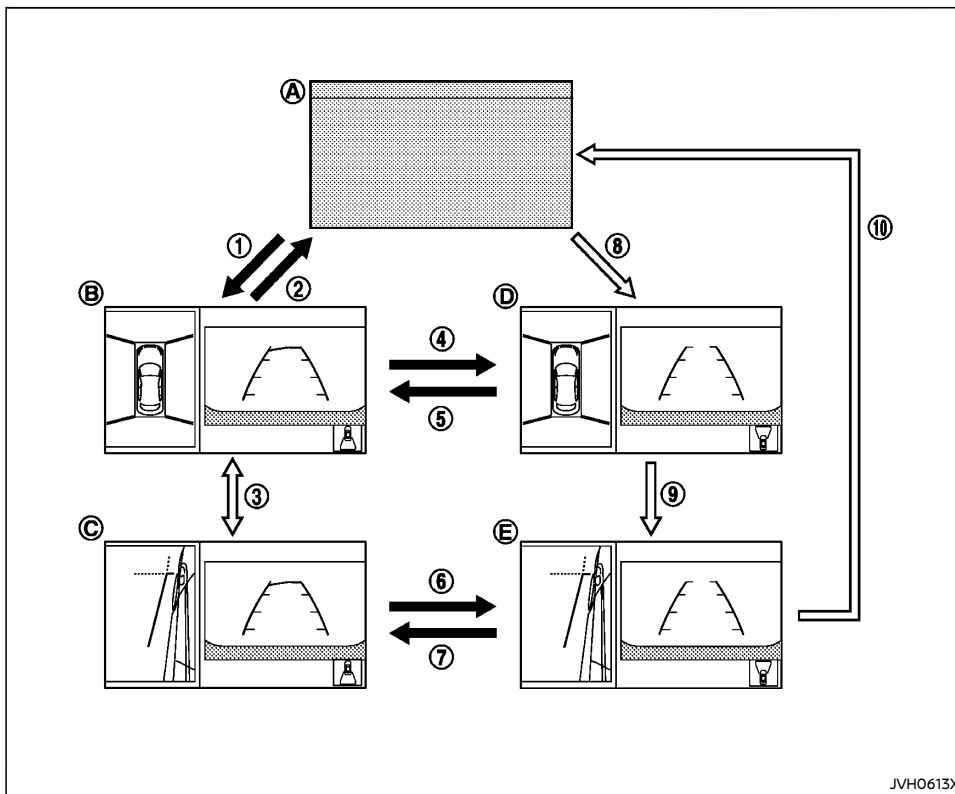

JVH0613X

➡: Shift the shift lever

➡: Push the CAMERA (models with navigation system)/the DISP (models without navigation system) button

(A): Original screen before the Intelligent Around View Monitor is operated

(B): Rear view/bird's-eye view screen

- Ⓒ: Rear view/front-side view screen
- Ⓓ: Front view/bird's-eye view screen
- Ⓔ: Front view/front-side view screen

Activating Intelligent Around View Monitor

Shift lever operation:

- When the shift lever is shifted into the "R" (Reverse) position ① while another screen ④ is displayed, Intelligent Around View Monitor operates and the rear view and bird's-eye view ⑤ are displayed.
The Intelligent Around View Monitor screen switches to the previous screen when the shift lever is shifted out of the "R" (Reverse) position ②.
- The view on the driver's side switches to the rear view ⑥ or ③ when the shift lever is shifted into the "R" (Reverse) position ⑤ or ⑦.
- The view will switch back to the front view ⑨ or ⑧ when the shift lever is shifted out of the "R" (Reverse) position ④ or ⑥).

CAMERA (models with navigation system)/DISP (models without navigation system) button operation:

- When the CAMERA/the DISP button is pushed ③ while a screen other than the Intelligent Around View Monitor ④ is displayed, Intelligent Around View Monitor is activated and the front view/bird's-eye view screen ⑨ is displayed.
- When the rear view is displayed on the right side on the screen ⑥ or ③), the view on the left side switches between the bird's-eye view ⑤ and the front-side view ③ each time the CAMERA/the DISP button is pushed ③).

- When the front view/bird's-eye view ⑨ is displayed on the screen, pushing the CAMERA/the DISP button ③ will switch the view on the left side to the front-side view ③. When the CAMERA/the DISP button is pushed again ③), the screen which was displayed before the Intelligent Around View Monitor was activated ④ is displayed.

HOW TO SEE EACH VIEW



WARNING:

- **The distance guide line and the vehicle width line should be used as a reference only when the vehicle is on a paved, level surface. The distance viewed on the monitor is for reference only and may be different than the actual distance between the vehicle and displayed objects.**
- **Use the displayed lines and the bird's-eye view as a reference. The lines and the bird's-eye view are greatly affected by the number of occupants, fuel level, vehicle position, road condition and road grade.**
- **If the tires are replaced with different sized tires, the predictive course line and the bird's-eye view may be displayed incorrectly.**
- **When driving the vehicle up a hill, objects viewed in the monitor are further than they appear. When driving the vehicle down a hill, objects viewed in the monitor are closer than they appear. Use the mirrors or actually look to properly judge distances to other objects.**
- **Objects in the rear view will appear visually opposite like ones viewed in the inside and outside mirrors.**

- **On the snow-covered or slippery road, there may be a difference between the predictive course lines and the actual course line.**
- **The displayed lines on the rear view will appear slightly off the right because the rear view camera is not installed in the rear center of the vehicle.**

The vehicle width and predictive course lines are wider than the actual width and course.

Front and rear view

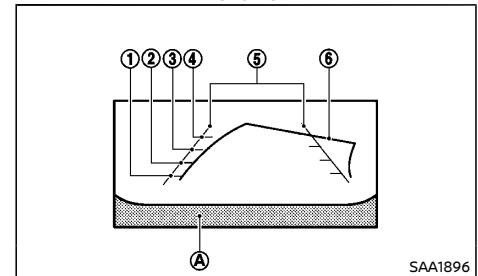
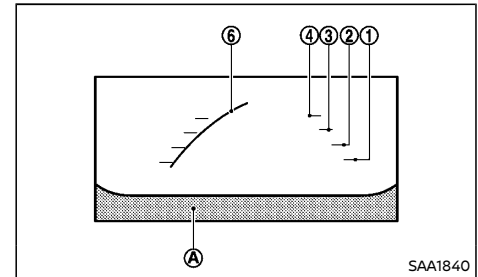

Guiding lines, which indicate the vehicle width

and distances to objects with reference to the vehicle body line ④, are displayed on the monitor.

Distance guide lines:

Indicate distances from the vehicle body.

- Red line ① : approx. 0.5 m (1.5 ft)
- Yellow line ② : approx. 1 m (3 ft)
- Green line ③ : approx. 2 m (7 ft)
- Green line ④ : approx. 3 m (10 ft)

Vehicle width guide lines ⑤ :

Indicate the vehicle width when backing up.

Predictive course lines ⑥ :

Indicate the predictive course when operating the vehicle. The predictive course lines will be displayed on the monitor when the steering wheel is turned. The predictive course lines will move depending on how much the steering wheel is turned. When the rear view is displayed, predictive course lines will not be displayed while the steering wheel is in the neutral position.

The front view will not be displayed when the vehicle speed is above 10 km/h (6 MPH).

WARNING:

- **The distance between objects viewed in the rear view may differ from the actual distance. Objects in the rear view will appear visually opposite from those viewed in the inside and outside mirrors.**
- **On a snow-covered or slippery road, there may be a difference between the predictive course line and the actual course line.**
- **The displayed lines on the rear view will appear slightly off to the right because the rear view camera is not installed in**

the rear center of the vehicle.

CAUTION:

When the monitor displays the front view and the steering wheel turns about 90 degrees or less from the neutral position, both the right and left predictive course lines ⑥ are displayed. When the steering wheel turns about 90 degrees or more, the predictive course line is displayed only on the opposite side of the turn.

Bird's-eye view

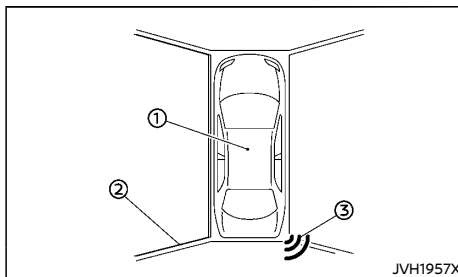

The bird's-eye view shows the overhead view of the vehicle which helps confirm the vehicle position and the predicted course to a parking space.

The vehicle icon ① shows the position of the vehicle. Note that the distance between objects viewed in the bird's-eye view differs from the actual distance.

The areas that the cameras cannot cover ② are indicated in black.

After the ignition switch is placed in the "ON" position, the nonviewable area ② is highlighted in yellow for 3 seconds after the bird's-eye view

is displayed.

When the vehicle moves closer to an object, the parking sensor indicators ③ (if equipped) appear. See "Parking sensor system" (P.5-21) for more information.

The parking sensor indicator ③ (if equipped) can be turned off. See "Driver Assistance" (P.2-12).

WARNING:

- **Objects in the bird's-eye view will appear further than the actual distance because the bird's-eye view is a pseudo view that is processed by combining the views from the cameras on the outside mirrors, the front and the rear of the vehicle.**
- **Tall objects, such as a curb or vehicle, may be misaligned or not displayed at the seam of the views.**
- **Objects that are above the camera cannot be displayed.**
- **The view for the bird's-eye view may be misaligned when the camera position alters.**
- **A line on the ground may be misaligned and is not seen as being straight at the seam of the views. The misalignment will increase as the line proceeds away from the vehicle.**

Front-side view

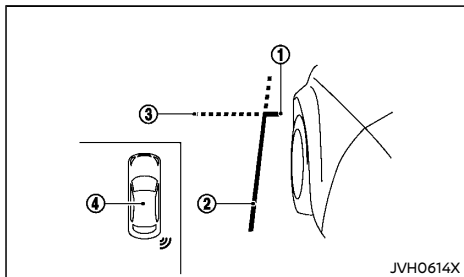

Guiding lines:

Guiding lines that indicate the width and the front end of the vehicle are displayed on the monitor.

The front-of-vehicle line ① shows the front part of the vehicle.

The side-of-vehicle line ② shows the vehicle width including the outside mirror.

The extensions ③ of both the front ① and side ② lines are shown with a green dotted line.

The parking sensor indicator ④ (if equipped) will appear when the vehicle moves closer to an object.

The parking sensor indicator ④ (if equipped) can be turned off. See "Driver Assistance" (P.2-12).

CAUTION:

- Do not scratch the camera lens when cleaning dirt or snow.
- The turn signal light may look like the side-of-vehicle line. This is not a malfunction.

DIFFERENCE BETWEEN PREDICTIVE AND ACTUAL DISTANCES

Moving to a steep uphill

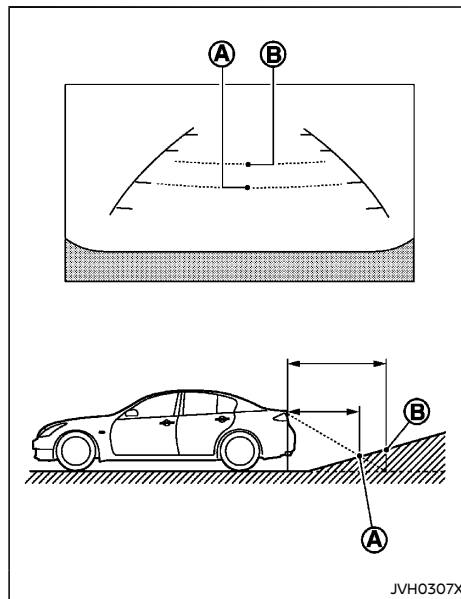

When moving the vehicle up a hill, the distance guide lines and the vehicle width guide lines are shown closer than the actual distance. For example, the display shows 1 m (3 ft) to the place ①, but the actual 1 m (3 ft) distance on the hill is the place ②. Note that any object on the hill is viewed in the monitor further than it appears.

Moving to a steep downhill

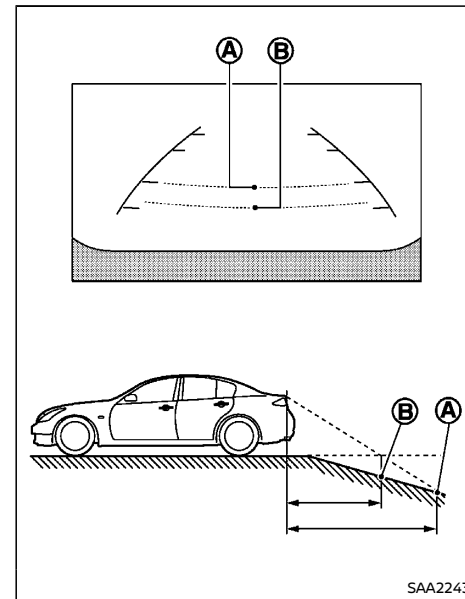

When moving the vehicle down a hill, the distance guide lines and the vehicle width guide lines are shown further than the actual distance. For example, the display shows 1 m (3 ft) to the place ①, but the actual 1 m (3 ft) distance on the hill is the place ②. Note that any object on the hill is viewed in the monitor closer than it appears.

Moving near a projecting object

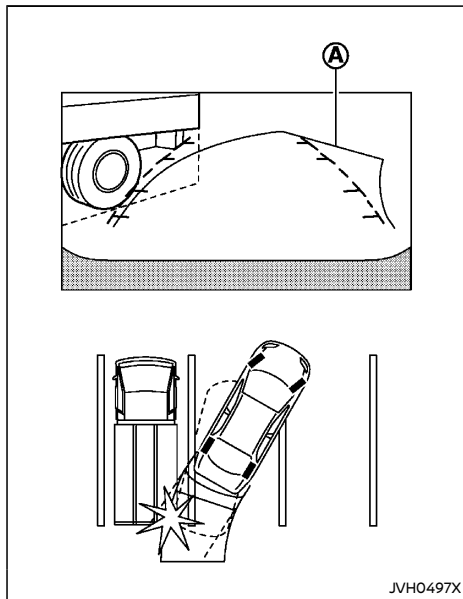

The predictive course lines **A** do not touch the object in the display. However, the vehicle may hit the object if it projects over the actual moving course.

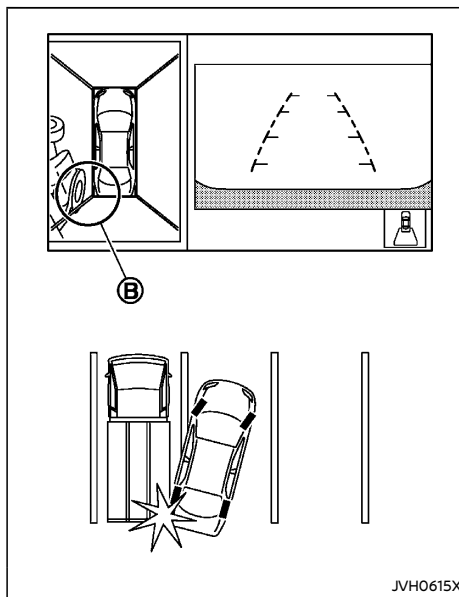

There may be a small distance visible between the vehicle and the object in the bird's-eye view on the display **B**.

Moving closer to a projecting object

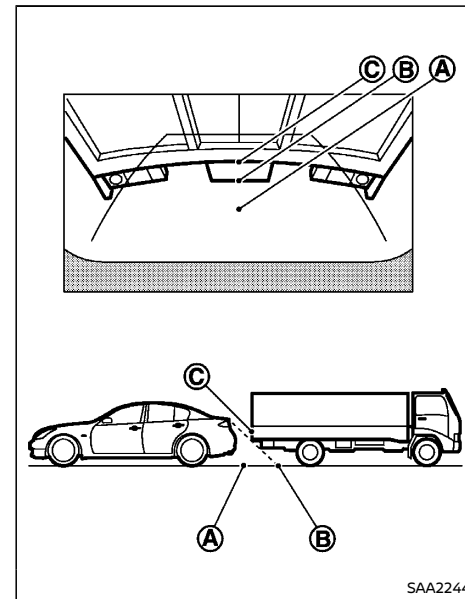

The position **C** is shown further than the position **B** in the display. However, the position **C** is actually at the same distance as the position **A**. The vehicle may hit the object when moving toward the position **A** if the object projects over the actual moving course.

CAMERA AIDING PARKING SENSOR FUNCTION (if equipped)

When the vehicle moves closer to the object while the Intelligent Around View Monitor is displayed, an indicator is displayed and a tone is sounded by the parking sensor function to warn the driver.

The color of the indicator and the pattern of the tone vary according to the distance to the object.

Keep the parking sensors (located on the front and rear bumper fascia) free from snow, ice and large accumulations of dirt. Do not clean the parking sensors with sharp objects. If the parking sensors are covered, the accuracy of the function will be diminished.

The tone sound and the parking sensor indicator display can be turned on/off, and the volume of the tone sound and the parking sensor detection range can be adjusted. See "Driver Assistance" (P.2-12).



WARNING:

- The parking sensor function is not designed to prevent the object.
- The colors of the parking sensor indicator and the distance guide lines in the front/rear view indicate different distances to the object.
- Inclement weather may affect the function of the parking sensor system; this may include reduced performance or a false activation.
- This function is designed as an aid to the driver in detecting large stationary objects to help avoid damaging the vehicle. The system will not detect small objects below the bumper, and may not detect

objects that are too close to the bumper or on the ground.

- **If your vehicle sustains damage to the bumper fascia, leaving it misaligned or bent, the sensing zone may be altered causing inaccurate measurement of obstacles or false alarms.**



CAUTION:

Keep the interior of the vehicle as quiet as possible to hear the tone clearly.

MOVING OBJECT DETECTION (MOD) FUNCTION

The Moving Object Detection (MOD) system can inform the driver of moving objects when driving out of garages, maneuvering into parking lots and in other such instances.

The MOD system detects moving objects by using image processing technology on the image shown in the display. The rear view camera is equipped with the automatic washer function using window washer fluid.

The MOD system operates in the following conditions when the camera view is displayed:

- When the shift lever is in the "P" or "N" position and the vehicle is stopped, the MOD system detects the moving objects in the bird's-eye view. The MOD system will not operate if the outside mirror is moving in or out or if either door is opened.
- When the shift lever is in the "D" position and the vehicle speed is below approximately 8 km/h (5 MPH), the MOD system detects moving objects in the front view.
- When the shift lever is in the "R" position and the vehicle speed is below approximately 8 km/h (5 MPH), the MOD system

detects moving objects in the rear view. The MOD system will not operate if the trunk is open.

The MOD system does not detect moving objects in the front-side view. The MOD icon is not displayed on the screen when in this view.



WARNING:

- **The MOD system is not a substitute for proper vehicle operation and does not prevent contact with the objects surrounding the vehicle. When maneuvering, always use the outside mirror and inside rearview mirror and turn and look to check the surroundings to make sure it is safe to maneuver.**
- **The system is deactivated at speeds above 8 km/h (5 MPH).**
- **The system is not designed to prevent contact with all objects.**
- **The MOD system is not designed to detect surrounding stationary objects.**

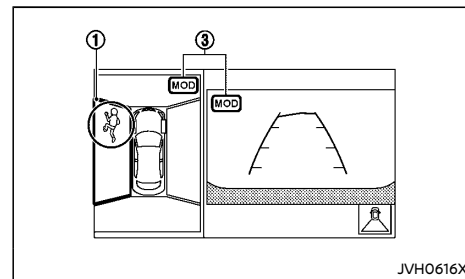

bird's-eye view

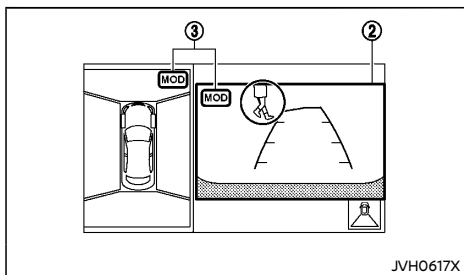

front view / rear view

When the MOD system detects a moving object surrounding the vehicle, the yellow frame will be displayed on the view where the objects are detected and a chime will sound once. While the MOD system continues to detect moving objects, the yellow frame continues to be displayed.

In the bird's-eye view, the yellow frame ① is displayed on each camera image (front, rear, right, left) depending on where moving objects are detected.

The yellow frame ② is displayed on each view in the front view and rear view modes.

While the parking sensor is beeping, the MOD system does not chime.

A blue MOD icon is displayed in the view where the MOD system is operative. A gray MOD icon is displayed in the view where the MOD system is not operative.

If the MOD system is turned off, the MOD icon ③ is not displayed.

The MOD system will turn on automatically under the following conditions:

- When the shift lever is in the "R" (Reverse) position.

- When the CAMERA (models with navigation system)/the DISP (models without navigation system) button is pressed to switch from a different screen to the camera view on the display.
- When vehicle speed decreases below approximately 8 km/h (5 MPH).

The MOD system can be set to remain inactive in the vehicle information display. See "Driver Assistance" (P.2-12).



WARNING:

- **Excessive noise (for example, audio system volume or open vehicle window) will interfere with the chime sound, and it may not be heard.**
- **The MOD system performance will be limited according to environmental conditions and surrounding objects such as:**
 - **When there is low contrast between background and the moving objects**
 - **When there is blinking source of light.**
 - **When strong light such as another vehicle's headlight or sunlight is present.**
 - **When there is dirt, water drops or snow on the camera lens.**
 - **When the position of the moving objects in the display is not changed.**
- **The MOD system might detect something like flowing water droplets on the camera lens, white smoke from the muffler, moving shadows, etc.**
- **The MOD system may not function properly depending on the speed, direction, distance or shape of the moving objects.**

- **If your vehicle sustains damage to the parts where the camera is installed, leaving it misaligned or bent, the sensing zone may be altered and the MOD system may not detect objects properly.**

Turning the MOD system on or off

The MOD system is turned on or off using in the vehicle information display. See "Driver Assistance" (P.2-12).

MOD malfunction

When the orange MOD icon is displayed in the view, the system is not functioning properly. This will not hinder normal driving operation but the system should be inspected by a NISSAN dealer.

Camera maintenance

If dirt, rain or snow accumulates on the camera, the MOD system may not operate properly. Clean the camera.

The rear view camera washer operates automatically when dirt is detected on the camera during driving. The washer then stops operation after a period of time.

HOW TO ADJUST THE SCREEN

Do not adjust the screen while the vehicle is moving.

Adjusting screen (models with navigation system)

Operation with touch screen:

1. Push the SETUP button.
2. Select the "System" key.
3. Select the "Camera Settings" key.

4. Select the item you wish to adjust.

- **Display Mode:**

Adjusts to fit the level of lighting in the vehicle. Touch the "Display Mode" key to cycle through options of the mode (Day, Night and Auto).

- **Brightness:**

Adjusts the brightness of the display.

- **Contrast:**

Adjusts the level of contrast.

- **Colour:**

Adjusts the level of the color.

Operation with buttons:

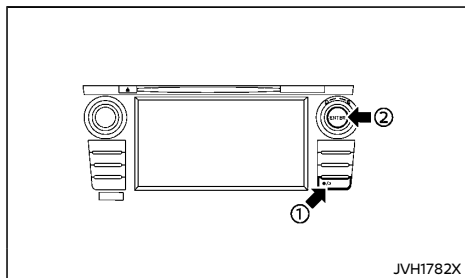

1. To adjust the screen brightness when the Intelligent Around View Monitor is displayed, push the brightness control/display on-off "*/" button ①.

2. Adjust brightness to the preferred setting using the ENTER/Scroll dial ②.

Adjusting screen (models without navigation system)

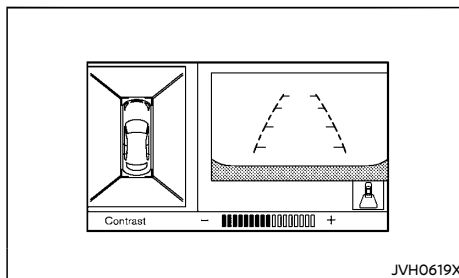
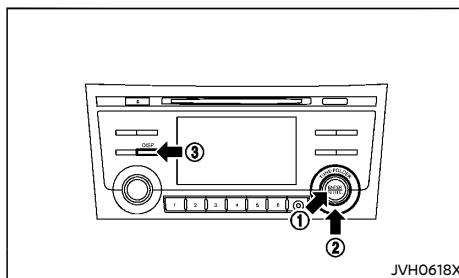

To set up the Intelligent Around View Monitor to your preferred settings, push the ENTER/SETTING button ① while the Intelligent Around View Monitor screen is displayed. Each time the ENTER/SETTING button ① is pushed, the next setting item is selected. Turn the TUNE-FOLDER control knob ② to adjust each item.

Available setting items:

- Brightness
- Contrast

The setting items will disappear and the display

will return to the original screen if the ENTER/SETTING button ① is pushed when the last setting item is selected or if the screen is left without operation for some time.

Choosing a language:

The warning message on the camera screen flashes when the DISP button ③ is pressed and held for more than 6 seconds. The language of the warning message changes when the DISP button ③ is pressed again while the warning message is flashing. When more than 6 seconds have elapsed with no operation, the warning message stops flashing and displays normally and the language is set.

VIEW MALFUNCTION

Camera

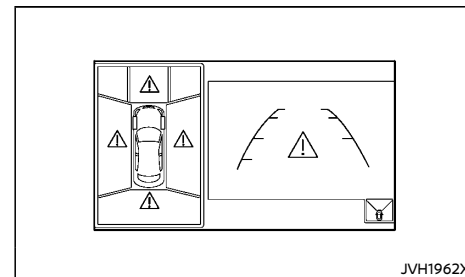

When the "!" icon is displayed on the screen, there will be abnormal conditions in the Intelligent Around View Monitor. This will not hinder normal driving operation but the system should be inspected by a NISSAN dealer.

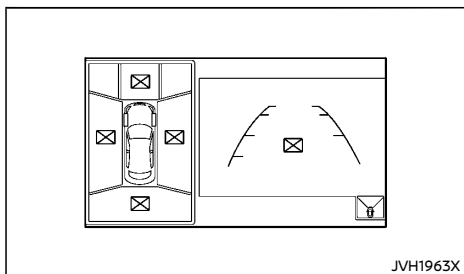

When the "[X]" icon is displayed on the screen, the camera image may be receiving temporary electronic disturbances from surrounding devices. This will not hinder normal driving operation but the system should be inspected by a NISSAN dealer if it occurs frequently.

OPERATING TIPS

- The screen displayed on the Intelligent Around View Monitor will automatically return to the previous screen when no operation takes place for 3 minutes after the CAMERA (models with navigation system)/the DISP (models without navigation system) button has been pushed while the shift lever is in a position other than the "R" (Reverse) position.
- The display of images on the screen may be delayed after screens are switched.
- When the temperature is extremely high or low, the screen may not display objects clearly. This is not a malfunction.
- When strong light directly shines on the camera, objects may not be displayed clearly. This is not a malfunction.
- The screen may flicker under fluorescent light. This is not a malfunction.
- The colors of objects on the Intelligent Around View Monitor may differ somewhat from those of the actual object.
- Objects on the monitor may not be clear and the color of the object may differ in a dark location or at night. This is not a malfunction.
- There may be differences in clearness between each camera view of the bird's-eye view.
- If dirt, rain or snow attaches to the camera, the Intelligent Around View Monitor may not display objects clearly. Clean the camera.
- Do not use alcohol, benzine or thinner to clean the camera. This will cause discoloration. To clean the camera, wipe with a cloth that has been dampened with a diluted mild cleaning agent and then wipe with a dry cloth.
- Do not damage the camera because the monitor screen may be adversely affected.
- Do not use wax on the camera window. Wipe off any wax with a clean cloth that has been dampened with a mild detergent diluted with water.

VENTILATORS

CENTER VENTILATORS

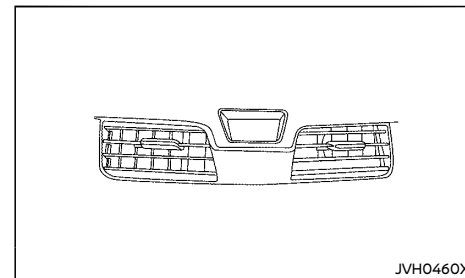

Adjust the air flow direction of the ventilators by moving the center knob (up/down, left/right) until the desired position is achieved.

SIDE VENTILATORS

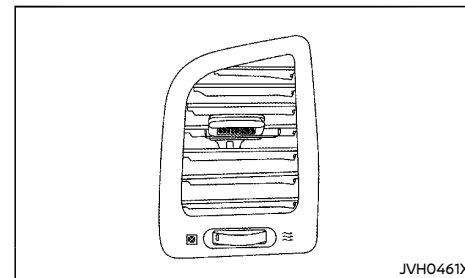

Open/close the ventilators by moving the control to either direction.

- ☒ : This symbol indicates that the ventilators are closed. Moving the side control to this direction will close the ventilators.

HEATER AND AIR CONDITIONER

 : This symbol indicates that the ventilators are open. Moving the side control to this direction will open the ventilators.

Adjust the air flow direction of the ventilators by moving the center knob (up/down, left/right) until the desired position is achieved.

REAR VENTILATORS

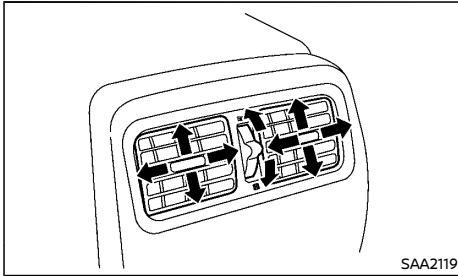

Open/close the ventilators by moving the control to either direction.

 : This symbol indicates that the ventilators are closed. Moving the side control to this direction will close the ventilators.

 : This symbol indicates that the ventilators are open. Moving the side control to this direction will open the ventilators.

Adjust the air flow direction of the ventilators by moving the center knob (up/down, left/right) until the desired position is achieved.

WARNING:

- The heater and air conditioner operate only when the engine is running.
- Never leave children or adults who would normally require the support of others alone in the vehicle. Pets should not be left alone either. They could unknowingly activate switches or controls and inadvertently become involved in a serious accident and injure themselves. On hot, sunny days, temperatures in a closed vehicle could quickly become high enough to cause severe or possibly fatal injuries to people or animals.
- Do not use the recirculation mode for long periods as it may cause the interior air to become stale and the windows to fog up.
- Do not adjust the heating and air conditioning controls while driving so that full attention may be given to vehicle operation.

The heater and air conditioner operate when the engine is running. The air blower will operate even if the engine is turned off and the ignition switch is in the "ON" position.

NOTE:

- Odors from inside and outside the vehicle can build up in the air conditioner unit. Odor can enter the passenger compartment through the vents.
- When parking, set the heater and air conditioner controls to turn off air recirculation to allow fresh air into the passenger compartment. This should help reduce odors inside the vehicle.

OPERATING TIPS

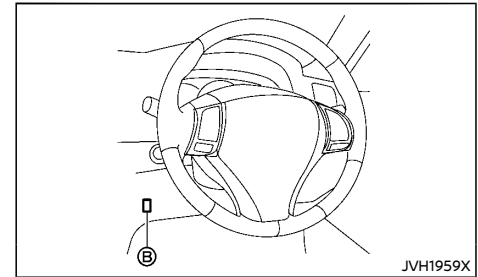
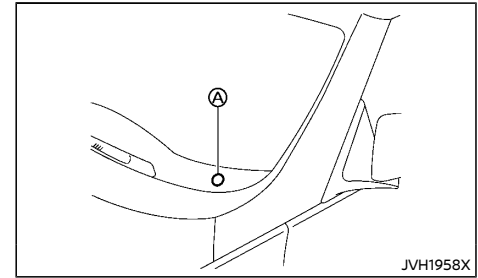

When the engine coolant temperature and outside air temperature are low, the air flow from the foot outlets may not operate. However, this is not a malfunction. After the coolant temperature warms up, the air flow from the foot outlets will operate normally.

The sensors **A** and **B** located on the instrument panel help maintain a constant temperature. Do not put anything on or around the sensors.

DUAL ZONE AUTOMATIC AIR CONDITIONER

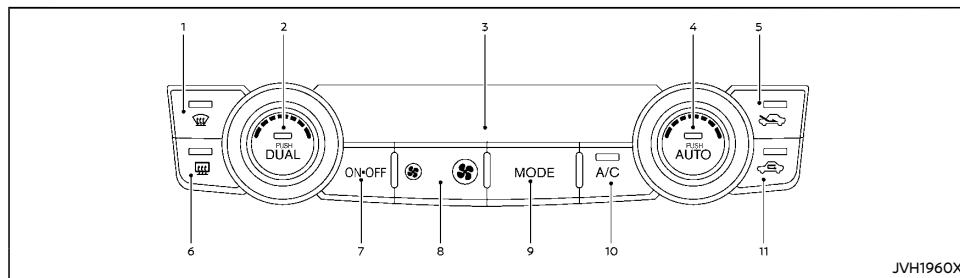

1. (front defogger) button
2. Temperature control dial (passenger's side)/DUAL button
3. Display screen
4. Temperature control dial (driver's side)/AUTO (automatic) button
5. (outside air circulation) button
6. (rear window defogger) button
(See "Defogger switch" (P.2-23).)
7. ON-OFF button
8. (fan speed control) buttons
9. MODE (manual air flow control) button
10. A/C (air conditioner) button
11. (air recirculation) button



WARNING:

- **The air conditioner cooling function operates only when the engine is running.**
- **Do not leave children or adults who would normally require the assistance of others alone in your vehicle. Pets should also not be left alone. They could acci-**

dentally injure themselves or others through inadvertent operation of the vehicle. Also, on hot, sunny days, temperatures in a closed vehicle could quickly become high enough to cause severe or possibly fatal injuries to people or animals.

- **Do not use the recirculation mode for long periods as it may cause the interior air to become stale and the windows to fog up.**

Automatic operation

Cooling and/or dehumidified heating (AUTO):

This mode may be used all year round as the system automatically works to keep a constant temperature. Air flow distribution and fan speed are also controlled automatically.

1. Push the AUTO button on. (The indicator on the button will illuminate and AUTO will be displayed.)
2. Turn the temperature control dial to the left or right to set the desired temperature.



- Adjust the temperature display to about 24°C (75°F) for normal operation.
 - The temperature of the passenger compartment will be maintained automatically. Air flow distribution and fan speed are also controlled automatically.
 - A visible mist may be seen coming from the vents in hot, humid conditions as the air is cooled rapidly. This does not indicate a malfunction.
3. You can individually set driver's and front passenger's side temperature using each temperature control dial. When the DUAL button or passenger's side temperature dial is turned, the DUAL indicator will come on. To turn off the passenger's side temperature control, push the DUAL button.

Heating (A/C OFF):

The air conditioner does not activate in this mode. Only use this mode when you need to heat the vehicle.

1. Push the A/C button. (The A/C indicator will turn off.)
 2. Turn the temperature control dial to set the desired temperature.
- The temperature of the passenger compartment will be maintained automatically. Air flow distribution and fan speed are also controlled automatically.
 - Do not set the temperature lower than the outside air temperature or the system may not work properly.
 - Not recommended if windows fog up.

Dehumidified defrosting or defogging:

1. Push the  front defogger button on. (The indicator light on the button will come on.)
2. Turn the temperature control dial to set the desired temperature.
 - To quickly remove ice from the outside of the windows, use the fan speed control buttons to set the fan speed to maximum.
 - As soon as possible after the windshield is clean, push the AUTO button to return to the automatic mode.
 - When the  front defogger button is pushed, the air conditioner will automatically be turned on at outside temperatures above 2°C (35°F) (The indicator light may or may not illuminate). The air recirculation mode automatically turns off, allowing outside air to be drawn into the passenger compartment to further improve the defogging performance.





Manual operation



Fan speed control:

Push the  fan control buttons to manually control the fan speed.

Push the AUTO button to return to automatic control of the fan speed.





Air intake control:

- Push the  air recirculation button to recirculate interior air inside the vehicle. The  indicator light on the button will come on.
- Push the  outside air circulation button to draw outside air into the passenger compartment. The  indicator light on the button will come on.

- To switch to automatic control mode, push and hold the  air recirculation button or the  outside air circulation button (the button with the indicator light turned on) for about 2 seconds. The indicator lights (both air recirculation and outside air circulation buttons) will flash twice, and then the air intake will be controlled automatically.

Air flow control:

Pushing the MODE button manually controls air flow and selects the air outlet:

- : Air flows from the center and side ventilators.
- : Air flows from the center and side ventilators and the foot outlets.
- : Air flows mainly from the foot outlets.
- : Air flows from the defogger and foot outlets.

To turn the system off

Push the ON-OFF button.

Remote engine start logic (if equipped)

When the remote engine start function is activated, your vehicle may go into automatic heating or cooling mode depending on the outside and cabin temperatures. During this period, the automatic air conditioner display and buttons will be inoperable until the ignition switch is placed in the "ON" position. When the temperature is low, the rear defogger may also be activated automatically with the activation of the remote engine start function. (See "Remote engine start" (P.3-16).)

SERVICING AIR CONDITIONER



WARNING:

The air conditioner system contains refrigerant under high pressure. To avoid personal injury, any air conditioner service should be done only by an experienced technician with the proper equipment.

The air conditioner system in your vehicle is charged with a refrigerant designed with the environment in mind.

This refrigerant will not harm the earth's ozone layer. However, it may contribute in a small part to global warming.

Special charging equipment and lubricant are required when servicing your vehicle's air conditioner. Using improper refrigerants or lubricants will cause severe damage to the air conditioner system. (See "Air conditioner system refrigerant and lubricant" (P.9-4).)

A NISSAN dealer will be able to service your environmentally friendly air conditioner system.

Air conditioner filter

The air conditioner system is equipped with an air conditioner filter which collects dirt and dust, etc. To make sure the air conditioner heats, defogs and ventilates efficiently, replace the filter according to the specified maintenance intervals listed in a separate maintenance booklet. To replace the filter, contact a NISSAN dealer.

The filter should be replaced if the air flow decreases significantly or if windows fog up easily when operating the heater or air conditioner.

AUDIO SYSTEM

AUDIO OPERATION PRECAUTIONS



WARNING:

Do not adjust the audio system while driving so that full attention may be given to vehicle operation.

Radio

- Radio reception is affected by station signal strength, distance from radio transmitter, buildings, bridges, mountains and other external influences. Intermittent changes in reception quality normally are caused by these external influences.
- Using a cellular phone in or near the vehicle may influence radio reception quality.
- Some cellular phones or other devices may cause interference or a buzzing noise to come from the audio system speakers. Storing the device in a different location may reduce or eliminate the noise.

Compact Disc (CD) player

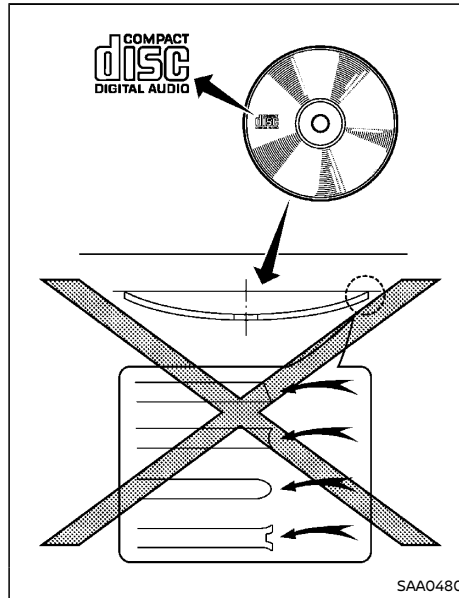

- During cold weather or rainy days, the player may malfunction due to the humidity. If this occurs, remove the CD from CD player and dehumidify or ventilate the player completely.
- The player may skip while driving on rough roads.
- The CD player sometimes may not function when the passenger compartment temperature is extremely high. Lower the temperature before use.

- Do not expose the CD to direct sunlight.
- CDs that are of poor quality, or are dirty, scratched, covered with fingerprints, or that have pin holes may not work properly.
- The following CDs may not work properly.
 - Copy control compact discs (CCCD)
 - Recordable compact discs (CD-R)
 - Rewritable compact discs (CD-RW)
- Do not use the following CDs as they may cause the CD player to malfunction.
 - 8 cm (3.1 in) discs
 - CDs that are not round
 - CDs with a paper label
 - CDs that are warped, scratched or have unusual edges.
- This audio system can only play pre-recorded CDs. It has no capabilities to record or burn CDs.
- If the CD cannot be played, one of the following messages will be displayed.
Check disc:
 - Confirm that the CD is inserted correctly (the label side is facing up, etc.).
 - Confirm that the CD is not bent or warped and it is free of scratches.

Push eject:

This is a malfunction due to the temperature inside the player is too high. Remove the CD by pushing the EJECT button, and after a short time reinsert the CD. The CD can be played when the temperature of the player returns to normal.

Unplayable:

The file is unplayable in this audio system (only MP3 or WMA CD).

USB (Universal Serial Bus) connection port



WARNING:

Do not connect, disconnect or operate the USB device while driving. Doing so can be a distraction. If distracted you could lose control of your vehicle and cause an accident or serious injury.



CAUTION:

- **Do not force the USB device into the USB connection port. Inserting the USB device tilted or up-side-down into the port may damage the port. Make sure that the USB device is connected correctly into the USB connection port.**
- **Do not grab the USB connection port cover (if equipped) when pulling the USB device out of the port. This could damage the port and the cover.**
- **Do not leave the USB cable in a place where it can be pulled unintentionally. Pulling the cable may damage the port.**

The vehicle is not equipped with a USB device. USB devices should be purchased separately as necessary.

This system cannot be used to format USB devices. To format a USB device, use a personal computer.

In some states/area, the USB device for the front seats plays only sound without images for regulatory reasons, even when the vehicle is parked.

This system supports various USB devices, USB hard drives and iPod players. Some USB devices may not be supported by this system.

- Partitioned USB devices may not be played correctly.
- Some characters used in other languages (Chinese, Japanese, etc.) are not displayed properly on display. Using English language characters with a USB device is recommended.

General notes for USB use:

Refer to your device manufacturer's owner information regarding the proper use and care of the device.

Notes for iPod use:

iPod and iPhone are a trademark of Apple Inc., registered in the U.S. and other countries.

- Improperly plugging in the iPod may cause a checkmark to be displayed on and off (flickering). Always make sure that the iPod is connected properly.
- An iPod nano (1st Generation) may remain in fast forward or rewind mode if it is connected during a seek operation. In this case, please manually reset the iPod.
- An iPod nano (2nd Generation) will continue to fast-forward or rewind if it is disconnected during a seek operation.
- An incorrect song title may appear when the Play Mode is changed while using an iPod nano (2nd Generation)
- Audiobooks may not play in the same order as they appear on an iPod.
- Large video files cause slow responses in an iPod. The vehicle center display may momentarily black out, but will soon recover.
- If an iPod automatically selects large video files while in the shuffle mode, the vehicle center display may momentarily black out, but will soon recover.

Bluetooth® Audio player

- Some Bluetooth® audio devices may not be used with this system.
- Before using a Bluetooth® audio system, the initial registration process for the audio device is necessary.
- Operation of the Bluetooth® audio system may vary depending on the audio device that is connected. Confirm the operation procedure before use.
- The playback of Bluetooth® audio will be paused under the following conditions. The playback will be resumed after the following conditions are completed.
 - while using a hands-free phone
 - while checking a connection with a cell phone
- The in-vehicle antenna for Bluetooth® communication is built in the system. Do not place the Bluetooth® audio device in an area surrounded by metal, far away from the system or in a narrow space where the device closely contacts the body or the seat. Otherwise, sound degradation or connection interference may occur.
- While a Bluetooth® audio device is connected through the Bluetooth® wireless connection, the battery power of the device may discharge quicker than usual.
- This system is compatible with the Bluetooth® AV profile (A2DP and AVRCP).

Bluetooth® is a trademark owned by Bluetooth SIG, Inc., and licensed to Visteon Corporation and Robert Bosch GmbH.



Compact Disc (CD)/USB memory with MP3/WMA/AAC (if equipped)

Terms:

- **MP3** — MP3 is short for Moving Pictures Experts Group Audio Layer 3. MP3 is the most well known compressed digital audio file format. This format allows for near “CD quality” sound, but at a fraction of the size of normal audio files. MP3 conversion of an audio track from CD can reduce the file size by approximately 10:1 ratio (Sampling: 44.1 kHz, Bit rate: 128 kbps) with virtually no perceptible loss in quality. MP3 compression removes the redundant and irrelevant parts of a sound signal that the human ear doesn’t hear.
- **WMA** — Windows Media Audio (WMA) is a compressed audio format created by Microsoft as an alternative to MP3. The WMA codec offers greater file compression than the MP3 codec, enabling storage of more digital audio tracks in the same amount of space when compared to MP3s at the same level of quality.
- **AAC** — Advanced Audio Coding (AAC) is a compressed audio format. AAC offers greater file compression than MP3 and enables music file creation and storage at the same quality as MP3.
- **Bit rate** — Bit rate denotes the number of bits per second used by a digital music files. The size and quality of a compressed digital audio file is determined by the bit rate used when encoding the file.
- **Sampling frequency** — Sampling frequency is the rate at which the samples of a signal are converted from analog to digital (A/D conversion) per second.

- **Multisession** — Multisession is one of the methods for writing data to media. Writing data once to the media is called a single session, and writing more than once is called a multisession.
 - **ID3/WMA Tag** — The ID3/WMA tag is the part of the encoded MP3 or WMA file that contains information about the digital music file such as song title, artist, album title, encoding bit rate, track time duration, etc. ID3 tag information is displayed on the Album/Artist/Track title line on the display.
- * Windows® and Windows Media® are registered trademarks and/or trademarks of Microsoft Corporation in the United States of America and/or other countries.

Playback order:

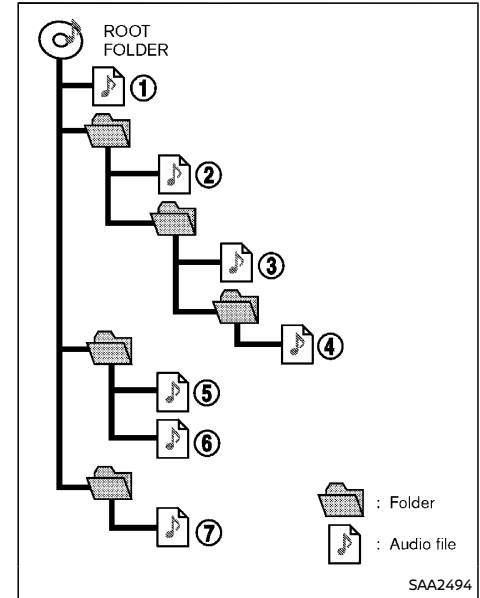

Music playback order of the CD with MP3/WMA is as illustrated above.

- The folder names of folders not containing MP3/WMA files are not shown in the display.
- If there is a file in the top level of the disc, “Root Folder” is displayed.
- The playback order is the order in which the files were written by the writing software, so the files might not play in the desired order.

Specification chart (models without navigation system):

Supported media		CD, CD-R, CD-RW, USB 2.0	
Supported file systems		CD, CD-R, CD-RW: ISO9660 LEVEL1, ISO9660 LEVEL2, Romeo, Joliet * ISO9660 Level 3 (packet writing) is not supported. * Files saved using the Live File System component (on a Windows Vista-based computer) are not supported.	
		UDF Bridge (UDF1.02+ISO9660), UDF1.5, UDF2.0 * UDF1.5/UDF2.0 (packet writing) is not supported. * Files saved using the Live File System component (on a Windows Vista-based computer) are not supported.	
		USB device: FAT16, FAT32	
Supported versions*1	MP3	Version	MPEG-1 Audio Layer 3, MPEG-2 Audio Layer 3
		Sampling frequency	MPEG-2 Audio Layer 3: 16kHz, 22.05kHz, 24kHz MPEG-1 Audio Layer 3: 32kHz, 44.1kHz, 48kHz
		Bit rate	8 kbps - 320 kbps
	WMA*2	Version	WMA7, WMA8, WMA9
		Sampling frequency	8k/11.025k/16k/22.05k/32k/44.1k/48 kHz
		Bit rate	12,16,20,22,32,40,48,80,96,128,160,192kbps , VBR*3
	AAC*5	Version	MPEG-AAC
		Sampling frequency	11.025 kHz - 48 kHz
		Bit rate	8 kbps - 256 kbps, VBR*3
Tag information (album title, song title and artist name)		ID3 tag VER1.0, VER1.1, VER2.2, VER2.3, VER2.4 (MP3 only)	
		WMA tag (WMA only)	
Folder levels/Capacity		CD, CD-R, CD-RW: Folder levels: 8, Folders: 255 (including root folder), Files: 1024 (Max. 1024 files for one folder) USB 2.0: Folder levels: 8, Folders: 512 (including root folder), Files: 8000 (Max. 255 files for one folder)	
Displayable character codes*4		01: ASCII, 02: ISO-8859-1, 03: UNICODE (UTF-16 BOM Big Endian), 04: UNICODE (UTF-16 Non-BOM Big Endian), 05: UNICODE (UTF-8), 06: UNICODE (Non-UTF-16 BOM Little Endian), 07: SHIFT-JIS	

*1 Files created with a combination of 48 kHz sampling frequency and 64 kbps bit rate cannot be played.

*2 Protected WMA files (DRM) cannot be played. Playback of silence for 5 seconds.

*3 When VBR files are played, the playback time may not be displayed correctly. WMA7 and WMA8 are not applied to VBR.

*4 Available codes depend on what kind of media, versions and information are going to be displayed.

*5 Only m4a files (saved using iTunes) are supported.

4-26 Display screen, heater and air conditioner, and audio system

Specification chart (models with navigation system):

Supported media		CD, CD-R, CD-RW, USB 2.0	
Supported file systems		ISO9660 LEVEL 1, ISO9660 LEVEL2, Apple ISO, Romeo, Joliet *ISO9660 LEVEL 3 (packet writing) is not supported.	
Supported versions*1	MP3	Version	MPEG1, MPEG2, MPEG2.5
		Sampling frequency	8 kHz - 48 kHz
		Bit rate	8 kbps - 320 kbps, VBR
	WMA*2	Version	WMA7, WMA8, WMA9
		Sampling frequency	32 kHz - 48 kHz
		Bit rate	48 kbps - 192 kbps, VBR
Tag information		ID3 tag VER1.0, VER1.1, VER2.2, VER2.3 (MP3 only)	
Folder levels		Folder levels: 8, Max folders: 255 (including root folder), Files: 512 (Max. 255 files for one folder)	
Displayable character codes*2		01: ASCII, 02: ISO-8859-1, 03: UNICODE (UTF-16 BOM Big Endian), 04: UNICODE (UTF-16 Non-BOM Big Endian), 05: UNICODE (UTF-8), 06: UNICODE (Non-UTF-16 BOM Little Endian)	

*1 Files created with a combination of 48 kHz sampling frequency and 64 kbps bit rate cannot be played.

*2 Available codes depend on what kind of media, versions and information are going to be displayed.

Troubleshooting guide:

Symptom	Cause and Countermeasure
Cannot play	Check if the disc was inserted correctly.
	Check if the disc is scratched or dirty.
	Check if there is condensation inside the player, and if there is, wait until the condensation is gone (about 1 hour) before using the player.
	If there is a temperature increase error, the CD player will play correctly after it returns to the normal temperature.
	If there is a mixture of music CD files (CD-DA data) and MP3/WMA files on a CD, only the music CD files (CD-DA data) will be played.
	Files with extensions other than ".MP3", ".WMA", ".M4A", ".mp3", ".wma" or "m4a" cannot be played. In addition, the character codes and number of characters for folder names and file names should be in compliance with the specifications.
	Check if the disc or the file is generated in an irregular format. This may occur depending on the variation or the setting of MP3/WMA writing applications or other text editing applications.
	Check if the finalization process, such as session close and disc close, is done for the disc.
	Check if the disc is protected by copyright.
Poor sound quality	Check if the disc is scratched or dirty.
It takes a relatively long time before the music starts playing.	If there are many folder or file levels on the MP3/WMA disc, some time may be required before the music starts playing.
Music cuts off or skips	The writing software and hardware combination might not match, or the writing speed, writing depth, writing width, etc., might not match the specifications. Try using the slowest writing speed.
Skipping with high bit rate files	Skipping may occur with large quantities of data, such as for high bit rate data.
Move immediately to the next song when playing.	When a non-MP3/WMA file has been given an extension of ".MP3", ".WMA", ".M4A", ".mp3", ".wma" or "m4a", or when play is prohibited by copyright protection, the player will skip to the next song.
The songs do not play back in the desired order.	The playback order is the order in which the files were written by the writing software, so the files might not play in the desired order.

ANTENNA

Window antenna

The antenna pattern is printed inside the rear window.



CAUTION:

- Do not place metallic film near the rear window. Do not attach any metal items to the rear window. This may cause poor reception and/or noise.
- When cleaning the inside of the rear window, be careful not to scratch or damage the rear window antenna. Lightly wipe along the antenna with a dampened soft cloth.

Diversity antenna (if equipped):

The electronic tuning radio has a diversity reception system. The FM signal can reflect off of obstacles such as buildings or mountains. This causes offensive noises. The diversity system employs two antennas and automatically switches to the antenna with the better reception. Thus the radio transmits less noise.

FM-AM RADIO WITH COMPACT DISC (CD) PLAYER (models without navigation system)

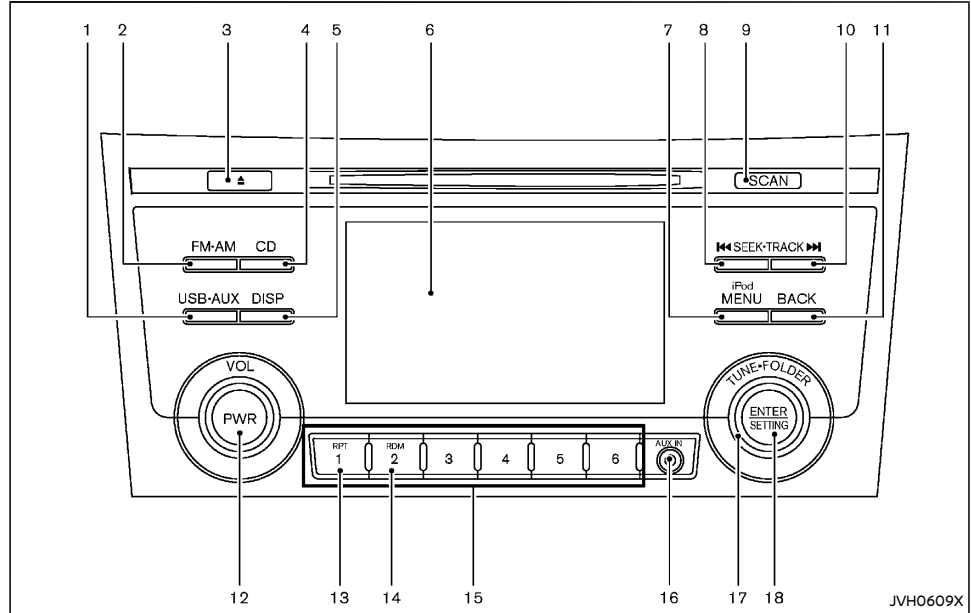

- | | |
|--------------------------|--------------------------------------|
| 1. USB-AUX button | 8. SEEK-TRACK (rewind) button |
| 2. FM-AM button | 9. SCAN tuning button |
| 3. CD eject button | 10. SEEK-TRACK (fast forward) button |
| 4. CD button | 11. BACK button |
| 5. DISP (display) button | 12. VOL (volume)/Power button |
| 6. Color display | 13. RPT (repeat) button |
| 7. iPod MENU button | 14. RDM (random) button |

- 15. Radio station preset select buttons
- 16. AUX (Auxiliary) IN jack
- 17. TUNE-FOLDER control knob
- 18. ENTER/SETTING button

Audio main operation

The audio system operates when the ignition switch is in the "ACC" or "ON" position.

Head unit:

The auto loudness circuit enhances the low and high frequency ranges automatically in both radio reception and CD playback.

Power ON-OFF:

To turn on the audio system, push the VOL/Power button.

- The system will turn on in the mode which was used immediately before the system was turned off.
- If there are no CDs loaded, the radio will be turned on.

To turn off the audio system, push the VOL/Power button.

Volume control:

To control the volume, turn the VOL/Power button.

Turn the VOL/Power button clockwise to increase the volume.

Turn the VOL/Power button counterclockwise to decrease the volume.

Audio settings:

The settings screen will appear when pushing the ENTER/SETTING button.

The following items are available in the settings screen.

- **Bluetooth**
It is possible to set the Bluetooth® settings. For details of the Bluetooth® settings, see "Bluetooth® streaming audio operation" (P.4-34) and "Setup" (P.4-43).
- **Bass, Treble, Balance and Fade**
Controls the sound of the audio system. Balance adjusts the sound between the left and right speakers. Fade adjusts the sound between the front and rear speakers.
Select the "Bass", "Treble", "Balance" or "Fade" using the TUNE-FOLDER control knob and then push the ENTER/SETTING button. Turn the TUNE-FOLDER control knob to adjust the Bass, Treble, balance and Fade of the screen to the preferred level.
- **Speed Sens Vol.**
To change the Speed Sensitive Volume (Speed Sens Vol.) level from off (0) to 5, turn the TUNE-FOLDER control knob.
- **AUX Vol.**
Controls the volume level of incoming sound when an auxiliary device is connected to the system. Choose a setting between 1 and 3 or choose 0 to disable the feature entirely.
- **Brightness and Contrast**
Adjust the brightness and contrast of the screen.
Select the "brightness" or "contrast" using the TUNE-FOLDER control knob and then push the ENTER/SETTING button. Turn the TUNE-FOLDER control knob to adjust the brightness and contrast of the screen to the preferred level.
- **Clock Adjust**
Adjust the clock according to the following procedure.

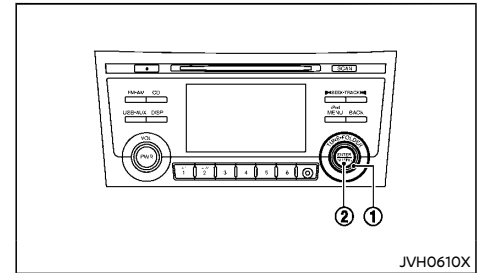

- 1) Select "Clock Adjust" using the TUNE-FOLDER control knob ① and then push the ENTER/SETTING button ②.
- 2) Adjust the hour with the TUNE-FOLDER control knob ① and then push the ENTER/SETTING button ②.
- 3) Adjust the minute with the TUNE-FOLDER control knob ① and then push the ENTER/SETTING button ②.

24 hour clock is not available.

- **On-Screen Clock**
When this item is turned on, a clock is always displayed in the upper right corner of the screen.
Select the "On-Screen Clock" using the TUNE-FOLDER control knob and then push the ENTER/SETTING button. You can toggle between ON and OFF using the TUNE-FOLDER control knob.
- **RDS Display (if equipped)**
RDS (radio data system) information can be shown on the display. Select "RDS Display" using the TUNE-FOLDER control knob and then push the ENTER/SETTING button. You can toggle between ON and OFF using the TUNE-FOLDER control knob.

- Language Select

The Language Select can be set to English, Chinese, Taiwanese or Korea.

Select "Language Select" using the TUNE-FOLDER control knob and then push the ENTER/SETTING button. Use the TUNE-FOLDER control knob to select the preferred language.

AUX IN jack:

The AUX IN jack is located on the audio unit. The AUX IN audio input jack accepts any standard analog audio input such as from a portable cassette tape/CD player, MP3 player or laptop computer.

NISSAN strongly recommends using a stereo mini plug cable when connecting your music device to the audio system. Music may not play properly when a monaural cable is used.

USB-AUX button:

Pushing the USB-AUX button will switch the displays as follows:

USB → AUX → USB

Radio operation

radio (FM-AM) band select:

Pushing the FM-AM button will change the band as follows:

AM → FM1 → FM2 → AM

TUNE (Tuning):

Turn the radio TUNE-FOLDER control knob for manual tuning.

Radio Data System (RDS) (if equipped):

RDS stands for Radio Data System, and is a data information service transmitted by some radio stations on the FM band (not AM band) encoded within a regular radio broadcast. Currently, most RDS stations are in large cities, but many stations are now considering broadcasting RDS data.

RDS can display:

- Station name, such as "The Groove".
- Music or programing type such as "Classical", "Country" or "Rock".



Push the SEEK-TRACK (rewind) or SEEK-TRACK (fast forward) button to tune from low to high or high to low frequencies and to stop at the next broadcasting station.

SCAN tuning:



Push the SCAN tuning button to tune from low to high frequencies and stop at each broadcasting station for 5 seconds. Pushing the button again during this 5 seconds period will stop SCAN tuning and the radio will remain tuned to that station.

If the SCAN tuning button is not pushed within 5 seconds, SCAN tuning moves to the next station.

Station memory operations:

12 stations can be set for the FM band (6 each for FM1 and FM2) and 6 stations can be set for the AM band.

1. Choose the radio band using the FM-AM button.

2. Tune to the desired station using the SEEK-TRACK, SCAN button or the radio TUNE-FOLDER control knob.
3. Push and hold the desired station preset button  to  until the radio mutes.
4. The station indicator will then come on and the sound will resume. Memorizing is now complete.
5. Other buttons can be set in the same manner.

If the battery cable is disconnected, or if the fuse opens, the radio memory will be erased. In that case, reset the desired stations.

CD player operation

Place the ignition switch in the "ACC" or "ON" position and insert the Compact Disc (CD) into the slot with the label side facing up. The CD will be guided automatically into the slot and start playing.

After loading the CD, the number of tracks on the CD and the play time will appear on the display.

If the radio is already operating, it will automatically turn off and the CD will play.

If the system has been turned off while the CD was playing, pushing the VOL/Power button will start the CD.

PLAY:

When the CD button is pushed with the system off and the CD loaded, the system will turn on and the CD will start to play.

When the CD button is pushed with the CD loaded and the radio playing, the radio will automatically be turned off and the CD will start to play.

 **SEEK/TRACK button:**

When the SEEK-TRACK (rewind) or SEEK-TRACK (fast forward) button is pushed for more than 1.5 seconds while the CD is being played, the CD will play while fast forwarding or rewinding. When the button is released, the CD will return to normal play speed.

When the SEEK-TRACK (rewind) or SEEK-TRACK (fast forward) button is pushed for less than 1.5 seconds while the CD is being played, the next track or the beginning of the current track on the CD will be played.

 **REPEAT (RPT):**

When the RPT button is pushed while the CD is played, the play pattern can be changed as follows:

(CD)

Normal ⇔ 1 Track Repeat

(CD with compressed audio files)

Normal → 1 Folder Repeat → 1 Track Repeat → Normal

 **RANDOM (RDM):**

When the RDM button is pushed while a CD is being played, the play pattern can be changed as follows:

(CD)

Normal ⇔ 1 Disc Random

(CD with compressed audio files)

Normal → 1 Disc Random → 1 Folder Random → Normal

 **CD eject:**

When the CD eject button is pushed with the CD loaded, the CD will be ejected.

When this button is pushed while the CD is being played, the CD will be ejected.

If the CD comes out and is not removed, it will be pulled back into the slot to protect it.

USB device operation

Audio main operation:

Connecting a USB device will switch the audio mode to the USB mode automatically. See "USB (Universal Serial Bus) connection port" (P.4-39) for the location of the USB connection port.

If the system has been turned off while the USB device was playing, pushing the VOL/Power button will start the USB device.

 **WARNING:**

Do not connect, disconnect or operate the USB device while driving. Doing so can be a distraction. If distracted you could lose control of your vehicle and cause an accident or serious injury.

 **CAUTION:**

- **Do not force the USB device into the USB connection port. Inserting the USB device tilted or up-side-down into the port may damage the port. Make sure that the USB device is connected correctly into the USB connection port.**
- **Do not grab the USB connection port cover (if equipped) when pulling the USB device out of the port. This could damage the port and the cover.**

- **Do not leave the USB cable in a place where it can be pulled unintentionally. Pulling the cable may damage the port.**

Refer to your device manufacturer's owner information regarding the proper use and care of the device.

 **PLAY:**

When the USB-AUX button is pushed with the system off and the USB device inserted, the system will turn on.

If another audio source is playing and a USB device is inserted, push the USB-AUX button repeatedly until the color display changes to the USB device mode.

 **Previous/Next File and Fast Rewind/Forward:**

When the SEEK-TRACK (rewind) or SEEK-TRACK (fast forward) button is pushed for more than 1.5 seconds while a USB device is being played, the USB device will play while forwarding or rewinding. When the button is released, the USB device will return to normal play speed.

When the SEEK-TRACK (rewind) or SEEK-TRACK (fast forward) button is pushed for less than 1.5 seconds while the USB device is being played, the next track or the beginning of the current track on the USB device will be played.

Folder selection:

To change to another folder in the USB device, turn the TUNE-FOLDER control knob.

RPT REPEAT (RPT):

When the RPT button is pushed while the USB device is played, the play pattern can be change as follows.

To change the play mode, push the RPT button repeatedly and the mode will change as follows.

Normal → 1 Folder Repeat → 1 Track Repeat → Normal

RDM RANDOM (RDM):

When the RDM button is pushed while a USB device is being played, the play pattern can be changed as follows.

To change the play mode, push the RDM button repeatedly, and the mode will change as follows.

Normal → All Random → 1 Folder Random → Normal

BACK BACK:

When the BACK button is pushed, it returns to the previous display.

iPod player operation

Connecting iPod:

Connect the iPod cable to the USB connection port. See "USB (Universal Serial Bus) connection port" (P.4-39) for the location of the USB connection port.

Depending on the version of the iPod, the display on the iPod shows a NISSAN or Accessory Attached screen when the connection is completed. When the iPod is connected to the vehicle, the iPod music library can only be operated by the vehicle audio controls.

* iPod and iPhone are a trademark of Apple Inc., registered in the U.S. and other countries.



WARNING:

Do not connect, disconnect or operate the USB device while driving. Doing so can be a distraction. If distracted you could lose control of your vehicle and cause an accident or serious injury.



CAUTION:

- **Do not force the USB device into the USB connection port. Inserting the USB device tilted or up-side-down into the port may damage the port. Make sure that the USB device is connected correctly into the USB connection port.**
- **Do not grab the USB connection port cover (if equipped) when pulling the USB device out of the port. This could damage the port and the cover.**
- **Do not leave the USB cable in a place where it can be pulled unintentionally. Pulling the cable may damage the port.**

Refer to your device manufacturer's owner information regarding the proper use and care of the device.

Compatibility:

The following models are compatible:

- Third generation iPhone (Firmware version IOS4/4.0)
- Fourth generation iPhone (Firmware version IOS4/4.0)
- Fifth generation iPod (Firmware version 1.3)

- First generation iPod Classic (Firmware version 1.1.1 or 1.1.2PC)
- Second generation iPod Classic (Firmware version 2.0.1)
- First generation iPod touch (Firmware version 1.1.5 or 2.2.1)
- Second and third generation iPod touch (Firmware version 2.2.1 or IOS4/4.0.0)
- First generation iPod nano (Firmware version 1.3.1)
- Second generation iPod nano (Firmware version 1.1.3)
- Third generation iPod nano (Firmware version 1.1.2PC or 1.1.3PC)
- Fourth generation iPod nano (Firmware version 1.0.2 or 1.0.4)
- Fifth generation iPod nano (Firmware version 1.0.1 or 1.0.2)

The iPod touch may not response quickly with the system in some cases.

Make sure that the iPod firmware is updated.

Audio main operation:

Place the ignition switch in the "ACC" or "ON" position. Then, push the iPod MENU button to switch to the iPod mode.

If the system has been turned off while the iPod was playing, pushing the VOL/Power button will start the iPod.

iPod MENU iPod MENU:

Place the ignition switch in the "ACC" or "ON" position. Then, push the iPod MENU button to switch to the iPod mode.

If another audio source is playing and the iPod is connected, pushing the iPod MENU button changes to the iPod mode.

If the system has been turned off while the iPod

was playing, pushing the VOL/Power button will start the iPod.

When the iPod MENU button is pushed while the iPod is connected, the interface for iPod operation is shown on the audio display. The items on the menu list can be scrolled by pushing the SEEK-TRACK (rewind) or SEEK-TRACK (fast forward) button while the iPod is operational. To select an item, push ENTER. Items in the iPod menu appear on the display in the following order.

- Now playing
- Playlists
- Artists
- Albums
- songs
- Podcasts
- Genres
- Composers
- Audiobooks
- Shuffle songs

For more information about each item, see the iPod Owner's Manual.

Previous/Next Track and Fast Rewind/Forward:

When the SEEK-TRACK (rewind) or SEEK-TRACK (fast forward) button is pushed for more than 1.5 seconds while the iPod is playing, the iPod will play while fast forwarding or rewinding. When the button is released, the iPod will return to the normal play speed.

When the SEEK-TRACK (rewind) or SEEK-TRACK (fast forward) button is pushed for less than 1.5 seconds while the iPod is playing, the next track or the beginning of the current track on the iPod will be played.

RPT REPEAT (RPT):

When the RPT button is pushed while a track is being played, the play pattern can be changed as follows:

Repeat Off → 1 Track Repeat → All Repeat → Repeat Off

RDM RANDOM (RDM):

When the RDM button is pushed while a track is being played, the play pattern can be changed as follows:

Shuffle Off → Track Shuffle → Albums Shuffle → Shuffle Off

BACK BACK:

The display will return to the previous screen.

Bluetooth® streaming audio operation

If you have a compatible Bluetooth® audio device that is capable of playing audio files, the device can be connected to the vehicle's audio system so that the audio files on the device play through the vehicle's speakers.

Connecting Bluetooth® audio:

To connect your Bluetooth® audio device to the vehicle, follow the procedure below:

1. Push the ENTER/SETTING button.

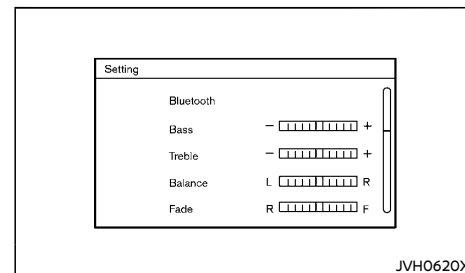

JVH0620X

2. Select the "Bluetooth" key.

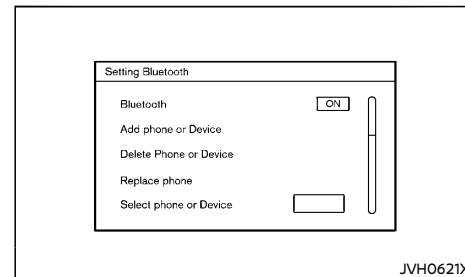

JVH0621X

3. Select the "Add Telephone" key. This same screen can be accessed to remove, replace or select a different Bluetooth® device.
4. The system acknowledges the command and asks you to initiate connecting from the Bluetooth® device. The connecting procedure of the Bluetooth® device varies according to each cellular phone model. See the Owner's manual of the Bluetooth® device for details.

Audio main operation:

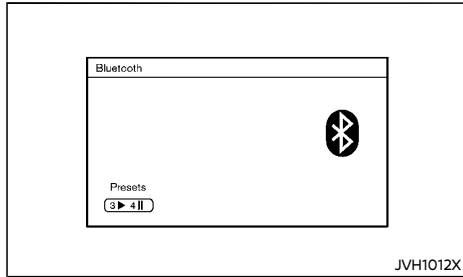

To switch to the Bluetooth® audio mode, push the USB-AUX button repeatedly until the Bluetooth® audio mode is displayed on the screen.

The controls for the Bluetooth® audio are displayed on the screen. Use the Preset 3 button to play and use the Preset 4 button to pause.

FM-AM RADIO WITH COMPACT DISC (CD) PLAYER (models with navigation system)

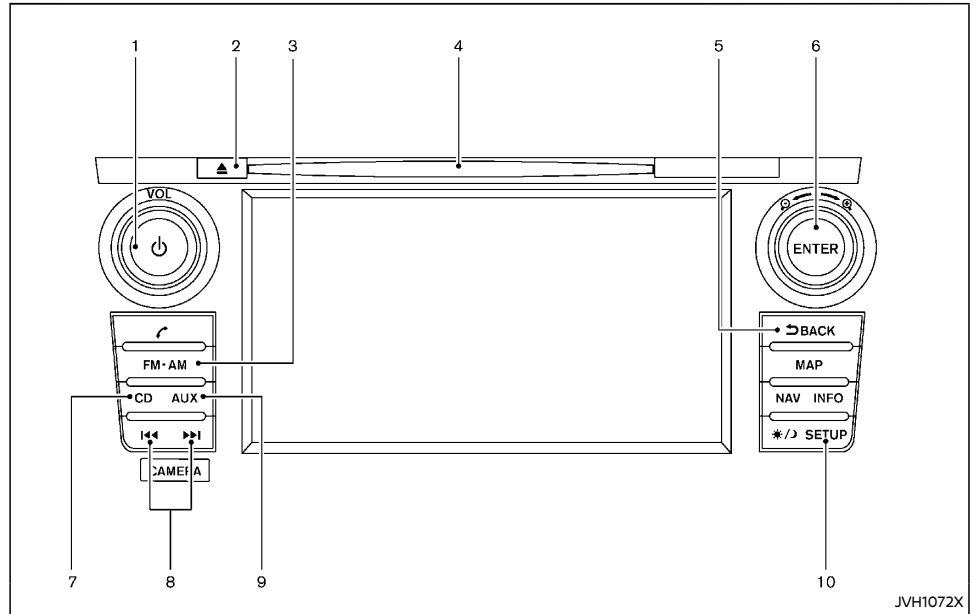

1. Power/VOL (volume) dial
2. Disc eject button
3. FM-AM button
4. Disc insert slot
5. BACK button
6. ENTER/Scroll dial
7. CD button
8. Seek/Track buttons
9. AUX (auxiliary) button
10. SETUP button

Audio main operation

The audio system operates when the ignition switch is placed in the "ON" or "ACC" position.

Power/VOL dial:

Push Power/VOL dial to turn on and off the audio system.

Turn the Power/VOL dial to adjust the volume.

This vehicle may be equipped with Speed Sensitive Volume (SSV) function for audio. When this function is turned on, the audio volume will be adjusted automatically as the vehicle speed changes. For operations to turn on and off the SSV function, see "Audio settings" (P.4-5).

Audio settings:

For the operations to adjust the audio settings, see "Audio settings" (P.4-5).

Radio operation

The audio system operates when the ignition switch is placed in the "ON" or "ACC" position.

Radio band select button:

Push the FM-AM button to change the band as follows:

AM → FM → AM

If another audio source is playing when the FM-AM button is pushed, the audio source playing will automatically be turned off and the last radio station played will begin playing.

Radio tuning:

When in radio mode, the radio can be tuned using the touch screen. To bring up the visual tuner, touch the "Tune" key on the lower part of the screen. A screen appears with a bar running from low frequencies on the left to high frequencies on the right.

One of the following operations can be used for tuning.

- Touching the bar on the screen
- Touching "◀"/"▶" on the screen
- Turning ENTER/Scroll dial

To return to the regular radio display screen, touch the "OK" key.

Station List:

When in FM mode, touch "FM List" to display the station list.



Seek/Track buttons:

When in radio mode, push the Seek/Track buttons to tune from low to high or high to low frequencies and to stop at the next broadcasting station.

Station memory keys:

Up to six stations can be stored for AM band, and up to twelve stations can be stored for FM band.

1. Choose the radio band using the FM-AM button.
2. Tune to the desired station using manual or seek tuning. Touch and hold any of the desired station memory keys until a beep sound is heard.

For FM, touch the "7-12" key to display the 7 - 12 memory keys.

3. The channel indicator will then come on and the sound will resume. Programming is now complete.

CD player operation

Loading disc:

Insert a CD into the slot with the label side facing up. The CD will be guided automatically into the slot and will start playing. If the radio is already playing, it will automatically turn off, and the CD will start playing.



CAUTION:

Do not force the compact disc into the slot. This could damage the player.





CD button:



When the CD button is pushed with the system off and the CD loaded, the system will turn on and the CD will start to play.

When the CD button is pushed with a CD loaded while the radio playing, the radio will turn off and the CD will start to play.



Seek/Track button:

When the  or  button is pushed for more than 1.5 seconds while the CD is being played, the CD will play while fast forwarding or rewinding. When the button is released, the CD will return to normal play speed.

When the  or  button is pushed for less than 1.5 seconds while the CD is being played, the next track or the beginning of the current track on the CD will be played. Push the button several times to skip through the tracks on the CD. If the last track on a CD is skipped, the first track on the disc will play. If the last track in a folder of an MP3 CD is skipped, the first track of the next folder will play.

CD/MP3/WMA display mode:

While listening to a CD or an MP3/WMA CD, certain text may be displayed (when a CD encoded with text is being used). Depending on how the CD or MP3/WMA CD is encoded, the text is displayed listing the artist, album and song title. Operation keys are also displayed on the screen.

Mix:

Touching the "Mix" key while an CD or MP3 CD is playing will alternate the random play pattern as follows:

(CD)

(Normal) → Mix → (Normal)

(CD with compressed audio files)

(Normal) → Random Folder → Random All → (Normal)

Repeat:

Touching the "Repeat" key while an CD or MP3 CD is playing will alternate the repeat play pattern as follows:

(CD)

(Normal) → Repeat → (Normal)

(CD with compressed audio files)

(Normal) → Repeat Track → Repeat Folder → (Normal)

Browse:

Touch the "Browse" key to display the titles on the CD in list format. Touch the title of a song in the list to begin playing that song. If an MP3 CD is playing, touching the "Browse" key will also list the folders on the disc. Touch the "Folder Up" key to view the lists in the upper layer. Follow the procedure for selecting a song with the touch screen to choose a folder.



Disc eject button:

When the Disc eject button is pushed while a CD is loaded, the CD will be ejected.

If the CD is not removed within 10 seconds, the CD will be reloaded.

USB (Universal Serial Bus) connection port

The audio system operates when the ignition switch is placed in the "ON" or "ACC" position.

The USB connection port is located on the center console. See "USB (Universal Serial Bus) connection port" (P.4-39). Connect a USB memory device into the connection port. The USB memory device will be activated automatically.

Refer to your device manufacturer's owner information regarding the proper use and care of the device.

USB main operation:

If another audio source is playing with a USB memory device inserted, push the AUX button until the screen on the display changes to the USB memory mode.

If the system has been turned off while the USB memory device was playing, push the Power/VOL dial to restart the USB memory device.

Touch the name of a song on the screen to begin playing that song.

USB screen operation:

While files on a USB memory device are playing, the play pattern can be altered so that songs are repeated or played randomly.

Mix:

Touching the "Mix" key on the screen while a USB memory device is playing will alternate the random play pattern as follows:

(Normal) → Random Folder → Random All → (Normal)

Repeat:

Touching the "Repeat" key on the screen while a USB memory device is playing will alternate the repeat play pattern as follows:

(Normal) → Repeat Track → Repeat Folder → (Normal)

Browse:

Touch "Browse" key to display USB interface. Select the songs you wish to play by touching the item on the screen.



Seek/Track buttons:

Push the Seek/Track (rewind) button while an audio file on the USB memory device is playing to return to the beginning of the current track. Push the button several times to skip backward several tracks.

Push the Seek/Track (fast forward) button while an audio file on the USB memory device is playing to advance one track. Push the button several times to skip forward several tracks. If the last track on the USB memory device is skipped, the first track of the next folder is played.

iPod player operation

Connecting iPod:

Connect the iPod to the USB connection port using the USB cable that came with your iPod.

The USB connection port is located on the center console. See "USB (Universal Serial Bus) connection port" (P.4-39).

If your iPod supports charging via a USB connection, its battery will be charged while connected to the vehicle with the ignition switch placed in the "ON" or "ACC" position.

Compatibility:

The following models are compatible:

- iPod 5th Generation (firmware version 1.2.3 or later)
- iPod Classic (firmware version 1.1.1 or later)
- iPod Touch (firmware version 2.0.0 or later)*
- iPod nano - 1st generation (firmware version 1.3.1 or later)
- iPod nano - 2nd generation (firmware version 1.1.3 or later)
- iPod nano - 3rd generation (firmware version 1.1.3 or later)
- iPod nano - 4th generation (firmware version 1.0.4 or later)
- iPod nano - 5th generation (firmware version 1.0.1 or later)

* Some features of this iPod may not be fully functional.

Make sure that your iPod firmware is updated to the version indicated above.

iPod main operation:

If the system has been turned off while the iPod was playing, pushing the Power/VOL dial will start the iPod.

If another audio source is playing with an iPod connected, push the AUX button until the screen on the display changes to the iPod mode.

Refer to your device manufacturer's owner information regarding the proper use and care of the device.

Interface operation:

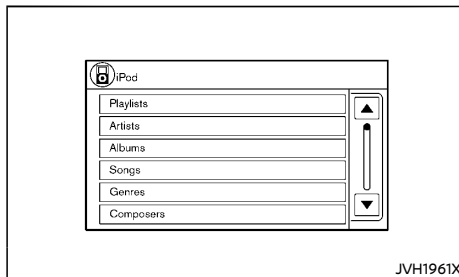

The interface for iPod operation shown on the vehicle's audio system display screen is similar to the iPod interface. Use the touch screen, BACK button or the ENTER/Scroll dial to navigate the menus on the screen.

When the iPod is playing, touch the "Menu" key to bring up the iPod interface.

Depending on the iPod model, the following items may be available on the menu list screen. For further information about each item, see the iPod Owner's Manual.

- Playlists

- Artists
- Albums
- Songs
- Genres
- Composers
- Audiobooks
- Podcasts
- Update Music Library

Scrolling menus:

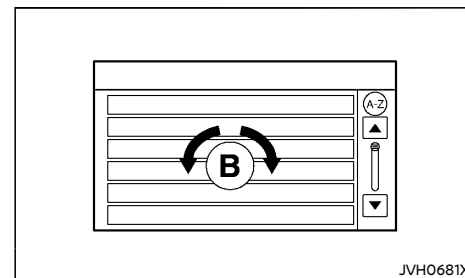

While navigating long lists of artists, albums or songs in the music menu, it is possible to scroll the list by the first character in the name. To activate character indexing, touch the "A-Z" key in the upper right corner of the screen. Turn the ENTER/Scroll dial to choose the number or letter to jump to in the list and then push the ENTER/Scroll dial.

If no character is selected after 30 seconds, the display returns to normal.

Random and repeat play mode:

While the iPod is playing, the play pattern can be altered so that songs are repeated or played randomly.

Mix:

Touching the "Mix" key on the screen while an iPod is playing will alternate the random play pattern as follows:

(Normal) → Mix Songs → (Normal)

Repeat:



Touching the "Repeat" key on the screen while an iPod is playing will alternate the repeat play pattern as follows:

(Normal) → Repeat Song → (Normal)



Seek/Track buttons:

When the  or  button is pushed for less than 1.5 seconds while the iPod is playing, the next track or the beginning of the current track will be played. Push the button several times to skip through the tracks.

Push and hold the  or  button for 1.5 seconds while a track is playing to reverse or fast forward the track being played. The track plays at an increased speed while reversing or fast forwarding. When the button is released, the track returns to normal play speed.

Bluetooth® audio player operation

If you have a compatible Bluetooth® audio device that is capable of playing audio files, the device can be connected to the vehicle's audio system so that the audio files on the device play through the vehicle's speakers.

Bluetooth® trademark:



Bluetooth® is a trademark owned by Bluetooth SIG, Inc. and licensed to Robert Bosch GmbH.

Connecting Bluetooth® audio:

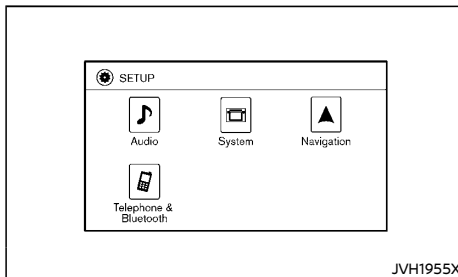

To connect your Bluetooth® audio device to the vehicle, follow the procedure below:

1. Push the SETUP button.
2. Select the "Telephone & Bluetooth" key.
3. Select the "Pair New Device" key.
4. The system acknowledges the command and asks you to initiate connecting from the phone handset. The connecting procedure of the cellular phone varies according to each cellular phone model. See the Bluetooth® device Owner's Manual for details.



Bluetooth® audio player main operation:

To switch to the Bluetooth® audio mode, push the AUX button repeatedly until the Bluetooth® audio mode is displayed on the screen.

The controls for the Bluetooth® audio are displayed on the screen.



Seek/Track buttons:

When the  or  button is pushed for less than 1.5 seconds while the Bluetooth® audio is playing, the next track or the beginning of the current track will be played. Push the button several times to skip through the tracks.

AUX device player operation

The AUX input jack is located on the center console. See "AUX (auxiliary) input jack (models with navigation system)" (P.4-40). The AUX audio input jack accepts any standard analog audio input such as from a portable cassette tape/CD player, MP3 player or laptop computer.

NISSAN strongly recommends using a stereo mini plug cable when connecting your music device to the audio system. Music may not play properly when a monaural cable is used.

AUX button:

To switch to the AUX mode, push the AUX button until the AUX mode is selected while the ignition switch is placed in the "ON" or "ACC" position.

USB (Universal Serial Bus) CONNECTION PORT



WARNING:

Do not connect, disconnect or operate the USB device while driving. Doing so can be a distraction. If distracted you could lose control of your vehicle and cause an accident or serious injury.



CAUTION:

- Do not force the USB device into the USB connection port. Inserting the USB device tilted or upside-down into the port may damage the port. Make sure that the USB device is connected correctly into the USB connection port.
- Do not grab the USB connection port cover (if equipped) when pulling the USB device out of the port. This could damage the port and the cover.
- Do not leave the USB cable in a place where it can be pulled unintentionally. Pulling the cable may damage the port.

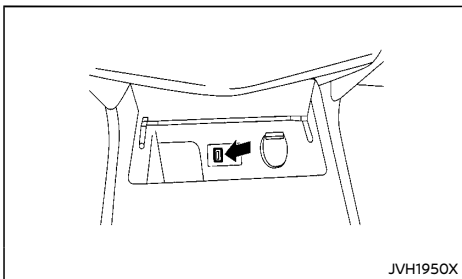

The USB connection port is located on the center console. Open the lid and connect a USB device or an iPod.

Refer to your device manufacturer's owner information regarding the proper use and care of the device.

AUX (auxiliary) INPUT JACK (models with navigation system)

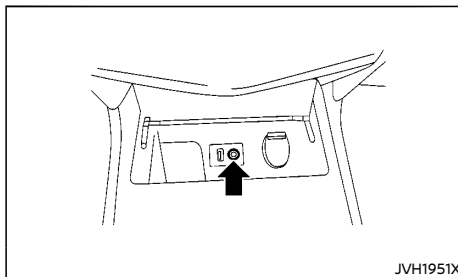

The AUX input jack is located on the center console. Open the lid and connect an audio device.

Compatible audio devices, such as some MP3 players, can be connected to the system through the AUX input jack.

Before connecting a device to a jack, turn off the power of the portable device.

With a compatible device connected to the jack, push the corresponding button repeatedly until the display switches to the AUX mode.

NISSAN strongly recommends using a stereo mini plug cable when connecting your music device to the audio system. Music may not play properly when a monaural cable is used.

CD/USB DEVICE CARE AND CLEANING

CD

- Handle a disc by its edges. Never touch the surface of the disc. Do not bend the disc.
- Always place the discs in the storage case when they are not being used.
- To clean a disc, wipe the surface from the center to the outer edge using a clean, soft cloth. Do not wipe the disc using a circular motion.

Do not use a conventional record cleaner or alcohol intended for industrial use.

- A new disc may be rough on the inner and outer edges. Remove the rough edges by rubbing the inner and outer edges with the side of a pen or pencil as illustrated.

USB device

- Do not touch the terminal portion of the USB device.
- Do not place heavy objects on the USB device.
- Do not store the USB device in highly humid locations.
- Do not expose the USB device to direct sunlight.
- Do not spill any liquids on the USB device.

Refer to the USB device Owner's Manual for the details.

STEERING-WHEEL-MOUNTED CONTROLS FOR AUDIO

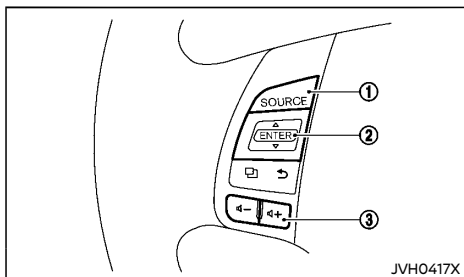

1. SOURCE select switch
2. Tuning switch
3. Volume control switches

SOURCE select switch

Push the SOURCE select switch to change the mode to available audio source.

Tuning switch (models without navigation system)

Push the switch upward or downward to select a channel, track, CD or folder when they are listed on the display.

RADIO:

- Pushing DOWN ▼ /UP ▲ shorter
Next or previous preset channel
- Pushing DOWN ▼ /UP ▲ longer
Next or previous station/channel

CD:

- Pushing DOWN ▼ /UP ▲ shorter
Next track or the beginning of the current track (the previous track if the button is pushed immediately after the current track starts playing)
- Pushing DOWN ▼ /UP ▲ longer
Forward or rewind

CD with MP3/WMA/AAC, iPod, USB device or Bluetooth® audio:

- Pushing DOWN ▼ /UP ▲ shorter
Next track or the beginning of the current track (the previous track if the button is pushed immediately after the current track starts playing)
- Pushing DOWN ▼ /UP ▲ longer
Folder change (When the last folder is changed, the next disc will be selected.)

Tuning switch (models with navigation system)

CD, iPod and USB device:



- Pushing DOWN ▼ /UP ▲ shorter
Next track or the beginning of the current track (the previous track if the button is pushed immediately after the current track starts playing)
- Pushing DOWN ▼ /UP ▲ longer
Forward or rewind

Bluetooth® audio:

- Pushing DOWN ▼ /UP ▲ shorter
Next track or the beginning of the current track (the previous track if the button is pushed immediately after the current track starts playing)

- Pushing DOWN ▼ /UP ▲ longer
Folder change (When the last folder is changed, the next disc will be selected.)

Volume control switches

Push the  + or  - button to increase or decrease the volume.

CAR PHONE AND CB RADIO

When installing a CB, ham radio or a car phone in your vehicle, be sure to observe the following cautions, otherwise the new equipment may adversely affect the Engine Control System and other electronic parts.

CAUTION:

- Keep the antenna as far away as possible from the Electronic Control Module.
- Keep the antenna wire at least 20 cm (8 in) away from the Engine Control harnesses. Do not route the antenna wire next to any harnesses.
- Adjust the antenna standing wave ratio as recommended by the manufacturer.
- Connect the ground wire from the radio chassis to the body.
- For details, consult a NISSAN dealer.

Bluetooth® HANDS-FREE PHONE SYSTEM (models without navigation system)

WARNING:

- Use a phone after stopping your vehicle in a safe location. If you have to use a phone while driving, exercise extreme caution at all times so full attention may be given to vehicle operation.
- If you find yourself unable to devote full attention to vehicle operation while talking on the phone, pull off the road to a safe location and stop your vehicle before doing so.

CAUTION:

To avoid draining the vehicle battery, use a phone after starting the engine.

NOTE:

Wireless LAN (Wi-Fi) and the Bluetooth® functions share the same frequency band (2.4 GHz). Using the Bluetooth® and the wireless LAN functions at the same time may slow down or disconnect communication and cause undesired noise. It is recommended that you turn off the wireless LAN (Wi-Fi) when using the Bluetooth® functions.

Your vehicle is equipped with Bluetooth® Hands-Free Phone System. If you are an owner of a Bluetooth® enabled cellular phone, you can set up the wireless connection between your cellular phone and the in-vehicle phone module. With Bluetooth® wireless technology, you can make or receive a telephone call with your cellular phone in your pocket.

Once your cellular phone is paired to the in-vehicle phone module, no phone connecting procedure is required. Your phone is automatically connected with the in-vehicle phone module when the ignition switch is placed in

the "ON" position with the registered cellular phone turned on and carried in the vehicle.

You can register up to 5 different Bluetooth® cellular phones in the in-vehicle phone module. However, you can talk on only one cellular phone at a time.

When a call is active, the audio system and microphone (located near the map light) are used for the handsfree communications.

If the audio system is being used at the time, the audio mode will mute and will stay muted until the active call is ended.

Before using the Bluetooth® Hands-Free Phone System, refer to the following notes.

- Set up the wireless connection between a cellular phone and the in-vehicle phone module before using the Bluetooth® Hands-Free Phone System.
- Some Bluetooth® enabled cellular phones may not be recognized by the in-vehicle phone module.
- You will not be able to use a hands-free phone under the following conditions:
 - Your vehicle is outside of the telephone service area.
 - Your vehicle is in an area where it is difficult to receive radio waves; such as in a tunnel, in an underground parking garage, behind a tall building or in a mountainous area.
 - Your cellular phone is locked in order not to be dialed.
- When the radio wave condition is not ideal or ambient sound is too loud, it may be difficult to hear the other person's voice during a call.
- Immediately after the ignition switch is placed in the "ON" position, it may be impossible to receive a call for a short

period of time.

- Do not place the cellular phone in an area surrounded by metal or far away from the in-vehicle phone module to prevent tone quality degradation and wireless connection disruption.
- While a cellular phone is connected through the Bluetooth® wireless connection, the battery power of the cellular phone may discharge quicker than usual.
- If the Bluetooth® Hands-Free Phone System seems to be malfunctioning, please contact a NISSAN dealer.
- Some cellular phones or other devices may cause interference or a buzzing noise to come from the audio system speakers. Storing the device in a different location may reduce or eliminate the noise.
- Refer to the cellular phone Owner's Manual regarding the telephone pairing procedure specific to your phone, battery charging, cellular phone antenna, etc.
- The antenna display on the monitor will not coincide with the antenna display of some cellular phones.
- Keep the interior of the vehicle as quiet as possible to hear the caller's voice clearly as well as to minimize its echoes.
- If reception between callers is unclear, adjusting the incoming or outgoing call volume may improve the clarity.
- This wireless hands free car kit is based on Bluetooth® technology,
 - Frequency: 2402 MHz - 2480 MHz
 - Output Power: 4.14 dBm E.I.R.P
 - Modulation: FHSS GFSK 8DPSK, π/4DQPSK

- Number of Channel: 79
- This wireless equipment can't be used for any services related to safety because there is the possibility of radio interference.

REGULATORY INFORMATION

Bluetooth® trademark



Bluetooth® is a trademark owned by Bluetooth SIG, Inc. and licensed to Visteon Corporation.

CE statement



Hereby "Yangfeng Visteon Automotive Electronics Co., Ltd." declares that this Bluetooth car kit AV System is in compliance with the essential requirements and other relevant provisions of Directive 1999/5/EC.

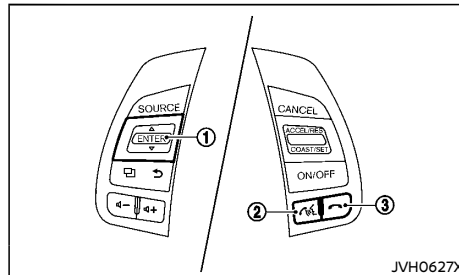

USING THE SYSTEM

Control buttons:



1. ▲ / ▼ button
2. Phone send  button
3. Phone end  button

Microphone:

Microphone is located near the map light.

The NISSAN Voice Recognition system allows hands-free operation of the Bluetooth® Hands-Free Phone System. If the vehicle is in motion, some commands may not be available so full attention may be given to vehicle operation.

Setup

Choosing a language:



You can interact with the Bluetooth® Hands-Free Phone System using English, Chinese or Korean. To change the language, perform the following. See "Audio main operation" (P.4-30).

Connecting procedure:

You can register up to 5 different Bluetooth® cellular phones in the in-vehicle phone module. However, you can talk on only one cellular phone at a time.









To connect a phone to the Bluetooth® hands-free phone system. See "Bluetooth® streaming audio operation" (P.4-34).

Selecting a registered phone:

1. Push the phone send  button and ▲ / ▼ button to select "Bluetooth", and then push the phone send  button.
2. Push the ▲ / ▼ button to select "Select Phone", and then push the phone send  button.
3. Push the ▲ / ▼ button. Each time the button is operated, the system announces the names of the phones. Select the phone you wish to use.

4. Push the phone send  button to complete the selection.

Deleting a registered phone:

1. Push the phone send  button and  button to select "Bluetooth", and then push the phone send  button.
2. Push the  button to select "Delete Phone", and then push the phone send  button.
3. Push the  button. Each time the button is operated, the system announces the name of the phones. Select the phone you wish to delete.
4. When the system asks if you want to delete, push the phone send  button. To cancel the deletion, push the phone end  button.
5. The system asks you to confirm the deletion. To delete the desired phone, push the phone send  button again.

NOTE:

When you delete a phone, the associated phonebook for the phone will also be deleted.

Bluetooth® on/off:

1. Push the ENTER/SETTING button.
2. Use the TUNE-FOLDER knob to select "Bluetooth" and then push the ENTER/SETTING button.
3. Select "On" or "Off" to turn the vehicle's Bluetooth® system on or off.

When Bluetooth® is off, you will not be able to make or receive calls by the hands-free mode. Also, you will not have access to the phonebook.

Phone menu

Push the  button to bring up the phone menu. The available options are:

- Call
- Phonebook
- Record Name (if equipped)
- Recent Calls
- Select Phone

Call:

The following items are available under "Call".

- List Names
Select this item to have the system list the names in the phonebook one by one in alphabetical order. Select "Dial" to dial the number of the currently selected name. Push the  button on the steering wheel to move through the list and select the person you wish to call.
- Redial
Select this item to call the last number dialed.
- Call Back
Select this item to call the number of the last incoming call to the vehicle.

Phonebook:

The following items are available under "Phonebook".

NOTE:

Each phone has its own separate phonebook. You cannot access Phone A's phonebook if you are currently connected with Phone B.

- List Names
Select this item to have the system list the names in the phonebook one by one in alphabetical order. Select "Dial" to dial the number of the currently selected name.

Push the  button on the steering wheel to move through the list and select the person you wish to call.

- Delete Entry

Select this item to delete an entry in the phonebook. Choose an entry to delete.

Record Name (if equipped):

The system allows you to record custom voice tags for contact names in the phonebook. Up to 40 voice tags can be recorded to the system.

Recent Calls:

The following items are available under "Recent Calls":

- Incoming Calls
Select this item to list the last five incoming calls to the vehicle. If the call is from an entry in the phonebook, the name will be displayed. Otherwise, the phone number of the incoming call will be displayed.
Select "Dial" to call the number. Select "Next Entry" or "Previous Entry" to move through the list of incoming calls.
- Missed Calls
Select this item to list the last five missed calls to the vehicle. If the call is from an entry in the phonebook, the name will be displayed. Otherwise, the phone number of the missed call will be displayed. Select "Dial" to call the number. Select "Next Entry" or "Previous Entry" to move through the list of missed calls.
- Outgoing Calls
Select this item to list the last five outgoing calls from the vehicle. If the call was to an entry in the phonebook, the name will be displayed. Otherwise, the phone number of the outgoing call will be displayed. Select "Dial" to call the number. Select "Next Entry"

or "Previous Entry" to move through the list of outgoing calls.

- **Redial**
Select this item to call the last number dialed.
- **Call Back**
Select this item to call the number of the last incoming call to the vehicle.

Select Phone:

Select this item to select a phone to use from a list of those phones connected to the vehicle.

Downloading phonebook automatically (if equipped)

The availability of this function depends on each cellular phone. The copying procedure also varies according to each cellular phone. See cellular phone Owner's Manual for more information.

When the cellular phone is connected to the in-vehicle module, the data stored in the cellular phone such as phonebook, outgoing call logs, incoming call logs and missed call logs is automatically transferred and registered to the system.

Up to 1,000 phone numbers per registered cellular phone can be stored in the phonebook.

Downloading phonebook manually (one contact transfer) (if equipped)

The availability of this function depends on each cellular phone. The copying procedure also varies according to each cellular phone. See cellular phone Owner's Manual for more information.





The phonebook stores up to 40 names for each phone paired with the system.

NOTE:



Each phone has its own separate phonebook. You cannot access Phone A's phonebook if you are currently connected with Phone B.

New entry:

This function is not available while driving.





1. Push the phone send  button and  button to select "PHONEBOOK", and then push the phone send  button.
2. Push the  button to select "Transfer Entry", and then push the phone send  button.
3. The Phonebook is transferred automatically to the system.

The memory sending procedure from the Bluetooth® cellular phone varies according to each cellular phone manufacturer. See the cellular phone Owner's Manual for more details.







4. When prompted by the system, say the name that you would like to give for the new entry.
Speak in a natural voice without pausing between words.
5. When the system requires you to repeat the name, say the name again.
6. Push the phone send  button to continue the entry, or push the phone end  button to finish the phone mode.

Delete:

This function is not available while driving.







1. Push the phone send  button and  button to select "PHONEBOOK", and then push the phone send  button.
2. Push the  button to select "Delete Entry", and then push the phone send  button.

button.







3. Push the  button and choose the phonebook entry you wish to delete.
4. When the system asks if you want to delete the contact, push the phone send  button. To cancel the deletion, push the phone end  button.
5. The system asks you to confirm the deletion.
6. To delete the desired contact, push the phone send  button again.
7. Push the phone send  button to continue the deletion or push the phone end  button to finish the phone mode.

Making a call

Phonebook:

1. Push the phone send  button and  button to select "Call", and then push the phone send  button.
2. Push the  button to select "List Names", and then push the phone send  button.
3. Push the  button, and choose the phonebook entry you wish to call. The system acknowledges the name and begins the call.

Redial:

1. Push the phone send  button and  button to select "Call", and then push the phone send  button.
2. Push the  button to select "Redial", and then push the phone send  button.
3. Push the phone send  button, and then the system begins the call.

Bluetooth® cellular phone keypad:

You can also make a call by operating the cellular phone that is registered to the in-vehicle phone module to use the hands-free phone system.

Receiving or rejecting a call



When you hear the ring tone, push the phone send  button on the steering wheel.

If you do not wish to answer the call when you hear the ring tone, push the phone end  button.

During a call



During a call, push the phone send  button to access additional options. Select one of the following items:

- "Mute On" / "Mute Off"
Select the item to mute or unmute the system.
- "Transfer Call"
Select this item to switch the call from the Bluetooth® Hands-Free Phone System to the cellular phone when privacy is desired. Once the ignition switch is placed in the "OFF" position and the "ON" position again, the system will automatically change to the hands-free mode as a default setting.

If supported by the phone, the Bluetooth® Hands-Free Phone System allows for call waiting functionality. If a call is received while another call is already active, a message will be displayed on the screen. Push the phone send  button to hold the active call and switch to the second call. Push the  button to reject the second call.

While the second call is active, pushing the phone send  button will allow the same items that are available during any call as well

as two additional items:

- "Switch Call"
Select this item to hold the second call and switch back to the original call.
 - "End Other Call"
Select this item to stay with the second call and end the original call.
- Push the phone send  button to accept the call. Push the  button to reject the call.

Ending a call

Push the phone end  button on the steering wheel or the off button on the cellular phone.

Bluetooth® SETTINGS

To access and adjust the settings for the Bluetooth® Hands-Free Phone System;

1. Push the ENTER/SETTING button on the audio unit.
2. Use the TUNE-FOLDER dial on the audio unit to select "Bluetooth" and then push the ENTER/SETTING button on the audio unit.

Available setting items:

- Bluetooth
Select to turn the vehicle's Bluetooth® system on or off.
- Add Telephone
For operation to connect a phone to the system, see "Bluetooth® streaming audio operation" (P.4-34).
- Delete Phone
Select to delete a phone from the displayed list. The system will ask to confirm before deleting the phone.

NOTE:

When you delete a phone, the associated phonebook for the phone will also be deleted.

- Replace Phone
Select to replace a phone from the displayed list. When a selection is made, the system will ask to confirm before proceeding. The recorded phonebook for the phone being deleted will be saved as long as the new phone's phonebook is the same as the old phone's phonebook.
- Select Phone
Select to connect to a previously connected phone from the displayed list.
- Phonebook Download (if equipped)
Select to turn on or off the automatic download of a connected phone's phonebook.
- Show Incoming Calls
Select "Driver Only" to have incoming call information displayed only in the vehicle information display. Select "Both" to have incoming call information displayed in both the vehicle information display and the center display screen.

Bluetooth® HANDS-FREE PHONE SYSTEM (models with navigation system)



WARNING:

- Use a phone after stopping your vehicle in a safe location. If you have to use a phone while driving, exercise extreme caution at all times so full attention may be given to vehicle operation.
- If you are unable to devote full attention to vehicle operation while talking on the phone, pull off the road to a safe location and stop your vehicle.



CAUTION:

To avoid discharging the vehicle battery, use a phone after starting the engine.

Your vehicle is equipped with the Bluetooth® Hands-Free Phone System. If you have a compatible Bluetooth® enabled cellular phone, you can set up the wireless connection between your cellular phone and the in-vehicle phone module. With Bluetooth® wireless technology, you can make or receive a hands-free telephone call with your cellular phone in the vehicle.

Once your cellular phone is connected to the in-vehicle phone module, no other phone connecting procedure is required. Your phone is automatically reconnected with the in-vehicle phone module when the ignition switch is placed in the ON position with the connected cellular phone turned on and carried in the vehicle.

You can register up to 5 different Bluetooth® cellular phones to the in-vehicle phone module. However, you can talk on only one cellular phone at a time.

Before using the Bluetooth® Hands-Free Phone System, refer to the following notes.

- Set up the wireless connection between a cellular phone and the in-vehicle phone module before using the Bluetooth® Hands-Free Phone System.
- Some Bluetooth® enabled cellular phones may not be recognized by the in-vehicle phone module.
- You will not be able to use a hands-free phone under the following conditions:
 - Your vehicle is outside of the cellular service area.
 - Your vehicle is in an area where it is difficult to receive cellular signal; such as in a tunnel, in an underground parking garage, near a tall building or in a mountainous area.
 - Your cellular phone is locked to prevent it from being dialed.
- When the radio wave condition is not ideal or ambient sound is too loud, it may be difficult to hear the other person's voice during a call.
- Immediately after the ignition switch is placed in the ON position, it may be impossible to receive a call for a short period of time.
- Do not place the cellular phone in an area surrounded by metal or far away from the in-vehicle phone module to prevent tone quality degradation and wireless connection disruption.
- While a cellular phone is connected through the Bluetooth® wireless connection, the battery power of the cellular phone may discharge quicker than usual. The Bluetooth® Hands-Free Phone System cannot charge cellular phones.
- Some cellular phones or other devices may cause interference or a buzzing noise to come from the audio system speakers.

Storing the device in a different location may reduce or eliminate the noise.

- Refer to the cellular phone owner's manual regarding the telephone charges, cellular phone antenna and body, etc.
- The signal strength display on the monitor will not coincide with the signal strength display of some cellular phones.

REGULATORY INFORMATION

Bluetooth® Trademark



Bluetooth® is a trademark owned by Bluetooth SIG, Inc. and licensed to Robert Bosch GmbH.

CONTROL BUTTONS AND MICROPHONE

Steering wheel:

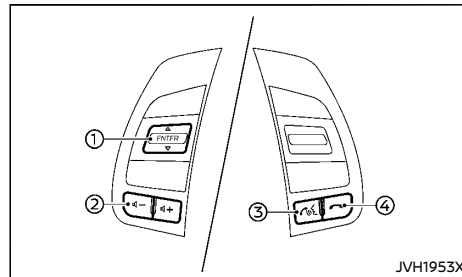

1. Tuning switch
2. Volume control - / + switch
3. Phone send button
4. Phone end button

Control panel:

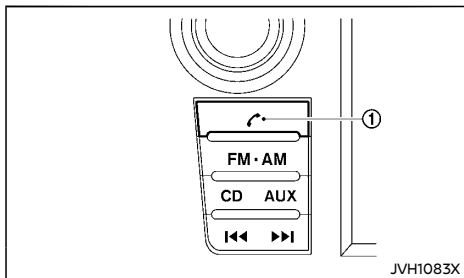

1. Phone  button

Microphone:

Microphone is located near the map lights.

PAIRING PROCEDURE

NOTE:

The connecting procedure must be performed when the vehicle is stationary. If the vehicle starts moving during the procedure, the procedure will be cancelled.

1. Push the SETUP button on the control panel.
2. Select the "Telephone & Bluetooth" key.
3. Select the "Pair New Device" key.
4. The system acknowledges the command and asks you to initiate connecting from the phone handset. The connecting procedure of the cellular phone varies according to each cellular phone model. See the Bluetooth® device Owner's Manual for details.

For more information, see the Bluetooth® device's Owner's Manual.

PHONEBOOK

To access the vehicle phonebook:



1. Push the  button on the control panel.
2. Select the "Contacts" key.
3. Choose the desired entry from the displayed list.
4. The number of the entry will be displayed on the screen. Touch the number to initiate dialing.

NOTE:

To scroll quickly through the list, touch the "A-Z" key in the upper right corner of the screen. Turn the ENTER/Scroll dial to choose a letter or number and then push the ENTER/Scroll dial. The list will move to the first entry that begins with that number or letter.

MAKING A CALL



To make a call, follow the procedure below:

1. Push the  on the control panel. The "Phone" screen will appear on the display.
2. Select one of the following options to make a call:
 - "Contacts": Select the name from an entry stored in the vehicle phonebook.
 - "Call Lists": Select the name from the incoming, outgoing or missed.
 - "Redial": Dial the last outgoing call from the vehicle.
 - : Input the phone number manually using a keypad displayed on the screen. For information on how to use the touch screen, see "Touch screen operation" (P.4-4).



RECEIVING A CALL

When a call is placed to the connected phone, the display will change to phone mode.

To accept the incoming call, take one of the following actions.

- Push the  button on the steering wheel.
- Touch the "  " icon on the screen.

To reject the incoming call, take one of the following actions.



- Push the  button on the steering wheel.
- Touch the red phone "  " icon on the screen.

DURING A CALL

While a call is active, the following options are available on the screen:

- "Handset"
Select this option to switch control of the phone call over to the handset.
- "Mute Mic."
Select this option to mute the microphone. Select again to unmute the microphone.
- "  " icon
Select to end the phone call.

ENDING A CALL

To end a phone call, select the "  " icon on the screen or push the  button on the steering wheel.

Bluetooth® SETTINGS

To access the Bluetooth® settings screen:

1. Push the SETUP button.
2. Touch the "Telephone & Bluetooth" key.

Available setting items:

- **Telephone Setup**
See "Telephone setup" (P.4-49) for details.
- **Pair New Device**
Select to pair a new Bluetooth® device to the Bluetooth® Hands-Free Phone System.
- **Select Paired Device**
Select to choose a Bluetooth® device from a list of those devices paired to the Bluetooth® Hands-Free Phone System.
- **Delete Paired Device**
Select to delete a Bluetooth® device from a list of those devices connected/paired to the Bluetooth® Hands-Free Phone System.
- **Bluetooth**
Select to toggle Bluetooth® on and off.

TELEPHONE SETUP

To access the phone settings screen:

1. Push the SETUP button.
2. Touch the "Telephone & Bluetooth" key.
3. Touch the "Telephone Setup" key.

Available setting items:

- **Sort Phonebook By:**
Select "First Name" or "Last Name" to choose how phonebook entries are alphabetically displayed on the screen.
- **Phonebook (if equipped):**
Select "Phone" to use the handset's phonebook. Select "SIM" to use the phonebook on the SIM card. Select "Both" to use both sources.

- **Download Phonebook Now:**
Select to download the phonebook to the vehicle from the chosen source.
- **Phone Notifications for:**
Select "Driver" to have phone notifications shown in the vehicle information display. Select "Both" to have phone notifications shown in both the vehicle information display and the center display screen.

MEMO

5 Starting and driving

Break-in schedule	5-2	BSW/LDW automatic deactivation	5-16
Before starting engine	5-2	BSW/LDW malfunction	5-16
Precautions when starting and driving	5-2	Camera unit maintenance	5-16
Exhaust gas (carbon monoxide)	5-3	Cruise control	5-16
Three-way catalyst	5-3	Precautions on cruise control	5-17
Care when driving	5-4	Cruise control operations	5-17
Engine cold start period	5-4	Fuel Efficiency and Carbon Dioxide Reduction	
Loading luggage	5-4	driving tips	5-18
Driving in wet conditions	5-4	Increasing fuel economy and reducing Carbon	
Driving in winter conditions	5-4	Dioxide emissions	5-18
Push-button ignition switch	5-4	ECO mode system	5-19
Precautions on push-button ignition		ECO Pedal Guide function	5-19
switch operation	5-4	Ambient ECO	5-19
Intelligent Key system	5-4	Parking	5-20
Ignition switch positions	5-5	Parking sensor system (if equipped)	5-21
Continuously Variable Transmission (CVT)	5-5	Parking sensor system OFF switch	5-22
Steering lock	5-6	Parking sensor system setting	5-22
Intelligent Key battery discharge	5-6	Trailer towing	5-22
Starting engine	5-7	Hydraulic pump electric power steering	5-23
Remote engine start (if equipped)	5-7	Brake system	5-23
Driving vehicle	5-7	Brake precautions	5-23
Driving with Continuously Variable		Anti-lock Braking System (ABS)	5-24
Transmission (CVT)	5-7	Vehicle security	5-25
Vehicle Dynamic Control (VDC) system	5-10	Cold weather driving	5-25
Vehicle Dynamic Control (VDC) OFF switch	5-11	Battery	5-25
Blind Spot Warning (BSW)/Lane Departure Warning		Engine coolant	5-25
(LDW) systems (if equipped)	5-12	Tire equipment	5-25
BSW system operation	5-12	Special winter equipment	5-26
BSW driving situations	5-14	Parking brake	5-26
LDW system operation	5-14	Corrosion protection	5-26
BSW/LDW temporary disabled status	5-16		

BREAK-IN SCHEDULE

During the first 1,600 km (1,000 miles), follow these recommendations to obtain maximum engine performance and ensure the future reliability and economy of your new vehicle. Failure to follow these recommendations may result in shortened engine life and reduced engine performance.

- Do not drive at a constant speed, either fast or slow, for long periods of time.
- Do not run the engine over 4,000 rpm.
- Do not accelerate at full throttle in any gear.
- Do not start quickly.
- Do not brake hard as much as possible.

BEFORE STARTING ENGINE



WARNING:

The driving characteristics of your vehicle will change remarkably by any additional load and its distribution, as well as by adding optional equipment (roof racks, etc.). Your driving style and speed must be adjusted according to the circumstances. Especially when carrying heavy loads, your speed must be reduced adequately.

- Make sure the area around the vehicle is clear.
- Visually inspect tires for their appearance and condition. Measure and check the tire pressure for proper inflation.
- Check that all windows and lights are clean.
- Adjust the seat and head restraint positions.
- Adjust the inside and outside rearview mirror positions.
- Fasten your seat belt and ask all passengers to do the same.
- Check that all doors are closed.
- Check the operation of the warning lights when the ignition switch is placed in the "ON" position.
- Maintenance items in the "8. Maintenance and do-it-yourself" section should be checked periodically.

PRECAUTIONS WHEN STARTING AND DRIVING



WARNING:

- Never leave children or adults who would normally require the support of others alone in your vehicle. Pets should not be left alone either. They could unknowingly activate switches or controls and inadvertently become involved in a serious accident and injure themselves. On hot, sunny days, temperatures in a closed vehicle could quickly become high enough to cause severe or possibly fatal illness to people or animals.
- Closely supervise children when they are around your vehicle to prevent them from playing and becoming locked in the trunk where they could be seriously injured. Keep the vehicle locked with the trunk lid closed when not in use, and prevent children's access to vehicle keys.

NOTE:

During the first few months after purchasing a new vehicle, if you smell strong odors of Volatile Organic Compounds (VOCs) inside the vehicle, ventilate the passenger compartment thoroughly. Open all the windows before entering or while in the vehicle. In addition, when the temperature in the passenger compartment rises, or when the vehicle is parked in direct sunlight for a period of time, turn off the air recirculation mode of the air conditioner and/or open the windows to allow sufficient fresh air into the passenger compartment.

EXHAUST GAS (carbon monoxide)



WARNING:

- Do not breathe exhaust gas; it contains colorless and odorless carbon monoxide. Carbon monoxide is dangerous. It can cause unconsciousness or death.
- If you suspect that exhaust fumes are entering the vehicle, drive with all windows fully open, and have the vehicle inspected immediately.
- Do not run the engine in closed spaces such as a garage.
- Do not park the vehicle with the engine running for an extended period of time.
- Keep the trunk lid closed while driving, otherwise exhaust gas could be drawn into the passenger compartment. If you must drive with the trunk lid open, follow these precautions:
 - Open all the windows.
 - Turn the air recirculation mode off and set the fan speed control to the highest level to circulate the air.
- The exhaust system and body should be inspected by a qualified mechanic whenever:
 - Your vehicle is raised while being serviced.
 - You suspect that exhaust fumes are entering into the passenger compartment.
 - You notice a change in the sound of the exhaust system.

- You have had an accident involving damage to the exhaust system, underbody, or rear of the vehicle.

THREE-WAY CATALYST



WARNING:

- The exhaust gas and the exhaust system are very hot. Keep people, animals and flammable materials away from the exhaust system components.
- Do not stop or park the vehicle over flammable materials such as dry grass, wastepaper or rags. They may ignite and cause a fire.

The three-way catalyst is an emission control device installed in the exhaust system. Exhaust gas in the three-way catalyst is burned at high temperatures to help reduce pollutants.



CAUTION:

- Do not use leaded gasoline. (See "Recommended fluids/lubricants and capacities" (P.9-2).) Deposits from leaded gasoline seriously reduce the ability of the three-way catalyst to help reduce exhaust pollutants and/or damage the three-way catalyst.
- Keep your engine tuned up. Malfunctions in the ignition, fuel injection, or electrical systems may cause overrich fuel to flow into the three-way catalyst, causing it to overheat. Do not keep driving if the engine misfires, or if noticeable loss of performance or other unusual operating conditions are detected. Have the vehicle inspected promptly by a NISSAN dealer.

- Avoid driving with an extremely low fuel level. Running out of fuel could cause the engine to misfire, damaging the three-way catalyst.
- Do not race the engine while warming it up.
- Do not push or tow your vehicle to start the engine.

CARE WHEN DRIVING

Driving your vehicle to fit the circumstances is essential for your safety and comfort. As a driver, you should be the one who knows best how to drive in the given circumstances.

ENGINE COLD START PERIOD

Due to the higher engine speeds, when the engine is cold, extra caution must be exercised when selecting a gear during the engine warm-up period after starting the engine.

LOADING LUGGAGE

Loads and their distribution and the attachment of equipment (coupling devices, roof luggage carriers, etc.) will considerably change the driving characteristics of the vehicle. Your driving style and speed must be adjusted according to the circumstances.

DRIVING IN WET CONDITIONS

- Avoid accelerating or stopping suddenly.
- Avoid sharp turning or lane changing suddenly.
- Avoid following too close to the vehicle in front.

When water covers the road surface with water puddles, small water streams, etc., reduce speed to prevent hydroplaning which can cause skidding and loss of control. Worn tires will increase this risk.

DRIVING IN WINTER CONDITIONS

- Drive cautiously.
- Avoid accelerating or stopping suddenly.
- Avoid sharp turning or lane changing suddenly.
- Avoid sudden steering.
- Avoid following too close to the vehicle in front.

PUSH-BUTTON IGNITION SWITCH

PRECAUTIONS ON PUSH-BUTTON IGNITION SWITCH OPERATION

Do not operate the push-button ignition switch while driving the vehicle except in an emergency. (The engine will stop when the ignition switch is pushed 3 consecutive times or the ignition switch is pushed and held for more than 2 seconds.) The steering wheel may lock and could cause the driver to lose control of the vehicle. This could result in serious vehicle damage or personal injury.

Before operating the push-button ignition switch, be sure to move the shift lever to the "P" (Park) position.

INTELLIGENT KEY SYSTEM

The Intelligent Key system can operate the ignition switch without taking the key out from your pocket or purse. The operating environment and/or conditions may affect the Intelligent Key system operation.



CAUTION:

- **Be sure to carry the Intelligent Key with you when operating the vehicle.**
- **Never leave the Intelligent Key inside the vehicle when you leave the vehicle.**
- **If the vehicle battery is discharged, the ignition switch cannot be switched from the "LOCK" position and if the steering lock is engaged, the steering wheel cannot be moved. Charge the battery as soon as possible. (See "Jump starting" (P.6-5).)**

Operating range

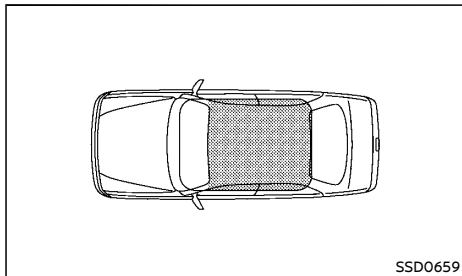

The Intelligent Key functions can only be used for starting the engine when the Intelligent Key is within the specified operating range as illustrated.

When the Intelligent Key battery is almost discharged or strong radio waves are present near the operating location, the Intelligent Key system's operating range becomes narrower and may not function properly.

If the Intelligent Key is within the operating range, it is possible for anyone, even someone who does not carry the Intelligent Key, to push the ignition switch to start the engine.

- The trunk area is not included in the operating range, but the Intelligent Key may function.
- If the Intelligent Key is placed on the instrument panel, rear parcel shelf, inside the glove box or door pocket, the Intelligent Key may not function.
- If the Intelligent Key is placed near the door or window outside the vehicle, the Intelligent Key may function.

IGNITION SWITCH POSITIONS

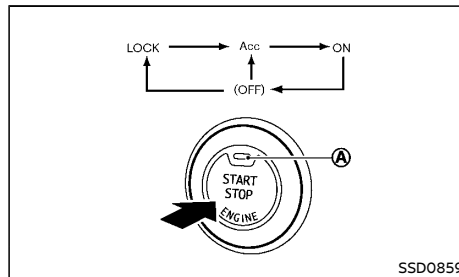

When the ignition switch is pushed without depressing the brake pedal, the ignition switch position will change as follows:

- Push once to change to "ACC".
- Push two times to change to "ON".
- Push three times to change to "OFF". (No position illuminates.)
- Push four times to return to "ACC".
- Open or close any door to return to "LOCK" from the "OFF" position.

The indicator light (A) on the ignition switch illuminates when the ignition switch is in the "ACC" or "ON" position.

"LOCK" position

The ignition switch and steering lock can only be locked at this position.

The ignition switch will be unlocked when it is pushed to the "ACC" position while carrying the Intelligent Key.

"ACC" position

The electrical accessory power activates at this position without the engine turned on.

"ON" position

The ignition system and the electrical accessory power activate at this position without the engine turned on.

"OFF" position

The engine is turned off with the steering wheel unlocked.



WARNING:

Never push the ignition switch to the "OFF" position while driving. The steering wheel may lock and cause the driver to lose control of the vehicle, resulting in serious vehicle damage or personal injury.



CAUTION:

Do not leave the vehicle for extended periods of time when the ignition switch is in the "ACC" or "ON" position and the engine is not running. This can discharge the battery.

To start the engine, see "Starting engine" (P.5-7).

CONTINUOUSLY VARIABLE TRANSMISSION (CVT)

The ignition lock is designed so that the ignition switch cannot be switched to the "LOCK" position until the shift lever is moved to the "P" (Park) position.

When the ignition switch cannot be switched to the "LOCK" position:

1. "Shift to Park" warning appears on the vehicle information display and a chime sounds.
2. Move the shift lever to the "P" (Park) position.
3. If the ignition switch is in the "ACC" position, "Push ignition to OFF" warning appears on the vehicle information display.
4. Push the ignition switch. The ignition switch is switched to the "ON" position.
5. "Push ignition to OFF" warning appears again on the vehicle information display.
6. Push the ignition switch. The ignition switch is switched to the "OFF" position.
7. Open the door. The ignition switch turns to the "LOCK" position.

For warnings and indicators on the vehicle information display, see "Vehicle information display" (P.2-11).

If the ignition switch is switched to the "LOCK" position, the shift lever cannot be moved from the "P" (Park) position. The shift lever can be moved if the ignition switch is in the "ON" position with the foot brake pedal depressed.

STEERING LOCK

The ignition switch is equipped with an anti-theft steering lock device.

To lock steering wheel

1. Push the ignition switch to the "OFF" position where the ignition switch position indicator will not illuminate.
2. Open or close the door. The ignition switch turns to the "LOCK" position.
3. Turn the steering wheel 1/8 of a turn to the right or left from the straight up position.

To unlock steering wheel

Push the ignition switch, and the steering wheel will be automatically unlocked.



CAUTION:

- **If the battery of the vehicle is discharged, the push-button ignition switch cannot be switched from the "LOCK" position.**
- **If the steering lock release malfunction indicator appears on the vehicle information display, push the ignition switch again while rotating the steering wheel slightly to the right and left. (See "Vehicle information display" (P.2-11).)**

INTELLIGENT KEY BATTERY DISCHARGE

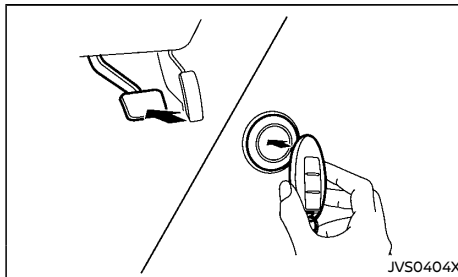

If the battery of the Intelligent Key is discharged, or environmental conditions interfere with the Intelligent Key operation, start the engine according to the following procedure:

1. Move the shift lever to the "P" (Park) position.
2. Firmly apply the foot brake.

3. Touch the ignition switch with the Intelligent Key as illustrated. (A chime will sound.)
4. Push the ignition switch while depressing the brake pedal within 10 seconds after the chime sounds. The engine will start.

After step 3 is performed, when the ignition switch is pushed without depressing the brake pedal, the ignition switch position will change to "ACC".

NOTE:

- **When the ignition switch is pushed to the "ACC" or "ON" position or the engine is started by the above procedures, the Key Battery Low indicator appears on the vehicle information display even if the Intelligent Key is inside the vehicle. This is not a malfunction. To turn off the Key Battery Low indicator, touch the ignition switch with the Intelligent Key again.**
- **If the Key Battery Low indicator appears on the vehicle information display, replace the battery as soon as possible. See "Battery" (P.8-16).**

STARTING ENGINE

1. Apply the parking brake.
2. Move the shift lever to the "P" (Park) or "N" (Neutral) position.

The starter is designed to operate only when the shift lever is in the proper position.

3. Confirm the location of the key.
 - Carry the Intelligent Key inside the vehicle.

4. Place the ignition switch in the "ON" position. Firmly depress the brake pedal and push the ignition switch to start the engine.

To start the engine immediately, push and release the ignition switch while depressing the brake pedal with the ignition switch in any position.

5. Immediately release the ignition switch when the engine starts. If the engine starts, but fails to run, repeat the above procedures.

If the engine is very hard to start in extremely cold or hot weather, depress the accelerator pedal and hold it to help start the engine. Push the ignition switch for up to 15 seconds while holding. Release the accelerator pedal when the engine starts.



CAUTION:

- **As soon as the engine has started, release the ignition switch immediately.**
- **Do not operate the starter for more than 15 seconds at a time. If the engine does not start, turn the ignition switch off and wait 10 seconds before cranking the engine again. Otherwise, the starter could be damaged.**

- **If it becomes necessary to start the engine with a booster battery and jumper cables, the instructions and cautions contained in the "6. In case of emergency" section should be carefully followed.**

6. Allow the engine to idle for at least 30 seconds after starting the engine to warm-up. Drive at moderate speeds for a short distance first, especially in cold weather.



CAUTION:

Do not leave the vehicle unattended while the engine is warming up.

To stop the engine, move the shift lever to the "P" (Park) position, apply the parking brake and place the ignition switch in the "OFF" position.

REMOTE ENGINE START (if equipped)

Vehicles started with the remote engine start function require the ignition switch to be placed in the "ON" position before the shift lever can be moved from the "P" (Park) position. To place the ignition switch in the "ON" position, perform the following steps:

1. Make sure that the Intelligent Key is with you.
2. Depress the brake pedal.
3. Push the ignition switch once to the "ON" position.

For additional information about the remote engine start function, see "Remote engine start" (P.3-16).

DRIVING VEHICLE

DRIVING WITH CONTINUOUSLY VARIABLE TRANSMISSION (CVT)



WARNING:

- **Do not depress the accelerator pedal while shifting from "P" (Park) or "N" (Neutral) to "R" (Reverse), "D" (Drive) or "Ds" (Drive Sport). Always depress the brake pedal until shifting is completed. Failure to do so could cause you to lose control and have an accident.**
- **Cold engine idle speed is high, so use caution when shifting into a forward or reverse gear before the engine has warmed up.**
- **Do not downshift abruptly on slippery roads. This may cause a loss of control.**
- **Never shift to either the "P" (Park) or "R" (Reverse) position while the vehicle is moving forward and "P" (Park), "D" (Drive) or "Ds" (Drive Sport) position while the vehicle is reversing. This could cause an accident or damage the transmission.**



CAUTION:

- **Except in an emergency, do not shift to the "N" (Neutral) position while driving. Coasting with the transmission in the "N" (Neutral) position may cause serious damage to the transmission.**
- **When stopping the vehicle on an uphill grade, do not hold the vehicle by depressing the accelerator pedal. The foot brake should be used for this purpose.**

The Continuously Variable Transmission (CVT) in your vehicle is electronically controlled to produce maximum power and smooth opera-

tion.

The CVT can operate in two different automatic drive modes:

- D (Drive) mode - Move the shift lever to "D" (Drive), the transmission is in the normal forward automatic driving mode. The position indicator in the meter shows a "D". The D (Drive) mode does not produce a gear change sensation like a traditional automatic transmission.
- Ds (Drive Sport) mode - Move the shift lever from "D" (Drive) to "Ds" (Drive Sport). The position indicator in the meter shows a "Ds". In Ds (Drive Sport) mode, transmission operation changes to "Sporty" driving shift operation, creating a more aggressive acceleration feeling than the D (Drive) mode and a gear change sensation when the driver accelerates. During Ds (Drive Sport) mode operation, the driver must move the shift lever from Ds (Drive Sport) mode to D (Drive) mode and back again to re-select Ds (Drive Sport) mode.
- To cancel the Ds (Drive Sport) mode, return the shift lever to the "D" (Drive) position. The transmission returns to the automatic drive mode.

The recommended operating procedures for this transmission are shown on the following pages. Follow these procedures for maximum vehicle performance and driving enjoyment.

NOTE:

Engine power may be automatically reduced to protect the CVT if the engine speed increases quickly when driving on slippery roads or while being tested on some dynamometers.

Starting vehicle

1. After starting the engine, fully depress the foot brake pedal before moving the shift lever out of the "P" (Park) position.
2. Keep the foot brake pedal depressed, push the shift lever button and move the shift lever to a driving position.
3. Release the parking brake, the foot brake pedal, and then gradually start the vehicle in motion.
4. Stop the vehicle completely before shifting the shift lever to the "P" (Park) position.

The CVT is designed so the foot brake pedal MUST be depressed before shifting from the "P" (Park) position to any driving position while the ignition switch is in the "ON" position.

The shift lever cannot be moved out of the "P" (Park) position and into any of the other positions if the ignition switch is placed in the "LOCK" position.

To move the shift lever:

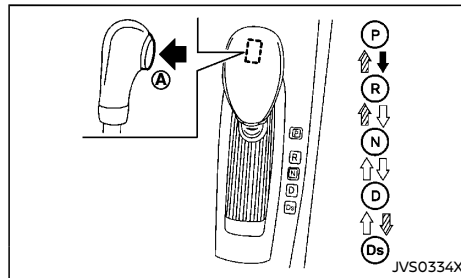

- ➡: Push the button (A) while depressing the foot brake pedal.
- ⚡: Push the button (A).
- ⇄: Just move the shift lever.

Shifting



WARNING:

Apply the parking brake if the shift lever is in any position while the engine is not running. Failure to do so could cause the vehicle to move unexpectedly or roll away and result in serious personal injury or property damage.

After starting the engine, fully depress the brake pedal and move the shift lever from "P" (Park) to any of the desired shift positions.

When it is hard to shift the shift lever from the "P" (Park) position to other position, first check that the parking brake is applied, then release the foot brake pedal and depress the foot brake pedal again.

P (Park):



CAUTION:

To prevent transmission damage, use the "P" (Park) or "R" (Reverse) position only when the vehicle is completely stopped.

Use this position when the vehicle is parked or when starting the engine. **Make sure that the vehicle is completely stopped and move the shift lever into the "P" (Park) position.** Apply the parking brake. When parking on a hill, first depress the foot brake pedal, apply the parking brake, and then move the shift lever into the "P" (Park) position.

R (Reverse):



CAUTION:

To prevent transmission damage, use the "P" (Park) or "R" (Reverse) position only when the vehicle is completely stopped.

Use this position to back up. Make sure that the vehicle is completely stopped before selecting the "R" (Reverse) position. **The brake pedal must be depressed to move the shift lever from "P" (Park), "N" (Neutral) or any drive position to "R" (Reverse).**

N (Neutral):

Neither the forward nor reverse gear is engaged. The engine can be started in this position. You may shift to the "N" (Neutral) position and restart a stalled engine while the vehicle is moving.

D (Drive):

Use this position for all normal forward driving.

Ds (Drive Sport):

When the shift lever is shifted from the "D" (Drive) to "Ds" (Drive Sport) position, the transmission enters the Ds (Drive Sport) mode. Moving the shift lever to the "Ds" (Drive Sport) position allows you to enjoy "sporty" driving shift operation on a winding road and feel smooth acceleration or deceleration on a hilly road by moving in a lower gear automatically. When canceling the Ds (Drive Sport) mode, return the shift lever to the "D" (Drive) position. The transmission returns to the normal driving mode.

SPORT mode switch

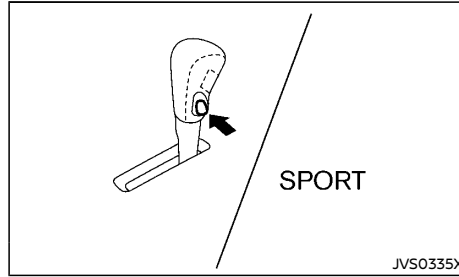

To select the SPORT mode, push the SPORT mode switch with the shift lever in the "D" (Drive) position. The SPORT mode indicator light **SPORT** in the meter panel illuminates. To turn off the SPORT mode, push the SPORT mode switch again. The SPORT mode indicator light will turn off. When the shift lever is shifted to any position other than "D" or "Ds", the SPORT mode will be automatically turned off.

"OFF" position:

For normal driving and fuel economy, use the "OFF" position.

"ON" position:

For driving up or down long slopes where engine braking is necessary, or for powerful acceleration, use the "ON" position. The transmission will automatically select a different gear ratio, allowing the engine to provide high output.

When driving conditions change, push the switch to turn the SPORT mode off.

Remember not to drive at high speeds for extended periods of time with the SPORT mode in the "ON" position. This reduces fuel economy.

Shift lock release

If the battery is discharged, the shift lever may not be moved from the "P" (Park) position even with the brake pedal depressed and the shift lever button pushed.

To move the shift lever, release the shift lock. The shift lever can be moved to the "N" (Neutral) position. However, the steering wheel will be locked unless the ignition switch is placed in the "ON" position. This allows the vehicle to be moved if the battery is discharged.

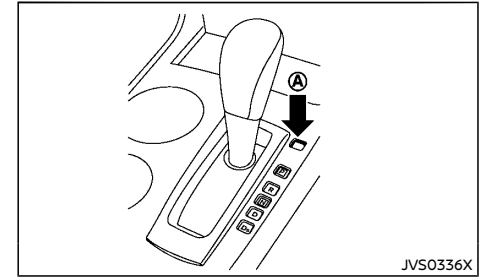

To move the shift lever, complete the following procedure:

1. Place the ignition switch in the "LOCK" position.
2. Apply the parking brake.
3. Push down the shift lock release button (A).
4. Move the shift lever to the "N" (Neutral) position while holding down the shift lock release.

Place the ignition switch in the "ON" position to release the steering wheel lock.

The vehicle may be moved, by pushing, to the desired location.

If the shift lever cannot be moved out of "P"

(Park), have a NISSAN dealer check the transmission as soon as possible.



WARNING:

If the shift lever cannot be moved from the "P" (Park) position while the engine is running and the brake pedal is depressed, the stop lights may not work. Malfunctioning stop lights could cause an accident injuring yourself and others.

Accelerator downshift - in the "D" position -

For passing or hill climbing, depress the accelerator pedal to the floor. This shifts the transmission down into a lower gear, depending on the vehicle speed.

High fluid temperature protection mode

This transmission has a high fluid temperature protection mode. If the fluid temperature becomes too high (for example, when climbing steep grades in high temperature with heavy loads), engine power and, under some conditions, vehicle speed will be decreased automatically to reduce the chance of transmission damage. Vehicle speed can be controlled with the accelerator pedal, but engine and vehicle speed may be limited.

Fail-safe

If the vehicle is driven under extreme conditions, such as excessive wheel spinning and subsequent hard braking, the fail-safe system may be activated. The Malfunction Indicator Light (MIL) may come on to indicate the fail-safe mode is activated. (See "Malfunction Indicator Light (MIL)" (P.2-10).) This

will occur even if all electrical circuits are functioning properly. In this case, place the ignition switch in the "OFF" position and wait for 10 seconds. Then push the switch back to the "ON" position. The vehicle should return to its normal operating condition. If it does not return to its normal operating condition, have a NISSAN dealer check the transmission and repair if necessary.







WARNING:

When the high fluid temperature protection mode or fail-safe operation occurs, vehicle speed may be gradually reduced. The reduced speed may be lower than other traffic, which could increase the chance of a collision. Be especially careful when driving. If necessary, pull to the side of the road at a safe place and allow the transmission to return to normal operation, or have it repaired if necessary.



WARNING:

- The Vehicle Dynamic Control (VDC) system is designed to help the driver maintain stability but does not prevent accidents due to abrupt steering operation at high speeds or by careless or dangerous driving techniques. Reduce vehicle speed and be especially careful when driving and cornering on slippery surfaces and always drive carefully.
- Do not modify the vehicle's suspension. If suspension parts such as shock absorbers, struts, springs, stabilizer bars, bushings and wheels are not NISSAN recommended for your vehicle or are extremely deteriorated, the VDC system may not operate properly. This could adversely affect vehicle handling performance, and the VDC warning light  may illuminate.
- If brake related parts such as brake pads, rotors and calipers are not NISSAN recommended or are extremely deteriorated, the VDC system may not operate properly and the VDC warning light  may illuminate.
- If engine control related parts are not NISSAN recommended or are extremely deteriorated, the VDC warning light  may illuminate.
- When driving on extremely inclined surfaces such as higher banked corners, the VDC system may not operate properly and the VDC warning light  may illuminate. Do not drive on these types of roads.
- When driving on an unstable surface such as a turntable, ferry, elevator or ramp, the

VDC warning light  may illuminate. This is not a malfunction. Restart the engine after driving onto a stable surface.

- **If wheels or tires other than the NISSAN recommended ones are used, the VDC system may not operate properly and the VDC warning light  may illuminate.**
- **The VDC system is not a substitute for winter tires or tire chains on a snow covered road.**

The Vehicle Dynamic Control (VDC) system uses various sensors to monitor driver inputs and vehicle motion. Under certain driving conditions, the VDC system helps to perform the following functions.

- Controls brake pressure to reduce wheel slip on one slipping drive wheel so power is transferred to a non slipping drive wheel on the same axle.
- Controls brake pressure and engine output to reduce drive wheel slip based on vehicle speed (traction control function).
- Controls brake pressure at individual wheels and engine output to help the driver maintain control of the vehicle in the following conditions:
 - understeer (vehicle tends to not follow the steered path despite increased steering input)
 - oversteer (vehicle tends to spin due to certain road or driving conditions).

The VDC system can help the driver to maintain control of the vehicle, but it cannot prevent loss of vehicle control in all driving situations.

When the VDC system operates, the VDC warning light  in the instrument panel flashes so note the following:

- The road may be slippery or the system may determine some action is required to help the vehicle on the steered path.
- You may feel a pulsation in the brake pedal and hear a noise or vibration from under the hood. This is normal and indicates that the VDC system is working properly.
- Adjust your speed and driving to the road conditions.

If a malfunction occurs in the system, the VDC warning light  illuminates in the instrument panel. The VDC system automatically turns off.

The VDC OFF switch is used to turn off the VDC system. The VDC off indicator light  illuminates to indicate the VDC system is off. When the VDC OFF switch is used to turn off the system, the VDC system still operates to prevent one drive wheel from slipping by transferring power to a non slipping drive wheel. The VDC switch is placed in the "OFF" position then back to the "ON" position.

See "Vehicle Dynamic Control (VDC) warning light" (P.2-9) and "Vehicle Dynamic Control (VDC) off indicator light" (P.2-10).

The computer has a built-in diagnostic feature that tests the system each time you start the engine and move the vehicle forward or in reverse at a slow speed. When the self-test occurs, you may hear a "clunk" noise and/or feel a pulsation in the brake pedal. This is normal and is not an indication of a malfunction.

VEHICLE DYNAMIC CONTROL (VDC) OFF SWITCH

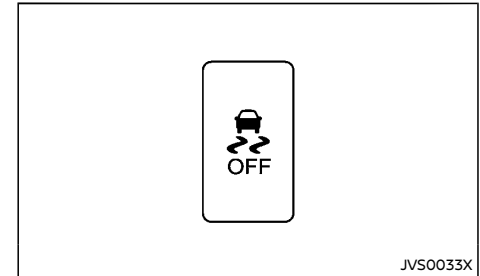

The vehicle should be driven with the Vehicle Dynamic Control (VDC) system on for most driving conditions.

When the vehicle is stuck in mud or snow, the VDC system reduces the engine output to reduce wheel spin. The engine speed will be reduced even if the accelerator is depressed to the floor. If maximum engine power is needed to free a stuck vehicle, turn the VDC system off.

To turn off the VDC system, push the VDC OFF switch located on the lower side of the instrument panel. The  indicator light will illuminate.

Push the VDC OFF switch again or restart the engine to turn on the system.

BLIND SPOT WARNING (BSW)/LANE DEPARTURE WARNING (LDW) SYSTEMS (if equipped)

The Blind Spot Warning (BSW) system helps alert the driver of other vehicles in adjacent lanes when changing lanes.

The Lane Departure Warning (LDW) system helps alert the driver when the vehicle is traveling close to either the left or the right of a traveling lane.

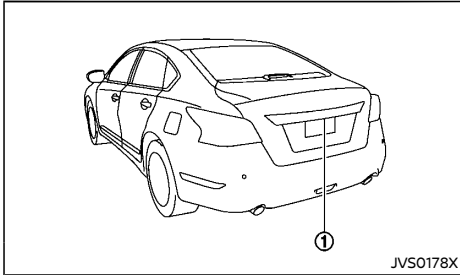

The BSW/LDW systems use the rearview camera unit ① with automatic washer and blower.



WARNING:

- The BSW system is not a replacement for proper driving procedure and is not designed to prevent contact with vehicles or objects. When changing lanes, always use the side and rear mirrors and turn and look in the direction you will move to ensure it is safe to change lanes. Never rely solely on the BSW system.
- The LDW system is only a warning device to help inform the driver of a potential unintended lane departure. It will not steer the vehicle or prevent loss of control. It is the driver's responsibility to stay alert, drive safely, keep the vehicle in the traveling lane, and be in control of the vehicle at all times.

- The camera unit may not function properly under the following conditions:
 - When strong light enters the camera unit. (For example, light directly shines on the rear of the vehicle at sunrise or sunset.)
 - When ambient brightness changes suddenly. (For example, when the vehicle enters or exits a tunnel or passes under a bridge.)
- If the camera lens is excessively dirty, the automatic washer may not be able to completely clean the lens. This could result in the camera not detecting vehicles or lane markers.
- Excessive noise (for example, audio system volume, open vehicle window) will interfere with the chime sound, and it may not be heard.

BSW SYSTEM OPERATION

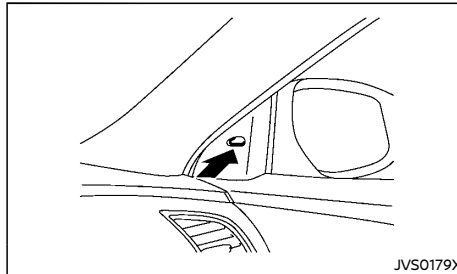

Blind Spot Indicator light

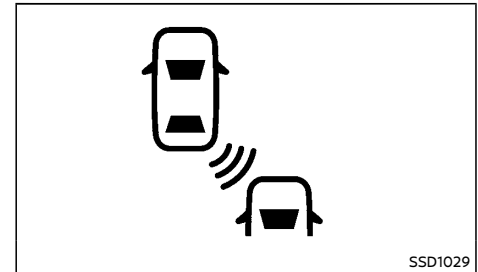

BSW indicator (in the vehicle information display)
The BSW system operates above approximately 32 km/h (20 MPH).

When the camera unit detects vehicles in the detection zone, the Blind Spot Indicator light located inside the outside mirrors will illuminate. If the turn signal is then activated, the system chimes (twice) and the Blind Spot Indicator light flashes to alert the driver.

The Blind Spot Indicator light continues to flash until the detected vehicle(s) leave the detection zone.

Detection zone

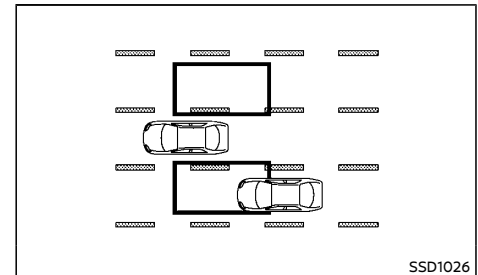

The camera unit can detect vehicles on either

side of your vehicle when part of another vehicle is within the detection zone shown as illustrated.

This detection zone typically starts from the outside mirror of your vehicle and extends approximately 3 m (10 ft) behind the rear bumper, and approximately 3 m (10 ft) sideways.

NOTE:

The Blind Spot Indicator light will illuminate for a few seconds when the ignition switch is placed in the "ON" position.

The brightness of the Blind Spot Indicator lights is adjusted automatically depending on the brightness of the ambient light.

A chime sounds if the camera unit has already detected vehicles when the driver activates the turn signal. If a vehicle comes into the detection zone after the driver activates the turn signal, then only the Blind Spot Indicator light flashes and no chime sounds. (See "BSW driving situations" (P.5-14).)

Turning on or off the BSW system

The BSW system is turned on or off using the settings menu in the vehicle information display.



SYSTEM ON:

The BSW indicator (white) in the vehicle information display will appear.

SYSTEM OFF:

The BSW indicator (white) in the vehicle information display will off.

Perform the following steps to enable or disable the BSW system.

1. Press the  button until "Settings" displays in the vehicle information display. Use the  to select "Driver Assistance". Then press the ENTER button.
2. Select "Driving Aids", and press the ENTER button.
3. To set the BSW system to on or off, use the  buttons to navigate in the menu and use the ENTER button to select or change an item:
 - Select "Blind Spot" and press the ENTER button.
 - To turn on the BSW system, use the ENTER button to check box for "Warning (BSW)".

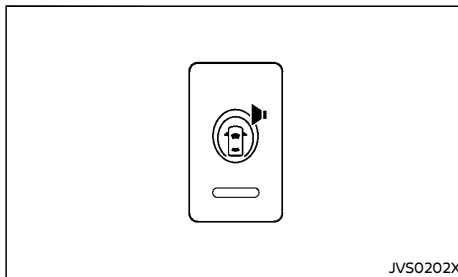

Warning systems switch

The warning systems switch is used to temporarily turn off the warning systems (Lane Departure Warning (LDW) and Blind Spot Warning (BSW) systems) that are activated using the settings menu.



WARNING:

- **The camera unit may not be able to detect when certain objects are present such as:**

- **Pedestrians, bicycles, animals**
- **Some types of small vehicles such as motorcycles and very short length vehicles**
- **Oncoming vehicles**
- **A vehicle approaching rapidly from behind. (See "BSW driving situations" (P.5-14).)**
- **A vehicle which your vehicle overtakes rapidly. (See "BSW driving situations" (P.5-14).)**
- **A vehicle that merges or changes lanes rapidly directly next to your vehicle.**

- **The camera unit may not be able to detect properly when your vehicle travels beside the middle section of a vehicle with long wheelbase (for example, trailer truck, semi-trailer, tractor).**
- **The camera detection zone is designed based on a standard lane width. When driving in a wider lane, the camera unit may not detect vehicles in an adjacent lane. When driving in a narrow lane, the camera unit may detect vehicles driving two lanes away.**
- **The camera unit is designed to ignore most stationary objects, however objects such as guardrails, walls, foliage and parked vehicles may occasionally be detected. This is a normal operating condition.**
- **The camera unit may detect the reflected image of vehicles or roadside objects that are not actually in the detection zone, especially when the road is wet.**

BSW DRIVING SITUATIONS

Another vehicle approaching from behind

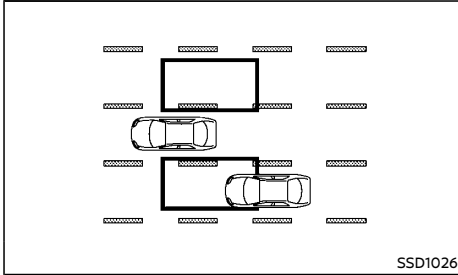

The Blind Spot Indicator light illuminates if a vehicle enters the detection zone from behind in an adjacent lane.

However, if the overtaking vehicle is traveling much faster than your vehicle, the indicator light may not illuminate before the detected vehicle is beside your vehicle. Always use the side and rear mirrors and turn and look in the direction your vehicle will move to ensure it is safe to change lanes.

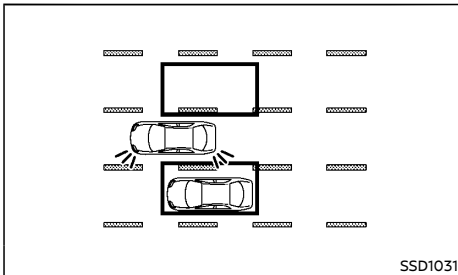

If the driver activates the turn signal, then the Blind Spot Indicator light flashes and a chime will sound twice.

NOTE:

If the driver activates the turn signal before a vehicle enters the detection zone, the Blind Spot Indicator light will flash but no chime will sound when the other vehicle is detected.

Overtaking other vehicles

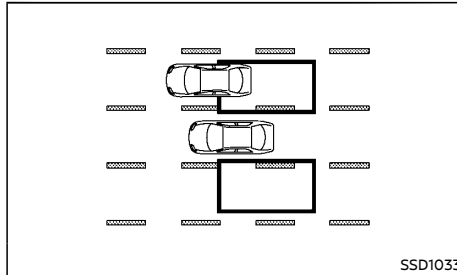

The Blind Spot Indicator light illuminates if you overtake a vehicle and that vehicle stays in the detection zone for approximately 3 seconds.

The camera unit may not detect slower moving vehicles if they are passed quickly.

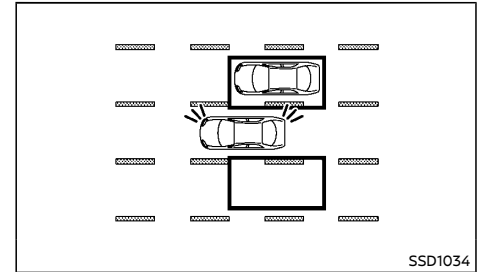

If the driver activates the turn signal while another vehicle is in the detection zone, then the Blind Spot Indicator light flashes and a chime will sound twice.

LDW SYSTEM OPERATION

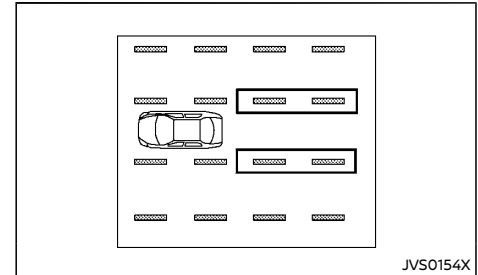

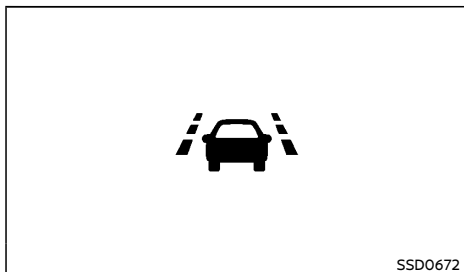

SSD0672

LDW indicator (in the Vehicle information display)
The LDW system operates above approximately 70 km/h (45 MPH).

When the vehicle approaches either the left or the right of the traveling lane, the LDW system will chime a sound and the LDW indicator (orange) in the vehicle information display will blink to alert the driver.

The LDW system is not designed to operate under the following conditions.

- When you operate the lane change signal and change traveling lanes in the direction of the signal. (The LDW system will become operable again approximately 2 seconds after the lane change signal is turned off.)
- When the vehicle speed is less than approximately 70 km/h (45 MPH).

Turning on or off the LDW system

The LDW system is turned on or off using the settings menu in the vehicle information display.



SYSTEM ON:

The LDW indicator (white) in the vehicle information display will light up.

SYSTEM OFF:

The LDW indicator (white) in the vehicle information display will go out.

Perform the following steps to enable or disable the LDW system.

1. Press the  button until "Settings" displays in the vehicle information display. Use the  to select "Driver Assistance". Then press the ENTER button.
2. Select "Driving Aids", and press the ENTER button.
3. To set the LDW system to on or off, use the  buttons to navigate in the menu and use the ENTER button to select or change an item:
 - Select "Lane" and press the ENTER button.
 - To turn on the LDW system, use the ENTER button to check box for "Warning (LDW)".

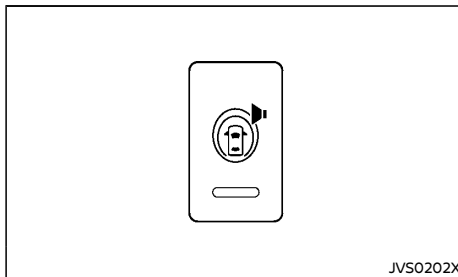

JVS0202X

Warning systems switch

The warning systems switch is used to temporarily turn off the warning systems (Lane

Departure Warning (LDW) and Blind Spot Warning (BSW) systems) that are activated using the settings menu in the vehicle information display.



WARNING:

- **The camera unit may not be able to detect properly under the following conditions:**
 - On roads where there are multiple parallel lane markers; lane markers that are faded or not painted clearly; yellow painted lane markers; non-standard lane markers; or lane markers covered with water, dirt, snow, etc.
 - On roads where the discontinued lane markers are still detectable.
 - On roads where there are sharp curves.
 - On roads where there are sharply contrasting objects, such as shadows, snow, water, wheel ruts, seams or lines remaining after road repairs. (The LDW system could detect these items as lane markers.)
 - On roads where the traveling lane merges or separates.
 - When the vehicle's traveling direction does not align with the lane marker.
 - When the road surface is very dark due to weak ambient light or impaired tail lamp.
- **When driving on a curved road, warning will be late on the outside of the curve.**

BSW/LDW TEMPORARY DISABLED STATUS

Under the following condition, the BSW and/or LDW system is turned off temporarily, the BSW indicator (white) and/or LDW indicator (white) will blink, and either of the following message will appear in the vehicle information display:

- "Trunk Open"
- "Low Washer Fluid"

When the above conditions are corrected, the BSW and/or LDW system will resume automatically.

BSW/LDW AUTOMATIC DEACTIVATION

When dirt, rain or snow accumulates on the camera, the BSW and/or LDW system will be turned off automatically and cannot be removed by the automatic washer and blower the BSW indicator (white) and/or LDW indicator (white) will blink, and the "Unavailable : Clean rear camera" will appear in the vehicle information display.

Action to take:

If the message appears, park the vehicle in a safe place, clean the camera unit with a soft cloth. Then turn off and restart the engine.

BSW/LDW MALFUNCTION

When the BSW and/or LDW system malfunctions, they will be turned off automatically, the BSW indicator (orange) and/or LDW indicator (orange) will illuminate and "Malfunction: Please see owners manual" will appear in the vehicle information display.

Action to take:

Stop the vehicle in a safe location, turn off and restart the engine. If the LDW indicator (orange) continues to illuminate, have the BSW and/or

LDW system checked by a NISSAN dealer.

CAMERA UNIT MAINTENANCE

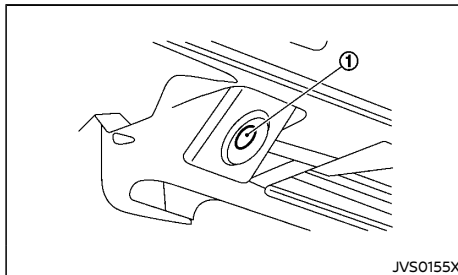

The rearview camera unit ① for the LDW/BSW systems is located above the rear license plate. To maintain the proper operation of the LDW/BSW systems and help keep the system functioning, be sure to observe the following:

- Always keep the camera unit clean. Be careful not to damage the nozzle of automatic washer and blower.
- Do not attach "license plate accessories" that reflect light.
- Do not strike or damage the areas around the camera unit.

CRUISE CONTROL

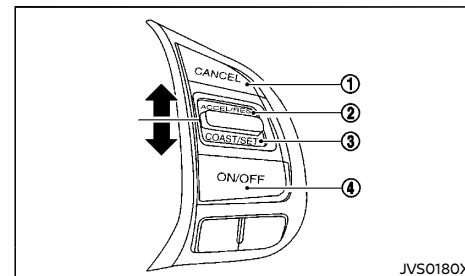

1. CANCEL switch
2. ACCELERATE/RESUME switch
3. COAST/SET switch
4. Cruise control MAIN switch



WARNING:

- **Always observe the posted speed limits and do not set the speed over them.**
- **Do not use the cruise control when driving under the following conditions. Doing so could cause a loss of vehicle control and result in an accident.**
 - When it is not possible to keep the vehicle at a constant speed
 - When driving in heavy traffic
 - When driving in traffic that varies speed
 - When driving in windy areas
 - When driving on winding or hilly roads
 - When driving on slippery (rain, snow, ice, etc.) roads

PRECAUTIONS ON CRUISE CONTROL

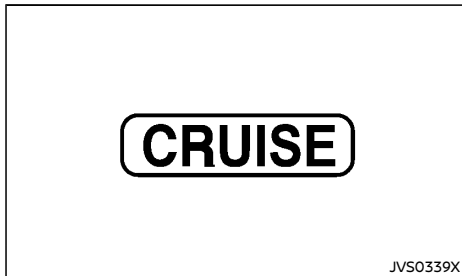

- If the cruise control system malfunctions, it will cancel automatically. The CRUISE indicator in the vehicle information display will then blink to warn the driver.
- If the CRUISE indicator blinks, turn the cruise control MAIN switch off and have the system checked by a NISSAN dealer.
- The CRUISE indicator may blink when the cruise control MAIN switch is turned ON while pushing the ACCELERATE/RESUME, COAST/SET or CANCEL switch. To properly set the cruise control system, perform the following procedures.

CRUISE CONTROL OPERATIONS

The cruise control allows driving at speeds above 40 km/h (25 MPH) without keeping your foot on the accelerator pedal.

The cruise control will automatically be canceled if the vehicle slows down more than approximately 13 km/h (8 MPH) below the set speed.

Moving the shift lever to the "N" (Neutral) position will cancel the cruise control.

Turning on cruise control

Push the MAIN switch. The CRUISE indicator in the vehicle information display will appear.

Setting cruising speed

1. Accelerate to the desired speed.
2. Push the COAST/SET switch and release it.
3. Take your foot off the accelerator pedal.

The vehicle will maintain the set speed.

Passing another vehicle:

Depress the accelerator pedal to accelerate. After releasing the accelerator pedal, the vehicle will return to the previously set speed.

The vehicle may not maintain the set speed when going up or down steep hills. In such cases, drive without the cruise control.

Resetting to slower speed:

Use any one of the following methods to reset to a slower speed.

- Lightly tap the foot brake pedal. When the vehicle reaches the desired speed, push and release the COAST/SET switch.
- Push and hold the COAST/SET switch. When the vehicle reaches the desired speed, release the COAST/SET switch.
- Quickly push and release the COAST/SET switch. This will reduce the vehicle speed by about 1 km/h (0.6 MPH).

Resetting to faster speed:

Use any one of the following methods to reset to a faster speed.

- Depress the accelerator pedal. When the vehicle reaches the desired speed, push and release the COAST/SET switch.

- Push and hold the ACCELERATE/RESUME switch. When the vehicle reaches the desired speed, release the ACCELERATE/RESUME switch.
- Quickly push and release the ACCELERATE/RESUME switch. This will increase the vehicle speed by about 1 km/h (0.6 MPH).

Resuming at preset speed:

Push and release the ACCELERATE/RESUME switch.

The vehicle will resume the last set cruising speed when the vehicle speed is over 40 km/h (25 MPH).

Cancelling cruising speed

Use any one of the following methods to cancel the set speed.

- Push the CANCEL switch.
- Tap the foot brake pedal.
- Push the cruise control MAIN switch. The CRUISE indicator will turn off.

FUEL EFFICIENCY AND CARBON DIOXIDE REDUCTION DRIVING TIPS

Follow these easy-to-use Fuel Efficiency and Carbon Dioxide Reduction Driving Tips to help you achieve the most fuel economy from your vehicle and reduce carbon dioxide emissions.

1. Use smooth accelerator and brake pedal application.
 - Avoid rapid starts and stops.
 - Use smooth, gentle accelerator and brake application whenever possible.
 - Maintain constant speed while commuting and coast whenever possible.
2. Maintain constant speed.
 - Look ahead to try and anticipate and minimize stops.
 - Synchronizing your speed with traffic lights allows you to reduce your number of stops.
 - Maintaining a steady speed can minimize red light stops and improve fuel efficiency.
3. Drive at economical speeds and distances.
 - Observing the speed limit and not exceeding 97 km/h (60 MPH) (where legally allowed) can improve fuel efficiency due to reduced aerodynamic drag.
 - Maintaining a safe following distance behind other vehicles reduces unnecessary braking.
 - Safely monitoring traffic to anticipate changes in speed permits reduced braking and smooth acceleration changes.
 - Select a gear range suitable to road conditions.
4. Use cruise control (if equipped).
 - Using cruise control during highway driving helps maintain a steady speed.

- Cruise control is particularly effective in providing fuel savings when driving on flat terrains.
5. Plan for the shortest route.
 - Utilize a map or navigation system (if equipped) to determine the best route to save time.
 6. Avoid idling.
 - Shutting off your engine when safe for stops exceeding 30-60 seconds saves fuel and reduces emissions.
 7. Buy an automated pass for toll roads.
 - Automated passes permit drivers to use special lanes to maintain cruising speed through the toll and avoid stopping and starting.
 8. Winter warm up.
 - Limit idling time to minimize impact to fuel economy.
 - Vehicles typically need no more than 30 seconds of idling at start-up to effectively circulate the engine oil before driving.
 - Your vehicle will reach its ideal operating temperature more quickly while driving versus idling.
 9. Keeping your vehicle cool.
 - Park your vehicle in a covered parking area or in the shade whenever possible.
 - When entering a hot vehicle, opening the windows will help to reduce the inside temperature faster, resulting in reduced demand on your A/C system.
 10. Do not carry excessive weight.
 - Remove unnecessary objects from the vehicle to reduce vehicle weight.

INCREASING FUEL ECONOMY AND REDUCING CARBON DIOXIDE EMISSIONS

- Keep your engine tuned up.
- Follow the recommended scheduled maintenance.
- Keep the tires inflated to the correct pressure. Low tire pressure increases tire wear and lowers fuel economy.
- Keep the wheels in correct alignment. Improper alignment increases tire wear and lowers fuel economy.
- Use the recommended viscosity engine oil. (See "Recommended fluids/lubricants and capacities" (P.9-2).)

ECO MODE SYSTEM

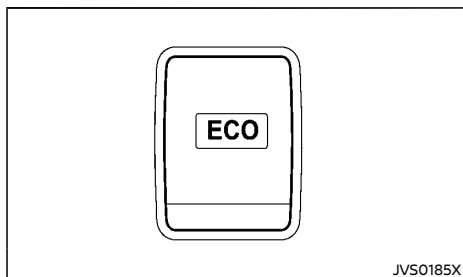

The ECO mode system helps to enhance the fuel economy by controlling the engine and CVT operation automatically to avoid rapid acceleration.

To turn on the ECO mode system, push the ECO switch. The ECO mode indicator appears in the vehicle information display.

To turn off the ECO mode, push the ECO switch again. The ECO mode indicator will turn off.

- The ECO mode system cannot be turned off while the accelerator pedal is depressed even if the ECO switch is pushed to OFF. Release the accelerator pedal to turn off the ECO mode system.
- The ECO mode system will turn off automatically if a malfunction occurs in the system.
- Turn off the ECO mode system when acceleration is required such as when:
 - driving with a heavy load of passengers or cargo in the vehicle
 - driving on a steep uphill slope

ECO PEDAL GUIDE FUNCTION

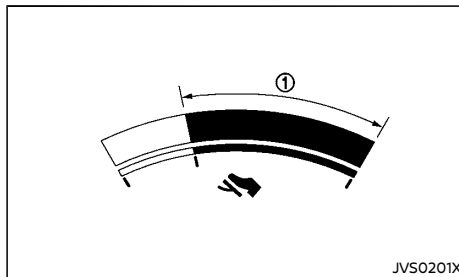

Use the ECO Pedal Guide function for improving fuel economy.

When the ECO Pedal Guide bar is in the green range ①, it indicates that the vehicle is driven within range of economy drive.

If the ECO Pedal Guide bar is out of the green range, it indicates that the accelerator pedal is depressed over the range of economy drive.

The ECO Pedal Guide bar is not displayed when the cruise control system is operating.

To activate or deactivate the ECO Pedal Guide function, see "ECO Mode Settings" (P.2-14).

AMBIENT ECO

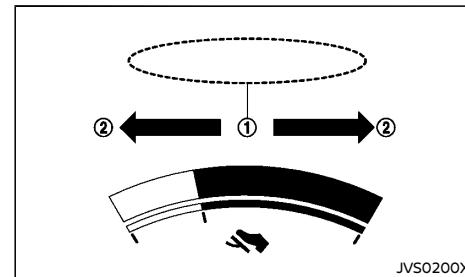

The ambient ECO ① is displayed according to the accelerator pedal operation, while driving the vehicle in ECO mode.

The ambient ECO will illuminate in the directions of ② as the driving pattern becomes more ECO friendly.

To activate or deactivate the ambient ECO, see "ECO Mode Settings" (P.2-14).

The ambient ECO is not displayed in the following conditions

- The vehicle speed is under 10 km/h (6 MPH).
- The shift lever is in the "P" (Park), "N" (Neutral) or "R" (Reverse) position.
- The cruise control system is operating.

PARKING



WARNING:

- Do not stop or park the vehicle over flammable materials such as dry grass, waste paper or rags. They may ignite and cause a fire.
- Safe parking procedures require that both the parking brake be applied and the shift lever placed in the "P" (Park) position. Failure to do so could cause the vehicle to move unexpectedly or roll away and result in an accident.
- When parking the vehicle, make sure the shift lever is moved to the "P" (Park) position. The shift lever cannot be moved out of the "P" (Park) position without depressing the foot brake pedal.
- Never leave the engine running while the vehicle is unattended.
- Do not leave children unattended inside the vehicle. They could unknowingly activate switches or controls. Unattended children could become involved in serious accidents.
- To help avoid risk of injury or death through unintended operation of the vehicle and/or its systems, do not leave children, people who require the assistance of others or pets unattended in your vehicle. Additionally, the temperature inside a closed vehicle on a warm day can quickly become high enough to cause a significant risk of injury or death to people and pets.

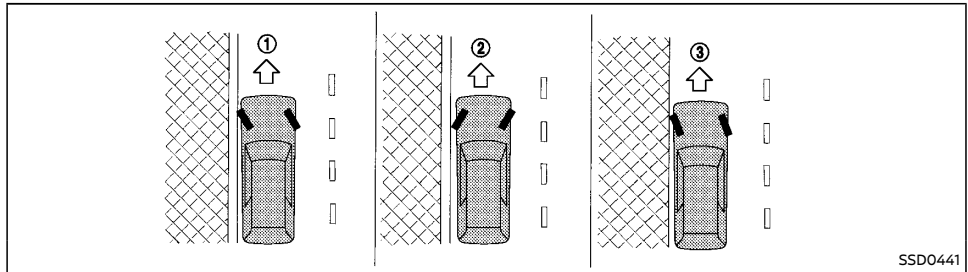

SSD0441

1. Firmly apply the parking brake.
2. Move the shift lever to the "P" (Park) position.
3. To help prevent the vehicle from moving into traffic when parked on an incline, it is a good practice to turn the wheels as illustrated.

HEADED DOWNHILL WITH CURB ①

Turn the wheels towards the curb and move the vehicle forward until the curb side wheel gently touches the curb. Then apply the parking brake.

HEADED UPHILL WITH CURB ②

Turn the wheels away from the curb and allow the vehicle to move back until the curb side wheel gently touches the curb. Then apply the parking brake.

HEADED UPHILL OR DOWNHILL, WITHOUT CURB ③

Turn the wheels toward the side of the road so the vehicle will move away from the center of the road if the vehicle moves. Then apply the parking brake.

4. Place the ignition switch in the "OFF" position.

PARKING SENSOR SYSTEM (if equipped)

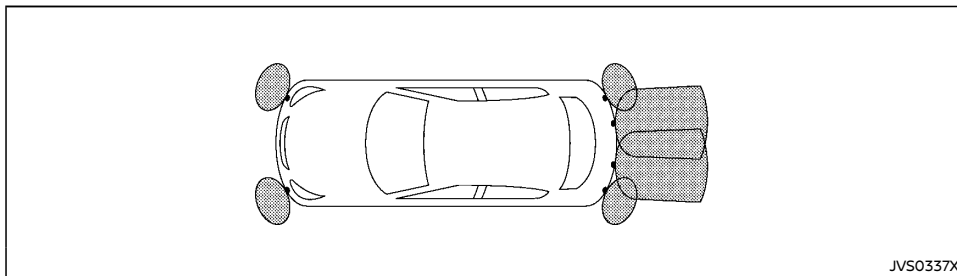

The parking sensor system sounds a tone to inform the driver of obstacles near the bumper. When the "Display" key is ON, the sensor view will automatically appear in the vehicle information display.



WARNING:

- The parking sensor system is a convenience but it is not a substitute for proper parking. The driver is always responsible for safety during parking and other manoeuvres. Always look around and check that it is safe to do so before parking.
- Read and understand the limitations of the parking sensor system as contained in this section. The colors of the parking sensor indicator and the distance guide lines in the front/rear view indicate different distances to the object. Inclement weather or ultrasonic sources such as an automatic car wash, a truck's compressed-air brakes or a pneumatic drill may affect the function of the system; this may include reduced performance or a false activation.

- This function is designed as an aid to the driver in detecting large stationary objects to help avoid damaging the vehicle. The system is not designed to prevent contact with small or moving objects. Always move slowly.
- The system will not detect small objects below the bumper, and may not detect objects close to the bumper or on the ground.
- The system may not detect the following objects.
 - Fluffy objects such as snow, cloth, cotton, grass or wool, etc.
 - Thin objects such as rope, wire and chain, etc.
 - Wedge-shaped objects
- If your vehicle sustains damage to the bumper fascia, leaving it misaligned or bent, the sensing zone may be altered causing inaccurate measurement of obstacles or false alarms.



CAUTION:

- Keep the interior of the vehicle as quiet as possible to hear the tone clearly.
- Keep the sensors (located on the bumper fascia) free from snow, ice and large accumulations of dirt. Do not clean the sensors with sharp objects. If the sensors are covered, the accuracy of the sensor function will be diminished.

The system informs with visual and audible signal of front obstacles when the shift lever is in the "D" (Drive) position and both front and rear obstacles when the shift lever is in the "R" (Reverse) position.

The system is deactivated at speeds above 10 km/h (6 MPH). It is reactivated at lower speeds.

The intermittent tone will stop after 3 seconds when an obstacle is detected by only the corner sensor and the distance does not change. The tone will stop when the obstacle gets away from the vehicle.

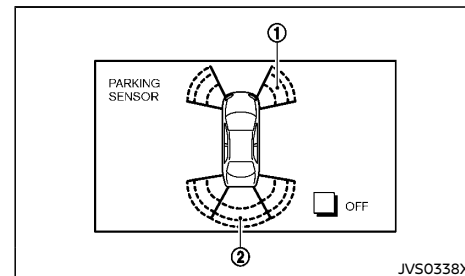

When the corner of the vehicle moves closer to an object, the corner sensor indicators ① appears.

When the center of the vehicle moves close to

an object, the rear center sensor indicator ② appears.

When the object is detected, the indicator (green) appears and blinks and the tone sounds intermittently. When the vehicle moves closer to the object, the color of the indicator turns yellow and the rate of the blinking increase. When the vehicle is very close to the object, the indicator stops blinking and turns red, and the tone sounds continuously.

PARKING SENSOR SYSTEM OFF SWITCH

The switch  on the steering-wheel-mounted controls allows the driver to turn the parking sensor system off.

The parking sensor system will turn on automatically under the following conditions.

- When the ignition switch is turned from the "OFF" position to the "ON" position.
- When the shift lever is in the "R" (Reverse) position.
- When the vehicle speed decrease to 10 km/h (6 MPH).

The automatic turning on function can be turned on and off by "Sensor" key in the setting menu. See "Driver Assistance" (P.2-12).

PARKING SENSOR SYSTEM SETTING

Sensor

Activate or deactivate the use of sensor.

ON (default) - Fr only - OFF

Display

Automatically shows the sensor view on the vehicle information display when the sensor is activated.

ON (default) - OFF

Volume

Adjust the volume of the tone.

High - Med. (default) - Low

Range

Adjust the detection range of the sensor.

Far - Mid. (default) - Near

TRAILER TOWING

Your vehicle was designed to be used to carry passengers and luggage. NISSAN does not recommend trailer towing, because it places additional loads on your vehicle's engine, drivetrain, steering, braking and other systems.



CAUTION:

Vehicle damage resulting from towing a trailer is not covered by the warranty.

HYDRAULIC PUMP ELECTRIC POWER STEERING



WARNING:

- **If the engine is not running or is turned off while driving, the power assist for the steering will not work. Steering will be harder to operate.**
- **When the hydraulic pump electric power steering warning light illuminates with the engine running, the power assist for the steering will cease operation. You will still have control of the vehicle, but the steering will be much harder to operate.**

The hydraulic pump electric power steering is designed to provide power assistance while driving to operate the steering wheel with light force.

When the steering wheel is operated repeatedly or continuously while parking or driving at a very low speed, the power assist for the steering wheel will be reduced. This is to prevent overheating of the hydraulic pump electric power steering and protect it from getting damaged. While the power assist is reduced, steering wheel operation will become heavy. If the steering wheel operation is still performed, the power steering may stop and the hydraulic pump electric power steering warning light will illuminate. Stop the engine and place the ignition switch in the "OFF" position. The temperature of the hydraulic pump electric power steering will go down and the power assist level will return to normal after starting the engine. The hydraulic pump electric power steering warning light will go off. Avoid repeating such steering wheel operations that could cause the hydraulic pump electric power steering to overheat.

You may hear a noise from the front of the vehicle when the steering wheel is operated. This is not a malfunction.

If the hydraulic pump electric power steering warning light illuminates while the engine is running, it may indicate the hydraulic pump electric power steering is not functioning properly and may need servicing. Have the hydraulic pump electric power steering checked by a NISSAN dealer.

When the hydraulic pump electric power steering warning light illuminates with the engine running, the power assist for the steering will cease operation but you will still have control of the vehicle. At this time, greater steering efforts are required to operate the steering wheel, especially in sharp turns and at low speeds.

BRAKE SYSTEM

The brake system has two separate hydraulic circuits. If one circuit malfunctions, you will still have braking ability at two wheels.

BRAKE PRECAUTIONS

Vacuum assisted brakes

The brake booster aids braking by using engine vacuum. If the engine stops, you can stop the vehicle by depressing the foot brake pedal. However, greater foot pressure on the foot brake pedal will be required to stop the vehicle. The stopping distance will be longer.

If the engine is not running or is turned off while driving, the power assisted brakes will not function. Braking will be harder.



WARNING:

Do not coast with the engine stopped.

Using brakes

Avoid resting your foot on the foot brake pedal while driving. This will overheat the brakes, wear out the brake linings/pads faster, and increase fuel consumption.

To help reduce brake wear and to prevent the brakes from overheating, reduce speed and downshift to a lower gear before going down a slope or long grade. Overheated brakes may reduce braking performance and could result in loss of vehicle control.

While driving on a slippery surface, be careful when braking, accelerating or downshifting. Abrupt braking or acceleration could cause the wheels to skid and result in an accident.

Wet brakes

When the vehicle is washed or driven through water, the brakes may get wet. As a result, your braking distance will be longer and the vehicle may pull to one side during braking.

To dry the brakes, drive the vehicle at a safe speed while lightly depressing the brake pedal to heat up the brakes. Do this until the brakes return to normal. Avoid driving the vehicle at high speeds until the brakes function correctly.

Parking brake break-in

Break in the parking brake shoes whenever the stopping effect of the parking brake is weakened or whenever the parking brake shoes and/or drums/rotors are replaced, in order to assure the best braking performance.

This procedure is described in the vehicle service manual and can be performed by a NISSAN dealer.

Driving downhill

The engine braking action is effective for controlling the vehicle while descending hills. Ds (Drive Sport) mode should be selected and the SPORT mode switch should be pushed to the "On" position prior to descent.

ANTI-LOCK BRAKING SYSTEM (ABS)



WARNING:

- **The Anti-lock Braking System (ABS) is a sophisticated device, but it cannot prevent accidents resulting from careless or dangerous driving techniques. It can help maintain vehicle control during braking on slippery surfaces. Remember that stopping distances on slippery surfaces will be longer than on normal surfaces**

even with ABS. Stopping distances may also be longer on rough, gravel or snow covered roads, or if you are using tire chains. Always maintain a safe distance from the vehicle in front of you. Ultimately, the driver is responsible for safety.

- **Tire type and condition may also affect braking effectiveness.**
 - **When replacing tires, install the specified size of tires on all four wheels.**
 - **When installing a spare tire, make sure that it is the proper size and type as specified on the tire placard. (See "Tire placard" (P.9-8).)**
 - **For detailed information, see "Tires and wheels" (P.8-23).**

The Anti-lock Braking System (ABS) controls the brakes so the wheels do not lock during hard braking or when braking on slippery surfaces. The system detects the rotation speed at each wheel and varies the brake fluid pressure to prevent each wheel from locking and sliding. By preventing each wheel from locking, the system helps the driver maintain steering control and helps to minimize swerving and spinning on slippery surfaces.

Using system

Depress the brake pedal and hold it down. Depress the brake pedal with firm steady pressure, but do not pump the brakes. The ABS will operate to prevent the wheels from locking up. Steer the vehicle to avoid obstacles.



WARNING:

Do not pump the brake pedal. Doing so may result in increased stopping distances.

Self-test feature

The ABS includes electronic sensors, electric pumps, hydraulic solenoids and a computer. The computer has a built-in diagnostic feature that tests the system each time you start the engine and move the vehicle at a low speed in forward or reverse. When the self-test occurs, you may hear a "clunk" noise and/or feel a pulsation in the brake pedal. This is normal and does not indicate a malfunction. If the computer senses a malfunction, it switches the ABS off and illuminates the ABS warning light on the instrument panel. The brake system then operates normally, but without anti-lock assistance.

If the ABS warning light illuminates during the self-test or while driving, have the vehicle checked by a NISSAN dealer.

Normal operation

The ABS operates at speeds above 5 to 10 km/h (3 to 6 MPH). The speed varies according to road conditions.

When the ABS senses that one or more wheels are close to locking up, the actuator rapidly applies and releases hydraulic pressure. This action is similar to pumping the brakes very quickly. You may feel a pulsation in the brake pedal and hear a noise from under the hood or feel a vibration from the actuator when it is operating. This is normal and indicates that the ABS is operating properly. However, the pulsation may indicate that road conditions are hazardous and extra care is required while driving.

VEHICLE SECURITY

When leaving your vehicle unoccupied:

- Always take the key with you - even when leaving the vehicle in your own garage.
- Close all windows completely and lock all doors.
- Always park your vehicle where it can be seen. Park in a well lit area during the night.
- If the security system is equipped, use it - even for a short period.
- Never leave children or pets in the vehicle unattended.
- Never leave valuables inside the vehicle. Always take valuables with you.
- Never leave the vehicle documents in the vehicle.
- Never leave articles on a roof rack. Remove them from the rack and keep and lock them in a safe place such as inside the trunk.
- Never leave the spare key in the vehicle.

COLD WEATHER DRIVING



WARNING:

- **Whatever the condition, drive with caution. Accelerate and decelerate with great care. If accelerating or decelerating too fast, the drive wheels will lose even more traction.**
- **Allow more stopping distance in cold weather driving. Braking should be started sooner than on dry pavement.**
- **Keep at a greater distance from the vehicle in front of you on slippery roads.**
- **Wet ice (0°C, 32°F and freezing rain), very cold snow and ice can be slick and very difficult to drive on. The vehicle will have a lot less traction or grip under these conditions. Try to avoid driving on wet ice until the road is salted or sanded.**
- **Watch for slippery spots (glaring ice). These may appear on an otherwise clear road in shaded areas. If a patch of ice is seen ahead, brake before reaching it. Try not to brake while actually on the ice, and avoid any sudden steering maneuvers.**
- **Do not use cruise control on slippery roads.**
- **Snow can trap dangerous exhaust gas under your vehicle. Keep snow clear of the exhaust pipe and from around your vehicle.**

BATTERY

If the battery is not fully charged during extremely cold weather conditions, the battery fluid may freeze and damage the battery. To maintain maximum efficiency, the battery should be checked regularly. For details, see "Battery" (P.8-16).

ENGINE COOLANT

If the vehicle is to be left outside without anti-freeze, drain the cooling system, including the engine block. Refill before operating the vehicle. For details, see "Changing engine coolant" (P.8-7).

TIRE EQUIPMENT

1. If you have snow tires installed on the front/rear wheels of your vehicle, they should be of the same size, loading range, construction and type (bias, bias-belted or radial) as the rear/front tires.
2. If the vehicle is to be operated in severe winter conditions, snow tires should be installed on all four wheels.
3. For additional traction on icy roads, studded tires may be used. However, some countries, provinces and states prohibit their use. Check local, state and provincial laws before installing studded tires.

Skid and traction capabilities of studded snow tires, on wet or dry surfaces, may be poorer than that of non-studded snow tires.

4. Snow chains may be used if desired. Make sure they are the proper size for the tires on your vehicle and are installed according to the chain manufacturer's instructions. (See "Tire chains" (P.8-24).)

SPECIAL WINTER EQUIPMENT

It is recommended that the following items be carried in the vehicle during the winter:

- A scraper and stiff-bristled brush to remove ice and snow from the windows.
- A sturdy, flat board to be placed under the jack to give it firm support.
- A shovel to dig the vehicle out of snow-drifts.

Engine block heater (if equipped)



WARNING:

Do not use the heater with an ungrounded electrical system or two-pronged (cheater) adapters. You can be injured by an electrical shock if you use an ungrounded connection.

An engine block heater to assist in extreme cold temperature starting is available through a NISSAN dealer.

PARKING BRAKE

When parking in the area where the outside temperature is below 0 °C (32 °F), do not apply the parking brake to prevent it from freezing. For safe parking:

- Place the shift lever in the "P" (Park) position.
- Securely block the wheels.

CORROSION PROTECTION

Chemicals used for road surface deicing are extremely corrosive and will accelerate corrosion and the deterioration of underbody components such as the exhaust system, fuel and brake lines, brake cables, floor pan and fenders.

In the winter, the underbody must be cleaned periodically. For additional information, see "Corrosion protection" (P.7-5).

For additional protection against rust and corrosion, which may be required in some areas, consult a NISSAN dealer.

6 In case of emergency

Hazard indicator flasher switch	6-2	Jump starting	6-5
Flat tire	6-2	Push starting	6-7
Stopping vehicle	6-2	If your vehicle overheats	6-7
Preparing tools and spare tire	6-2	Towing your vehicle	6-8
Blocking wheels	6-3	Towing precautions	6-8
Removing tire	6-3	Towing recommended by NISSAN	6-8
Installing spare tire	6-4	Freeing trapped vehicle	6-8
Stowing damaged tire and tools	6-5		

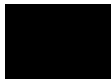

HAZARD INDICATOR FLASHER SWITCH

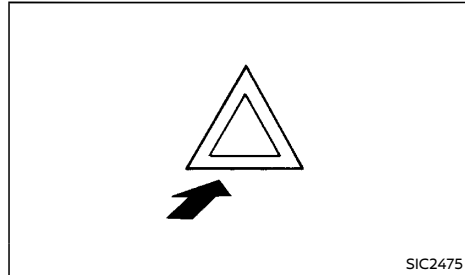

The hazard indicator flasher switch operates regardless of the ignition switch position except when the battery is discharged.

The hazard indicator flasher is used to warn other drivers when you have to stop or park under emergency conditions.

When the hazard indicator flasher switch is pushed, all turn signal lights will flash. To turn off the hazard indicator flasher, push the hazard indicator flasher switch again.

FLAT TIRE

If you have a flat tire, follow the instructions as follows.

STOPPING VEHICLE



WARNING:

- **Be sure to apply the parking brake firmly.**
 - **Be sure to move the shift lever to the "P" (Park) position.**
 - **Never change tires when the vehicle is on a slope, ice or slippery area. This is hazardous.**
 - **Never change tires when the oncoming traffic is close to your vehicle. Call for professional road assistance.**
1. Safely move the vehicle off the road away from traffic.
 2. Turn on the hazard indicator flasher lights.
 3. Park on a level surface.
 4. Apply the parking brake.
 5. Move the shift lever to the "P" (Park) position.
 6. Turn off the engine.
 7. Open the hood:
 - To warn other traffic.
 - To signal professional road assistance personnel that you need assistance.
 8. Have all passengers get out from the vehicle and stand in a safe place, away from other traffic and clear of the vehicle.

PREPARING TOOLS AND SPARE TIRE

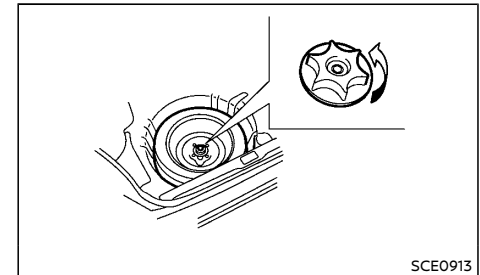
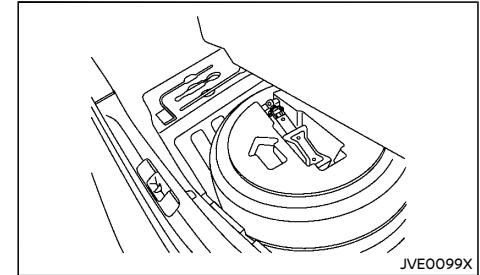

Remove the jack, necessary tools and the spare tire from the storage area located under the trunk.

BLOCKING WHEELS

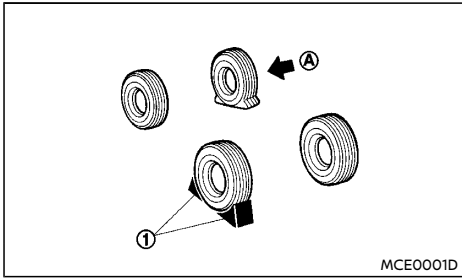

WARNING:

Be sure to block the appropriate wheel to prevent the vehicle from moving, which may cause personal injury.

Place suitable blocks ① at both the front and back of the wheel diagonally opposite the flat tire ② to prevent the vehicle from moving when it is jacked up.

REMOVING TIRE

Jacking up vehicle

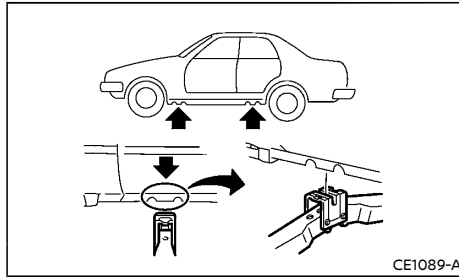

Jack-up points

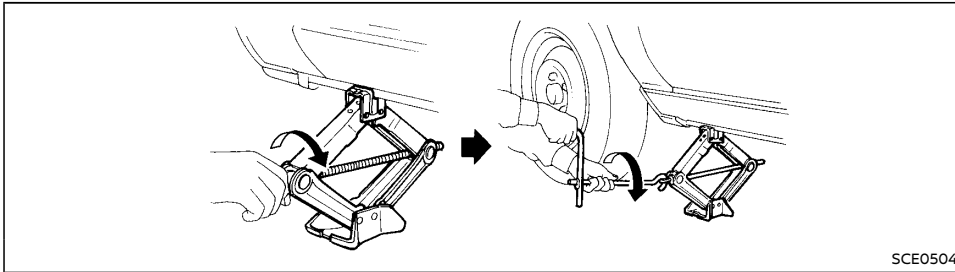

SCE0504

WARNING:

- Be sure to read and follow the instructions in this section.
- **DO NOT GET UNDER A VEHICLE THAT IS SUPPORTED BY A JACK.**
- Never use a jack which was not provided with your vehicle.
- The jack, which is provided with your vehicle, is designed only to lift your vehicle during a tire change. Do not use the jack provided with your vehicle on other vehicles.
- Never jack up the vehicle at a location other than the jack-up point that is specified.
- Never lift the vehicle more than necessary.
- Never use blocks on or under the jack.
- Never start or run the engine while the vehicle is on the jack. The vehicle may move suddenly, and this may cause an accident.

- Never allow passengers to remain in the vehicle while the tire is off the ground.
- Be sure to read the caution label attached to the jack body before using.

1. Place the jack directly under the jack-up point as illustrated so that the top of the jack contacts the vehicle at the jack-up point.

The jack should be placed on firm level ground.

2. Align the jack head between the two notches located at the jack-up point of either the front or the rear section.
3. Fit the groove of the jack head between the notches as shown.

4. Loosen each wheel nut, counterclockwise, one or two turns with the wheel nut wrench.

Do not remove the wheel nuts until the tire is off the ground.

5. Carefully raise the vehicle until the clearance between the tire and ground is achieved.

6. To lift the vehicle, securely hold the jack lever and rod with both hands and turn the jack lever.

Removing tire

1. Remove the wheel nuts.
2. Remove the damaged tire.



CAUTION:

The tire is heavy. Be sure that your feet are clear from the tire and use gloves as necessary to avoid injury.

INSTALLING SPARE TIRE

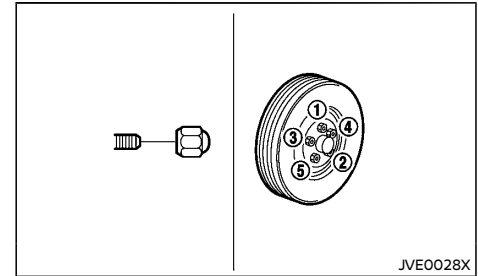

JVE0028X



WARNING:

- Never use wheel nuts which are not provided with your vehicle. Incorrect wheel nuts or improperly tightened wheel nuts may cause the wheel to become loose or come off. This could cause an accident.
- Never use oil or grease on the wheel studs or nuts. This may cause the wheel nuts to become loose.

1. Clean any mud or dirt from the surface between the wheel and hub.
2. Carefully put the spare tire on and tighten the wheel nuts with your fingers. Check that all the wheel nuts contact the wheel surface horizontally.
3. Tighten the wheel nuts alternately and evenly in the sequence illustrated (① - ⑤), more than 2 times with the wheel nut wrench, until they are tight.
4. Lower the vehicle slowly until the tire touches the ground.
5. Tighten the wheel nuts securely, with the wheel nut wrench, in the sequence illustrated.
6. Lower the vehicle completely.

Tighten the wheel nuts to the specified torque with a torque wrench as soon as possible.

**Wheel nut tightening torque:
108 N·m (11 kg·m, 80 ft·lb)**

The wheel nuts must be kept tightened to specification at all times. It is recommended that the wheel nuts be tightened to specification at each lubrication interval.



WARNING:

Retighten the wheel nuts when the vehicle has been driven for 1,000 km (600 miles) (also in cases of a flat tire, etc.).

STOWING DAMAGED TIRE AND TOOLS



WARNING:

Be sure that the tire, jack and tools used are properly stored after use. Such items can become dangerous projectiles in an accident or sudden stop.

1. Securely store the damaged tire, jack and tools used in the storage area.
2. Replace the spare tire cover and the floor cover.
3. Close the trunk lid.

JUMP STARTING



WARNING:

- **Incorrect jump starting can lead to a battery explosion. The battery explosion may result in severe injury or death. It may also result in damage to the vehicle. Be sure to follow the instructions in this section.**
- **Explosive hydrogen gas is always present in the vicinity of the battery. Keep all sparks and flames away from the battery.**
- **Always wear suitable eye protection and remove rings, bracelets, and any other jewelry whenever working on or near a battery.**
- **Never lean over the battery while jump starting.**
- **Never allow battery fluid to come into contact with eyes, skin, clothes or the vehicle's painted surfaces. Battery fluid is a corrosive sulfuric acid which can cause severe burns. If the fluid comes into contact with anything, immediately flush the contacted area with plenty of water.**
- **Keep the battery out of the reach of children.**
- **The booster battery must be rated at 12 volts. Use of an incorrectly rated battery will damage your vehicle.**
- **Never attempt to jump start a frozen battery. It could explode and cause serious injury.**

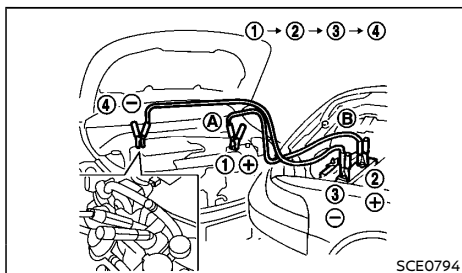

QR25DE engine model

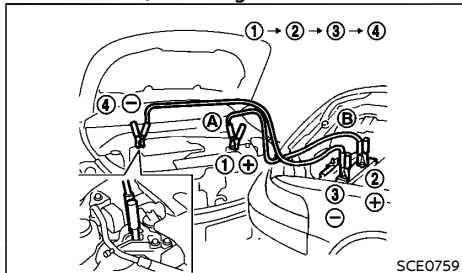

MR20DE engine model

1. If the booster battery is in another vehicle (B), position the two vehicles (A) and (B) to bring the batteries into close proximity to each other.



CAUTION:

If the battery of vehicle (A) equipped with the Intelligent Key system is discharged, the ignition switch cannot be moved from the "LOCK" position and, if the steering lock is engaged, the steering wheel cannot be moved. Connect the jumper cables to the booster vehicle (B) before pushing the ignition switch and disengaging the steering lock.

2. Apply the parking brake.
3. Move the shift lever to the "P" (Park) position.
4. Switch off all unnecessary electrical systems (headlights, heater, air conditioner, etc.).
5. Place the ignition switch in the "LOCK" position.
6. Remove the vent caps, if equipped, on the battery.
7. Cover the battery with a firmly wrung out moist cloth to reduce the hazard of an explosion.
8. Connect the jumper cables in the sequence as illustrated (1, 2, 3, 4).



CAUTION:

- Always connect positive ⊕ to positive ⊕ and negative ⊖ to body ground, NOT to the battery's negative ⊖.
 - Be sure that the jumper cables do not touch moving parts in the engine compartment.
 - Be sure that the jumper cable's clamps do not contact any other metal.
9. Start the engine of the booster vehicle (B) and let it run for a few minutes.
 10. Depress the accelerator pedal of the booster vehicle (B) at about 2,000 rpm.
 11. Start the engine of the jumped vehicle (A) in the normal manner.



CAUTION:

Never keep the starter motor engaged for more than 10 seconds. If the engine does not start right away, place the ignition switch in the "OFF" position and wait at least 10 seconds before trying again.

12. After the engine is started, carefully disconnect the jumper cables in the opposite sequence from that illustrated (4, 3, 2, 1).
13. Remove and dispose of the cloth as it may be contaminated with corrosive acid.
14. Replace the vent caps, if removed.

PUSH STARTING

Do not attempt to start the engine by pushing the vehicle.



CAUTION:

- **Continuously Variable Transmission (CVT) model cannot be started by pushing. Attempting to do so may cause damage to the transmission.**
- **Three-way catalyst equipped model should not be started by pushing. Attempting to do so may cause damage to the three-way catalyst.**
- **Never try to start the engine by towing. When the engine starts, the forward surge could cause the vehicle to collide with the towing vehicle.**

IF YOUR VEHICLE OVERHEATS



WARNING:

- **Never continue driving if your vehicle overheats. Doing so could cause a vehicle fire.**
- **Never open the hood if steam is coming out.**
- **Never remove the radiator cap while the engine is hot. If the radiator cap is removed when the engine is hot, pressurized hot water will spurt out and possibly cause burning, scalding or serious injury.**
- **If steam or coolant is coming from the engine, stand clear of the vehicle to prevent getting burned.**
- **The engine cooling fan will start at any time when the coolant temperature exceeds preset degrees.**
- **Be careful not to allow your hands, hair, jewelry or clothing to come into contact with, or to get caught in the cooling fan or drive belts.**

If your vehicle is overheating (indicated by the high temperature indicator), or if you feel a lack of engine power, detect unusual noise, etc., take the following steps:

1. Safely move the vehicle off the road away from traffic.
2. Turn on the hazard indicator flasher lights.
3. Apply the parking brake.
4. Move the shift lever to the "P" (Park) position.

DO NOT STOP THE ENGINE.

5. Open all the windows.

6. Turn off the air conditioner. Move the temperature control to maximum hot and the fan control to high speed.
 7. Get out from the vehicle.
 8. Visually inspect and listen for steam or coolant escaping from the radiator before opening the hood. Wait until no steam or coolant can be seen before proceeding.
 9. Open the engine hood.
 10. Visually inspect if the cooling fan is running.
 11. Visually inspect the radiator and radiator hoses for leakage.
If the cooling fan is not running or the coolant is leaking, stop the engine.
 12. After the engine cools down, check the coolant level in the reservoir with the engine running. **Do not open the radiator cap.**
 13. Add coolant to the reservoir if necessary.
- Have your vehicle inspected/repaired at a NISSAN dealer.

TOWING YOUR VEHICLE

When towing your vehicle, local regulations for towing must be followed. Incorrect towing equipment could damage your vehicle. To assure proper towing and to prevent accidental damage to your vehicle, NISSAN recommends that you have professional road assistance personnel tow your vehicle. It is advisable to have the professional road assistant carefully read the following precautions.

TOWING PRECAUTIONS

- Be sure that the transmission, steering system and powertrain are in working condition before towing. If any units are damaged, the vehicle must be towed using a dolly or flatbed tow truck.
- NISSAN recommends that your vehicle be towed with the driving front wheels off the ground.
- Always attach safety chains before towing.

TOWING RECOMMENDED BY NISSAN

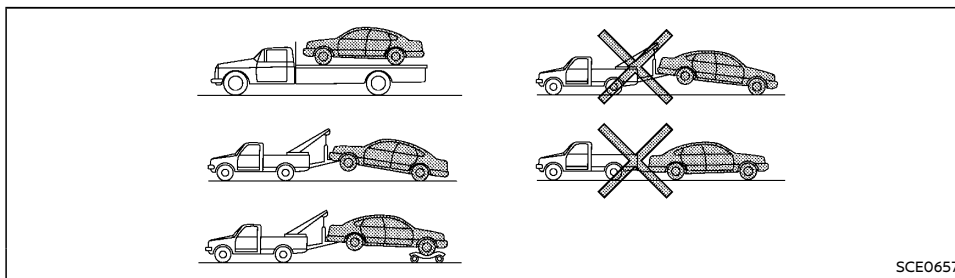

Front wheels on the ground:



CAUTION:

Never tow Continuously Variable Transmission (CVT) model with the front wheels on the ground. Doing so will cause serious and expensive damage to the transmission. If it is necessary to tow the vehicle, always use a dolly under the front wheels or use a flatbed tow truck.

Rear wheels on the ground:

1. Place the ignition switch in the "ON" position.
2. Secure the steering wheel in a straight-ahead position with rope or a similar device.
3. Move the shift lever to the "N" (Neutral) position.
4. Release the parking brake.
5. Attach safety chains whenever towing.

All four wheels on the ground



CAUTION:

Never tow CVT model with all four wheels on the ground. Doing so will cause serious and expensive damage to the transmission.

FREEING TRAPPED VEHICLE



WARNING:

- Never allow anyone to stand near the towing line during the pulling operation.
- Never spin the tires at high speed. This could cause them to explode and result in serious injury. Parts of the vehicle could also overheat and be damaged.
- Except for Indonesia: Do not pull the vehicle using the rear hook. The rear hook is not designed to pull the vehicle out in the event that the vehicle becomes trapped.

In the event that your vehicle's tires become trapped in sand, snow, or mud, and the vehicle

is unable to free itself without being pulled, use the recovery hooks.

- Use the recovery hooks only. Do not attach the pulling device to any other part of the vehicle body. Otherwise, the vehicle body may be damaged.
- Use the recovery hooks to free a vehicle only.
- The recovery hooks are under tremendous stress when used to free a trapped vehicle. Always pull the pulling device straight out from the vehicle. Never pull on the recovery hooks at an angle.

Front

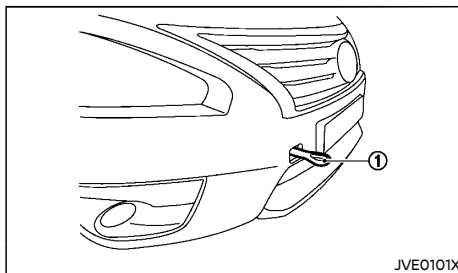
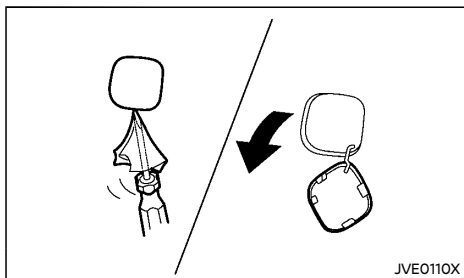

Front

Remove the cover and securely install the recovery hook ① as illustrated. (The hook is stored with the jacking tools.)

Make sure that the recovery hook is properly secured in its storage area after use.

Rear

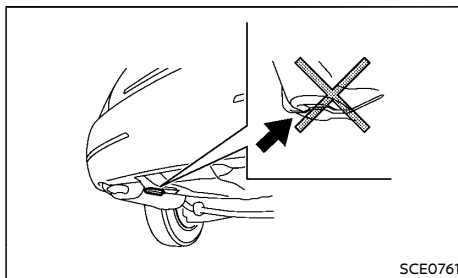

Rear (except for Indonesia)

MEMO

7 Appearance and care

Cleaning exterior	7-2	Floor mats	7-4
Washing	7-2	Glass	7-4
Removing spots	7-2	Seat belts	7-4
Waxing	7-2	Rear sunshade (if equipped)	7-4
Glass	7-2	Corrosion protection	7-5
Underbody	7-3	Most common factors contributing to	
Wheels	7-3	vehicle corrosion	7-5
Aluminum alloy wheels	7-3	Environmental factors influence rate	
Chrome parts	7-3	of corrosion	7-5
Cleaning interior	7-3	To protect your vehicle from corrosion	7-5
Air fresheners	7-4		

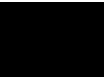

CLEANING EXTERIOR

In order to maintain the appearance of your vehicle, it is important to take proper care of it.

Whenever possible, park your vehicle inside a garage or in a covered area to minimize the chances of damaging the paint surface of your vehicle.

When it is necessary to park outside, park in a shady area or protect the vehicle with a body cover. **Be careful not to scratch the paint surface when putting on or removing the body cover.**

WASHING

In the following instances, wash your vehicle as soon as possible to protect the paint surface:

- After a rainfall, which may cause the paint surface damage from acid rain.
 - After driving on coastal roads, which may cause rusting from the sea breeze.
 - When contaminants such as soot, bird droppings, tree sap, metal particles or bugs get on the paint surface.
 - When dust or mud builds up on the paint surface.
1. Wash the vehicle surface with a wet sponge and plenty of water.
 2. Clean the vehicle surface gently and thoroughly using a mild soap, a special vehicle soap or a general purpose dishwashing liquid mixed with clean, lukewarm (never hot) water.



CAUTION:

- **Do not wash the vehicle with strong household soap, strong chemical detergents, gasoline or solvents.**

- **Do not wash the vehicle in direct sunlight or while the vehicle body is hot, as the paint surface may become water-spotted.**
 - **Avoid using tight-napped or rough cloths, such as washing mitts. Care must be taken when removing caked-on dirt or other foreign substances so the paint surface is not scratched or damaged.**
3. Rinse the vehicle thoroughly with plenty of clean water.
 4. Use a dampened chamois to dry the paint surface and avoid leaving water spots.

When washing the vehicle, take care of the following:

- Inside flanges, joints and folds on the doors, hatches and hood are particularly vulnerable to the effects of road salt. Therefore, these areas must be cleaned regularly.
- Be sure that the drain holes in the lower edge of the doors are not clogged.
- Spray water to the underbody and in the wheel wells to loosen the dirt and/or wash away road salt.

REMOVING SPOTS

Remove tar and oil spots, industrial dust, insects, and tree sap as quickly as possible from the paint surface to avoid lasting damage or staining. Special cleaning products are available at a NISSAN dealer or any automotive accessory store.

WAXING

Regular waxing protects the paint surface and helps maintain a new vehicle appearance.

After waxing, polishing is recommended to remove built-up residue and to avoid a weathered appearance.

A NISSAN dealer can assist you in choosing the appropriate waxing products.



CAUTION:

- **Wash your vehicle thoroughly and completely before applying wax to the paint surface.**
- **Always follow the manufacturer's instructions supplied with the wax.**
- **Do not use a wax containing any abrasives, cutting compounds or cleaners that may damage the vehicle finish.**

Machine compounding or aggressive polishing on a base coat/clear coat paint finish may dull the finish or leave swirl marks.

GLASS

Use glass cleaner to remove smoke and dust film from the glass surfaces. It is normal for glass to become coated with a film after the vehicle is parked in the hot sun. Glass cleaner and a soft cloth will easily remove this film.

UNDERBODY

In areas where road salt is used in the winter, it is necessary to clean the vehicle's underbody regularly in order to prevent dirt and salt from building up and causing the acceleration of corrosion on the underbody and suspension.

Before the winter and again in the spring, the underseal must be checked and, if necessary, re-treated.

WHEELS

- Wash the wheels when washing the vehicle to maintain their appearance.
- Clean the inner side of the wheels when the wheel is changed or the underside of the vehicle is washed.
- Do not use abrasive cleaners when washing the wheels.
- Inspect wheel rims regularly for dents or corrosion. This may cause loss of pressure or damage the tire bead.
- NISSAN recommends that the road wheels be waxed to protect against road salt in areas where it is used during winter.

ALUMINUM ALLOY WHEELS

Wash the wheels regularly with a sponge dampened in a mild soap solution, especially during winter in areas where road salt is used. The salt residue from road salt could discolor the wheels if it is not washed off regularly.



CAUTION:

Follow the directions below to avoid staining or discoloring the wheels:

- Do not use a cleaner that uses strong acid or alkali contents to clean the wheels.

- Do not apply wheel cleaners to the wheels when they are hot. The wheel temperature should be the same as ambient temperature.
- Rinse the wheel to completely remove the cleaner within 15 minutes after the cleaner is applied.

CHROME PARTS

Clean all chrome parts regularly with a non-abrasive chrome polish to maintain the finish.

CLEANING INTERIOR

Occasionally remove loose dust from the interior trim, plastic parts and seats using a vacuum cleaner or soft bristled brush. Wipe the vinyl and leather surfaces with a clean, soft cloth dampened in mild soap solution, then wipe clean with a dry, soft cloth.

Regular care and cleaning is required in order to maintain the appearance of the leather.

Before using any fabric protector, read the manufacturer's recommendations. Some fabric protectors contain chemicals that may stain or bleach the seat material.

Use a soft cloth dampened only with water to clean the meter and gauge lens covers.



CAUTION:

- Never use benzine, thinner or any similar material.
- Small dirt particles can be abrasive and damaging to leather surfaces and should be removed promptly. Do not use saddle soap, car waxes, polishes, oils, cleaning fluids, solvents, detergents or ammonia-based cleaners as they damage the leather natural finish.
- Never use fabric protectors unless recommended by the manufacturer.
- Do not use glass or plastic cleaner on meter or gauge lens covers. It may damage the lens covers.

AIR FRESHENERS

Most air fresheners use a solvent that could affect the vehicle interior. If you use an air freshener, take the following precautions:

- Hanging-type air fresheners can cause permanent discoloration when they contact vehicle interior surfaces. Place the air freshener in a location that allows it to hang free and not contact an interior surface.
- Liquid-type air fresheners typically clip on the vents. These products can cause immediate damage and discoloration when spilled on interior surfaces.

Carefully read and follow the manufacturer's instructions before using air fresheners.

FLOOR MATS

The use of genuine NISSAN floor mats (if equipped) can extend the life of your vehicle carpet and make it easier to clean the interior. Regardless of what mats are used, be sure they are fitted for your vehicle and are properly positioned in the foot well to prevent interference with pedal operation. Mats should be maintained with regular cleaning and replaced if they become excessively worn.

Floor mat positioning aid

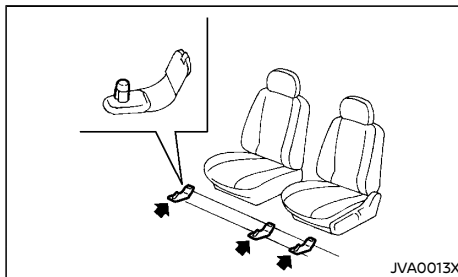

Example

This vehicle includes front floor mat brackets to act as a floor mat positioning aid. NISSAN floor mats have been specially designed for your vehicle model.

Position the mat by placing the floor mat bracket hook through the floor mat grommet hole while centering the mat in the foot area.

Periodically check that the mats are properly positioned.

GLASS

Use glass cleaner to remove smoke and dust film from the glass surfaces. It is normal for glass to become coated with a film after the vehicle is parked in the hot sun. Glass cleaner and a soft cloth will easily remove this film.



CAUTION:

When cleaning the inside of the windows, do not use sharp-edged tools, abrasive cleaners or chlorine-based disinfectant cleaners. They could damage the electrical conductors, such as rear window defogger elements.

SEAT BELTS



WARNING:

- **Do not allow wet seat belts to roll up in the retractor.**
- **Never use bleach, dye or chemical solvents to clean the seat belts, since these materials may severely weaken the seat belt webbing.**

The seat belts can be cleaned by wiping them with a sponge dampened in a mild soap solution.

Allow the belts to dry completely in the shade before using them. (See "Seat belts" (P.1-9).)

REAR SUNSHADE (if equipped)

Screen

To clean, fully extend the rear sunshade screen and clean dust or dirt off using a vacuum cleaner from the inside of the compartment. (See "Rear sunshade" (P.2-27) for rear sunshade operation.)



CAUTION:

Be careful not to damage the screen while cleaning.

Cover

Wipe the rear sunshade cover with a clean, dry cloth.



CAUTION:

Never use benzine, thinner or any other neutral detergent as this may deform the cover.

CORROSION PROTECTION

MOST COMMON FACTORS CONTRIBUTING TO VEHICLE CORROSION

- The accumulation of moisture-retaining dirt and debris in body panel sections, cavities, and other areas.
- Damage to the paint surface and other protective coatings caused by gravel and stone chips or minor traffic accidents.

ENVIRONMENTAL FACTORS INFLUENCE RATE OF CORROSION

Moisture

The accumulation of sand, dirt and water on the inside floor of the vehicle can accelerate corrosion. Wet floor carpet/floor mats will not dry completely inside the vehicle. They should be removed and completely dried to avoid floor panel corrosion.

Relative humidity

Corrosion will be accelerated in areas of high relative humidity.

Temperature

High temperatures accelerate the rate of corrosion to those parts which are not well ventilated.

Corrosion will also be accelerated in areas where the temperatures stay above freezing.

Air pollution

Industrial pollution, the presence of salt in the air in coastal areas, or heavy road salt use accelerates the corrosion process. Road salt also accelerates the disintegration of paint surfaces.

TO PROTECT YOUR VEHICLE FROM CORROSION

- Wash and wax your vehicle often to keep the vehicle clean.
- Always check for minor damage to the paint surface and if any exists, repair it as soon as possible.
- Keep the drain holes in the lower edge of the doors open to avoid water accumulation.
- Check the vehicle underbody for accumulation of sand, dirt or salt. If present, wash with water as soon as possible.



CAUTION:

- **Never remove dirt, sand or other debris from the passenger compartment by washing it out with a hose. Remove dirt with a vacuum cleaner or broom.**
- **Never allow water or other liquids to come in contact with electronic components inside the vehicle as this may damage them.**

Chemicals used for road surface deicing are extremely corrosive. They accelerate corrosion and deterioration of underbody components such as the exhaust system, fuel and brake lines, brake cables, floor pan and fenders.

In the winter, the underbody must be cleaned periodically.

For additional protection against rust and corrosion, which may be required in some areas, consult a NISSAN dealer.

MEMO

8 Maintenance and do-it-yourself

Maintenance requirements	8-2	Power steering fluid	8-13
Scheduled maintenance	8-2	Air cleaner filter	8-13
General maintenance	8-2	Wiper blades	8-14
Where to go for service	8-2	Windshield wiper blades	8-14
General maintenance	8-2	Window washer fluid	8-15
Explanation of general maintenance items	8-2	Battery	8-16
Maintenance precautions	8-4	Vehicle battery	8-16
Engine compartment check locations	8-5	Intelligent Key battery	8-17
QR25DE engine model	8-5	Variable voltage control system	8-18
MR20DE engine model	8-6	Fuses	8-18
Engine cooling system	8-6	Engine compartment	8-18
Checking engine coolant level	8-7	Passenger compartment	8-19
Changing engine coolant	8-7	Lights	8-21
Engine oil	8-7	Headlights	8-21
Checking engine oil level	8-7	Exterior lights	8-21
Changing engine oil and oil filter	8-8	Interior lights	8-21
Protect environment	8-9	Light locations	8-22
Drive belts	8-9	Tires and wheels	8-23
Spark plugs	8-10	Tire inflation pressure	8-23
Iridium-tipped spark plugs (if equipped)	8-10	Types of tires	8-23
Platinum-tipped spark plugs (if equipped)	8-10	Tire chains	8-24
Brakes	8-11	Tire rotation	8-24
Checking parking brake	8-11	Tire wear and damage	8-25
Checking foot brake pedal	8-11	Tire age	8-25
Brake booster	8-11	Changing tires and wheels	8-25
Brake fluid	8-12	Wheel balance	8-25
Continuously Variable Transmission (CVT) fluid	8-12	Spare tire	8-25

MAINTENANCE REQUIREMENTS

Some day-to-day and regular maintenance is essential to maintain your vehicle's good mechanical condition, as well as its emission and engine performance.

It is the owner's responsibility to make sure that the specified maintenance, as well as general maintenance, is performed.

As the vehicle owner, you are the only one who can ensure that your vehicle receives the proper maintenance care.

SCHEDULED MAINTENANCE

For your convenience, the required scheduled maintenance items are described and listed in a separate Warranty Information and Maintenance booklet. You must refer to that booklet to ensure that necessary maintenance is performed on your vehicle at regular intervals.

GENERAL MAINTENANCE

General maintenance includes those items which should be checked during normal day-to-day operation of the vehicle. They are essential if your vehicle is to continue to operate properly. It is your responsibility to perform these procedures regularly as prescribed.

Performing general maintenance checks requires minimal mechanical skill and only a few general automotive tools.

These checks and inspections can be done by yourself, a qualified technician, or if you prefer, a NISSAN dealer.

WHERE TO GO FOR SERVICE

If maintenance service is required or your vehicle appears to malfunction, have the systems checked and tuned by an authorized NISSAN dealer.

GENERAL MAINTENANCE

During normal day-to-day operation of the vehicle, general maintenance should be performed regularly as prescribed in this section. If you detect any unusual sounds, vibrations or smells, be sure to check for the cause or have a NISSAN dealer do it promptly. In addition, you should notify a NISSAN dealer if you think that repairs are required.

When performing any checks or maintenance work, closely observe "Maintenance precautions" (P.8-4).

EXPLANATION OF GENERAL MAINTENANCE ITEMS

Additional information on the following items with "" is found later in this section.

Outside vehicle

The maintenance items listed here should be performed from time to time, unless otherwise specified.

Doors and hood:

Check that all doors and the hood operate smoothly as well as the back door, trunk lid and hatch. Also make sure that all latches lock securely. Lubricate if necessary. Make sure that the secondary latch keeps the hood from opening when the primary latch is released. When driving in areas using road salt or other corrosive materials, check lubrication frequently.

Lights*:

Clean the headlights on a regular basis. Make sure that the headlights, stop lights, tail lights, turn signal lights, and other lights are all operating properly and installed securely. Also check the aim of the headlights.

Tires*:

Check the pressure with a gauge often and always prior to long distance trips. Adjust the pressure in all tires, including the spare, to the pressure specified. Check carefully for damage, cuts or excessive wear.

Tire rotation*:

In the case that Two-Wheel Drive (2WD) and front and rear tires are same size; tires should be rotated every 10,000 km (6,000 miles). Tires marked with directional indicators can only be rotated between front and rear. Make sure that the directional indicators point in the direction of wheel rotation after the tire rotation is completed.

In the case that Four-Wheel Drive and All Wheel Drive (4WD/AWD) and front and rear tires are same size; tires should be rotated every 5,000 km (3,000 miles). Tires marked with directional indicators can only be rotated between front and rear. Make sure that the directional indicators point in the direction of wheel rotation after the tire rotation is completed.

In the case that front tires are different size from rear tires; tires cannot be rotated.

The timing for tire rotation may vary according to your driving habits and the road surface conditions.

Tire Pressure Monitoring System (TPMS) transmitter components (if so equipped):

Replace the TPMS transmitter grommet seal, valve core and cap when the tires are replaced due to wear or age.

Wheel alignment and balance:

If the vehicle should pull to either side while driving on a straight and level road, or if you detect uneven or abnormal tire wear, there may be a need for wheel alignment. If the steering wheel or seat vibrates at normal highway speeds, wheel balancing may be needed.

Windshield:

Clean the windshield on a regular basis. Check the windshield at least every six months for cracks or other damage. Repair as necessary.

Wiper blades*:

Check for cracks or wear if not functioning correctly. Replace as necessary.

Inside vehicle

The maintenance items listed here should be checked on a regular basis, such as when performing periodic maintenance, cleaning the vehicle, etc.

Accelerator pedal:

Check the pedal for smooth operation and make sure that the pedal does not catch or require uneven effort. Keep the floor mats away from the pedal.

Brake pedal*:

Check the pedal for smooth operation and make sure that it is the proper distance from the floor mat when depressed fully. Check the brake booster function. Be sure to keep the floor mats away from the pedal.

Parking brake*:

Check the parking brake operation regularly. Check that the lever (if so equipped) or the pedal (if so equipped) has the proper travel. Also make sure that the vehicle is held securely on a fairly steep hill when only the parking brake is applied.

Seat belts:

Check that all parts of the seat belt system (for example, buckles, anchors, adjusters and retractors) operate properly and smoothly, and are installed securely. Check the belt webbing for cuts, fraying, wear or damage.

Steering wheel:

Check for changes in the steering condition, such as excessive play, hard steering or strange noises.

Warning lights and chimes:

Make sure that all warning lights and chimes are operating properly.

Windshield defogger:

Check that the air comes out of the defogger outlets properly and in good quantity when operating the heater or air conditioner.

Windshield wiper and washer*:

Check that the wipers and washer operate properly and that the wipers do not streak.

Under hood and vehicle

The maintenance items listed here should be checked periodically (for example, each time you check the engine oil or refuel).

Battery (except for maintenance free batteries)*:

Check the fluid level in each cell. It should be between the UPPER and LOWER lines. Vehicles operated in high temperatures or under severe conditions require frequent checks of the battery fluid level.

Brake (and clutch) fluid level(s)*:

For Manual Transmission (MT) model; make sure that the brake and clutch fluid levels are between the MAX and MIN lines on the reservoirs.

Except for Manual Transmission (MT) model; make sure that the brake fluid level is between the MAX and MIN lines on the reservoir.

Engine coolant level*:

Check the coolant level when the engine is cold. Make sure that the coolant level is between the MAX and MIN lines on the reservoir.

Engine drive belt(s)*:

Make sure that drive belt(s) is not frayed, worn, cracked or oily.

Engine oil level*:

Check the level after parking the vehicle (on a level ground) and turning off the engine.

Fluid leaks:

Check under the vehicle for fuel, oil, water or other fluid leaks after the vehicle has been parked for a while. Water dripping from the air conditioner after use is normal. If you should notice any leaks or if fuel fumes are evident, check for cause and have it corrected immediately.

Power steering fluid level and lines*:

Check the level when the fluid is cold, with the engine off. Check the lines for proper attachment, leaks, cracks, etc.

Windshield washer fluid*:

Check that there is adequate fluid in the reservoir.

MAINTENANCE PRECAUTIONS

When performing any inspection or maintenance work on your vehicle, always take care to prevent serious accidental injury to yourself or damage to the vehicle. The following are general precautions which should be closely observed.



WARNING:

- **Park the vehicle on a level surface, apply the parking brake securely and block the wheels to prevent the vehicle from moving. Move the shift lever to the "P" (Park) position.**
 - **Be sure the ignition switch is in the "OFF" or "LOCK" position when performing any parts replacement or repairs.**
 - **Do not work under the hood while the engine is hot. Always turn off the engine and wait until it cools down.**
 - **If you must work with the engine running, keep your hands, clothing, hair and tools away from moving fans, belts and any other moving parts.**
 - **It is advisable to secure or remove any loose clothing and any jewelry, such as rings, watches, etc. before working on your vehicle.**
- **If you must run the engine in an enclosed space such as a garage, be sure there is proper ventilation for exhaust gases to escape.**
 - **Never get under the vehicle while it is supported by a jack.**
 - **Keep smoking materials, flame and sparks away from fuel and the battery.**
 - **Never connect or disconnect either the battery or any transistorized component connector while the ignition switch is in the "ON" position.**
 - **On gasoline engine models with the Multiport Fuel Injection (MFI) system, the fuel filter and fuel lines should be serviced by a NISSAN dealer because the fuel lines are under high pressure even when the engine is turned off.**
 - **Your vehicle is equipped with an automatic engine cooling fan. It may come on at any time without warning, even if the ignition switch is in the "OFF" position and the engine is not running. To avoid injury, always disconnect the negative battery cable before working near the fan.**
 - **Always wear eye protection whenever you work on your vehicle.**
 - **Never leave the engine or transmission related component harness connector disconnected while the ignition switch is in the "ON" position.**
 - **Avoid direct contact with used engine oil and coolant. Improperly disposed engine oil, engine coolant, and/or other vehicle fluids can hurt the environment. Always conform to local regulations for disposal of vehicle fluids.**

This "8. Maintenance and do-it-yourself" section

ENGINE COMPARTMENT CHECK LOCATIONS

provides instructions regarding only those items which are relatively easy for an owner to perform.

You should be aware that incomplete or improper servicing may result in operating difficulties or excessive emissions, and could affect your warranty coverage. **If in doubt about any servicing, have it done by a NISSAN dealer.**

QR25DE ENGINE MODEL

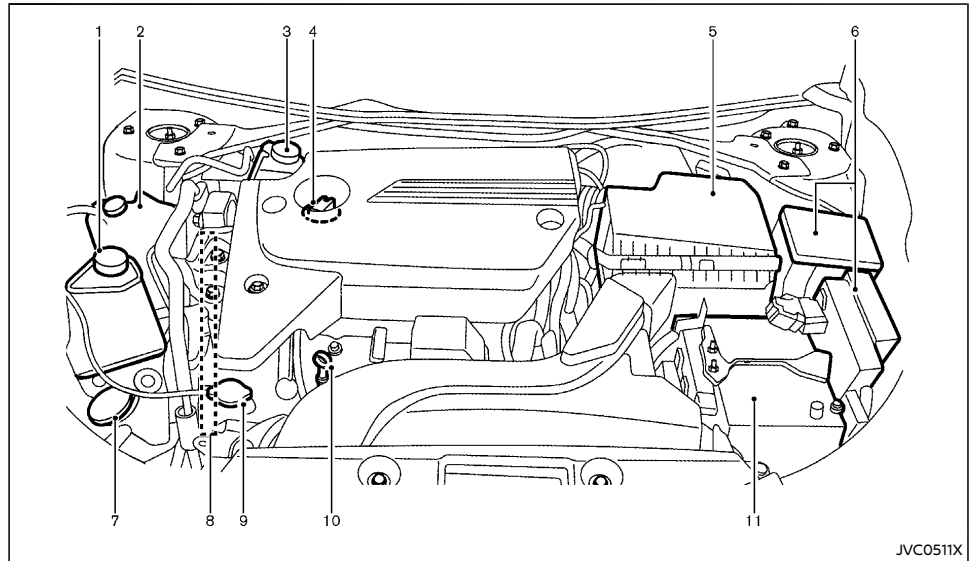

JVC0511X

1. Power steering fluid reservoir
2. Engine coolant reservoir
3. Brake fluid reservoir
4. Engine oil filler cap
5. Air cleaner
6. Fuse/fusible link box
7. Window washer fluid reservoir
8. Engine drive belt location
9. Radiator filler cap
10. Engine oil dipstick
11. Battery

ENGINE COOLING SYSTEM

MR20DE ENGINE MODEL

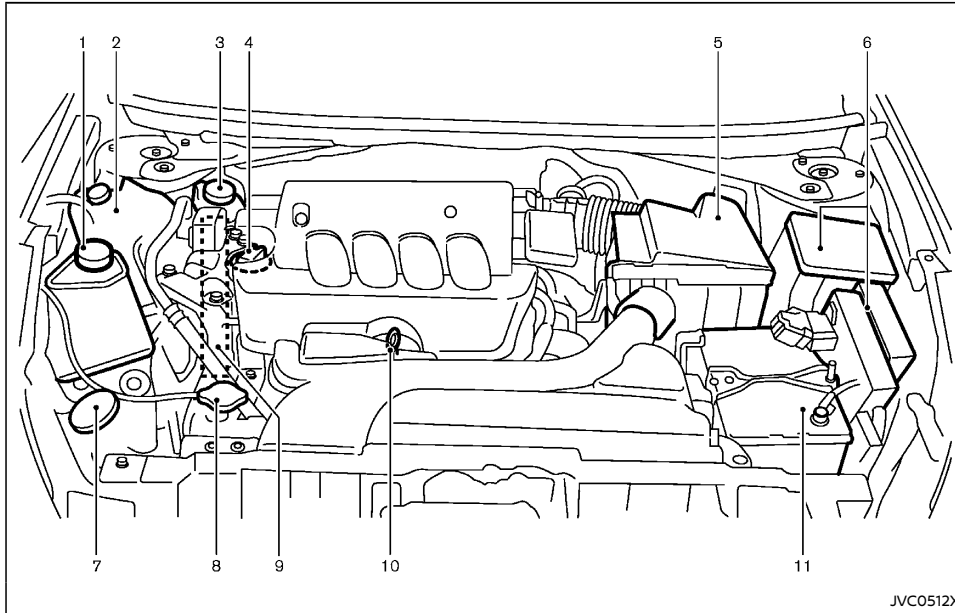

- | | |
|-----------------------------------|-------------------------------|
| 1. Power steering fluid reservoir | 9. Engine drive belt location |
| 2. Engine coolant reservoir | 10. Engine oil dipstick |
| 3. Brake fluid reservoir | 11. Battery |
| 4. Engine oil filler cap | |
| 5. Air cleaner | |
| 6. Fuse/fusible link box | |
| 7. Window washer fluid reservoir | |
| 8. Radiator cap | |



WARNING:

- Never remove the radiator cap when the engine is hot. Serious burns could be caused by high-pressure fluid escaping from the radiator. Wait until the engine and radiator cool down.
- Engine coolant is poisonous and should be stored carefully in marked containers out of the reach of children.

The engine cooling system is filled at the factory with a high-quality, year-round, anti-freeze coolant solution. The anti-freeze solution contains rust and corrosion inhibitors, therefore additional cooling system additives are not necessary.



CAUTION:

- Never use any cooling system additives such as radiator sealer. Additives may clog the cooling system and cause damage to the engine, transmission and/or cooling system.
- When adding or replacing coolant, be sure to use only Genuine NISSAN Engine Coolant or equivalent in its quality with the proper mixture ratio. Examples of the mixture ratio of coolant and water are shown in the following table:

Outside temperature down to		Engine coolant (concentrated)	Demineralized or distilled water
°C	°F		
-15	5	30%	70%
-35	-30	50%	50%

The use of other types of coolant solutions may damage the engine cooling system.

The radiator is equipped with a pressure cap. To prevent engine damage, use only a Genuine NISSAN radiator cap or its equivalent when replacement is required.

CHECKING ENGINE COOLANT LEVEL

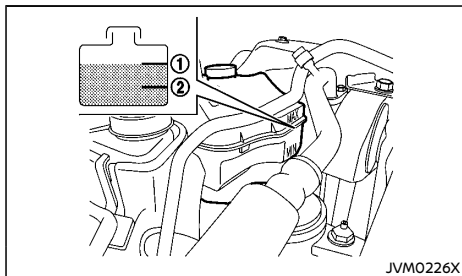

Check the coolant level in the reservoir tank when the engine is cold. If the coolant level is below the MIN level ②, add coolant up to the MAX level ①. If the reservoir tank is empty, check the coolant level in the radiator **when the engine is cold**. If there is insufficient coolant in the radiator, fill the radiator with coolant up to the filler opening and also add it to the reservoir tank up to the MAX level ①.

If the cooling system frequently requires coolant, have it checked by a NISSAN dealer.

CHANGING ENGINE COOLANT

Contact a NISSAN dealer if replacement is required.

Major engine cooling system repair should be performed by a NISSAN dealer. The service procedures can be found in the appropriate NISSAN Service Manual.

Improper servicing can result in reduced heater performance and engine overheating.



WARNING:

- **To avoid being scalded, never change the coolant when the engine is hot.**
- **Never remove the radiator cap when the engine is hot. Serious burns could be caused by high pressure fluid escaping from the radiator.**
- **Avoid direct skin contact with used coolant. If skin contact is made, wash thoroughly with soap or hand cleaner as soon as possible.**
- **Keep coolant out of reach of children and pets.**

Engine coolant must be disposed of properly. Check your local regulations.

ENGINE OIL

CHECKING ENGINE OIL LEVEL

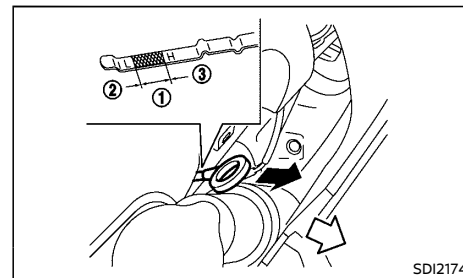

MR engine model

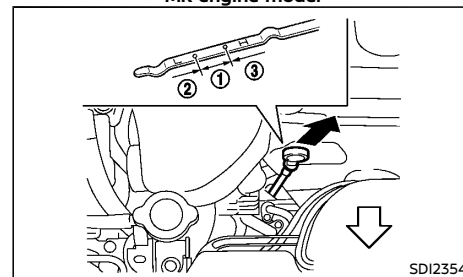

QR engine model

1. Park the vehicle on a level surface and apply the parking brake.
2. Start the engine and warm it up until the engine temperature reaches the normal operating temperature (approximately 5 minutes).
3. Stop the engine.
4. Wait at least 10 minutes for the engine oil to drain back to the oil pan.
5. Remove the dipstick and wipe it clean.

6. Reinsert the dipstick all the way.
7. Remove the dipstick and check the oil level. It should be within the range ①.
8. If the oil level is below ②, remove the oil filler cap and pour the recommended oil into the opening. Do not overfill ③.

When filling the engine oil, do not remove the dipstick.

9. Recheck the oil level with the dipstick.

It is normal to add some oil between oil maintenance intervals or during the break-in period, depending on the severity of operating conditions.

CAUTION:

The oil level should be checked regularly. Operating your vehicle with an insufficient amount of oil can damage the engine, and such damage is not covered by warranty.

CHANGING ENGINE OIL AND OIL FILTER

WARNING:

- Used oil must be disposed of properly. Never pour or dump oil into the ground, canals, rivers, etc. It should be disposed of at proper waste facilities. NISSAN recommends having your oil changed by a NISSAN dealer.
- Be careful not to burn yourself, as the engine oil may be hot.
- Prolonged and repeated contact with used engine oil may cause skin cancer.
- Avoid direct skin contact with used oil. If contacted, wash thoroughly with soap or hand cleaner and plenty of water as soon as possible.

• Store used engine oil in marked containers out of the reach of children.

1. Park the vehicle on a level surface and apply the parking brake.
2. Start the engine and warm it up until the engine temperature reaches the normal operating temperature (approximately 5 minutes).
3. Stop the engine.
4. Wait at least 10 minutes for the engine oil to drain back to the oil pan.
5. Raise and support the vehicle using a suitable floor jack and safety jack stands.
 - Place the safety jack stands under the vehicle jack-up points.
 - A suitable adapter should be attached to the jack stand saddle.
6. Remove the plastic cover (if equipped).
 - Remove the plastic clips from the cover.

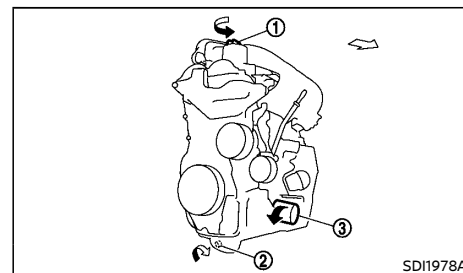

MR engine

- ① Oil filler cap
- ② Oil drain plug
- ③ Oil filter

1. Place a large drain pan under the drain plug.
2. Remove the drain plug with a wrench.
3. Remove the oil filler cap and completely drain the oil.

If the oil filter is to be changed, remove and replace it at this time.

CAUTION:

Waste oil must be disposed of properly. Check your local regulations.

4. Loosen the oil filter with an oil filter wrench.
5. Remove the oil filter by turning it by hand.
6. Wipe the engine oil filter mounting surface with a clean cloth.

Be sure to remove any old gasket remaining on the mounting surface.
7. Apply new engine oil to the gasket of the new oil filter.

Engine oil and filter

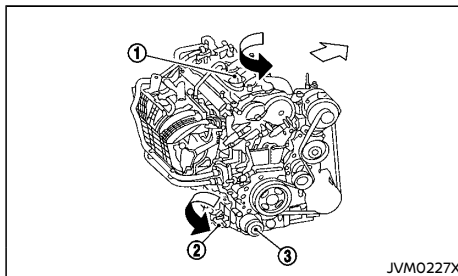

QR engine

- Screw in the oil filter until a slight resistance is felt and then tighten an additional 2/3 of a turn to secure the oil filter.

Oil filter tightening torque:

15 to 20 N·m

(1.5 to 2.0 kg·m, 11 to 15 ft·lb)

- Clean and reinstall the drain plug and new washer. Securely tighten the drain plug with a wrench. Do not use excessive force.

Drain plug tightening torque:

29 to 39 N·m

(3.0 to 4.0 kg·m, 22 to 29 ft·lb)

- Refill the recommended engine oil and quantity. (See "Recommended fluids/lubricants and capacities" (P.9-2).)

When filling the engine oil, do not remove the dipstick.

- Securely install the oil filler cap.
- Start the engine.
- Check the drain plug for any sign of leakage.
- Dispose of the used oil in the proper manner. Check your local regulations.
- Check the engine oil level according to the proper procedure. (See "Checking engine oil level" (P.8-7).)

After operation

- Install the cover (if equipped) into position as the following steps.
 - Pull the center of each plastic clip out.
 - Hold the cover into position.
 - Insert the clips through the cover into the hole in the frame, then push the center of the clips in to lock the clips in place.

- Lower the vehicle carefully to the ground.

PROTECT ENVIRONMENT

It is illegal to pollute drains, watercourses and soil. Use authorized waste collection facilities, including civil amenity sites and garages providing facilities for disposal of used oil and used oil filters. If in doubt, contact your local authority for advice on disposal.

The regulations concerning the pollution of the environment will vary from country to country.

DRIVE BELTS

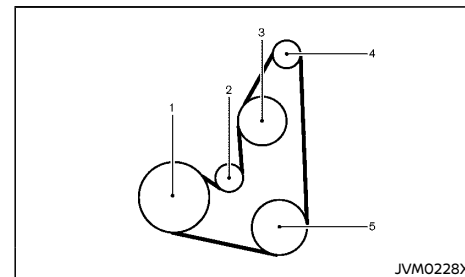

QR25DE engine

- Crankshaft pulley
- Drive belt auto-tensioner
- Water pump
- Alternator
- Air conditioner compressor

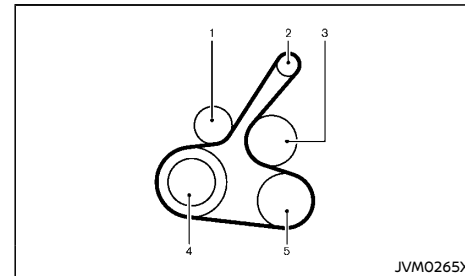

MR20DE engine

- Drive belt auto-tensioner
- Alternator
- Water pump
- Crankshaft pulley
- Air conditioner compressor

Be sure the ignition switch is in the "OFF" position.

SPARK PLUGS

Visually inspect each belt for signs of unusual wear, cuts, fraying or looseness. Check regularly for condition. If the belt is in poor condition or loose, have it replaced or adjusted by a NISSAN dealer.



WARNING:

Be sure the engine and ignition switch are off and that the parking brake is applied.

Replace the spark plugs according to the maintenance log shown in a separate maintenance booklet.

If replacement is required, contact a NISSAN dealer.

IRIDIUM-TIPPED SPARK PLUGS (if equipped)

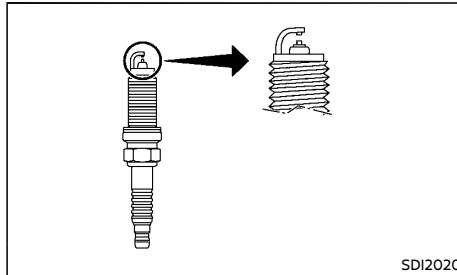

It is not necessary to replace the iridium-tipped spark plugs as frequently as the conventional type of spark plugs. These spark plugs are designed to last much longer than the conventional type of spark plug.



CAUTION:

- Do not reuse the iridium-tipped spark plugs by cleaning or re-gapping.
- Always replace with the recommended iridium-tipped spark plugs.

PLATINUM-TIPPED SPARK PLUGS (if equipped)

It is not necessary to replace the platinum-tipped spark plugs as frequently as the conventional type of spark plugs. These spark plugs are designed to last much longer than the conventional type of spark plugs.



CAUTION:

- Do not reuse the platinum-tipped spark plugs by cleaning or re-gapping.
- Always replace with the recommended platinum-tipped spark plugs.

BRAKES

CHECKING PARKING BRAKE

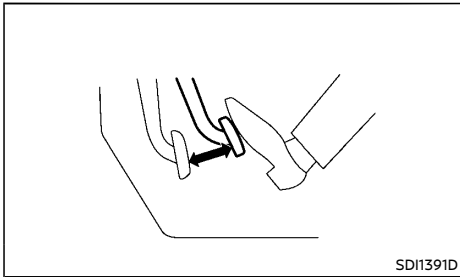

From the released position, depress the parking brake pedal slowly and firmly. If the number of clicks is out of the range listed, see a NISSAN dealer.

5 to 6 clicks
Depressing force 196 N (20 kg, 44 lb)

CHECKING FOOT BRAKE PEDAL

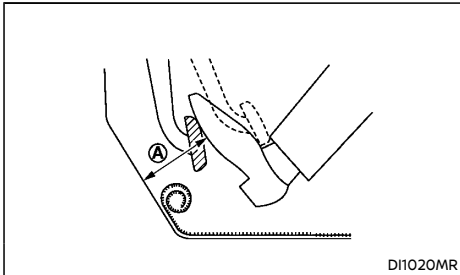

WARNING:

See a NISSAN dealer for a brake system check if the foot brake pedal height does not return to normal.

With the engine running, check the distance between the upper surface of the pedal and the metal floor. If it is out the range listed, see a NISSAN dealer.

A: 108 mm (4.25 in) or more
Depressing force: 490 N (50 kg, 110 lb)

Self-adjusting brakes

Your vehicle is equipped with self-adjusting brakes. The disc-type brakes self-adjust every time the foot brake pedal is applied.

Brake pad wear indicator

The disc brake pads have audible wear warnings. When a brake pad requires replacement, it will make a high pitched scraping sound when the vehicle is in motion. This scraping sound will first occur only when the brake pedal is depressed. After more wear of the brake pad, the sound will always be heard even if the brake pedal is not depressed. Have the brakes checked as soon as possible if the wear warning sound is heard.

Under some driving or climate conditions, occasional brake squeaks, squeals or other noises may be heard. Occasional brake noise during light to moderate stops is normal and does not affect the function or performance of the brake system.

Proper brake inspection intervals should be followed. For additional information, see a separate maintenance booklet.

BRAKE BOOSTER

Check the brake booster function as follows:

1. With the engine off, depress and release the foot brake pedal several times. When the brake pedal movement (distance of travel) remains the same from one pedal application to the next, continue on to the next step.
2. While depressing the foot brake pedal, start the engine. The pedal height should drop a little.
3. With the foot brake pedal depressed, stop the engine. Keep the pedal depressed for about 30 seconds. The pedal height should not change.
4. Run the engine for 1 minute without depressing the foot brake pedal, then turn it off. Depress the foot brake pedal several times. The pedal travel distance will decrease gradually with each depression as the vacuum is released from the booster.

If the brakes do not operate properly, have the brakes checked by a NISSAN dealer.

BRAKE FLUID



WARNING:

- Use only new fluid from a sealed container. Old, inferior, or contaminated fluid may damage the brake system. The use of improper fluids can damage the brake system and affect the vehicle's stopping ability.
- Clean the filler cap before removing.
- Brake fluid is poisonous and should be stored carefully in marked containers out of the reach of children.



CAUTION:

Do not spill the fluid on painted surfaces. This will damage the paint. If fluid is spilled, wash it off with plenty of water immediately.

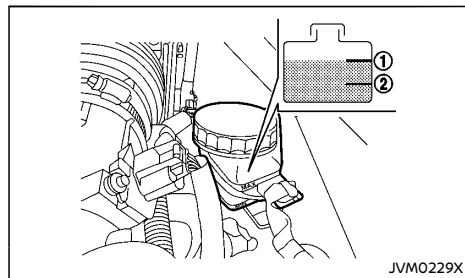

Check the fluid level in the reservoir. If the fluid is below the MIN line ②, the brake warning light will illuminate. Add fluid up to the MAX line ①. (See "Recommended fluids/lubricants and capacities" (P.9-2) for recommended types of fluid.)

If the fluid must be added frequently, the system should be thoroughly checked by a

NISSAN dealer.

CONTINUOUSLY VARIABLE TRANSMISSION (CVT) FLUID

Contact a NISSAN dealer if checking or replacement is required.



CAUTION:

- Use only Genuine NISSAN CVT Fluid NS-3. Do not mix with other fluids.
- Using transmission fluid other than Genuine NISSAN CVT Fluid NS-3 will damage the CVT, which is not covered by the warranty.

POWER STEERING FLUID

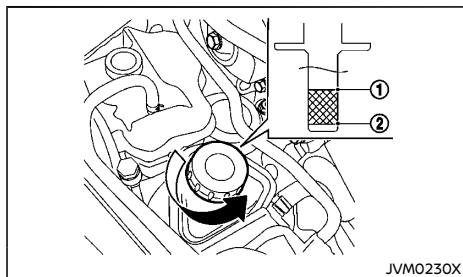

WARNING:

Power steering fluid is poisonous and should be stored carefully in marked containers out of the reach of children.

Check the fluid level in the reservoir. The fluid level should be checked when the fluid is cold at fluid temperatures of 0 to 30°C (32 to 86°F). The fluid level can be checked with the level gauge which is attached to the cap. To check the fluid level, remove the cap. The fluid level should be between the MAX ① and MIN ② lines.

If the fluid is below the MIN ② line, add Genuine NISSAN E-PSF. Remove the cap and fill through the opening. (See "Recommended fluids/lubricants and capacities" (P.9-2).) **Do not overfill.**

AIR CLEANER FILTER

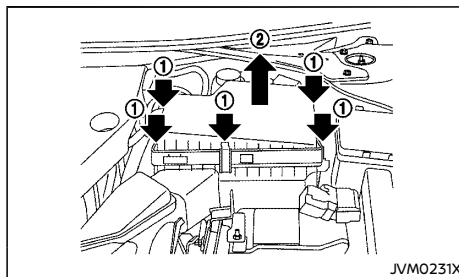

QR engine model

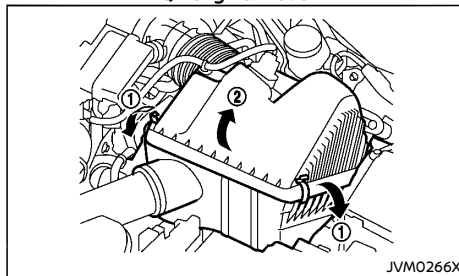

MR engine model



WARNING:

Operating the engine with the air cleaner filter off can cause you or others to be burned. The air cleaner filter not only cleans the intake air, it also stops flame if the engine backfires. If the air cleaner filter is not installed and the engine backfires, you could be burned. Never drive with the air cleaner filter off. Be cautious working on the engine when the air cleaner filter is off.

To remove the filter, release the lock pins ① and pull the air cleaner cover upward ②.

The viscous paper type filter element should not be cleaned and reused. The dry paper type filter element may be cleaned and reused. Replace the air filter according to the maintenance log shown in a separate maintenance booklet.

When replacing the air filter, wipe the inside of the air cleaner housing and the cover with a damp cloth.

WIPER BLADES

WINDSHIELD WIPER BLADES

Cleaning

If the windshield does not become clear after using the windshield washer or if the wiper blades chatter when operating the windshield wipers, wax or other materials may be on the windshield and/or wiper blades.

Clean the outside of the windshield surface with a washer solution or mild detergent. Your windshield is clean if beads do not form when rinsing with water.

Clean the blade by wiping it with a cloth soaked in a washer solution or a mild detergent. Rinse the blade with water. If your windshield is still not clear after cleaning the blades and using the wipers, replace the blades.

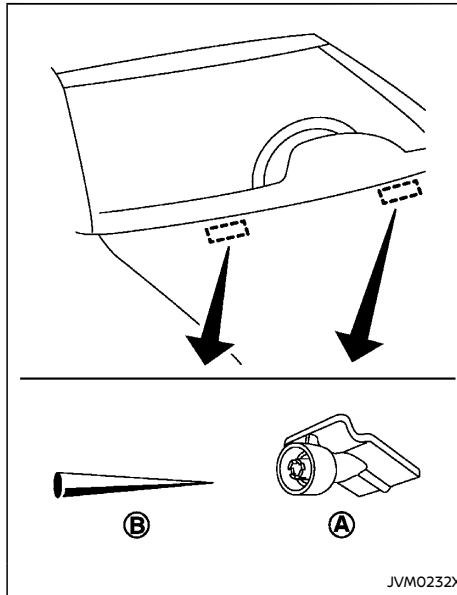

Be careful not to clog the washer nozzle (A). This may cause improper windshield washer operation. If the nozzle is clogged, remove any objects with a needle or small pin (B). Be careful not to damage the nozzle.

Replacing

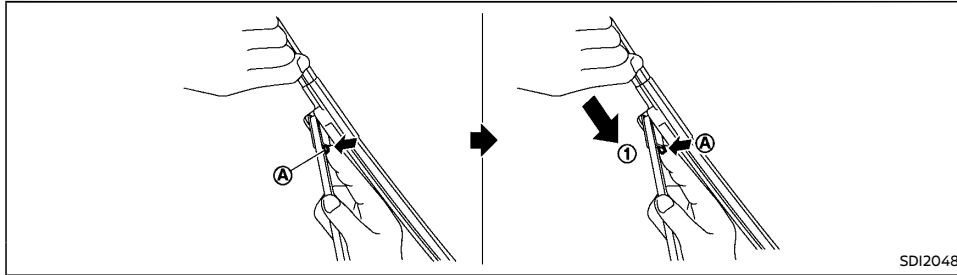

1. Lift the wiper arm away from the windshield. **When lifting the wiper arm, lift the driver's side first, then the passenger's side. Otherwise, the wiper blades may be scratched and may cause damage.**
2. Push and hold the release tab (A), and then move the wiper blade down the wiper arm to remove ①.
3. Remove the wiper blade.
4. Insert the new wiper blade onto the wiper arm until it clicks into place.



CAUTION:

- **After wiper blade replacement, return the wiper arm to its original position. Otherwise the wiper arm or the engine hood may be scratched and may cause damage when the engine hood is opened.**
- **Worn wiper blades can damage the windshield and impair driver vision.**

WINDOW WASHER FLUID

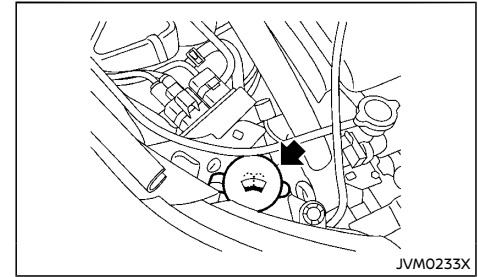

WARNING:

Anti-freeze is poisonous and should be stored carefully in marked containers out of the reach of children.







Fill the window washer fluid reservoir periodically. Add window washer fluid when the Low Washer Fluid warning appears on the vehicle information display.

To fill the fluid level, lift the cap off the reservoir and pour the window washer fluid into the reservoir opening.

Add a washer solvent to the water for better cleaning. In the winter season, add a windshield washer anti-freeze. Follow the manufacturer's instructions for the mixture ratio.

BATTERY

VEHICLE BATTERY

Caution symbols for battery		⚠ WARNING	
①		No smoking, No exposed flames, No sparks	Never smoke around battery. Never expose battery to open flames or electrical sparks.
②		Shield eyes	Handle the battery cautiously. Always wear eye protection glasses to protect against explosion or battery acid.
③		Keep away from children	Never allow children to handle battery. Keep the battery out of the reach of children.
④		Battery acid	Do not allow battery fluid to contact your skin, eyes, fabrics, or painted surfaces. After handling the battery or battery cap, immediately wash your hands thoroughly. If the battery fluid gets into your eyes, or onto your skin or clothing, flush with water immediately for at least 15 minutes and seek medical attention. Battery fluid is acid. If the battery fluid gets into your eyes or onto your skin, it could cause loss of your eyesight or burns.
⑤		Note operating instructions	Before handling the battery, read this instruction carefully to ensure correct and safe handling.
⑥		Explosive gas	Hydrogen gas, generated by battery fluid, is explosive.

SDI1573



WARNING:

Do not operate the vehicle if the fluid in the battery is low. Low battery fluid can cause a higher load on the battery which can generate heat, reduce battery life, and in some cases lead to an explosion.

Checking battery fluid level

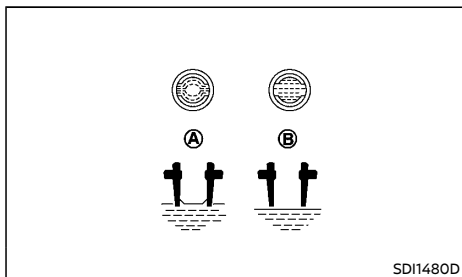
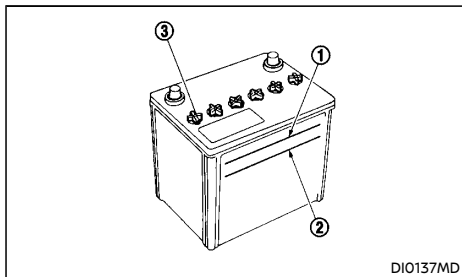

Check the fluid level in each cell. The battery fluid level should be between the UPPER LEVEL ① and LOWER LEVEL ② lines.

If it is necessary to add fluid, add only demineralized/distilled water to bring the level to the indicator in each filler opening. Do not overfill.

1. Remove the cell plugs ③ (if equipped) using a suitable tool.
2. Add demineralized/distilled water up to the UPPER LEVEL ① line.

If the side of the battery is not clear, check the distilled water level by looking directly

above the cell; the condition ④ indicates OK and the condition ③ needs more to be added.

3. Replace and tighten the cell plugs.
 - Vehicles operated in high temperatures or under severe conditions require frequent checks of the battery fluid level.
 - Keep the battery surface clean and dry. Clean the battery with a solution of baking soda and water.
 - Make certain the terminal connections are clean and securely tightened.
 - If the vehicle is not to be used for more than 30 days, disconnect the negative (-) battery terminal cable to prevent battery discharge.

Jump starting

If jump starting is necessary, see "Jump starting" (P.6-5). If the engine does not start by jump starting or the battery does not charge, the battery may have to be replaced. Contact a NISSAN dealer for replacing the battery.

INTELLIGENT KEY BATTERY

Battery replacement



CAUTION:

- **Be careful not to allow children to swallow the battery and removed parts.**
- **An improperly disposed battery can harm the environment. Always confirm local regulations for battery disposal.**
- **There is a danger of explosion if a lithium battery is incorrectly replaced. Replace only with the same or equivalent type.**

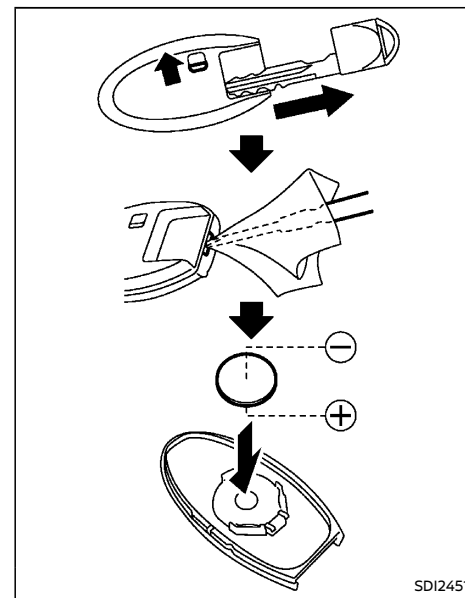

To replace the battery:

1. Remove the mechanical key from the Intelligent Key.
2. Insert a small flat-blade screwdriver into the slit of the corner and twist it to separate the upper part from the lower part. Use a cloth to protect the casing.
3. Replace the battery with a new one.

Recommended battery: CR2032 or equivalent

- Do not touch the internal circuit and electric terminals as doing so could cause a malfunction.
- Hold the battery by the edges. Holding the battery across the contact points will seriously deplete the storage capacity.
- Make sure that the + side faces as illustrated.

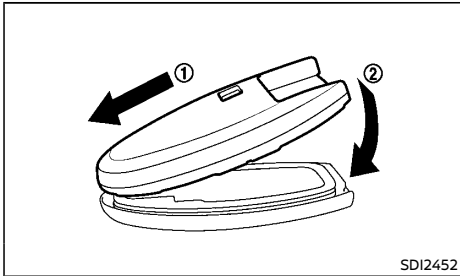

4. Close the lid securely as illustrated ① ②.
 5. Operate the buttons to check its operation.
- See a NISSAN dealer if you need assistance for replacement.

VARIABLE VOLTAGE CONTROL SYSTEM

The variable voltage control system measures the amount of electrical discharge from the battery and controls voltage generated by the alternator.



CAUTION:

- Do not ground accessories directly to the battery terminal. Doing so will bypass the variable voltage control system and the vehicle battery may not charge completely.
- Use electrical accessories with the engine running to avoid discharging the vehicle battery.

FUSES

ENGINE COMPARTMENT

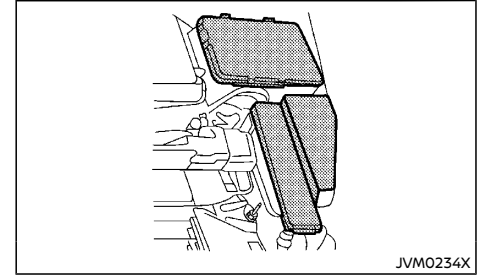

CAUTION:

Never use a fuse of a higher or lower amperage rating than that specified on the fuse box cover. This could damage the electrical system or cause a fire.

If any electrical equipment does not operate, check for an open fuse.

1. Be sure the ignition switch and the headlight switch are OFF.
2. Open the engine hood.
3. Remove the fuse box cover by pushing the tab and lifting the cover up.
4. Remove the fuse with the fuse puller. The fuse puller is located in the passenger compartment fuse box.

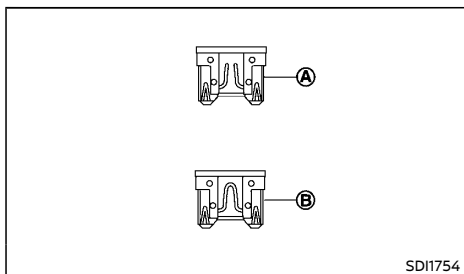

5. If the fuse is open (A), replace it with a new fuse (B).

If the new fuse also opens, after installing, have the electrical system checked, and if necessary repaired, by a NISSAN dealer.

Fusible links

If any electrical equipment does not operate and the fuses are in good condition, check the fusible links. If any of these fusible links are melted, replace only with genuine NISSAN parts.

PASSENGER COMPARTMENT

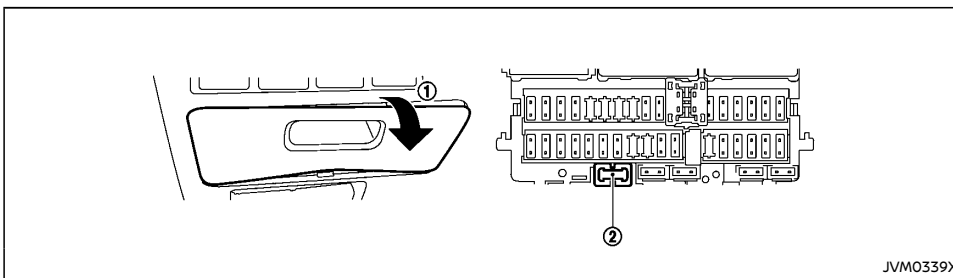

CAUTION:

Never use a fuse of a higher or lower amperage rating than that specified on the fuse box cover. This could damage the electrical system or cause a fire.

If any electrical equipment does not operate, check for an open fuse.

1. Be sure the ignition switch is in the "OFF" position.
2. Be sure the headlight switch is in the "OFF" position.
3. Pull the fuse box cover to remove ①
4. Remove the fuse with the fuse puller ②.

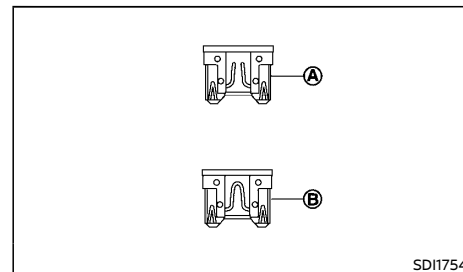

5. If the fuse is open (A), replace it with a new fuse (B).

If the new fuse also opens, after installing, have the electrical system checked, and if necessary repaired, by a NISSAN dealer.

Extended storage fuse switch (if equipped)

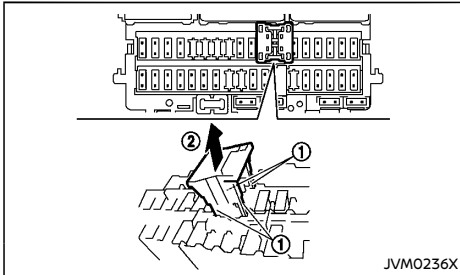

To reduce battery drain, the extended storage fuse switch comes from the factory switched off. Prior to delivery of your vehicle, the switch is pushed in (switched on) and should always remain on.

If the extended storage fuse switch is not pushed in (switched on), the "Transit Mode Reinsert Fuse" warning may appear on the vehicle information display. See "Vehicle information display warnings and indicators" (P.2-17).

If any electrical equipment does not operate, remove the extended storage fuse switch and check for an open fuse.

NOTE:

If the extended storage fuse switch malfunctions or if the fuse is open, it is not necessary to replace the switch. In this case, remove the extended storage fuse switch and replace it with a new fuse of the same rating.

How to remove the extended storage fuse switch:

1. To remove the extended storage fuse switch, be sure the ignition switch is in the OFF or LOCK position.
2. Be sure the headlight switch is in the OFF position.
3. Remove the fuse box cover.
4. Pinch the locking tabs ① found on each side of the storage fuse switch.
5. Pull the storage fuse switch straight out from the fuse box ②.

LIGHTS

HEADLIGHTS

Fog may temporarily form inside the lens of the exterior lights in the rain or in a car wash. A temperature difference between the inside and the outside of the lens causes the fog. This is not a malfunction. If large drops of water collect inside the lens, contact a NISSAN dealer.

Replacing LED headlight

If replacement is required, see your NISSAN dealer.

Replacing halogen headlight bulb

If bulb replacement is required, see your NISSAN dealer.



CAUTION:

- **Aiming is not necessary after replacing the bulb. When aiming adjustment is necessary, contact a NISSAN dealer.**
- **Do not leave the headlight assembly open without a bulb installed for a long period of time. Dust, moisture, smoke, etc. entering the headlight body may affect bulb performance. Remove the bulb from the headlight assembly just before a replacement bulb is installed.**
- **Only touch the base when handling the bulb. Never touch the glass envelope. Touching the glass could significantly affect bulb life and/or headlight performance.**
- **High pressure halogen gas is sealed inside the halogen bulb. The bulb may break if the glass envelope is scratched or the bulb is dropped.**

- **Use the same number and wattage as shown in the chart.**

EXTERIOR LIGHTS

Item	Wattage (W)
Headlight	
Low	LED
High	65
Front turn signal light	21
Front clearance light/Day-time running light	LED
Front fog light	55
Side turn signal light	LED
Rear combination light	
Turn signal	21
Stop/Tail light	LED
Reverse light	16
High-mounted stop light	LED
License plate light	5

See a NISSAN dealer for exterior lights replacement.

INTERIOR LIGHTS

Item	Wattage (W)
Front map light*	LED
Vanity mirror light	2
Rear personal light	8
Step light	3.4
Trunk light	3.4

*: See a NISSAN dealer for replacement.

LIGHT LOCATIONS

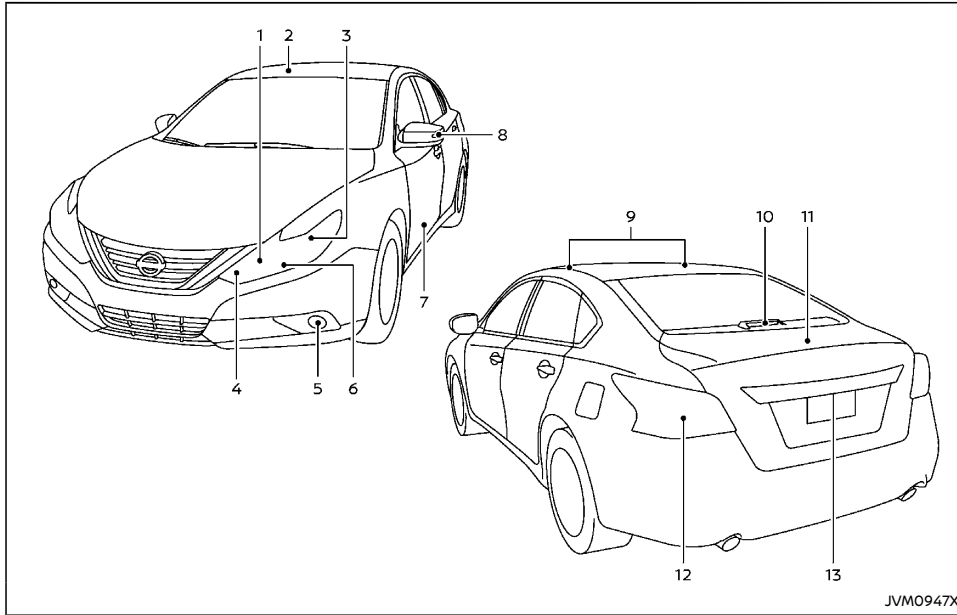

- | | |
|--|--|
| 1. Front turn signal light | 8. Side turn signal light |
| 2. Front map light | 9. Rear personal light |
| 3. Headlight (low-beam) | 10. High-mounted stop light |
| 4. Front clearance light/Daytime running light | 11. Trunk light |
| 5. Front fog light | 12. Rear combination light (turn signal/stop/tail/reverse light) |
| 6. Headlight (high-beam) | 13. License plate light |
| 7. Step light (front and rear) | |

Replacement procedures

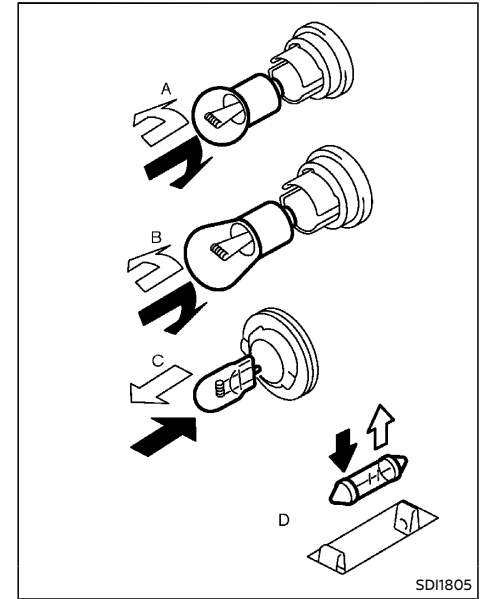

↖ REMOVE

↗ INSTALL

All other lights are either type A, B, C or D. When replacing a bulb, first remove the lens and/or cover.

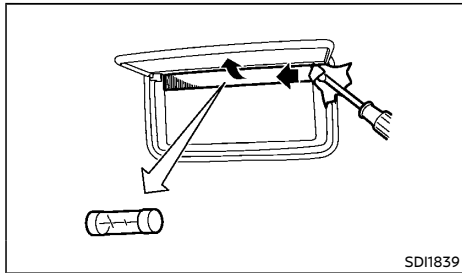

SDI1839

Vanity mirror light

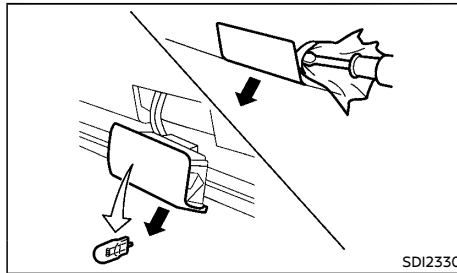

SDI2330

Step light

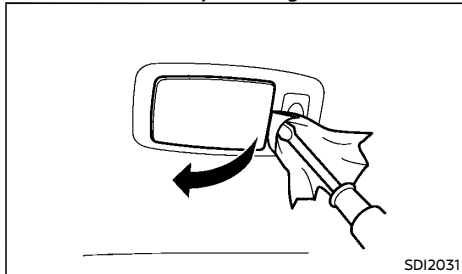

SDI2031

Rear personal light

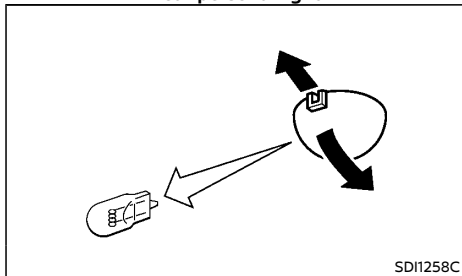

SDI1258C

Trunk light

TIRES AND WHEELS

If you have a flat tire, see "Flat tire" (P.6-2).

TIRE INFLATION PRESSURE

Periodically check the pressure of the tires, including the spare. An incorrect tire pressure may adversely affect tire life and vehicle handling. The tire pressure should be checked when tires are COLD. Tires are considered COLD after the vehicle has been parked for 3 or more hours, or driven less than 1.6 km (1 mile). COLD tire pressures are shown on the tire placard.

Insufficient pressure can lead to an overheating of the tire and subsequent internal damage. At high speeds, this could result in tread separation and even bursting of the tire.

TYPES OF TIRES



CAUTION:

When changing or replacing tires, be sure all four tires are of the same type (that is, summer, all season or snow) and construction. A NISSAN dealer may be able to help you with information about tire type, size, speed rating and availability.

Replacement tires may have a lower speed rating than the factory equipped tires, and they may not match the potential maximum vehicle speed. Never exceed the maximum speed rating of the tire.

All season tires

NISSAN specifies all season tires on some models to provide good performance all year, including snowy and icy road conditions. All season tires are identified by ALL SEASON and/or M&S on the tire sidewall. Snow tires have better snow traction than all season tires and may be more appropriate in some areas.

Summer tires

NISSAN specifies summer tires on some models to provide superior performance on dry roads. Summer tire performance is substantially reduced in snow and ice. Summer tires do not have the tire traction rating M&S on the tire sidewall.

If you plan to operate your vehicle in snowy or icy conditions, NISSAN recommends the use of snow or all season tires on all four wheels.

Snow tires

If snow tires are needed, it is necessary to select tires equivalent in size and load rating to the original equipment tires. If you do not, it can adversely affect the safety and handling of your vehicle.

Generally, snow tires have lower speed ratings than factory equipped tires and may not match the potential maximum vehicle speed. Never exceed the maximum speed rating of the tire. If you install snow tires, they must be the same size, brand, construction and tread pattern on all four wheels.

For additional traction on icy roads, studded tires may be used. However, some states and provinces prohibit their use. Check local, state and provincial laws before installing studded tires. Skid and traction capabilities of studded snow tires on wet or dry surfaces may be poorer than that of non-studded snow tires.

TIRE CHAINS



WARNING:

Tire chains/cables should not be installed on 18-inch size tires. Doing so will cause damage to the vehicle. If you plan to use tire chains/cables, you should install 16-inch size tires on your vehicle.

Use of tire chains may be prohibited according to location. Check the local laws before installing tire chains. When installing tire chains, make sure that they are of proper size for the tires on your vehicle and are installed according to the chain manufacturer's instructions.

Use chain tensioners when recommended by the tire chain manufacturer to ensure a tight fit. Loose end links of the tire chains must be secured or removed to prevent the possibility of whipping action damage to the fenders or underbody. If possible, avoid fully loading your vehicle when using tire chains. In addition, drive at a reduced speed. Otherwise, your vehicle may be damaged and/or vehicle handling and performance may be adversely affected.

Tire chains must be installed only on the front wheels and not on the rear wheels. Do not use the chains on dry roads.

Do not drive with tire chains on paved roads which are clear of snow. Driving with chains in such conditions can cause damage to the various mechanisms of the vehicle due to some overstress.

TIRE ROTATION

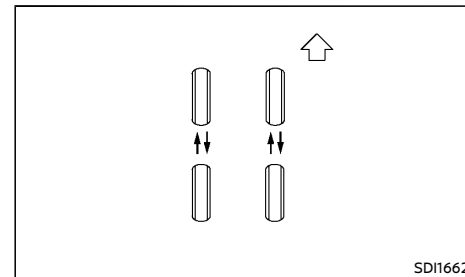

NISSAN recommends that tires be rotated every 10,000 km (6,000 miles). However, the timing for tire rotation may vary according to your driving habits and the road surface conditions. (See "Flat tire" (P.6-2) for the tire replacement.)



WARNING:

- **After rotating the tires, adjust the tire pressure.**
- **Retighten the wheel nuts when the vehicle has been driven for 1,000 km (600 miles) (also in cases of a flat tire, etc.).**
- **Do not include the spare tire in tire rotation.**
- **Incorrect tire selection, fitting, care, or maintenance can affect vehicle safety with risk of accident and injury. If in doubt, consult a NISSAN dealer or the tire manufacturer.**

TIRE WEAR AND DAMAGE

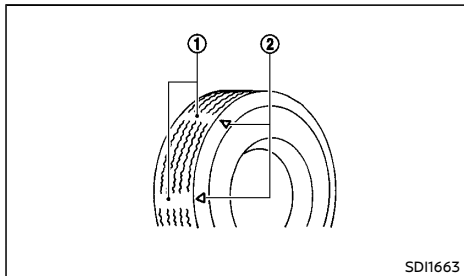

- ① Wear indicator
- ② Wear indicator location marks. The locations are shown by "Δ", "TWI", etc. depending on tire types.

Tires should be periodically inspected for wear, cracking, bulging or objects caught in the tread. If excessive wear, cracks, bulging or deep cuts are found, the tire should be replaced immediately.

The original tires have a built-in tread wear indicator. When the wear indicator is visible, the tire should be replaced.

Improper service of a spare tire may result in serious personal injury. If it is necessary to repair the spare tire, contact a NISSAN dealer.

TIRE AGE

Never use a tire over six years old, regardless of whether it has been used or not.

Tires degrade with age as well as with the vehicle usage. Have your tires checked and balanced often by a repair shop or, if you prefer, a NISSAN dealer.

CHANGING TIRES AND WHEELS



WARNING:

Do not install a deformed wheel or tire even if it has been repaired. Such wheels or tires could have structural damage and could fail without warning.

When replacing a tire, use the same size, speed rating and load carrying capacity as originally equipped. (See "Tires and wheels" (P.9-6) for recommended types and sizes of tires and wheels.) The use of tires other than those recommended or the mixed use of tires of different brands, construction (bias, bias-belted, or radial), or tread patterns can adversely affect the ride, braking, handling, ground clearance, body-to-tire clearance, snow chain clearance, speedometer calibration, headlight aim and bumper height. Some of these effects may lead to accidents and could result in serious personal injury.

If the wheels are changed for any reason, always replace with wheels which have the same offset dimension. Wheels of a different offset could cause early tire wear, possibly degraded vehicle handling characteristics and/or interference with the brake discs/drums. Such interference can lead to decreased braking efficiency and/or early brake pad/shoe wear.

WHEEL BALANCE

Unbalanced wheels may affect vehicle handling and tire life. Even with regular use, wheels can get out of balance. Therefore, they should be balanced as required.

SPARE TIRE

Conventional spare tire (if equipped)

A standard tire (the same size as the road wheels) is supplied with your vehicle.

MEMO

9 Technical information

Recommended fluids/lubricants and capacities	9-2	Vehicle identification	9-7
Fuel information	9-3	Vehicle identification plate (if equipped)	9-7
Recommended SAE viscosity number	9-3	Vehicle Identification Number (VIN)	9-7
Air conditioner system refrigerant and lubricant	9-4	Engine serial number	9-7
Engine	9-5	Tire placard	9-8
Tires and wheels	9-6	Air conditioner specification label	9-8
Dimensions	9-6	Installation of an RF transmitter	9-8
When travelling or registering in another country	9-7		



RECOMMENDED FLUIDS/ LUBRICANTS AND CAPACITIES

The following are approximate capacities. The actual refill quantities may be slightly different. When refilling, follow the procedures instructed in the "8. Maintenance and do-it-yourself" section to determine the proper refill capacity.

Fluid type			Capacity (approximate)			Recommended Fluids/Lubricants	
			Metric Measure	US Measure	Imperial Measure		
Fuel			65 L	17-1/8 gal	14-1/4 gal	· See "Fuel information" (P.9-3).	
Engine oil*1 Drain and refill "1": For additional information, see "Changing engine oil and oil filter" (P.8-8).	QR25DE	with oil filter change	4.6 L	4-7/8 qt	4 qt	<ul style="list-style-type: none"> · Genuine "NISSAN Motor Oil 5W-30 SN" is recommended. · If the above motor oil is not available, use "NISSAN Motor Oil" or equivalent that matches the following grade and viscosity. <ul style="list-style-type: none"> · Oil grade: API SM or SN, ILSAC GF-4 or GF-5 · SAE Viscosity: See "Recommended SAE viscosity number" (P.9-3). · Genuine "NISSAN Motor Oil 10W-30 SM or SN" is recommended. · If the above motor oil is not available, use "NISSAN Motor Oil" or equivalent that matches the following grade and viscosity. <ul style="list-style-type: none"> · Oil grade: API SL, SM or SN, ILSAC GF-3, GF-4 or GF-5 · SAE Viscosity: See "Recommended SAE viscosity number" (P.9-3). 	
		without oil filter change	4.3 L	4-1/2 qt	3-3/4 qt		
	MR20DE	with oil filter change	4.2 L	4-1/2 qt	3-3/4 qt		
		without oil filter change	4.0 L	4-1/4 qt	3-1/2 qt		
Engine coolant with reservoir	Total	QR25DE	8.1 L	8-5/8 qt	7-1/8 qt	<ul style="list-style-type: none"> · Genuine NISSAN Engine Coolant (blue) or equivalent · Use Genuine NISSAN Engine Coolant, or equivalent in its quality, in order to avoid possible aluminum corrosion within the engine cooling system caused by the use of non-genuine engine coolant. · Note that any repairs for the incidents within the engine cooling system while using non-genuine engine coolant may not be covered by the warranty even if such incidents occurred during the warranty period. · Genuine NISSAN CVT Fluid NS-3 · Use only Genuine NISSAN CVT Fluid NS-3. Using transmission fluid other than Genuine NISSAN CVT Fluid NS-3 will damage the CVT, which is not covered by the warranty. · Genuine NISSAN E-PSF or equivalent · Use of a power steering fluid other than Genuine NISSAN E-PSF will prevent the power steering system from operating properly. · Genuine NISSAN Brake Fluid, or equivalent DOT3 · NLGI No. 2 (Lithium soap base) · HFC-134a (R-134a) · NISSAN A/C System Oil Type S or exact equivalent 	
		MR20DE	8.4 L	8-7/8 qt	7-3/8 qt		
	Reservoir		0.75 L	3/4 qt	5/8 qt		
Continuously Variable Transmission (CVT) fluid			—	—	—		
Power Steering Fluid (PSF)			Refill to the proper fluid level according to the instructions in the "8. Maintenance and do-it-yourself" section.				
Brake fluid			—	—	—		
Multi-purpose grease			—	—	—		
Air conditioner system refrigerant			—	—	—		
Air conditioner system lubricants			—	—	—		

FUEL INFORMATION

Gasoline engine (model with three-way catalyst)



CAUTION:

Do not use leaded gasoline. Using leaded gasoline will damage the three-way catalyst.

For Thailand: Use Unleaded REGULAR gasoline or gasohol (up to E20*) with an octane rating of at least 91 (RON).

Except for Thailand: Use UNLEADED REGULAR gasoline with an octane rating of at least 91 (RON).

*: Gasohol is alcohol blended gasoline. For example, "E20" is a mixture of approximately 20% fuel ethanol and 80% unleaded gasoline.

RECOMMENDED SAE VISCOSITY NUMBER

Gasoline engine oil

QR25DE engine models:

5W-30 is preferable.

If 5W-30 is not available, select the viscosity, from the chart below, that is suitable for the outside temperature range.

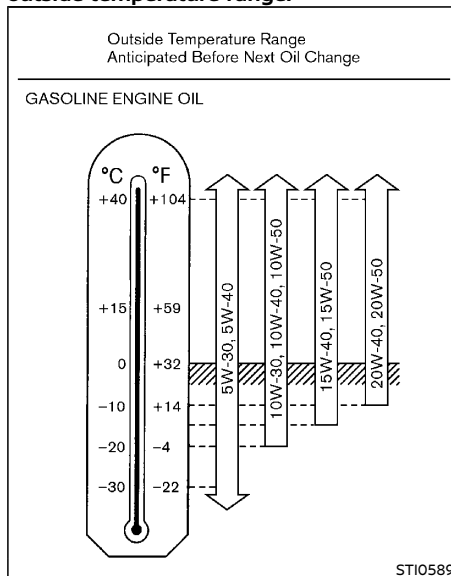

MR20DE engine models:

10W-30 is preferable.

If 10W-30 is not available, select the viscosity, from the chart below, that is suitable for the outside temperature range.

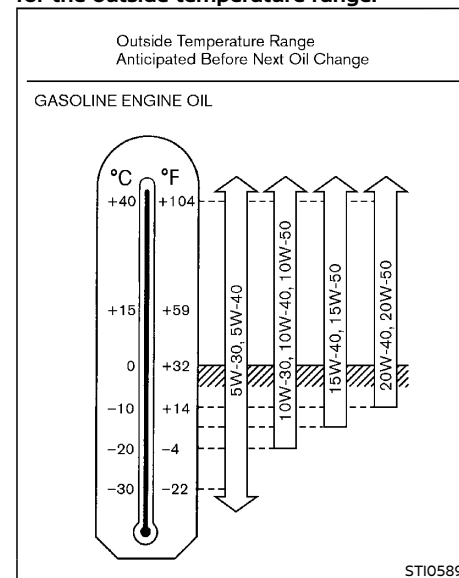

AIR CONDITIONER SYSTEM REFRIGERANT AND LUBRICANT

The air conditioner system of your vehicle must be charged with the refrigerant HFC-134a (R134a) and the lubricant NISSAN A/C System Oil Type S or equivalents. Use of any other refrigerants or lubricants will cause severe damage, and you may need to replace your vehicle's entire air conditioner system.

The release of refrigerants into the atmosphere is prohibited in many countries and regions. The refrigerant HFC-134a (R-134a) in your vehicle will not harm the Earth's ozone layer. However, it may contribute in a small part to the global warming effect. NISSAN recommends that the refrigerant be appropriately recovered and recycled. Contact a NISSAN dealer when servicing the air conditioner system.

ENGINE

Engine model		QR25DE	MR20DE	
Type		Gasoline, 4-cycle, DOHC	Gasoline, 4-cycle, DOHC	
Cylinder arrangement		4-cylinder, inline	4-cylinder, in-line	
Bore × Stroke	mm (in)	89.0 × 100.0 (3.504 × 3.937)	84.0 × 90.1 (3.307 × 3.547)	
Displacement	cm ³ (cu in)	2,488 (151.82)	1,997 (121.86)	
Idle speed	rpm	650±50	700±50	
Ignition timing (B.T.D.C.)	degree at idle	10°±5	9°±5	
Spark plugs				
	Type	Standard	FXE20HE11	LZKAR6AP-11
	Gap	mm (in)	1.1 (0.043)	1.1 (0.043)
Camshaft operation		Timing chain	Timing chain	

TIRES AND WHEELS

		Standard	Spare
Tire size		215/60R16 95V	215/60R16 95V
		235/45R18 98W	235/45R18 98W

		Size	Offset mm (in)
Road wheel	Aluminum	16 × 7J	50 (1.97)
		18 × 7.5J	55 (2.17)
Spare	Steel	16 × 7J	50 (1.97)
	Aluminum	18 × 7.5J	55 (2.17)

DIMENSIONS

		Unit: mm (in)
Overall length		4,875 (191.9)
Overall width		1,830 (72.0)
Overall height		1,485 (58.5)
Front tread		1,585 (62.4)
Rear tread		1,585 (62.4)
Wheelbase		2,775 (109.3)

WHEN TRAVELLING OR REGISTERING IN ANOTHER COUNTRY

When planning to travel in another country or region, find out whether the fuel required for your vehicle is available in that country or region. Using a low octane rated fuel may cause engine damage. Therefore, be sure that the required fuel is available wherever you go. For additional information regarding recommended fuel, see earlier in this section.

When transferring the registration of your vehicle to another country, state, province or district, contact the appropriate authorities to find out that the vehicle complies with the local legal requirements. In some cases, a vehicle cannot meet the legal requirements, and it may be necessary to modify the vehicle to meet local laws and regulations. In addition, there may be possibilities that a vehicle cannot be adapted in certain areas.

The laws and regulations for motor vehicle emission control and safety standards vary according to the country, state, province or district; therefore, the vehicle specification may differ.

When any vehicles are to be taken into another country, state, province or district, its modification, transportation, registration, and any other expenses which may result, are the responsibility of the user. NISSAN is not responsible for any inconveniences that may result.

VEHICLE IDENTIFICATION

It is prohibited to cover, paint, weld, cut, drill, alter or remove Vehicle Identification Number (VIN).

VEHICLE IDENTIFICATION PLATE (if equipped)

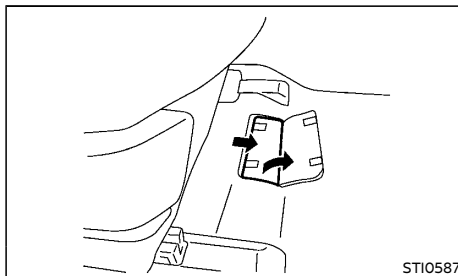

The plate is affixed under the front right-side seat as shown.

VEHICLE IDENTIFICATION NUMBER (VIN)

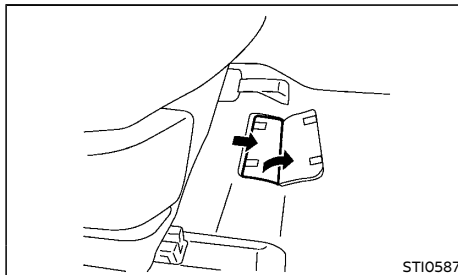

The vehicle identification number is stamped under the front right-side seat as shown.

ENGINE SERIAL NUMBER

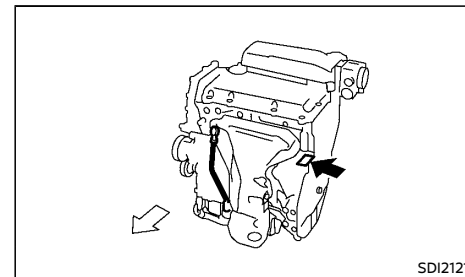

QR engine

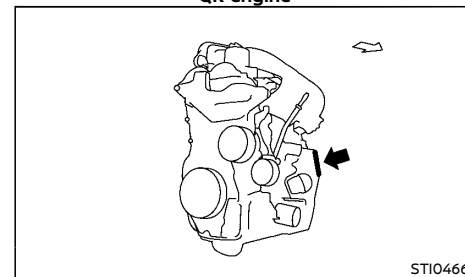

MR engine

The engine serial number is stamped on the engine as shown.

INSTALLATION OF AN RF TRANSMITTER

For countries conforming to UN regulation No.10 or equivalent:

The installation of an RF transmitter in your vehicle could affect electric equipment systems. Be sure to check with your NISSAN dealer for precautionary measures or special instructions regarding installation. Upon request, your NISSAN dealer will provide the detailed information (frequency band, power, antenna position, installation guide, etc.) regarding installation.

TIRE PLACARD

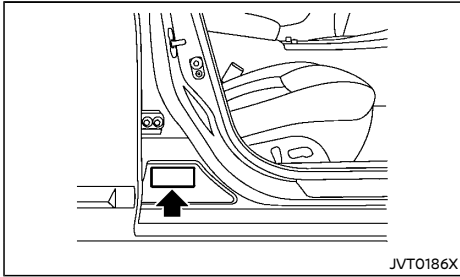

The cold tire pressures are shown on the tire placard affixed to the driver's side center pillar.

AIR CONDITIONER SPECIFICATION LABEL

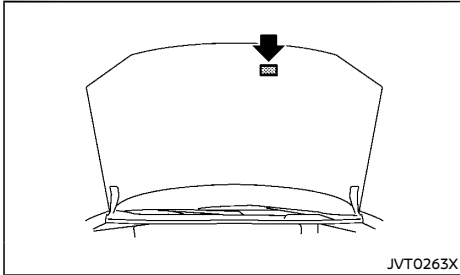

The air conditioner specification label is attached to the underside of the hood as shown.

MEMO

MEMO

10 Index

A

ABS (Anti-lock Braking System).....	5-24
Aiming control, Headlights.....	2-21
Air bag system	
Side (See supplemental side-impact air bag system).....	1-20, 1-25
Air conditioner	
Air conditioner operation.....	4-20
Air conditioner service.....	4-22
Air conditioner specification label.....	9-8
Antenna.....	4-29
Anti-lock Braking System (ABS).....	5-24
Anti-lock braking system (ABS) warning light.....	2-8
Appearance care	
Exterior appearance care.....	7-2
Interior appearance care.....	7-3
Armrest.....	1-6
Audible reminders.....	2-11
Audio operation precautions.....	4-23
Audio system.....	4-23
Automatic	
Drive positioner.....	3-23
Seat positioner.....	3-23
AUX (auxiliary) Input Jack.....	4-40

B

Battery.....	8-4, 8-16
Battery saver system.....	2-21, 2-32
Keyfob battery replacement.....	8-17
Variable voltage control system.....	8-18
Belts (See drive belts).....	8-9
Blind Spot Warning (BSW) system.....	5-12
Blind Spot Warning (BSW)/Lane Departure Warning (LDW) systems.....	5-12
Bluetooth® Hands-Free Phone System.....	4-42, 4-47

Bluetooth® streaming audio operation.....	4-34, 4-39
Brake	
Anti-lock Braking System (ABS).....	5-24
Brake booster.....	8-11
Brake fluid.....	8-12
Brake system.....	5-23
Parking brake check.....	8-11
Parking brake operation.....	5-26
Warning light.....	2-8
Break-in schedule.....	5-2
Brightness control, Instrument panel.....	2-6
Bulb check/instrument panel.....	2-8
Bulb replacement.....	8-2, 8-21

C

Catalytic converter, Three way catalyst.....	5-3
Checking lights.....	2-8
Child restraints.....	1-13
Child safety.....	1-10
Child safety rear door lock.....	3-5
Chimes, Audible reminders.....	2-11
Circuit breaker, Fusible link.....	8-19
Cleaning exterior and interior.....	7-2, 7-3
Clock settings.....	4-5, 4-30
Coat hook.....	2-30
Cockpit.....	2-2
Cold weather driving.....	5-25
Console box.....	2-28
Continuously Variable Transmission (CVT) fluid.....	8-12
Coolant	
Changing engine coolant.....	8-7
Checking engine coolant level.....	8-7
Corrosion protection.....	7-5
Cruise control.....	5-16
Cruise control operations.....	5-17
Cup holders.....	2-29

CVT, Driving with CVT (Continuously Variable Transmission).....	5-5
--	-----

D

Dimensions.....	9-6
Drive belts.....	8-9
Drive positioner.....	3-23
Driving	
Cold weather driving.....	5-25
Driving with CVT (Continuously Variable Transmission).....	5-5
Precautions when starting and driving.....	5-2
Dual zone automatic air conditioner.....	4-21

E

ECO mode system.....	5-19
Economy, Fuel.....	5-18
Engine	
Break-in schedule.....	5-2
Changing engine coolant.....	8-7
Checking engine coolant level.....	8-7
Checking engine oil level.....	8-7
Coolant temperature gauge.....	2-5
Engine block heater.....	5-26
Engine compartment check locations.....	8-5
Engine cooling system.....	8-6
Engine oil.....	8-7
Engine serial number.....	9-7
Engine specifications.....	9-5
If your vehicle overheats.....	6-7
Remote engine start.....	3-16
Entry/exit function, Automatic drive positioner.....	3-23
Exhaust gas (carbon monoxide).....	5-3

F

Flat tire.....	6-2
Floor mat cleaning.....	7-4
Fluid	
Brake fluid.....	8-12
Continuously Variable Transmission (CVT) fluid.....	8-12
Engine coolant.....	8-6
Engine oil.....	8-7
Power steering fluid.....	8-13
Window washer fluid.....	8-4, 8-15
FM-AM radio with Compact Disc (CD) player (models with navigation system) ...	4-35
FM-AM radio with Compact Disc (CD) player (models without navigation system).....	4-29
Fog light switch.....	2-22
Front seat, Front seat adjustment.....	1-2
Fuel	
Fuel economy.....	5-18
Fuel information.....	9-3
Fuel octane rating.....	9-3
Fuel-filler lid.....	3-19
Gauge.....	2-5
Fuel Efficiency and Carbon Dioxide Reduction driving tips.....	5-18
Fuses.....	8-18
Fusible links.....	8-19

G

Gauge.....	2-4
Engine coolant temperature gauge.....	2-5
Fuel gauge.....	2-5
Tachometer.....	2-5
General maintenance.....	8-2
Glove box.....	2-28

H

Hands-free phone.....	4-42, 4-47
Head restraints.....	1-6
Headlights	
Aiming control.....	2-21
Bulb replacement.....	8-21
Headlight switch.....	2-20
Heater	
Engine block heater.....	5-26
Heater and air conditioner operation.....	4-20
Hood lock release.....	3-17
Horn.....	2-24
Hydraulic pump electric power steering.....	5-23

I

Ignition switch (Push-button).....	5-4
Indicator	
Lights.....	2-10
Vehicle information display.....	2-11
Inside rearview mirror.....	3-20
Instrument brightness control.....	2-6
Intelligent Around View Monitor.....	4-10
Intelligent Key.....	3-2
Intelligent Key system.....	3-5
Key operating range.....	3-7
Warning signals.....	3-9
Interior lights.....	2-31
iPod player operation.....	4-33, 4-38
ISOFIX child restraint system.....	1-13

J

Jump starting.....	6-5
--------------------	-----

K

Keys.....	3-2
Intelligent Key system.....	3-5

L

Labels	
Air conditioner specification label.....	9-8
Engine serial number.....	9-7
Vehicle identification number (VIN).....	9-7
Lane Departure Warning (LDW) system.....	5-12
Light	
Bulb replacement.....	8-2, 8-21
Fog light switch.....	2-22
Headlight switch.....	2-20
Headlights bulb replacement.....	8-21
Indicator lights.....	2-10
Interior lights.....	2-31
Map lights.....	2-31
Rear personal lights.....	2-31
Replacement.....	8-2, 8-21
Trunk light.....	2-31
Vanity mirror light.....	2-31
warning/indicator lights and audible reminders.....	2-8
Lock	
Auto door lock releasing mechanism.....	3-4
Vehicle speed sensing door lock mechanism.....	3-4
Lock, Trunk lid.....	3-18
Low fuel warning light.....	2-9

M

Maintenance	
Battery.....	8-4, 8-16
General maintenance.....	8-2
Maintenance precautions.....	8-4
Maintenance requirements.....	8-2
Seat belt maintenance.....	1-12

Malfunction indicator light (MIL).....	2-10
Map lights.....	2-31
Map pockets.....	2-30
Master warning light.....	2-9
Mechanical key (Intelligent Key system).....	3-2
Memory storage, Automatic drive positioner.....	3-23
Meters and gauges.....	2-4
Instrument brightness control.....	2-6
Mirror	
Mirrors.....	3-20
Mirror, Vanity mirror.....	3-22
Moving Object Detection (MOD) function.....	4-16

N

New vehicle break-in.....	5-2
---------------------------	-----

O

Oil	
Checking engine oil level.....	8-7
Engine oil.....	8-7
Overheat, if your vehicle overheats.....	6-7

P

Parking	
Parking brake break-in.....	5-24
Parking brake operation.....	5-26
Parking sensor system.....	5-21
Power	
Power outlet.....	2-27
Power steering.....	5-23
Power steering fluid.....	8-13
Power windows.....	2-24
Precautions	
Audio operation.....	4-23
Cruise control.....	5-17
Maintenance.....	8-4

Seat belt usage.....	1-9
When starting and driving.....	5-2
Pre-tensioner seat belt system.....	1-23, 1-27
Push starting.....	6-7
Push-button ignition switch.....	5-4

R

Rain-sensing auto wiper system.....	2-23
Rear door lock, Child safety rear door lock.....	3-5
Rear personal lights.....	2-31
Rear seats.....	1-4
Rear sunshade.....	2-27
Rear view monitor.....	4-6
Remote engine start.....	3-16

S

Safety, Child seat belts.....	1-10
Seat adjustment, Front seats.....	1-2
Seat belt(s)	
Child safety.....	1-10
Injured persons.....	1-11
Precautions on seat belt usage.....	1-9
Pregnant women.....	1-11
Pre-tensioner seat belt system.....	1-23, 1-27
Seat belt cleaning.....	7-4
Seat belt maintenance.....	1-12
Seat belt warning light.....	2-9
Seat belts.....	1-9
Shoulder belt height adjustment.....	1-12
Seat(s)	
Driver-side memory.....	3-23
Seats.....	1-2
Servicing air conditioner.....	4-22
Shift lever	
Shift lock release.....	5-9
Shift lock release	
Transmission.....	5-9

Shifting, CVT (Continuously Variable Transmission).....	5-5
Shoulder belt height adjustment, For front seats.....	1-12
Side-impact air bag system.....	1-20, 1-25
Small light indicator light.....	2-10
SOURCE select switch.....	4-41
Spare tire.....	8-25
Spark plugs.....	8-10
Starting	
Jump starting.....	6-5
Precautions when starting and driving.....	5-2
Push starting.....	6-7
Steering	
Power steering fluid.....	8-13
Steering lock.....	5-6
Steering lock release malfunction indicator.....	2-20
Steering-wheel-mounted controls for audio.....	4-41
Tilting steering wheel.....	3-20
Sunglasses holder.....	2-29
Sunroof.....	2-26
Sunshade (rear).....	2-27
Supplemental side-impact air bag system.....	1-20, 1-25
Switch	
Fog light switch.....	2-22
Headlight aiming control.....	2-21
Headlight switch.....	2-20
Power door lock switch.....	3-4
Steering-wheel-mounted controls for audio.....	4-41
Turn signal switch.....	2-21

T

Tachometer.....	2-5
Temperature gauge, Engine coolant temperature gauge.....	2-5
Three-way catalyst.....	5-3

Tilting steering wheel.....	3-20
Tires	
Flat tire.....	6-2
Tire chains.....	8-24
Tire rotation.....	8-3, 8-24
Tires and wheels.....	8-23, 9-6
Types of tires.....	8-23
Towing, Tow truck towing.....	6-8
Transmission	
Continuously Variable Transmission (CVT) fluid.....	8-12
Driving with CVT (Continuously Variable Transmission).....	5-5
Transmission shift lever lock release.....	5-9
Trunk	
Light.....	2-31
Trunk lid.....	3-18
Trunk open request switch.....	3-19
Turn signal switch.....	2-21

U

Underbody cleaning.....	7-3
USB connection port.....	4-39
USB device operation.....	4-32, 4-37
Using remote keyless entry system.....	3-11

V

Vanity mirror.....	3-22
Vanity mirror light.....	2-31
Variable voltage control system.....	8-18
Vehicle	
Dimensions.....	9-6
Identification number (VIN).....	9-7
Speed sensing door lock mechanism.....	3-4
Vehicle Dynamic Control (VDC) system.....	5-10
Vehicle information display.....	2-11
Ventilators.....	4-19

W

Warning	
Lights.....	2-8
Vehicle information display.....	2-11
Warning lights, indicator lights and audible reminders.....	2-7
Warning light	
Anti-lock braking system (ABS) warning light.....	2-8
Brake warning light.....	2-8
Low fuel warning light.....	2-9
Seat belt warning light.....	2-9
Washer switch, Windshield wiper and washer switch.....	2-22
Washing.....	7-2
Waxing.....	7-2
Wheels and tires	
Care of wheels.....	7-3
Cleaning aluminum alloy wheels.....	7-3
Tires and wheels.....	8-23, 9-6
Window washer fluid.....	8-4, 8-15
Window(s)	
Cleaning.....	7-2, 7-4
Power windows.....	2-24
Windshield wiper and washer switch.....	2-22
Wiper	
Rain-sensing auto wiper system.....	2-23
Windshield wiper and washer switch.....	2-22
Wiper blades.....	8-14

MEMO

GAS STATION INFORMATION

FUEL INFORMATION

Gasoline engine (model with three-way catalyst)



CAUTION:

Do not use leaded gasoline. Using leaded gasoline will damage the three-way catalyst.

For Thailand: Use Unleaded REGULAR gasoline or gasohol (up to E20*) with an octane rating of at least 91 (RON).

Except for Thailand: Use UNLEADED REGULAR gasoline with an octane rating of at least 91 (RON).

*: Gasohol is alcohol blended gasoline. For example, "E20" is a mixture of approximately 20% fuel ethanol and 80% unleaded gasoline.

RECOMMENDED ENGINE OIL

See "Recommended fluids/lubricants and capacities" (P.9-2).

TIRE COLD PRESSURE

See the tire placard affixed to the driver's side center pillar.

QUICK REFERENCE

- In case of emergency ... 6-1
(Flat tire, engine will not start, overheating, towing)
- How to start the engine ... 5-1
- How to read the meters and gauges ... 2-1
- Maintenance and do-it-yourself ... 8-1
- Technical information ... 9-1