

2008 Owner's Manual

امداد خودرو فارما
SANTAFE
تلفن: ۰۲۱-۸۸۶۶۰۸۵

FarmaSOS.com



HYUNDAI

Drive your way™

A010A02A-AAT

WARRANTIES FOR YOUR HYUNDAI VEHICLE

Please consult your Owner's Handbook & Warranty Information booklet for your vehicle's specific warranty coverage.

امداد خودرو فارما
تلفن شبانه روزی: ۰۲۱-۸۸۶۲۰۸۵

A020A01A-AAT

RESPONSIBILITY FOR MAINTENANCE

The maintenance requirements for your new Hyundai are found in Section 5. As the owner, it is your responsibility to see that all maintenance operations specified by the manufacturer are carried out at the appropriate intervals. When the vehicle is used in severe driving conditions, more frequent maintenance is required for some operations. Maintenance requirements for severe operating conditions are also included in Section 5.

HYUNDAI



SANTAFE

امداد خودرو فارما

تلفن شبانه روزی: ۰۲۱-۸۸۶۲۰۸۵

FarmaSOS.com

OWNER'S MANUAL

A030A01A-AAT

**Operation
Maintenance
Specifications**

All information in the Owner's Manual is current at the time of publication. However, Hyundai reserves the right to make changes at any time as part of our policy of continual product improvement may be carried out.

This manual applies to all Hyundai models and includes descriptions and explanations of optional as well as standard equipment. As a result, you may find material in this manual that does not apply to your specific vehicle.

A070A01A-AAT



CAUTION: MODIFICATIONS TO YOUR HYUNDAI

Your Hyundai should not be modified in any way. Such modifications may adversely affect the performance, safety or durability of your Hyundai and may, in addition, violate conditions of the limited warranties covering the vehicle. Certain modifications may also be in violation of regulations established by the U.S. Department of Transportation and other federal or state agencies.

A080A01S-AAT

TWO-WAY RADIO OR CELLULAR TELEPHONE INSTALLATION

Your vehicle is equipped with electronic fuel injection and other electronic components. It is possible for an improperly installed/adjusted two-way radio or cellular telephone to adversely affect electronic systems. For this reason, we recommend that you carefully follow the radio manufacturer's instructions or consult your Hyundai dealer for precautionary measures or special instructions if you choose to install one of these devices.

تلفن شبانه روزی: ۰۲۱-۸۸۶۲۰۸۵

فونیکس ۲۰۰۸

SAFETY AND VEHICLE DAMAGE WARNING

This manual includes information titled as WARNING, CAUTION and NOTE.
These titles indicate the following:



WARNING:

This indicates that a condition may result in harm, serious injury or death to you or other persons if the warning is not heeded. Follow the advice provided with the warning.



CAUTION:

This indicates that a condition may result in damage to your vehicle or its equipment if the caution is not heeded. Follow the advice provided with the caution.

NOTE:

This indicates that interesting or helpful information is being provided.

VEHICLE DATA COLLECTION AND EVENT DATA RECORDERS

Your Hyundai vehicle is equipped with many high technology, electronically controlled systems that help to ensure your vehicle operates properly and provides the performance that you expect. These systems utilize computers to monitor the operation of various systems and components and help to control their operation. These computerized system operations are wide-ranging and involve components to reduce emissions, to continuously evaluate the readiness of the air bag and seat belt pretensioner systems, to determine when the air bag and seat belt pre-tensioner systems should be deployed and then to activate the deployment, and if equipped, to operate anti-lock braking, traction control and electrical stability control to assist the driver to control the vehicle in difficult driving situations. These systems electronically store information that is useful to service technicians when they need to diagnose and repair these systems. Additional information is stored only when a crash occurs that results in the deployment of the air bags or seat belt pre-tensioners. This type of data storage is done by devices called event data recorders(EDR).

After a crash event, the air bag and seat belt pre-tensioner computer system, known as the Supplemental Restraint System Control Module (SRSCM) or Air bag Control Unit (ACU), may record some information about the condition of the vehicle and how it was being operated. This information consists of data related to seat belt usage and if there was diagnostic information in the air bag or seat belt systems at the time that a crash occurred, and if the ACU sensed that a crash of sufficient severity occurred to require seat belt pre-tensioner or air bag deployment.

To retrieve this information, special equipment is needed and access to the vehicle or the device that stores the data is required. Hyundai will not access information about a crash event or share it with others except:

- o in response to an official request of police or similar government office, or
- o with the consent of the vehicle owner or, if the vehicle is leased, with the consent of the lessee,
or
- o as part of Hyundai's defense of litigation, or
- o as required by law.

FOREWORD

Thank you for choosing Hyundai. We are pleased to welcome you to the growing number of discriminating people who drive Hyundais. The advanced engineering and high-quality construction of each Hyundai we build is something of which we're very proud.

Your Owner's Manual will introduce you to the features and operation of your new Hyundai. It is suggested that you read it carefully because the information it contains can contribute greatly to the satisfaction you receive from your new car.

The manufacturer also recommends that all service and maintenance on your car be performed by an authorized Hyundai dealer. Hyundai dealers are prepared to provide high-quality service, maintenance and any other assistance that may be required.

A050A04A-AAT

HYUNDAI MOTOR COMPANY

Note: Because future owners will also need the information included in this manual, if you sell this Hyundai, please leave the manual in the vehicle for their use. Thank you.



CAUTION:

Severe engine and transaxle damage may result from the use of poor quality fuels and lubricants that do not meet Hyundai specifications. You must always use high quality fuels and lubricants that meet the specifications listed on Page 9-4 in the Vehicle Specifications section of the Owner's Manual and which also appear in the Service Station Information on the back cover of the Owner's Manual.

Copyright 2008 Hyundai Motor Company. All rights reserved. No part of this publication may be reproduced, stored in any retrieval system or transmitted in any form or by any means without the prior written permission of Hyundai Motor Company.

Guide to Hyundai Genuine Parts

1. What are Hyundai Genuine Parts?

Hyundai Genuine Parts are the same parts used by Hyundai Motor Company to manufacture vehicles. They are designed and tested for the optimum safety, performance, and reliability to our customers.

2. Why should you use genuine parts?

Hyundai Genuine Parts are engineered and built to meet rigid manufacturing requirements. Using imitation, counterfeit or used salvage parts is not covered under the Hyundai New Vehicle Limited Warranty or any other Hyundai

warranty. In addition, any damage to or failure of Genuine Hyundai Parts caused by the installation or failure of an imitation, counterfeit or used salvage part is not covered by any Hyundai Warranty.

3. How can you tell if you are purchasing Hyundai Genuine Parts?

Look for the Hyundai Genuine Parts Logo on the package (see below).

Hyundai Genuine Parts exported to the United States are packaged with labels written only in English.

تلفن شبانه روزی: ۰۲۱-۸۸۶۲۰۸۵

Hyundai Genuine Parts are only sold through authorized Hyundai Dealerships.



A100A01L



A100A02L

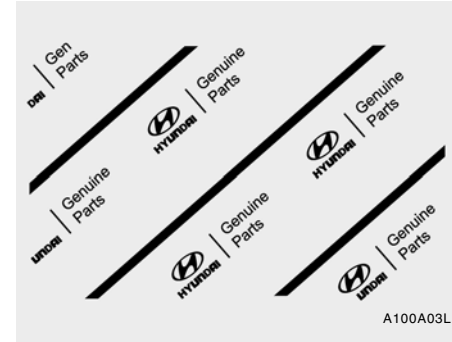

A100A03L

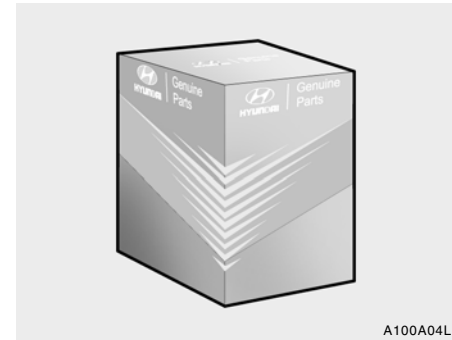

A100A04L

TABLE OF CONTENTS

SECTION

FEATURES OF YOUR HYUNDAI	1
DRIVING YOUR HYUNDAI	2
WHAT TO DO IN AN EMERGENCY	3
CORROSION PREVENTION & APPEARANCE CARE	4
VEHICLE MAINTENANCE REQUIREMENTS	5
DO-IT-YOURSELF MAINTENANCE	6
EMISSION CONTROL SYSTEMS	7
CONSUMER INFORMATION, REPORTING SAFETY DEFECTS & BINDING ARBITRATION OF WARRANTY CLAIMS	8
VEHICLE SPECIFICATIONS	9
INDEX	10

INSTRUMENTS AND CONTROLS

B250A01CM-AAT

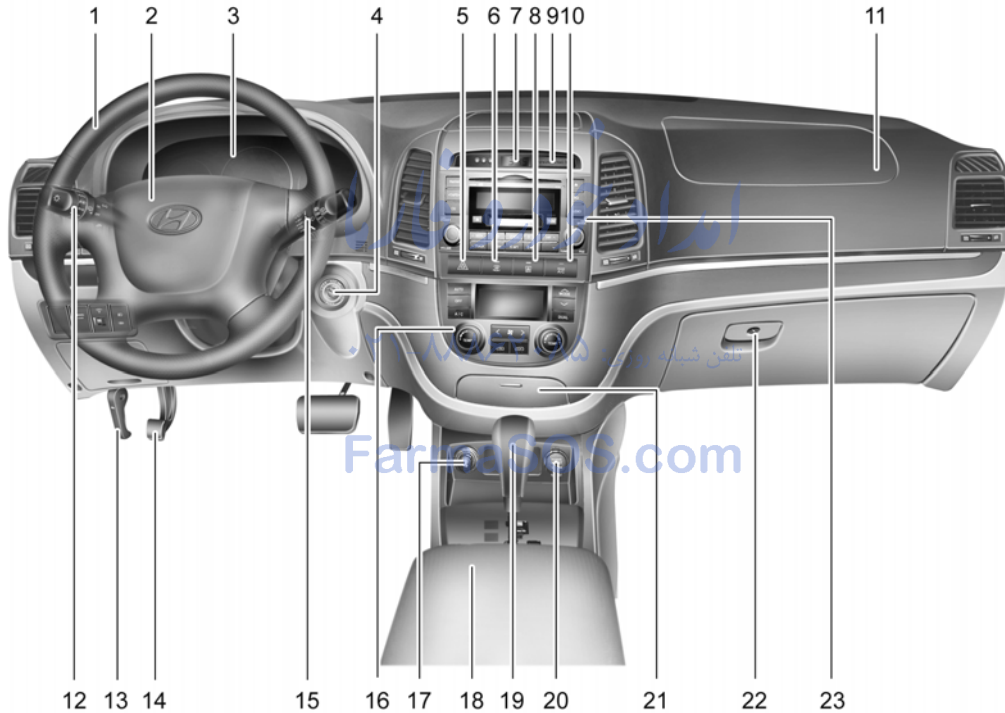

1. Steering Wheel	1-118	13. Hood Release Lever	1-115
2. Horn and Driver's Air bag	1-119, 1-44	14. Parking Brake Pedal (If installed)	1-108
3. Instrument Cluster	1-62	15. Windshield Wiper/Washer Switch	1-78
4. Ignition Switch	1-7	16. Heating/Air Conditioning Control Panel	1-125
5. Hazard Warning Switch	1-83	17. Cigarette Lighter	1-85
6. Front Window Defroster Switch	1-141	18. Center Console Box	1-96
7. Digital Clock	1-84	19. Shift Lever (If installed)	2-10
8. Rear Window Defroster Switch (If installed)	1-83	20. Power Outlet	1-86
9. Passenger Air bag Off Indicator	1-52	21. Ashtray	1-85
10. Rear Air Conditioning Switch (If installed)	1-141	22. Glove Box	1-95
11. Passenger's Air bag	1-51	23. Audio System (If installed)	1-147
12. Multi-Function Light Switch	1-75		























FarmaSOS.com



CAUTION:

When installing a container of liquid air freshener inside the vehicle, do not place it near the instrument cluster nor on the instrument panel surface. If there is any leakage from the air freshener onto these areas (Instrument cluster, instrument panel or air ventilator), it may damage these parts. If the liquid from the air freshener does leak onto these areas, wash them with water immediately.

INDICATOR SYMBOLS ON THE INSTRUMENT CLUSTER

	Turn Signal Indicator Lights		Malfunction Indicator Light
	ABS Service Reminder Indicator		Cruise Indicator Light
	Electronic Stability Control (ESC) Indicator Lights		Cruise SET Indicator Light
	High Beam Indicator Light		AWD System Warning Light
	Low Oil Pressure Warning Light		AWD Lock Indicator Light
	Parking Brake/Brake Fluid Level Warning Light		Immobilizer Warning Light (If Installed)
	Charging System Warning Light		Low Windshield Washer Fluid Level Warning Light
	Door Ajar Warning Light		Seat Belt Warning Light
	Tail Gate Open Warning Light		TPMS (Tire pressure monitoring system) malfunction indicator
	Low Fuel Level Warning Light		Low tire pressure telltale
	SRS (Air bag) Service Reminder Indicator (SRI)		Low tire pressure position telltale

F10 * More detailed explanations of these items will be found beginning on page 1-64.

FEATURES OF YOUR HYUNDAI

Fuel Recommendations	1-2
Breaking in Your New Hyundai	1-3
Keys	1-3
Door	1-7
Power Windows	1-14
Seats	1-16
Seat Belts	1-27
Child Restraint System	1-33
Supplemental Restraint (AIR BAG) system	1-44
Instrument Cluster and Indicator Lights	1-62
Warning and Indicator Lights	1-64
Multi-Function Light Switch	1-75
Windshield Wiper and Washer Switch	1-78
Sunroof	1-89
Mirror	1-97
Luggage Compartment	1-109
Hood Release	1-115
Cruise Control	1-120
Heating and Cooling Control	1-125
Antenna	1-142
Stereo Sound System	1-144
Audio System	1-147

FUEL RECOMMENDATIONS

B010A01CM-AAT

Use Unleaded Gasoline

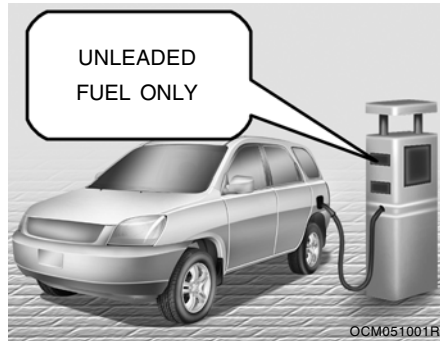

Unleaded gasoline with a Pump Octane Rating of 87 (Research Octane Number 91) or Higher must be used. For improved vehicle Performance, premium unleaded gasoline with Pump Octane Rating of 91 (RON 95) or higher is recommended.



WARNING:

- o Do not "top off" after the nozzle automatically shuts off when refueling.
- o Tighten the cap until it clicks, otherwise the "CHECK" light will illuminate.
- o Always check that the fuel cap is installed securely to prevent fuel spillage in the event of an accident.

B010B01A-AAT

What About Gasohol?

Gasohol (a mixture of 90% unleaded gasoline and 10% ethanol or grain alcohol) may be used in your Hyundai. However, if your engine develops driveability problems, the use of 100% unleaded gasoline is recommended. Fuels with unspecified quantities of alcohol, or alcohols other than ethanol, should not be used.

B010C01A-AAT

Use of MTBE

Hyundai recommends that fuels containing MTBE (Methyl Tertiary Butyl Ether) over 15.0% vol. (Oxygen Content 2.7% weight) should not be used in your Hyundai.

Fuel containing MTBE over 15.0% vol. (Oxygen Content 2.7% weight) may reduce vehicle performance and produce vapor lock or hard starting.

B010D01A-AAT

Do Not Use Methanol

Fuels containing methanol (wood alcohol) should not be used in your Hyundai. This type of fuel can reduce vehicle performance and damage components of the fuel system.



CAUTION:

Your Hyundai's New Vehicle Limited Warranty may not cover damage to the fuel system and any performance problems that are caused by the use of fuels containing methanol or fuels containing MTBE (Methyl Tertiary Butyl Ether) over 15.0% vol. (Oxygen Content 2.7% weight.)

B010E01A-AAT

Gasolines for Cleaner Air

To help contribute to cleaner air, Hyundai recommends that you use gasolines treated with detergent additives, which help prevent deposit formation in the engine. These gasolines will help the engine run cleaner and enhance performance of the Emission Control System.

B010F01A-AAT

Operation in Foreign Countries

If you are going to drive your Hyundai in another country, be sure to:

- o Observe all regulations regarding registration and insurance.
- o Determine that acceptable fuel is available.

BREAKING IN YOUR NEW HYUNDAI

B020A01S-AAT

During the First 1,200 Miles (2,000 Km)

No formal "break-in" procedure is required with your new Hyundai. However, you can contribute to the economical operation and durability of your Hyundai by observing the following recommendations during the first 1,200 miles (2,000 km).

- o Don't drive faster than 55 MPH (88 km/h).
- o While driving, keep your engine speed (rpm, or revolutions per minute) between 2,000 rpm and 4,000 rpm.
- o Use moderate acceleration. Don't start quickly or depress the accelerator pedal fully.
- o For the first 200 miles (300 km), try to avoid hard stops.
- o Don't lug the engine (in other words, don't drive so slowly in too high a gear that the engine "bucks"-shift to a lower gear).
- o Whether going fast or slow, vary your speed from time to time.
- o Don't let the engine idle longer than 3 minutes at one time.
- o Don't tow a trailer during the first 1,200 miles (2,000 km) of operation.

KEYS

B030A01A-AAT



OMC025001

For greater convenience, the same key operates all the locks in your Hyundai. However, because the doors can be locked without a key, carrying a spare key is recommended in case you accidentally lock one key inside the car.

IMMOBILIZER SYSTEM

B030B01NF-GAT

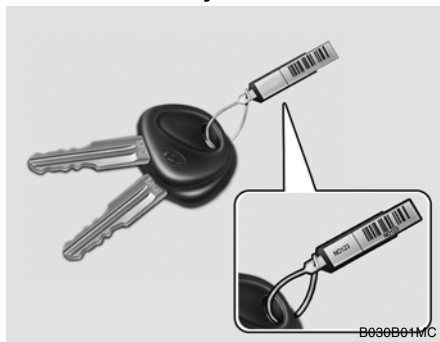
Record Your Key Number

A code number is attached on the number tag that came with the keys to your Hyundai. This key number tag should not be left with the keys but kept in a safe place, not in the vehicle. The key number should also be recorded in a place where it can be found in an emergency.

If you need additional keys, or if you should lose your keys, your authorized Hyundai dealer can make new keys if you can supply the key number.

B880A01TG-AAT

(If Installed)

The immobilizer system is an anti-theft device, designed to deter automobile theft.

NOTE:

This device complies with Part 15 of the FCC rules. Operation is subject to the following two conditions:

(1) This device may not cause harmful interference, and (2) this device must accept any interference received, including interference that may cause undesired operation.

**CAUTION:**

Changes or modifications not expressly approved by the party responsible for compliance could void the user's authority to operate the equipment.

B880B03MC-GAT

Keys

All of the locks fitted to the vehicle are operated by the same key. However, since it is possible to lock the doors without the use of the key, care should be exercised to ensure that the key does not become locked inside the vehicle by mistake.

NOTE:

If you make your own duplicate key, you will not be able to cancel the system or start the engine.

**CAUTION:**

- o When starting the engine, do not use the key with other immobilizer keys around. Otherwise the engine may not start or may stop soon after it starts.
Keep each keys separately not to have any malfunction after you receive your new vehicle.
- o Do not install the metal accessories near the key or ignition switch.
The engine may not start for the metal accessories may interrupt the transponder signal from normally transmitting.

**WARNING:**

In order to prevent theft of your vehicle, do not leave spare keys anywhere in your vehicle. Your immobilizer password is a customer unique password and should be kept confidential. Do not leave this number anywhere in your vehicle.

B880C01NF-GAT

Key Numbers

The vehicle key number is recorded on a number tag attached to the keys when the vehicle is first delivered to you.

The key number should be recorded and kept in a safe place in case the need to order further keys arises. New keys are available from any Hyundai dealer by quoting the relevant key number.

In the interest of security, the number tag attached to the keys which bears the key number should be removed from the key string after you receive your new vehicle. In addition, key numbers cannot be provided by Hyundai for security reasons.

If you need additional keys or if you should lose your keys, your authorized Hyundai dealer can make new keys if you can supply the key number and master key.

B880D01CM-AAT

"Limp Home" Mode and Related Procedures

Immobilizer warning indicator



HNF2011

If the immobilizer warning indicator blinks for five seconds when the ignition key is turned to the "ON" position, this indicates the immobilizer system requires service. The engine cannot be started without using the procedure below.

The following procedure describes how to start the engine using the limp home function (0, 1, 2, 3 as a sample password).

NOTE:

You can get a limp home password when the vehicle is first delivered to you. If you do not have a password, consult your authorized Hyundai dealer.

1. To activate the password, turn the ignition key "ON" and "OFF" according to the digit numbers. The immobilizer indicator will blink along with the operation of the ignition key. For example, turn the ignition key once for digit number "1", and twice for "2", and so on. For the digit number "0", you must cycle the ignition key 10 times.
2. Wait for 3~10 seconds. *تلفن شبانه روزی:*
3. You may set the remaining number of digits by following steps 1 and 2.
4. If all of the four password digits have been successfully entered, turn the ignition key "ON" and check that the immobilizer indicator illuminates. From this time, you have to start your engine within 30 seconds. If you try to start your engine after 30 seconds, your engine will not start.

NOTE:

If the engine stalls while driving in the "limp home" mode, you can start your engine within 2.5 seconds without re-entering the password.

If the immobilizer indicator blinks for five seconds, you must re-enter the password (steps 1~4).

After performing the limp home activation procedure, consult with your authorized Hyundai dealer as soon as possible.



CAUTION:

- o If the password is entered incorrectly three consecutive times, wait for about one hour to perform the limp home activation procedure again.
- o If you cannot start your engine using the limp home activation procedure, have your vehicle towed by an authorized Hyundai dealer.

DOOR LOCKS

B030C01CM-AAT

**Illuminated Ignition Switch
(If installed)**

B030C01E-1

Whenever either front door is opened, the ignition switch will be illuminated for your convenience, provided the ignition switch is not in the "ON" position.

The light will go off approximately 30 seconds after closing the door or when the ignition switch is turned on.

B040A01CM-AAT

! **WARNING:**

- o Unlocked doors can be dangerous. Before you drive away (especially if there are children in the car), be sure that all the doors are securely closed and locked so that the doors cannot be opened from the inside.
- o Before opening the door, always look for and avoid oncoming traffic.

تلفن شبانه روزی: ۰۲۱-۸۸۶۲۰۸۵

FarmaSOS.com

B040B01O-AAT

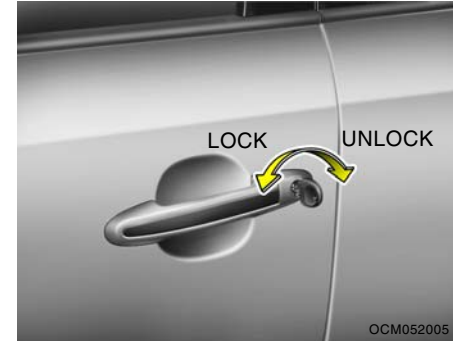
**Locking, unlocking front doors
with a key**

OCM052005

- o The door can be locked or unlocked with a key.
- o Lock the door by turning the key toward the front of the vehicle and unlock it by turning the key toward the rear.

NOTE:

The driver's door can be unlocked by turning the key once toward the rear. If you wish to unlock all doors, turn the key again toward the rear within 4 seconds.

B040C02Y-AAT

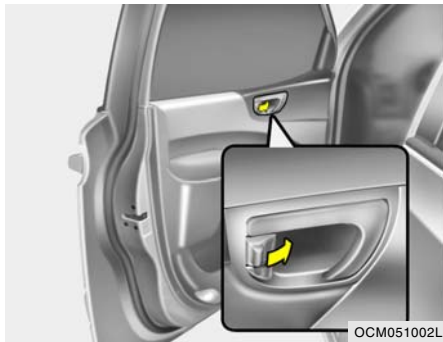
Locking from the Outside

The doors can be locked without a key. To lock the doors from the outside, first push the inside lock switch to the "LOCK" position, so that the red mark on the switch is not visible, then close the door.

The door will not lock if the key is left in the ignition switch when the front doors are closed. This is normal operation.

NOTE:

- o When locking the door this way, be careful not to lock the door with the key left in the vehicle.
- o To discourage theft, always remove the ignition key, close all windows and lock all doors when leaving your vehicle unattended.

امداد خودرو فارما

تلفن شبانه روزی: ۰۲۱-۸۸۶۲۰۸۵

FarmaSOS.com

B040D01NF-AAT

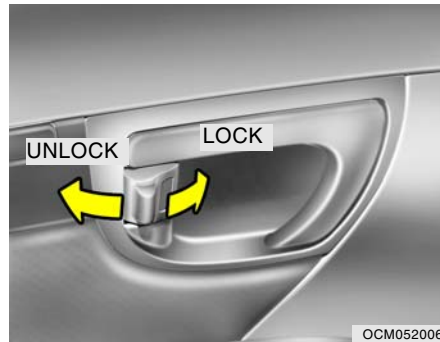
Locking from the Inside

To lock the doors from the inside, simply close the door and push the lock switch to the "LOCK" position.

NOTE:

- o When the door is locked, the red mark on the switch is not visible.
- o The driver's and front passenger's doors can be opened by pulling the inside door handle even if the inside lock switch is pushed to the "LOCK" position.

**WARNING:**

Be careful not to pull the inside door handle while driving. If you pull the inside door handle, the door can be opened and you may be ejected from the vehicle and can be injured or killed.

B040E04A-AAT

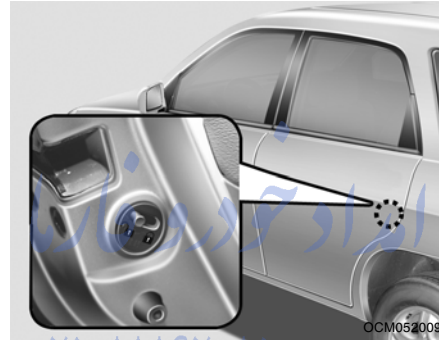
Child-Protector Rear Door Lock

Your Hyundai is equipped with left and right side "child-protector" rear door locks. When the lock mechanism is engaged, the rear door cannot be opened from the inside. Its use is recommended whenever there are small children in the rear seat.

To engage the child-protector feature so that the door cannot be opened from the inside, move the child-protector lever to the "🔒" position and close the door. Move the lever to the "🔓" position when normal door operation is desired.

To open the door from the outside, pull the outside door handle.

B040G01CM-AAT

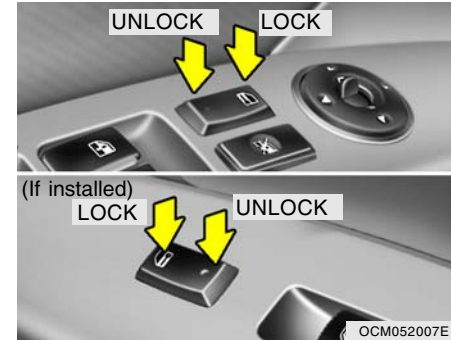
Central Door Locks

The central door locking switch is located on the driver's and front passenger's (if installed) armrest. It is operated by depressing the door lock switch. If any door is open when the switch is depressed to the "LOCK" position, the door will remain locked when closed.

NOTE:

- o Depressing the front portion of the driver's or front passenger's door lock switch "will lock", all vehicle doors.
- o Depressing the rear portion of these switches "will unlock", all vehicle doors.

- o The driver's and front passenger's doors can be opened by pulling the inside door handle even if the front portion of the driver's or front passenger's central door locking switch has been depressed to lock the doors.

**WARNING:**

- o Be careful not to pull the inside door handle while driving. If you pull the inside door handle, the door can be opened and you may be ejected from the vehicle and can be injured or killed.
- o If the door is locked/unlocked multiple times in rapid succession with either the vehicle key or door lock switch, the system may stop operating temporarily in order to protect the circuit and prevent damage to system components.

B070F01CM-AAT

Keyless Entry System (If installed)**NOTE:**

This device complies with Part 15 of the FCC rules. Operation is subject to the following two conditions:

(1) This device may not cause harmful interference, and (2) this device must accept any interference received, including interference that may cause undesired operation.

**CAUTION:**

تلفن شبانه روزی: ۸۵
Changes or modifications not expressly approved by the party responsible for compliance could void the user's authority to operate the equipment.

Locking doors

1. Close all doors.
2. Push the "LOCK ()" button on the transmitter.
3. At the same time all doors lock, the turn signal lights will blink once to indicate that the system is armed.

Unlocking doors

1. Push the "UNLOCK ()" button on the transmitter.
2. At the same time the driver's door unlocks, the turn signal lights will blink twice to indicate that the system is disarmed.

NOTE:

If you wish to unlock all doors, press the "UNLOCK" button on the transmitter again within 4 seconds.

THEFT-ALARM SYSTEM

NOTE:

The transmitter will not work if any of following occur:

- The ignition key is in ignition switch.
- You exceed the operating distance limit (10 m).
- The battery in the transmitter is weak.
- Other vehicles or objects may be blocking the signal.
- The weather is extremely cold.
- The transmitter is close to a radio transmitter such as a radio station or an airport which can interfere with normal operation of the transmitter.

When the transmitter does not work correctly, open and close the door with the ignition key. If you have a problem with the transmitter, contact an authorized Hyundai Dealer.

NOTE:

Keep the transmitter away from water or any liquid. If the keyless entry system is inoperative due to exposure to water or liquids, it will not be covered by your manufacturer vehicle warranty.

B070A01A-AAT

(If installed)

This system is designed to provide protection from unauthorized entry into the car. This system is operated in three stages : the first is the "Armed" stage, the second is the "Alarm" stage and the third is the "Disarmed" stage. If triggered, the system provides an audible alarm with blinking of the turn signal lights.

B075B01CM-AAT

Armed Stage

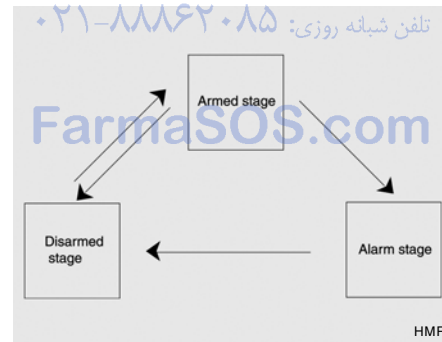

Park the car and stop the engine. Arm the system as described below.

- 1) Remove the ignition key from the ignition switch.
- 2) Make sure that the hood and tail gate are closed and latched.
- 3) Lock the doors using the transmitter of the keyless entry system or key or central door lock switch.

After completion of the steps above, the turn signal lights will blink once and the system will be armed after 30 seconds.

The system can also be armed by locking the doors with the key; however, the turn signal lights are not operated.

If any door, tailgate or engine hood is opened within 30 seconds after entering the armed stage, the system is disarmed to prevent unnecessary alarm.

NOTE:

If any door, tailgate or engine hood remains open, the system will not be armed. If all doors, tailgate and engine hood are closed, after pressing the "Lock" button on the transmitter, the turn signal lights blink once indicating the system is armed.

NOTE:

If the "LOCK" button is pressed once more within 4 seconds after pushing the "LOCK" button on the transmitter, the siren will sound once to indicate that the system is armed.

**CAUTION:**

Do not arm the system until all passengers have left the car. If the system is armed while a passenger(s) remains in the car, the alarm may be activated when the remaining passenger(s) leaves the car.

B075C01CM-AAT

Alarm Stage

The alarm will be activated if any of the following occurs while the car is parked and the system is armed.

- 1) A front or rear door is opened without using the transmitter or the ignition key.
- 2) The tail gate is opened without using the transmitter.
- 3) The engine hood is opened.

The siren will sound and the turn signal lights will blink continuously for about 30 seconds (This will repeat 3 times). To turn off the system, unlock the door or tail gate using the transmitter or the ignition key.

**CAUTION:**

Avoid trying to start the engine while the system is armed.

B075D01CM-AAT

Disarmed Stage

If the following conditions are met, the system will be disarmed.

- o When the doors are unlocked with the transmitter or the ignition key.
 - After depressing unlock button, you must open the doors within 30 seconds or all doors will automatically lock again and theft-alarm system will be armed.
- o When the ignition switch is in the "ON" position.

The turn signal lights will blink twice when the door is unlocked with the transmitter.

The alarm will be deactivated when:

- o The lock/unlock button on the transmitter is pressed.
- o The doors are unlocked with the ignition key.
- o The ignition switch is in the "ON" position for 30 seconds.

NOTE:

When the system is disarmed while the "DOOR" button of the interior light is depressed, the interior light will illuminate for 30 seconds.

B070E01CM-AAT
Panic Warning

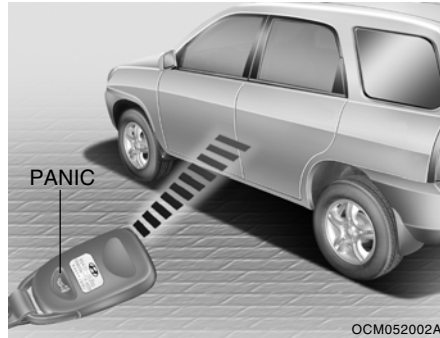

1. Push the "PANIC" button on the back-side of the transmitter.
2. At the same time, the alarming horn will sound and the turn signal lights will blink continuously for 30±3 seconds.
3. To turn off the system, push any button on the transmitter.

B070E01CM-AAT
Replacing the battery

When the transmitter's battery begins to get weak, it may take several pushes on the button to lock or unlock the doors, and the LED will not light. Replace the battery as soon as possible.

Battery type : CR2032

Replacement instructions:



1. Carefully separate the case with a coin as shown in the illustration.

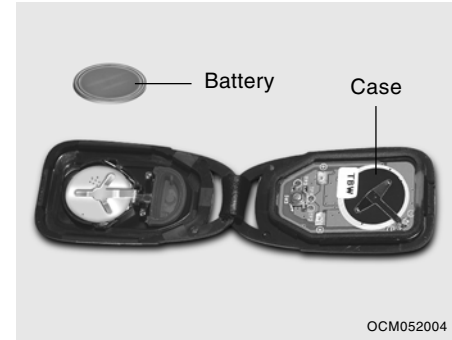

2. Remove the old battery from the case and note the polarity. Make sure the polarity of the new battery is the same (+side facing down), then insert it in the transmitter.

WINDOWS

B060D01NF-GAT

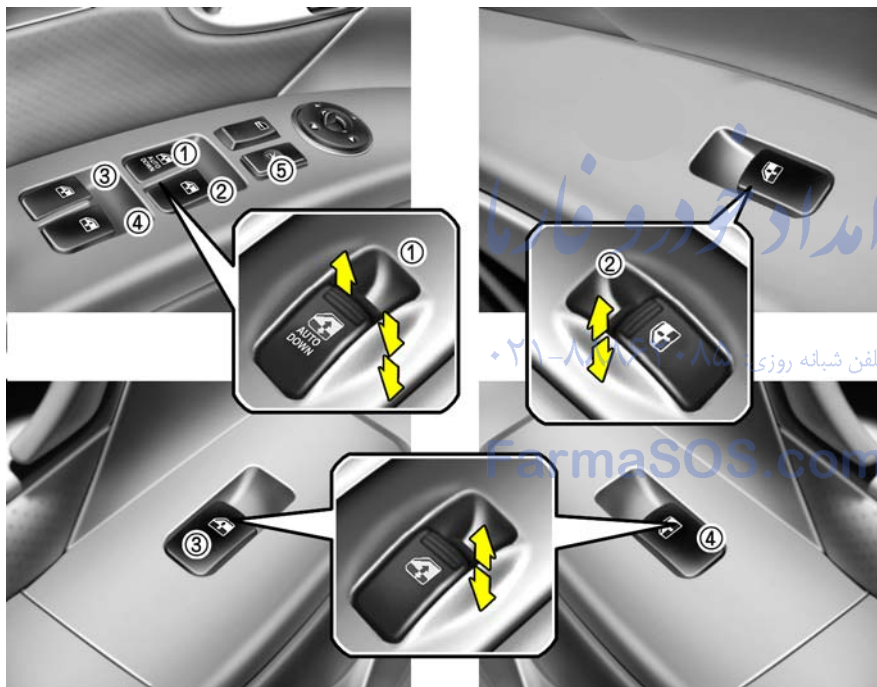

1. Driver's door power window switch
2. Front passenger's door power window switch
3. Rear passenger's door power window switch (left side)
4. Rear passenger's door power window switch (right side)
5. Window lock switch

POWER WINDOWS

B060A01CM-AAT



The power windows operate when the ignition key is in the "ON" position. The main switches are located on the driver's armrest and control the front and rear windows on both sides of the vehicle. The windows may be opened by depressing the appropriate window switch and closed by pulling up the switch. To open the window on the driver's side, press the switch halfway down. The window moves as long as the switch is operated. To fully open the driver's window automatically, press the switch fully down. In automatic operation, the window will fully open even if you let go of the switch. To stop at the desired opening, pull up and release the switch.



In order to prevent operation of the passenger front and rear windows, a window lock switch is provided on the armrest of the driver's door. To disable the power windows, press the window lock switch. To revert to normal operation, press the window lock switch a second time.

NOTE:

The power windows can be operated for 30 seconds after the ignition key is turned to the "ACC" or "LOCK" positions, or removed from the ignition switch. If the driver's door is opened during this 30 second period, the power windows can no longer be operated without the ignition key turned to the "ON" position.



WARNING:

- o Passengers can be injured in their head, hands or other body parts are trapped by a closing window. Always check for obstructions before raising any windows.
- o Never leave any child unattended in the vehicle. Even very young children may inadvertently cause the vehicle to move, entangle themselves in the window, otherwise injure themselves or others.

SEATS

**WARNING:**

- o Do not attempt to operate the main switch on another door in opposing directions at the same time. If this is done, the window will stop and cannot be opened or closed.

B080A02A-AAT

Adjustable Front Seats**WARNING:**

- o Never adjust the driver's seat while the vehicle is moving. Any sudden or unexpected movement of the seat could cause you to lose control of the vehicle resulting in an accident. Only adjust the driver's seat when the vehicle is stationary.
- o Do not sit or lean unnecessarily close to the air bag. Position the seat so that you can sit as far back as possible from the air bag and still comfortably reach all controls.

B080B04A-AAT

Front Seat**Adjusting seat forward and rearward**

To move the seat toward the front or rear, pull the lock release lever upward. This will release the seat on its track so you can move it forward or rearward to the desired position. When you find the position you want, release the lever and slide the seat forward or rearward on its track until it locks into the desired position and cannot be moved further.

**WARNING:**

After adjusting the seat, always check that it is securely locked into place by attempting to move the seat forward or rearward without using the lock release lever. Sudden or unexpected movement of the driver's seat could cause you to lose control of the vehicle resulting in an accident.

B080C03A-AAT

Adjusting Seatback Angle

To recline the seatback, lean forward to take your weight off it, then pull up on the recliner control lever at the outside edge of the seat. Now lean back until the desired seatback angle is achieved. To lock the seatback into position, release the recliner control lever.

**WARNING:**

Riding with a reclined seatback increases your chance of serious or fatal injuries in the event of a collision or sudden stop. The protection of your restraint system (seat belts and air bags) is greatly reduced by reclining your seat. Seat belts must be snug against your hips and chest to work properly. The more the seatback is reclined, the greater the chance that an occupant's hips will slide under the lap belt or the occupant's neck will strike the shoulder belt. Drivers and passengers should always sit well back in their seats, properly belted, and with the seatbacks upright.

B080D02JM-AAT

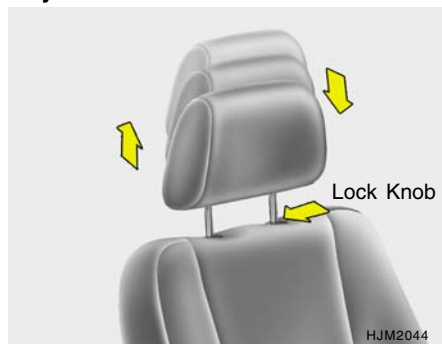
Adjustable Headrests

Headrests are designed to help reduce the risk of neck injuries.

To raise the headrest, pull it up. To lower the headrest, push it down while pressing the lock knob. To remove the headrest, raise it as far as it can go then press the lock knob while pulling upward. This should only be done when the seat is not occupied.

! WARNING:

B080D01JM

- o For maximum effectiveness in case of an accident the headrest should be adjusted so the middle of the headrest is at the same height as the top of the occupant's eyes. For this reason, the use of a cushion that holds the body away from the seatback is not recommended.
- o Do not operate vehicle with the headrests removed as injury to the occupants may occur in the event of an accident. Headrests may provide protection against neck injuries when properly adjusted.

! WARNING:

- o Do not adjust the headrest height while the vehicle is in motion.

B081D01CM-AAT

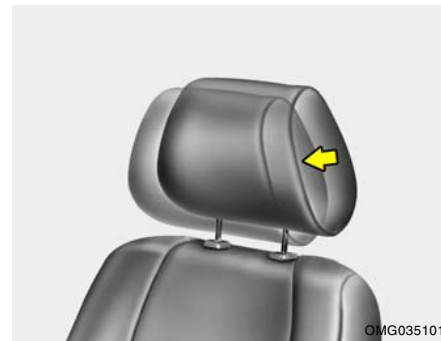
Adjusting Headrest Forward and Rearward

The headrest may be adjusted forward to three different positions by pulling the headrest forward. To adjust the headrest rearward, pull it fully forward to the farthest position and release it. Adjust the headrest so that it properly supports the head and neck.

B083D01NF-AAT

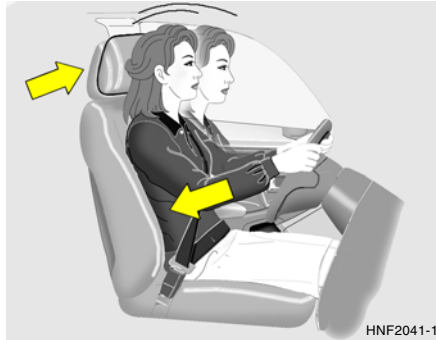
Active Headrests (If Installed)

The active headrest is designed to move forward and upward during a rear impact. This helps to prevent the driver's and front passenger's heads from moving backward and thus helps prevent neck injuries.

B080E01Y-AAT

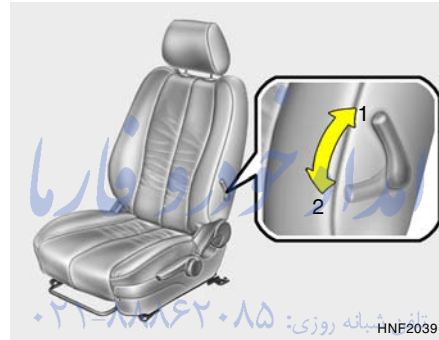
Lumbar Support Control (Driver's Seat Only) (If Installed)

To adjust the lumbar support, turn the handle on the outboard or left side of the seat. To increase the amount of lumbar support, pull the lever forward. To decrease it, push the lever toward the rear.

1. Minimum support
2. Maximum support

B080F01NF-GAT

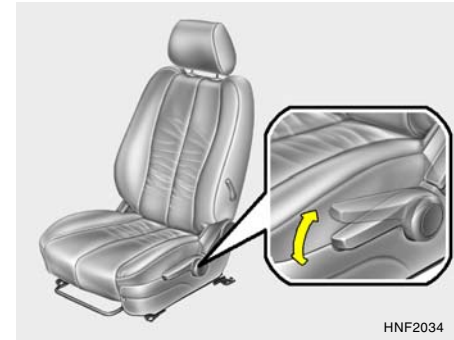
Seat Height Adjustment (Driver's Seat Only)

To raise or lower the seat, raise or lower the control lever to the desired seat height.

B090A02TG-AAT

Front Power Seats

The front seats can be adjusted appropriately by using the control knob on the seat. Before driving, adjust the seat to the proper position so as to easily control the steering wheel, pedals and switches on the instrument panel.

**CAUTION:**

Do not operate two knobs at the same time.

**WARNING:**

- o Never adjust a driver's seat while the vehicle is moving. Any sudden or unexpected movement of the seat could cause you to lose control of the vehicle resulting in an accident. Only adjust the driver's seat when the vehicle is stationary.
- o Do not sit or lean unnecessarily close to the air bag. Position the seat so that you can sit as far back as possible from the air bag and still comfortably reach all controls.

B090B01CM-AAT

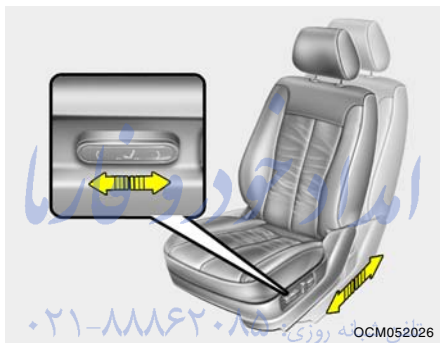
Adjusting Seat Forward and Rearward

Push the control knob forward or backward to move the seat forward or backward to the desired position. Release the control knob and the seat will remain at that position.

B090D01CM-AAT

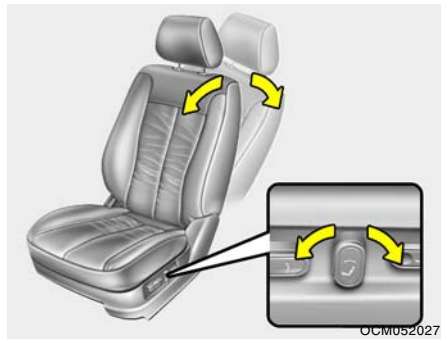
Adjusting Seatback Angle

Push the upper portion of the control knob forward or backward to recline the seatback to the desired position. Release the control knob and the seatback will remain in that position.

**WARNING:**

Riding with a reclined seatback increases your chance of serious or fatal injuries in the event of a collision or sudden stop. The protection of your restraint system (seat belts and air bags) is greatly reduced by reclining your seat. Seat belts must be snug against your hips and chest to work properly. The more the seatback is reclined, the greater the chance that an occupant's hips will slide under the lap belt or the occupant's neck will strike the shoulder belt. Drivers and passengers should always sit well back in their seats, properly belted, and with the seatbacks upright.

B090C01Y-AAT

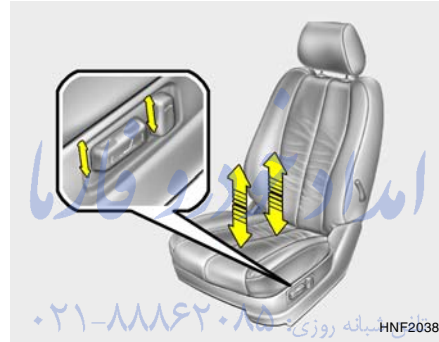
**Seat Cushion Height Adjustment
(Driver's seat only)**

Move the front portion of the control knob up or down to raise or lower the front part of the seat cushion. Move the rear portion of the control knob up or down to raise or lower the rear part of the seat cushion.

B090E01TG-AAT

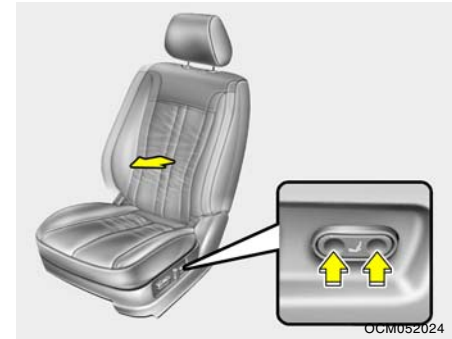
**Lumbar Support Control
(Driver's seat only) (If Installed)**

To adjust the lumbar support, press the control switch on the outboard side of the seat cushion. To increase the amount of lumbar support, press the front portion of the switch. To decrease lumbar support, press the rear portion of the switch.

B100A01CM-AAT

Seat Warmer (If installed)

The seat warmer is provided to warm the front seats during cold weather. With the ignition key in the "ON" position, push either of the switches to warm the driver's seat or the passenger's seat.

During mild weather or under conditions where the operation of the seat warmer is not needed, keep the switches in the "OFF" position.

Each time you push the button, the temperature setting of the seat is changed as follows :

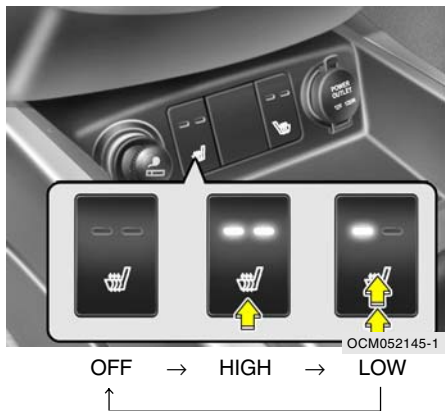

NOTE:

- o The seat warmer will not operate if the ambient temperature is warm.
- o If the seat warmer doesn't work when ambient temperature is lower than 70°F (21°C), it should be checked at an authorized dealer.

! WARNING:
Do not turn on the seat warmers if the seat is occupied by someone who cannot monitor the temperature and turn off the seat warmer if it becomes too warm. The seat warmers should not be turned on when children, the elderly, ill people, and sleeping people occupy the seat.

B085A01JM-GAT

Rear Seat

Adjusting seatback angle

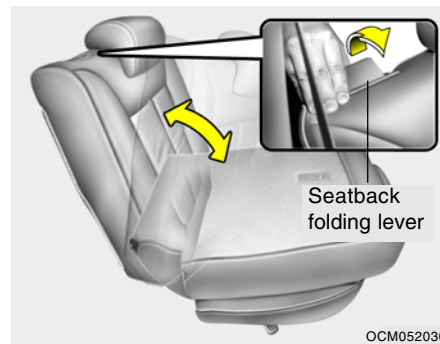

To recline the seatback, pull the seatback folding lever and release it after the desired seatback angle is achieved.

When you recline the seatback to the desired position, always be sure it has locked into position.

! CAUTION:
When reclining the seatback, you should adjust the seatback folding lever while you are standing.

B085B02CM-AAT

Folding Rear Seatback 2nd row seat

For convenience, the seatbacks and seat cushions may be folded down and up.

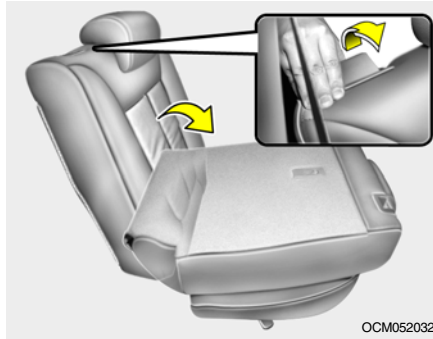

1. Lower the headrest to the lowest position.
2. Pull the seatback folding lever then push down the seatback.
3. Be sure it has locked into position by listening for an audible "Click".

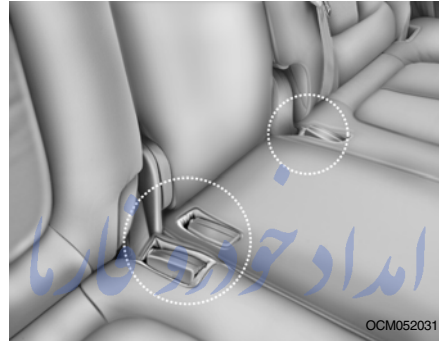

NOTE:
Before folding the seatback, place the rear seat belt buckles in the buckle pouch on the seat cushion.

FarmaSOS.com



CAUTION:
Be careful not to overload seatback. Overloading may cause damage to the seatback.

4. To return the seatback to its normal position, pull the seatback folding lever and reverse the above procedure.

When you return the seatback to its upright position, always be sure it is locked into position by pulling and pushing on the top of the seatback.

3rd Row Seat (If Installed)

1. Move the 2nd row seatback to the forward position.
2. Lower the headrest to the lowest position.
3. To fold down the seatback, pull the seatback folding lever and then push down the seatback.

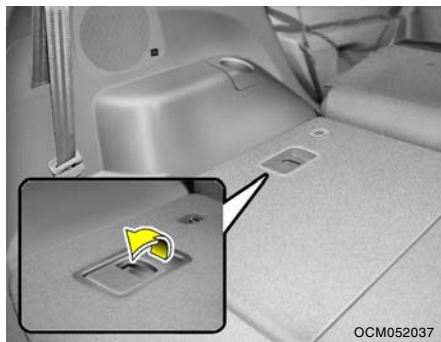

4. To return the seatback to its normal position, reverse the above procedure.



CAUTION:

When return the seatback to upright position, you always lift and pull it by folding lever.

In the case of a lift and a pull by grip the edge of seatback, it may cause damage to the seatback board.

Double-folding the rear seat (2nd row) (if installed)

To fold the rear seat forward to increase the cargo area:

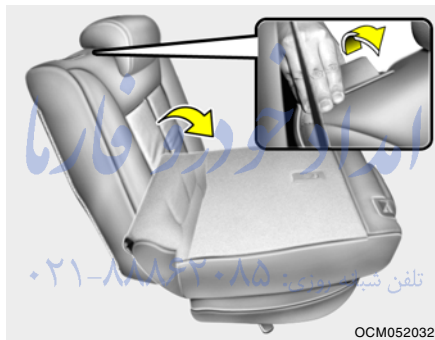

1. Lower the headrest to the lowest position.
2. Pull the seatback folding lever then push down the seatback.

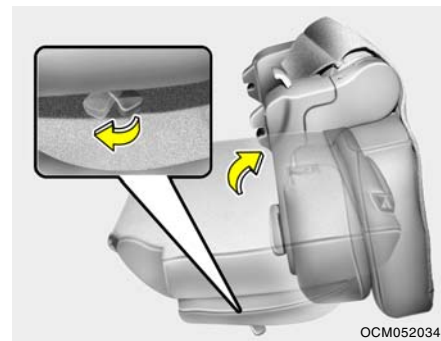
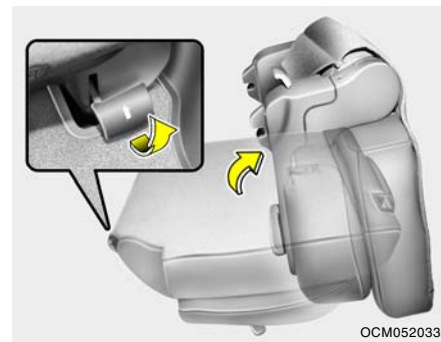

3. Pull the seat cushion release lever and then fold up the seat cushion.

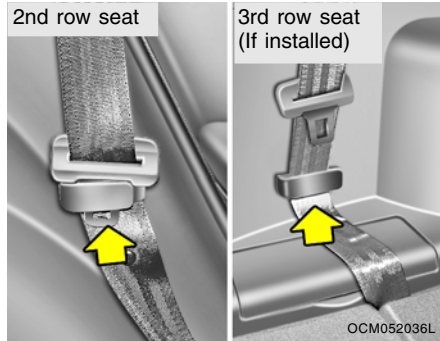

CAUTION:
 When returning the rear seatbacks to the upright position, remember to return the rear shoulder belts to their proper position. Routing the safety belt webbing through the rear safety belt guides will help keep the belts from being trapped behind or under the seats.

WARNING:

- o Never allow passengers to sit on the 3rd row seat when the 2nd row seat is double-folded. This could result in serious injury or death in case of an accident or a sudden stop.
- o Do not allow passengers to fold up and down the seatback and seat cushion while the car is moving.

WARNING: تلفن شبانه روزی: ۸۵

- o When you return the rear seatback to its upright position after being folded down, be careful not to damage the seatbelt webbing or buckle. Do not allow the seatbelt webbing or buckle to get caught or pinched in the rear seat.
- o When you return the rear seatback to its upright position, be sure it is locked into position by attempting to move it.
- o Never attempt to fold or return the seat to an upright position while the vehicle is moving.

WARNING:

- o The purpose of the fold-down rear seat back is to allow you to carry more cargo objects than could otherwise be accommodated. Never allow passengers to sit on the cargo area while the car is moving. This is not a proper seating position and no seat belts are available for use when the seat back is folded down. This could result in serious injury or death in case of an accident or a sudden stop. Objects should not extend higher than the top of the front seatbacks. This could allow cargo to slide forward and cause injury or damage during sudden stops.

B611A01Y-AAT

Rear seat arm rest

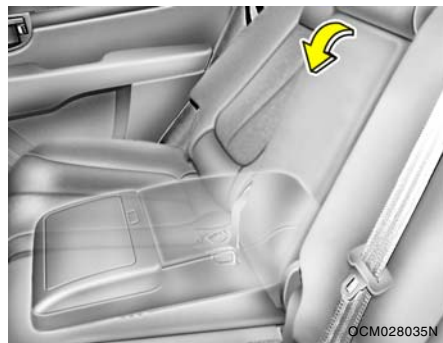

This arm rest is located in the center of the rear seat back.

B085D02TG-AAT

Adjustable Headrests

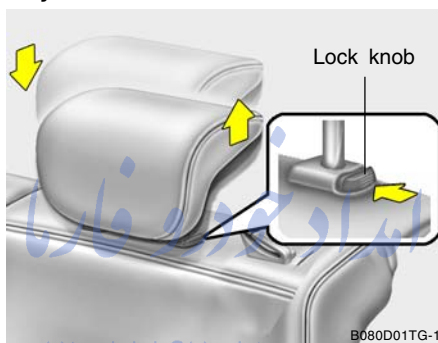

Headrests are designed to help reduce the risk of neck injuries.

To raise the headrest, pull it up. To lower it, push it down while pressing the lock knob. To remove the headrest, raise it as far as it can go then press the lock knob while pulling upward. This should only be done when the seat is not occupied.

!
WARNING:

- o For maximum effectiveness in case of an accident the headrest should be adjusted so the middle of the headrest is at the same height as the top of the occupant's eyes. For this reason, the use of a cushion that holds the body away from the seatback is not recommended.
- o Do not operate vehicle with the headrests removed as injury to the occupants may occur in the event of an accident. Headrests may provide protection against neck injuries when properly adjusted.

SEAT BELTS



B140A01B-AAT

REAR SEAT WARNING

OCM015004L

For the safety of all passengers, luggage or other cargo should not be piled higher than the top of the seatback.

B150A03S-AAT

Seat Belt Precautions**WARNING:**

All occupants of the vehicle must wear their seat belts at all times. Seat belts and child restraints reduce the risk of serious or fatal injuries for all occupants in the event of a collision or sudden stop. Without a seat belt, occupants could be shifted too close to a deploying air bag, strike the interior structure or be thrown from the vehicle. Properly worn seat belts greatly reduce these hazards. Even with advanced air bags, unbelted occupants can be severely injured by a deploying air bag. Always follow the precautions about seat belts, air bags and occupant safety contained in this manual.

B150B04Y-AAT

Infant or Small Child

All 50 states have child restraint laws. You should be aware of the specific requirements in your state. Child and/or infant safety seats must be properly placed and installed in the rear seat. Information about the use of these restraints begins on page 1-33.

**WARNING:**

Every person in your vehicle needs to be properly restrained at all times, including infants and children. Never hold a child in your arms or lap when riding in a vehicle. The violent forces created during a crash will tear the child from your arms and throw the child against the interior. Always use a child restraint appropriate for your child's height and weight.

NOTE:

Small children are best protected from injury in an accident when properly restrained in the rear seat by a child restraint system that meets the requirements of the Federal Motor Vehicle Safety Standards. Before buying any child restraint system, make sure that it has a label certifying that it meets Federal Motor Vehicle Safety Standard 213. The restraint must be appropriate for your child's height and weight. Check the label on the child restraint for this information. See page 1-33.

B150C02A-AAT

Larger Children

Children who are too large for child restraint systems should always occupy the rear seat and use the available lap/shoulder belts. The lap portion should be fastened snug on the hips and as low as possible. Check belt fit periodically. A child's squirming could put the belt out of position. Children are afforded the most safety in the event of an accident when they are restrained by a proper restraint system in the rear seat. If a larger child (over age 13) must be seated in the front seat, the child should be securely restrained by the available lap/shoulder belt and the seat should be placed in the rearmost position. Children under the age of 13 should be restrained securely in the rear seat. NEVER place a child under the age of 13 in the front seat. NEVER place a rear facing child seat in the front seat of a vehicle.

B150D01A-AAT

Pregnant Women

The use of a seat belt is recommended for pregnant women to lessen the chance of injury in an accident. When a seat belt is used, the lap belt portion should be placed as low and snugly as possible on the hips, not across the abdomen. For specific recommendations, consult a physician.

B150E01A-AAT

Injured Person

A seat belt should be used when an injured person is being transported. When this is necessary, you should consult a physician for recommendations.

B150F01A-AAT

One Person Per Belt

Two people (including children) should never attempt to use a single seat belt. This could increase the severity of injuries in case of an accident.

B150G02A-AAT

Do Not Lie Down

To reduce the chance of injuries in the event of an accident and to achieve maximum effectiveness of the restraint system, all passengers should be sitting up and the front seats should be in an upright position when the car is moving. A seat belt cannot provide proper protection if the person is lying down in the rear seat or if the front seat is in a reclined position.



WARNING:

Riding with a reclined seatback increases your chance of serious or fatal injuries in the event of a collision or sudden stop. The protection of your restraint system (seat belts and air bags) is greatly reduced by reclining your seat. Seat belts must be snug against your hips and chest to work properly. The more the seatback is reclined, the greater the chance that an occupant's hips will slide under the lap belt causing serious internal injuries or the occupant's neck could strike the shoulder belt. Drivers and passengers should always sit well back in their seats, properly belted (see page 1-31), and with the seatbacks upright.

B160A02A-AAT

Care of Seat Belts

Seat belt systems should never be disassembled or modified. In addition, care should be taken to assure that seat belts and belt hardware are not damaged by seat hinges, doors or other abuse.



WARNING:

When you return the rear seatback to its upright position after the rear seatback was folded down, be careful not to damage the seat belt webbing or buckle. Be sure that the webbing or buckle does not get caught or pinched in the rear seat. A seat belt with damaged webbing or buckle will not be as strong and could possibly fail during a collision or sudden stop, resulting in serious injury.

B160B01A-AAT

Periodic Inspection

It is recommended that all seat belts be inspected periodically for wear or damage of any kind. Parts of the system that are damaged should be replaced as soon as possible.

B160C01A-AAT

Keep Belts Clean and Dry

Seat belts should be kept clean and dry. If belts become dirty, they can be cleaned by using a mild soap solution and warm water. Bleach, dye, strong detergents or abrasives should not be used because they may damage and weaken the fabric.

B160D01A-AAT

When to Replace Seat Belts

Entire in-use seat belt assembly or assemblies should be replaced if the vehicle has been involved in an accident. This should be done even if no damage is visible. Additional questions concerning seat belt operation should be directed to your Hyundai Dealer.

B170A06A-AAT

Height Adjustable Front Seat Shoulder Belt

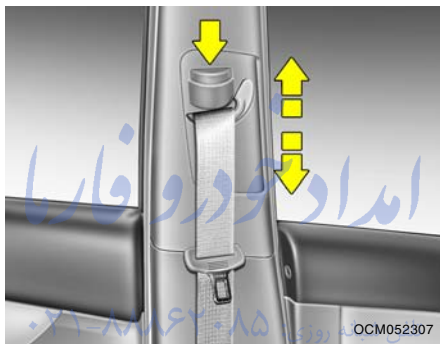

You can adjust the height of the shoulder belt anchor to one of the 4 positions for maximum comfort and safety. If the height of the adjusting seat belt is too near your neck, you will not be getting the most effective protection. The shoulder portion should be adjusted so that it lies across your chest and midway over your shoulder nearest the door and not your neck.

To adjust the height of the seat belt anchor, lower or raise the height adjuster into an appropriate position. To raise the height adjuster, pull it up. To lower it, push it down while pressing the height adjuster button. Release the button to lock the anchor into position. Try sliding the height adjuster to make sure that it has locked into the position.



WARNING:

- o Adjust the shoulder belt height when you sit well back in the seat.
- o When adjusting the shoulder belt height, grip the height adjuster button securely and slide the height adjuster up or down.

**WARNING:**

- o Verify the shoulder belt anchor is locked into position at the appropriate height. Never position the shoulder belt across your neck or face. Improperly positioned seat belts can cause serious injuries in an accident.
- o Failure to replace seat belts after an accident could leave you with damaged seat belts that will not provide protection in the event of another collision leading to personal injury or death. Replace your seat belts after being in an accident as soon as possible.

B180A01CM-AAT

SEAT BELT-Driver's 3-Point System with Emergency Locking Retractor

To fasten your belt

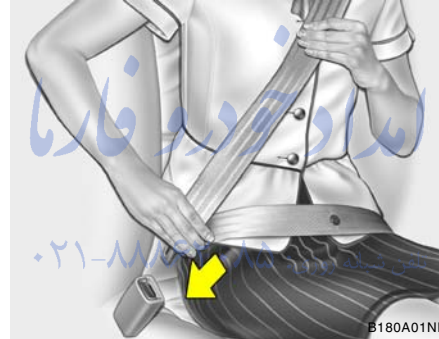

B180A01NF

To fasten your seat belt, pull it out of the retractor and insert the metal tab into the buckle. There will be an audible "click" when the tab locks into the buckle.

The seat belt automatically adjusts to the proper length only after the lap belt portion is adjusted manually so that it fits snugly around your hips. If you lean forward in a slow, easy motion, the belt will extend and let you move around.

If there is a sudden stop or impact, however, the belt will lock into position. It will also lock if you try to lean forward too quickly.

NOTE:

- o If you are not able to pull out the seat belt from the retractor, firmly pull the belt out and release it. Then you will be able to pull the belt out smoothly.
- o If the driver's seat belt is not fastened when the ignition key is in the "ON" position, the seat belt warning light will flash and the warning chime will sound for approximately six seconds. See page 1-66.

B190A01CM-AAT

SEAT BELTS-Front Passenger and Rear Seat 3-Point System with Convertible Locking Retractor

Convertible retractor type seat belts are installed in the rear seat positions to help accommodate the installation of child restraint systems. Although a convertible retractor is also installed in the front passenger seat position, Hyundai strongly recommends that children always be seated in the rear seat. NEVER place any infant restraint system in the front seat of the vehicle.

This type of seat belt combines the features of both an emergency locking retractor seat belt and an automatic locking retractor seat belt. To fasten your seat belt, pull it out of the retractor and insert the metal tab into the buckle. There will be an audible "click" when the tab locks into the buckle. When not securing a child restraint, the seat belt operates in the same way as the driver's seat belt (Emergency Locking Retractor Type). It automatically adjusts to the proper length only after the lap belt portion of the seat belt is adjusted manually so that it fits snugly around your hips.

When the seat belt is fully extended from the retractor to allow the installation of a child restraint system, the seat belt operation changes to allow the belt to retract, but not to extend (Automatic Locking Retractor Type). See page 1-39.

NOTE:

Although the convertible retractor provides the same level of protection for seated passengers in either emergency or automatic locking modes, it is recommended that seated passengers use the emergency locking feature for improved convenience. The automatic locking function is intended to facilitate child restraint installation. To convert from the automatic locking feature to the emergency locking operation mode, allow the unbuckled seat belt to fully retract.



WARNING:

- o For maximum restraint system protection, the seat belts must always be used whenever the car is moving.
- o Children age 12 and younger must always be properly restrained in the rear seat. Never allow children to ride in the front passenger seat. If a child over 13 must be seated in the front seat, he/she must be properly belted and the seat should be moved as far back as possible.
- o Never wear the shoulder belt under your arm or behind your back. An improperly positioned shoulder belt can cause serious injuries in a crash. The shoulder belt should be positioned midway over your shoulder across your collarbone.
- o Avoid wearing twisted seat belts. A twisted belt can't do its job as well. In a collision, it could even cut into you. Be sure the belt webbing is straight and not twisted.
- o Be careful not to damage the belt webbing or hardware. If the belt webbing or hardware is damaged, replace it.

B200A01A-AAT

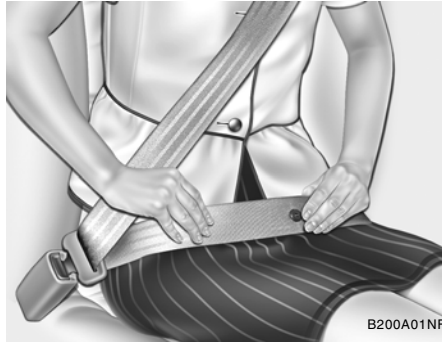
Adjusting Your Seat Belt

B210A01A-AAT

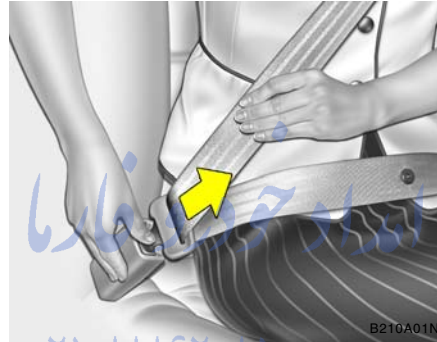
To Release the Seat Belt

The seat belt is released by pressing the release button in the locking buckle. When it is released, the belt should automatically draw back into the retractor. If this does not happen, check the belt to be sure it is not twisted, then try again.

B230A01CM-AAT

Children riding in the car should sit in the rear seat and must always be properly restrained to minimize the risk of injury in an accident, sudden stop or sudden maneuver. According to accident statistics provided by the National Highway Traffic Safety Administration (NHTSA), children are safer when properly restrained in the rear seats than in the front seat. Larger children not in a child restraint should use one of the seat belts provided.

All 50 states have child restraint laws. You should be aware of the specific requirements in your state. Child and/or infant safety seats must be properly placed and installed in the rear seat. You must use a commercially available child restraint system that meets the requirements of the Federal Motor Vehicle Safety Standards (FMVSS). Child restraint systems are designed to be secured in vehicle seats by lap belts or the lap belt portion of a lap/shoulder belt, or by a LATCH system (if installed).

Children could be injured or killed in a crash if their restraints are not properly secured. For small children and babies, a child seat or infant seat must be used.

**WARNING:**

You should place the lap belt portion as low as possible and snugly across your hips, not on your waist. If the lap belt is located too high on your waist, it may increase the chance of injury in the event of a collision. Both arms should not be under or over the belt. Rather, one should be over and the other under, as shown in the illustration. Never wear the seat belt under the arm nearest the door.

Before buying a particular child restraint system, make sure it fits your car seat and seat belts, and fits your child. Follow all the instructions provided by the manufacturer when installing the child restraint system.



WARNING:

- o A child restraint system must be placed in the rear seat. Never install a child or infant seat on the front passenger's seat. Should an accident occur and cause the passenger side air bag to deploy, it could severely injure or kill an infant or child seated in an infant or child seat. Thus only use a child restraint in the rear seat of your vehicle.
- o A safety belt or child restraint system can become very hot if it is left in a closed vehicle on a sunny day, even if the outside temperature does not feel hot. Be sure to check the seat cover and buckles before placing a child there.
- o When the child restraint system is not in use, store it in the luggage compartment or fasten it with a safety belt so that it will not be thrown forward in the case of a sudden stop or an accident.



WARNING:

- o Children may be seriously injured or killed by an inflating air bag. All children, even those too large for child restraints, must ride in the rear seat.



WARNING:

To reduce the chance of serious or fatal injuries:

- o Children of all ages are safer when restrained in the rear seat. A child riding in the front passenger seat can be forcefully struck by an inflating air bag resulting in serious or fatal injuries.
- o Always follow the instructions for installation and use of the child restraint maker.
- o Always make sure the child seat is secured properly in the car and your child is securely restrained in the child seat.



WARNING:

- o Never hold a child in your arms or lap when riding in a vehicle. The violent forces created during a crash will tear the child from your arms and throw the child against the car's interior.
- o Never put a seat belt over yourself and a child. During a crash, the belt could press deep into the child causing serious internal injuries.
- o Never leave children unattended in a vehicle – not even for a short time. The car can heat up very quickly, resulting in serious injuries to children inside. Even very young children may inadvertently cause the vehicle to move, entangle themselves in the windows, or lock themselves or others inside the vehicle.
- o Never allow two children, or any two persons, to use the same seat belt.
- o Children often squirm and reposition themselves improperly. Never let a child ride with the shoulder belt under their arm or behind their back. Always properly position and secure children in rear seat.

**WARNING:**

- o Never allow a child to stand-up or kneel on the seat or floorboard of a moving vehicle. During a collision or sudden stop, the child can be violently thrown against the vehicles interior, resulting in serious injury.
- o Never use an infant carrier or a child safety seat that "hooks" over a seatback, it may not provide adequate security in an accident.
- o Seat belts can become very hot, especially when the car is parked in direct sunlight. Always check seat belt buckles before fastening them over a child.
- o Always store or secure a child seat, even when it is not in use. During a collision or sudden stop, the child seat could be thrown inside the vehicle.

B230B01E-AAT

Using a Child Restraint System

For small children and babies, the use of a child seat or infant seat is required. This child seat or infant seat should be of appropriate size for the child and should be installed in accordance with the manufacturer's instructions. It is further required that the seat be placed in the vehicle's rear seat since this can make an important contribution to safety. Your vehicle is provided with three child restraint hook holders for installing the child seat or infant seat.

تلفن شبانه روزی: ۰۲۱-۸۸۶۲۰۸۵

FarmaSOS.com

B230C01CM-AAT

Installing a Child Restraint Seat with the "Tether Anchorage" System

Three child restraint hook holders are located on the seatback behind the rear seat.

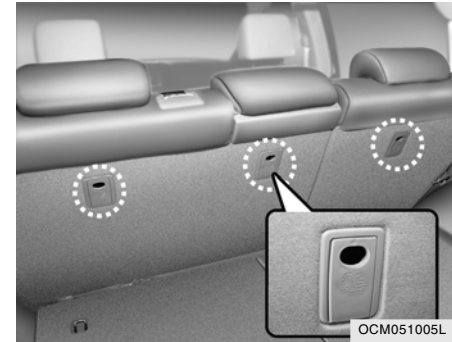

This symbol indicates the location of each user ready tether anchorage.

To install the child restraint seat tether

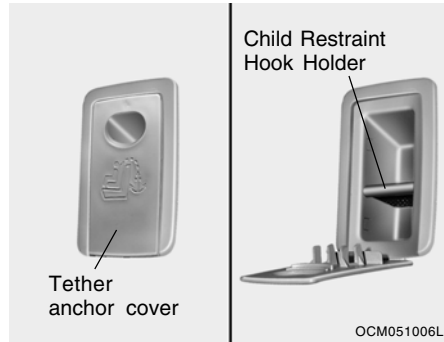

1. Open the tether anchor cover.

Seaback behind the rear seat

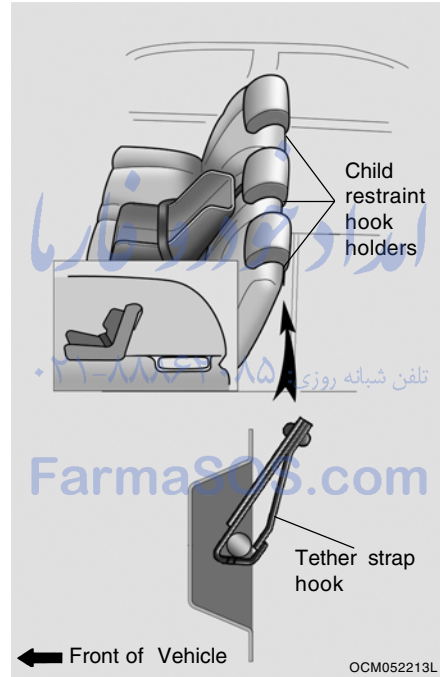

2. Route the child restraint seat tether strap over the seatback.

For vehicles with adjustable headrests, route the tether strap under the headrest and between the headrest posts, otherwise route the tether strap over the top of the seatback.

3. Connect the tether strap hook to the child restraint hook holder and tighten to secure the seat.

! WARNING:

- o Adjust the rear seatback in a semi-reclined position from the upright position, before installing the Child Restraint Seat. With the seatback in the proper reclining angle, push and pull the child restraint seat in different directions to be sure it is secure.
- o A child can be seriously injured or killed in a collision if the child restraint is not properly anchored. Always follow the child seat manufacturer's instructions for installation and use.

**WARNING:**

- o Never mount more than one child restraint to a single tether or to a single lower anchorage point. The increased load caused by multiple seats may cause the tethers or anchorage points to break, causing serious injury or death.

B230D03CM-AAT

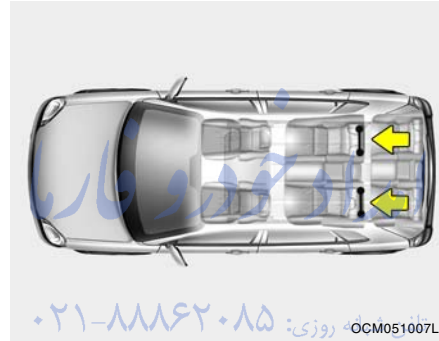
Securing the Child Restraint Seat with the "LATCH" system

Some child seat manufacturers make safety seats that are labeled as LATCH or LATCH-compatible child seats. These seats include two rigid or webbing mounted attachments that connect to two lower anchors at specific seating positions in your vehicle. This type of child seat eliminates the need to use seat belts to attach the child seat; the tether strap must also be attached to the proper tether anchor point. For information on using tether straps, refer to "Installing a Child Restraint Seat with the "Tether Anchorage" system".

LATCH anchors have been provided in your vehicle. The LATCH anchors are located in the left and right outboard 2nd rear seating positions.

Their locations are shown in the illustration. There is no lower anchor provided for the center rear seating position.

**WARNING:**

- o A child can be seriously injured or killed in a collision if the child restraint is not properly anchored. Always follow the child seat manufacturer's instructions for installation and use.
- o Never install a child restraint using the lower anchors at the center position of the rear seat. In a crash, the LATCH anchors may break if a car seat is improperly placed in the center position resulting in serious or fatal injuries. Only place a LATCH or LATCH-compatible child seat in the left or right out-board rear seating positions (as shown) to the appropriate LATCH anchors provided.

**WARNING:**

- o Never mount more than one child restraint to a single tether or to a single lower anchorage point. The increased load caused by multiple seats may cause the tethers or anchorage points to break, causing serious injury or death.
- o When using the vehicle's "LATCH" system to install a child restraint system in the rear seat, all unused vehicle rear seat belt metal latch plates or tabs must be latched securely in their seat belt buckles and the seat belt webbing must be retracted behind the child restraint to prevent the child from reaching and taking hold of unretracted seat belts. Unlatched metal latch plates or tabs may allow the child to reach the unretracted seat belts which may result in strangulation and a serious injury or death to the child in the child restraint.

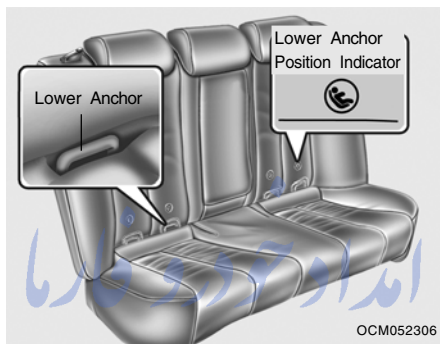

The lower anchors are located between the seatback and the seat cushion of the 2nd rear seat left and right outboard seating positions.

FarmaSOS.com

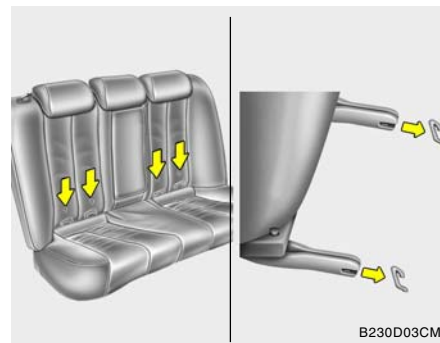

Follow the child seat manufacturer's instructions to properly install safety seats with LATCH or LATCH-compatible attachments.

Once you have installed the LATCH child restraint seat, assure that the seat is properly attached to the lower and tether anchors. Also, test the safety seat before you place the child in it. Tilt the seat from side to side. Also try to tug the seat forward. Check to see if the anchors hold the seat in place.

**CAUTION:**

Do not allow the rear seat belt webbing to get scratched or pinched by the child-seat latch and LATCH anchor during the installation.

**WARNING:**

- o A child can be seriously injured or killed in a collision if the child restraint is not properly anchored to the car and the child is not properly restrained in the child restraint. Always follow the child seat manufacturer's instructions for installation and use.
- o Adjust the rear seatback in a semi-reclined position from the upright position, before installing the Child Restraint Seat. With the seatback in the proper reclining angle, push and pull the child restraint seat in different directions to be sure it is secure.

B230F01JM-AAT

Child Restraint System Installation on Rear Seat Center Position

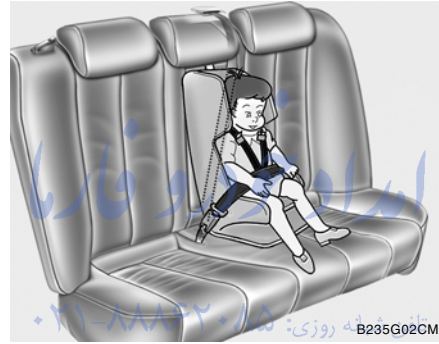

To install a child restraint system in the center rear seat, extend the shoulder/lap belt entirely from its retractor until a "click" is felt. This will engage the seat belt retractor automatic locking feature, which allows the seat belt to retract but not extend. Install the child restraint system, buckle the seat belt and allow the seat belt to take up any slack. Make sure that the lap portion of the belt is tight around the child restraint system and the shoulder portion of the belt is positioned so that it can not interfere with the child's head or neck.

Also, double check to be sure that the retractor has engaged the Automatic Locking feature by trying to extend webbing out of the retractor. If the retractor is in the Automatic Locking mode, the belt will be locked.

B230G01CM-AAT

Child Restraint System Installation on Outboard Rear Seats

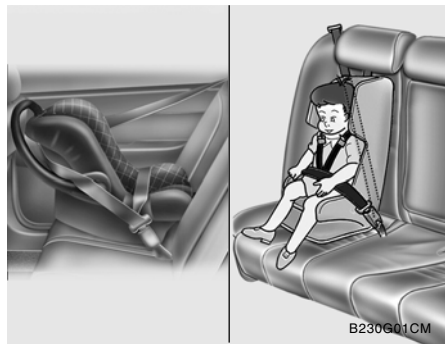

To install a child restraint system in the outboard rear seats, extend the shoulder/lap belt entirely from its retractor until a "click" is felt. This will engage the seat belt retractor automatic locking feature, which allows the seat belt to retract but not extend. Install the child restraint system, buckle the seat belt and allow the seat belt to take up any slack. Make sure that the lap portion of the belt is tight around the child restraint system and the shoulder portion of the belt is positioned so that it can not interfere with the child's head or neck.

Also, double check to be sure that the retractor has engaged the Automatic Locking feature by trying to extend webbing out of the retractor. If the retractor is in the Automatic Locking mode, the belt will be locked. After installation of the child restraint system, try to move it in all directions to be sure the child restraint system is securely installed. If you need to tighten the belt, pull more webbing toward the retractor. When you unbuckle the seat belt and allow it to retract, the retractor will automatically revert back to its normal seated passenger Emergency Locking usage condition.

NOTE:

- o Before installing the child restraint system in any seating position, read the instructions supplied by the child restraint system manufacturer.
- o If the seat belt does not operate as described, have the system checked immediately by your authorized Hyundai dealer.



WARNING:

- o If the retractor is not in the Automatic Locking mode, the child restraint can move when your vehicle turns or stops suddenly. A child can be seriously injured or killed if the child restraint is not properly anchored to the car, including setting the retractor to the Automatic Locking mode.
- o Do not install any child restraint system in the front passenger seat. Should an accident occur and cause the passenger side air bag to deploy, it could severely injure or kill an infant or child seated in an infant or child seat. Therefore, only use a child restraint system in the rear seat of your vehicle.
- o Before installing Child Restraint Systems, refer to safety notices for Curtain Air Bag systems beginning on page 1-58 this manual. Whenever installing child restraints, use only approved devices and refer to the "Child Restraint System" section to ensure correct installation and occupant protection is maximized.

B180B01CM-AAT

Pre-tensioner Seat Belt

OMG035300

Your Hyundai vehicle is equipped with driver's and front passenger's pre-tensioner seat belts. The purpose of the pre-tensioner is to make sure that the seat belts fit tightly against the occupant's body in certain frontal collisions. The pre-tensioner seat belts can be activated together with the air bags.

When the vehicle stops suddenly, or if the occupant tries to lean forward too quickly, the seat belt retractor will lock into position. In certain frontal collisions, the pre-tensioner will activate and pull the seat belt into tighter contact against the occupant's body.

If the system senses excessive seat belt tension on the driver or passenger's seat belt when the pre-tensioner activates, the load limiter inside the pre-tensioner will release some of the pressure on the affected seat belt.

تلفن شبانه روزی: ۰۲۱-۸۸۶۲۰۸۵

FarmaSOS.com

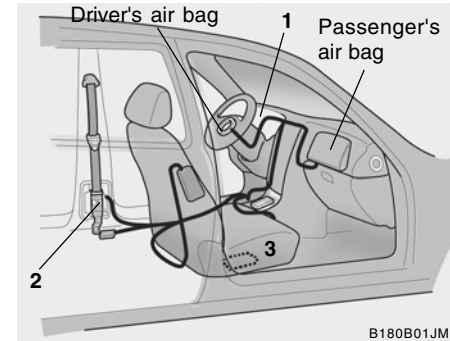

B180B01JM

The seat belt pre-tensioner system consists mainly of the following components. Their locations are shown in the illustration:

1. SRS air bag warning light
2. Retractor pre-tensioner assembly
3. SRS control module

**WARNING:**

To obtain maximum benefit from a pre-tensioner seat belt:

1. The seatbelt must be work correctly and adjusted to the proper position (see pages 1-30 and 1-31). Please read and follow all of the important information and precautions about your vehicle's occupant safety features – including seat belts and advanced air bags – that are provided in this manual.
2. Be sure you and your passengers always wear seat belts and wear them properly.

NOTE:

- o Both the driver's and front passenger's pre-tensioner seat belts will be activated in certain frontal collisions. The pre-tensioner seat belts can be activated together with the air bags.
The pre-tensioners will not be activated if the seat belts are not being worn at the time of the collision.
- o When the pre-tensioner seat belts are activated, a loud noise may be heard and fine dust, which may appear to be smoke, may be visible in the passenger compartment. These are normal operating conditions and are not hazardous.
- o Although it is harmless, the fine dust may cause skin irritation and should not be breathed for prolonged periods. Wash all exposed skin areas thoroughly after an accident in which the pre-tensioner seat belts were activated.

**CAUTION:**

- o The sensor that activates the SRS air bag is connected with the pre-tensioner seat belt. The SRS air bag warning light  on the instrument panel will illuminate for approximately 6 seconds after the ignition key has been turned to the "ON" position, and then it should turn off.
- o If the pre-tensioner seat belt is not working properly, this warning light will illuminate even if there is no malfunction of the SRS air bag. If the SRS air bag warning light does not illuminate when the ignition key is turned to the "ON" position, remains illuminated after approximately 6 seconds when the ignition key is turned to the "ON" position, or if it illuminates while the vehicle is being driven, have an authorized Hyundai dealer inspect the advanced SRS air bag system as soon as possible.

**WARNING:**

- o Pre-tensioners are designed to operate only one time. After activation, pre-tensioner seat belts and seat belt buckles must be replaced. All seat belts, of any type, should always be replaced after they have been worn during a collision.
- o The pre-tensioner seat belt assembly mechanisms become hot during activation. Do not touch the pre-tensioner seat belt assemblies for several minutes after they have been activated.
- o Do not attempt to inspect or replace the pre-tensioner seat belts yourself. This must be done by an authorized Hyundai dealer.
- o Do not strike the pre-tensioner seat belt or buckle assemblies.
- o Do not attempt to service or repair the pre-tensioner seat belt system in any manner.

**WARNING:**

- o Improper handling of the pre-tensioner seat belt assemblies, and failure to heed the warnings not to strike, modify, inspect, replace, service or repair the pre-tensioner seat belt and buckle assemblies may lead to improper operation or inadvertent activation and serious injury.
- o Always wear the seat belts when driving or riding in a motor vehicle.

تلفن شبانه روزی: ۰۲۱-۸۸۶۲۰۸۵

FarmaSOS.com

ADVANCED SUPPLEMENTAL RESTRAINT (AIR BAG) SYSTEM (SRS)

B240D01CM-AAT

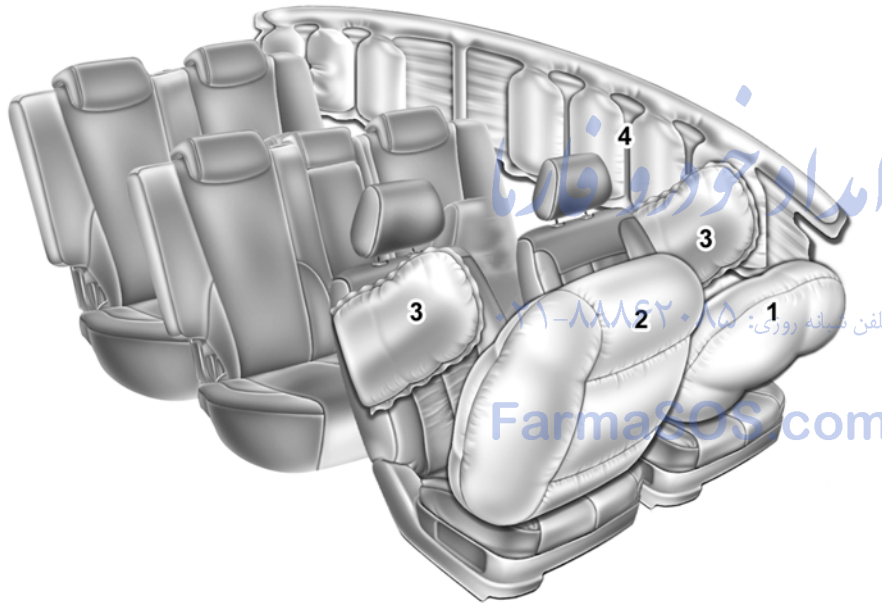

1. Driver's front air bag
2. Passenger's front air bag
3. Side impact air bag
4. Curtain air bag (Both sides)

DRIVER'S AND PASSENGER'S FRONT AIR BAG

B240A01CM-AAT

Driver's Air bag



Your Hyundai is equipped with an advanced Supplemental Restraint (Air bag) System. The indications of the system's presence are the letters "SRS AIR BAG" embossed on the air bag pad cover in the steering wheel and the passenger's side front panel pad above the glove box.

The Hyundai SRS consists of air bags installed under the pad covers in the center of the steering wheel and the passenger's side front panel above the glove box. The purpose of the SRS is to provide the vehicle's driver and/or the front passenger with additional protection than that offered by the seat belt system alone, in case of a frontal impact of sufficient severity.

The SRS uses a collection of sensors to gather information about the driver's and front passenger's seat position, the driver's and front passenger's seat belt usage and impact severity.

The driver's seat position sensors, which are installed on the seat track, determine if the seats are fore or aft of a reference position. Similarly, the seat belt usage sensors determine if the driver and front passenger's seat belts are fastened. These sensors provide the ability to control the SRS deployment based on how close the driver's seat is to the steering wheel, whether or not the seat belts are fastened, and how severe the impact is.

The advanced SRS offers the ability to control the air bag inflation with two levels. A first stage level is provided for moderate-severity impacts. A second stage level is provided for more severe impacts.

According to the impact severity, driver's seating position, the SRSCM(SRS Control Module) controls the air bag inflation. Failure to properly wear seat belts can increase the risk or severity of injury in an accident.

Additionally, your Hyundai is equipped with an occupant classification system in the front passenger's seat. The occupant classification system detects the presence of a passenger in the front passenger's seat and will turn off the front passenger's air bag under certain conditions. For more detail, see "Occupant Classification System" later in this section.

**CAUTION:**

If the seat position sensor is not working properly, the SRS air bag warning light  on the instrument panel will illuminate even if there is no malfunction of the SRS air bag system, because the SRS air bag warning light is connected with the seat position sensor. If the SRS air bag warning light does not illuminate when the ignition key is turned to the "ON" position, if it remains illuminated after coming on for approximately 6 seconds, or if it illuminates while the vehicle is being driven, have an authorized Hyundai dealer inspect the seat position sensor and the advanced SRS air bag system as soon as possible.

**WARNING:**

- o Modification to the seat structure can adversely affect the seat position sensor and cause the air bag to deploy at a different level than should be provided.
- o Do not place any objects underneath the front seats which could damage the seat position sensor or interfere with the occupant classification system.
- o Do not place any objects that may cause magnetic fields near the front seats. These may cause a malfunction of the seat position sensor.

NOTE:

- o Be sure to read information about the SRS on the labels provided on the sun visor.
- o Advanced air bags are combined with pre-tensioner seat belts to help provide enhanced occupant protection in frontal crashes. Front air bags are not intended to deploy in light collisions in which protection can be provided by the pre-tensioner seat belt.
- o If you are considering modification of your vehicle due to a disability, please contact the Hyundai Customer Assistance Center at 1-800-633-5151.

**WARNING:**

Always use seat belts and child restraints – every trip, every time, everyone! Air bags inflate with considerable force and in the blink of an eye. Seat belts help keep occupants in proper position to obtain maximum benefit from the air bag. Even with advanced air bags, improperly and unbelted occupants can be severely injured when the air bag inflates. Always follow the precautions about seat belts, air bags and occupant safety contained in this manual.

To reduce the chance of serious or fatal injuries and receive the maximum safety benefit from your restraint system:

- o Never place a child in any child or booster seat in the front seat (see child restraints 1-33).
- o ABC – Always Buckle Children in the back seat. It is the safest place for children of any age to ride
- o Front and side impact air bags can injure occupants improperly positioned in the front seats

**WARNING:**

- o Move your seat as far back as possible from the front airbags, while still maintaining control of the vehicle.
- o Never sit or lean unnecessarily close to the front or side air bags
- o Never lean against the door or center console – always sit in an upright position
- o Do not allow a passenger to ride in the front seat when the “Passenger Air bag OFF” indicator is illuminated, because the air bag will not deploy in the event of a moderate or severe frontal crash.
- o Never place objects over or near any air bag module (front or side impact air bags), because these objects can injure passengers in a crash
- o Never place covers, blankets or aftermarket seat warmers on the passenger seat as these may interfere with the occupant classification system
- o Do not tamper with or disconnect SRS wiring or other components. Injuries could result from inadvertent deployment or failure of the air bag to deploy in a crash.

**WARNING:**

- o If the SRS air bag warning light (see pg 1-68) remains illuminated while the vehicle is being driven, have an authorized Hyundai dealer inspect the air bag system as soon as possible.
- o Air bags can only be used once – have an authorized Hyundai dealer replace the air bag immediately after deployment.
- o The SRS is designed to deploy the front air bags only when an impact is sufficiently severe and when the impact angle is within a range as measured from the forward longitudinal axis of the vehicle. The front air bags will not deploy in side, rear or rollover impacts. Additionally, the air bags will only deploy once. Seat belts must be worn at all times.



WARNING:

- Front air bags are not intended to deploy in side-impact, rear-impact or rollover crashes. In addition, air bags will not deploy in frontal crashes below the deployment threshold.

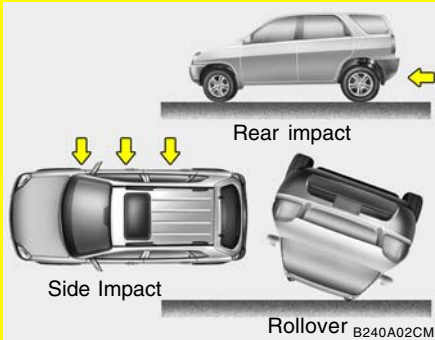

- Move your seat as far back as practical from the front air bags, while still maintaining control of the vehicle. You and your passengers should never sit or lean unnecessarily close to the air bags. Improperly positioned drivers and passengers can be severely injured by inflating air bags.



WARNING:

- No objects should be placed over or near the air bag modules on the steering wheel, instrument panel, and the front passenger's panel above the glove box, because any such object could cause harm if the vehicle is in a crash severe enough to cause the air bags to deploy.
- If the air bags deploy, they must be replaced by an authorized Hyundai dealer. Deployed air bags WILL NOT inflate again and will provide no protection in subsequent collisions.
- Do not tamper with or disconnect SRS wiring or other components of the SRS system. Doing so could result in injury, due to accidental deployment of the air bags or by rendering the SRS inoperative.
- Do not install a child restraint system in the front passenger seat position. A child restraint system must never be placed in the front seat. The infant or child could be severely injured or killed by an air bag deployment in case of an accident.



WARNING:

- Children younger than 13 years must always be properly restrained in the rear seat. Never allow children to ride in the front passenger seat. If a child over 13 must be seated in the front seat, he or she must be properly belted and the seat should be moved as far back as possible.
- For maximum safety protection in all types of crashes, all occupants including the driver should always wear their seat belts whether or not an air bag is also provided at their seating position to minimize the risk of severe injury or death in the event of a crash. Do not sit or lean unnecessarily close to the air bag while the vehicle is in motion.
- Sitting improperly or out of position can result in serious or fatal injury in a crash. All occupants should sit upright in their seats with their feet on the floor until the vehicle is parked and the ignition key is removed.

! WARNING:

- o The SRS air bag system must deploy very rapidly to provide protection in a crash. If an occupant is out of position because of not wearing a seat belt, the air bag may forcefully contact the occupant causing serious or fatal injuries.
- o Your vehicle has been designed to absorb impact and deploy the air bag(s) in certain collisions. Installing aftermarket bumper guards, side steps or replacing a bumper with non-genuine parts may adversely affect your vehicles collision and air bag deployment performance.

B240B01CM-AAT

SRS Components and Functions

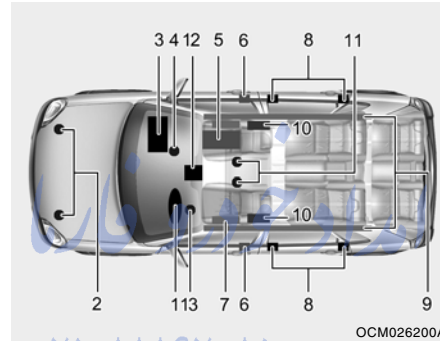

The SRS consists of the following components:

1. Driver's Air bag Module
2. Front Impact Sensor
3. Passenger's Air bag Module
4. Passenger Air bag Off Indicator (Front passenger's seat only)
5. Occupant Classification System (Front passenger's seat only)
6. Pre-tensioner Seat Belt
7. Driver's Seat Position Sensors
8. Side Impact Sensor
9. Curtain Air bag

10. Driver's and Front Passenger's Side Air bag
11. Driver's and Front Passenger's Seat Belt Usage Sensors
12. SRS Control Module (SRSCM)
13. SRS Service Reminder Indicator (SRI)

The SRSCM continually monitors all elements while the ignition is "ON" to determine if a frontal or near-frontal impact is severe enough to require air bag deployment or pre-tensioner seat belt deployment.

The SRS service reminder indicator (SRI) on the instrument panel will illuminate for about 6 seconds after the ignition key is turned to the "ON" position or after the engine is started, after which the SRI should go out.



B240B01L

The air bag modules are located both in the center of the steering wheel and in the front passenger's panel above the glove box. When the SRSCM detects a sufficiently severe impact to the front of the vehicle, it will automatically deploy the front air bags.



B240B02L

Upon deployment, tear seams molded directly into the pad covers will separate under pressure from the expansion of the air bags. Further opening of the covers then allows full inflation of the air bags.

FarmaSOS.com



B240B03L

A fully inflated air bag, in combination with a properly worn seat belt, slows the driver's or the passenger's forward motion, reducing the risk of head and chest injury.

After complete inflation, the air bag immediately starts deflating, enabling the driver to maintain forward visibility, and the ability to steer or operate other controls.

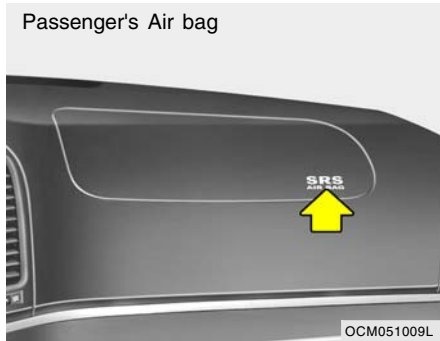

CAUTION:
 When installing a container of liquid air freshener inside the vehicle, do not place it near the instrument cluster nor on the instrument panel surface. If there is any leakage from the air freshener onto these areas (instrument cluster, instrument panel or air ventilator), it may damage these parts. If the liquid from the air freshener does leak onto these areas, wash them with water immediately.

WARNING:
 If an air bag deploys, there may be a loud noise followed by a fine dust released in the vehicle. These conditions are normal and are not hazardous - the air bags are packed in this fine powder. The dust generated during air bag deployment may cause skin or eye irritation as well as aggravate asthma for some persons. Always wash all exposed skin areas thoroughly with lukewarm water and a mild soap after an accident in which the air bags were deployed.

WARNING:

- o The SRS can function only when the ignition key is in the "ON" position. If the SRS SRI does not illuminate or continuously remains on after illuminating for about 6 seconds when the ignition key is turned to the "ON" position, or after the engine is started, illuminates while driving, the SRS is not working properly. If this occurs, have your vehicle immediately inspected by your Hyundai dealer.
- o Before you replace a fuse or disconnect a battery terminal, turn the ignition key to the "LOCK" position or remove the ignition key. Never remove or replace the air bag related fuse(s) when the ignition key is in the "ON" position. Failure to heed this warning will cause the SRS SRI to illuminate.

B990A01CM-AAT

Occupant Classification System

Your vehicle is equipped with an occupant classification system in the front passenger's seat. The Occupant Classification system is designed to detect the presence of a properly-seated front passenger and determine if the passenger's front air bag should be enabled (may inflate or not). The driver's front air bag is not affected or controlled by the Occupant Classification System.



OCM052116N

If the front passenger seat is occupied by a person that the system determines to be of adult size, and he/she sits properly (sitting upright with the seatback in an upright position, centered on the seat cushion with their seat belt on, legs comfortably extended and their feet on the floor), the passenger air bag off indicator will be turned off (The "OFF" will not illuminate) and the front passenger's air bag will be able to inflate, if necessary, in frontal crashes.

You will find the passenger air bag off indicator on the center facia panel. When this indicator is ON, (The "OFF" will illuminate) the front passenger's air bag will not deploy. The side air bag will not deploy if the front passenger seat is unoccupied. The side air bag may deploy if the front seat is occupied by a small occupant. The following table summarizes the functioning of the system depending on the front passenger seat occupant.

Condition and operation in the front passenger occupant classification system

Condition detected by the occupant classification system	passenger air bag off indicator light	SRS warning light	Front passenger air bag
1. Adult*1	Off	Off	Activated
2. Child*2 or child restraint system*3	On	Off	Deactivated
3. Unoccupied	On	Off	Deactivated

*1) The system judges a person of adult size as an adult. When a smaller adult sits in the front passenger seat, the system may recognize him/her as a child depending on his/her physique and posture.

*2) Do not allow children to ride in the front passenger seat. When a larger child who has outgrown a child restraint system sits in the front passenger seat, the system may recognize him/her as an adult depending on his/her physique or posture, or objects in the lap of the child.

*3) Never install a child restraint system on the front passenger seat.

! **WARNING:**
Riding in an improper position or placing weight on the front passenger's seat when it is unoccupied by a passenger adversely affects the occupant classification system (OCS).

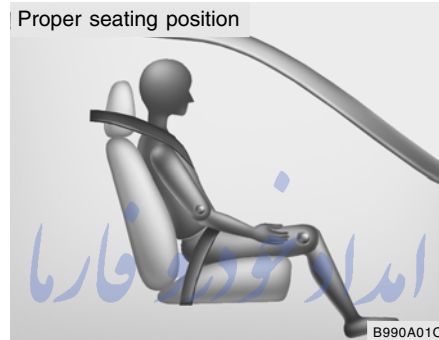

When an adult is seated in the front passenger seat, if the passenger air bag off indicator is on, turn the ignition key to "LOCK" and ask the passenger to sit properly (sitting upright with the seat back in an upright position, centered on the seat cushion with their seat belt on, legs comfortably extended and their feet on the floor). Restart the engine and have the person remain in that position for about 40 seconds. This will allow the system to detect the person and to enable the passenger air bag. If the passenger air bag off indicator is still on, turn the ignition key to "LOCK" and ask the passenger to sit properly and restart the engine again. If the "PASSENGER AIR BAG OFF" indicator is still on, ask the passenger to move to the rear seat.

! **WARNING:**

- Do not do any of the following. Placing weight on the front passenger's seat or sitting incorrectly adversely affects occupant classification system operation.

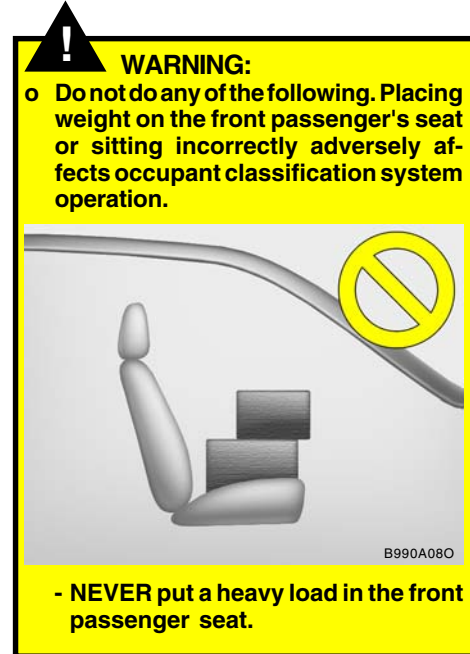

B990A080

- NEVER put a heavy load in the front passenger seat.



- NEVER excessively recline the front passenger seatback.



- NEVER sit with hips shifted towards the front of the seat.



- NEVER lean on the center console.
- NEVER lean on the door trim.
- NEVER sit on one side of the front passenger seat.



- NEVER place feet on the dashboard.

**WARNING:**

- o A smaller-stature adult who is not seated correctly (for example: seat excessively reclined, leaning on the center console, or hips shifted forward in the seat) can cause a condition where the advanced frontal air bag system senses less weight than if the occupant were seated properly (sitting upright with the seatback in an upright position, centered on the seat cushion with their seat belt on, legs comfortably extended and their feet on the floor).
- o This condition can result in an adult potentially being misclassified and illumination of the passenger air bag off indicator.

**WARNING:**

Do not allow an adult passenger to ride in the front seat when the passenger air bag off indicator is illuminated, because the air bag will not deploy in the event of a crash. If the passenger air bag off indicator remains illuminated after the passenger repositions themselves properly and the car is restarted, Hyundai recommends that passenger move to the rear seat because the passenger's front air bag will not deploy.

تلفن شبانه روزی: ۰۲۱-۸۸۶۲۰۸۵

NOTE:

The passenger air bag off indicator illuminates for about 4 seconds after the ignition key is turned to the "ON" position or after the engine is started. If the front passenger seat is occupied, the occupant classification sensor will then classify the front passenger within approximately 10 seconds after the ignition is turned on.

**CAUTION:**

If the occupant classification system is not working properly, the SRS air bag warning light  on the instrument panel will illuminate because the passenger's front air bags are connected with the occupant classification system. If there is a malfunction of the occupant classification system, the passenger air bag off indicator will illuminate and the passenger's front air bags will not inflate in frontal impact crashes even if there is adult occupant in the front passenger's seat. If the SRS air bag warning light does not illuminate when the ignition key is turned to the "ON" position, remains illuminated after approximately 6 seconds when the ignition key is turned to the "ON" position, or if it illuminates while the vehicle is being driven, have an authorized Hyundai dealer inspect the occupant classification system and the SRS air bag system as soon as possible.

**WARNING:**

- o Even though your vehicle is equipped with the occupation classification system, never install a child restraint system in the front passenger's seat. A deploying air bag can forcefully strike a child resulting in serious injuries or death. Any child under 13 years of age should ride in the rear seat. Children too large for child restraints should use the available lap/shoulder belts. No matter what type of crash, children of all ages are safer when restrained in the rear seat.
- o If the "PASSENGER AIR BAG OFF" indicator is illuminated when the front passenger's seat is occupied by an adult and he/she sits properly (sitting upright with the seatback in an upright position, centered on the seat cushion with their seat belt on, legs comfortably extended and their feet on the floor), have that person sit in the rear seat.

**WARNING:**

- o If you change the weight on the front passenger seat just after sit-in or restart of the engine, the "PASSENGER AIR BAG OFF" indicator may be turned on or off for a few seconds, disabling or enabling the passenger air bags. After the initial stage of about 30 seconds, the "PASSENGER AIR BAG OFF" indicator will not toggle on and off.
- o Do not modify or replace the front passenger seat. Don't place anything on or attach anything such as a blanket or after market seat heater to the front passenger seat. This can adversely affect the occupant classification system.
- o Do not sit on sharp objects such as tools when occupying the front passenger seat. This can adversely affect the occupant classification system.
- o Do not use accessory seat covers on the front seats.

**WARNING:**

- o Accident statistics show that children are safer if they are restrained in the rear, as opposed to the front seat. It is recommended that child restraints be secured in a rear seat, including an infant riding in a rear-facing infant seat, a child riding in a forward-facing child seat and an older child riding in a booster seat.
- o Air bags can only be used once – have an authorized Hyundai dealer replace the air bag immediately after deployment.

B990B03MC-AAT

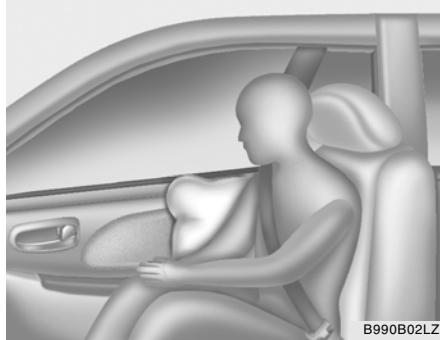
Side Impact Air bag

B990B02LZ

Your Hyundai is equipped with a side impact air bag in each front seat. The purpose of the air bag is to provide the vehicle's driver and/or the front passenger with additional protection than that offered by the seat belt alone. The side impact air bags are designed to deploy only during certain side-impact collisions, depending on the crash severity, angle, speed and point of impact. The side impact air bags are not designed to deploy in all side impact situations.

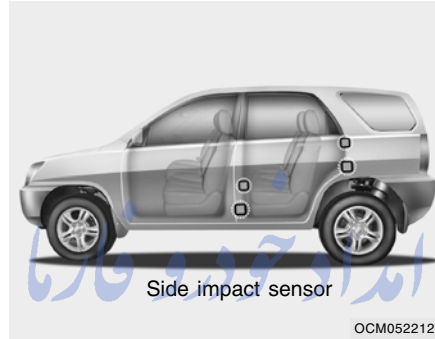

OCM052212L

Important Safety Notes on the Side Impact Air bag System

تلفن شبانه روزی: ۰۲۱-۸۸۸۸۸۸۸۸
 Following are a number of safety points concerning this system which should always be observed to ensure risk of injury is reduced in an accident.

! **WARNING:**

- o The side impact air bag is supplemental to the driver's and the passenger's seat belt systems and is not a substitute for them. Therefore your seat belts must be worn at all times while the vehicle is in motion. The air bags deploy only in certain side impact conditions severe enough to cause significant injury to the vehicle occupants.
- o For best protection from the side impact air bag system and to avoid being injured by the deploying side impact air bag, both front seat occupants should sit in an upright position with the seat belt properly fastened. The driver's hands should be placed on the steering wheel at the 9:00 and 3:00 positions. The passenger's arms and hands should be placed on their laps.
- o Do not use any accessory seat covers. Use of seat covers could reduce or prevent the effectiveness of the air bag system.

**WARNING:**

- o Do not install any accessories on the side or near the side impact air bag.
- o Do not place any objects over the air bag or between the air bag and yourself.
- o Do not place any objects (an umbrella, bag, etc.) between the front door and the front seat. Such objects may become dangerous projectiles and cause injury if the supplemental side impact air bag inflates.
- o To prevent unexpected deployment of the side impact air bag that may result in personal injury, avoid impact to the side impact sensor when the ignition key is on.

B990C02JM-AAT

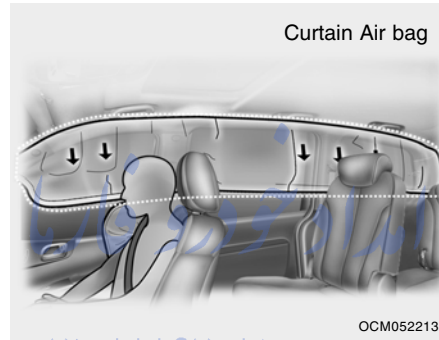
Curtain Air bag

Curtain air bags are located along both sides of the roof rails above the front and rear doors.

They are designed to help protect the heads of the front seat occupants and the rear outboard seat occupants in certain side impact collisions.

The curtain air bags are designed to deploy only during certain side impact collisions, depending on the crash severity, angle, speed and impact. The curtain air bags are not designed to deploy in all side impact situations, collisions from the front or rear of the vehicle or in most rollover situations.

Important Safety Notes for Curtain Air Bag Systems

Following are a number of safety points concerning this system which should always be observed to ensure risk of injury is reduced in an accident.

**WARNING:**

- o Before installing child restraints, always refer to the "Child Restraint System" section to ensure correct installation and occupant protection is maximized.
- o Make sure that the occupant does not have any body parts (head, arms & legs) protruding outside the restraining system. If an inflating air bag was to strike an infant child on the head, it may cause serious injury.
- o Ensure the opening for the Curtain Air Bag System remains unobstructed at all times, so that the air bags can inflate properly if needed.

**WARNING:**

- o The built in coat hooks should only be used for light weight clothing. Ensure that clothing pockets are free of any heavy or sharp objects. When using coat hooks, do not hang clothes on coat hangers.
- o The space between the occupant and the curtain air bag must never be occupied by children, passengers or pets. Occupants should never lean out or have any parts of their body protruding from the window while the engine is running.
- o Do not move the sun visor out to cover the side window if there is an item attached to it such as garage door remote control, pens, compact disc pocket, air fresheners or the like. These objects may cause injury if the Curtain Air Bag is deployed.
- o Where sun blinds are fitted to the rear doors, these must not obstruct or impair the air bag in any way.

**WARNING:**

- o Do not install any accessories or children's toys in the Curtain Air Bag deployment zones, as this may impair the operation of the system or throw parts of them into the vehicle cabin causing injury to occupants if the system is deployed.
- o To maintain the integrity of the Curtain Air Bag system, any work, removal or installation of the air bag and associated components (such as roof lining and side trims) should always be performed by an authorized Hyundai dealer.

FarmaSOS.com

B240C01CM-AAT

SRS Care

The SRS is virtually maintenance free and there are no parts you can safely service by yourself. If the SRS SRI (Service Reminder Indicator) does not illuminate, or continuously remains on, have your vehicle immediately inspected by your Hyundai dealer.

Any work on the SRS system, such as removing, installing, repairing, or any work on the steering wheel must be performed by a qualified Hyundai technician. Improper handling of the air bag system may result in serious personal injury.

**WARNING:**

Never tamper with or disconnect the air bag system sensors & wiring. You could cause the air bag to inflate or the system may fail to operate which may result in fatal personal injury.



1JBH3051L

**WARNING:**

- o Do not install a child restraint system in the front passenger seat position. A child restraint system must never be placed in the front seat. The infant or child could be severely injured or killed by an air bag deployment in case of an accident.
- o Modification to SRS components or wiring, including the addition of any kind of badges to the pad covers or modifications to the body structure, can adversely affect SRS performance and lead to possible injury.

**WARNING:**

- o For cleaning the air bag pad covers, use only a soft, dry cloth or one which has been moistened with plain water. Solvents or cleaners could adversely affect the air bag covers and proper deployment of the system.
- o No objects should be placed over or near the air bag modules on the steering wheel, instrument panel, and the front passenger's panel above the glove box, because any such object could cause harm if the vehicle is in a crash severe enough to cause the air bags to inflate.
- o If the air bags inflate, they must be replaced by an authorized Hyundai dealer.
- o Do not tamper with or disconnect SRS wiring, or other components of the SRS system. Doing so could result in injury, due to accidental inflation of the air bags or by rendering the SRS inoperative.

**WARNING:**

- o If components of the air bag system must be discarded, or if the vehicle must be scrapped, certain safety precautions must be observed. Your Hyundai dealer knows these precautions and can give you the necessary information. Failure to follow these precautions and procedures could increase the risk of personal injury.
- o If your car was flooded and has soaked carpeting or water on the floor, don't try to start the engine; have the car towed to an authorized Hyundai dealer.
- o Do not replace bumper or the bumper guard with the one other than Hyundai genuine parts. Otherwise, it can adversely affect SRS performance and lead to an increased risk of injury.

B240D02JM-AAT

Additional Safety Precautions

- o **Never let passengers ride in the cargo area (trunk) or on top of a folded-down back seat.** All occupants should sit upright, fully back in their seats with their seat belts on and their feet on the floor.
- o **Passengers should not move out of or change seats while the vehicle is moving.** A passenger who is not wearing a seat belt during a crash or emergency stop can be thrown against the inside of the vehicle, against other occupants, or out of the vehicle.
- o **Each seat belt is designed to restrain one occupant.** If more than one person uses the same seat belt, they could be seriously injured or killed in a collision.
- o **Do not use any accessories on seat belts.** Devices claiming to improve occupant comfort or reposition the seat belt can reduce the protection provided by the seat belt and increase the chance of serious injury in a crash.
- o **Passengers should not place hard or sharp objects between themselves and the air bags.** Carrying hard or sharp objects on your lap or in your mouth can result in injuries if an air bag inflates.

- o **Keep occupants away from the air bag covers.** All occupants should sit upright, fully back in their seats with their seat belts on and their feet on the floor. If occupants are too close to the air bag covers, they could be injured if the air bags inflate.
- o **Do not attach or place objects on or near the air bag covers.** Any object attached to or placed on the front or side impact air bag covers could interfere with the proper operation of the air bags.
- o **Do not modify the front seats.** Modification of the front seats could interfere with the operation of the supplemental restraint system sensing components or side impact air bags.
- o **Do not place items under the front seats.** Placing items under the front seats could interfere with the operation of the supplemental restraint system sensing components and wiring harnesses.
- o **Never hold an infant or child on your lap.** The infant or child could be seriously injured or killed in the event of a crash. All infants and children should be properly restrained in appropriate child safety seats or seat belts in the rear seat.



WARNING:

- o **Sitting improperly or out of position can cause occupants to be shifted too close to a deploying air bag, strike the interior structure or be thrown from the vehicle resulting in serious injury or death.**
- o **Always sit upright with the seatback in an upright position, centered on the seat cushion with your seat belt on, legs comfortably extended and your feet on the floor.**

Adding Equipment to or Modifying Your Air bag-Equipped Vehicle.

If you modify your vehicle by changing your vehicle's frame, bumper system, front end or side sheet metal or ride height, this may affect the operation of your vehicle's air bag system.

62 INSTRUMENT CLUSTER AND INDICATOR LIGHTS

B260A01CM-AAT

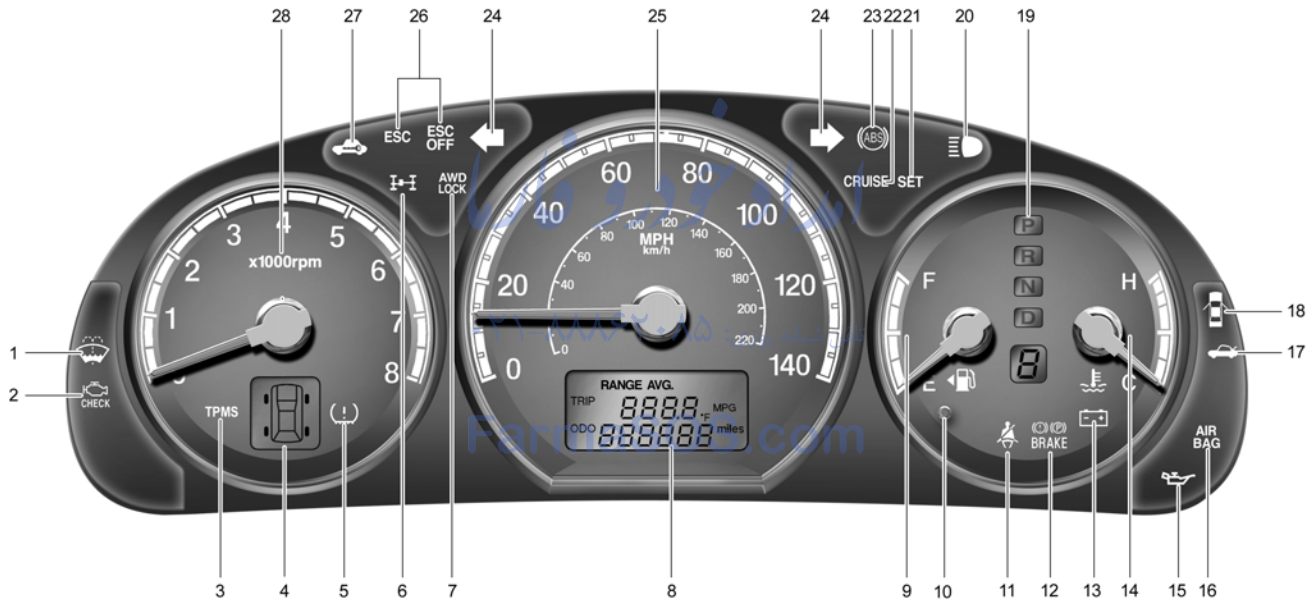

1. Low Windshield Washer Fluid Level Warning Light
2. Malfunction Indicator Light (MIL)
3. TPMS (Tire Pressure Monitoring System) Malfunction Indicator
4. Low Tire Pressure Position Telltale
5. Low Tire Pressure Telltale
6. AWD System Warning Light (If installed)
7. AWD Lock Indicator Light (If installed)
8. Odometer / Tripmeter / Trip Computer (If installed)
9. Fuel Gauge
10. Low Fuel Warning Light
11. Seat Belt Warning Light (Driver's Side)
12. Parking Brake/Low Brake Fluid Level Warning Light
13. Charging System Warning Light
14. Coolant Temperature Gauge
15. Low Oil Pressure Warning Light
16. Supplemental Restraint (Air bag) System Service Reminder Indicator (SRI)
17. Tail Gate Open Warning Light
18. Door Ajar Warning Light
19. Automatic Transaxle Position Indicator Light (If installed)
20. High Beam Indicator Light
21. Cruise SET Indicator Light
22. Cruise Indicator Light
23. ABS Service Reminder Indicator
24. Turn Signal Indicator Light
25. Speedometer
26. Electronic Stability Control (ESC) Indicator Light
27. Immobilizer Warning Indicator Light (If Installed)
28. Tachometer

WARNING AND INDICATOR LIGHTS

B260S01NF-GAT



Low Windshield Washer Fluid Level Warning Light

The low windshield washer fluid warning light comes on when the washer fluid reservoir is approaching empty. When it comes on, add washer fluid at your earliest opportunity.

B260N02A-AAT



Malfunction Indicator Light

This light illuminates when there is a malfunction of an exhaust gas related component, and the system is not functioning properly so that the exhaust gas regulation values are not satisfied. This light will also illuminate when the ignition key is turned to the "ON" position, and then it will go out in a few seconds after the engine is started. If it illuminates while driving, or does not illuminate when the ignition key is turned to the "ON" position, take your car to your nearest authorized Hyundai dealer and have the system checked.

B265W01JM-AAT



TPMS (Tire pressure monitoring system) malfunction indicator

TPMS malfunction indicator illuminates for 3 seconds after the ignition key is turned to the "ON" position. If the warning light does not illuminate, or remains when you turned the ignition key to the "ON" position, the Tire Pressure Monitoring System is not working properly. If this occurs, have your vehicle checked by an authorized Hyundai dealer as soon as possible. The warning light also comes on and stays on when there is a malfunction with the Tire Pressure Monitoring System. If this happens, the system may not monitor the tire pressure. Have the system checked by an authorized Hyundai dealer as soon as possible.



WARNING:

- o **The TPMS cannot alert you to severe and sudden tire damage caused by external factors.**
- o **If you feel any vehicle instability, immediately take your foot off the accelerator and slowly move to a safe position off the road.**

B260W01CM-AAT



Low tire pressure telltale



Low tire pressure position telltale

The low tire pressure and position telltales illuminate for 3 seconds after the ignition key is turned to the "ON" position.

If the warning lights do not illuminate, or remain illuminate after the 3-second lamp check when you turned the ignition key to the "ON" position, the Tire Pressure Monitoring System is not working properly. If this occurs, have your vehicle checked by an authorized Hyundai dealer as soon as possible.

This warning lights will also illuminate if one or more of your tires is significantly under-inflated. The low tire pressure position telltale light will indicate which tire is significantly under-inflated by illuminating the corresponding position light.

You should stop and check your tires as soon as possible. If the warning lights illuminate while driving, reduce vehicle speed immediately and stop the vehicle.

Avoid hard braking and overcorrecting at the steering wheel. Inflate the tires to the proper pressure as indicated on the vehicle's tire information placard.

If you have a flat tire, the Low Tire Pressure and Position Telltales will illuminate.

Replace the flat tire with the spare tire (see page 3-12)

Each wheel is equipped with a tire pressure sensor mounted inside the tire behind the valve stems. You must use TPMS specific wheels. IT is recommended that you always have tires serviced by your Hyundai dealer or qualified technician.

After you replace the flat tire, the Low Tire Pressure and Position Telltales remain illuminated. This is normal; the system is not monitoring the spare tire pressure. Check the spare tire pressure to make sure it is correct.



CAUTION:

Never use a puncture-repair agent in a flat tire. If used, the tire pressure sensor will be damaged and will require replacement. Have the flat tire repaired by a Hyundai dealer or qualified technician as soon as possible.



WARNING:

Significantly low tire pressure makes the vehicle unstable and can contribute to loss of vehicle control and increased braking distances.

Continued driving on low pressure tires may cause the tires to overheat and fail.

B260T01O-GAT



AWD (All Wheel Drive) System Warning Light (If installed)

When the key is turned to the "ON" position, the AWD (All Wheel Drive) system warning light will illuminate and then go off in a few seconds.



CAUTION:

If the AWD system warning light () blinks while driving, this indicates that there is a malfunction in the AWD system. If this occurs, have your vehicle checked by an authorized Hyundai dealer as soon as possible.

B260V01CM-GAT



AWD (All Wheel Drive) Lock Indicator Light (If installed)

The AWD (All Wheel Drive) lock indicator light in the instrument cluster is illuminated when the AWD lock switch is pushed.

The purpose of this switch is to increase the drive power when driving on wet pavement, snow-covered roads and/or off-road. The AWD lock indicator light is turned off by pushing the switch again.

NOTE:

Do not use AWD LOCK on normal dry pavement conditions.

B260M02A-AAT



Low Fuel Level Warning Light



OCM052208

The low fuel level warning light illuminates when the fuel tank is approaching empty. When it illuminates, you should add fuel as soon as possible. Driving with the fuel level warning light on or with the fuel level below "E" can cause the engine to misfire and damage the catalytic converter.

B265E02MC-AAT



Seat Belt Warning Light and Chime

The driver's seat belt warning light and chime will activate to the following table when the ignition switch is in "ON" position.

Conditions		Warning Pattern	
Seat Belt	Vehicle Speed	Light-Blink	Chime-Sound
Unbuckled		6seconds	
Buckled		6seconds	None
Buckled → Unbuckled		6seconds	
Unbuckled	Above 6mph (10 km/h)	6seconds*1)	
	Below 3mph (5 km/h)	Stop*2)	

*1) Warning pattern repeats 11 times with 24 second. If the driver's seat belt is buckled, the light will stop within 6 seconds and chime will stop immediately.

*2) The light will stop within 6 seconds and chime will stop immediately.

B260H03A-AAT



Parking Brake/Low Brake Fluid Level Warning Light

! WARNING:

If you suspect brake trouble, have your brakes checked by a Hyundai dealer as soon as possible. Driving your car with a problem in either the brake electrical system or brake hydraulic system is dangerous, and could result in a serious injury or death.

Warning Light Operation

The parking brake/brake fluid level warning light should illuminate when the parking brake is applied and the ignition switch is turned to "ON" or "START". After the engine is started, the light should go out when the parking brake is released. If the parking brake is not applied, the warning light should illuminate when the ignition switch is turned to "ON" or "START", then go out when the engine starts. If the light illuminate at any other time, you should slow the vehicle and bring it to a complete stop in a safe location off the roadway.

The brake fluid level warning light indicates that the brake fluid level in the brake master cylinder is low and hydraulic brake fluid conforming to DOT 3 or DOT 4 specifications should be added. After adding fluid, if no other trouble is found, the car should be immediately and carefully driven to a Hyundai dealer for inspection. If further trouble is experienced, the vehicle should not be driven at all but taken to a dealer by a professional towing service.

Your Hyundai is equipped with dual-diagonal braking systems. This means you still have braking on two wheels even if one of the dual systems should malfunction. With only one of the dual systems working, more than normal pedal travel and greater pedal pressure are required to stop the car. Also, the car will not stop in as short a distance with only half of the brake system working. If the brakes malfunction while you are driving, shift to a lower gear for additional engine braking and stop the car as soon as it is safe to do so.

Parking brake warning chime (if installed)

The parking brake warning chime sounds to remind you that the parking brake is applied when you are driving above 6mph(10km/h). Always release the parking brake before you drive.

B260J02TG-AAT



Charging System Warning Light

The charging system warning light should illuminate when the ignition is turned on, then go out when the engine is running. If the light stays on while the engine is running, there is a malfunction in the electrical charging system. If the light illuminates while you are driving, have the system checked by your Hyundai dealer as soon as possible.

B260G02A-AAT



Low Oil Pressure Warning Light



CAUTION:

If the low oil pressure warning light stays on while the engine is running, serious engine damage may result. The oil pressure warning light comes on whenever there is insufficient oil pressure. In normal operation, it should illuminate when the ignition switch is turned on, then go out when the engine is started. If the oil pressure warning light stays on while the engine is running, there is a serious malfunction.

If this happens, stop the car as soon as it is safe to do so, turn off the engine and check the oil level. If the oil level is low, fill the engine oil to the proper level and start the engine again. If the light stays on with the engine running, turn the engine off immediately. In any instance where the oil light stays on when the engine is running, the engine should be checked by a Hyundai dealer before the car is driven again.

B260B02JM-AAT

AIR BAG SRS (Air bag) Service Reminder Indicator (SRI)

The SRS service reminder indicator (SRI) illuminates for about 6 seconds after the ignition key is turned to the "ON" position or after the engine is started, after which it will go out.

This light also illuminates when the SRS is not working properly. If the SRI does not illuminate, or continuously remains on after illuminating for about 6 seconds when you turned the ignition key to the "ON" position or started the engine, or if illuminates while driving, have the SRS inspected by an authorized Hyundai Dealer.

B260B01JM-AAT

Tail Gate Open Warning Light

This light remains on unless the tail gate and/or tail gate window is completely closed and latched.

B260L02HP-GAT

Door ajar warning light and chime

The door ajar warning light warns you that a door is not completely closed and the chime warns you that the key is in the ignition switch.

NOTE :
The warning chime only sounds whenever the key is in the ignition switch and the driver's side front door is open simultaneously. The chime sounds until the key is removed from the ignition switch or the driver's side front door is closed.

B260F02A-AAT

High Beam Indicator Light

The high beam indicator light illuminates whenever the headlights are switched to the high beam or flash position.

B260Q02E-GAT

CRUISE Cruise Indicator Light

The cruise indicator light in the instrument cluster is illuminated when the cruise control main switch on the end of the barrel is pushed.

When the cruise control main switch is pushed a second time, the cruise control system and light will turn off. Information on the use of cruise control may be found on page 1-120.

B260R01E-GAT

SET SET Indicator Light

The SET indicator light in the instrument cluster is illuminated when the cruise control switch is pushed downward to "SET (COAST)".

The SET indicator light does not illuminate when the control switch is in the "CANCEL" position.

FarmaSOS.com

تلفن شبانه روزی: 021-22000000

B260P03Y-GAT



ABS Service Reminder Indicator

When the key is turned to the "ON" position, the Anti-Lock Brake System indicator will illuminate and then go off in a few seconds. If the ABS SRI remains on, illuminates while driving, or does not illuminate when the key is turned to the "ON" position, this indicates that there may be a malfunction with the ABS.

If this occurs, have your vehicle checked by your Hyundai dealer as soon as possible. The normal braking system will still be operational, but without the assistance of the anti-lock brake system.



WARNING:

If both the ABS SRI and Parking Brake/ Brake fluid level warning lights remain "ON" or come on while driving, there may be a malfunction with E.B.D. (Electronic Brake Force Distribution). If this occurs, avoid sudden stops and have your vehicle checked by your Hyundai dealer as soon as possible.

B260D02A-AAT



Turn Signal Indicator Lights

The blinking green arrows on the instrument panel show the direction indicated by the turn signals. If the arrow comes on but does not blink, blinks more rapidly than normal, or does not illuminate at all, a malfunction in the turn signal system is indicated. Your Hyundai dealer should be consulted for repairs.

B265C03LZ-AAT



Electronic Stability Control Indicator Lights

The electronic stability control indicators change operation according to the ignition switch position and whether the system is in operation or not.

They will illuminate when the ignition key is turned to the "ON" position, but should go out after approximately three seconds. If the ESC or ESC-OFF indicator stays on, take your car to your authorized Hyundai dealer and have the system checked. See section 2 for more information about the ESC.

B260U02CM-AAT



Immobilizer Warning Light (If Installed)

This indicator light illuminates after the ignition key is turned to the "ON" position. The light goes out after the engine is running or after 30 seconds. If this light blinks for five seconds when the ignition key is turned to "ON" position, this indicates that the immobilizer system is not functioning correctly. At this time, consult your Hyundai dealer.

B270A01O-AAT

Brake Pad Wear Warning Sound

The front and rear disc brake pads have wear indicators that should make a high-pitched squealing or scraping noise when new pads are needed. The sound may come and go or be heard all the time when the vehicle is moving. It may also be heard when the brake pedal is pushed down firmly. Excessive rotor damage will result if the worn pads are not replaced. See your Hyundai dealer immediately.

INSTRUMENT CLUSTER

B280A01A-AAT

Fuel Gauge

The needle on the gauge indicates the approximate fuel level in the fuel tank. The fuel capacity is given in Section 9.

B290A02A-AAT

Engine Coolant Temperature Gauge

The needle on the engine coolant temperature gauge should stay in the normal range. If it moves across the dial to "H" (HOT), pull over and stop as soon as possible and turn off the engine. Then open the hood and, after the engine has cooled, check the coolant level and the water pump drive belt. If you suspect cooling system trouble, have your cooling system checked by a Hyundai dealer as soon as possible.

**WARNING:**

Never remove the radiator cap when the engine is hot. The engine coolant is under pressure and could erupt and cause severe burns. Wait until the engine is cool before adding coolant to the reservoir.

B330A03A-AAT

Tachometer

OCM015014L

The tachometer registers the speed of your engine in revolutions per minute (rpm).

**CAUTION:**

The engine should not be raced to such a speed that the needle enters the red zone on the tachometer face. This can cause severe engine damage and may void your warranty.

B300A01A-AAT

Speedometer

OCM051016L

Your Hyundai's speedometer is calibrated in miles per hour (on the outer scale) and kilometers per hour (on the inner scale).

FarmaSOS.com

B310B01CM-AAT

Odometer/Tripmeter

OCM052203R

1. Odometer

The odometer records the total driving distance in miles, and is useful for keeping a record for maintenance intervals.

NOTE:

Federal law forbids alteration of the odometer of any vehicle with the intent to change the number of the odometer. The alteration may void your warranty coverage.

2. Tripmeter



Pushing in the TRIP switch when the ignition switch is turned "ON" will display two tripmeters in kilometers or miles.



To shift from TRIP A to TRIP B, press the TRIP switch.

TRIP A: First distance you have traveled from your origination point to a first destination.

TRIP B: Second distance from the first destination to the final destination.



When the RESET switch is pressed for 1 second, the tripmeter will reset to 0.

TRIP COMPUTER

B400B01CM-AAT
(If Installed)

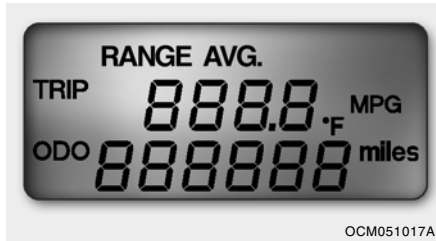

Trip computer is a microcomputer-controlled driver information system that displays information related to driving on the LCD.

Reset Switch



Push in the RESET switch more than 1 second to initialize the displayed information.

Trip Switch

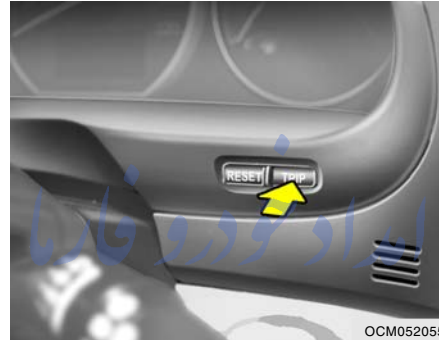

Pushing in the TRIP switch for when the ignition switch is in "ON" position changes the display as follows;

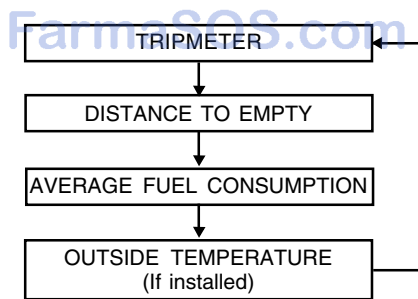

1. Tripmeter



- o This mode indicates the total distance travelled since the last tripmeter reset. Total distance is also reset to zero if the battery is disconnected.
- o Pressing the RESET switch for more than 1 second when the tripmeter is being displayed clears the tripmeter to zero.
- o The meter's working range is from 0 to 999.9.

2. Distance to Empty

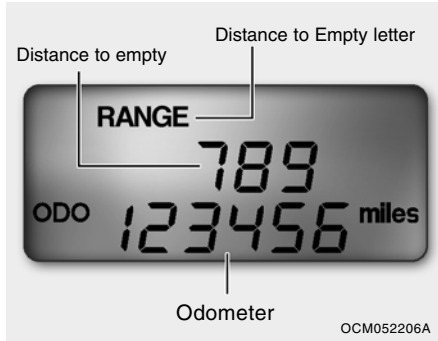

- o This mode indicates the estimated distance to empty from the current fuel level in the fuel tank.
- o The trip computer may not register additional fuel if less than 1.36 gallons (6 liters) of fuel are added to the vehicle.



- o When the estimated distance to empty is less than 30 miles, the distance to empty digits (---) will blink until more fuel is added.

NOTE:

- o **The estimated distance to empty can differ from the actual tripmeter according to driving conditions.**
- o **The estimated distance to empty can vary according to the driving conditions, driving pattern or vehicle speed.**

3. Average Fuel Consumption

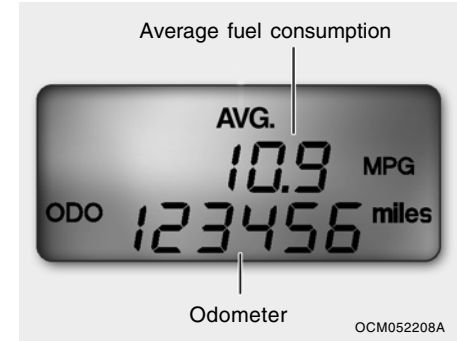

- o This mode calculates the average fuel consumption from the total fuel used and the distance since the last average consumption reset.
- o The total fuel used is calculated from the fuel consumption input.
- o Average fuel consumption is reset to zero (---) if the battery is disconnected.
- o To reset the average fuel consumption to zero (---), press and hold the RESET switch for more than 1 second.
- o When you drive 0.5 mile and less after resetting, the average fuel consumption will be displayed to '---'.

4. Outside temperature (If installed)



This mode indicates the outside temperature between -40°F and 167°F.

MULTI-FUNCTION LIGHT SWITCH

B340A01A-AAT

Combination Turn Signal, Headlight and High-beam Switch Turn signal operation

Pulling down on the lever causes the turn signals on the left side of the car to blink. Pushing upwards on the lever causes the turn signals on the right side of the car to blink. As the turn is completed, the lever will automatically return to the center position and turn off the turn signals at the same time. If either turn signal indicator light blinks more rapidly than usual, goes on but does not blink, or does not go on at all, there is a malfunction in the system. Check for a burned-out fuse or bulb or see your Hyundai dealer.

FarmaSOS.com

B340B01A-AAT

Lane Change Signal



To indicate a lane change, move the lever up or down to a point where it begins flashing.

The lever will automatically return to the center position when released.

B340C01CM-AAT

Headlight Switch

To operate the headlights, turn the barrel on the end of the multi-function switch. The first position turns on the parking lights, sidelights, tail lights and instrument panel lights. The second position turns on the headlights.

NOTE:

The ignition must be in the "ON" position to turn on the headlights.

Parking Light Auto Off

- o The purpose of this feature is to prevent the battery from being discharged. The system automatically turns off the headlights and parking lights when the driver removes the ignition key and opens the driver- side door.
- o With this feature, the parklight will be turned off automatically if the driver parks on the side of road at night.

If necessary, to keep the lights on when the ignition key is removed, perform the following :

- 1) Open the driver-side door.
- 2) Turn the parking lights OFF and ON again using the light switch on the steering column.

FarmaSOS.com

B340D01A-AAT

High-beam Switch

To turn on the headlight high beams, push the lever forward (away from you). The High Beam Indicator Light will come on at the same time. For low beams, pull the lever back toward you.

B340E01A-AAT

Headlight Flasher

To flash the headlights, pull the switch lever toward you, then release it. The headlights can be flashed even though the headlight switch is in the "OFF" position.

B340G01LZ-AAT

Auto Light (If Installed)

To operate the automatic light feature, turn the barrel on the end of the multi-function switch. If you set the multi-function switch to "AUTO", the tail lights and headlights will be turned automatically on or off according to external illumination conditions.

NOTE:

Turn the lights manually in foggy, cloudy and rainy conditions.

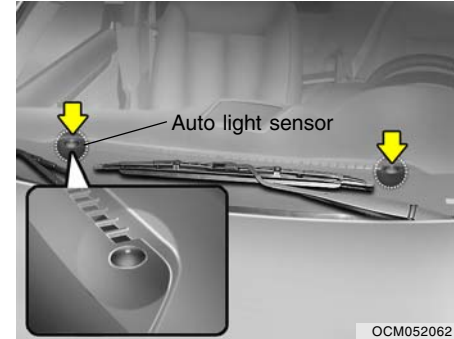
**NOTE:**

- o **Never place anything over the sensor located on the instrument panel to ensure better auto light system control.**
- o **Don't clean the sensor using a window cleaner.**
- o **If your vehicle has window tint or other types of coating on the windshield, the AUTO light system may not work properly.**

WINDSHIELD WIPER AND WASHER SWITCH

Windshield wiper/washer

Type A

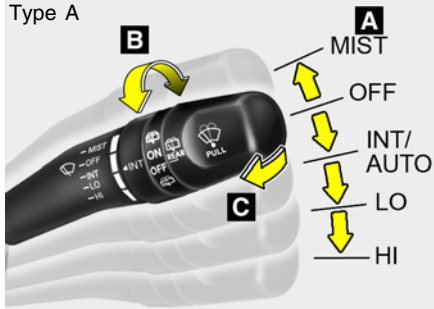

Type B

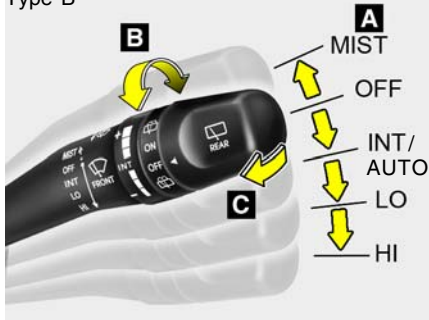

Rear window wiper/washer (if installed)

Type A

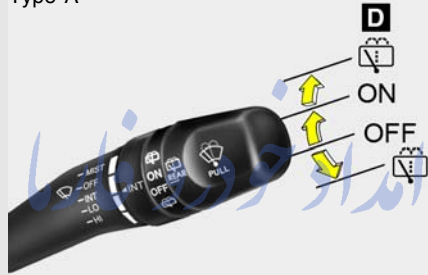

Type B

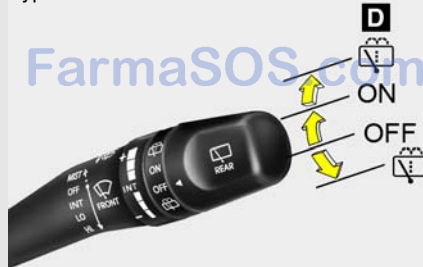



A : Wiper speed control

- MIST – Single wipe
- OFF – Off
- INT/AUTO – Intermittent wipe or Auto control wipe (If installed)
- LO – Low wiper speed
- HI – High wiper speed

B : Intermittent or Auto control wipe time adjustment

C : Wash with brief wipes

D : Rear wiper/washer control

-  - Spraying washer fluid
- ON - Continuous wipe
- OFF - Off
-  - Wash with brief wipes

B350A01CM-AAT

Windshield wiper

Type A

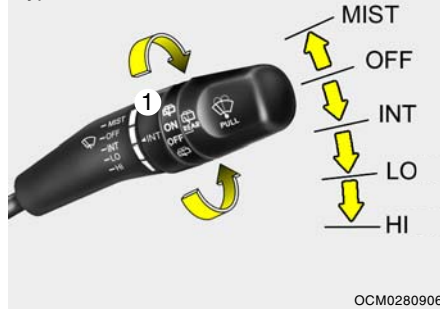

OCM0280906

Type B

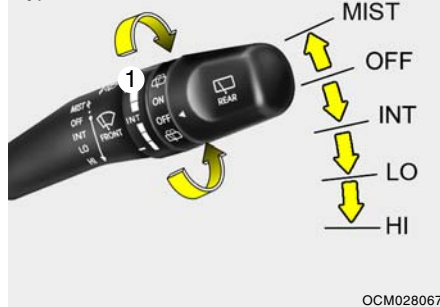

OCM028067

Operates as follows when the ignition switch is turned ON.

MIST : For a single wiping cycle, push the lever upward and release it with the lever in the OFF position. The wipers will operate continuously if the lever is pushed upward and held.

OFF : Wiper is not in operation

INT : Wiper operates intermittently at the same wiping intervals. Use this mode in a light rain or mist. To vary the speed setting, turn the speed control knob(1). (If installed)

LO : Normal wiper speed

HI : Fast wiper speed

NOTE: *تلفن شبانه روزی: ۸۸۶۲۰۸۵*
To prevent damage to the wiper system, do not attempt to wipe away heavy accumulations of snow or ice with the windshield wipers. Accumulated snow and ice should be removed manually. If there is only a light layer of snow or ice, operate the heater in the defrost mode to melt the snow or ice before using the wiper or activate the windshield wiper blade deicer.(if installed)

B350B02CM-AAT

Auto Wiper Operation (If Installed)

Type A

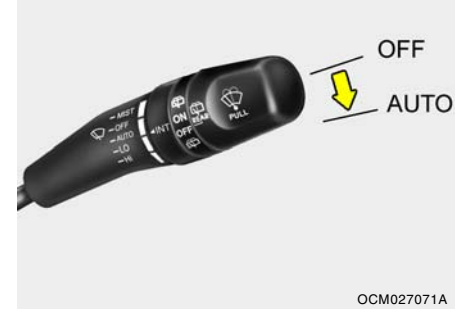

OCM027071A

Type B

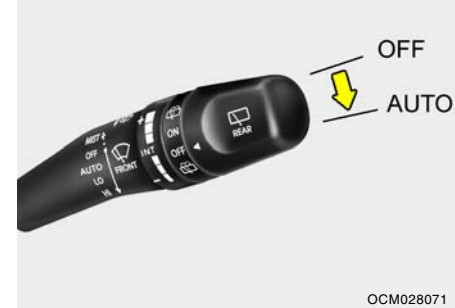

OCM028071

When the windshield wiper switch is placed in the "AUTO" position, the rain sensor located on the upper end of windshield glass senses the amount of rainfall and controls for the appropriate length of the intervals between wipes appropriately. If the ignition switch is turned "ON" when the wiper switch is set in "AUTO" mode, or the wiper switch is set in "AUTO" mode when the ignition switch is "ON", or the speed control knob is turned upward when the wiper switch is in "AUTO" mode, the wiper will operate once to perform a self-check of the system. Set the wiper to the "OFF" position when the wiper is not in use.

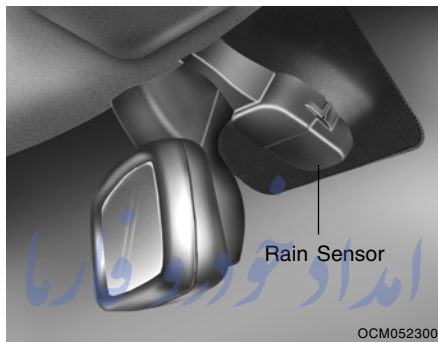
**NOTE:**

If there is heavy accumulation of snow or ice on the windshield glass, there will be a 10 minute waiting period prior to the operation of the automatic windshield wipers system.

WARNING: تلفن شبانه روزی: ۸۵

When the ignition switch is on and the windshield wiper switch is placed in the "AUTO" mode, please use caution to avoid any hand injury: The wiper system may automatically activate. The fingers or hand might be caught in the wiper.

- o Do not touch the upper end of the windshield glass facing the rain sensor.
- o Do not wipe the upper end of the windshield glass with a cloth.
- o Do not put pressure on the windshield glass.

B350B020-GAT

Windshield Washer Operation

Type A



Type B



To use the windshield washer, pull the wiper/washer lever toward the steering wheel.

When the washer lever is operated, the wipers automatically make two passes across the windshield. The washer continues to operate until the lever is released.

NOTE:

- o Do not operate the washer more than 15 seconds at a time or when the washer fluid reservoir is empty.
- o In icy or freezing weather, be sure the wiper blades are not frozen to the glass prior to operating the wipers.
- o In areas where water freezes in winter, use windshield washer fluid appropriate for cold weather.

Mist Wiper Operation



If a single wipe is desired in mist, push the windshield wiper and washer control lever upwards.

B350C01CM-AAT

Adjustable Intermittent Wiper Operation (if installed)

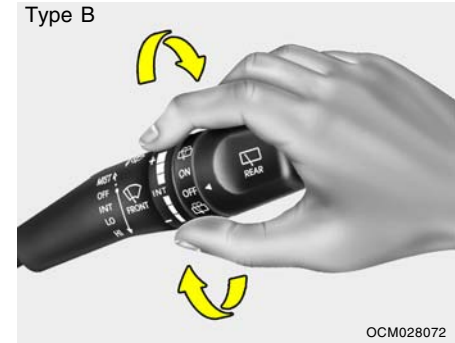

To use the intermittent wiper feature, place the wiper switch in the "INT" position.



With the switch in this position, the interval between wipes can be varied by turning the interval adjuster barrel.

B390A02CM-GAT

Rear Window Wiper and Washer (if installed)



Turn the switch to desired position to operate the rear wiper and washer.

-  : Wash with brief wipes
- ON : Normal wiper operation
- OFF : Wiper is not in operation
-  : Spraying washer fluid and wiping

NOTE:

Do not operate the washer continuously for more than 15 seconds or when the fluid reservoir is empty; this could damage the system. Do not operate the wiper when the window is dry; this can result in scratching as well as premature wiper blade wear. For the same reason, do not operate the washer when the washer fluid reservoir is empty.

FRONT FOG LIGHT SWITCH

B360A01CM-AAT
(If installed)



To turn on the front fog lights, push the switch in the "ON" position. They will light when the headlight switch is in the second position.

HAZARD WARNING SYSTEM

B370A01A-AAT



The hazard warning system should be used whenever you find it necessary to stop the car in a hazardous location. When you must make such an emergency stop, always pull off the road as far as possible. The hazard warning lights are turned on by pushing in the hazard switch. This causes all turn signal lights to blink. The hazard warning lights will operate even though the key is not in the ignition. To turn the hazard warning lights off, push the switch a second time.

REAR WINDOW DEFROSTER SWITCH

B380A01CM-AAT



The rear window defroster and heated outside rear view mirrors are turned on by pushing in the switch when the engine is running. At the same time, the rear window defroster indicator light on the switch is turned on. To turn the defroster off, push the switch a second time. The rear window defroster automatically turns itself off after about 20 minutes. To restart the defroster cycle, push in on the switch again after it has turned itself off.

Front Windshield Deicer (If Installed)

If your vehicle is installed with the front windshield deicer, it will be operating at the same time when you operate the rear window defroster.

This function helps release stuck windshield wipers, especially in winter time and cold regions.

Outside Rearview Mirror Heater (If Installed)

If your vehicle is installed with the outside rearview mirror heater, it will operate at the same time when you operate the rear window defroster.



CAUTION:

Do not clean the inner side of the rear window glass with an abrasive type of glass cleaner or use a scraper to remove foreign deposits from the inner surface of the glass as this may cause damage to the defroster elements.

NOTE:

Use the rear window defroster only when the engine is running.

DIGITAL CLOCK

B400A01NF-GAT

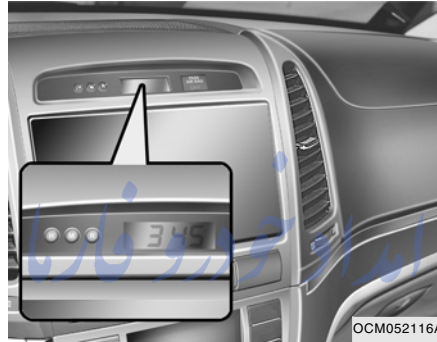

There are three control buttons for the digital clock. Their functions are: تلفن شبیه

- H** - Push "H" to advance the hour indicated.
- M** - Push "M" to advance the minute indicated.
- R** - Push "R" to reset minutes to ":00" to facilitate resetting the clock to the correct time. When this is done:
 - Pressing "R" between 11 : 01 and 11 : 29 changes the readout to 11 : 00.
 - Pressing "R" between 11 : 30 and 11 : 59 changes the readout to 12 : 00.
 - Push the "R" button for 5 seconds to display a 12 or 24-hour clock.

INSTRUMENT PANEL LIGHT CONTROL (RHEOSTAT)

B410A01A-AAT



The instrument panel lights can be made brighter or dimmer by turning the instrument panel light control knob.

CIGARETTE LIGHTER

B420A02A-AAT

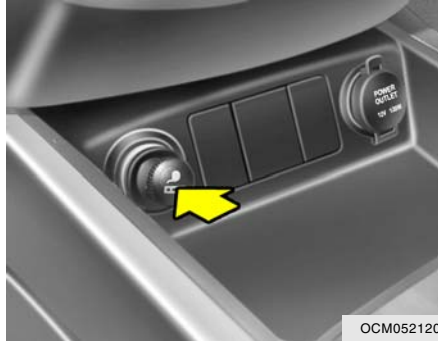

OCM052120

For the cigarette lighter to work, the key must be in the "ACC" position or the "ON" position. To use the cigarette lighter, push it all the way into its socket. When the element has heated, the lighter will pop out to the "ready" position. Do not hold the cigarette lighter pressed in. This can damage the heating element and create a fire hazard. If it is necessary to replace the cigarette lighter, use only a genuine Hyundai replacement or its approved equivalent.

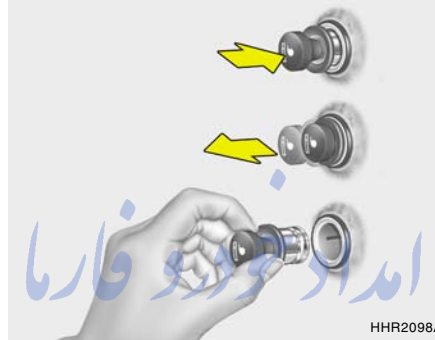

HHR2098A



CAUTION:
Do not use electric accessories or equipment other than the Hyundai genuine parts in this socket.

ASHTRAY

B430A01CM-AAT

Front Ashtray

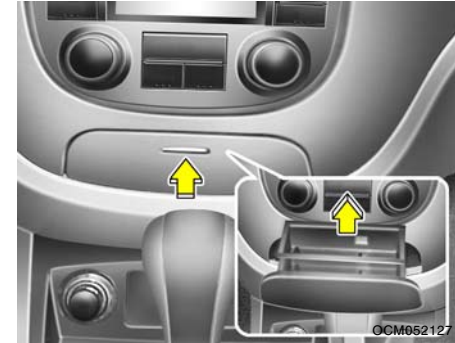

OCM052127

The front ashtray may be opened by pushing and releasing the ashtray lid. To remove the ashtray to empty or clean it, lift the ashtray upward and pull it out.

POWER OUTLETS

B500D01TG-AAT



OCM052121

(If installed)



OCM052122L

(If installed)

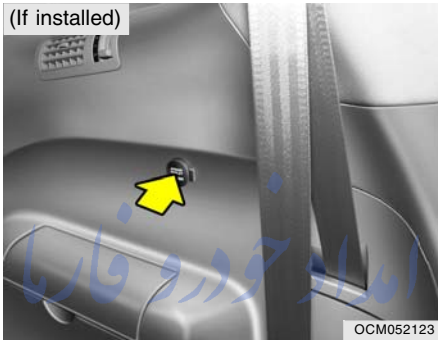

OCM052123

The power outlets are designed to provide power for mobile telephones or other devices designed to operate with vehicle electrical systems. The devices should draw less than 10 amps with the engine running.

ParmaSOS.com

**CAUTION:**

- o Use the power outlets only when the engine is running. Remove the plug from the power outlet after using the electric device. Using the power outlets when the engine stops or keeping the electric device plugged in for many hours may cause the battery to discharge.
- o Do not use the power outlet to connect electric accessories or equipment that are not designed to operate on 12 volts.
- o Some electronic devices can cause electronic interference when plugged into the power outlet. These devices may cause excessive audio noise and malfunctions in other electronic systems or devices in your vehicle.

B505A01CM-AAT

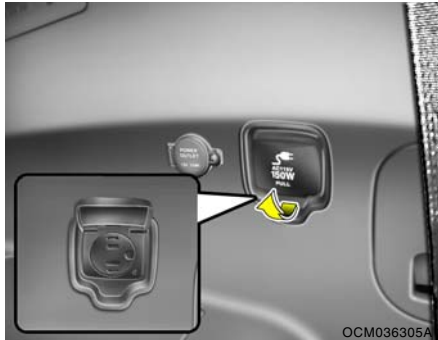
AC Inverter (If installed)

These supply 115VAC/150W electric power to operate electric accessories or equipment when the key is in the "ON" position or engine is running. The AC Inverter is turned on by pushing in the switch. To turn the AC Inverter off, push the switch a second time.

NOTE:

When pushing the AC inverter switch, the switch indicator illumination is delayed momentarily while the system conducts a self-check.

**CAUTION:**

- o When not using the AC Inverter, make sure that the switch is turned off, and is closed the AC Inverter cover.
- o Only use when the engine is running, and remove the plug from the AC Inverter after using the accessory. Using when the engine is not running or leaving the accessory plugged in for long time may cause the battery to discharge.

- o Do not use the electric accessories or equipment with maximum electric power consumption greater than 150W (115VAC).
- o Some electronic devices can cause electronic interference when plugged into the AC Inverter. These devices may cause excessive audio noise and malfunctions in other electronic systems or devices used in your vehicle.
- o Do not use broken electric accessories or equipment, as they may damage the AC Inverter and vehicle's electrical system.
- o Do not use two or more electric accessories or equipment at the same time.
- o When input voltage is under 11V, the outlet LED and indicator will blink, and will automatically turn off.

**WARNING:**

The AC Inverter can be dangerous! When using the AC Inverter, carefully observe the following precautions to avoid serious injuries.

- o Do not use heated electric products (coffeepot, toaster, heater, iron, etc.).
- o Do not insert a foreign objects into or touch the AC Inverter; you may get shocked.
- o Do not let children operate or touch the AC Inverter.
- o When not using the AC Inverter, close the cover.

DRINK HOLDER

B450A01CM-AAT

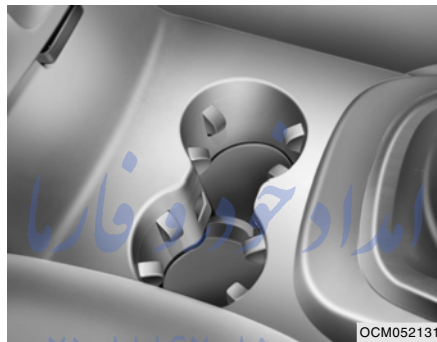
Front Drink Holder

OCM052131

The front drink holder is located on the main console.

B450B01NF-GAT

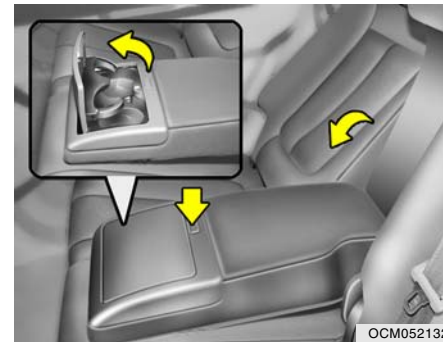
Rear Drink Holder

OCM052132

The rear drink holder for holding cups or cans is located in the center of the rear seat armrest.

**CAUTION:**

Place the drink holder in its closed position when not in use.

**WARNING:**

- o Use caution when using the drink holders. A spilled beverage that is very hot can injure you or your passengers. Spilled liquids can damage interior trim and electrical components.
- o Do not place objects other than cups or cans in the drink holder. These objects can be thrown out in the event of a sudden stop or an accident, possibly injuring the passengers in the vehicle.

SEATBACK POCKET

B540B02E-AAT
(If Installed)

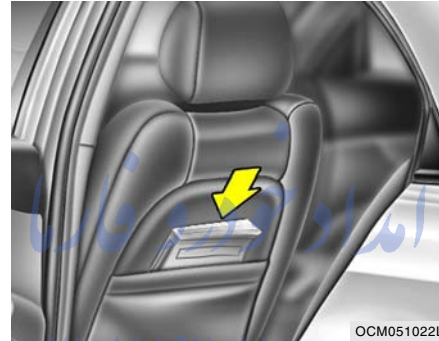

The seatback pockets for holding papers are located on the backside of the front seats.

**WARNING:**

To avoid injury, do not place large or hard objects in the seat back pockets.

SUNROOF

B460A03Y-AAT
(If Installed)
Sun Shade

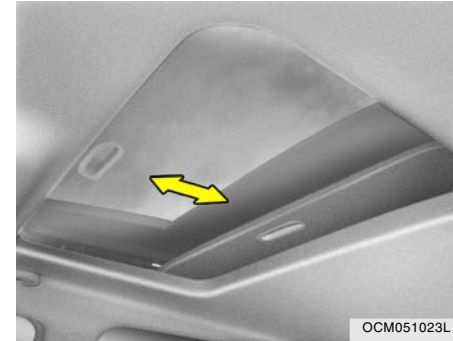

Your vehicle is equipped with a sliding sunshade which you can manually adjust to let in light with the sunroof closed, or to block sunlight.

**WARNING:**

Never adjust the sunshade while driving. This could result in loss of control and an accident that may cause death, serious injury, or property damage.

B460B01CM-AAT

Opening the Sunroof System



If your vehicle is equipped with this feature, you can slide or tilt your sunroof with the sunroof control buttons located on the overhead console.

The sunroof can only be opened, closed, or tilted when the ignition switch is in the "ON" position.

Auto slide open

To use the auto slide feature, momentarily (more than 1 second) press the OPEN button on the overhead console. The sunroof will slide all the way open. To stop the sunroof sliding at any point, press any sunroof control button.

Manual slide open

Press the OPEN button on the overhead console for less than 0.5 second.

Auto slide close

To close the sunroof, press the CLOSE button on the overhead console for more than 1 second.

The sunroof will slide all the way close. To stop at the desired point, press any sunroof control button.

Auto Reverse

If an object is detected while the sunroof is closing automatically, it will reverse direction, and then stop.

Auto reverse function does not work if a small obstacle is blocked between the sliding glass and the sunroof sash. You should always check that all passengers and objects are away from the sunroof before closing it.



WARNING:

Be careful that someone's head, hands and body are not trapped by a closing sunroof.

Manual slide close

Press the CLOSE button on the overhead console for less than 0.5 second.

B460C01CM-GAT

Tilting the Sunroof System



Auto tilt open

To use the autotilt feature, momentarily (more than 1 second) press the TILT UP button on the overhead console. The sunroof will tilt all the way open. To stop the sunroof tilting at any point, press any sunroof control button.

Manual tilt open

Press the TILT UP button on the overhead console for less than 0.5 second.

Close

To close the sunroof, press the CLOSE button on the overhead console and hold it until the sunroof is closed.

NOTE:

After washing the car or after there is rain, be sure to wipe off any water that is on the sunroof before operating it.



WARNING:

- o Do not close a sunroof if anyone's hands, arms or body are between the sliding glass and the sunroof sash, as this could result in injury.
- o Do not place your head or arms out of the sunroof opening at any time.
- o While the vehicle is moving, always keep the head, hands and other parts of the body of all occupants away from the roof opening. Otherwise, you could be seriously injured if the vehicle stops suddenly or if the vehicle is involved in an accident.



CAUTION:

- o Do not open the sunroof in severely cold temperature or when it is covered with ice or snow.
- o Periodically remove any dirt that may have accumulated on the guide rails.
- o Do not press any sunroof control button longer than necessary. Damage to the motor or system components could occur.

B460D01CM-AAT

Manual Operation of Sunroof

If the sunroof does not electrically operate:

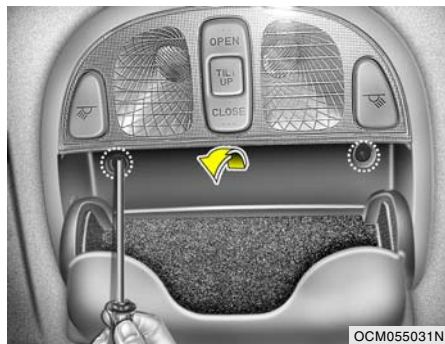

1. Open the sunglass holder.
2. Remove the two mounting screws of the front overhead console with a (+) driver.

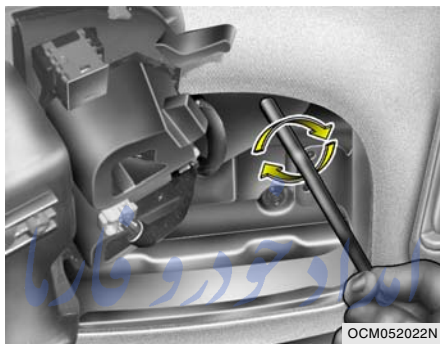

3. Insert the hexagonal head wrench provided with the vehicle into the socket. This wrench can be found in the vehicle's glove box.
4. Turn the wrench clockwise to open or counterclockwise to close the sunroof.

B460E01TG-GAT

Resetting the sunroof

Whenever the vehicle battery is disconnected or discharged, or you use the emergency handle to operate the sunroof, you have to reset your sunroof system as follows:

1. Turn the ignition key to the "ON" position.
2. Press the TILT UP button for more than 1 second to tilt up the sunroof completely when the sunroof is fully closed. Then, release the button.
3. Press and hold the TILT UP button once again until the sunroof has returned to the original position of TILT UP after it is raised a little higher than the maximum TILT UP position. Then, release the button.
4. Press and hold the TILT UP button within 5 seconds until the sunroof is operated as follows;

TILT DOWN → SLIDE OPEN → SLIDE CLOSE

Then, release the button.



CAUTION:
If the sunroof is not reset, it may not operate properly.

INTERIOR LIGHT

B480B01CM-AAT
Map Light



The light comes on when any door is opened regardless of the ignition switch position.

If a door is opened with the ignition switch in the ACC or LOCK position, the light stays on for about 20 minutes. However, if a door is opened with the ignition switch in the ON position, the light stays on continuously. When doors are unlocked by the transmitter, the light comes on for approximately 30 seconds as long as any door is not open. The light goes out gradually after approximately 30 seconds if the door is closed. However, if the ignition switch is ON or all doors are locked, the light will turn off immediately.

-  : Push in the map light switch to turn the light on or off. This light produces a spot beam for convenient use as a map light at night or as a personal light for the driver and the passenger.

امداد خودرو فارما

تلفن شبانه روزی: ۰۲۱-۸۸۱۶۲۰۸۵

FarmaSOS.com

B490A01CM-AAT
Interior Light

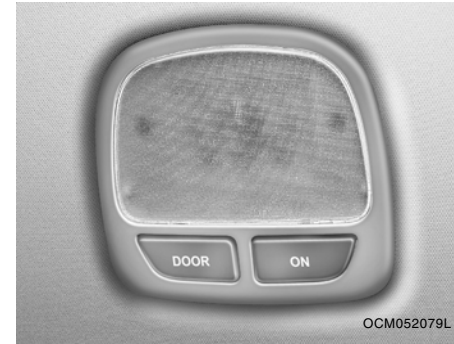

The interior courtesy light has two buttons. The two buttons are:

o DOOR

The courtesy light turns on when a door is opened or when a door is unlocked by the transmitter (if installed). The interior light goes out slowly after 30 seconds after the door is closed. However if the ignition switch is ON or all vehicle doors are locked when the door is closed, interior light will turn off even within 30 seconds.

o ON

In the "ON" position, the light stays on at all times.



CAUTION:

Do not leave this button pressed for an extended period of time when the vehicle is not running.

B540C01JM-GAT

Luggage Compartment Light



OCM052078L

Luggage compartment light has a 3-position switch. The three positions are:

- o In the "DOOR" position, the luggage compartment light comes on when the tail gate is opened, then goes out when it is closed.
- o In the "ON" position, the light stays on at all times.
- o In the "OFF" position, the light stays off at all times.

SUNGLASS HOLDER

B491A04O-AAT

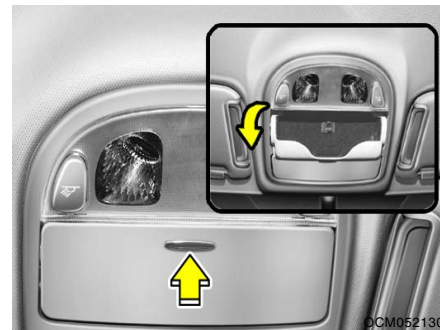

OCM052130

The sunglasses holder is located on the front overhead console. Push the end of the cover to open the sunglasses holder.



WARNING:

- o Do not keep objects other than eyeglasses inside the sunglasses holder. Such objects can be thrown from the holder in the event of a sudden stop or an accident, possibly injuring the passengers in the vehicle.
- o Do not open the sunglasses holder while the vehicle is moving. The rear view mirror of the vehicle can be blocked by an open sunglasses holder.

CONVERSATION MIRROR

B525A01CM-AAT
(If Installed)

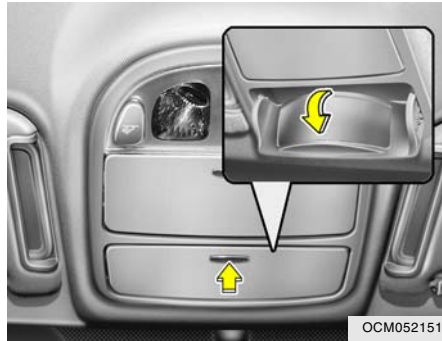

To use the mirror, push the cover and open it. Adjust mirror angle to the desired position.

Close the cover after use.



WARNING

Do not adjust the mirror angle or look at rear passengers while driving. This could result in loss of control, and an accident causing death, serious injury, or property damage.

STORAGE BOX

B500A01Y-AAT
Glove Box

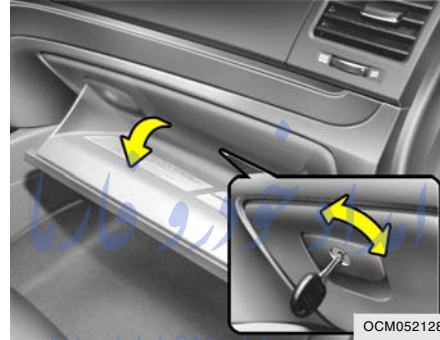

تلفن شبانه روزی: ۰۸۵+۲۰۸۸۶۲-۲۱



WARNING:

To avoid the possibility of injury in case of an accident or a sudden stop, the glove box door should be kept closed when the car is in motion.

- o To open the glove box, pull on the glove box release lever.
- o The glove box door can be locked (and unlocked) with the key (if installed).

B500B01O-AAT

Illuminated Glove Box

Opening the glove box will automatically turn on the light when the multi-function switch is turned to the first/second position.

B505A02NF-GAT

Center Console Box

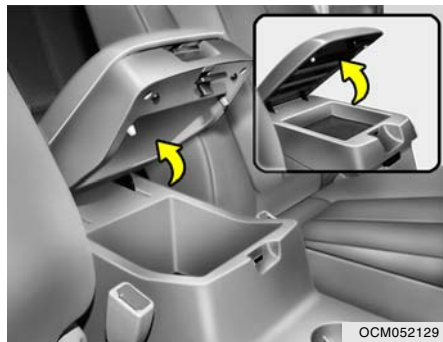

The center console box is used for storing small articles.

To use the center console box, pull up the button and lift the lid to open it.

! **WARNING:**
To avoid the possibility of injury in case of an accident or a sudden stop, the center console box lid should be kept closed when the car is in motion.

B505C01CM-AAT

Rear Console Box



The rear console box is located on the rear main console and may be used for small articles. It is opened by pulling forward.

! **WARNING:**
To avoid the possibility of injury in case of an accident or a sudden stop, the tray should be kept closed when the car is in motion.

B505B01CM-GAT

Center facia upper tray (If Installed)

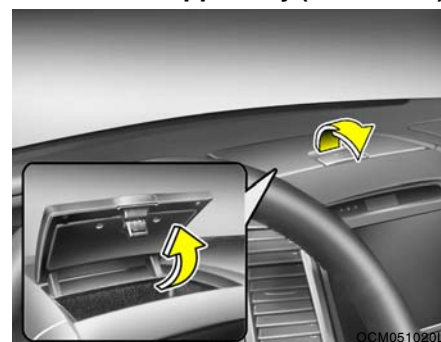

The center facia upper tray is used for storing small articles. To use the center facia upper tray, pull up the button and lift lid to open it.

**WARNING:**

- o Do not store cigarette lighters, propane cylinders, or other flammable/explosive materials in the vehicle. These items may catch fire and/or explode if the vehicle is exposed to hot temperatures for extended periods.
- o To avoid the possibility of injury in case of an accident or a sudden stop, the center facia upper tray lid should be kept closed when the car is in motion.

OUTSIDE REARVIEW MIRROR

B510B01TG-AAT

The outside rearview mirrors can be adjusted to your preferred rear vision, both directly behind the vehicle, and to the rear of the left and right sides.

The remote control outside rearview mirror switch controls the adjustments for both right and left outside mirrors.

NOTE:

Before driving away, always check that your mirrors are positioned so you can see behind you, both to the left and right sides, as well as directly behind your vehicle.

تلفن شبانه روزی: ۰۲۱-۸۸۶۲۰۸۵

**CAUTION:**

If the mirror is jammed with ice, do not adjust the mirror by force. Use an approved spray de-icer (not radiator anti-freeze) to release the frozen mechanism or move the vehicle to a warm place and allow the ice to melt.

To adjust the position of either mirror:

1. Move the selecting switch to the right or left to activate the adjustable mechanism for the corresponding door mirror.
2. Adjust mirror angle by depressing the appropriate perimeter switch as illustrated.



OCM052053

**CAUTION:**

- o Do not operate the switch continuously for an unnecessary length of time.
- o Scraping ice from the mirror face could cause permanent damage. To remove any ice, use a sponge, soft cloth or approved de-icer.

**WARNING:**

Be careful when judging the size or distance of any object seen in the passenger side rearview mirror. It is a convex mirror with a curved surface, and any objects seen in this mirror are closer than they appear.

B510D01CM-AAT

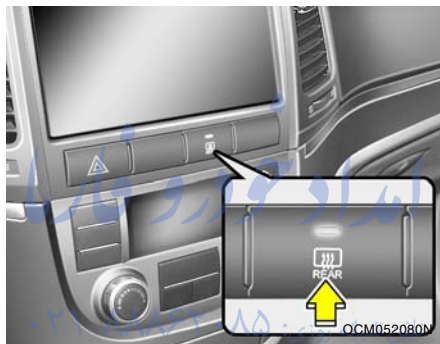
**Outside Rearview Mirror Heater
(If Installed)**

The outside rearview mirror heater is actuated in connection with the rear window defroster. To heat the outside rearview mirror glass, push in the switch for the front/rear window defroster. The rearview mirror glass will be heated for defrosting or defogging and will give you improved rear vision in inclement weather conditions. Push the switch again to turn the heater off. The outside rearview mirror heater automatically turns itself off after 20 minutes.

B510C01TG-AAT

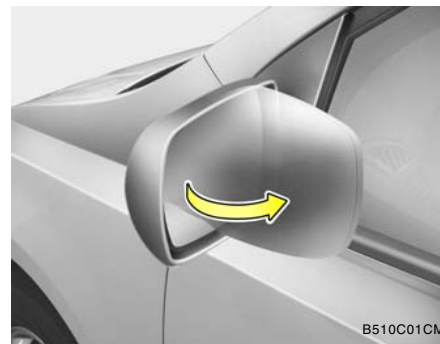
**Folding The Outside Rearview
Mirrors (Manual Type)**

To fold the outside rearview mirrors, push them towards the rear. The outside rearview mirrors can be folded rearward for parking in narrow areas.

**CAUTION:**

If the mirror is jammed with ice, do not adjust the mirror by force. Use an approved spray de-icer (not radiator anti-freeze) to release the frozen mechanism or move the vehicle to a warm place and allow the ice to melt.

**WARNING:**

Do not adjust or fold the outside rearview mirrors while the vehicle is moving. This could result in loss of control, and an accident causing death, serious injury or property damage.

DAY/NIGHT INSIDE REARVIEW MIRROR

B520A01A-AAT

Manual Type

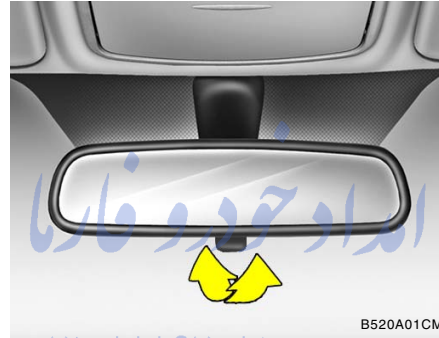

Your Hyundai is equipped with a day/night inside rearview mirror. The "night" position is selected by flipping the tab at the bottom of the mirror toward you. In the "night" position, the glare of headlights of cars behind you is reduced.

B520C01CM-AAT

Automatic Dimming Rearview Mirror with Compass (If installed)

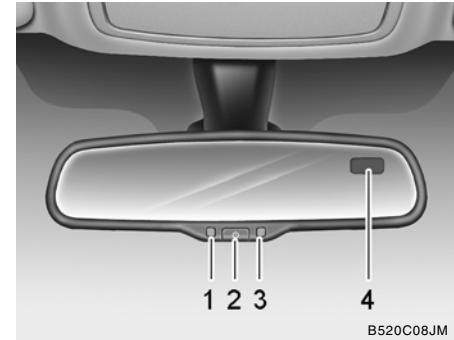

1. Status Indicator LED
2. Feature Control Button
3. Rear Light Sensor
4. Display Window

Automatic dimming rearview mirrors automatically controls the glare from headlights behind you when the function is turned on by pressing and holding the Feature Control Button for more than 3 but less than 6 seconds. This feature can be turned off by pressing and holding the button for the same amount of time once more.

To operate Compass feature

Press and release the button, then the vehicle's directional heading will be displayed. Pressing and releasing the button again will turn off the display.

Heading display

- E : East
- W : West
- S : South
- N : North

ex) NE : North East







Calibration procedure

If the compass is not properly calibrated, set to the correct variance zone, or the vehicle is driven in certain environments (tunnel, underground or in-building parking garage, near transformer substation), the following may occur :

- "C" is displayed.
- The compass heading become inaccurate.
- The compass heading does not changed.
- Some compass headings are not displayed.

- The compass headings are inaccurate in long distance driving.

If the vehicle's compass headings become inaccurate, the compass should be calibrated as follows:

1. Ensure the vehicle is not located near large steel structures or under electric power lines.
2. Turn on the compass by pressing the  button.
3. Press and hold the  button for more than 6 but less than 9 seconds. The current zone number will appear in the display. Release then press the  button until your zone number appears in the display.
4. Check the mirror angle by pressing and holding the  button for more than 12seconds. Release then press the  button to "L"(for steering wheel on the Left side of the vehicle). (if installed)
5. Press and hold the  button between 9 and 12 seconds. Release the  button when a "C" appears in the display.
6. Drive the vehicle in 2 complete circles at less than 5mph(8km/h) or until the compass heading appears.



CAUTION:
Be sure the area is free of traffic, pedestrians, and obstructions.

Setting the compass zone

1. Determine the Zone Number based on your current location in the Zone Map.

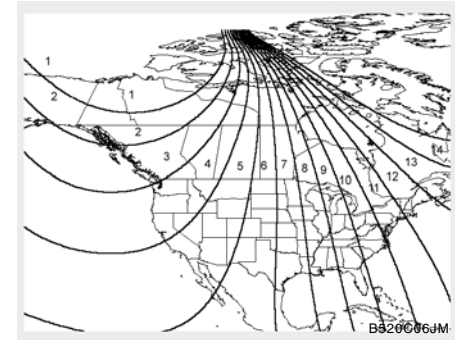

2. Press and hold the button for more than 6 but less than 9 seconds. The current zone number will appear in the display.
3. Release then press the button to increment to new your zone number.

4. Drive the vehicle in 2 complete circles at less than 5mph(8km/h) or until the compass heading appears.



CAUTION:

- o Do not install a ski rack, antenna, etc. which are attached to the vehicle by means of a magnet. They affect the operation of the compass.
- o If the compass deviates from the correct indication soon after repeated adjustment, have the compass checked at an authorized dealer.
- o The compass may not indicate the correct indication in tunnels or while driving up or down a steep hill.(The compass returns to the correct compass point when the vehicle moves to an area where the geomagnetism is stabilized.)
- o When cleaning the mirror, use a paper towel or similar material dampened with glass cleaner. Do not spray glass cleaner directly on the mirror as that may cause the liquid cleaner to enter the mirror housing.

امداد خودرو فارما

تلفن شبانه روزی: ۰۲۱-۸۸۸۶۲۰۸۵

FarmaSOS.com

HOMELINK MIRROR

B520C01CM-AAT

Automatic-Dimming Mirror with Z-Nav™ Electronic Compass Display and HomeLink® (If Installed)

Your vehicle comes with a Gentex Automatic-Dimming Mirror with a Z-Nav™ Electronic Compass Display and an Integrated HomeLink® Wireless Control System. During nighttime driving, this feature will automatically detect and reduce rearview mirror glare while the compass indicates the direction the vehicle is pointed. The HomeLink® Universal Transceiver allows you to activate your garage door(s), electric gate, home lighting, etc.



B520C01CM

- | | |
|-------------------------|---------------------------|
| 1. Channel 1 Button | 5. Rear Light Sensor |
| 2. Channel 2 Button | 6. Dimming On/Off Button |
| 3. Status Indicator LED | 7. Compass Control Button |
| 4. Channel 3 Button | 8. Display |

Automatic-Dimming Night Vision Safety™ (NVS®) Mirror

The NVS® Mirror in your vehicle is the most advanced way to reduce glare in the rear-view mirror during any driving situation. For more information regarding NVS® mirrors and other applications, please refer to the Gentex website: www.gentex.com.





CAUTION:

Too close the NVS® Mirror automatically reduces glare during driving conditions based upon light levels monitored in front of the vehicle and from the rear of the vehicle. These light sensors are visible through openings in the front and rear of the mirror case. Any object that would obstruct either light sensor will degrade the automatic dimming control feature.

Automatic-Dimming Function

Your mirror will automatically dim upon detecting glare from the vehicles traveling behind you. The auto-dimming function can be controlled by the Dimming ON/OFF Button:

1. Pressing the  button turns the auto-dimming function OFF which is indicated by the green Status Indicator LED turning off.
2. Pressing the  button again turns the auto-dimming function ON which is indicated by the green Status Indicator LED turning on.

NOTE:



The mirror defaults to the "ON" position each time the vehicle is started.

Z-Nav™ Compass Display

The NVS™ Mirror in your vehicle is also equipped with a Z-Nav™ Compass that shows the vehicle Compass heading in the Display Window using the 8 basic cardinal headings (N, NE, E, SE, etc.).

Compass Function

The Compass can be turned ON and OFF and will remember the last state when the ignition is cycled. To turn the display feature ON/OFF:

1. Press and release the  button to turn the display feature OFF.
2. Press and release the  button again to turn the display back ON.

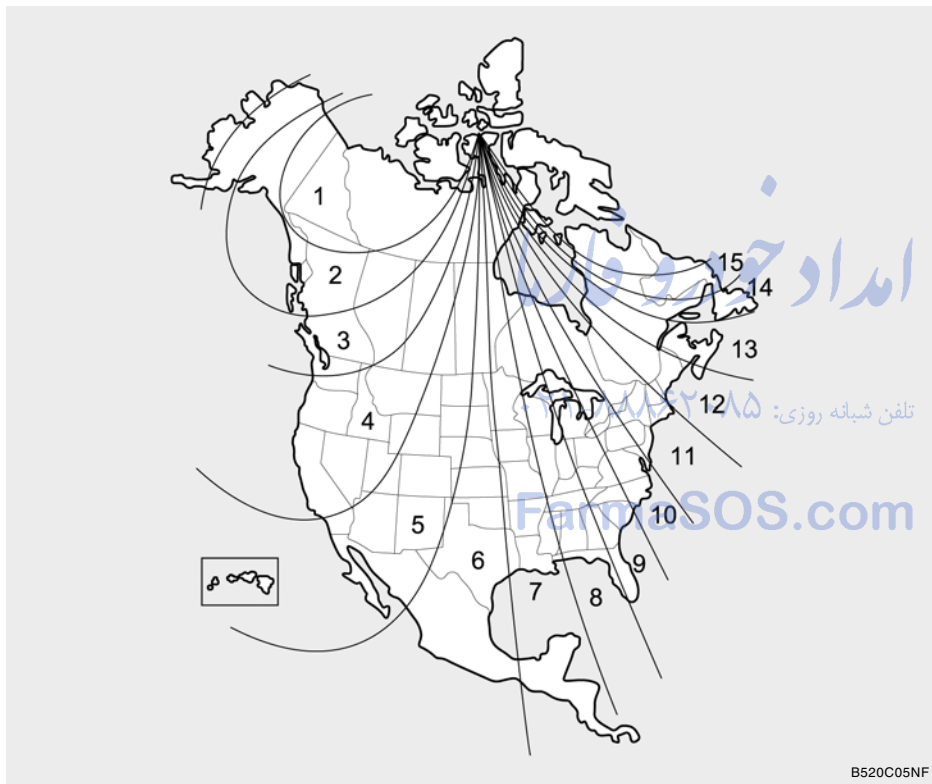

Additional options can be set with press and hold sequences of the  button and are detailed below.

There is a difference between magnetic north and true north. The compass in the mirror can compensate for this difference when it knows the Magnetic Zone in which it is operating. This is set either by the dealer or by the user. The operating Zone Numbers for North America are shown in the figure on the following section.



B520C05NF

To adjust the Zone setting:

1. Determine the desired Zone Number based upon your current location on the Zone Map.
2. Press and hold the  button for more than 3 but less than 6 seconds, the current Zone Number will appear on the display.
3. Pressing and holding the  button again will cause the numbers to increment (Note: they will repeat ...13, 14, 15, 1, 2, ...). Releasing the button when the desired Zone Number appears on the display will set the new Zone.
4. Within about 5 seconds the compass will start displaying a compass heading again.

There are some conditions that can cause changes to the vehicle magnets. Items such as installing a ski rack or a CB antenna or even some body repair work on the vehicle can cause changes to the vehicle's magnetic field. In these situations, the compass will need to be recalibrated to quickly correct for these changes. To re-calibrate the compass:

1. Press and hold the  button for more than 6 seconds. When the compass memory is cleared a "C" will appear in the display.
2. To calibrate the compass, drive the vehicle in 2 complete circles at less than 5 MPH (8 Km/h) or until the compass heading appears.

**CAUTION:**

Be sure the area is free of traffic, pedestrians, and obstructions.

Integrated HomeLink® Wireless Control System

The HomeLink® Wireless Control System provides a convenient way to replace up to three hand-held radio-frequency (RF) transmitters with a single built-in device. This innovative feature will learn the radio frequency codes of most current transmitters to operate devices such as gate operators, garage door openers, entry door locks, security systems, even home lighting. Both standard and rolling code-equipped transmitters can be programmed by following the outlined procedures.

Additional HomeLink® information can be found at: www.homelink.com or by calling 1-800-355-3515.

**CAUTION:**

Before programming HomeLink® to a garage door opener or gate operator, make sure that people and objects are out of the way of the device to prevent potential harm or damage. Do not use HomeLink® with any garage door opener that lacks the safety stop and reverse features as required by U.S. federal safety standards (this includes any garage door opener model manufactured before April 1, 1982). A garage door that cannot detect an object - signaling the door to stop and reverse - does not meet current U.S. federal safety standards. Using a garage door opener without these features increases the risk of serious injury or death.

Retain the original transmitter of the RF device you are programming for use in other vehicles as well as for future HomeLink® programming. It is also suggested that upon the sale of the vehicle, the programmed HomeLink® buttons be erased for security purposes.

Programming HomeLink®

NOTE:

- o When programming a garage door opener, it is advised to park the vehicle outside of the garage.
- o It is recommended that a new battery be placed in the hand-held transmitter of the device being programmed to HomeLink® for quicker training and accurate transmission of the radio-frequency signal.
- o Some vehicles may require the ignition switch to be turned to the second (or "accessories") position for programming and/or operation of HomeLink.
- o In the event that there are still programming difficulties or questions after following the programming steps listed below, contact HomeLink® at: www.homelink.com or 1-800-355-3515.

Standard Programming

To train most devices, follow these instructions:

1. For first-time programming, press and hold the two outside buttons, HomeLink® Channel 1 and Channel 3 Buttons, until the indicator light begins to flash (after 20 seconds). Release both buttons. Do not hold the buttons for longer than 30 seconds.
2. Position the end of your hand-held transmitter 1-3 inches (5-14 cm) away from the HomeLink® buttons while keeping the indicator light in view.
3. Simultaneously press and hold both the HomeLink® and hand-held transmitter button. DO NOT release the buttons until step 4 has been completed.
4. While continuing to hold the buttons the red Indicator Status LED will flash slowly and then rapidly after HomeLink® successfully trains to the frequency signal from the hand-held transmitter. Release both buttons.

5. Press and hold the just-trained HomeLink® button and observe the red Status Indicator LED. If the indicator light stays on constantly, programming is complete and your device should activate when the HomeLink® button is pressed and released.
6. To program the remaining two HomeLink® buttons, follow steps 2 through 5.

Rolling Code Programming

Rolling code devices which are "code-protected" and manufactured after 1996 may be determined by the following:

- o Reference the device owner's manual for verification.
- o The handheld transmitter appears to program the HomeLink Universal Transceiver but does not activate the device.
- o Press and hold the trained HomeLink button. The device has the rolling code feature if the indicator light flashes rapidly and then turns solid after 2 seconds.

To train rolling code devices, follow these instructions:

1. At the garage door opener receiver (motor-head unit) in the garage, locate the "learn" or "smart" button. This can usually be found where the hanging antenna wire is attached to the motor-head unit. Exact location and color of the button may vary by garage door opener brand. If there is difficulty locating the training button, reference the device owner's manual or please visit our Web site at www.homelink.com.
2. Firmly press and release the "learn" or "smart" button (which activates the "training light").

NOTE:

There are 30 seconds in which to initiate step3.

3. Return to the vehicle and firmly press, hold for two seconds and then release the desired HomeLink® button. Repeat the "press/hold/release" sequence a second time to complete the programming. (Some devices may require you to repeat this sequence a third time to complete the programming.)

4. Press and hold the just-trained HomeLink® button and observe the red Status Indicator LED. If the indicator light stays on constantly, programming is complete and your device should activate.
5. To program the remaining two HomeLink® buttons, follow either steps 1 through 4 above for other Rolling Code devices or steps 2 through 5 in Standard Programming for standard devices.

Gate Operator & Canadian Programming

During programming, your handheld transmitter may automatically stop transmitting. Continue to press the Integrated HomeLink® Wireless Control System button (note steps 2 through 4 in the Standard Programming portion of this document) while you press and re-press ("cycle") your handheld transmitter every two seconds until the frequency signal has been learned. The indicator light will flash slowly and then rapidly after several seconds upon successful training.

Operating HomeLink®

To operate, simply press and release the programmed HomeLink® button. Activation will now occur for the trained device (i.e. garage door opener, gate operator, security system, entry door lock, home/office lighting, etc.). For convenience, the hand-held transmitter of the device may also be used at any time.

Reprogramming a Single HomeLink® Button

To program a new device to a previously trained HomeLink® button, follow these steps:

1. Press and hold the desired HomeLink® button. Do NOT release until step 4 has been completed.
2. When the indicator light begins to flash slowly (after 20 seconds), position the handheld transmitter 1 to 3 inches away from the HomeLink® surface.
3. Press and hold the handheld transmitter button. The HomeLink® indicator light will flash, first slowly and then rapidly.
4. When the indicator light begins to flash rapidly, release both buttons.

5. Press and hold the just-trained HomeLink® button and observe the red Status Indicator LED. If the indicator light stays on constantly, programming is complete and your new device should activate.

Erasing HomeLink® Buttons

Individual buttons cannot be erased. However, to erase all three programmed buttons:

1. Press and hold the two outer HomeLink® buttons until the indicator light begins to flash-after 20 seconds.
2. Release both buttons. Do not hold for longer than 30 seconds.

The Integrated HomeLink® Wireless Control System is now in the training (learn) mode and can be programmed at any time following the appropriate steps in the Programming sections above.

FCC ID: NZLZTVHL3
IC: 4112A-ZTVHL3

This device complies with Part 15 FCC Rules. Operation is subject to the following two conditions: (1) this device may not cause harmful interference, and (2) this device must accept any interference received, including interference that may cause undesired operation.

! WARNING:
The transceiver has been tested and complies with FCC and Industry Canada rules. Changes or modifications not expressly approved by the party responsible for compliance could void the user's authority to operate the device.

NVS® is a registered trademark and Z-Nav™ is a trademark of the Gentex Corporation, Zeeland, Michigan. HomeLink® is a registered trademark owned by Johnson Controls, Incorporated, Milwaukee, Wisconsin.

PARKING BRAKE

B530A02CM-AAT

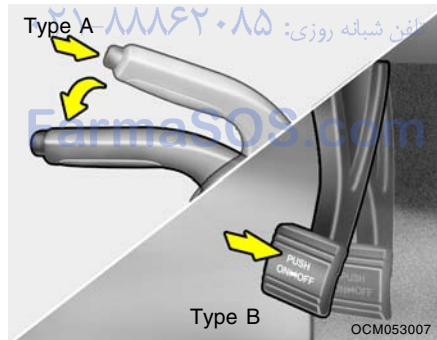
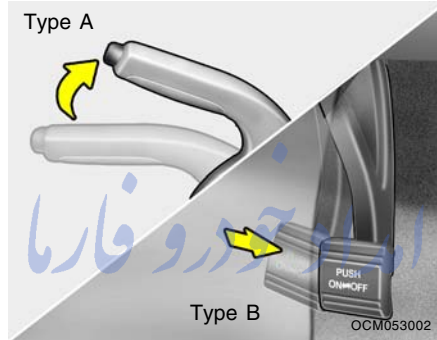

Always engage the parking brake before leaving the car. This also turns on the parking brake indicator light when the key is in the "ON" or "START" position.

Before driving away, be sure that the parking brake is fully released and the indicator light is off.

Type A (with manual transaxle)

- o To engage the parking brake, pull the lever up as far as possible.
- o To release the parking brake, pull up the lever and press the thumb button. Then, while holding the button in, lower the brake lever.

Type B (with automatic transaxle)

- o To engage the parking brake, depress the parking brake pedal.
- o To release the parking brake, depress the parking brake pedal a second time.

NOTE:

The parking brake pedal should be checked periodically for proper stroke.

B535A01CM-GAT

Parking brake warning chime (if installed)

The parking brake warning chime reminds you that the parking brake is applied when you are driving above 6mph(10km/h). Always release the parking brake before you drive.

TAIL GATE

B540A01CM-AAT

**WARNING:**

- Whenever leaving vehicle or parking always set the parking brake as far as possible and fully engage the vehicle's transaxle into the park position. Vehicles not fully engaged in park with the parking brake set are at risk for moving inadvertently and injuring yourself or others.
- To prevent unintentional movement when stopped and leaving the vehicle, do not use the gearshift lever in place of the parking brake. Set the parking brake AND make sure the gearshift lever is securely positioned in 1st (First) gear or R (Reverse) for manual transaxle equipped vehicles and in P (Park) for automatic transaxle equipped vehicles.
- Never allow a person who is unfamiliar with the vehicle or children to touch the parking brake. If the parking brake is released unintentionally, serious injury may occur.

**WARNING:**

The tail gate should always be kept completely closed while the vehicle is in motion. If it is left open or ajar, poisonous exhaust gases may enter the car resulting in serious illness or death to the occupants. See additional warnings concerning exhaust gases on page 2-2.

- The tail gate is opened by pulling the outside handle up, raising the tail gate manually.
- To close, lower the tail gate, then press down on it until it is closed. To be sure the tail gate is fully closed, always try to pull it up again without using the outside handle.

LUGGAGE COMPARTMENT

B640A01S-AAT

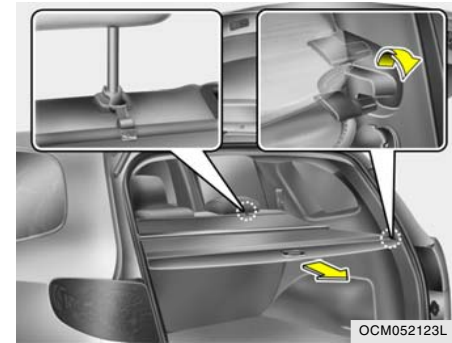
**Cargo Security Screen
(If installed)**

To use the security screen, pull it out of the retractor and hook it to the anchors as illustrated.



B650A01S-AAT

Stowage Precautions

1. Do not place objects on the cargo security screen. Such objects may be thrown about inside the vehicle and possibly injure vehicle occupants during an accident or when braking.
2. For better fuel economy, do not carry unnecessary weight.
3. Never allow anyone to ride in the luggage compartment. It is designed for luggage only.
4. Try to maintain the balance of the vehicle and locate the weight as far forward as possible.

B540D02O-AAT

Luggage Net

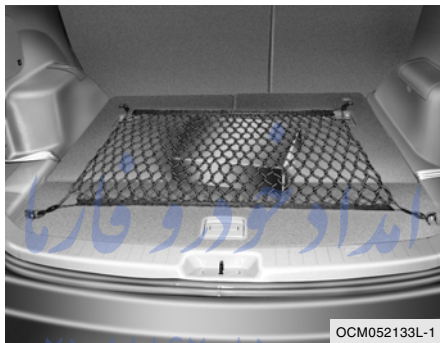

When loading objects in the luggage compartment, use the four rings located in the luggage compartment to attach the luggage net as shown illustration. This will help prevent the objects from sliding.



CAUTION:

To prevent damage to the goods or the vehicle, care should be taken when carrying fragile or bulky objects in the luggage compartment.



WARNING:

Avoid eye injury. DO NOT overstretch. The luggage net ALWAYS keep your face and body out of its recoil path. DO NOT use when the strap has visible signs of wear or damage.

B545B01CM-AAT

Luggage Under Tray

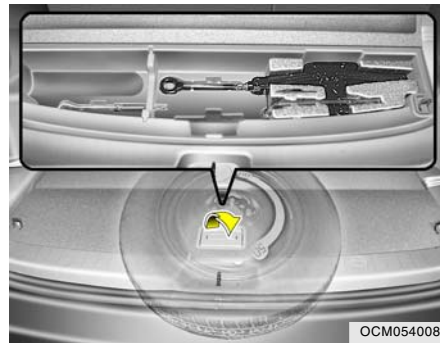

There is a multipurpose receipt space under the luggage mat. Before using, remove the luggage mat (if installed). Raise the cover by using grip.

ROOF RACK

B630A01CM-AAT
(If installed)

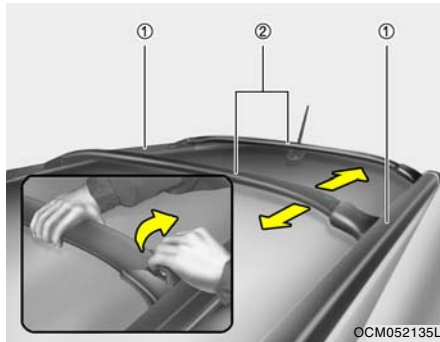

- ① Roof rack
- ② Crossbar (if installed)

If your Hyundai has a roof rack, you can load certain items on top of your vehicle. Crossbars and attaching components to adapt the roof rack on your vehicle may be obtained from an authorized Hyundai dealer.

To move the crossbars, pull the lock release lever and release it after the desired position is achieved.

B635A01CM-GAT
**To move the front crossbar
(If Installed)**

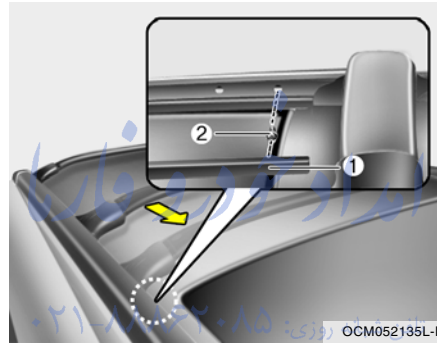

You can reposition the front crossbar more to the frontside of the vehicle to transport ski equipment or other goods. After removing the bumper molding ① and mounting bolt ②, move the crossbar frontside of the vehicle and fix it up with a bolt into the hole. And then reinstall the bumper molding.

NOTE:

When do not use the roof rack, to prevent severe noise of the wind while you driving, place the front crossbar at the extreme rearward.



CAUTION:

- The crossbars should be placed in the proper load carrying positions prior to placing items onto the roof rack.
- If the vehicle is equipped with a sunroof, be sure not to position cargo onto the roof rack in such a way that it could interfere with sunroof operation.
- When carrying cargo on the roof rack, take the necessary precautions to make sure the cargo does not damage the roof of the vehicle.
- When carrying large objects on the roof rack, make sure they do not exceed the overall roof length or width.

! **WARNING:**

- o The following specification is the maximum weight that can be loaded onto the roof rack. Distribute the load as evenly as possible across the crossbars and roof rack and secure the load firmly.
- o The vehicle's center of gravity will be higher when items are loaded onto the roof rack. Avoid sudden starts, braking, sharp turns, abrupt maneuvers or high speeds that may result in loss of vehicle control or rollover causing an accident.

ROOF RACK	220 lbs (100 kg) EVENLY DISTRIBUTED
-----------	--

! **WARNING:**

- o Always drive slowly and turn corners carefully when carrying items on the roof rack. Severe wind updrafts, caused by passing vehicles or natural causes. Can cause sudden upward pressure on items loaded on the roof rack. This is especially true when carrying large, flat items.
- o To prevent damage or loss of cargo while driving, check frequently to make sure the items on the roof rack are securely fastened.

FarmaSOS.com

HIGH-MOUNTED REAR STOP LIGHT

B550A01A-AAT

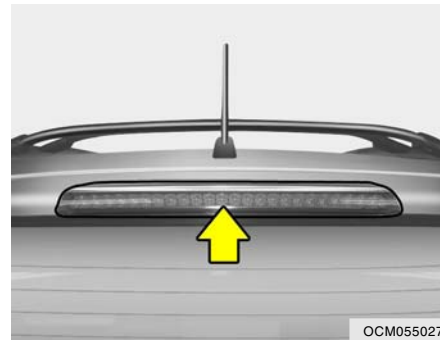

In addition to the lower-mounted rear stoplights on either side of the car, the high mounted rear stoplight in the center of the rear window also lights when the brakes are applied.

REMOTE FUEL-FILLER LID RELEASE

B560A01CM-AAT

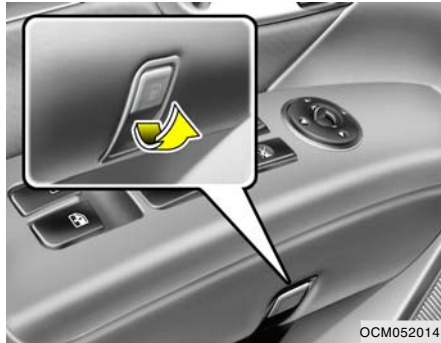

OCM052014

The fuel-filler lid may be opened from inside the vehicle by pulling up on the fuel-filler lid opener located on the driver's door.

NOTE:

If the fuel-filler lid will not open because ice has formed around it, tap lightly or push on the lid to break the ice and release the lid. Do not pry on the lid. If necessary, spray around the lid with an approved de-icer fluid (do not use radiator anti-freeze) or move the vehicle to a warm place and allow the ice to melt.

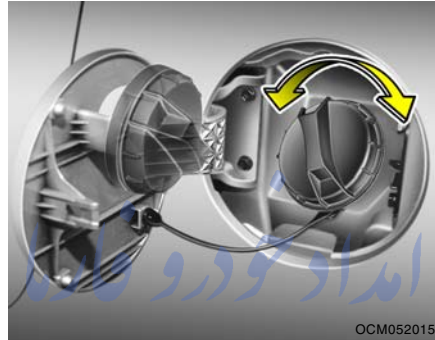

OCM052015

WARNING:

- o Gasoline vapors are dangerous. Before refueling, always stop the engine and never smoke or allow sparks and open flames near the filler area.
- o Never operate your vehicle without a filler cap properly installed, flammable vapors and gasoline could leak out in dangerous situations such as a collision or rollover. If the filler cap must be replaced, only use genuine Hyundai replacement parts.

WARNING:

- o After refueling, make sure the fuel cap is installed securely to prevent fuel spillage in the event of an accident
- o Tighten the cap until it clicks, otherwise the "CHECK" light will illuminate

**WARNING:**

- o If you open the fuel filler cap during high ambient temperatures, a slight "pressure sound" may be heard. This is normal and not a cause for concern. Whenever you open the fuel filler cap, turn it slowly.
- o Do not "TOP-OFF" after the first nozzle shut off when refueling.
- o Automotive fuels are flammable/explosive materials. When refueling, please note the following guidelines carefully.
 - Before touching the fuel nozzle or fuel filler cap, have one's hands in contact with metal parts away from the filler neck to discharge static electricity.
 - Do not get back in the vehicle while refueling. Do not operate anything that can produce static electricity. Static electricity discharge can ignite fuel vapors resulting in explosion.

**WARNING:**

- When using a portable fuel container be sure to place the container on the ground while refueling. Static electricity discharge from the container can ignite fuel vapors causing a fire. While starting refueling contact should be maintained until the filling is complete.
- Do not use cellular phones around a gas station. The electric current or electronic interference from cellular phones can ignite fuel vapors causing a fire.
- When refueling always shut the engine off. Sparks by electrical equipment of the engine can ignite fuel vapors causing a fire. After refueling, check to make sure the fuel filler cap is securely closed, and then start the engine.
- Do not smoke or try to light cigarettes around a gas station. Automotive fuels are flammable.

B560B01CM-AAT

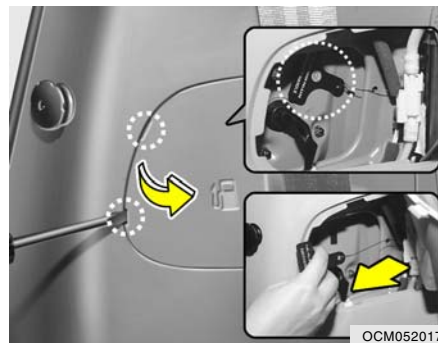
Manual Fuel Filler Lid Release

OCM052017

If the fuel filler lid does not open using the remote fuel filler lid release, you can open it manually. Unsnap and remove the panel in the rear cargo area. Pull the handle outward.

HOOD RELEASE

B570A01HP-GAT

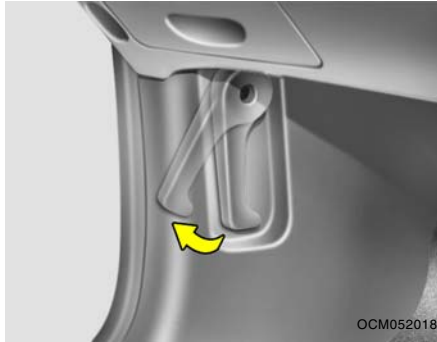

1. Pull the release knob to unlatch the hood.



2. Push the secondary latch lever sideways and lift the hood.
3. Raise the hood by hand.



When closing the hood, slowly close the hood and make sure it locks into place.

FarmaSOS.com



WARNING:

- o Always double check to be sure that the hood is firmly latched before driving away. If it is not latched, the hood could open while the vehicle is being driven, causing a total loss of visibility, which might result in an accident.
- o Do not move the vehicle with the hood in the raised position, as vision is obstructed and the hood could fall or be damaged.

FLOOR MAT ANCHOR

B571A03Y-AAT

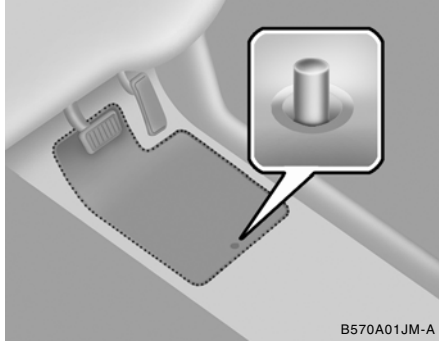

B570A01JM-A

When using a floor mat on the front floor carpet, make sure it attaches to the floor mat anchor in your vehicle. This keeps the floor mat from sliding forward.

! **WARNING:**

- o Make sure the floor mat is properly placed on the floor carpet. If the floor mat slips and interferes with the movement of the pedals during driving, it may cause an accident.
- o Don't put an additional floor mat on the top of the anchored floor mat, otherwise the additional mat may slide forward and interfere with the movement of the pedals.

تلفن شبانه روزی: ۰۲۱-۸۸۶۲۰۸۵

FarmaSOS.com

SUN VISOR

B580A01CM-AAT

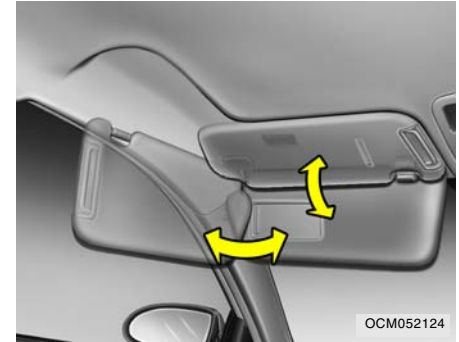

OCM052124

Your Hyundai is equipped with sun visors to give the driver and front passenger either frontal or sideward shade. To reduce glare or to shut out direct rays of the sun, turn the sun visor down.

A vanity mirror is provided on the back of the sun visor for the driver and front passenger.

NOTE:

The Supplemental Restraint System (SRS) label containing useful information can be found on the of sun visor.

**WARNING:**

- o Do not place the sun visor in such a manner that it obscures visibility of the roadway, traffic or other objects.
- o Do not move the sun visor out to cover the side window if there is an item attached to it such as a garage door remote control, pens, air fresheners or the like. These objects could cause injury if the curtain air bag is deployed.

B580B01B-GAT

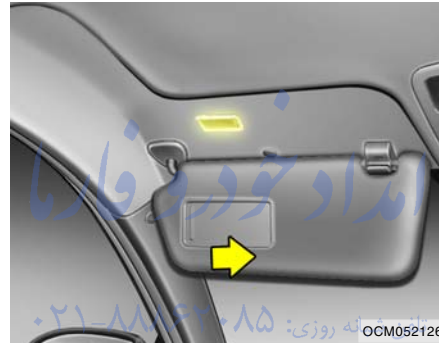
**Illuminated Vanity Mirror
(If installed)**

Opening the lid of the vanity mirror will automatically turn on the mirror light.

FarmaSOS.com

B585BA01JM-AAT

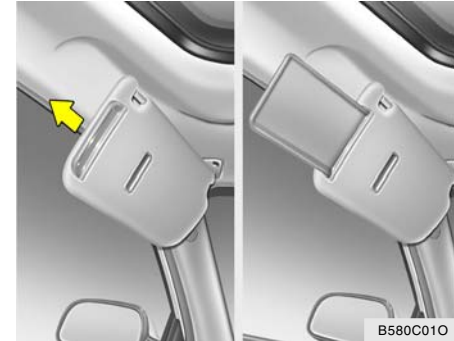
Sun Visor Extender (If Installed)

Your vehicle is equipped with sun visor extenders that may be used when the visor is in the side glass position.

STEERING WHEEL

B580C01LZ-AAT

Ticket Holder (If installed)



The ticket holder is provided on the front of the sun visor for holding a tollgate ticket.

B600A01NF-GAT

Tilt type

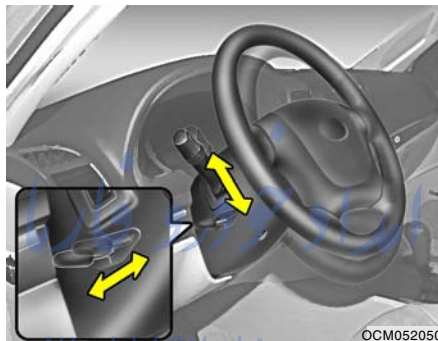

To adjust the steering wheel: تلفن شبانه ۰۲۱

1. Pull the lever toward you and hold it to unlock.
2. Raise or lower the steering wheel to the desired position.
3. After adjustment, release the lever.

B600B01NF-GAT

Tilt and telescopic type (If Installed)



To adjust the steering wheel:

1. Push the lever downward fully to unlock.
2. Adjust upward or downward and forward or backward to set the steering wheel to the desired position.
3. After adjustment, securely tighten the lever by pulling it upward.

**CAUTION:**

After adjusting the steering wheel, try moving it up and down to make sure it is locked in position.

**WARNING:**

Do not attempt to adjust the steering wheel while driving as this may result in loss of control of the vehicle and serious injury or death.

FRONT DOOR EDGE LIGHT

B620A02S-AAT
(If Installed)

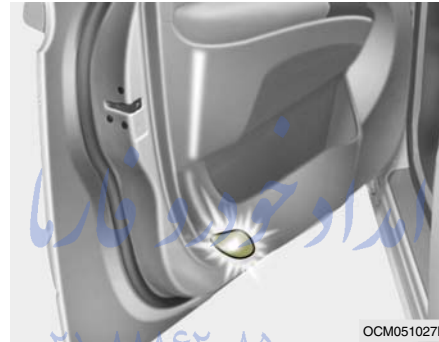

OCM051027L

A light comes on when the front door is opened.

HORN

B610A01L-GAT



OCM052052

Press the pad on the steering wheel to sound the horn.

FarmaSOS.com

CRUISE CONTROL

B660A02S-AAT

The cruise control system provides automatic speed control for your comfort when driving on straight, open freeways, toll roads, or other noncongested highways. This system is designed to function above approximately 25 mph (40 km/h).

NOTE:

Cruise control is not recommended for city driving, winding roads, slippery roads, heavy rain, or other bad weather conditions.

B660B01NF-AAT

To Set the Cruise Speed



1. Push the cruise control ON/OFF switch. The "CRUISE" indicator light in the instrument cluster will illuminate. This turns the system on.
2. Accelerate to desired cruising speed above 25 mph (40 km/h).



3. Push the "SET" (COAST) switch after you have set the vehicle speed at the desired speed. If the "SET (COAST)" switch is selected, the cruise "SET" indicator light in the instrument cluster will illuminate.
4. Remove your foot from the accelerator pedal and the desired speed will automatically be maintained.
5. To increase speed, temporarily depress the accelerator pedal enough for the vehicle to exceed the preset speed. When you remove your foot from the accelerator pedal, the vehicle will return to the speed you have set.

NOTE:

If the vehicle speed decreases more than 9 mph (15 km/h) below the set speed or decreases below 25 mph (40 km/h), the cruise control system will automatically cancel the set speed.

B660C01NF-AAT

To Cancel the Cruise Speed

To disengage the cruise control system, push the control switch "CANCEL". Additionally, the following actions will disengage the system:

- o Depress the brake pedal.
- o Depress the clutch pedal (Manual transaxle).
- o Shift the selector lever to "N" position (Automatic transaxle).
- o Decrease the vehicle speed lower than the memory speed by 9 mph (15 km/h).
- o Decrease the vehicle speed to less than 25 mph (40 km/h).
- o Release the cruise control ON/OFF switch.

B660D01NF-AAT

To Resume the Preset Speed

The vehicle will automatically resume the speed set prior to cancellation when you push the control switch "RESUME (ACCEL)" and release it to return (when travelling above 25 mph).

If the control switch "RESUME (ACCEL)" is selected, the cruise "SET" indicator in the instrument cluster will illuminate.

B660E01NF-GAT

To Reset at a Faster Speed

1. Push the control switch "RESUME (ACCEL)" and hold it. If the control switch "RESUME (ACCEL)" is selected, the cruise "SET" indicator in the instrument cluster will illuminate.
2. Accelerate to desired speed and release the control switch. While the control switch is held, the vehicle will gradually gain speed.

B660F02NF-GAT

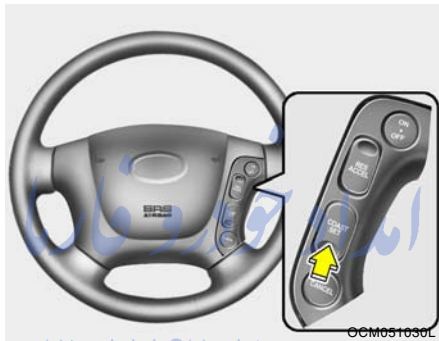
To Reset at a Slower Speed

1. Push the control switch "SET (COAST)" and hold it. While the control switch is pushed, the vehicle speed will gradually decrease. If the "SET (COAST)" switch is selected, the cruise "SET" indicator light in the instrument cluster will illuminate.
2. When the desired speed is obtained, release the control switch.

**WARNING:**

- o Keep the cruise control ON/OFF switch off when not using the cruise control to avoid inadvertently setting a speed.
- o Use the cruise control system only when traveling on open highways in good weather.
- o Do not use the cruise control when it may not be safe to keep the car at a constant speed, for instance, driving in heavy or varying traffic, or on slippery (rainy, icy or snow-covered) or winding roads or over 6% up-hill or down-hill roads.
- o Pay particular attention to the driving conditions whenever using the cruise control system.
- o During cruise-speed driving of a manual transaxle vehicle, do not shift into neutral without depressing the clutch pedal, since the engine will be overrevved. If this happens, depress the clutch pedal or release the cruise control ON/OFF switch.

**WARNING:**

- o During normal cruise control operation, when the "SET" switch is activated or reactivated after applying the brakes, the cruise control will energize after approximately 3 seconds. This delay is normal.

AUDIO REMOTE CONTROL SWITCH

B610A01CM-AAT
(If Installed)



The steering wheel audio remote control switch is installed to promote safe driving.

NOTE:

Do not operate audio remote control switches simultaneously.

1. MODE Switch

Press the MODE switch to select Radio, CD (Compact Disc) and CDC (Compact Disc Changer). Each press of the switch changes the display as follows:

RADIO (FM1 → FM2 → AM) → CD* → CDC*
 ↑ _____ |

* : If installed

2. MUTE Switch

- o Press the MUTE switch to disappear the sound.
- o Press the MUTE switch again to reproduce the sound.

3. VOL Switch

Press the VOL switch to increase or decrease volume.

4. \wedge / \vee (SEEK) Switch

MODE	Short Key (less than 0.8 sec)	Long Key (more than 0.8 sec)
RADIO	PRESET SEEK - Preset station select.	SEARCH THE FREQUENCY - Automatically tune to the next higher or lower frequency.
CDP	TRACK UP/DOWN(\wedge / \vee) - Press (\wedge) once to skip forward to the beginning of the next track. - Press (\vee) once to skip back to the beginning of the track.	FF(\wedge)/REW(\vee) - To fast forward or reverse through the track, push and hold FF or REW button. - When you release the Button, the CDP will resume playing.
6CDC	TRACK UP/DOWN(\wedge / \vee) - Press (\wedge) once to skip forward to the beginning of the next track. - Press (\vee) once to skip back to the beginning of the track.	DISC UP(\wedge)/DOWN(\vee) - Move forward or backward to the next disc and playback automatically begins. - When switching CD's, the LCD displays the selected CD's number.

HEATING AND COOLING CONTROL

B710A01JM-GAT

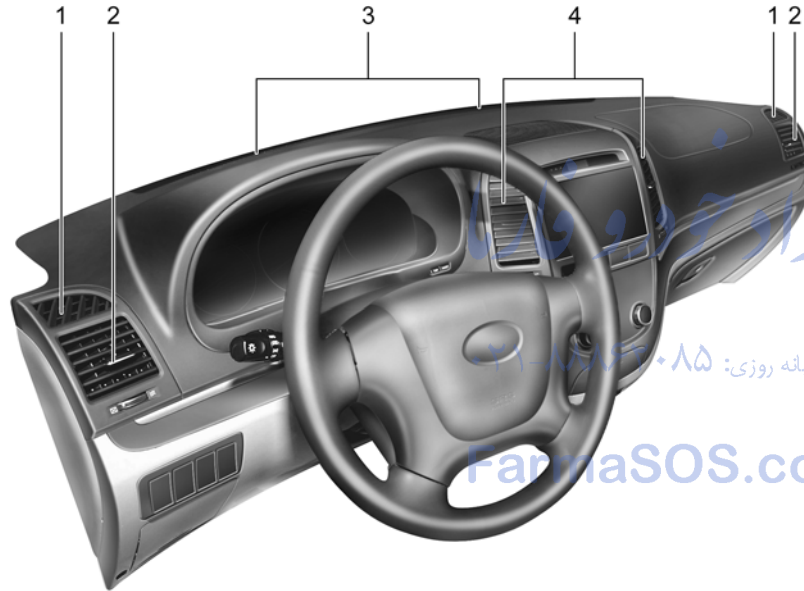

1. Side Defroster Nozzle
2. Side Ventilators
3. Windshield Defroster Nozzles
4. Center Ventilators

B710B02O-AAT

Center Ventilator

The center ventilators are located in the middle of the dashboard. To change the direction of the air flow, move the knob in the center of the vent up-and-down and side-to-side. The vents are opened when the vent knob is moved to "☰" position. The vents are closed when the vent knob is moved to "☒". Keep these vents clear of any obstructions.

B710C02HP-AAT

Side Ventilator

The side ventilators are located on each side of the dash board. To change the direction of the air flow, move the knob in the center of the vent up-and-down and side-to-side. The vents are closed when the vent knob is moved to "☒" position. The vents are opened when the vent knob is moved to "☰". Keep these vents clear of any obstructions.

HEATING AND VENTILATION

B670A01CM-AAT

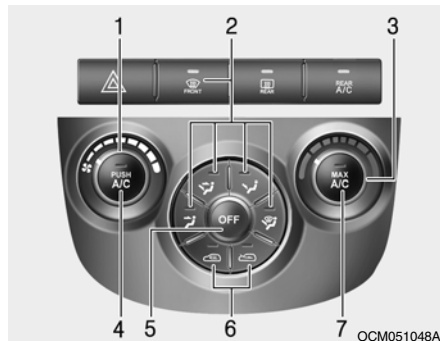

1. Fan speed control
2. Air flow control
3. Temperature control
4. Air conditioning switch
5. OFF switch
6. Air intake control switch
7. MAX A/C switch

B670B01CM-GAT

Fan Speed Control (Blower Control)

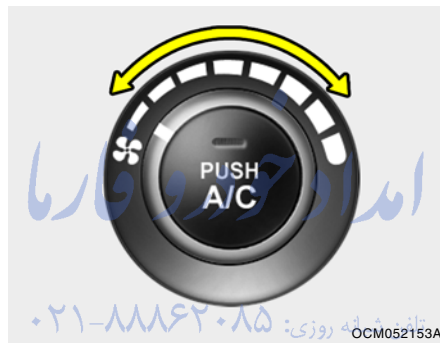

The ignition switch must be in the ON position for fan operation.
The fan speed control knob allows you to control the fan speed of the air flowing from the ventilation system. To change the fan speed, turn the knob to the right for higher speed or left for lower speed.
To turn off the fan, turn the knob to the off (0) position.

B670C03E-AAT

Air Intake Control

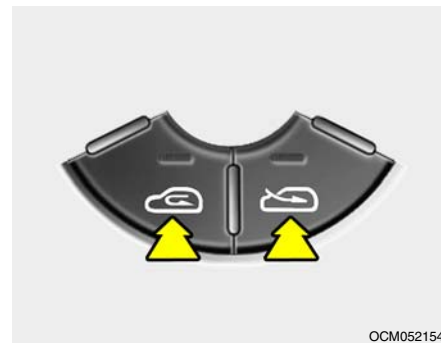

This is used to select fresh outside air or recirculating inside air.
To change the air intake control mode, (Fresh mode, Recirculation mode) push the control button.

FRESH MODE (): The indicator light on the button goes on when the air intake control is fresh mode.

RECIRCULATION MODE (): The indicator light on the button is illuminated when the air intake control is recirculation mode.

With the "Fresh" mode selected, air enters the vehicle from the outside and is heated or cooled according to the function selected.

With the "Recirculation" mode selected, air from within the passenger compartment will be drawn through the heating system and heated or cooled according to the function selected.

NOTE:

It should be noted that prolonged operation of the heating in "Recirculation" mode (☞) may result in fogging of the windshield and side windows and the air within the passenger compartment will become stale. In addition, prolonged use of the air conditioning with the "Recirculation" mode (☞) selected may result in the air within the passenger compartment becoming excessively dry.

B670D01CM-AAT

Air Flow Control



This is used to turn the blower fan on/off and to direct the flow of air. Air can be directed to the floor, dashboard outlets, or windshield. Five symbols are used to represent Face, Bi-Level, Floor, Floor-Defrost and Defrost air position.

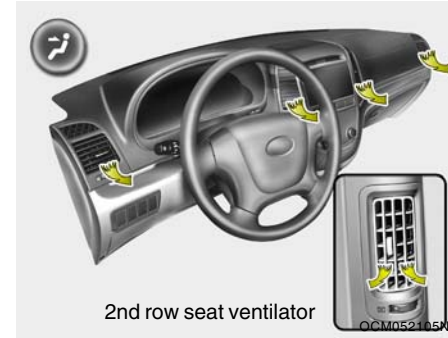

2nd row seat ventilator



Face-Level

Selecting the "Face" mode will cause air to be discharged through the side and center ventilators and 2nd row seat ventilator.

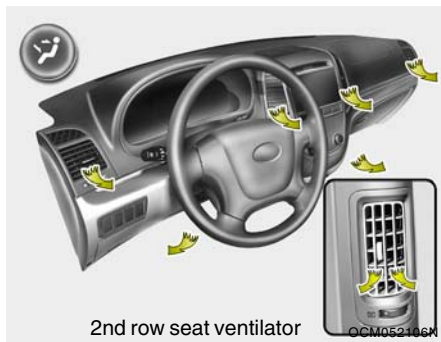

Bi-Level

Air is discharged through the face vents and the floor vents.



Floor-Level

Air is discharged through the floor vents, windshield defroster nozzle, side defroster nozzle and side ventilator. If the "Floor" mode is selected, "Fresh" mode will be activated.



Floor-Defrost Level

Air is discharged through the windshield defroster nozzle, the floor vents, side defroster nozzle and side ventilator. If the "Floor-Defrost" mode is selected, "Fresh" mode will be activated.



OCM052111



Defrost-Level

Air is discharged through the windshield defroster nozzle, side defroster nozzle and side ventilator. If the "Defrost" mode is selected, "Fresh" mode will be activated to improve windshield defrosting.



2nd row seat ventilator

OCM052105A



MAX A/C-Level

Air is discharged through the face level vents. If the "MAX A/C" mode is selected, the "FACE" mode and "Recirculation" mode will be activated.

NOTE:

- o The air intake control switch will change to " " mode when the ignition switch is turned "ON" with the MAX A/C mode selected.
- o When you change to another mode from MAX A/C, the A/C and the air intake control switch are set to the following chart.

	A/C	Air Intake Control Switch
MAX A/C OFF (?)	ON	or
?	ON or OFF *	
OFF	OFF	
?	ON or OFF *	
?	ON or OFF *	
?	ON or OFF *	

* The A/C or the air intake control switch returns to its former setting.

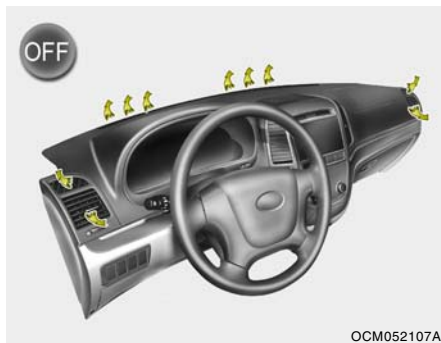

OCM052107A

OFF **Off-Level**

Air is discharged through the windshield defroster nozzle, side defroster nozzle and side ventilator.

NOTE:

If the air flow control is off, the air intake control is set to the fresh mode automatically.

B670E02A-AAT

Temperature Control

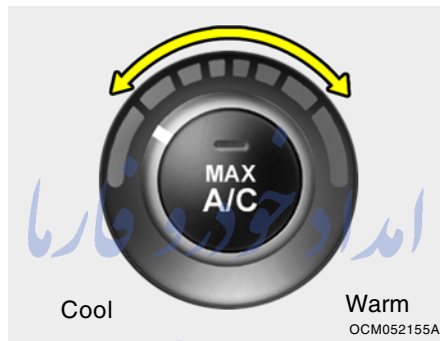

OCM052155A

This control is used to adjust the degree of heating or cooling desired.



FarmaSOS.com

HEATING CONTROLS



B690A01CM-AAT



OCM052152A

For normal heating operation, set the air intake control to the fresh air () position and the air flow control to the floor () position.

For faster heating, the air intake control should be set in the recirculate () position.

If the windows fog up, set the air flow control to the defrost () position and the air intake control to the fresh air () position.

For maximum heat, move the temperature control to "Warm".

VENTILATION

B710A01A-AAT



OCM051040A

To operate the ventilation system:

- o Set the air intake control switch to the fresh air (🌬️) position.
- o To direct all intake air to the dashboard vents, set the airflow control to the face (👤) position.
- o Adjust the fan speed control to the desired speed.
- o Set the temperature control between "Cool" and "Warm".

B730A01CM-AAT

Operation Tips

- o To keep dust or unpleasant fumes from entering the car through the ventilation system, temporarily set the air intake control to (🌬️).
- o Be sure to return the control to (👤) when the irritation has passed to keep fresh air in the vehicle. This will help keep the driver alert and comfortable.
- o Air for the heating/cooling system is drawn in through the grilles just ahead of the windshield. Care should be taken that these are not blocked by leaves, snow, ice or other obstructions.
- o To prevent interior fog on the windshield, set the air intake control to the fresh air (🌬️) position, fan speed to the desired position, turn on the air conditioning system, and adjust temperature control to desired temperature.

- o If the interior of the car is hot when you first get in, open the windows for a few minutes to expel the hot air.
- o When you are using the air conditioning system, keep all windows closed to keep hot air out.
- o When moving slowly, as in heavy traffic, shift to a lower gear. This increases engine speed, which in turn increases the speed of the air conditioning compressor.
- o On steep grades, turn the air conditioning off to avoid the possibility of the engine over-heating.
- o During winter months or in periods when the air conditioning is not used regularly, run the air conditioning once every month for a few minutes. This will help circulate the lubricants and keep your system in peak operating condition.

AIR CONDITIONING SYSTEM

B740A01A-AAT

Air Conditioning Switch (If installed)



The air conditioning is turned on by pushing the A/C button on the heating/air conditioning control panel.

B740B02A-AAT

Air Conditioning Operation Cooling



To use the air conditioning to cool the interior:

- o Turn on the fan control switch.
- o Turn on the air conditioning by pushing in on the switch. The air conditioning indicator light should come on at the same time.
- o Set the air intake control to "Fresh" mode (☞).
- o Set the temperature control to "Cool". ("Cool" provides maximum cooling. The temperature may be moderated by moving the control toward "Warm".)

- o Adjust the fan control to the desired speed. For greater cooling, turn the fan control to one of the higher speeds or temporarily select the "Recirculation (☞)" position on the air intake control switch.

B740C01S-AAT

Dehumidified Heating

For dehumidified heating:

- o Turn on the fan control switch.
- o Turn on the air conditioning switch. The air conditioning indicator light should come on at the same time.
- o Set the air intake control to the "Fresh" mode (☞).
- o Set the air flow control to the "Face" (☞).
- o Adjust the fan control to the desired speed.
- o For more rapid action, set the fan at one of the higher speeds.
- o Adjust the temperature control to provide the desired amount of warmth.

DEFROSTING/DEFOGGING

B720A01CM-AAT

A Type



B Type



OCM028216N

A Type



B Type



OCM028217N

Use the heating/ventilation system to defrost or defog the windshield:



To remove interior fog on the windshield:

- o Set the air flow control to the defrost () position.
(The "Fresh" mode will be activated.)
- o Turn on the air conditioning switch.
- o Set the temperature control to the desired position.
- o Set the fan speed control to the desired position.

To remove frost or exterior fog on the windshield:

- o Set the air flow control to the defrost () position.
(The "Fresh" mode will be activated.)
- o Turn on the air conditioning switch.
- o Set the temperature control to the warm.
- o Set the fan speed control to the high or maximum position.
- o Activate windshield wiper blade de-icer (If installed)

NOTE:

When the A/C is operated continuously on the floor-defrost level () or defrost level (), it may cause fog to form on the exterior windshield because of the temperature difference. At this time set the air flow control to the face level position () and fan speed control to the low position.

AUTOMATIC HEATING AND COOLING CONTROL SYSTEM

B970A01Y-AAT (If installed)

Your Hyundai is equipped with an automatic heating and cooling control system controlled by simply setting the desired temperature.

B970B02CM-GAT

Heating and Cooling Controls



FarmaSOS.com

OCM028096L

1. AUTO (Automatic Control) Switch
2. OFF Switch
3. Air Conditioning Switch
4. Display Window (Driver's side)
5. Temperature Control Switch (Driver's side)
6. Blower Fan Control Switch
7. Air Intake Control Switch
8. Display Window (Front passenger's side)
9. Temperature Control Switch (Front passenger's side)
10. Dual Temperature Control Selection Switch
11. Air Flow Control Switch
12. Front Window Defroster Switch
13. Rear Window Defroster Switch
14. Rear Air Conditioning Switch (If installed)

B970C01CM-AAT

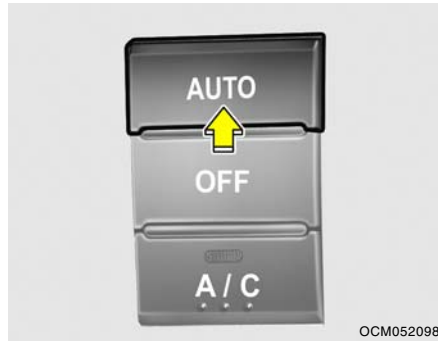
Automatic Operation

The FATC (Full Automatic Temperature Control) system automatically controls heating and cooling by doing as follows:

1. Push the AUTO button. It is indicated by AUTO on the display. The modes, fan speeds, air intake and air-conditioning will be controlled automatically by temperature setting.

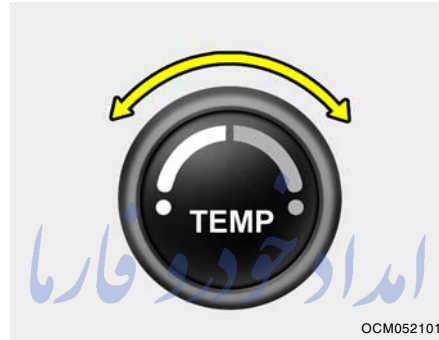

2. Turn the "TEMP" knob to set the desired temperature.
The temperature will increase to the maximum 90°F (32°C) by turning the knob clockwise.
The temperature will decrease to the minimum 62°F (17°C) by turning the knob counterclockwise.

NOTE:

If the battery has been discharged or disconnected, the temperature mode will reset to Centigrade degrees.

This is a normal condition and you can change the temperature mode from Centigrade to Fahrenheit as follows; Press the "MODE" and "DUAL" switch simultaneously for 3 seconds.

The display shows that the unit of temperature is adjusted to Centigrade or Fahrenheit (°C → °F or °F → °C).

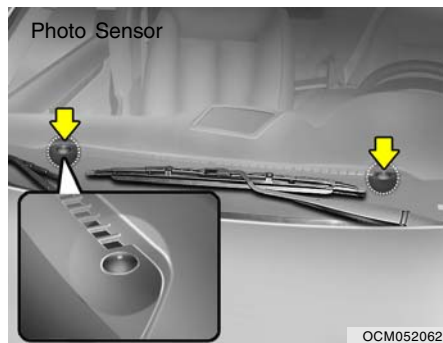
**NOTE:**

Never place anything over the sensor which is located on the instrument panel to ensure better control of the heating and cooling system.

B980A01Y-AAT

Manual Operation

The heating and cooling system can be controlled manually as well by pushing buttons other than the "AUTO" button. In this state, the system sequentially works according to the order of buttons selected. The function of the buttons which are not selected will be controlled automatically. Press the "AUTO" button in order to convert to automatic control of the system.

تلفن شبانه روزی: ۰۲۱-۸۸۶۲۰۸۵

FarmaSOS.com

B980B01Y-AAT

Fan Speed Control Switch

The fan speed can be set to the desired speed by pressing the appropriate fan speed control button. The higher the fan speed is, the more air is delivered. Pressing the "OFF" button turns off the fan.

B670C03Y-AAT

Air Intake Control Switch

This is used to select fresh outside air or recirculation inside air.

To change the air intake control mode, (Fresh mode, Recirculation mode) push the control button.

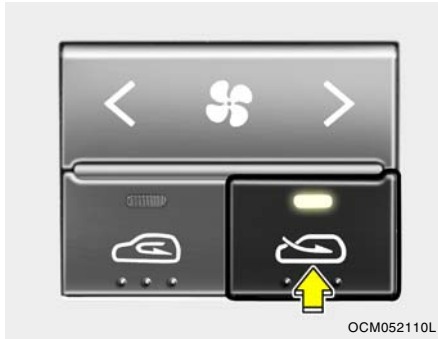

FRESH MODE () : The indicator light on the button goes on when the air intake control is fresh mode.

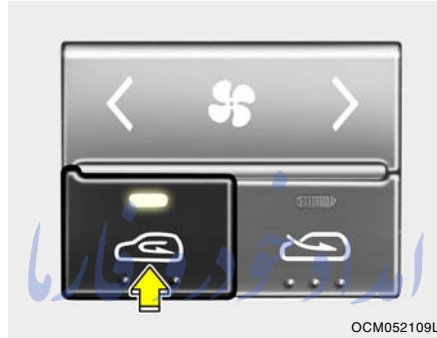

RECIRCULATION MODE () : The indicator light on the button is illuminated when the air intake control is recirculation mode.

With the "Fresh" mode selected, air enters the vehicle from the outside and is heated or cooled according to the function selected.

With the "Recirculation" mode selected, and air from within the passenger compartment will be drawn through the heating system and heated or cooled according to the function selected.

NOTE:

It should be noted that prolonged operation of the heating system in "recirculation" mode will give rise to fogging of the windshield and side windows and the air within the passenger compartment will become stale. In addition, prolonged use of the air conditioning with the "Recirculation" mode selected may result in the air within the passenger compartment becoming excessively dry.

B740A01S-AAT

Air Conditioning Switch

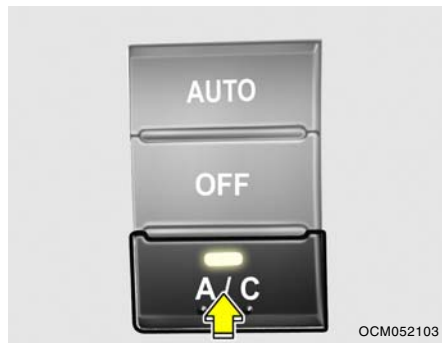

The air conditioning is turned on or off by pushing the A/C button on the heating/air conditioning control panel.

B980D01Y-AAT

Heating and Cooling System Off



Press the "OFF" button to stop the operation of the heating and cooling system.

FarmaSOS.com

B985A01CM-AAT

Dual Temperature Control Selection Switch

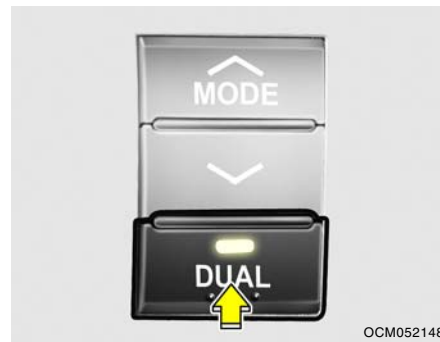

Adjusting the driver and passenger side temperature individually

Press the DUAL button or turn the passenger side "TEMP" knob to operate the driver and passenger side temperature individually (The indicator light on the button is illuminated).

Adjusting the driver and passenger side temperature equally

Press the DUAL button again or turn the driver side "TEMP" knob to the Lo position or HI position to deactivate DUAL mode (The indicator light on the button goes off). The passenger side temperature will be set to the same as the driver side temperature.

B980E01CM-AAT

Air Flow Control

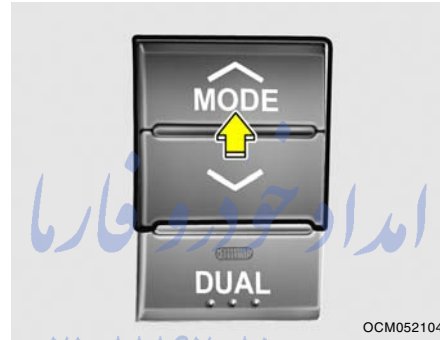

This is used to direct the flow of air. Air can be directed to the floor, dashboard outlets, or windshield. Four symbols are used to represent Face, Bi-Level, Floor and Floor-Defrost position.

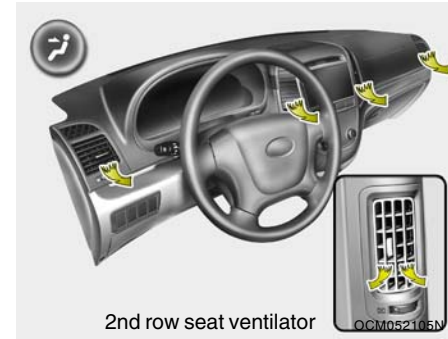

2nd row seat ventilator



Face-Level

When selecting the "Face-Level", the indicator light will come on, causing air to be discharged through the face level and the 2nd row seat ventilator.

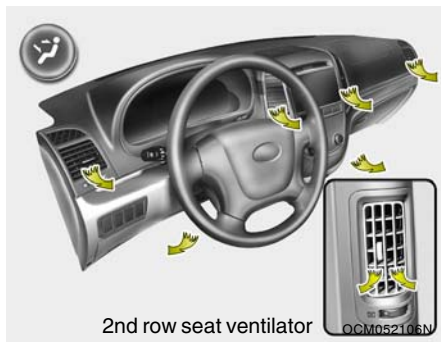

Bi-Level

When selecting the "Bi-Level", the indicator light will come on and the air will be discharged through the face, the floor and the 2nd row seat ventilator.



Floor-Level

When selecting the "Floor-Level", the indicator light will come on and the air will be discharged through the floor vents, windshield defroster nozzle, side defroster nozzle and side ventilator.



Floor-Defrost Level

When selecting the "Floor-Defrost Level", the indicator light will come on and the air will be discharged through the windshield defroster nozzle, the floor vents, side defroster nozzle and side ventilator.

B980F01CM-AAT

Defrost Switch

When the "Defrost" button is pressed, the "☁" mode will be automatically selected and the air will be discharged through the windshield defroster nozzle, side defroster nozzle and side ventilator. To assist in defrosting, the air conditioning will operate according to the ambient temperature.

REAR AIR CONDITIONING SYSTEM

B770A01CM-AAT

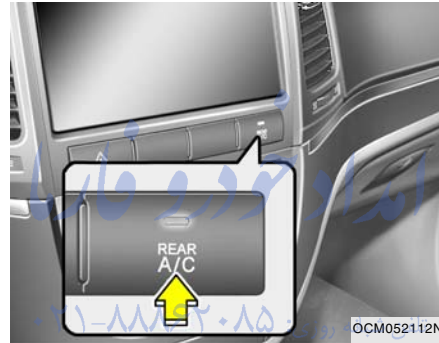
Rear Air Conditioning Switch (If installed)

You may select the rear air conditioning ON/OFF button in the front seat. When pushing the button and turning on the rear blower fan switch on the rear ventilator, the indicator light will come on and the rear air conditioning will operate.

NOTE:

The rear air conditioning system can only be used when the rear air conditioning ON/OFF button (Rear A/C) is pressed.

B770B01CM-GAT

Rear Ventilator (If Installed)

The rear ventilators are located in quarter trim. To change the direction of the air flow, move the knob in the center of the vent side to side. The blower fan speed may be controlled by setting the control lever to the desired position.

CLIMATE CONTROL AIR FILTER (IN FRONT OF EVAPORATOR UNIT)

B760A01CM-AAT
(If installed)

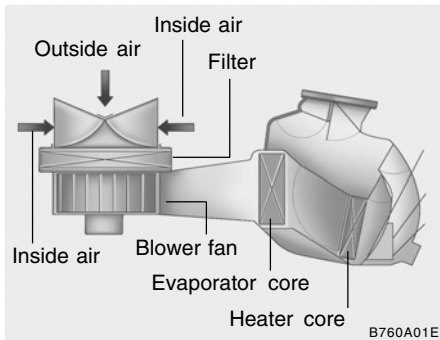

The climate control air filter is located in front of the evaporator unit behind the glove box.

It operates to decrease the amount of pollutants entering the car.

To replace the climate control air filter, refer to page 6-17.



CAUTION:

- o Replace the filter every 10,000 miles (15,000 km) or once a year. If the car is being driven in severe conditions such as dusty, rough roads, more frequent climate control air filter inspections and changes are required.
- o When the air flow rate is decreased, the system should be checked at an authorized dealer.

تلفن شبانه روزی: ۰۲۱-۸۸۶۲۰۸۵

FarmaSOS.com

ANTENNA

B870D02FC-GAT
Roof Antenna

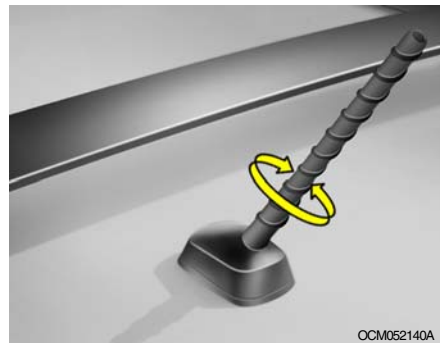

Your car uses a roof antenna to receive both AM and FM broadcast signals.

This antenna is a removable type. To remove the antenna, turn the antenna counterclockwise. To install the antenna, turn the antenna clockwise.

**CAUTION:**

- o Be sure to remove the antenna before washing the car in an automatic car wash or it may be damaged.
- o Before entering a place with a low height clearance, be sure to fold forward or remove the roof mounted antenna.
- o When reinstalling your antenna, it is important that it is fully tightened to ensure proper reception.

امداد خودرو فارما

تلفن شبانه روزی: ۰۲۱-۸۸۸۶۲۰۸۵

FarmaSOS.com

STEREO SOUND SYSTEM

B750A02A-AAT

How Car Audio Works

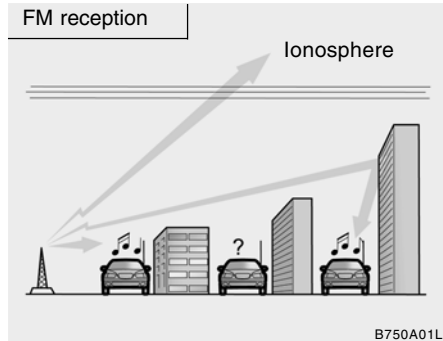

AM and FM radio signals are broadcast from transmitter towers located around your city. They are intercepted by the radio antenna on your car. This signal is then received by the radio and sent to your car speakers. When a strong radio signal has reached your vehicle, the precise engineering of your audio system ensures the best possible quality reproduction. However, in some cases the signal coming to your vehicle may not be strong and clear. This can be due to factors such as the distance from the radio station, closeness of other strong radio stations or the presence of buildings, bridges or other large obstructions in the area.

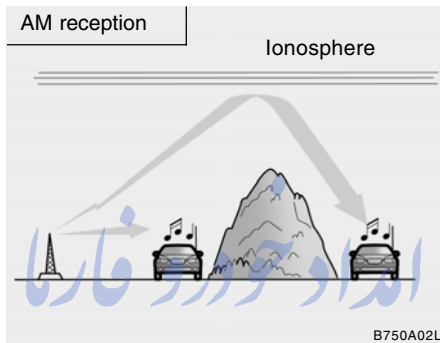

AM broadcasts can be received at greater distances than FM broadcasts. This is because AM radio waves are transmitted at low frequencies. These long, low frequency radio waves can follow the curvature of the earth rather than travelling straight out into the atmosphere. In addition, they curve around obstructions so that they can provide better signal coverage.

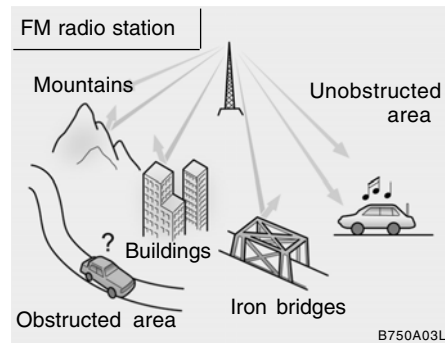

FM broadcasts are transmitted at high frequencies and do not bend to follow the earth's surface. Because of this, FM broadcasts generally begin to fade at short distances from the station. Also, FM signals are easily affected by buildings, mountains, or other obstructions. These can result in certain listening conditions which might lead you to believe a problem exists with your radio. The following conditions are normal and do not indicate radio trouble:

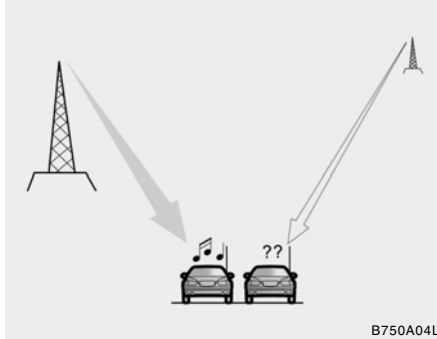

B750A04L

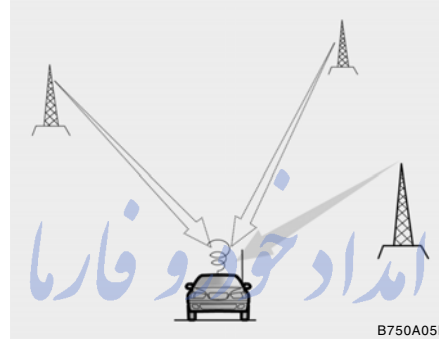

B750A05L

- o Fading - As your car moves away from the radio station, the signal will weaken and sound will begin to fade. When this occurs, we suggest that you select another stronger station.
- o Flutter/Static - Weak FM signals or large obstructions between the transmitter and your radio can disturb the signal causing static or fluttering noises to occur. Reducing the treble level may lessen this effect until the disturbance clears.

- o Station Swapping - As an FM signal weakens, another more powerful signal near the same frequency may begin to play. This is because your radio is designed to lock onto the clearest signal. If this occurs, select another station with a stronger signal.
- o Multi-Path Cancellation - Radio signals being received from several directions can cause distortion or fluttering. This can be caused by a direct and reflected signal from the same station, or by signals from two stations with close frequencies. If this occurs, select another station until the condition has passed.

B750B05Y-AAT

Using a cellular phone or a two-way radio

When a cellular phone is used inside the vehicle, noise may be produced from the audio equipment. This does not mean that something is wrong with the audio equipment. In such a case, use the cellular phone at a place as far as possible from the audio equipment.

! **WARNING:**

Hyundai recommends that you never use a cell phone while driving. This could result in loss of control, and an accident that may cause death, serious injury, or property damage. You must stop at a safe place to use a cellular phone.

NOTE:

Some states and cities have regulations prohibiting the use of cell phones while driving. You should be aware of the specific requirements in your area.

CARE OF DISCS

B850A02F-AAT

Proper Handling

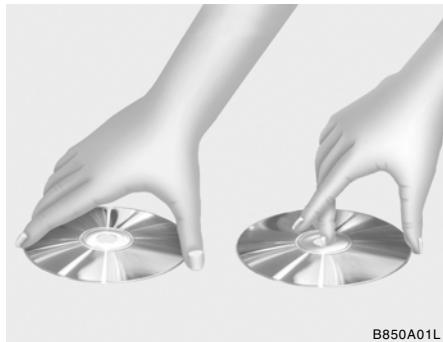

B850A01L

Handle your disc as shown. Do not drop the disc. Hold the disc so you will not leave fingerprints on the surface. If the surface is scratched, it may cause the pickup to skip signal tracks. Do not affix tape, paper, or gummed labels on the disc. Do not write on the disc.

Damaged Disc

Do not attempt to play damaged, warped or cracked discs. These could severely damage the playback mechanism.

Storage

When not in use, place your discs in their individual case and store them in a cool place away from the sun, heat, and dust. Do not grip or pull out the disc with your hand while the disc is being pulled into the unit by the self loading mechanism.

تلفن شبانه روزی: ۰۲۱-۸۸۶۲۰۸۵

FarmaSOS.com

Keep Your Discs Clean

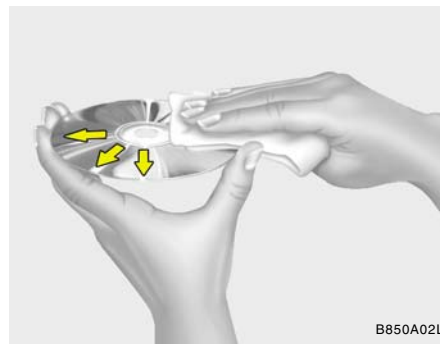

B850A02L

Fingerprints, dust, or soil on the surface of a disc could cause the pickup to skip signal tracks. Wipe the surface clean with a clean soft cloth. If the surface is heavily soiled, dampen a clean soft cloth in a solution of mild neutral detergent to wipe it clean. See drawing.

AUDIO SYSTEM

B445A02CM-AAT

IDENTIFYING YOUR AUDIO SYSTEM (IF INSTALLED)

The front panels of the respective audio system models are shown below. Identify the model of your audio system by the pictures shown below.



Model D445S

AM/FM/XM tuner with single-disc CD player and SDAR support



Model D465S

AM/FM/XM tuner with 6-disc changer CD player and SDAR (Satellite Digital Audio Radio) support.

Optional factory-installed RSE system*.



Model D466S

AM/FM/XM tuner with 6-disc changer CD player and SDAR support.

Optional factory-installed RSE system*.

B445B02CM-AAT

CONTROLLING HOW YOUR AUDIO SYSTEM SOUNDS

Operating your Audio system

Your audio system comprises a factory-installed amplifier, an AM/FM digital tuner (radio) and a CD player (single disc or 6-disc changer). Use the CD player to play discs encoded in the CD Audio, MP3, and WMA formats. This audio system also comes with an external Satellite Digital Audio Receiver (SDAR) in providing the XM service.

If your audio system is the D465S or D466S model and it is connected to a factory-installed Rear Seat Entertainment (RSE) system*, you can control some playback functions of the RSE system using the audio system's front panel controls (for example, CD player controls).

Your audio system has 5 different types of controls. These controls are used either independently or in combination with your audio system's radio, CD player, SDAR or optional RSE system*.

NOTE:

Your audio system's factory-installed amplifier is pre-configured for optimum performance. You will not be able to make any adjustments. If there is a problem with the audio system's amplifier, please consult a professional audio engineer or the dealer where you purchased your vehicle.

تلفن شبانه روزی: ۰۲۱-۸۸۶۲۰۸۵

FarmaSOS.com

1. General Controls:

These controls are used to operate the entire audio system. (e.g. Power **ON-OFF** control knob)

Use these controls independently or in combination to control how the audio system sounds. (e.g. **Volume** control, **Bass** and **Treble** controls)

The sound settings you make are applicable to all audio reproduction sources (radio, CD, SDAR or auxiliary RSE* devices).

2. AM/FM tuner controls:

Use these controls to operate, navigate the menu options and change settings when you are using the AM/FM digital tuner.

The figure below is an example of the LCD screen display in tuner mode.



3. CD controls:

Use these controls to operate the CD player/changer, navigate the discs menu options and change playback settings when you are using the CD player. The figure below is an example of the LCD screen display in CD mode.



4. XM controls:

Use these controls to operate, navigate the menu options and change settings when you are using the SDAR. The figure below is an example of the LCD screen display in XM mode.

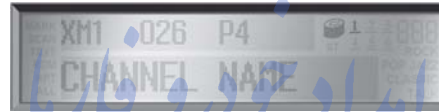

تلفن شبانه روزی: ۰۲۱-۸۸۶۲۰۸۵

FarmaSOS.com

5. Rear Seat Entertainment (RSE) controls (for D465S and D466S only):

To switch between CD and RSE modes, press the **CD/RSE** button until you see the corresponding screen displays.

If a factory-installed RSE system (optional) is connected to your audio system, use the RSE controls (located at the rear of the center console), remote control and D465S or D466S front panel audio controls in combination to operate the video player, navigate disc menu options and change playback settings.

The figure below is an example of the LCD screen display in RSE mode.



NOTE:

A button or control may have different functions depending on whether you are using the Radio, CD player or RSE mode. For example, the RPT (Repeat) button can only be used in the CD mode.

*** Only for Model D465S and D466S**

Passengers in the rear seat can use the RSE to play DVD/VCD/MPEG discs. The RSE system functions as an auxiliary source, directing sound to the audio system for amplification and processing. For more information, please refer to the RSE section.

امداد خودرو فارما

تلفن شبانه روزی: ۰۲۱-۸۸۸۶۲۰۸۵

FarmaSOS.com

B445C02CM-AAT

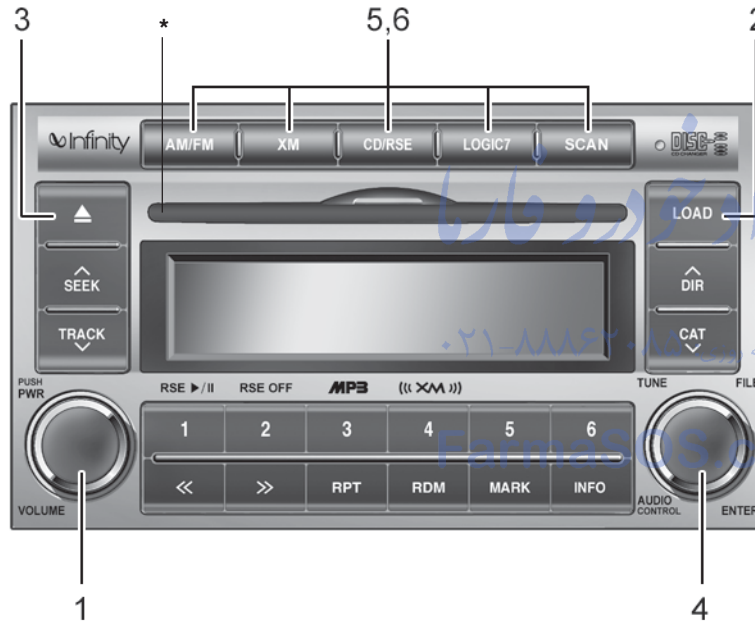
USING GENERAL CONTROLS

1. **POWER ON-OFF**/Volume control knob
2. **SCAN** button (Model D445S)
LOAD button (Model D465S and D466S)
3. **CD EJECT** (▲) button
4. **AUDIO CONTROL** knob
5. **Input source selector buttons**
Depending on your model, the buttons shown are **AM/FM, FM, FM1, FM2, XM, CD, CD/RSE**
6. **Surround Sound selector LOGIC7** (for Model D466S only)

*. CD Loading / Ejecting Slot

D466S01CM

* Model shown is D466S. The buttons on your audio system may differ.
For details, see specific descriptions in the following sections

B445D02CM-AAT

1. Power ON-OFF / Volume Control knob

Power

To operate your audio system, your ignition key must be in the “ACC” or “ON” position.

Press the knob to switch on the audio system. The audio system resumes operation in either the Radio, CD mode, XM mode or RSE mode (only for model D465S or D466S with RSE system connected).

Press the knob again to switch off the audio system.

Volume Control Knob

Rotate the knob clockwise to increase the volume and rotate the knob counter-clockwise to reduce the volume.

2. Loading CDs

Model D445S :

Only one CD can be loaded at any one time. If there is already a disc inserted in the CD player, eject the disc before loading a new CD.

To load a CD, gently insert the CD into the CD slot. The CD will be automatically loaded. The CD player then starts to play the CD.

NOTE:

- o Do not force-load the CD as it will damage the loading mechanism and cause your disc to jam in the player.
- o If a CD cannot be loaded, check if there is already a disc in the player and eject it first.

Models D465S and D466S :

Press the **LOAD** button to automatically switch the audio system to the CD player mode.

Follow the instructions on the LCD screen to load and play your CDs.

NOTE:

To load more than 1 CD (maximum of 6), press and hold the load button for more than 2 seconds. The disc number indicator will flash to indicate how many CDs you can still load.

3. CD EJECT (▲) Button

Model D445S :

Press the ▲ button once to eject the CD from the CD player.

Models D465S and D466S :

Press the ▲ button once to eject the last CD played.

Press and hold button for more than 2 seconds to eject all the CDs in the changer in sequence beginning with the last CD played.

NOTE:

You can eject discs even if the audio system is switched off.

4. Audio Control knob

Use the audio control knob to change how music playback sounds and also to control how sound is distributed to the speaker system.

Sound properties

Press the knob repeatedly to display the corresponding audio control settings (**Bass, Middle, Treble, Fader, Balance, EQ**).

The LCD screen displays the audio control settings in sequence. Once the audio control setting you want is displayed, rotate the knob **clockwise/anti-clockwise** to change the level of that audio setting.

- Bass** – increases/decreases Bass response of audio reproduction
- Middle** – increases/decreases Mid-range response of audio reproduction
- Treble** – increases/decreases Treble response of audio reproduction
- Fader** – sets front/rear balance level for your speaker system
- Balance** – sets left/right balance level for your speaker system
- EQ** – selects one of the 6 equalizer settings: **ROCK, POP, JAZZ, CLASSIC, TALK** and equalizer off by turning the audio control knob once in the EQ mode. If no icon is displayed in the LCD screen, the equalizer is switched off.

The 5 preset equalizer settings have been optimized for the 5 common genres of music. For example, the **ROCK** setting enhances bass reproduction with rock music whereas the **CLASSIC** setting enhances the clarity of string instruments during audio reproduction of classical music. You may want to experiment with the different settings to confirm your personal preferences.

If you store an AM/FM station or a XM channel **Preset (1-6)** with a specific equalizer setting, that setting is automatically used when you select that preset again.

EQ is not available for Model D466S.

NOTE:

To return all audio control settings (except for EQ) to the default (centered) positions, press and hold the audio control knob for more than 2 seconds. An audible beep indicates that all audio controls have been returned to the default setting.

5. AM, FM, FM1, FM2, XM, CD, CD/RSE selector buttons

Model D445S: AM, FM1, FM2, XM, CD

Model D465S: AM, FM, XM, CD/RSE

Model D466S: AM/FM, XM, CD/RSE

Use the input source selector buttons to select the desired operation mode between the AM mode, the FM mode, the XM mode, the CD mode and the RSE mode.

Pressing any of these buttons when the audio system is at off state automatically switches the audio system on and goes into the selected operation mode.

The LCD screen displays the operation mode you currently selected.

NOTE:

- o Remember that station Presets (1-6) stored in FM1 mode can only be accessed in FM1 mode. Similarly, FM2 presets can only be accessed in FM2 mode. That also applies to the presets (1-6) for XM1, XM2 and XM3 modes.
- o For Model D465S:
Press the FM band selector button repeatedly to switch between the FM1 and FM2 modes.
- o For Model D466S:
Press the AM/FM band selector button repeatedly to switch between the AM, FM1 and FM2 modes.
- o For all models:
Press the XM button repeatedly to switch between the XM1, XM2 and XM3.
- o For Models D465S and D466S:
If a Rear Seat Entertainment (RSE) system is connected to your audio system, press the CD/RSE player selector button repeatedly to switch between CD and RSE modes.

6. Surround Sound select Model D466S: LOGIC7 button

LOGIC7 button:

The **LOGIC7** button controls the Surround Sound effects of audio reproduction. Generally, switching on the LOGIC7 function will give music playback a fuller, more 3-dimensional 'feel'.

Press the LOGIC7 button to switch the LOGIC7 effect on/off. The LCD screen displays the ON/OFF status.

امداد خودرو فارما

تلفن شبانه روزی: ۰۲۱-۸۸۸۶۲۰۸۵

FarmaSOS.com

B445D02CM-AAT

USING AM / FM TUNER CONTROLS

The functions of the buttons and controls described below are only applicable when you select the Tuner mode by pressing the **AM/FM** selector button (model D466S) or the **AM** or **FM** selector buttons (models D465S), or, **AM**, **FM1** or **FM2** selector buttons (model D445S).

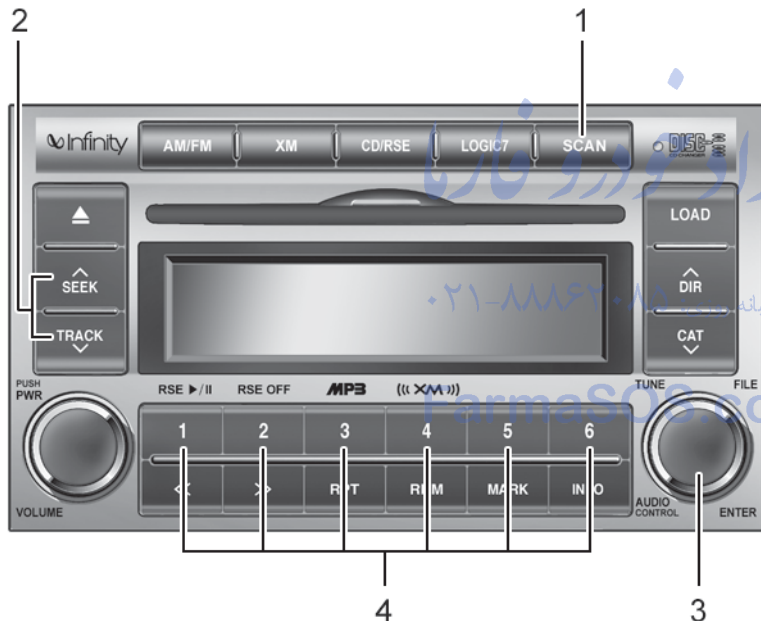

1. **SCAN** button with **STATION / PRESET SCAN** function
2. **SEEK** '▲' and '▼' buttons with **Auto-matic Station Selection** function
3. **TUNE** Knob for Manual Station selection
4. **Station Preset (1~6)** buttons

* Model shown is D466S. The buttons on your audio system may differ.
For details, see specific descriptions in the following section

D466S02CM

B445E02CM-AAT

1. SCAN button

Station scan function

Press the **SCAN** button for the tuner to scan for radio signals in the selected frequency band (AM or FM). Once the tuner locks onto the signal of a transmitting station, it plays that station for 5 seconds before scanning for the next available station in the selected frequency band.

If you want to keep listening to a particular station and want to stop the scanning, press the **SCAN** button again.

This function is useful for providing you with a good overview of all the radio stations within range of your tuner.

Preset scan function

Press and hold the **SCAN** button for more than 2 seconds. Each preset radio stations will be automatically played for 5 seconds. If you want to keep listening to a particular preset station and want to stop the scanning, press the **SCAN** button again.

2. SEEK '^' and 'v' buttons

Automatic Station Selection function

Press the '^' and 'v' buttons to scan up and down the frequency range for the next available radio station and automatically lock on to that frequency.

The LCD screen displays the frequency of the radio station transmitting a clear and strong signal.

Use this function to search for a radio station you want. If you like a particular station, you can store it as one of 6 presets using the Preset buttons described later.

NOTE:

This function is not effective if you are experiencing poor reception in your vicinity.

FarmaSOS.com

3. TUNE Knob

Manual Station Selection

Rotate the knob clockwise or counter-clockwise to manually advance up or down the frequency range. The Tune knob also gives you fine-grain control which you can use to manually fine-tune your frequency selection. This is useful if you are searching for a radio signal which is not strong enough for you to use the Automatic Station Selection function

NOTE:

The speed at which you advance up or down the frequency range depends on how fast you turn the knob.

4. Station Preset buttons (1~6)

There are 6 Station Preset buttons which you can use to store the frequencies of your 6 favorite radio stations. Saving a station as a preset gives you one-touch access to the station you want. Remember that the 6 presets stations you store are for the specific radio band mode you are in. That means that you can store up to 6 stations in **AM** mode, 6 in **FM1** mode, and 6 in **FM2** mode. This means that you can store up to 18 of your favorite stations in the preset memory.

NOTE:

- o For Model D445S, use **FM1** and **FM2** buttons to switch between **FM1** and **FM2** modes.
- o For Model D465S, use **FM** button to switch between **FM1** and **FM2** modes.
- o For Model D466S, use **AM/FM** button to switch between **AM**, **FM1** and **FM2** modes.
- o Remember that if you store a station as preset 1 in **FM2** mode, you must first select **FM2** mode before you can use that preset button.
- o This function is not effective if you are experiencing poor reception in your vicinity.

Using Presets

To save a radio station as a preset:

1. Take note of the band selection displayed on the LCD screen (**AM**, **FM1** or **FM2**)
2. Tune in to the radio station you want using either the **SEEK UP** and **DOWN** buttons or the **TUNE Knob**.
3. Choose the preset button (1~6) you want to use to store the radio station.
4. Press and hold the Preset button for more than 2 seconds.

The system beeps to indicate that it has saved the new station and displays the frequency and preset number on the LCD screen.

NOTE:

Saving a new station erases the previous setting saved in that preset.

To tune in to a preset station:

1. Select the band (**AM**, **FM1** or **FM2**) you want using the band selector buttons.
2. Press the preset button corresponding to the radio station you want.
The system automatically jumps to the preset station. The frequency and preset number is displayed on the LCD screen.

Buttons not in use in tuner mode

The following buttons and functions are not used in tuner mode.

- << button
- >> button
- **RPT** button
- **RDM** button
- **MARK** button
- **INFO** button

B445F02CM-AAT

USING CD PLAYER CONTROLS

The functions of the buttons and controls described below are only applicable when you select the **CD** mode by pressing the **CD** selector button (for model D445S) or the **CD/RSE** selector button (models D465S and D466S).

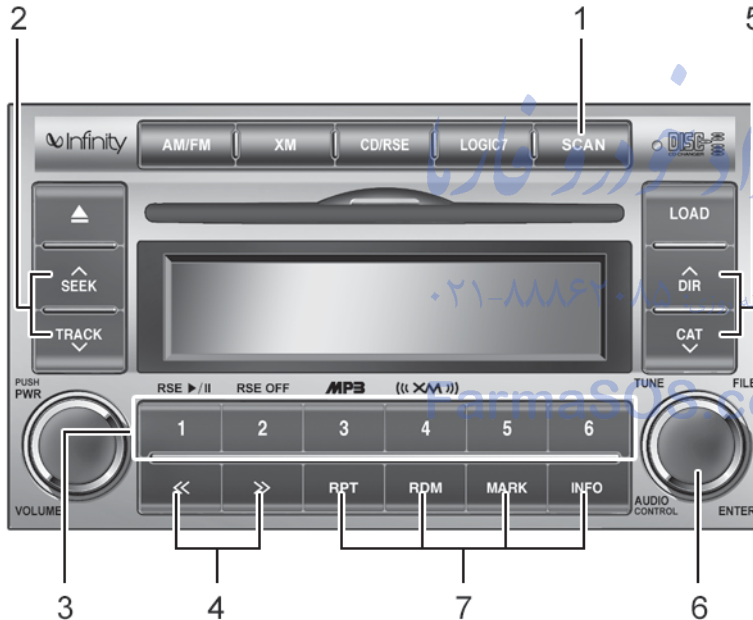

1. **SCAN** button
2. **TRACK '▲'** and **'▼'** buttons
3. **CD selector buttons(1-6)**
* Not used with D445S
4. **Rewind <<** and **Fast Forward >>** buttons
5. **DIR '▲'** and **'▼'** buttons
* Used with MP3 and WMA discs
6. **File Search Knob**
Random play **RDM** button
Marklist **MARK** button
Disc **INFO** button
7. Repeat **RPT** button

NOTE:

For models D465S and D466S, if a RSE system is connected to your audio system, press the **CD/RSE** selector button repeatedly to switch between CD mode and RSE mode.

* Model shown is D466S. The buttons on your audio system may differ. For details, see specific descriptions in the following section

D466S03CM

B445G02CM-AAT

1. SCAN button**Disc Scan function**

During CD playback, press the **SCAN** button to play the first 10 seconds (pre-view) of all tracks on the current CD.

Once you hear a track you want, press the **SCAN** button again to resume normal playback

2. Track UP '^' and DOWN 'v' buttons

During CD playback, press the ^ and v buttons to select and play the next or previous track on the current disc. The LCD screen displays the track number as you press the buttons. You can press the button several times to select the track you want.

3. CD selector buttons (1~6)**Model D445S:**

The CD selector buttons are not used with Model D445.

Models D465S and D466S:

Press the CD selector button corresponding to the CD you want. The CD player automatically interrupts playback and loads the selected CD.

NOTE:

If no CD is loaded in the selected position, the LCD screen displays the No Disc indicator.

4. Rewind << and Fast Forward >> buttons

During CD playback, press and hold the << or >> buttons to rewind or fast-forward playback of the current track. The LCD screen displays the elapsed time of the track you are rewinding or fast-forwarding. Release the << or >> button when you have reached the point you want. Playback resumes automatically at the selected point.

5. DIR '^' and 'v' buttons (MP3 and WMA discs)

During MP3/WMA CD playback, press the **DIR '^'** or **'v'** buttons to switch to the next or previous directory on the CD. The LCD screen displays the name of the directory you have switched to. You can press the button several times to search for the directory you want. The directories are displayed in sequence (i.e. ascending or descending alphabetical order).

To access the directory displayed, press the **File Search** knob to **ENTER** your selection.

NOTE:

The Directory UP and DOWN buttons can only be used when you are playing a CD which has organized its tracks in the form of directories. Normally, only MP3 or WMA CDs will contain a directory tree which you can navigate using these buttons.

6. File Search Knob

Rotate the knob clockwise or counter-clockwise to manually advance up or down the track list of the CD currently played. This function allows you to quickly scroll to a specific track number. It is especially useful if you are playing an MP3 or WMA CD which contains many directories and tracks. The LCD screen displays the track number you have scrolled to.

Once the track number you want is displayed, press the **File Search** knob to **ENTER** your selection and begin playback of the selected track.

NOTE:

You must push the File Search knob to select the track for playback. Otherwise, the CD player will not jump to the track number displayed in the number counter.

Use the File Search knob and the DIR '^' and 'V' buttons in together to quickly search for a track you want on an MP3 CD with many directories and tracks.

7. RPT, RDM, MARK & INFO buttons

These buttons correspond to the Repeat, Random Playback, Marklist and Disc Information functions.

Turn to the next section of your handbook for detailed instructions.

تلفن شبانه روزی: ۰۲۱-۸۸۸۶۲۰۸۵

FarmaSOS.com

B445F02CM-AAT

PLAYING CDS, MP3 AND WMA DISCS



D466S04CM

1. Loading CDs
2. Ejecting CDs
3. Selecting a disc to play
4. Selecting and playing tracks (songs)
5. Using the Repeat function (**RPT** button)
6. Using the Random playback function (**RDM** button)
7. Using the Bookmark function (**MARK** button)
8. Using the file information function* (**INFO** button)

* Model shown is D466S. The buttons on your audio system may differ.
For details, see specific descriptions in the following section

B445G02CM-AAT

1. Loading CDs

Model D445S:

Only one CD can be loaded at any one time. If there is already a disc inserted in the CD player, eject the disc before loading a new CD.

To load a CD, gently insert the CD into the CD slot. The CD will be automatically loaded. The CD player then starts to play the CD.

NOTE:

- o Do not force-load the CD as it will damage the loading mechanism and cause your disc to jam in the player.
- o If a CD cannot be loaded, check if there is already a disc in the player and eject it first.

Only one CD can be loaded at any one time.

Models D465S and D466S:

You can load one or more CDs (maximum of 6) into the CD changer through the CD loading slot. To do so:

1. Press the **LOAD** button to load 1 CD. The LCD screen displays the number assigned to the CD as a flashing number. For example, if the CD changer currently contains 4 CDs, the loaded disc will be CD 5.
OR
Press and hold the **LOAD** button for more than 2 seconds to load more than 1 CD. The LCD screen displays empty slots in the CD changer as flashing numbers.
2. The LCD screen displays the instructions for loading one or more CDs. Follow the instructions - "Wait, Insert CD1, Loading CD 1, Reading CD1,... Reading CD6".

3. Once you have finished loading the CD or CDs, the CD player automatically plays the first track of the last CD loaded. If the audio system was in Radio mode while you were loading the CDs, it automatically switches to CD player mode.

NOTE:

The LCD screen displays **Changer Full** to indicate that the CD changer is full. Do not try to load any other disc.

2. Ejecting CDs

Model D445S

Press the **CD EJECT** () button to eject the CD in the CD player.

Models D465S and D466S

Press the  button once to eject the last CD played.

Press and hold  button for more than 2 seconds to eject all the CDs in the changer in sequence beginning with the last CD played.

NOTE:

You can eject discs without switching on the audio system using the Power ON-OFF knob.

To eject 1 CD:

Press the **EJECT** button once.

If you are playing a CD, playback will automatically switch to the next available CD.

The LCD screen displays the number of the CD ejected as a flashing number.

If there are no other disc left in the CD changer, the audio system automatically switches to Radio mode and resumes with the last channel or frequency selected.

OR

If the audio system is in Radio mode, the last CD played will be ejected.

The LCD screen displays the number of the CD ejected as a flashing number.

To eject all CDs:

Press and hold the **EJECT** button for more than 2 seconds to eject all the CDs in the CD changer.

The LCD screen displays the CDs being ejected in the CD changer as flashing numbers. The CDs are ejected in sequence. Follow the instructions displayed on the LCD screen to remove all CDs from the changer.

NOTE:

If the audio system is in Radio mode, you can eject CDs without interrupting the operation of the radio.

3. Selecting a disc to play

Model D445S

Only the CD loaded in the player can be played.

Models D465S and D466S

You can select any disc loaded in the CD changer for playback.

To do so:

Press the corresponding CD selector button (1 – 6).

The CD changer automatically loads the selected CD and begins playback of the first track.

The LCD screen displays the selected CD as a flashing number.

4. Selecting and playing tracks (songs)

To select tracks, you can use one of 3 methods:

Method 1:

Press the **Track Up** or **Track Down** button repeatedly until you find the track you want.

Method 2:

Rotate the **File Search** knob to scroll to the track you want. The number counter in the LCD screen shows you the track number.

Press the **File Search** knob to **ENTER** your selection and begin playback.

Method 3 (only for MP3 and WMA CDs):

Press the **DIR Up** or **Down** buttons repeatedly to switch to the directory you want on the CD.

The LCD screen displays the name of the directory you have switched to.

Rotate the **File Search** knob to scroll to the track you want in the selected directory. The number counter in the LCD screen shows you the track number. Press the **File Search** knob to **ENTER** your selection and begin playback.

NOTE:

You may notice that the track number counter on the LCD screen matches the track list on audio CDs exactly while that may not be the case for MP3 or WMA CDs. This is because WMA and MP3 CDs typically contain multiple tracks (files) that are organized on the CD as directories. The number counter displays the track number of the track being played in relation to the numbering system on the MP3 or WMA CD. Depending on the sequence in which the files and directories were added to the CD, the track number sequence displayed on the screen may not match the playback sequence. This is due to the MP3 and WMA encoding process and does not mean that your CD player is defective.

5. Using the Repeat function (RPT button)

To repeat playback of the current track:

Press the **RPT** button once. The LCD screen displays **RPT** to indicate that it is in **REPEAT** mode. Playback of the current track will be repeated.

Press the **RPT** button again to resume normal playback. The **RPT** indicator is cleared.

To repeat playback of all tracks on the current CD/File Directory:

Press and hold the **RPT** button for more than 2 seconds. The LCD screen displays **RPT ALL** to indicate that it is in **REPEAT ALL** mode. The tracks of the current audio CD or the tracks in the current MP3 file directory will be repeated.

Press the **RPT** button again to resume normal playback. The **RPT ALL** indicator is cleared.

6. Using the Random playback function (RDM button)

For random playback in audio CDs (also applies to current MP3 file directory):

Press the **RDM** button once. The LCD screen displays **RDM** to indicate that it is in **RANDOM** mode. Tracks on the current audio CD/MP3 directory will be randomly selected and played.

Press the **RDM** button again to resume normal playback. The **RDM** indicator is cleared. Normal playback resumes.

For random playback of all tracks on a CD (only for MP3 and WMA CDs):

Press and hold the **RDM** button for more than 2 seconds. The LCD screen displays **RDM ALL** to indicate that it is in **RANDOM ALL** mode. Tracks from all directories in the MP3/WMA CD will be randomly selected and played.

Press the **RDM** button again to resume normal playback. The **RDM ALL** indicator is cleared.

7. Using the Bookmark function (MARK button)

The Bookmark function allows you to select and add up to 20 tracks from any CD in the CD changer to a playlist (marklist). You can then play the tracks on the playlist whenever you want.

Adding tracks to the playlist (marklist):

1. Play the track you want.
2. Press and hold the **MARK** button for more than 2 seconds to add the current track to the playlist (marklist). The LCD screen displays **MARK** to indicate that the track has been added to the playlist (marklist).
3. Repeat steps 1 & 2 to add more tracks to the marklist (maximum of 20 bookmarks.)

Playing tracks on the playlist (marklist):

1. Press the **MARK** button once. The LCD screen displays **MARK** to indicate that it is in bookmark mode and automatically begins playback of the tracks saved on the playlist (marklist) in sequence.
2. Press the **MARK** button again to resume normal playback. The **MARK** indicator is cleared. Normal playback resumes.

Deleting tracks from the playlist (marklist):

1. Press the **MARK** button once. The LCD screen displays **MARK** to indicate that it is in bookmark mode and automatically begins playback of the tracks saved on the playlist (marklist) in sequence.
2. Select the track you want to remove. (See **Selecting and playing tracks (songs)**)
3. Press and hold the **MARK** button for more than 2 seconds. The LCD screen displays **TRACK DELETED** to confirm that the bookmark has been deleted.

Deleting all tracks from the playlist (marklist):

1. Press the **MARK** button once. The LCD screen displays **MARK** to indicate that it is in bookmark mode and automatically begins playback of the tracks saved on the playlist (marklist) in sequence.
2. Press and hold the **MARK** button for more than 4 seconds. The LCD screen displays **MARKLIST EMPTY** to confirm that all the bookmarks in the playlist (marklist) have been deleted.

تلفن شبانه روزی: ۰۲۱-۸۸۶۲۰۸۵

FarmaSOS.com

8. Using the file information function* (INFO button)

* **This function can only be used with MP3/WMA tracks**

Press the **INFO** button repeatedly to display information about the track. The LCD screen displays the **File Name**, **Artiste Name** and **Song Title** in sequence.

Note:

The information (**File Name**, **Artiste Name** and **Song Title**) available for display depends on the information the MP3/WMA file was encoded with. If the relevant information was not included when the file was encoded, you will not be able to see it.

B466A02CM-AAT

USING XM CONTROLS

The functions of the buttons and controls described below are only applicable when you select the XM mode by pressing the **XM** selector button.

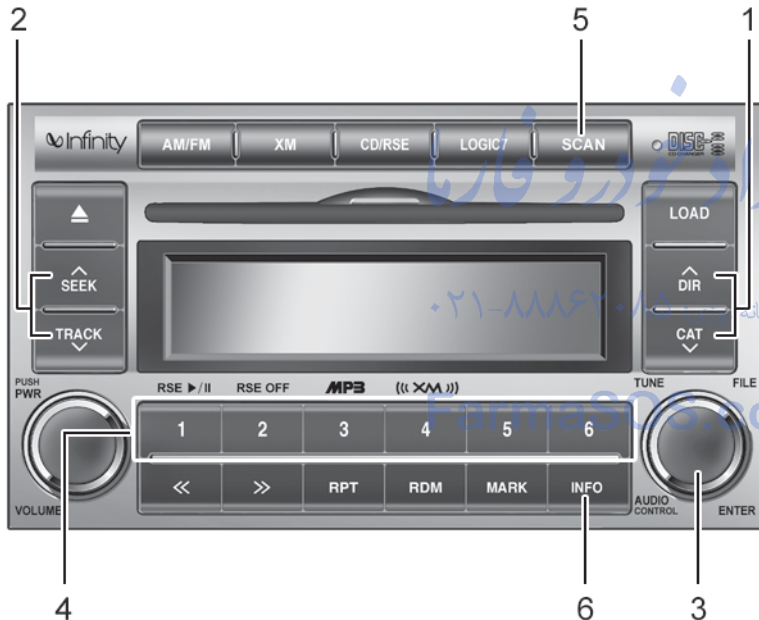

1. CAT '^' and 'v' for category up/down
2. SEEK '^' and 'v' buttons for channel select
3. TUNE knob for manual channel tune
4. Station Preset (1-6) buttons
5. SCAN button with Channel / Preset SCAN function
6. INFO button

* Model shown is D466S. The buttons on your audio system may differ. For details, see specific descriptions in the following section

D466S05CM

1. CAT UP '^' / DOWN 'v' buttons

Press **CAT UP '^' / DOWN 'v'** buttons to go to next/previous categories. Once reached the desired category, press the **ENTER** knob to select the category. The audio system will play the first channel of the new category. If there is no **ENTER** carried out 5 seconds after the last **CAT UP '^' / DOWN 'v'** button, the category up/down is canceled and the audio system reverts the display back to current active channel. The figure below shows the H/U display when the user is doing a category up/down.



When a category is being selected, the audio system sets a category search flag. This flag will stay on for 5 seconds if there is no other button press. During this ON period, the subsequent SEEK, SCAN and TUNE operations will be enclosed within the category. Otherwise, the above operation will be done across all categories. The figure below shows the audio system display when the category search flag is on.



تلفن شبانه روزی: ۰۲۱-۸۸۸۶۲۰۸۵

FarmaSOS.com

2. SEEK '^' and 'v' buttons

Press **SEEK '^' and 'v'** to access next/previous channels. No **ENTER** is required. There are two types of seek operations. One is the single seek and the other is the continuous seek.

Single seek is invoked by press-&-release the **SEEK '^' and 'v'** button. Each single seek goes to next/previous XM channel, with new channel audio.

Continuous seek is invoked by press-&-hold the **SEEK '^' and 'v'** button until the desired XM channel is reached. During the continuous seek, the audio system plays the current channel audio until the **SEEK** button is released.

When the category search is on, the seeking is blinded within the current category. Otherwise, it is done across the categories.

3. TUNE Knob

Turn the **TUNE knob** to scroll through the XM channels. This is called **manual tuning**. Upon reaching the desired channel, press the knob (**ENTER**) to make a selection. During manual tuning, the audio system plays the current channel audio until a selection is made.

If there is no **ENTER** being pressed 5 seconds after stopped turning the **TUNE knob**, the manual tune will be canceled. The audio system then reverts the display back to its current channel.

When the category search is on, the manual tuning is blinded within the current category. Otherwise, it is done across the categories.

4. Channel Preset buttons (1~6)

There are 6 Preset buttons in each XM band you can use to store your favorite XM channels. Saving a channel as a preset gives you one-touch access to the channel you want. Remember that the 6 presets channels you stored are for the specific XM band mode you are in. There are a total of 3 XM bands. That means you can store up to 18 of your favorite channels in the preset memory.

NOTE:

Remember that if you store a channel as preset 3 in XM2 mode, you must first select XM2 mode before you can use that preset button.

Using Presets

To save a XM channel as a preset:

1. Take note of the band selection displayed on the LCD screen (XM1, XM2 or XM3)
2. Select a XM channel you want using either the **SEEK 'A' and 'V'** buttons or the **TUNE Knob**.
3. Choose the preset button (1 – 6) you want to store that channel.
4. Press and hold the Preset button for more than 2 seconds.
The system beeps to indicate that it has saved the new channel and displays the preset number on the LCD screen.

NOTE:

Saving a new channel erases the previous setting saved in that preset.

To call back a preset channel:

1. Select the band (XM1, XM2 or XM3) you want using the XM button.
2. Press the preset button you want. The system automatically jumps to the preset channel. The channel information and preset number are displayed on the LCD screen.

5. SCAN button**Channel scan function**

Press the **SCAN** button to scan all the channels in XM. The audio system plays the audio of a channel for 10 seconds before scanning for the next channel. When the category search is on, the channel scan is blinded within the current category. Otherwise, it is done across the categories.

If you want to keep listening to a particular channel and want to stop the scanning, press the **SCAN** button again.

This function is useful for providing you with a good overview of all the radio stations within range of your tuner.

Preset scan function

Press and hold the **SCAN** button for more than 2 seconds. Each preset channel will be automatically played for 10 seconds. If you want to keep listening to a particular preset channel and want to stop the scanning, press the **SCAN** button again.

6. INFO button

INFO button brings out the extra channel info of the current played channel. The audio system shows the following extra channel info in sequence when the **INFO** is pressed several times. First, it shows the song/program title. Then, it follows by the name of the artist/feature. The last one is the category name. Another press of **INFO** button brings the display back to the status of the current played channel.

Checking RADIO ID

Every SDAR box comes with one unique RADIO ID. You need ID to make subscription with XM service provider. Do **single seek** to channel 0 using **SEEK '▲' and '▼'** buttons. The audio system will then display the RADIO ID of the SDAR box.

Buttons not in use in tuner mode

The following buttons and functions are not used in XM mode.

- << button
- >> button
- **RPT** button
- **RDM** button
- **MARK** button

B466A02CM-AAT

USING REAR SEAT ENTERTAINMENT (RSE) SYSTEM CONTROLS (ONLY FOR MODELS D465S AND D466S)

The functions of the buttons and controls described below are only applicable when a Rear Seat Entertainment (RSE) system is connected to your model D465S or D466S audio system. You can still control the RSE system using the rear controls even when the front audio system is in a power-off state.

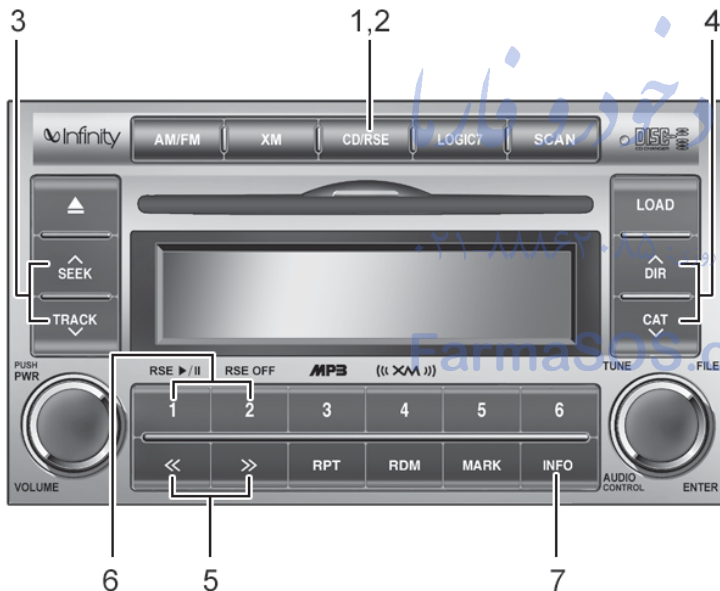

1. **RSE mode** selector button
2. **RSE Lock** button
3. **TRACK '▲'** and **'▼'** buttons
4. **DIR '▲'** and **'▼'** buttons*
5. **Rewind <<** and **Fast Forward >>** buttons
6. Operation buttons 1 & 2
7. RSE controls **INFO** button

You select the **RSE** mode by pressing the **CD/RSE** selector button until you see RSE mode displayed on the LCD screen.

D466S06CM

* Model shown is D466S. The buttons on your audio system may differ.
For details, see specific descriptions in the following section

B466B02CM-AAT

1. CD/RSE button (Switching to RSE mode)

Switch between **RSE** mode and **CD** mode by pressing the **CD/RSE** selector button until you see RSE mode displayed in the LCD screen. In RSE mode, you can control the **RSE** system from the controls on the front panel of the audio system.

NOTE:

- o If you are in **Radio mode**, press the **CD/RSE selector button once to switch to CD mode and then press the CD/RSE selector button again to switch to RSE mode.**
- o If the **CD changer does not contain any CDs**, you must press the **CD/RSE selector button a second time within 5 seconds of the first.** Otherwise, the audio system will automatically switch back to radio mode.

2. RSE Lock button

In any mode, press and hold the **CD/RSE** selector button for more than 2 seconds to lock or release the RSE from the **LOCK** mode. The LCD screen displays **LOCK** to indicate that the system is in **LOCK** mode. When the **LOCK** mode is engaged, only the **POWER ON/OFF** button and the **EJECT** button on the RSE system will be functional.

This function is useful if you do not want rear-seat passengers (e.g. children) to play with the controls or otherwise interrupt disc playback.

FarmaSOS.com

3. Track '^' and 'v' buttons

If the RSE system is playing a disc and the audio system is in RSE mode, press the **TRACK '^'** and **'v'** buttons to select and play the next or previous track on the disc being played in the RSE.

The LCD screen displays the track status as you press the buttons. You can press the button several times to select the track you want.

تلفن شبانه روزی: ۰۸۵-۸۸۶۲۰۸۸

4. Dir '^' and 'v' buttons*

If the RSE system is playing an MP3 disc* and the audio system is in RSE mode, press the **DIR '^'** or **'v'** buttons to switch to the next or previous directory on the CD. The LCD screen displays the name of the directory you have switched to and automatically begins playback of the first track in the directory.

* NOTE:

The DIR '^' or 'v' buttons can only be used when you are playing a CD which has organized its tracks in the form of directories. Normally, only MP3 CDs will contain a directory tree which you can navigate using these buttons.

5. << and >> buttons (Rewind and Fast Forward)

If the RSE system is playing a disc and the audio system is in RSE mode, press and hold the << or >> button to rewind or fast-forward playback of the current track. The LCD screen displays the elapsed time of the track you are rewinding or fast-forwarding. Release the << or >> button when you have reached the point you want. Playback resumes automatically at the selected point.

6. Operation buttons (1-2)

If a disc is loaded in the RSE system and the audio system is in RSE mode,

- o Press button **1** to play/pause the playback of the disc loaded in the RSE system DVD player
- o Press button **2** to power off the RSE system but continues to play the disc in the DVD player.

7. INFO button

If the RSE system is playing a disc and the audio system is in RSE mode, press **INFO** for detailed information on the assignment of operational / playback controls to the buttons on the audio system's front panel.

Buttons not in use in RSE mode

The following buttons and functions are not used in RSE mode.

- **RPT** button
- **RDM** button
- **MARK** button
- **SCAN** button
- Number buttons **3, 4, 5, 6**

USING EXTERNAL CONTROLS

The Dimmer control

The Dimmer control setting determines the brightness of the entire vehicle's displays.

Turn the scroll wheel up or down to increase or decrease the brightness of the vehicle's instrument panels, backlit displays and the audio system's LCD screen and backlit controls.

Steering wheel audio controls

Steering wheel-mounted audio controls allow you to make adjustments to the most frequently used audio controls without taking your eyes off the road.

Control	Function
MODE button	<p>Press this button to switch between the FM1/FM2/AM/XM1/XM2/XM3/CD/RSE modes. Check the LCD screen display to confirm if you have selected the mode you want.</p> <p>NOTE: The modes available depend on the model of your audio system and also on whether any auxiliary/RSE device is connected to your audio system.</p>
-VOL+ rocker switch	Press and hold to decrease (-) or increase (+) the volume.
-SEEK+ rocker switch	<p>In Tuner mode: <u>Press and release</u> + and – to switch to the next or previous preset station. For example, to switch from preset station 1 to preset station 3, press + twice.</p> <p><u>Press and hold</u> (about 1 second) + and – to scan up and down the frequency range for the next available radio station and automatically lock on to that frequency.</p> <p>In CD mode: During CD playback, <u>press and release</u> – and + to select and play the previous or next track on the disc. The LCD screen displays the track number as you press the buttons. You can press the button several times to select the track you want.</p>

<p>-SEEK+ rocker switch</p>	<p>Press and hold (about 1 second) + and – to:</p> <ul style="list-style-type: none"> o Fast-Forward or Rewind the current track (Model D445S) o Select and play the next or previous disc in the CD changer (Models D465S and D466S) <p>In XM mode: <u>Press and release + and –</u> to switch to the next or previous preset channel. For example, to switch from preset 1 to preset 3, press + twice.</p> <p><u>Press and hold (about 1 second) – and +</u> to search previous or next XM channel to play. The channel is selected upon the release of button.</p> <p>In RSE mode (only for models D465S and D466S): During DVD/VCD playback, <u>press and release – and +</u> to select and play the previous or next title/chapter/track on the disc (see note below).</p> <p><u>Press and hold (about 1 second) + and –</u> to Fast-Forward or Rewind the current title/chapter/track being played back in the RSE system DVD player (see note below).</p> <p>NOTE: Whether you are able to select, play, fast-forward or rewind the previous or next title/chapter/track on the disc depends on the contents encoded on your disc.</p>
-----------------------------	--

MUTE button	<p>Press to mute all sound from your audio system. Press again to unmute the sound.</p> <p>NOTE: Playback progress is not affected when you mute the sound.</p>
--------------------	---

امداد خودرو فارما

تلفن شبانه روزی: ۰۲۱-۸۸۸۶۲۰۸۵

FarmaSOS.com

178 REAR SEAT ENTERTAINMENT (RSE) SYSTEM (IF INSTALLED)

B470A03CM-AAT

IMPORTANT SAFETY INFORMATION

It is always important to operate your vehicle in a safe manner and to avoid distraction while driving. This manual provides information that will help you safely operate your Rear Seat Entertainment System (RSE). Please read it completely before using the system.

This device complies with part 15 of the FCC rules. Operation is subject to the following two conditions: (1) This device may not cause harmful interference, and (2) this device must accept any interference received, including interference that may cause undesired operation.

WELCOME

The Rear Seat Entertainment System is a compact, built-in, easy-to-use entertainment system designed to provide family fun while you are on the road. Enjoy great quality sound from the vehicle speakers, or private, quiet listening with the wireless headphones.

The overhead LCD display unit is mounted to the ceiling in the rear passenger area of the vehicle, allowing rear-seat passengers to play DVD movies, video CDs or music CDs. Users may also plug a game platform or VHS player into an auxiliary input to show the programs through the RSE LCD display. The RSE can also access the vehicle's front radio programs.

FarmaSOS.com

SYSTEM OVERVIEW**Connections / Setup**

Your Rear Seat Entertainment system will play DVD movies, video CDs, music CDs or music MP3 discs, and is designed to make your time on the road more enjoyable. Please follow these instructions carefully to get the most out of your RSE.

**CAUTION:**

- o Avoid having food or drinks near, in or on the RSE, the wireless headphones or the remote controller.
- o Direct sunlight may interfere with the headphone's RSE LCD display's operation and performance.
- o Normal RSE operation cannot be guaranteed with unofficially duplicated discs.
- o Use of the rear seat entertainment system without the engine running will rapidly reduce vehicle battery power.
- o The RSE system is programmed to the assigned DVD format for US region (#1). Please note that your RSE will not read or play DVDs from a different region.

Note:

The RSE requires a few seconds of set warm-up time after the ignition switch is turned ON or to Accessory mode.

Your RSE system is already set up and ready for use, and can be turned on by pushing the **POWER/VOLUME** knob on the RSE control panel or the **ON/OFF** button on the remote controller. The vehicle's ignition must be turned ON or in Accessory power mode. The RSE system can also be turned OFF by the Audio Unit.

تلفن شبانه روزی: ۰۲۱-۸۸۶۲۰۸۵

FarmaSOS.com

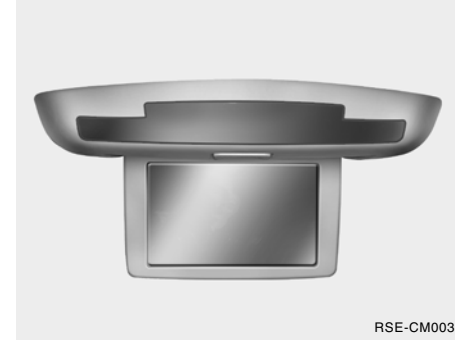

RSE-CM003

Components

Your RSE consists of several components: The LCD display, where video is viewed, is attached to the ceiling in the rear of the vehicle.



RSE-CM02A

The **RSE Control Panel**, which includes a digital display and the RSE control buttons, is located in the armrest console between the front seats.

The **DVD Player**, where a CD, DVD or other disc is inserted, is located below the RSE control panel in the first row seat armrest console.



HEADPHONE02A

The **Wireless headphones**, allow you to hear the audio from the RSE without disturbing other passengers. Two sets, with batteries, are provided.

FarmaSOS.com



RSE-CM002A

The **Remote controller**, allows you to control RSE functions. Batteries are included.

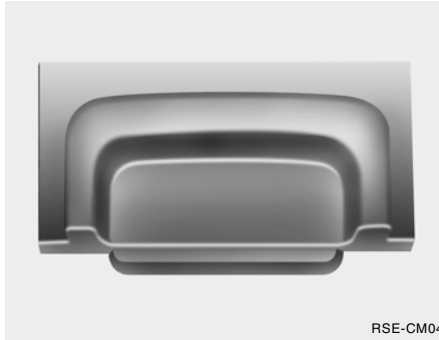

Opening and Closing the LCD Display

To view the LCD display, locate the latch on the bottom-center of the ceiling-mounted unit and pull it forward. This will release the LCD display from its locked, stow-away position.

Adjusting the LCD Display

Press the **DISP** button on the RSE control panel to adjust the LCD display. To adjust the brightness, select Brightness, then, press the **< REW** (dimmer) or **FWD >** (brighter) buttons. The next time the RSE is turned on, the LCD display will return to the brightness level it was adjusted to when last used. Brightness can be adjusted regardless of whether the RSE is playing an audio or video source. While the RSE is playing a video signal, press **DISP** and then press the **▲ NEXT** or **▼ PREV** buttons to cycle through other LCD display adjustments including **SCREEN SIZE**, **CONTRAST**, **CHROMA** and **HUE**. With any of these settings displayed, press the **< REW** or **FF >** buttons to adjust the settings.

To close the LCD display, pull the bottom edge towards you and push it up until it clicks and locks into the stow-away position.

Cleaning the LCD Display

If the LCD display becomes dusty or dirty, clean it by wiping gently with a soft, dry, clean cloth. Do not use chemical cleanser to clean the screen.

Loading a Disc

To load a disc in the player, insert it part way into the loading slot. The player will automatically grip the disc and pull it the rest of the way in.

Disc Protection

The player has an Auto-Reload Disc Protection feature to protect discs from accidental damage. If a disc is not removed within 12 seconds after being ejected, it will be pulled back into the player. The disc will not begin playing.

Audio via Vehicle Speakers

To hear the audio from the RSE through the vehicle's speakers, the RSE must be selected by the radio **CD/AUX** button in the front of the vehicle. Regardless of whether RSE audio is selected for the vehicle speakers or not, when the RSE audio is playing it can be heard in the headphones.

Volume Control

You can adjust the volume of the audio heard in the vehicle speakers from the RSE control panel or the remote controller. From the RSE control panel, rotate the **POWER/VOLUME** knob. From the remote controller, press "**VOL +**" to increase the volume and "**VOL -**" to decrease the volume.

Adjusting the volume in this way will not affect the wireless headphone volume. To adjust the headphones, turn the **VOL** control wheel on the headphones.



RSE-CM03A

Headphones

Your RSE comes with two (2) sets of wireless headphones and four (4) AAA 1.5V batteries. To install the batteries, press the button below the battery compartment on the right side of each set of headphones and insert each of the batteries, observing the correct polarity as shown in the headphone battery compartment. Each set of headphones requires two batteries.

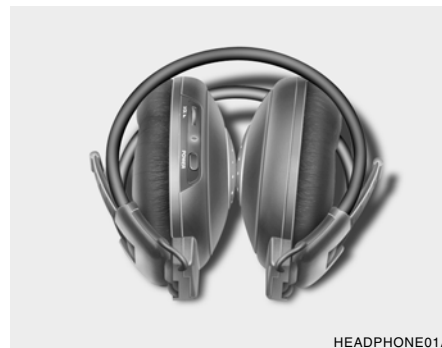

HEADPHONE01A

To turn the headphones on, push the **POWER** button on the left side of the headphones. Push the button again to turn the headphones off. Adjust the volume by turning the Volume control wheel. The headphones can be adjusted for size, and can be stored more compactly by folding them.

NOTE:

- o Conserve the energy of your batteries by turning the headphones off when they are not in use. Headphone batteries will typically work for 48 hours, depending on the volume setting.
- o The headphone has an automatic shutoff feature to extend battery life. The headphones will automatically turn off after 20 seconds if they don't detect a signal from the RSE.
- o In case of poor headphone reception performance, please check the battery condition.
The headphones perform best when used within 2 - 8 feet (0.6-2 m) of the RSE LCD display. Getting too close or too far away will cause poor reception.
- o Audio from the vehicle's CD/radio cannot be heard through the headphones. (Applies to Santa Fe model)

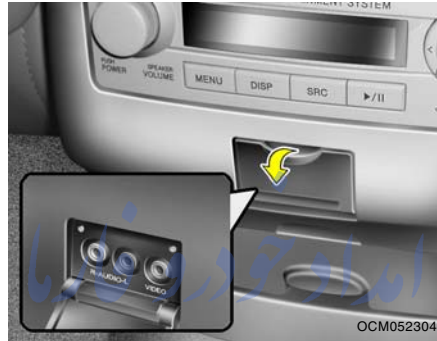
**Connecting Other Devices to the RSE**

Electronic devices such as video game systems or VHS players can be played through the RSE. These external devices can be connected to the unit via RCA plugs available in the vehicle. Press the **SOURCE** button on the remote controller, or the **SRC** button on the RSE control panel, to select and switch to the external device inputs.

Once the RSE has switched to the external device audio and/or video sources, you can operate the device using its controls. The RSE controls will not control external devices. For example, to control or play a video game after the RSE has recognized it as the source, you must use the game controls, not the RSE controls.

**CAUTION:**

Connect only appropriate input sources to the RSE jacks. Be sure to connect audio outputs from the external device to audio inputs in your vehicle, and video outputs to video inputs. Connecting an incorrect input may cause damage to the RSE and/or the external electronic device.

NOTE:

The RSE automatically detects when an external audio or video device has been connected to the RSE jacks, and will allow you to select this external source.

RSE Lock Function

Front seat passengers can use the RSE Lock function to prevent rear seat passengers from operating the RSE. To lock the RSE, press and hold the **CD/AUX** button on the vehicle radio for more than 2 seconds.

"Lock" will appear on the RSE LCD display, as well as on the RSE control panel. None of the RSE control panel or remote controller buttons will function while the RSE is locked. Rear seat passengers will still be able to eject or insert a disc in the player, as well as power on/off the system. Press and hold the **CD/AUX** button again to turn off the RSE lock.



Battery Discharge Warning

To prevent inadvertent vehicle battery discharge when the ignition switch is turned to the ignition **ON** or ACC (Accessory) position, a battery drain warning message will flash on the RSE LCD display.

B470B01CM-AAT

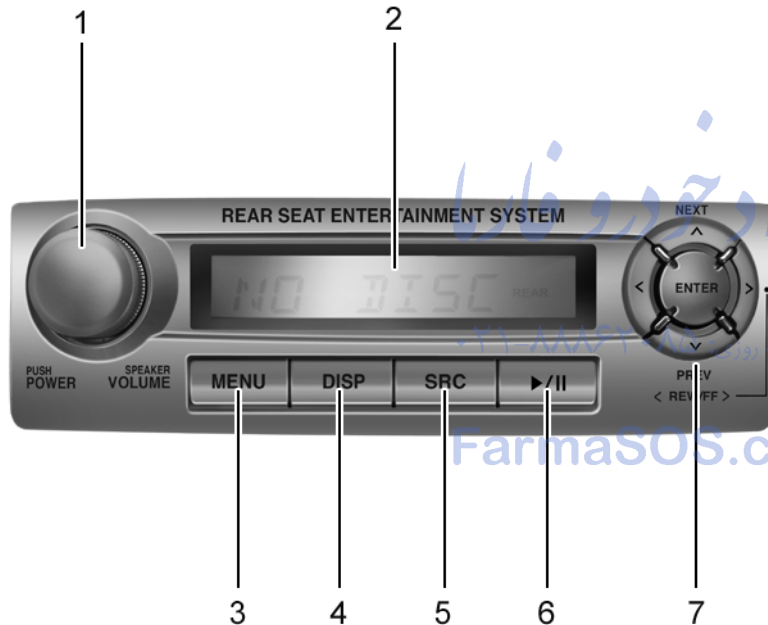
RSE CONTROL PANEL OPERATION

1. ON/OFF and Speaker Volume

2. RSE Display

3. MENU Button

4. DISP (Display) Button

5. SRC (Source) Button

6. Play/Pause Button

7. ^ NEXT / v PREV (Next/Previous) and < REW/FF > (Rewind/Fast Forward) and ENTER Buttons

RSE-CM001A

Most RSE functions are available through the RSE control panel.

B470C01CM-AAT

1. ON/OFF and Speaker Volume

Press the **POWER/VOLUME** knob to turn the RSE On or Off.

Rotate the knob to adjust the speaker volume. Note that changing the volume by using the **POWER/VOLUME** knob affects only the vehicle speakers. The wireless headset volume is not affected. See the "Headphones" section of this manual for more information.

2. RSE Display

This RSE control panel display indicates the current selected source, mode of operation in the current disc, and other information. It will display **FRONT** to indicate that the selected source is the front vehicle radio and **REAR** to indicate that the RSE player is the current source. The display will indicate **DISC IN** when a disc is in loaded the RSE player.

3. MENU Button

DVD can be controlled, and any special programming or features accessed, by using the DVD menu. To access the menu while playing a DVD, press the **MENU** button. Press the button a second time to exit the menu and return to the DVD program at the point it was being viewed.

While viewing the menu, press the **▲ NEXT** button to move the cursor up and the **▼ PREV** button to move the cursor down the menu. Press the **< FWD** button to move the cursor to the right, and the **< REW** button to move the cursor to the left.

For more details, see the "DVD – Menu" section of this manual.

4. DISP (Display) Button

Pressing **DISP** enables you to adjust the parameters of the LCD display. For more information on how to make these adjustments, see the "Adjusting the LCD Display" section of this manual.

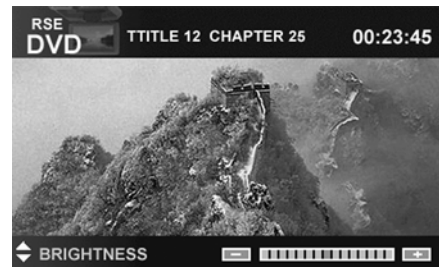

FarmaSOS.com

5. SRC(Source) Button

After inserting a disc in the RSE, it will automatically use that as the source and begin playing that disc. The RSE control panel will display "DISC IN" when there is disc loaded in the player.

Press the **SRC** button to select from the various audio and video sources available. All available sources will be displayed on the Source Selection screen. Use the arrow buttons (**▲NEXT/▼PREV** and **REW/FF**) to navigate to the desired source, and then press **ENTER** to select the highlighted source.

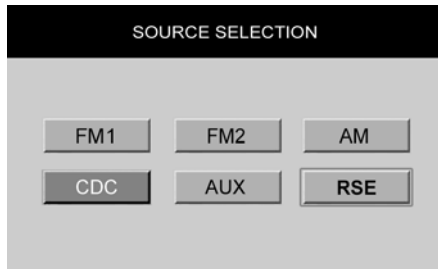

While the RSE is selected as the source by the front vehicle radio, the front vehicle radio will be able to control some RSE functions (e.g. Fast Forward / Reverse, Previous / Next Track, etc.). See your vehicle radio user manual for more information.

NOTE:

When switching from the vehicle radio to the RSE, there is a slight delay while the RSE initializes. The RSE control panel will display "READ" while the disc initializes, then begin playing the disc.

The RSE control panel will display "REAR" if the current source is the RSE player, "FRONT" if the current source is the front vehicle radio and "AUX" if the current source is an auxiliary input.

6. Play/Pause Button

You do not need to press the **PLAY/PAUSE** button after loading a disc to begin playing the disc. The player will start playing automatically.

While a disc is playing, press to pause. While paused, the elapsed time of the current disc, track or file will blink on the LCD display, and "PAUSE" will be displayed on the RSE control panel. Press the button again to resume play.

NOTE:

The RSE will enter standby mode when the vehicle ignition is turned off. When the vehicle is turned back on within 30 seconds, the RSE will turn on and the DVD/VCD will automatically begin playing again at the point where it paused. If the vehicle is turned off for longer than 30 seconds, the RSE system will not turn on automatically when the vehicle is restarted.

7. ▲NEXT/▼PREV (Next/Previous) and < REW/FF > (Rewind/Fast Forward) and ENTER Buttons

The **▲NEXT** or **▼PREV** and **REW/FF** buttons provide a variety of functions, depending on the media currently being played in the RSE or the source selected. For some of the functions, you will use these buttons to navigate to the desired location or option, then press the **ENTER** button in the center to confirm your selection.

For specific information about using these buttons, see the appropriate section for the various media types in this manual.

B470D01CM-AAT

DVD/VCD PLAYER OPERATION

Disc/Format Compatibility

Your RSE player accepts and plays all DVDs in 4:3 (normal) and 16:9 (widescreen) video formats. With DVDs that offer multiple formats, the default format is 16:9 and will stay that way unless changed by the user. See "Adjusting the LCD display" to learn how to adjust the format.

The DVD player has the capability to play DVD-video, DVD-R, DVD-RW, CD-DA, CD-R, CD-RW, VCD.

The DVD player was factory programmed with a region code for the assigned market or country. If a DVD is inserted for a region code that doesn't match with the player, the RSE player will eject the disc. An error message will be shown on the overhead LCD display and the RSE control panel display.

NOTE:

Because there is no universal standard for DVD/VCD programming, your disc may behave differently. Some DVDs may present warning messages about unauthorized duplication, some will go directly to a menu, some may have different on-disc menu and start playing the movie immediately, and some may be unreadable or damaged and will be ejected.

NOTE:

While the player will accept DVD ROM and CD ROM discs, the RSE cannot play discs in these formats and will eject them.

The player is only capable of reading the bottom side of a disc. When inserting a single-sided disc, the label side should be up. When inserting a two-sided disc, the desired play side should be down.

Press **DISP** on the RSE control panel or the remote controller, then press the **▲ NEXT** or **▼ PREV** buttons to cycle through LCD display adjustments (SCREEN SIZE, BRIGHTNESS, CONTRAST, CHROMA, HUE). To adjust the SCREEN SIZE, use the **< REW** or **FF >** buttons to select the preferred size.

1. Menu MENU

DVDs can be controlled, and any special programming or features accessed, by using the menu. To access the menu while playing a DVD, press the **MENU** button. Press the button a second time to exit the menu and return to the DVD program at the point it was being viewed. The menu is not available during disc initialization, the beginning credits or any copyright and FBI warnings.

While viewing the menu, press the **▲ NEXT** button to move the cursor up and the **▼ PREV** button to move the cursor down the menu. Press the **> FWD** button to move the cursor to the right, and the **< REW** button to move the cursor to the left.

NOTE:

You must repeatedly push any button to move through several items. Pressing and holding a button will not advance the cursor beyond the first item.

Press **ENTER** or **Play/Pause** to select the desired menu choice.

Playing a DVD/VCD

You can control your DVD or VCD by using the buttons on the RSE control panel or by using the remote controller. Instructions for the controls listed below are the same whether using the RSE control panel or the remote controller. However, there are some additional functions that are only available from the remote controller. These buttons and their functions are discussed in the "Remote Controller" section of this manual.

1. Play/Pause Button

You do not need to press the **PLAY/PAUSE** button after loading a disc to begin playing the disc. The player will start playing automatically.

While a disc is playing, press **PLAY/PAUSE** to pause. While paused, the elapsed time of the current disc, track or file will blink on the LCD display, and "PAUSE" will be displayed on the RSE control panel. Press the button again to resume play.

NOTE:

The RSE will enter standby mode when the vehicle ignition is turned off. When the vehicle is turned back on within 30 seconds, the RSE will turn on and the CD will automatically begin playing again at the point where it paused. If the vehicle is turned off for longer than 30 seconds, the RSE system will not turn on automatically when the vehicle is restarted.

2. Fast Forward/Reverse

Press and hold the **FF >** or **< REW** button and the player will fast forward or reverse at 32 times the normal speed. Release the **FWD** or **< REW** button to return to normal speed play.

FarmaSOS.com

3. Previous/Next Chapter

While a DVD/VCD is playing, press the **^ NEXT** button to skip to the next chapter. Press the **v PREV** button to jump to the beginning of the current chapter. Press **v PREV** again to go move through earlier chapters. Press the button repeatedly to move quickly through chapters.

NOTE:

Some VCDs do not have track information. If the VCD has no chapter information, pressing either of these buttons will restart the VCD.

While pressing the **^ NEXT** or **v PREV** buttons, the Status Display, including the current medium (DVD or VCD), chapter and title information is displayed. It will automatically disappear after five seconds.

NOTE:

Some DVDs do not permit chapter navigation.

Instead of using the **V PREV/ ^ NEXT** buttons, you can also enter the chapter number using the numbers on the remote controller. While a DVD/VCD is playing, press the number button(s) that correspond to the desired chapter and press **ENTER**.

4. Stop a Disc

The disc will automatically stop when any other source (e.g. the vehicle radio or an external game) is selected. When you switch back to the DVD, it will begin playing at the point where it stopped.

While the player is running, press the RSE control panel **POWER/VOLUME** knob, or the **ON/OFF** button on the remote controller, to stop a disc and turn off the RSE system and the DVD player. When the RSE is turned on again, the disc will begin playing at the point where it stopped.

5. Eject a Disc

To eject a disc press the  button. A disc can be ejected even when the unit or the vehicle is turned off.

NOTE:

The player has an Auto-Reload Disc Protection feature to protect discs from accidental damage. If a disc is not removed within 12 seconds after being ejected, it will be pulled back into the player.

تلفن شبانه روزی: ۰۲۱-۸۸۶۲۰۸۵

FarmaSOS.com

B470E01CM-AAT

CD PLAYER OPERATION

The RSE will play audio CDs in both standard (12 cm) and mini-disc (8 cm) format.

NOTE:

While the player will accept DVD ROM or CD ROM disc, the RSE cannot play disc in this format will eject the disc.

1. Volume Control

You can adjust the volume of the audio heard in the vehicle speakers from the RSE control panel or the remote controller. From the RSE control panel, rotate the **POWER/VOLUME** knob. From the remote controller, press "**VOL +**" to increase and "**VOL -**" to decrease the volume.

Adjusting the volume in this way will not adjust the wireless headphone volume. To adjust the headphones, roll the **VOL** control wheel.

2. Play/Pause



When a CD is inserted, the RSE will automatically begin playing the first track. Press the **PLAY/PAUSE** button to pause the CD. Press the button again to resume play. While paused, the elapsed time in the Status Display at the top of the LCD display will blink. The RSE control will display "PAUSE."

When the player reaches the end of the disc, the player will automatically return to the first track and continue playing.

3. Fast Forward / Reverse

Press and hold the **FF >** or **< REW** button and the player will fast forward or reverse at 10 times the normal speed. Release the button to return to normal speed play.

The audio is muted while the player fast forwards or fast reverses.

4. Previous/Next Track

While a CD is playing, press the **▼ PREV** button to jump to the beginning of the current track. If less than 10 seconds has elapsed on the current track, pressing **PREV** will go to the previous track. Press the button repeatedly to continue moving through previous tracks.

Press the **▲ NEXT** button to jump to the beginning of the next track. Press the button repeatedly to continue moving through the following tracks.

Instead of using the **▲ NEXT** or **▼ PREV** buttons, you can also enter the track number using the numbers on the remote controller. While a CD is playing, press the number button(s) that correspond to the desired track and press **ENTER**.

The current track number is shown in the Status Display at the top of the LCD display.

5. Stop

The CD will automatically stop when any other source (e.g. the vehicle radio or an external game) is selected. When you switch back to the CD, it will begin playing at the point where it stopped.

While a CD is playing, you can stop the CD by pressing the **ON/OFF** button on the remote controller or the **POWER/VOLUME** knob on the RSE control panel. When the RSE is turned on again, it will automatically begin playing the CD at the point where it was stopped.

Turning the vehicle off, or selecting a different RSE Source, will also stop playing the CD.

6. Eject

Press the **EJECT** button  to eject the CD. Discs can be ejected even when the unit is not turned on.

B470F01CM-AAT

USING THE MP3 PLAYER

Most RSE functions work the same for audio CDs and MP3 discs. The major difference is that audio CDs are organized by "tracks," while MP3 discs are organized using folders and files. Therefore, the navigation functions are somewhat different for MP3 discs.

NOTE:

While the player will accept DVD ROM or CD ROM disc, the RSE cannot play disc in this format will eject the disc.

1. Pause/Play

When an MP3 disc is inserted, the RSE will automatically begin playing the first file in the first folder. Press the **PLAY/PAUSE** button to pause the CD. Press the button again to resume play. While paused, the elapsed time in the Status Display at the top of the LCD display will blink. The RSE control panel will display "PAUSE." At the end of the disc, the player will automatically return to the first track and continue playing.

2. Fast Forward/Reverse

Press and hold the **FF >** or **< REW** button and the player will fast forward or reverse at 10 times the normal speed. Release the button to return to normal speed play.

The audio is muted while the player fast forwards or fast reverses.

Song List: Navigating Folders and Files

MP3 discs are organized by named or numbered folders, with each folder containing a collection of named or numbered music files. You can quickly navigate through the folders and files using the Song List function.

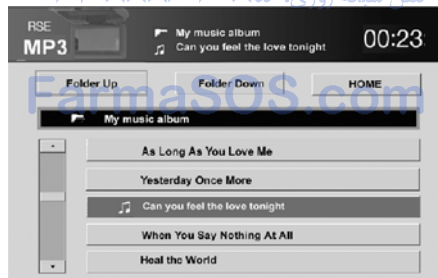

Press the **MENU** button on the RSE control panel or remote controller to display the song list. The song currently playing will be highlighted, and the music note icon appears to its left.

To navigate through the folders, press the **< REW** or **FF >** button to highlight the **FOLDER UP**, **FOLDER DOWN**, or **HOME** buttons on the monitor, the press **ENTER** to move up or down the folders. Press **ENTER** repeatedly to move through all the folders.

When you reach the desired folder, press the **▲ NEXT** or **▼ PREV** buttons to scroll through the list of files in that folder and press **ENTER** to select the desired file. The player will switch to the selected folder and begin playing the desired file.

Selecting the **HOME** button on the display and pressing **ENTER** will bring the Song List to the screen with the song currently playing.

Press **MENU** again to leave the Song List. The Song List will automatically disappear after five seconds if no buttons are pressed. During Song list mode, pressing the **A.LANG** or **S.TITLE** buttons will directly select the folder up or folder down function.

While in normal play mode, press the **FOLD-(A.LANG)** button at any time to jump to the first file in the next folder, press **FOLD+(S.TITLE)** to jump to the first file in the previous folder.

3. Previous/Next File

While a disc is playing, press the **∨ PREV** button to jump to the beginning of the current file. If less than 10 seconds has elapsed on the current file, pressing **PREV** will go to the previous file. Press it again to select previous files. Press the button repeatedly to continue moving through previous files.

Press the **∧ NEXT** button to jump to the beginning of the next file. Press the button repeatedly to continue moving through the following files.

Instead of using the **∧ NEXT/ ∨ PREV** buttons, you can also enter the file number using the numbers on the remote controller. While a disc is playing, press the number button(s) that correspond to the desired file and press **ENTER**.

The current folder name/number and file name/number are shown in the Status Display at the top of the LCD display.

4. Stop

The disc will automatically stop when any other source (e.g. the vehicle radio or an external game) is selected. When you switch back to the disc, it will begin playing at the point where it stopped.

While a disc is playing, you can stop the disc by pressing the **ON/OFF** button on the remote controller or the **POWER/VOLUME** knob on the RSE control panel. When the RSE is turned on again, it will automatically begin playing the disc at the point where it was stopped.

Turning the vehicle off, or selecting a different RSE Source, will also stop playing the disc. When the vehicle is turned on again, or the disc is again selected as the source, the disc will begin playing at the point where it was stopped. The player will automatically resume play at the point where it was stopped unless the disc is ejected.

5. Eject

Press the **EJECT**  button to eject the disc. Disc can be ejected even when the unit is not turned on.

B470G02CM-AAT

USING THE SATELLITE RADIO



(If only satellite radio installed.)

All the preset channels have been listed on this SDAR operation interface. You can use the **FF>** or **<REW** button to select the preset station. Press the **ENTER** button to will complete this selection. After the desired station has been selected, the information of this station will list in the information display area.

Also you can select the **CATEGORY** or **CHANNEL** function by using **FF>** and **<REW** buttons. After the focus locates at the **CATEGORY** or **CHANNEL** icon, pressing the **▲ NEXT** or **▼ PREV** button will activate the category up or down, channel up or down function. When the focus on the **CATEGORY**, if you press the **ENTER** button and move the focus on the **CHANNEL** icon, you can select the channel up or down function in the current category by pressing the **▲ NEXT** or **▼ PREV** buttons.

Move the focus on the **SCAN** icon, you can activate the scan function by pressing the **ENTER** button. If meantime, the **CATEGORY** icon been highlighted, above operation will activate the scan function in the current category.

B470H01CM-AAT

LISTENING TO THE VEHICLE RADIO

Press the **SRC** button to select from the various audio and video sources available. All available sources will be displayed on the Mode Selection screen. Use the arrow buttons (**▲ NEXT/▼ PREV** and **REW/FF**) to navigate to the desired source, and then press **ENTER** to select the highlighted source.

To control the vehicle radio from the RSE control panel or remote controller, press the **SOURCE** button on the remote controller or the **SRC** button on the RSE control panel, then all available sources will be displayed on the Source Selection screen. Use the arrow buttons (**▲ NEXT/▼ PREV** and **REW/FF**) to navigate to the desired source, and then press **ENTER** to select the highlighted source.

The RSE LCD display and the RSE control panel will indicate the selected source.

Tuning a Station

While the vehicle radio is the current source, press the **▲ NEXT** or **▼ PREV** button on the RSE control panel or remote controller once to search up or down for the next available station. When the tuner finds a station it will stop at the station and start to play.

Press the **▲ NEXT** or **▼ PREV** button to seek up or down through all radio stations. When the radio finds a station, it will stop and play that station.

Press the **FF>** or **<REW** button to manually tune up or down one channel. Press and hold the **FF>** or **<REW** button to continue tuning up or down.

Pressing a number on the remote controller keypad will tune to the corresponding preset station. For example, if 89.7 has been stored as preset 1 (CH1), then pressing the "1" button on the keypad will tune to that station.

AM, FM1 and FM2 Selection

When you press the **SOURCE** button, the Source Selection UI will come out, along with the current available mode. You can select the Radio mode by the remote controller. After pressing the **ENTER** button, both RSE and front Radio will play your selection station at the same time.

All of the RSE control panel and remote controller navigation functions can be used to control the front radio when the vehicle front radio is also playing the same radio mode.

B470I01CM-AAT

VIEWING FRONT CD, MP3

The RSE can be used to control discs that are loaded and playing in the vehicle radio. To control these discs, you must first select the vehicle radio as the source. Press the **SOURCE** button on the remote controller, or the **SRC** button on the RSE control panel, to display the available sources on the LCD display. Use the arrow buttons (**▲ NEXT / ▼ PREV** and **REW/FF**) to navigate to the desired source, then press **ENTER** to select the highlighted source.

CD/CD-MP3 Control

While the vehicle radio is playing a CD or MP3 audio disc, all of the RSE control panel and remote controller navigation functions can be used to control the vehicle radio. This includes:

- o Pause/Play
- o Fast Forward/Reverse
- o Previous/Next Track (CD) and Previous/Next File (MP3)

See these sections of the Users Manual for information on using these functions.

All of the RSE control panel and remote controller navigation functions can be used to control the front radio when the vehicle front radio is also playing the CD or CD-MP3 mode.

B470J02CM-AAT

AUX AUDIO AND VIDEO INPUT CONTROLS

External media sources, such as VCRs and video games, can be connected to the RSE. This allows you to display the video output on the RSE LCD display, and listen to the audio through the wireless headsets and the vehicle speakers.

For information and warnings about connecting external sources to the RSE, see "Connecting Other Devices to the RSE."

To switch to an external auxiliary device, press **SOURCE** on the remote controller or **SRC** on the RSE control panel until "AUX" appears on the LCD display and the RSE control panel display.

NOTE:

When using a portable audio device connected to the power outlet, noise may occur during playback. If this happens, use the power source of the portable audio device.

B475A02CM-AAT

USING THE REMOTE CONTROLLER

1. ON/OFF
2. Mute
3. Number Buttons
4. Source
5. DISP (Display) Button
6. A.LANG-Alternate Language Folder
7. S.Title – Subtitles, Folders +
8. Menu
9. Title/PBC
10. Return
11. Speaker Volume "VOL +" and "VOL –"

In addition to buttons and functions available from the RSE control panel, the remote controller has several additional buttons and operation control functions. The remote controller is an infrared device and should be pointed at the RSE LCD display for best results.

RSE-CM004A

1. ON/OFF



Press the RSE control panel POWER button or the **ON/OFF** button on the remote controller to turn the RSE On or Off. If a disc is loaded and playing when the RSE is turned off, when the RSE is turned back on the disc will automatically resume playback at the point where it was stopped.

2. Mute



Press the **MUTE** button to mute the audio in the vehicle speakers. The **MUTE** button has no effect on the wireless headphones. While muted, the RSE control panel, vehicle radio and RSE LCD display will display "MUTE." Press the button again, or adjust the volume at RSE control panel or vehicle radio, to un-mute the audio.

3. Number Buttons



The number buttons (**0 through 9**) can be used to directly enter information such as chapters in a DVD, track or file numbers for audio CDs, and radio station presets.

To select a DVD or VCD chapter, while a DVD/VCD is playing, press the number button(s) that correspond to the desired chapter and press **ENTER**.

To select a CD track, while a CD is playing press the number button(s) that correspond to the track and press **ENTER**.

To select an MP3 file, while an MP3 disc is playing, press the number button(s) that correspond to the desired file and press **ENTER**.

To select a radio station preset, while the desired band (AM, FM1 or FM2) is selected, press the numbered button that corresponds to the preset on the vehicle radio. There is no need to press **ENTER**.

4. Source



Press the **SOURCE** button to select from the various audio and video sources available. Use the arrow buttons (**▲ NEXT / ▼ PREV** and **REW/FF**) to navigate to the desired source, then press **ENTER** to select the highlighted source.

The RSE control panel will display "REAR" if the current source is the RSE player, and will display "FRONT" if the current source is the vehicle radio.

5. DISP (Display) Button



Pressing **DISP** enables you to adjust the parameters of the LCD display. For more information on how to make these adjustments, see the "Adjusting the LCD Display" section of this manual.

6. A.LANG-Alternate Language Folder



Where alternate languages are available on a DVD, pressing the **A.LANG** button will allow you to select your preferred language. Press the button repeatedly to cycle through the available languages. When the desired language is displayed, press ENTER.

Pressing the **A.LANG** (or **FOLD-**) button during MP3 mode will immediately bring the player to the first file of the previous folder.

Pressing the **A.LANG** (or **FOLD-**) button during CD or VCD play will do nothing.

7. S.Title – Subtitles, Folders +



The **S.TITLE** button allows you to display or remove language subtitles while playing DVDs. If no language subtitles are available, the display will show an invalid icon. Press the **S.TITLE** button repeatedly to cycle through all of the available languages.

Pressing the **S.TITLE** (or **FOLD+**) button during MP3 mode will immediately bring the player to the first file of the NEXT folder. Pressing the **S.TITLE** (or **FOLD+**) button during CD or VCD play will do nothing.

8. Menu



Pressing the **MENU** button during DVD play will present the DVD menu.

Pressing the **MENU** button during MP3 disc play will display the Song List on the LCD display.

Pressing the **MENU** button during CD or VCD play has no effect.

Press the button again to return to the program. After five seconds with no button press, the menu will automatically close and the program will begin playing.

9. Title/PBC



While viewing a DVD, press the **TITLE** button on the remote controller to jump to the top menu. Press the **<REW / FF >** or **VPREV/ANEXT** buttons to highlight the desired selection, then press **ENTER** to make your selection.

Press **TITLE** again to return to the DVD. While viewing a PBC function included VCD, pressing the **TITLE/PBC** button will switch the **PBC** function on and off.

10. Return



While view any operation, pressing the **RETURN** button will return to previous operation status.

11. Speaker Volume "VOL +" and "VOL –"



If the audio from the RSE is being played through the vehicle speakers, you can adjust the volume of the speakers with the "**VOL +**" and "**VOL –**" buttons. Adjusting the volume in this way will not adjust the wireless headphone volume. To adjust the headphones, roll the **VOL** control wheel.

Batteries

The remote controller requires a CR2025 battery (included).

B475B01CM-AAT

Troubleshooting

Problem	Possible causes / solutions
The disc is automatically pulled back into the player.	The Auto-Reload Disc Protection feature pulls discs back into the player after 12 seconds to protect them from accidental damage. Press the Eject button to release the disc from the player.
The disc becomes stuck or blocked.	Press the Eject button to release the disc. The player will attempt to eject the disc up to three times before performing the Auto-Reload function. Once the Auto-Reload function is complete, press the Eject button again to try to release the disc from the player.
There is no audio in the headphones.	Verify that the headphone is equipped with batteries, and that the batteries are in good condition. Insert or replace 2 AAA batteries to resume headphone function.
The RSE does not work.	Press the PLAY button. If the display does not show "NO DISC," then there is no power. Check the power connection. Check the fuse. Turn the vehicle ignition off and back on to reset the RSE. If the RSE still does not work, contact your Hyundai Dealer.
The remote controller does not work.	Make sure you are pointing the remote controller at the face of the RSE at a 45° angle. Change the battery. [Device requires one (1) CR2025 battery.] Use the control buttons on the RSE display panel. If the remote controller still does not work, contact your Hyundai Dealer.

DRIVING YOUR HYUNDAI

Engine Exhaust Can Be Dangerous!	2-2
Before Starting the Engine	2-4
Key Positions	2-5
Starting	2-6
Manual Transaxle	2-7
Automatic Transaxle	2-10
Anti-Lock Brake System (ABS)	2-15
Electronic Stability Control (ESC)	2-16
Full-Time AWD Operation	2-17
AWD Lock System	2-20
Good Braking Practices	2-21
Driving for Economy	2-23
Winter Driving	2-24
Trailer or Vehicle Towing	2-27
Trailer Connector	2-31
Vehicle Load Limit	2-32

**WARNING: ENGINE EXHAUST CAN BE DANGEROUS!**

C010A03A-AAT

Engine exhaust fumes can be extremely dangerous. If, at any time, you smell exhaust fumes inside the vehicle, open the windows immediately.

o Do not inhale exhaust fumes.

Exhaust fumes contain carbon monoxide, a colorless, odorless gas that can cause unconsciousness and death by asphyxiation.

o Be sure the exhaust system does not leak.

The exhaust system should be checked whenever the vehicle is raised to change the oil or for any other purpose. If you hear a change in the sound of the exhaust or if you drive over something that strikes the underneath side of the car, have the exhaust system checked as soon as possible by your Hyundai dealer.

o Do not run the engine in an enclosed area.

Letting the engine idle in your garage, even with the garage door open, is a hazardous practice. Never run the engine in your garage any longer than it takes to start the engine and back the car out.

o Avoid idling the engine for prolonged periods with people inside the car.

If it is necessary to idle the engine for a prolonged period with people inside the car, be sure to do so only in an open area with the air intake set at "Fresh" and fan operating at one of the higher speeds so fresh air is drawn into the interior.

If you must drive with the tail gate open because you are carrying objects that make this necessary:

1. Close all windows.
2. Open side vents.
3. Set the air intake control at "Fresh", the air flow control at "Floor" or "Face" and the fan at one of the higher speeds.

To assure proper operation of the ventilation system, be sure the ventilation air intakes located just in front of the windshield are kept clear of snow, ice, leaves or other obstructions.

RISK OF ROLLOVER

C015A01CM-AAT

**PROPOSITION 65 WARNING:**

Engine exhaust and a wide variety of automobile components and parts, including components found in the interior furnishings in a vehicle, contain or emit chemicals known to the State of California to cause cancer and birth defects and reproductive harm. In addition, certain fluids contained in vehicles and certain products of component wear contain or emit chemicals known to the State of California to cause cancer and birth defects or other reproductive harm.

**WARNING:**

- o The 2WD Santa Fe is not designed for off-road use. The AWD Santa Fe is designed primarily for use on paved roads. However, occasional use in off-highway conditions such as established unpaved roads and non-challenging off-road trails is allowed. The AWD Santa Fe is not designed for blazing new trails, challenging off-road conditions, or unpaved hill climbing. Exceeding the conditions that were intended for the vehicle's primary design may result in injury or death.
- o Utility vehicles have a significantly higher rollover rate than other types of vehicles.
- o In a rollover crash, an unbelted person is significantly more likely to die than a person wearing a seat belt.

**WARNING:**

- o Sport utility vehicle have higher ground clearance and a narrower track to make them capable of performing in a wide variety of off-road applications. Specific design characteristics give them a higher center of gravity than ordinary cars. An advantage of the higher ground clearance is a better view of the road allowing you to anticipate problems. They are not designed for cornering at the same speeds as conventional 2-wheel drive vehicles any more than low-slung sports cars are designed to perform satisfactorily under off-road conditions. If at all possible, avoid sharp turns or abrupt maneuvers. As with other vehicles of this type, failure to operate this vehicle correctly may result in loss of control or vehicle rollover.
- o In a collision, an unbelted person is significantly more likely to be seriously injured or killed than a person wearing a seatbelt.

**WARNING:**

Your vehicle is equipped with tires designed to provide for safe ride and handling capability.

Do not use a size and type of tire and wheel that is different from the one that is originally installed on your vehicle. It can affect the safety and performance of your vehicle, which could lead to handling failure or rollover and serious injury.

When replacing the tires, be sure to equip all four tires with the tire and wheel of the same size, type, tread, brand and load-carrying capacity.

BEFORE STARTING THE ENGINE

C020A01CM-AAT

Before you start the engine, you should always:

1. Look around the vehicle to be sure there are no flat tires, puddles of oil, water or other indications of possible trouble.
2. After entering the car, check to be sure the parking brake is engaged.
3. Check that all windows, and lights are clean.
4. Check that the interior and exterior mirrors are clean and in position.
5. Check your seat, seatback and headrest to be sure they are in their proper positions.
6. Lock all the doors.
7. Fasten your seat belt and be sure that all other occupants have fastened theirs.
8. Turn off all lights and accessories that are not needed.
9. When you turn the ignition switch to "ON", check that all appropriate warning lights are operating and that you have sufficient fuel.
10. Check the operation of warning lights and all bulbs when key is in the "ON" position.

**WARNING:**

- o All passengers must be properly belted whenever the vehicle is moving. Refer to pages: 1-27 through 1-33 for more information on their proper use.
- o Always check the surrounding areas near your vehicle for people, especially children, before putting a car into 'drive.'
- o Always wear appropriate shoes when operating your vehicle. Unsuitable shoes (high heels, ski boots, etc.) may interfere with your ability to use the brake and accelerator pedal, and the clutch (if installed).

**WARNING:**

When you intend to park or stop the vehicle with the engine on, be careful not to depress the accelerator pedal for a long period of time. It may overheat the engine or exhaust system and cause fire.

TO START THE ENGINE

C030A02E-AAT

Combination Ignition Switch

- o If your Hyundai is equipped with a manual transaxle, place the shift lever in neutral and depress the clutch pedal fully.
- o If your Hyundai has an automatic transaxle, place the shift lever in "P" (park).
- o To start the engine, insert the ignition key and turn it to the "START" position. Release it as soon as the engine starts. Do not hold the key in the "START" position for more than 15 seconds.

NOTE:

- o The engine will not start if the clutch pedal is not depressed fully (Manual Transaxle) or the shift lever is not in "P" or "N" Position (Automatic Transaxle).
- o The ignition key cannot be turned from "ACC" position to "LOCK" position unless the shift lever is in the "P" (Park) position or the negative battery terminal is disconnected from the battery. To remove the key, always confirm that the shift lever is securely positioned in "P" (Park) (For Automatic Transaxle).
- o For additional information about starting, see page 2-6.

FarmaSOS.com

KEY POSITIONS

C040A02A-AAT

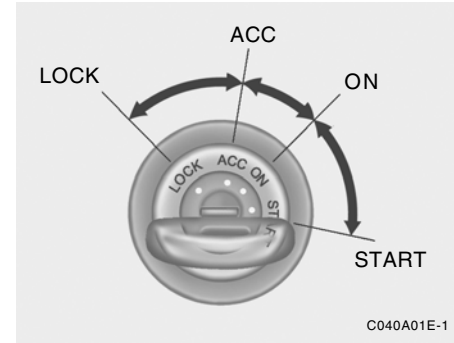

WARNING:

The engine should never be turned off or the key removed from the ignition key cylinder while the car is in motion. The steering wheel is locked by removing the key.

o "START"

The engine is started in this position. It will crank until you release the key.

NOTE:

Do not hold the key in the "START" position for more than 15 seconds.

- o "ON"

When the key is in the "ON" position, the ignition is on and all accessories may be turned on. If the engine is not running, the key should not be left in the "ON" position. This will discharge the battery and may also damage the ignition system.

- o "ACC"

With the key in the "ACC" position, some electrical accessories (radio, etc.) may be operated.

- o "LOCK"

The key can be removed or inserted in this position.

To protect against theft, the steering wheel locks by removing the key.

NOTE:

To unlock the steering wheel, insert the key, and then turn the steering wheel and key simultaneously.

C070C01A-AAT

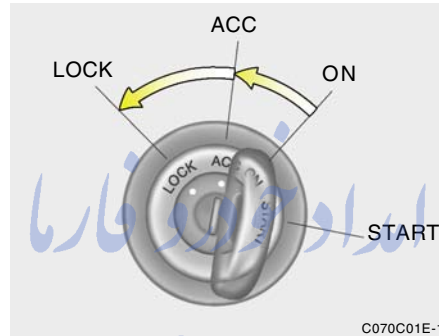
To remove the ignition key

C070C01E-1

1. Turn the ignition key to the "ACC" position.
2. Simultaneously push and turn the ignition key counterclockwise from the "ACC" position to the "LOCK" position.
3. The key can be removed in the "LOCK" position.

STARTING

C050A01A-AAT

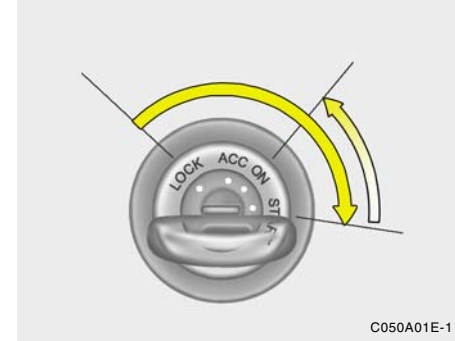

C050A01E-1

**WARNING:**

Never run the engine in a closed or poorly ventilated area any longer than is needed to move your car in or out of the area. The carbon monoxide gas emitted is odorless and can cause serious injury or death.

C050B01A-AAT

Normal Conditions:

The Starting Procedure:

1. Insert key, and fasten the seat belt.
2. Depress the clutch pedal fully and place the gearshift lever (manual transaxle) in neutral or the selector lever (automatic transaxle) in "P" (park) position.
3. After turning the ignition key to the "ON" position, make certain all warning lights and gauges are functioning properly before starting the engine.

**WARNING:**

Be sure that the clutch is fully depressed when starting a manual transaxle vehicle. Your manual transaxle equipped vehicle will not start unless the clutch pedal is fully depressed. On a manual transaxle equipped vehicle that can be started without depressing the clutch, there is the potential to cause damage to the vehicle or injury to someone inside or outside the vehicle as a result of the forward or backward movement of the vehicle that will occur if the clutch is not depressed when the vehicle is started.

4. Turn the ignition key to the "START" position and release it when the engine starts.
After the engine has started, allow the engine to run for 10 to 20 seconds prior to placing the vehicle in gear. The starter should not be operated for more than 15 seconds at a time. Wait 15-30 seconds between starting attempts to protect the starter from overheating.

تلفن شبانه روزی: ۰۲۱-۸۸۶۲۰۸۵

FarmaSOS.com

OPERATING THE MANUAL TRANSAXLE

C070A01CM-AAT

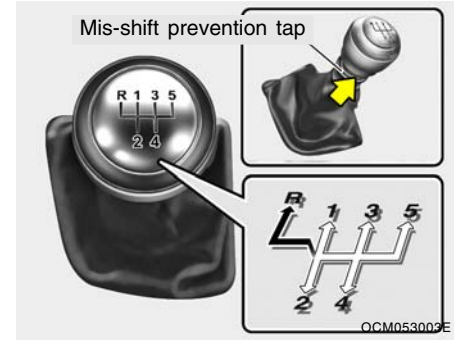
(If installed)

This shift pattern is imprinted on the shift knob. The transaxle is fully synchronized in all forward gears so shifting to either a higher or a lower gear is easily accomplished.

When shifting into reverse gear, pull the mis-shift prevention tab and shift into reverse gear position.

NOTE:

- o To shift into reverse, rest the lever in neutral for at least 3 seconds after your car is completely stopped. Then move the lever into the reverse position.
- o During cold weather, shifting may be difficult until the transaxle lubricant has warmed up. This is normal and not harmful to the transaxle.
- o If you've come to a complete stop and it's hard to shift into 1st or R(Reverse), put the shift lever in N(Neutral) position and release the clutch. Press the clutch pedal back down, and then shift into 1st or R(Reverse) gear position.
- o Do not use the shift lever as a handrest during driving, as this can result in premature wear of the transaxle shift forks.

**CAUTION:**

Do not downshift more than 2 gears or downshift the gear when the engine is running at high speed (5,000 RPM or higher). Such downshifting may damage the engine.

**CAUTION:**

When downshifting from fifth gear to fourth gear, caution should be taken not to inadvertently press the gear shift lever sideways in such a manner that second gear is engaged. Such a drastic downshift may cause the engine speed to increase to the point that the tachometer will enter the red-zone. Such over-revving of the engine may possibly cause engine damage.

C070B02A-AAT

Using the Clutch

The clutch should be pressed all the way to the floor before shifting, then released slowly. The clutch pedal should always be fully returned to the original position. Do not rest your foot on the clutch pedal while driving. This can cause unnecessary wear. Do not partially engage the clutch to hold the car on an incline. This causes unnecessary wear. Use the foot brake or parking brake to hold the car on an incline. Do not operate the clutch pedal rapidly and repeatedly.

C070E03A-AAT

Recommended Shift Points

Shift from-to	Recommended mph(km/h)
1-2	15 (20)
2-3	25 (40)
3-4	35 (55)
4-5	45 (75)

The shift points as shown above are recommended for optimum fuel economy and performance.

C070D040-AAT

Good Driving Practices

- o Never take the car out of gear and coast down a hill. This is extremely hazardous. Always leave the car in gear.
- o Don't "ride" the brakes. This can cause them to overheat and malfunction. Instead, when you are driving down a long hill, slow down and shift to a lower gear. When you do this, engine braking will help slow the car.
- o Slow down before shifting to a lower gear. This will help avoid over-revving the engine, which can cause damage.
- o Slow down when you encounter cross winds. This gives you much better control of your car.
- o Be sure the car is completely stopped before you attempt to shift into reverse. The transaxle can be damaged if you do not. To shift into reverse, depress the clutch, move the shift lever to neutral, wait three seconds, then shift to the reverse position.
- o Exercise extreme caution when driving on a slippery surface. Be especially careful when braking, accelerating or shifting gears. On a slippery surface, an abrupt change in vehicle speed can cause the drive wheels to lose traction and the vehicle to go out of control.



WARNING:

- o **Always buckle-up! In a collision, an unbelted occupant is significantly more likely to be seriously injured or killed than a properly belted occupant.**
- o **Avoid high speeds when cornering or turning.**
- o **Do not make quick steering wheel movements, such as sharp lane changes or fast, sharp turns.**
- o **The risk of rollover is greatly increased if you lose control of your vehicle at highway speeds.**
- o **Loss of control often occurs if two or more wheels drop off the roadway and the driver oversteers to reenter the roadway.**
- o **In the event your vehicle leaves the roadway, do not steer sharply. Instead, slow down before pulling back into the travel lanes.**
- o **Never exceed posted speed limits.**

AUTOMATIC TRANSAXLE (4 SPEED A/T, 5 SPEED A/T)

C090A01NF-GAT

(If Installed)



OCM053004

The highly efficient Hyundai automatic transaxle has four/five forward speeds and one reverse speed. The individual speeds are selected automatically, depending on the position of the speed selector lever. The selector lever has 2 gates; the main gate and the manual gate.

NOTE:

For information on manual gate operation, refer to "Sports Mode".

In the main gate, the selector lever has 4 positions.

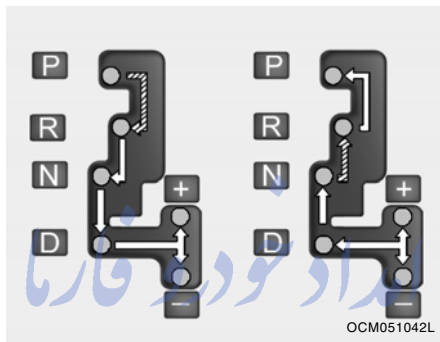

OCM051042L

NOTE:

- ➡ Depress the brake pedal when shifting.
- ➡ The selector lever can be shifted freely.

The first few shifts on a new vehicle, or if the battery has been disconnected, may be somewhat abrupt. This is a normal condition, and the shifting sequence will adjust after shifts are cycled a few times by the T.C.M (Transmission Control Module).



CAUTION:

Never shift into "R" or "P" position while the vehicle is moving.

The indicator lights in the instrument cluster indicate the selector lever position when the ignition is switched "ON". During sports mode operation, the gear currently in use displays in the numeral indicator.

C090B02A-AAT

The function of each position is as follows:

o P (Park):

Use to hold the vehicle in place when parked or while starting the engine. Whenever parking the car, apply the parking brake and shift the selector lever to the "P" (Park) position.



CAUTION:

Never place the selector lever in the "P" (Park) position unless the vehicle is fully stopped. Failure to observe this caution will cause severe damage to the transaxle.

C090C01A-AAT

o R (Reverse):

Use for backing up the vehicle. Bring the car to a complete stop before shifting the selector lever to "R" position.

C090D02A-AAT

o N (Neutral):

In the "N" position, the transaxle is in neutral, which means that no gears are engaged. The engine can be started with the shift lever in "N" position, although this is not recommended except if the engine stalls while the car is moving.

C090E01CM-GAT

o D (Drive):

Use for normal driving. Bring the car to a complete stop before shifting the selector to "D" position. The transaxle will automatically shift through a four/five gear sequence.

C090F02L-GAT

Sports Mode

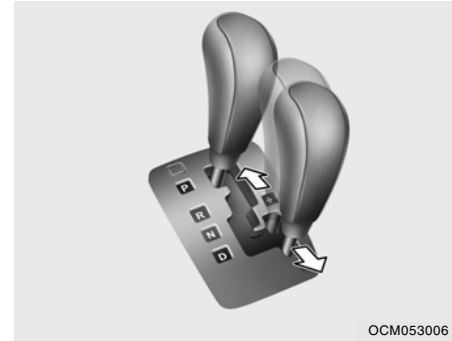

OCM053006

Whether the vehicle is stationary or in motion, sports mode is selected by pushing the selector lever from the "D" position into the manual gate. To return to "D" range operation, push the selector lever back into the main gate.

In sports mode, moving the selector lever backwards and forwards can make rapid gearshifts simple. In contrast to a manual transaxle, the sports mode allows gearshifts with the accelerator pedal depressed.

UP (+) : Push the lever forward once to shift up one gear.

DOWN (-) : Pull the lever backwards once to shift down one gear.

SKIP : By rapidly moving the selector forward or backward twice, it is possible to skip one gear, i.e. 1st to 3rd or 3rd to 1st .



CAUTION:

- o In sports mode, the driver must execute upward shifts in accordance with prevailing road conditions, taking care to keep the engine speed below the red zone.
- o For engine protection, upward shifts are made automatically when the engine rpm reaches the red zone.
- o By rapidly moving the selector lever backwards (-) twice it is possible to skip one gear, i.e., 3rd to 1st, 4th to 2nd or 5th to 3rd. Since sudden engine braking and/or rapid acceleration can cause a loss of traction, however, downshifts must be made carefully in accordance with the vehicle's speed.

NOTE:

- o In sports mode, only the four/five forward gears can be selected. To reverse or park the vehicle, move the selector lever to the "R" or "P" position as required.
- o In sports mode, downward shifts are made automatically when the vehicle slows down. When the vehicle stops, 1st gear is automatically selected.
- o To maintain the required levels of vehicle performance and safety, the system may not execute certain gear-shifts when the selector lever is operated.
- o Before driving away from a stop on a slippery road, push the selector lever forward into the +(UP) position. This causes the transaxle to shift into 2nd gear which is better for smooth driving away on a slippery road. Push the selector lever to the -(DOWN) side to shift back to 1st gear.

C090H01L-GAT

NOTE:

- o For smooth and safe operation, depress the brake pedal when shifting from "Neutral" position or "Park" position to a forward or reverse gear.
- o The ignition key must be in the "ON" position and the brake pedal fully depressed in order to move the shift lever from the "P" (Park) position to any of the other positions.
- o It is always possible to shift from "R", "N", or "D" position to "P" position. The vehicle must be fully stopped to avoid transaxle damage.

C090J01CM-GAT

**CAUTION:**

- o Shift into "R", "D" and "P" position only when the vehicle has completely stopped.
- o Do not accelerate the engine in reverse or any of the forward positions with the brakes applied.
- o Always apply the footbrake when shifting from "P" or "N", to "R" or "D" position.
- o Do not use the "P" (Park) position in place of the parking brake. Always set the parking brake, shift the transaxle into "P" (Park) position and turn off the ignition when you leave the vehicle, even momentarily. Never leave the vehicle unattended while the engine is running.
- o Check the automatic transaxle fluid level regularly, and add fluid as necessary.
- o See the maintenance schedule for the proper fluid recommendation.

C090J01NF-GAT

Shift Lock Release

If you cannot move the shift lever from the "P" (Park) position to any other position with the brake pedal fully depressed and the ignition key in the "ON" position, remove the cap on the console and with a thin object such as a flat-head screwdriver, push the shift lock release button down.

Then, with the brake pedal depressed, move the shift lever to the desired position, and then the shift lock release button will automatically return to its original position after shifting from the "P" (Park) position. Then, reinstall the cap.

If you need to use the shift lock release, it could mean your car is developing a problem. Have the car checked by your Hyundai dealer.

C090N01CM-AAT

Good Driving Practices

- o Never move the gear selector lever from "P" or "N" to any other position with the accelerator pedal depressed.
- o Never move the gear selector lever into "P" when the vehicle is in motion.
- o Be sure the car is completely stopped before you attempt to shift into "R" or "D".
- o Never take the car out of gear and coast down a hill. This may be extremely hazardous. Always leave the car in gear when moving.
- o Do not "ride" the brakes. This can cause them to overheat and malfunction. Instead, when you are driving down a long hill, slow down and shift to a lower gear. When you do this, engine braking will help slow the car.
- o Slow down before shifting to a lower gear. Otherwise, the lower gear may not be engaged.
- o Always use the parking brake. Do not depend on placing the transaxle in "P" to keep the car from moving.

- o Exercise extreme caution when driving on a slippery surface. Be especially careful when braking, accelerating or shifting gears. On a slippery surface, an abrupt change in vehicle speed can cause the drive wheels to lose traction and the vehicle to go out of control.
- o Optimum vehicle performance and economy is obtained by smoothly depressing and releasing the accelerator pedal.

تلفن شبانه روزی: ۰۲۱-۸۸۶۲۰۸۵

FarmaSOS.com

**WARNING:**

- o **Always buckle-up! In a collision, an unbelted occupant is significantly more likely to be seriously injured or killed than a properly belted occupant.**
- o **Avoid high speeds when cornering or turning.**
- o **Do not make quick steering wheel movements, such as sharp lane changes or fast, sharp turns.**
- o **The risk of rollover is greatly increased if you lose control of your vehicle at highway speeds.**
- o **Loss of control often occurs if two or more wheels drop off the roadway and the driver oversteers to reenter the roadway.**
- o **In the event your vehicle leaves the roadway, do not steer sharply. Instead, slow down before pulling back into the travel lanes.**
- o **Never exceed posted speed limits.**

ANTI-LOCK BRAKE SYSTEM (ABS)

C120A01NF-AAT

The Anti-Lock Brake System (ABS) is designed to prevent wheel lock-up during sudden braking or on hazardous road surfaces. The ABS control module monitors the wheel speed and controls the pressure applied to each brake. Thus, in emergency situations or on slick roads, ABS will increase vehicle control during braking.

NOTE:

- o A click sound may be heard in the engine compartment when the vehicle begins to move after the engine is started. These conditions are normal and indicate that the anti-lock brake system (Electronic Stability Control) is functioning properly.
- o During ABS (ESC) operation, a pulsation may be felt in the brake pedal when the brakes are applied. Also, a noise may be heard in the engine compartment while braking. These conditions are normal and indicate that the anti-lock brake system (Electronic Stability Control System) is functioning properly.



WARNING:

ABS (ESC) will not prevent accidents due to improper or dangerous driving maneuvers. Even though vehicle control is improved during emergency braking, always maintain a safe distance between you and objects ahead. Vehicle speeds should always be reduced during extreme road conditions.

The braking distance for cars equipped with an anti-lock braking system (Electronic Stability Control System) may be longer than for those without it in the following road conditions. تلفن شماره روزی
During these conditions the vehicle should be driven at reduced speed:

- o Rough, gravel or snow-covered roads.
- o With tire chains installed.
- o On roads where the road surface is pitted or has different surface height.

The safety features of an ABS (ESC) equipped vehicle should not be tested by high speed driving or cornering. This could endanger the safety of yourself or others.

ELECTRONIC STABILITY CONTROL (ESC) SYSTEM

C310A04JM-AAT

(If installed)



WARNING:

Never drive too fast for the road conditions or too quickly when cornering. Electronic stability control (ESC) will not prevent accidents. Excessive speed in turns, abrupt maneuvers and hydroplaning on wet surfaces can still result in serious accidents. Only a safe and attentive driver can prevent accidents by avoiding maneuvers that cause the vehicle to lose traction. Even with ESC installed, always follow all the normal precautions for driving - including driving at safe speeds for the conditions.



The Electronic Stability Control (ESC) system is designed to stabilize the vehicle during cornering maneuvers. ESC checks where you are steering and where the vehicle is actually going. ESC applies the brakes at individual wheels and intervenes in the engine management system to stabilize the vehicle.

The Electronic Stability Control (ESC) system is an electronic system designed to help the driver maintain vehicle control under adverse conditions. It is not a substitute for safe driving practices.

Factors including speed, road conditions and driver steering input can all affect whether ESC will be effective in preventing a loss of control. It is still your responsibility to drive and corner at reasonable speeds and to leave a sufficient margin of safety.



CAUTION:

Driving with varying tire or wheel size may cause the ESC system to malfunction. When replacing tires, make sure they are the same size as your original tires.



WARNING:

Electronic stability control is only a driving aid; all normal precautions for driving in inclement weather and on slippery road surfaces should be observed.

C310B01JM-AAT

ESC ON/OFF Mode

When the ESC is operating, the ESC indicator in the instrument cluster will blink. If you turn the system off by pressing the ESC switch, the ESC-OFF indicator will come on and stay on. In the ESC-OFF mode, the stability control will be deactivated. Adjust your driving accordingly. To turn the system back on, press the switch again. The ESC-OFF indicator should go off.

NOTE:

The ESC mode will automatically be turned ON after the engine is turned off and restarted.

FULL-TIME AWD OPERATION

C310D01JM-AAT

Indicators and Warning

The indicators should illuminate when the ignition key is turned to ON or START but should go out after three seconds.

If the indicators do not illuminate, or the ESC or ESC-OFF indicator does not go out after 3 seconds, have the vehicle checked by an authorized dealer.

Should there be any unusual conditions in the device while driving, ESC-OFF indicator illuminates as a warning.

If ESC-OFF indicator illuminates, pull your car to a safe place and stop the engine. Then, start the engine again to check if the ESC-OFF indicator goes out.

If the indicator remains lit even after the engine has been started, have your car checked by an authorized Hyundai dealer.

C350A01CM-AAT

(If installed)

Engine power can be delivered to all wheels. Full-time AWD (All Wheel Drive) is useful when good traction is required, such as when driving on slippery, wet or snow-covered roads and when moving out of mud. Your vehicle is not designed for challenging off-road use. Full-time AWD vehicles are designed primarily to improve traction and performance on paved roads and highways in wet and/or slippery conditions. Occasional off-road use such as established unpaved roads and trails is considered normal use. It is always important when traveling off-highway that the driver carefully reduce their speed to a level that does not exceed the safe operating speed for those conditions. In general, off-road conditions provide less traction and braking effectiveness than on road conditions. These factors must be carefully considered when driving off-road. Keeping the vehicle in contact with the driving surface and under control in these conditions is always the driver's responsibility for the safety of him/herself and his or her passengers.



WARNING:

This vehicle is designed primarily for on road use. Driving the vehicle in challenging off-road conditions may result in damage to the vehicle. Driving in conditions that exceed the vehicle's intended design or the driver's experience level may result in severe injury or death.

Driving AWD Safely

- (1) As always, be sure to wear the seat belt.
- (2) Do not drive in challenging off-road conditions or areas that exceed the vehicle's basic design intent or the driver's experience level.
- (3) Drive at lower speeds in strong crosswinds. Because of your vehicle's higher center of gravity, its stability will be affected in crosswinds. Slower speeds ensure better vehicle control.
- (4) Check the brake condition after driving in wet or muddy conditions. Press the brake several times as you move slowly until you feel normal braking forces return.
- (5) Do not drive the vehicle through water. (i.e. streams, rivers, lakes, etc.)
- (6) When driving on a snow-covered road or a slippery, muddy surface, make sure that you keep a sufficient distance between your vehicle and the one ahead of you.

- (7) Since the driving torque is always applied to all 4 wheels, the performance of the full-time AWD vehicle is affected by the condition of the tires. Be sure to equip your vehicle with four tires of the same size and type.
 - o When replacement of any of the tires or wheels is necessary, replace all of them with tires or wheels of the same size type.
 - o Rotate the tires and check the tire pressure at regular intervals.

تلفن شبانه روزی: ۰۲۱-۸۸۶۲۰۸۵

FarmaSOS.com



WARNING:

Your vehicle is equipped with tires designed to provide for safe ride and handling capability.

Do not use a size and type of tire and wheel that is different from the one that is originally installed on your vehicle. It can affect the safety and performance of your vehicle, which could lead to handling failure or rollover and serious injury.

When replacing the tires, be sure to equip all four tires with the tire and wheel of the same size, type, tread, brand and load-carrying capacity.

(8) The full-time AWD vehicle cannot be towed by an ordinary tow truck. Make sure that the vehicle is towed with all four wheels raised off the ground.

- o Roadside Assistance Program: Off-roading is not covered. To receive service, the vehicle must be on a publicly maintained road.
- o If the vehicle is towed with only two wheels raised off the ground, the AWD system could be damaged.
- o In unavoidable cases, if the vehicle is being towed with all four wheels on the ground, it should only be towed forward.
- o While towing, check the following items.
 1. The ignition switch is in "ACC" or "ON".
 2. Place the shift lever in neutral (For Automatic Transaxle, "N" position).
 3. Release the parking brake.

NOTE:

To avoid serious damage to your AWD vehicle, limit towing to 10 mph and not for more than 1 mile at ANY TIME.

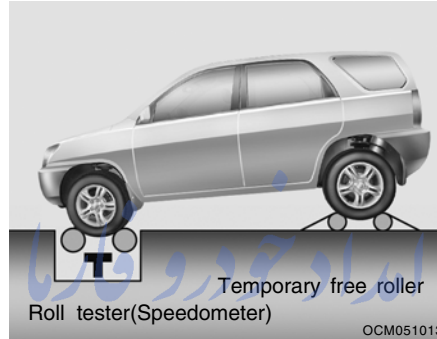

- (9) For a speedometer test or inspection/maintenance (I/M) program of a Santa Fe AWD vehicle, use a four wheel chassis dynamometer.

FarmaSOS.com



CAUTION:

Never engage the parking brake while performing these tests.

- o In rare cases when it's unavoidable that a AWD vehicle is to be inspected on a 2WD roll tester, strictly follow the procedures.
 1. Check the tire pressures recommended for your vehicle.
 2. Place the front wheels on the roll tester as shown in the illustration.
 3. Release the parking brake.
 4. Place the rear wheels on the temporary free roller as shown in the illustration.



WARNING:

Keep away from the front of the vehicle while inspecting.

- (10) When using tire chains, always attach them to the four wheels. In some unavoidable circumstances, install them on only the front wheels, not the rear wheels.
- (11) If the front or rear wheels get stuck in the mud, do not spin them recklessly. The AWD system could be damaged.

**CAUTION:**

If one of the front or rear wheels begins to spin in mud, snow, etc., the vehicle can sometimes be driven out by depressing the accelerator pedal further; however, avoid running the engine continuously at high rpm because doing so could damage the AWD system.

**WARNING:**

- o Avoid high cornering speeds.
- o Do not make quick steering wheel movements, such as sharp lane changes or fast, sharp turns.
- o The risk of rollover is greatly increased if you lose control of your vehicle at highway speeds.
- o While the full-time AWD vehicle is being raised on a jack, never start the engine or cause the tires to rotate. There is danger that rotating tires touching the ground could cause the vehicle to go off the jack and to jump forward.
- o In a collision, an unbelted person is significantly more likely to be seriously injured or killed than a person wearing a seat belt.
- o Loss of control may occur if two or more wheels drop off the roadway and the driver oversteers to reenter the roadway.
- o In the event your vehicle leaves the roadway, do not steer sharply. Instead, slow down before pulling back into the travel lanes.

AWD LOCK SYSTEM

C360A01CM-AAT

**(With Electronic Control AWD)
(If installed)**

Type A



Type B

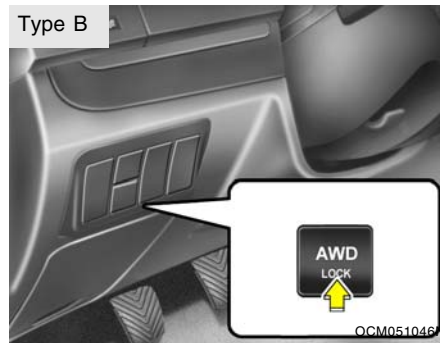

This AWD system is designed for dividing the power ratio automatically in normal driving conditions.

During off-road or low-friction driving conditions, press the AWD lock button to drive in full-time AWD, dividing the power ratio to 50:50 in the front and rear wheels. The AWD lock indicator light in the instrument cluster is illuminated.

This setup begins to get cancelled when the vehicle speed exceeds 19 mph, and the function is completely released at a speed of 25 mph or higher. Conversely, the function is rerun when the speed again drops to 25 mph or lower, and is fully established at speeds below 19 mph.

To release the AWD lock function, press the AWD lock button again.

The AWD lock indicator light in the instrument cluster should go off.



- 1) Pressing the AWD lock button on the tough terrain, the driving power is equally distributed to the front and rear. AWD lock keeps activating when not exceeding 25 mph.
- 2) Release the AWD lock button on the normal driving conditions.

C130A02A-AAT

**WARNING:**

- o Whenever leaving vehicle or parking, always set the parking brake as far as possible and fully engage the vehicle's transaxle into the park position. Vehicles not fully engaged in park with the parking brake set are at risk for moving inadvertently and injuring yourself or others.
- o All vehicles should always have the parking brake fully engaged when parking to avoid inadvertent movement of the car which can injure occupants or pedestrians.
- o Nothing should be carried on top of the shelf panel behind the rear seat. If there were an accident or a sudden stop, such objects could move forward and cause damage to the vehicle or injure the occupants.

- o After being parked, check to be sure the parking brake is not engaged and that the parking brake indicator light is out before driving away.
- o Driving through water may get the brakes wet. They can also get wet when the car is washed. Wet brakes can be dangerous! Your car will not stop as quickly if the brakes are wet. Wet brakes may cause the car to pull to one side. To dry the brakes, apply the brakes lightly while driving slowly until the braking action returns to normal, taking care to keep the car under control at all times. If the braking action does not return to normal, stop as soon as it is safe to do so and call your Hyundai dealer for assistance.
- o Don't coast down hills with the car out of gear. This is extremely hazardous. Keep the car in gear at all times, use the brakes to slow down, then shift to a lower gear so that engine braking will help you maintain a safe speed.
- o Don't "ride" the brake pedal. Resting your foot on the brake pedal while driving can be dangerous because it can result in the brakes overheating and losing their effectiveness. It also increases the wear of the brake components.
- o If a tire goes flat while you are driving, apply the brakes gently and keep the car pointed straight ahead while you slow down. When you are moving slowly enough for it to be safe to do so, pull off the road and stop in a safe place.
- o If your car is equipped with an automatic transaxle, don't let your car creep forward. To avoid creeping forward, keep your foot firmly on the brake pedal when the car is stopped.
- o Use caution when parking on a hill. Firmly engage the parking brake and place the gear selector lever in "P" (automatic transaxle) or in first or reverse gear (manual transaxle). If your car is facing downhill, turn the front wheels into the curb to help keep the car from rolling. If your car is facing uphill, turn the front wheels away from the curb to help keep the car from rolling. If there is no curb or if it is required by other conditions to keep the car from rolling, block the wheels.
- o Under some conditions your parking brake can freeze in the engaged position. This is most likely to happen when there is an accumulation of snow or ice around or near the rear brakes or if the brakes are wet. If there is a risk that the parking brake may freeze, apply it only temporarily while you put the gear selector lever in "P" (automatic) or in first or reverse gear (manual transaxle) and block the rear wheels so the car cannot roll. Then release the parking brake.
- o Do not hold the vehicle on the upgrade with the accelerator pedal. This can cause the transaxle to overheat. Always use the brake pedal or parking brake.

DRIVING FOR ECONOMY

C140A02A-AAT

You can save fuel and get more miles from your car if you follow these suggestions:

- o Drive smoothly. Accelerate at a moderate rate. Don't make "jack-rabbit" starts or full-throttle shifts and maintain a steady cruising speed. Don't race between stoplights. Try to adjust your speed to that of the other traffic so you don't have to change speeds unnecessarily. Avoid heavy traffic whenever possible. Always maintain a safe distance from other vehicles so you can avoid unnecessary braking. This also reduces brake wear.
- o Drive at a moderate speed. The faster you drive, the more fuel your car uses. Driving at a moderate speed, especially on the highway, is one of the most effective ways to reduce fuel consumption.
- o Don't "ride" the brake or clutch pedal. This can increase fuel consumption and also increase wear on these components. In addition, driving with your foot resting on the brake pedal may cause the brakes to overheat, which reduces their effectiveness and may lead to more serious consequences.
- o Take care of your tires. Keep them inflated to the recommended pressure. Incorrect inflation, either too much or too little, results in unnecessary tire wear. Check the tire pressures at least once a month.
- o Be sure that the wheels are aligned correctly. Improper alignment can result from hitting curbs or driving too fast over irregular surfaces. Poor alignment causes faster tire wear and may also result in other problems as well as greater fuel consumption.
- o Keep your car in good condition. For better fuel economy and reduced maintenance costs, maintain your car in accordance with the maintenance schedule in Section 5. If you drive your car in severe conditions, more frequent maintenance is required (see Section 5 for details).
- o Keep your car clean. For maximum service, your Hyundai should be kept clean and free of corrosive materials. It is especially important that mud, dirt, ice, etc. not be allowed to accumulate on the underside of the car. This extra weight can result in increased fuel consumption and also contribute to corrosion.
- o Travel lightly. Don't carry unnecessary weight in your car. Weight reduces fuel economy.
- o Don't let the engine idle longer than necessary. If you are waiting (and not in traffic), turn off your engine and restart only when you're ready to go.
- o Remember, your Hyundai does not require extended warm-up. After the engine has started, allow the engine to run for 10 to 20 seconds prior to placing the vehicle in gear. In very cold weather, however, give your engine a slightly longer warm-up period.
- o Don't "lug" or "over-rev" the engine. Lugging is driving too slowly in too high a gear resulting in the engine bucking. If this happens, shift to a lower gear. Over-revving is racing the engine beyond its safe limit. This can be avoided by shifting at the recommended speeds.
- o Use your air conditioning sparingly. The air conditioning system is operated by engine power so your fuel economy is reduced when you use it.

SMOOTH CORNERING

C150A01A-AAT

Avoid braking or gear changing in corners, especially when roads are wet. Ideally, corners should always be taken under gentle acceleration. If you follow these suggestions, tire wear will be held to a minimum.

WINTER DRIVING

C160A01A-AAT

The more severe weather conditions of winter result in greater wear and other problems. To minimize the problems of winter driving, you should follow these suggestions:

C160B01CM-AAT

Snowy or Icy Conditions

To drive your vehicle in deep snow, it may be necessary to use snow tires or to install tire chains on your tires. If snow tires are needed, it is necessary to select tires equivalent in size and type of the original equipment tires. Failure to do so may adversely affect the safety and handling of your car. Furthermore, speeding, rapid acceleration, sudden brake applications, and sharp turns are potentially very hazardous practices.

During deceleration, use engine braking to the fullest extent. Sudden brake applications on snowy or icy roads may cause skids to occur. You need to keep sufficient distance between the vehicle in operation in front and your vehicle. Also, apply the brake gently.

It should be noted that installing tire chains on the tire will provide a greater driving force, but will not prevent side skids.

NOTE:

- o **Tire chains are not legal in all states. Check state laws before fitting tire chains.**
- o **When using tire chains, attach them to the drive wheels as follows.**
2WD : Front wheels
AWD : All four wheels
In some unavoidable circumstances, install them on only the front wheels, not the rear wheels.

C160C01A-AAT

Use High Quality Ethylene Glycol Coolant

Your Hyundai is delivered with high quality ethylene glycol coolant in the cooling system. It is the only type of coolant that should be used because it helps prevent corrosion in the cooling system, lubricates the water pump and prevents freezing. Be sure to replace or replenish your coolant in accordance with the maintenance schedule in Section 5. Before winter, have your coolant tested to assure that its freezing point is sufficient for the temperatures anticipated during the winter.

C160D01A-AAT

Check Battery and Cables

Winter puts additional burdens on the battery system. Visually inspect the battery and cables as described in Section 6. The level of charge in your battery can be checked by your Hyundai dealer or a service station.

C160E01A-AAT

Change to "Winter Weight" Oil if Necessary

In some climates it is recommended that a lower viscosity "winter weight" oil be used during cold weather. See Section 9 for recommendations. If you aren't sure what weight oil you should use, consult your Hyundai dealer.

C160F01A-AAT

Check Spark Plugs and Ignition System

Inspect your spark plugs as described in Section 6 and replace them if necessary. Also check all ignition wiring and components to be sure they are not cracked, worn or damaged in any way.

C160G01A-GAT

To Keep Locks from Freezing

To keep the locks from freezing, squirt an approved de-icer fluid or glycerine into the key opening. If a lock is covered with ice, squirt it with an approved de-icing fluid to remove the ice. If the lock is frozen internally, you may be able to thaw it out by using a heated key. Handle the heated key with care to avoid injury.

NOTE:

The proper temperature for using the immobilizer key is from -40°F (-40°C) to 176°F (80°C). If you heat the immobilizer key over 80°C to open the frozen lock, it may cause damage to the transponder in its head.

C160H02A-AAT

Use Approved Window Washer Anti-Freeze in System

To keep the water in the window washer system from freezing, add an approved window washer anti-freeze solution in accordance with instructions on the container. Window washer anti-freeze is available from Hyundai dealers and most auto parts outlets. Do not use engine coolant or other types of anti-freeze as these may damage the paint finish.

C160I01A-AAT

Don't Let Your Parking Brake Freeze

Under some conditions your parking brake can freeze in the engaged position. This is most likely to happen when there is an accumulation of snow or ice around or near the rear brakes or if the brakes are wet. If there is a risk the parking brake may freeze, apply it only temporarily while you put the gear selector lever in "P" (automatic) or in first or reverse gear (manual transaxle) and block the rear wheels so the car cannot roll. Then release the parking brake.

C160J01A-AAT

Don't Let Ice and Snow Accumulate Underneath

Under some conditions, snow and ice can build up under the fenders and interfere with the steering. When driving in severe winter conditions where this may happen, you should periodically check underneath the car to be sure the movement of the front wheels and the steering components is not obstructed.

C160K01A-AAT

Carry Emergency Equipment

Depending on the severity of the weather where you drive your car, you should carry appropriate emergency equipment. Some of the items you may want to carry include tire chains, tow straps or chains, flashlight, emergency flares, sand, a shovel, jumper cables, a window scraper, gloves, ground cloth, coveralls, a blanket, etc.

C170A02A-AAT

Pre-Trip Inspections

1. Tires:

Adjust the tire inflation pressures to specification. Low tire inflation pressures will result in overheating and possible failure of the tires.

Avoid using worn or damaged tires which may result in reduced traction or tire failure.

NOTE:

Never exceed the maximum tire inflation pressure shown on the tires.



WARNING:

- o Underinflated or overinflated tires can cause poor handling, loss of vehicle control, and sudden tire failure leading to accidents, injuries, and even death. Always check tires are properly inflated before driving. Refer to pages 2-31 and 8-3 for proper tire pressures and further information.

USE OF LIGHTS

C180A01A-AAT

Check your lights regularly for correct operation and always keep them clean. When driving during the day in conditions of poor visibility, it is helpful to drive with headlights on low beam. This enables you to be seen as well as to see.

امداد خودرو فارما

تلفن شبانه روزی: ۰۲۱-۸۸۶۲۰۸۵

FarmaSOS.com

TRAILER OR VEHICLE TOWING

C190A01S-AAT

If you are considering towing with your car, you should first check with your State's Department of Motor Vehicles to determine their legal requirements. Since laws vary from State to State the requirements for towing trailers, cars, or other types of vehicles or apparatus may differ. Ask your Hyundai dealer for further details before towing.

**CAUTION:**

Do not do any towing with your car during its first 1,200 miles (2,000 km) in order to allow the engine to properly break in. Failure to heed this caution may result in serious engine or transaxle damage.

**WARNING:**

- o **Driving on tires with no or insufficient tread is dangerous. Worn-out tires can result in loss of vehicle control, collisions, injury, and even death. Worn-out tires should be replaced as soon as possible and should never be used for driving. Always check tire tread before driving your car. Refer to 8-12 for further information and tread limits.**

2. Fuel, engine coolant and engine oil:
High speed travel consumes more fuel than urban motoring. Do not forget to check both engine coolant and engine oil.

3. Drive belt:
A loose or damaged drive belt may result in overheating of the engine.

C190B01S-AAT

Trailer Hitches

Select the proper hitch and ball combination, making sure that its location is compatible with that of the trailer or vehicle being towed.

Use a quality non-equalizing hitch which distributes the tongue load uniformly throughout the chassis.

The hitch should be bolted securely to the car and installed by a qualified technician. **DO NOT USE A HITCH DESIGNED FOR TEMPORARY INSTALLATION AND NEVER USE ONE THAT ATTACHES ONLY TO THE BUMPER.**

C190C02Y-AAT

Trailer Brakes

If your trailer is equipped with a braking system, make sure it conforms to federal and/or local regulations and that it is properly installed and operating correctly.

NOTE:

If you tow a trailer or vehicle, your car will require more frequent maintenance due to the additional load. See Maintenance Under Severe Usage Conditions" on page 5-6.

**CAUTION:**

- o **Never connect a trailer brake system directly to the vehicle brake system.**
- o **When towing a trailer on steep grades (in excess of 6%) pay close attention to the engine coolant temperature gauge to ensure the engine does not overheat. If the needle of the coolant temperature gauge moves across the dial towards "H" (HOT), pull over and stop as soon as it is safe to do so, and allow the engine to idle until it cools down. You may proceed once the engine has cooled sufficiently.**

C190D01S-AAT

Safety Chains

Should the hitch connection between your vehicle and the trailer or vehicle you are towing fail, the trailer or vehicle could wander dangerously across other lanes of traffic and ultimately leave the roadway. To eliminate this potentially dangerous situation, safety chains, attached between your car and the trailer or towed vehicle, are required in most states.

C190E01CM-AAT

Trailer Weight Limit

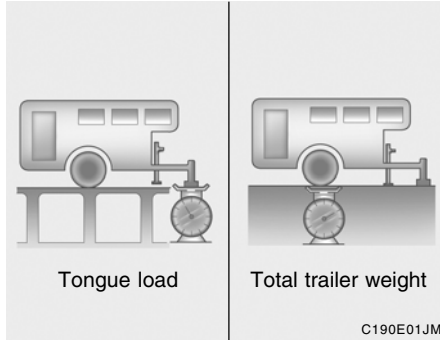

- o Keep the tongue load 10% of the total trailer load.
- o Tongue load $\frac{\quad}{\text{Total trailer weight}} \times 100 = 10\% \text{ (MAX)}$
- o Tongue loads can be increased or decreased by re-distributing the load in the trailer.
This can be verified by checking the total weight of the loaded trailer and then checking the load on the tongue.

NOTE:

1. Never load the trailer with more weight in the back than in the front. About 60% of the trailer load should be in the front half on the trailer and the remaining 40% in the rear.
2. The total gross vehicle weight with trailer must not exceed the Gross Vehicle Weight Rating (GVWR) shown on the vehicle identification plate (see page 8-2). The total gross vehicle weight is the combined weight of the vehicle, driver, all passengers and their luggage, cargo, hitch, trailer tongue load and other optional equipment.
3. The front or rear axle weight must not exceed the Gross Axle Weight Rating (GAWR) shown on the vehicle identification plate (see page 8-2). It is possible that your towing package does not exceed the GVWR but exceeds the GAWR.
Improper trailer loading and/or too much luggage in the cargo area can overload the rear axle. Redistribute the load and check the axle weight again.

4. When towing a trailer, be sure to consult your Hyundai dealer for further information on additional requirements such as a towing kit, etc.



CAUTION:

The following specifications are recommended when towing a trailer. The loaded trailer weight cannot safely exceed the values in the chart.

Lbs. (kg)

	Engine	Maximum Towable Weight	
		Trailer	Tongue
With	2.7L	2,800(1,270)	280(127)
Brake	3.3L	3,500(1,588)	350(159)
Without	2.7L	1,650(748)	165(75)
Brake	3.3L		

- Without Trailer Package : Towable Weight is 2,000 lbs(907.4kg)
- Boat Trailer Weight : Maximum towable weight + 1,000 lbs(453.7kg)
- Maximum Towable Weight : 2 person(Driver and 1 passenger)

**WARNING:**

- o Improperly loading your vehicle and trailer can seriously affect its steering and braking performance causing a crash which could cause serious injury or death.
- o Towing a trailer affects vehicle handling and braking.
- o Drive more slowly when towing a trailer and allow more distance when braking.
- o Be careful when driving in slippery and windy conditions.
- o Be careful when turning and while driving up and down hills.

C190F01CM-AAT

Trailer or Vehicle Towing Tips

1. Before towing, check hitch and safety chain connections as well as proper operation of the trailer running lights, brake lights, and turn signals.
2. Trailer towing requires more fuel than normal conditions.
3. To maintain engine braking efficiency, do not tow a trailer with the transaxle in fifth gear (manual transaxle).
4. Always secure items in the trailer to prevent load shift while driving.
5. Check the condition and air pressure of all tires on the trailer and your car. Low tire pressure can seriously affect the handling. Also check the spare tire.
6. The vehicle/trailer combination is more affected by crosswind and buffeting. When being passed by a large vehicle, keep a constant speed and steer straight ahead. If there is too much wind buffeting, slow down to get out of the other vehicle's air turbulence.
7. When parking your car and trailer, especially on a hill, be sure to follow all the normal precautions. Turn your front wheel into the curb, set the parking brake firmly, and put the transaxle in 1st or Reverse (manual) or Park (automatic). In addition, place wheel chocks at each of the trailer's tires.
8. If the trailer has electric brakes, start your vehicle and trailer moving, and then apply the trailer brake controller by hand to be sure the brakes are working. This lets you check your electrical connection at the same time.
9. During your trip, check occasionally to be sure that the load is secure, and that the lights and any trailer brakes are still working.
10. Avoid jerky starts, sudden acceleration or sudden stops.
11. Avoid sharp turns and rapid lane changes.
12. Avoid holding the brake pedal down too long or too frequently. This could cause the brakes to overheat, resulting in reduced braking efficiency.

13. When going down a hill, shift into a lower gear and use the engine braking effect.
When ascending a long grade, downshift the transaxle to a lower gear and reduce speed to reduce chances of engine overloading and/or overheating.
14. If you have to stop while going uphill, do not hold the vehicle in place by pressing on the accelerator. This can cause the automatic transaxle to overheat. Use the parking brake or footbrake.
15. If the transaxle shifts frequently while going up a hill, shift down one gear.

NOTE:

When towing check transaxle fluid more frequently.

**CAUTION:**

If overheating should occur when towing, (the temperature gauge reads near the red zone), taking the following actions may reduce or eliminate the problem.

1. Turn off the air conditioner.
2. Reduce highway speed.
3. Select a lower gear when going uphill.
4. When stopping, place the gear selector in park or neutral and idle the engine at a higher speed.

FarmaSOS.com

TRAILER CONNECTOR

C200A01CM-AAT

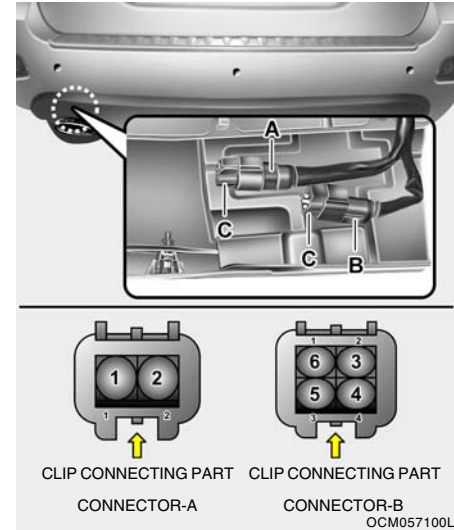

A : Power connector

B : Signal connector

C : Connector Cap

1 : Power supply for trailer lamp (30A/B+)

2 : Ground

3 : Signal (Right turn signal light)

4 : Signal (Tail light)

5 : Signal (Left turn signal light)

6 : Signal (Stop light)

The power connector (A) that is connected with a controller to operate the trailer lamp and the connector (B) used to judge whether the vehicle lamp operates properly is installed in the left bottom back of the vehicle.

You can use it, when needed.



CAUTION:

- o When using the trailer pack, open the cap(C) and then connect it to the connector. After using the connector, disconnect it and always put the cap(C) back on the corresponding connector. If the cap is not replaced, foreign elements such as dust or liquid may damage the vehicle.
- o You must use a separate controller to use the power connector(A) to operate the trailer lamp.
- o The connector B is only for the vehicle lamp. Therefore, do not use the connector B to operate the trailer lamp. It may blow out the fuse and damage the vehicle.
- o While the connector is connected to the trailer, make sure the connector wire does not go near the muffler. The heat from the muffler may damage the wire.

VEHICLE LOAD LIMIT

C190F01CM-AAT

Tire and Loading Information Label

Type A

TIRE AND LOADING INFORMATION/ PNEUS ET CHARGE INFORMATION				
SEATING CAPACITY		TOTAL 5	FRONT 2	REAR 3
NOMBRE DE SIÈGES		TOTAL 5	AVANT 2	ARRIÈRE 3
The combined weight of occupants and cargo should never exceed 420kg or 930lbs. Le poids combiné des occupants et du chargement ne doit jamais excéder 420kg ou 930lb.				
TIRE/ PNEU	SIZE/ DIMENSION	COLD TIRE PRESSURE/ PRESSION À FROID		SEE OWNERS MANUAL FOR ADDITIONAL INFORMATION CONSULTER LE GUIDE DU PROPRIÉTAIRE POUR OBTENIR DES RENSEIGNEMENTS ADDITIONNELS
FRONT/ AVANT	P235 / 70R16	210kPa, 30psi		
REAR/ ARRIÈRE	P235 / 70R16	210kPa, 30psi		
SPARE/ SECOURS	T165 / 90R17	420kPa, 60psi		

1030A01CM

Type B

TIRE AND LOADING INFORMATION/ PNEUS ET CHARGE INFORMATION				
SEATING CAPACITY		TOTAL 5	FRONT 2	REAR 3
NOMBRE DE SIÈGES		TOTAL 5	AVANT 2	ARRIÈRE 3
The combined weight of occupants and cargo should never exceed 420kg or 930lbs. Le poids combiné des occupants et du chargement ne doit jamais excéder 420kg ou 930lb.				
TIRE/ PNEU	SIZE/ DIMENSION	COLD TIRE PRESSURE/ PRESSION À FROID		SEE OWNERS MANUAL FOR ADDITIONAL INFORMATION CONSULTER LE GUIDE DU PROPRIÉTAIRE POUR OBTENIR DES RENSEIGNEMENTS ADDITIONNELS
FRONT/ AVANT	P235 / 60R18	210kPa, 30psi		
REAR/ ARRIÈRE	P235 / 60R18	210kPa, 30psi		
SPARE/ SECOURS	T165 / 90R17	420kPa, 60psi		

1030A02CM

Type C

TIRE AND LOADING INFORMATION/ PNEUS ET CHARGE INFORMATION				
SEATING CAPACITY		TOTAL 7	FRONT 2	REAR 5
NOMBRE DE SIÈGES		TOTAL 7	AVANT 2	ARRIÈRE 5
The combined weight of occupants and cargo should never exceed 506kg or 1120lbs. Le poids combiné des occupants et du chargement ne doit jamais excéder 506kg ou 1120lb.				
TIRE/ PNEU	SIZE/ DIMENSION	COLD TIRE PRESSURE/ PRESSION À FROID		SEE OWNERS MANUAL FOR ADDITIONAL INFORMATION CONSULTER LE GUIDE DU PROPRIÉTAIRE POUR OBTENIR DES RENSEIGNEMENTS ADDITIONNELS
FRONT/ AVANT	P235 / 70R16	210kPa, 30psi		
REAR/ ARRIÈRE	P235 / 70R16	210kPa, 30psi		
SPARE/ SECOURS	T165 / 90R17	420kPa, 60psi		

1030A03CM

Type D

TIRE AND LOADING INFORMATION/ PNEUS ET CHARGE INFORMATION				
SEATING CAPACITY		TOTAL 7	FRONT 2	REAR 5
NOMBRE DE SIÈGES		TOTAL 7	AVANT 2	ARRIÈRE 5
The combined weight of occupants and cargo should never exceed 506kg or 1120lbs. Le poids combiné des occupants et du chargement ne doit jamais excéder 506kg ou 1120lb.				
TIRE/ PNEU	SIZE/ DIMENSION	COLD TIRE PRESSURE/ PRESSION À FROID		SEE OWNERS MANUAL FOR ADDITIONAL INFORMATION CONSULTER LE GUIDE DU PROPRIÉTAIRE POUR OBTENIR DES RENSEIGNEMENTS ADDITIONNELS
FRONT/ AVANT	P235 / 60R18	210kPa, 30psi		
REAR/ ARRIÈRE	P235 / 60R18	210kPa, 30psi		
SPARE/ SECOURS	T165 / 90R17	420kPa, 60psi		

1030A04CM

The tire label located on the driver's side of the center pillar outer panel gives the original tire size, cold tire pressures recommended for your vehicle, the number of people that can be in your vehicle and vehicle capacity weight.

Vehicle capacity weight:

- o 5 passenger vehicle : 930 lbs (420 kg)
 - o 7 passenger vehicle : 1120 lbs (506 kg)
- Vehicle capacity weight is the maximum combined weight of occupants and cargo. If your vehicle is equipped with a trailer, the combined weight includes the tongue load.

Seating capacity:

- o 5 passenger vehicle
Total: 5 persons
(Front seat: 2 persons,
Rear seat: 3 persons)
- o 7 passenger vehicle
Total: 7 persons
(Front seat: 2 persons,
Rear seat: 3 persons
Third row seat: 2 persons)

Seating capacity is the maximum number of occupants including a driver, your vehicle may carry. However the seating capacity may be reduced based upon the weight of all of the occupants, and the weight of the cargo being carried or towed. Do not overload the vehicle as there is a limit to the total weight, or load limit including occupants and cargo, the vehicle can carry.

Towing capacity:

Towing capacity is the maximum trailer weight including its cargo weight, your vehicle can tow. See the section "Trailer or Vehicle Towing" for specifications about the trailer weight.

Cargo capacity:

The cargo capacity of your vehicle will increase or decrease depending on the weight and the number of occupants and the tongue load, if your vehicle is equipped with a trailer.

Steps for Determining Correct Load Limit

- (1) Locate the statement "The combined weight of occupants and cargo should never exceed XXX pounds" on your vehicle's placard.
- (2) Determine the combined weight of the driver and passengers that will be riding in your vehicle.

- (3) Subtract the combined weight of the driver and passengers from XXX kilograms or XXX pounds.
- (4) The resulting figure equals the available amount of cargo and luggage load capacity. For example, if the "XXX" amount equals 1400 lbs, and there will be five 150 lb. passengers in your vehicle, the amount of available cargo and luggage load capacity is 650 lbs. (1400-750 (5 x 150) = 650 lbs.)
- (5) Determine the combined weight of luggage and cargo being loaded on the vehicle. That weight may not safely exceed the available cargo and luggage load capacity calculated in Step 4.
- (6) If your vehicle will be towing a trailer, load from your trailer will be transferred to your vehicle. Consult this manual to determine how this reduces the available cargo and luggage load capacity of your vehicle.

Example 1

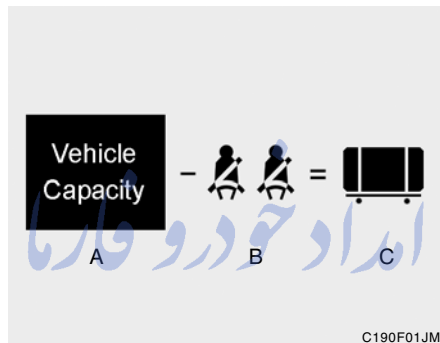

Item	Description	Total
A	Vehicle Capacity Weight	1400 lbs (635 kg)
B	Subtract Occupant Weight 150 lbs (68 kg) x 2	300 lbs (136 kg)
C	Available Cargo and Luggage weight	1100 lbs (498 kg)

Example 2

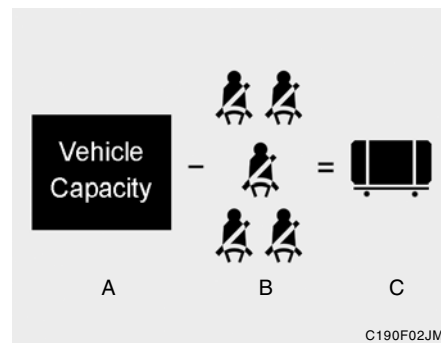

Item	Description	Total
A	Vehicle Capacity Weight	1400 lbs (635 kg)
B	Subtract Occupant Weight 150 lbs (68 kg) x 5	750 lbs (340 kg)
C	Available Cargo and Luggage Weight	650 lbs (295 kg)

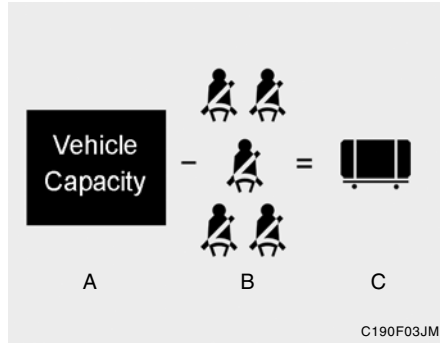
Example 3

Item	Description	Total
A	Vehicle Capacity Weight	1400 lbs (635 kg)
B	Subtract Occupant Weight 172 lbs (78 kg) x 5	860 lbs (390 kg)
C	Available Cargo Weight	540 lbs (245 kg)

Refer to your vehicle's tire and loading information label for specific information about your vehicle's capacity weight and seating positions. The combined weight of the driver, passengers and cargo should never exceed your vehicle's capacity weight.

امداد خودرو فارما

تلفن شبانه روزی: ۰۲۱-۸۸۶۲۰۸۵

FarmaSOS.com

C190G03JM-AAT

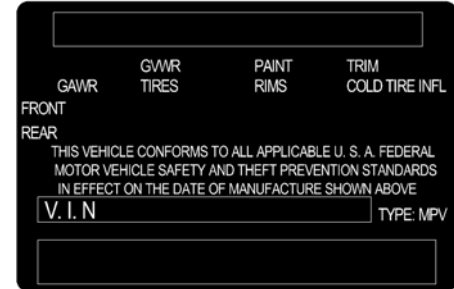
Compliance Label

C190G01JM

The compliance label is located on the driver's side of the center pillar outer panel.

The label shows the maximum allowable weight of the fully loaded vehicle. This is called the GVWR (Gross Vehicle Weight Rating). The GVWR includes the weight of the vehicle, all occupants, fuel and cargo.

This label also tells you the maximum weights that can be supported by the front and rear axles, called Gross Axle Weight Rating (GAWR). To find out the actual loads on your front and rear axles, you need to go to a weigh station and weigh your vehicle. Your dealer can help you with this. Be sure to spread out your load equally on both sides of the centerline.

**WARNING:**

- o Never exceed the GVWR for your vehicle, the GAWR for either the front or rear axle and vehicle capacity weight. Exceeding these ratings can cause an accident or vehicle damage. You can calculate the weight of your load by weighing the items (or people) before putting them in the vehicle. Be careful not to overload your vehicle.

**WARNING:**

- o Do not load your vehicle any heavier than the GVWR, either the maximum front or rear GAWR and vehicle capacity weight. If you do, parts, including tires on your vehicle can break, and it can change the way your vehicle handles and braking ability. This could cause you to lose control and crash. Also, overloading can shorten the life of your vehicle. تلفن شبانه روزی: 021-88888888

**WARNING:**

- o Overloading your vehicle can cause heat buildup in your vehicle's tires and possible tire failure that could lead to a crash.
- o Overloading your vehicle can cause increased stopping distances that could lead to a crash.
- o A crash resulting from poor handling vehicle damage, tire failure, or increased stopping distances could result in serious injury or death.

FarmaSOS.com

NOTE:

- o **Overloading your vehicle may cause damage. Repairs would not be covered by your warranty. Do not overload your vehicle.**
- o **Using heavier suspension components to get added durability might not change your weight ratings. Ask your dealer to help you load your vehicle the right way.**

The label will help you decide how much cargo and installed equipment your vehicle can carry.

If you carry items inside your vehicle – like suitcases, tools, packages, or anything else – they move as fast as the vehicle goes. If you have to stop or turn quickly, or if there is a crash, the items will keep going and can cause an injury if they strikes the driver or a passenger.

**WARNING:**

Items you carry inside your vehicle can strike and injure people in a sudden stop or turn, or in a crash.

- o **Put things in the cargo area of your vehicle. Try to spread the weight evenly.**
- o **Never stack items, like suitcases, inside the vehicle above the tops of the seats.**
- o **Do not leave an unsecured child restraint in your vehicle.**
- o **When you carry something inside the vehicle, secure it.**
- o **Do not drive with a seat folded down unless necessary.**

WHAT TO DO IN AN EMERGENCY

If the Engine will not Start	3-2
Jump Starting	3-3
If the Engine Overheats	3-4
Tire Pressure Monitoring System (TPMS)	3-5
Spare Tire	3-10
If You Have a Flat Tire	3-12
Changing a Flat Tire	3-12
If Your Car Must be Towed	3-18
Emergency Towing	3-20
If You Lose Your Keys	3-21

FarmaSOS.com

IF THE ENGINE WILL NOT START

D010A01A-AAT



WARNING:

If the engine will not start, do not push or pull the car to start it. This could result in a collision or cause other damage. In addition, push or pull starting may cause the catalytic converter to be overloaded and create a fire hazard.

D010B02A-AAT

If Engine Doesn't Turn Over or Turns Over Slowly

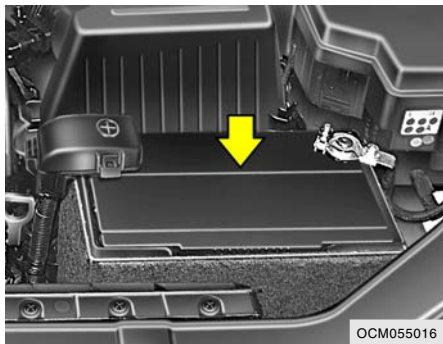

1. If your car has an automatic transaxle, be sure the gear selector lever is in "N" or "P" and the emergency brake is set.
2. Check the battery connections to be sure they are clean and tight.
3. Turn on the interior light. If the light dims or goes out when you operate the starter, the battery is discharged.
4. Check the starter connections to be sure they are securely tightened.
5. Do not push or pull the vehicle to start it. See instructions for "Jump Starting".

D010C02Y-AAT

If Engine Turns Over Normally but Does Not Start

1. Check fuel level.
2. With the key in the "OFF" position, check all connectors at ignition, coil and spark plugs. Reconnect any that may be disconnected or loose.
3. Check the fuel line in the engine compartment.
4. If the engine still does not start, call a Hyundai dealer or seek other qualified assistance.

D010D01CM-AAT

If Engine Stalls While Driving

1. Reduce your speed gradually, keeping a straight line. Move cautiously off the road to a safe place.
2. Turn on your emergency flashers.
3. Try to start the engine again. If your vehicle will not start, contact a Hyundai dealer or seek other qualified assistance.

If the Engine Stalls at a Crossroad and Crossing

If the engine stalls at a crossroad or crossing, set the shift lever in the N (Neutral) position and then push the vehicle to a safe place.

JUMP STARTING

D020A03A-AAT

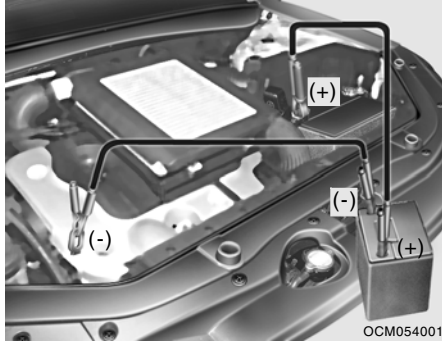

WARNING:

The gas produced by the battery during the jump-start operation is highly explosive. If these instructions are not followed exactly, serious personal injury and damage to the vehicle may occur! If you are not sure how to follow this procedure, seek qualified assistance. Automobile batteries contain sulfuric acid. This is poisonous and highly corrosive. When jump starting, wear protective glasses and be careful not to get acid on yourself, your clothing or on the car.

- o If you should accidentally get acid on your skin or in your eyes, immediately remove any contaminated clothing and flush the area with clear water for at least 15 minutes. Then promptly obtain medical attention. If you must be transported to an emergency facility, continue to apply water to the affected area with a sponge or cloth.
- o The gas produced by the battery during the jump-start operation is highly explosive. Do not smoke or allow a spark or an open flame in the vicinity.
- o The battery being used to provide the jump start must be 12-volt. If you cannot determine that it is a 12-volt battery, do not attempt to use it for the jump start.
- o To jump start a car with a discharged battery, follow this procedure exactly:
 1. If the booster battery is installed in another vehicle, be sure the two vehicles are not touching.
 2. Turn off all unnecessary lights and accessories in both vehicles.
 3. Attach the clamps of the jumper cable in the exact location shown on the illustration. First, attach one clamp of the jumper cable to the positive (+) post or cable of the discharged battery.

Then attach the other end of the same cable to the positive (+) post or cable of the booster battery. Next, using the other cable, attach one clamp to the negative (-) post or cable of the booster battery. Then attach the other end of that cable to a solid metal part of the engine of the vehicle with the discharged battery away from the battery. Do not connect the cable to any moving part.

4. Start the engine in the car with the booster battery and let it run for a few minutes. This will help to assure that the booster battery is fully charged. During the jumping operation, run the engine in this vehicle at about 2,000 rpm.
5. Start the engine in the car with the discharged battery using the normal starting procedure. After the engine starts, leave the jumper cables connected and let the engine run at fast idle or about 2,000 rpm for several minutes.
6. Carefully remove the jumper cables in the reverse order of attachment.

If you do not know why your battery became discharged (because the lights were left on, etc.), have the charging system checked by your Hyundai dealer.

IF THE ENGINE OVERHEATS

D030A02A-AAT

If your temperature gauge indicates overheating, you experience a loss of power, or hear loud pinging or knocking, the engine is probably too hot. If this happens, you should:

1. Pull off the road and stop as soon as it is safe to do so.
2. Place the gear selector lever in "P" (automatic), or neutral (manual transaxle) and set the parking brake. If the air conditioning is on, turn it off.
3. If engine coolant is running out under the car or steam is coming out from the hood, stop the engine. Do not open the hood until the coolant has stopped running or the steaming has stopped. If there is no visible loss of engine coolant and no steam, leave the engine running and check to be sure the engine cooling fan is operating. If the fan is not running, turn the engine off.
4. Check to see if the water pump drive belt is missing. If it is not missing, check to see that it is tight. If the drive belt seems to be satisfactory, check for coolant leaking from the radiator, hoses or under the car. (If the air conditioning had been in use, it is normal for cold water to be draining from it when you stop).



WARNING:

While the engine is running, keep hair, hands and clothing away from moving parts such as the fan and drive belts to prevent injury.

5. If the water pump drive belt is broken or engine coolant is leaking out, stop the engine immediately and call the nearest Hyundai dealer for assistance.



WARNING:

Do not remove the radiator cap when the engine is hot. This can allow coolant to be blown out of the opening and cause serious burns.

6. If you cannot find the cause of the overheating, wait until the engine temperature has returned to normal. Then, if coolant has been lost, carefully add coolant to the reservoir (page 6-7) to bring the fluid level in the reservoir up to the halfway mark.
7. Proceed with caution, keeping alert for further signs of overheating. If overheating happens again, call a Hyundai dealer for assistance.



CAUTION:

Serious loss of coolant indicates there is a leak in the cooling system and this should be checked as soon as possible by a Hyundai dealer.

TIRE PRESSURE MONITORING SYSTEM (TPMS)

C320A02CM-AAT

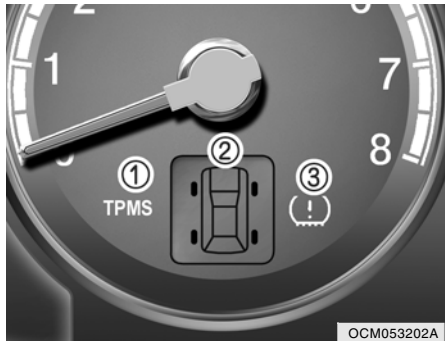

- (1) TPMS Malfunction Indicator
- (2) Low Tire Pressure Position telltale
- (3) Low Tire Pressure telltale

Each tire, including the spare, should be checked monthly when cold and inflated to the inflation pressure recommended by the vehicle manufacturer on the vehicle placard or tire inflation pressure label. (If your vehicle has tires of a different size than the size indicated on the vehicle placard or tire inflation pressure label, you should determine the proper tire inflation pressure for those tires.)

As an added safety feature, your vehicle has been equipped with a Tire Pressure Monitoring System (TPMS) that illuminates a low tire pressure telltale when one or more of your tires is significantly under-inflated. Accordingly, when the low tire pressure telltale illuminates, you should stop and check your tires as soon as possible, and inflate them to the proper pressure. Driving on a significantly under-inflated tire causes the tire to overheat and can lead to tire failure. Under-inflation also reduces fuel efficiency and tire tread life, and may affect the vehicle's handling and stopping ability.

Please note that the TPMS is not a substitute for proper tire maintenance, and it is the driver's responsibility to maintain correct tire pressure, even if under-inflation has not reached the level to trigger illumination of the TPMS low tire pressure telltale.

Your vehicle has also been equipped with a TPMS malfunction indicator to indicate when the system is not operating properly. The TPMS malfunction indicator is provided by a separate telltale, which displays the symbol "TPMS" when illuminated. When the malfunction indicator is illuminated, the system may not be able to detect or signal low tire pressure as intended. TPMS malfunctions may occur for a variety of reasons, including the installation of replacement or alternate tires or wheels on the vehicle that prevent the TPMS from functioning properly. Always check the TPMS malfunction telltale after replacing one or more tires or wheels on your vehicle to ensure that the replacement or alternate tires and wheels allow the TPMS to continue to function properly.

NOTE

If the TPMS, Low Tire Pressure and Position indicators does not illuminate for 3 seconds when the ignition key is turned to the “ON” position or engine is running, if it remains illuminated after coming on for approximately 3 seconds, take your car to your nearest authorized HYUNDAI dealer and have the system checked.

**Low tire pressure telltale****Low tire pressure position telltale**

When the tire pressure monitoring system warning indicators are illuminated, one or more of your tires is significantly under-inflated. The low tire pressure position telltale light will indicate which tire is significantly under-inflated by illuminating the corresponding position light.

If either telltale illuminates, immediately reduce your speed, avoid hard cornering and anticipate increased stopping distances. You should stop and check your tires as soon as possible. Inflate the tires to the proper pressure as indicated on the vehicle's placard or tire inflation pressure label located on the driver's side center pillar outer panel. If you cannot reach a service station or if the tire cannot hold the newly added air, replace the low pressure tire with the temporary spare tire.

The Low Tire Pressure and Position telltales will remain on until you have the low pressure tire repaired and replaced on the vehicle.

NOTE:

The temporary spare tire is not equipped with a tire pressure sensor.

**CAUTION:**

In winter or cold weather, the low tire pressure telltale may be illuminated if the tire pressure was adjusted to the recommended tire inflation pressure in warm weather. It does not mean your TPMS is malfunctioning because the decreased temperature leads to a proportional lowering of tire pressure.

When you drive your vehicle from a warm area to a cold area or from a cold area to a warm area, or the outside temperature significantly increases or decreases, you should check the tire inflation pressure and adjust the tires to the recommended tire inflation pressure.

**WARNING:**

Significantly low tire pressure makes the vehicle unstable and can contribute to loss of vehicle control and increased braking distances. Continued driving on low pressure tires will cause the tires to overheat and fail.

تلفن شبانه روزی: ۰۲۱-۸۸۶۲۰۸۵

FarmaSOS.com

TPMS

TPMS (Tire pressure monitoring system) malfunction

The TPMS malfunction indicator comes on and stays on when there is a problem with the Tire Pressure Monitoring System. If the Front Left sensor fails, the TPMS malfunction indicator illuminates, but if the Front Right, Rear Left, or Rear Right tire is under-inflated, the low tire pressure and position telltales may illuminate together with the TPMS malfunction indicator.

Have the system checked by an authorized Hyundai dealer as soon as possible to determine the cause of the problem.

NOTE:

- o **The TPMS malfunction indicator may be illuminated if the vehicle is moving around electric power supply cables or radios transmitter such as at police stations, government and public offices, broadcasting stations, military installations, airports, or transmitting towers, etc. This can interfere with normal operation of the Tire Pressure Monitoring System (TPMS).**
- o **The TPMS malfunction indicator may be illuminated if some electronic devices, such as notebook computer, are used in the vehicle. This can interfere with normal operation of the Tire Pressure Monitoring System (TPMS).**

Changing a tire with TPMS

If you have a flat tire, the Low Tire Pressure and Position telltales will come on. Have the flat tire repaired by an authorized Hyundai dealer as soon as possible or replace the flat tire with the temporary spare tire. NEVER use a puncture-repairing agent to repair and/or inflate a low pressure tire. The tire sealant can damage the tire pressure sensor. If used, you will have to replace the tire pressure sensor.

Each wheel is equipped with a tire pressure sensor mounted inside the tire behind the valve stem. You must use TPMS specific wheels. It is recommended that you always have your tires serviced by an authorized Hyundai dealer.

Even if you replace the low pressure tire with the temporary spare tire, the Low Tire Pressure and Position telltales will remain on until the low pressure tire is repaired and placed on the vehicle.

After you replace the low pressure tire with the temporary spare tire, the TPMS malfunction indicator may be illuminated after a few minutes, because the temporary spare tire does not have a sensor.

Once the low pressure tire is re-inflated to the recommended pressure and installed on the vehicle, the TPMS malfunction indicator and the low tire pressure and position telltales will extinguish within a few minutes.

If the indicators are not extinguished after a few minutes, please visit an authorized Hyundai dealer.

You may not be able identify a low tire by simply looking at it. Always use a good quality tire pressure gauge to measure the tire's inflation pressure. Please note that a tire that is hot (from being driven) will have a higher pressure measurement than a tire that is cold (from sitting stationary for at least 3 hours and driven less than 1 mile (1.6km) during that 3 hour period).

Allow the tire to cool before measuring the inflation pressure. Always be sure the tire is cold before inflating to the recommended pressure.

A cold tire means the vehicle has been sitting for 3 hours and driven for less than 1 mile (1.6km) in that 3 hour period.

NOTE:

Do not use any tire sealant if your vehicle is equipped with a Tire Pressure Monitoring System. The liquid sealant can damage the tire pressure sensors.



WARNING

- o **The TPMS cannot alert you to severe and sudden tire damage caused by external factors.**
- o **If you feel any vehicle instability, immediately take your foot off the accelerator and slowly move to a safe position off the road.**



WARNING:

Tampering with, modifying, or disabling the Tire Pressure Monitoring System (TPMS) components may interfere with the system's ability to warn the driver of low tire pressure conditions and/or TPMS malfunctions. Tampering with, modifying, or disabling the Tire Pressure Monitoring System (TPMS) components may void the warranty for that portion of the vehicle.

This device complies with Part 15 of the FCC rules.

Operation is subject to the following two conditions:

1. This device may not cause harmful interference, and
2. This device must accept any interference received, including interference that may cause undesired operation.



WARNING:

Changes or modifications not expressly approved by the party responsible for compliance could void the user's authority to operate the equipment.

SPARE TIRE

D040A01CM-AAT

Temporary Spare Tire

The following instructions for the temporary spare tire should be observed:

1. Check inflation pressure as soon as practical after installing the spare tire, and adjust to the specified pressure. The tire pressure should be periodically checked and maintained at the specified pressure while the tire is stored.

Spare Tire Pressure

Tire Size	T165/90R17
Inflation Pressure	60 psi (420 kPa)

2. The spare tire should only be used temporarily and should be returned to the spare tire carrier as soon as the original tire can be repaired or replaced.
3. Continuous use at speeds of over 50 mph (80 km/h) is not recommended.

4. As the temporary spare tire is specifically designed for your vehicle, it should not be used on any other vehicle.
5. The temporary spare tire should not be used on any other wheels, nor should standard tires, snow tires, wheel covers or trim rings be used with the temporary spare wheel. If such use is attempted, damage to these items or other car components may occur.
6. The temporary spare tire pressure should be checked once a month while the tire is stored.

**CAUTION:**

- o Do not use snow chains with your temporary spare tire.
- o Do not use more than one temporary spare tire at a time.
- o Do not tow a trailer while the temporary spare tire is installed.

**WARNING:**

The temporary spare tire is for emergency use only. Do not operate your vehicle on this temporary spare at speeds over 50 mph (80 km/h). The original tire should be repaired or replaced as soon as is possible to avoid failure of the spare possibly leading to personal injury or death.

D040B01CM-AAT

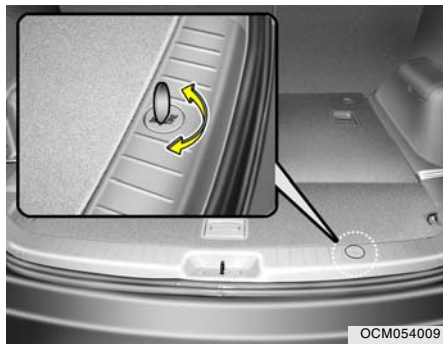
Handling the Spare Tire**To remove the spare tire**

1. Open the tail gate.
2. Remove the mounting bolt cover with a screwdriver or coin.

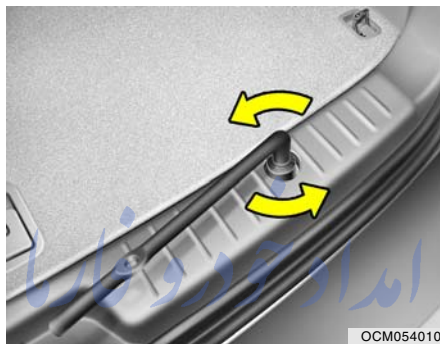

3. Turn the wheel nut wrench counter-clockwise until the spare tire reaches the ground.



4. Pull out the spare tire and remove the retainer from the center of spare tire.

FarmaSOS.com

IF YOU HAVE A FLAT TIRE

D050A02A-AAT

If a tire goes flat while you are driving:

1. Take your foot off the accelerator pedal and let the car slow down while driving straight ahead. Do not apply the brakes immediately or attempt to pull off the road as this may cause a loss of control. When the vehicle has slowed to such a speed that it is safe to do so, brake carefully and pull off the road. Drive off the road as far as possible and park on firm, level ground. If you are on a divided highway, do not park in the median area between the two traffic lanes.
2. When the car is stopped, turn on your emergency hazard flashers, set the parking brake and put the transaxle in "P" (automatic) or reverse (manual transaxle).
3. Have all passengers get out of the vehicle. Be sure they all get out on the side of the vehicle that is away from traffic.
4. Change the tire following the instructions provided on the following pages.

CHANGING A FLAT TIRE

D060A020-AAT



The procedure described on the following pages can be used to rotate tires as well as to change a flat tire. When preparing to change a flat tire, check to be sure the gear selector lever is in "P" (automatic transaxle) or reverse gear (manual transaxle) and that the parking brake is set, then:



WARNING:

Your vehicle is equipped with tires designed to provide for safe ride and handling capability.

Do not use a size and type of tire and wheel that is different from the one that is originally installed on your vehicle. It can affect the safety and performance of your vehicle, which could lead to handling failure or rollover and serious injury.

When replacing the tires, be sure to install all four tires and wheel to wheels of the same size, type, tread, brand and load-carrying capacity. If you nevertheless decide to equip your vehicle with any tire/wheel combination not recommended by Hyundai for off-road driving, you should not use these tires for highway driving.

D060B02O-AAT

1. Obtain Spare Tire and Tool

Remove the spare tire and remove the jack and tool bag from the luggage compartment.

NOTE:

The spare tire is located underneath the car.

D060C02A-AAT

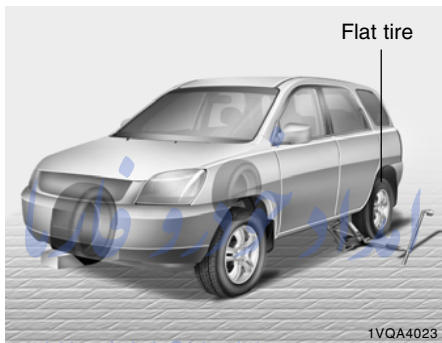
2. Block the Wheel

Block the wheel that is diagonally opposite from the flat to keep the vehicle from rolling when the vehicle is raised on the jack.

D060D01A-AAT

3. Loosen Wheel Nuts

The wheel nuts should be loosened slightly before raising the car. To loosen the nuts, turn the wrench handle counterclockwise. When doing this, be sure that the socket is seated completely over the nut so it cannot slip off. For maximum leverage, position the wrench so the handle is to the left as shown in the drawing. Then, while holding the wrench near the end of the handle, push down on it with steady pressure. Do not remove the nuts at this time. Just loosen them about one-half turn.

D060E01A-AAT

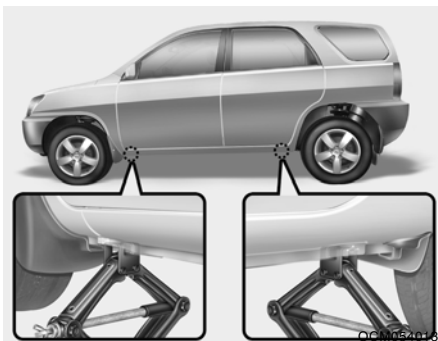
4. Put the Jack in Place

The base of the jack should be placed on firm, level ground. The jack should be positioned as shown in the drawing.

D060F03E-AAT

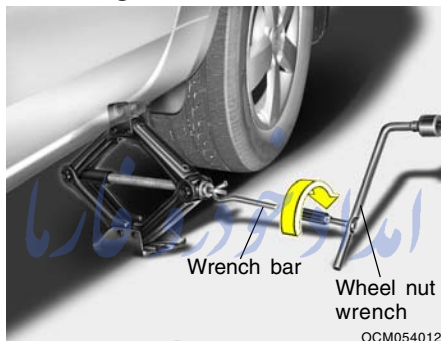
5. Raising the vehicle

After inserting the wrench bar into the wheel nut wrench, install the wrench bar into the jack as shown in the drawing. To raise the vehicle, turn the wheel nut wrench clockwise. As the jack begins to raise the vehicle, double check that it is properly positioned and will not slip. If the jack is on soft ground or sand, place a board, brick, flat stone or other object under the base of the jack to keep it from sinking.

Raise the car high enough so that the fully inflated spare tire can be installed. To do this, you will need more ground clearance than is required to remove the flat tire.

**WARNING:**

Do not get under the vehicle when it is supported by the jack! This is very dangerous as the vehicle could fall and cause serious injury or death. No one should stay in the vehicle while the jack is being used.

D060G01JM-AAT

6. Changing Wheels



Loosen the wheel nuts and remove them. Slide the wheel off the studs and lay it flat so it cannot roll away. To put the wheel on the hub, pick up the spare tire, line up the holes with the studs and slide the wheel onto them. If this is difficult, tip the wheel slightly and get the top hole in the wheel lined up with the top stud. Then jiggle the wheel back and forth until the wheel can be slid over the other studs.



! **WARNING:**
 If the vehicle has been driven recently, some pieces may be very hot. Use caution.

! **WARNING:**
 Wheels and wheel covers may have sharp edges. Handle them carefully to avoid possible severe injury. Before putting the wheel into place, be sure that there is nothing on the hub or wheel (such as mud, tar, gravel, etc.) that interferes with the wheel from fitting solidly against the hub. If there is, remove it. If there is not good contact on the mounting surface between the wheel and hub, the wheel nuts could come loose and cause the loss of a wheel. Loss of a wheel may result in loss of control of the vehicle. This may cause serious injury or death.

D060H02O-AAT

7. Reinstall Wheel Nuts

To reinstall the wheel, hold it on the studs, put the wheel nuts on the studs and tighten them finger tight. The nuts should be installed with their small diameter ends directed inward. Jiggle the tire to be sure it is completely seated, then tighten the nuts as much as possible with your fingers again.

D060I01E-AAT

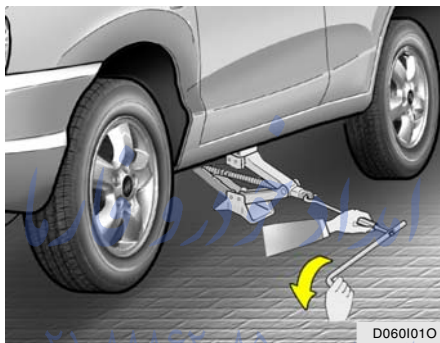
8. Lower Vehicle and Tighten Nuts

Lower the car to the ground by turning the wheel nut wrench counterclockwise.

تلفن شبانه روزی: ۰۲۱-۸۷۷۲۰۸۵
 ParmaSOS.com



Then position the wrench as shown in the drawing and tighten the wheel nuts. Be sure the socket is seated completely over the nut. Do not stand on the wrench handle or use an extension pipe over the wrench handle.

Go around the wheel tightening every other nut until they are all tight. Then double-check each nut for tightness. After changing wheels, have a technician tighten the wheel nuts to their proper torque as soon as possible.

Wheel nut tightening torque:

Steel wheel & aluminium alloy wheel*:
65-80 lb.ft (900-1,100 kg.cm)

* : if installed

D060J01CM-AAT

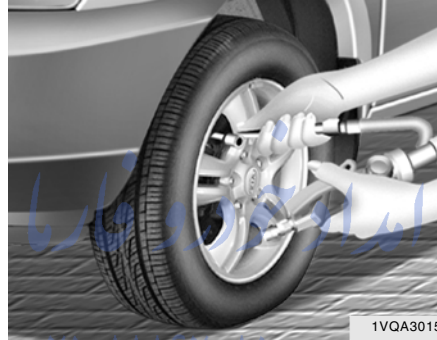
After Changing Wheels

If you have a tire gauge, remove the valve cap and check the air pressure. If the pressure is lower than recommended, drive slowly to the nearest service station and inflate to the correct pressure. If it is too high, adjust it until it is correct. Always reinstall the valve cap after checking or adjusting tire pressure. If the cap is not replaced, dirt and moisture could get into the valve core and cause air leakage. If you lose a valve cap, buy another and install it as soon as possible.

After you have changed wheels, always secure the flat tire in its place and return the jack and tools to their proper storage locations.

IF YOUR VEHICLE MUST BE TOWED

D080A01CM-AAT

If your vehicle has to be towed, it should be done by your Hyundai dealer or a commercial tow truck service. This will help assure that your vehicle is not damaged in towing. Also, professionals are generally aware of local laws governing towing. In any case, rather than risk damage to your car, it is suggested that you show this information to the tow truck operator. Be sure that a safety chain system is used and that all local laws are observed.

It is recommended that your vehicle be towed with a wheel lift and dollies or flatbed equipment with all the wheels off the ground.



CAUTION:

- o Your vehicle can be damaged if towed incorrectly!
- o Be sure the transaxle is in neutral.
- o When the engine will not start, be sure the steering is unlocked by placing the key in the "ACC" position.

D080B020-GAT

Towing a 2 Wheel Drive Vehicle

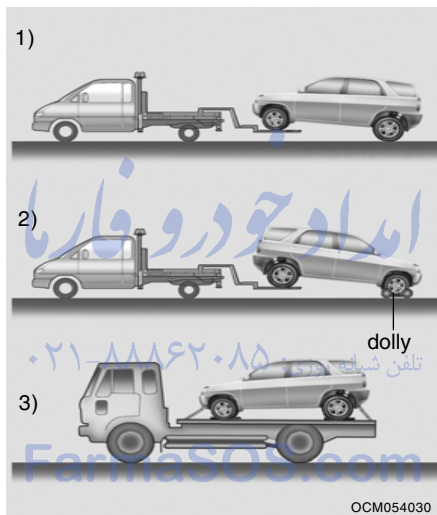

Your vehicle can be towed by a wheel lift type truck (1), (2) or flatbed equipment (3).



CAUTION:

- o When towing the vehicle, take care not to cause damage to the bumper or underbody of the vehicle.

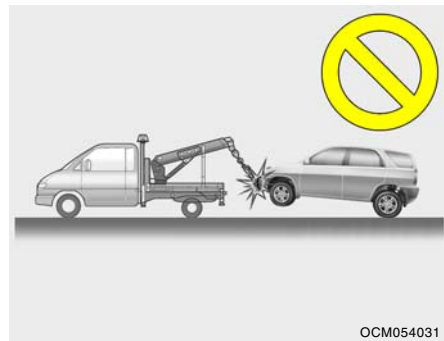

- o Do not tow with a sling type truck as this may cause damage to the bumper or underbody of the vehicle.

- 1) If the vehicle is being towed with the rear wheels on the ground, be sure the parking brake is released.

NOTE:

Before towing, check the level of the automatic transaxle fluid. If it is below the 75°C range on the dipstick, add fluid. If you cannot add fluid, a towing dolly must be used.

- 2) If any of the loaded wheels or suspension components are damaged or the vehicle is being towed with the front wheels on the ground, use a towing dolly under the front wheels.

- o Manual Transaxle:

If you do not use a towing dolly, place the ignition key in the "ACC" position and put the transaxle in "N (Neutral)".

**CAUTION:**

Do not tow with the key removed or in the "LOCK" position when towing from the rear without a towing dolly.

- o Automatic Transaxle:

Be sure to use a towing dolly under the front wheels.

**CAUTION:**

A vehicle with an automatic transaxle should never be towed from the rear with the front wheels on the ground. This can cause serious damage to the transaxle.

- 3) It is recommended that your vehicle be towed with all the wheels off the ground.

D080B01CM-AAT

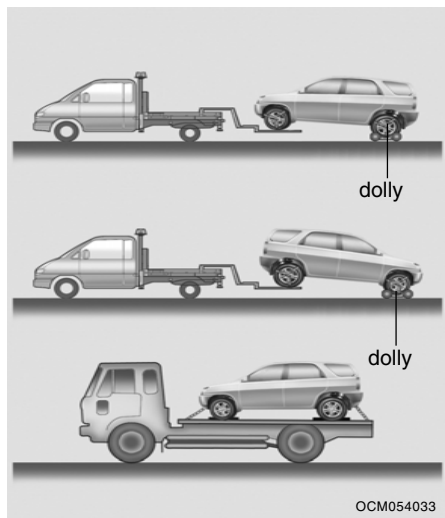
Towing a 4 Wheel Drive Vehicle

When towing a AWD vehicle, it must be towed by lifting all 4 wheels or using the towing dolly.

**CAUTION:**

- o The AWD vehicle should never be towed with the wheels on the ground. This can cause serious damage to the transaxle or the AWD system.
- o When towing the vehicle, take care not to cause damage to the bumper or underbody of the vehicle.

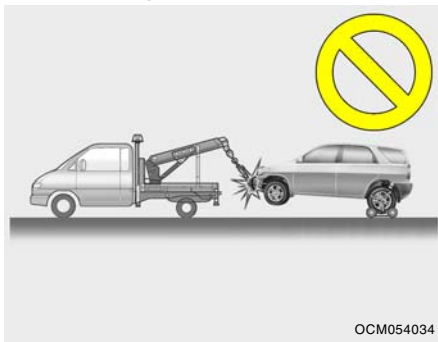

OCM054034

- o Do not tow with a sling type truck as this may cause damage to the bumper or underbody of the vehicle.

D080D01CM-AAT

Emergency Towing

Towing Hooks

OCM054016



Towing Hook

OCM054017

For emergency towing when no commercial tow vehicle is available. Do not attempt to tow your vehicle in this manner on any unpaved surface.

This could result in serious damage to your car. Nor should towing be attempted if the wheels, drive train, axles, steering or brakes are damaged. Before towing, be sure the transaxle is in neutral and the key is in "ACC" (with the engine off) or in the "ON" position (with the engine running). A driver must be in the towed car to steer it and operate the brakes.

When using the rear towing hook

- (1) To open the towing cover push it with your finger.
- (2) To mount the towing hook, rotate it clockwise.

**CAUTION**

It should be tightened firmly with your fingers until there is no more play in the towing hole. Towing hook is located in the luggage compartment.

IF YOU LOSE YOUR KEYS

- (3) Attach a tow cable, chain or strap to the towing hook on the rear bumper.

NOTE:

- o To avoid serious damage to your AWD vehicle, limit the towing to 10 mph (15 km/h) and not for more than 1 mile (1.5 km) at ANY TIME.
- o Before towing, check the level of the automatic transaxle fluid. If it is below the 75°C range on the dipstick, add fluid. If you cannot add fluid, a towing dolly must be used.

**CAUTION:**

If the Engine is not running, the power assist for the brakes and steering will not work so steering and braking will be much harder than usual.

**CAUTION:**

If the car is being towed with all four wheels on the ground, it can be towed only from the front. Be sure that the transaxle is in neutral. If your vehicle is equipped with an automatic transaxle, do not tow at speeds greater than 30 mph (50 km/h) and for more than 15 miles (25 km).

Be sure the steering is unlocked by placing the key in the "ACC" position. A driver must be in the towed vehicle to operate the steering and brakes.

D120A01CM-AAT

If you lose your keys, many Hyundai dealers can make you a new key if you have your key number. If you lock the keys inside your car and you cannot obtain a new key, many Hyundai dealers can use special tools to open the door for you.

Information about immobilizer keys (if installed) will be found on page 1-4.

FarmaSOS.com

CORROSION PREVENTION & APPEARANCE CARE

Corrosion Protection	4-2
To Help Prevent Corrosion	4-3
Washing and Waxing	4-4
Cleaning the Interior	4-5

امداد خودرو فارما

تلفن شبانه روزی: ۰۲۱-۸۸۸۶۲۰۸۵

FarmaSOS.com

4

CORROSION PROTECTION

E010A01A-AAT

Protecting Your Hyundai from Corrosion

By using the most advanced design and construction practices to combat corrosion, Hyundai produces cars of the highest quality. However, this is only part of the job. To achieve the long-term corrosion resistance your Hyundai can deliver, the owner's cooperation and assistance is also required.

E010B01A-AAT

Common Causes of Corrosion

The most common causes of corrosion on your car are:

- o Road salt, dirt and moisture that is allowed to accumulate underneath the car.
- o Removal of paint or protective coatings by stones, gravel, abrasion or minor scrapes and dents which leave unprotected metal exposed to corrosion.

E010C01A-AAT

High-Corrosion Areas

If you live in an area where your car is regularly exposed to corrosive materials, corrosion protection is particularly important. Some of the common causes of accelerated corrosion are road salts, dust control chemicals, ocean air and industrial pollution.

امداد خودرو فارما

تلفن شبانه روزی: ۰۲۱-۸۸۶۲۰۸۵

FarmaSOS.com

E010D01A-AAT

Moisture Breeds Corrosion

Moisture creates the conditions in which corrosion is most likely to occur. For example, corrosion is accelerated by high humidity, particularly when temperatures are just above freezing. In such conditions, the corrosive material is kept in contact with the car surfaces by moisture that is slow to evaporate.

Mud is particularly corrosive because it is slow to dry and holds moisture in contact with the vehicle. Although the mud appears to be dry, it can still retain the moisture and promote corrosion.

High temperatures can also accelerate corrosion of parts that are not properly ventilated so the moisture can be dispersed. For all these reasons, it is particularly important to keep your car clean and free of mud or accumulations of other materials. This applies not only to the visible surfaces but particularly to the underside of the car.

TO HELP PREVENT CORROSION

E020A01A-AAT

You can help prevent corrosion from getting started by observing the following:

E020B01A-AAT

Keep Your Car Clean

The best way to prevent corrosion is to keep your car clean and free of corrosive materials. Attention to the underside of the car is particularly important.

- o If you live in a high-corrosion area — where road salts are used, near the ocean, areas with industrial pollution, acid rain, etc.—, you should take extra care to prevent corrosion. In winter, hose off the underside of your car at least once a month and be sure to clean the underside thoroughly when winter is over.
- o When cleaning underneath the car, give particular attention to the components under the fenders and other areas that are hidden from view. Do a thorough job; just dampening the accumulated mud rather than washing it away will accelerate corrosion rather than prevent it.

Water under high pressure and steam are particularly effective in removing accumulated mud and corrosive materials.

- o When cleaning lower door panels, rocker panels and frame members, be sure that drain holes are kept open so that moisture can escape and not be trapped inside to accelerate corrosion.

امداد خودرو فارما

E020C02A-AAT

Keep Your Garage Dry

Don't park your car in a damp, poorly ventilated garage. This creates a favorable environment for corrosion. This is particularly true if you wash your car in the garage or drive it into the garage when it is still wet or covered with snow, ice or mud. Even a heated garage can contribute to corrosion unless it is well ventilated so moisture is dispersed.

E020D02A-AAT

Keep Paint and Trim in Good Condition

Scratches or chips in the finish should be covered with "touch-up" paint as soon as possible to reduce the possibility of corrosion. If bare metal is showing through, the attention of a qualified body and paint shop is recommended.

Bird droppings : Bird droppings are highly corrosive and may damage painted surfaces in just a few hours. Always remove bird droppings as soon as possible.

E020E01A-AAT

Don't Neglect the Interior

Moisture can collect under the floor mats and carpeting to cause corrosion. Check under the mats periodically to be sure the carpeting is dry. Use particular care if you carry fertilizers, cleaning materials or chemicals in the car.

These should be carried only in proper containers and any spills or leaks should be cleaned up, flushed with clear water and thoroughly dried.

WASHING AND WAXING

E030A02A-AAT

Washing Your Hyundai

Never wash your car when the surface is hot from being in the sun. Always wash your car in the shade.

Wash your car frequently. Dirt is abrasive and can scratch the paint if it is not removed. Air pollution or acid rain may damage the paint and trim through chemical action if pollutants are allowed to remain in contact with the surface. If you live near the ocean or in an area where road salts or dust control chemicals are used, you should pay particular attention to the underside of the car. Start by rinsing the car to remove dust and loose dirt. In winter, or if you have driven through mud or muddy water, be sure to thoroughly clean the underside as well. Use a hard direct stream of water to remove accumulations of mud or corrosive materials. Use a good quality car-washing solution and follow the manufacturer's directions on the package. These are available at your Hyundai dealer or auto parts outlet. Don't use strong household detergents, gasoline, strong solvents or abrasive cleaning powders as these may damage the finish.

Use a clean sponge or cloth, rinse it frequently and don't damage the finish by rubbing too hard. For stubborn spots, dampen them frequently and remove them a little at a time.

To clean whitewall tires, use a stiff brush or soapy steel-wool scouring pad.

To clean plastic wheel covers, use a clean sponge or soft cloth and water.

To clean cast aluminum alloy wheels, use a mild soap or neutral detergent. Do not use abrasive cleaners. Protect the bare-metal surfaces by cleaning, polishing and waxing. Because aluminum is subject to corrosion, be sure to give aluminum alloy wheels special attention in winter. If you drive on salted roads, clean the wheels thoroughly afterwards.

After washing, be sure to rinse thoroughly. If soapy water dries on the finish, streaking will result.

When the weather is warm and the humidity low, you may find it necessary to rinse each section immediately after washing to avoid streaking.

After rinsing, dry the car using a damp chamois or soft, absorbent cloth. The reason for drying the car is to remove water from the car so it will dry without water spots. Don't rub, this can damage the finish.

If you find any nicks or scratches in the paint, use touch-up paint to cover them to prevent corrosion. To protect the paintwork of the car against corrosion, you must clean your Hyundai (at least once a month). Give special attention to the removal of salt, mud and other substances on the underside of the splashboards of the car. Make sure that the outlets and the underside of the doors are open. Paint damage can be caused by small accumulation of tar, industrial precipitation, tree resin, insects and bird droppings, when not removed immediately. If water alone is not strong enough to remove the accumulated dirt, use a mild car washing solution. Be sure to rinse the surface after washing to remove the solution. Never allow the solution to dry on the painted surfaces.

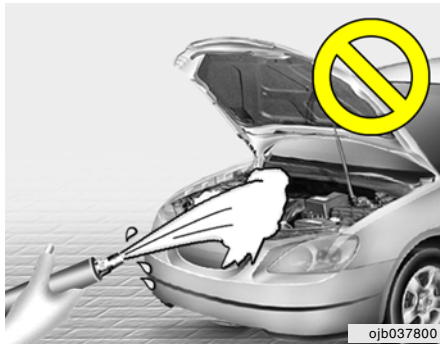
**CAUTION:**

- o **Water washing in the engine compartment including high pressure water washing may cause the failure of electrical circuits located in the engine compartment.**
- o **Never allow water or other liquids to come in contact with electrical/electronic components inside the vehicle as this may damage them.**

E030B01A-AAT

Spot Cleaning

Don't use gasoline, strong solvents or corrosive cleaning agents. These can damage the finish of the car. To remove road tar, use turpentine on a clean, soft cloth. Be gentle.

To remove dead insects or tree sap, use warm water and mild soap or car-washing solution. Soak the spot and rub gently. If the paint has lost its luster, use a commercial car-cleaning polish.

E030C01A-AAT

Polishing and Waxing

Always wash and dry the car before polishing or waxing or using a combination cleaner and wax. Use a good quality commercial product and follow the manufacturer's directions on the container. Polish and wax the bright trim pieces as well as the paint.

E030D01A-AAT

When to Wax Again

You should polish and wax the car again when water no longer beads on a clean surface but spreads out over a larger area.

E030E01A-AAT

Maintaining Bumpers

Special precautions must be observed to preserve the appearance of the bumpers on your Hyundai. They are:

- o Be careful not to spill battery electrolyte or hydraulic brake fluid on the bumpers. If you do, wash it off immediately with clear water.
- o Be gentle when cleaning the bumper surfaces. They are made of soft plastic and the surface can be damaged if mistreated. Do not use abrasive cleaners. Use warm water and mild soap or car-washing solution.
- o Do not expose the bumpers to high temperatures. For example, if you have your car repainted, do not leave the bumpers on the car if the car is going to be placed in a high-temperature paint booth.

CLEANING THE INTERIOR

E040A01A-AAT

Cleaning the upholstery and interior trim

Vinyl

Remove dust and loose dirt from vinyl with a whisk broom or vacuum cleaner. Clean vinyl surfaces with a vinyl cleaner.

Fabric

Remove dust and loose dirt from fabric with a whisk broom or vacuum cleaner. Clean with a mild soap solution recommended for upholstery or carpets. Remove fresh spots immediately with a fabric spot cleaner. If fresh spots do not receive immediate attention, the fabric can be stained and its color can be affected. Also, its fire-resistant properties can be reduced if the material is not properly maintained.



CAUTION:

Using anything but recommended cleaners and procedures may affect the fabric's appearance and fire-resistant properties.

E040B01A-AAT

To Clean the Leather Upholstery (If installed)

In the normal course of use, leather upholstered surfaces will, like any material, pick-up dust and dirt. This dust and dirt must be cleaned off or it may work into the surface of the leather, causing damage.

Fine leather needs care, and should be cleaned when necessary. Washing leather thoroughly with soap and water will keep your leather lustrous, beautiful and ensure you have many years of wear.

Take a piece of cheese cloth and using any mild soap and lukewarm water, work up a good lather. Thoroughly wash the leather. Wipe clean with a slightly damp cloth and dry with soft cloth. Do this as often as the leather becomes soiled.

During tanning operations, sufficient oils are incorporated through processing that none need be applied during the life of the leather. Oil applied to the finished surface will in no way help the leather and may do more harm than good. Varnishes and furniture polishes should never be used under any conditions.

E040C01A-AAT

Cleaning the Carpets

Use a foam-type carpet cleaner. Cleaners of this type are available in aerosol cans in liquid form or powder. Read the instructions and follow them exactly. Using a vacuum cleaner with the appropriate attachment, remove as much dirt from the carpets as possible. Apply the foam following the manufacturer's directions, then rub in overlapping circles. Do not add water. These cleaners work best when the carpet is kept as dry as possible.

E040D01A-AAT

Cleaning the Seat Belts

To clean the seat belts, use a cloth or sponge with mild soap or detergent and warm water. Do not use strong detergents, dye, bleach or abrasive materials on the seat belts as this may weaken the fabric. While cleaning the belts, inspect them for excessive wear, cuts, fraying or other signs of damage and replace them if necessary.

ANY QUESTIONS?

E040E01A-AAT

Cleaning the Windows

You may use any household window cleaner on the windows. However, when cleaning the inside of the rear window be careful not to damage the rear window defroster wiring.

E050A01A-AAT

If you have any questions about the care of your car, consult your Hyundai dealer.

امداد خودرو فارما

تلفن شبانه روزی: ۰۲۱-۸۸۸۶۲۰۸۵

FarmaSOS.com

VEHICLE MAINTENANCE REQUIREMENTS

Maintenance Intervals	5-2
Scheduled Maintenance	5-4
Maintenance under Severe Usage Conditions	5-6
Explanation of Scheduled Maintenance Items	5-7
California Perchlorate Notice	5-10

امداد خودرو فارما

تلفن شبانه روزی: ۰۲۱-۸۸۸۶۲۰۸۵

FarmaSOS.com

5

5

MAINTENANCE INTERVALS

F010A01A-AAT

Service Requirements

To ensure that you receive the greatest number of miles of satisfying operation from your Hyundai, certain maintenance procedures must be performed. Although careful design and engineering have reduced these to a minimum, those that are required are of the utmost importance.

It is your responsibility to have these maintenance procedures performed to comply with the terms of the warranties covering your new Hyundai. The Owner's Handbook supplied with your new vehicle provides further information about these warranties.

F010B01A-AAT

Maintenance Requirements

The maintenance required for your Hyundai can be divided into three main areas:

- o Specified scheduled procedures
- o General checks
- o Do-it-yourself maintenance

امداد خودرو فارما

تلفن شبانه روزی: ۰۲۱-۸۸۶۲۰۸۵

FarmaSOS.com

F010C01A-AAT

Specified Scheduled Procedures

These are the procedures such as inspections, adjustments and replacements that are listed in the maintenance charts starting on page 5-4. These procedures must be performed at the intervals shown in the maintenance schedule to assure that your warranty remains in effect. Although it is strongly recommended that they be performed by the trained technicians at your Hyundai dealer, these procedures may be performed at any qualified service facility. It is suggested that genuine Hyundai service parts be used for any required repairs or replacements. Other parts of equivalent quality such as engine oil, engine coolant, manual or auto transaxle oil, brake fluid and so on which are not supplied by Hyundai Motor Company or its distributor may be used without affecting your warranty coverage but you should always be sure these are equivalent to the quality of the original Hyundai parts. Your Owner's Handbook provides further information about your warranty coverage.

SCHEDULED MAINTENANCE REQUIREMENTS

F010D02A-AAT

General Checks

These are the regular checks you should perform when you drive your Hyundai or you fill the fuel tank. A list of these items will be found on page 6-5.

F010E01A-AAT

Do-It-Yourself Maintenance

If you are mechanically inclined, own a few tools that are required and want to take the time to do so, you can inspect and service a number of items. For more information about doing it yourself, see Section 6.

F010F01A-AAT

A Few Tips

- o Whenever you have your Hyundai serviced, keep copies of the service records in your glovebox. This will help ensure that you can document that the required procedures have been performed to keep your warranties in effect. This is especially important when service is not performed by an authorized Hyundai dealer.
- o If you choose to do your own maintenance and repairs, you may find it helpful to have an official Hyundai Shop Manual. A copy of this publication may be purchased at your Hyundai dealer's parts department.

F020A02Y-AAT

- o Inspection should be performed any time a malfunction is experienced or suspected.
- o Receipts for all emission control system services should be retained to demonstrate compliance with conditions of the emissions system warranty.
- o After 120 months or 150,000 miles (240,000 km), continue to follow the prescribed maintenance intervals.
- o For severe usage maintenance requirements, see page 5-6 of this section.

FarmaSOS.com

SCHEDULED MAINTENANCE

F030A01A-AAT

The following maintenance services must be performed to ensure good emission control and performance. Keep receipts for all vehicle emission services to protect your warranty. Where both mileage and time are shown, the frequency of service is determined by whichever occurs first.

F030B01CM-AAT

R : Replace I : Inspect and, after Inspection, clean, adjust, repair or replace if necessary.

No.	DESCRIPTION	MILES X 1000																			
		7.5	15	22.5	30	37.5	45	52.5	60	67.5	75	82.5	90	97.5	105	112.5	120	127.5	135	142.5	150
		KILOMETERS X 1000																			
		MONTHS																			
EMISSION CONTROL ITEMS																					
1	ENGINE OIL AND FILTER	R	R	R	R	R	R	R	R	R	R	R	R	R	R	R	R	R	R	R	R
2	FUEL FILTER									R							R				
3	FUEL LINES, FUEL HOSES AND CONNECTIONS	I	I	I	I	I	I	I	I	I	I	I	I	I	I	I	I	I	I	I	I
4	VACUUM HOSES								I						I						
5	CRANKCASE VENTILATION HOSE								I					I			I				I
6	VAPOR HOSE AND FUEL FILLER CAP					I				I				I			I				I
7	AIR CLEANER FILTER		I		R		I		R		I		R		I		R		I		R
8	FUEL TANK AIR FILTER (IF INSTALLED)		I		R		I		R		I		R		I		R		I		R
9	SPARK PLUGS (IRIDIUM COATED) *1													R							
10	VALVE CLEARANCE See Note *2	INSPECT AND ADJUST EVERY 60,000 MILES (96,000 KM) OR 48 MONTHS																			

Note : *1. Spark plugs should be long-reach type when replaced (2.7 only)
 *2. Inspect for excessive tappet noise and/or engine vibration and adjust if necessary.

F030C01CM-AAT

R : Replace I : Inspect and, after inspection, clean, adjust, repair or replace if necessary

No.	DESCRIPTION	MILES X 1000	7.5	15	22.5	30	37.5	45	52.5	60	67.5	75	82.5	90	97.5	105	112.5	120	127.5	135	142.5	150	
		KILOMETERS X 1000	12	24	36	48	60	72	84	96	108	120	132	144	156	168	180	192	204	216	228	240	
		MONTHS	6	12	18	24	30	36	42	48	54	60	66	72	78	84	90	96	102	108	114	120	
GENERAL ITEMS																							
1	DRIVE BELT	2.7 V6 (ALT, P/STR'G, A/CON)				I																	
		3.3 V6 (ALT, P/STR'G, A/CON)				I																	
2	COOLANT																						
3	TIMING BELT (ONLY 2.7 V6)																						
4	MANUAL TRANSAXLE FLUID																						
5	AUTOMATIC TRANSAXLE FLUID			I																			
6	BRAKE FLUID					I																	
7	BRAKE HOSES AND LINES			I																			
8	PARKING BRAKE																						
9	BRAKE PADS, CALIPERS AND ROTORS (FRONT, REAR)																						
10	EXHAUST PIPE AND MUFFLER			I																			
11	SUSPENSION MOUNTING BOLTS		I	I	I	I	I	I	I	I	I	I	I	I	I	I	I	I	I	I	I	I	I
12	STEERING GEAR BOX, LINKAGE & BOOTS / LOWER ARM BALL JOINT																						
13	POWER STEERING PUMP, BELT AND HOSES																						
14	DRIVESHAFTS AND BOOTS			I																			
15	AIR CONDITIONING REFRIGERANT			I																			
16	CLIMATE CONTROL AIR FILTER (FOR EVAPORATOR AND BLOWER UNIT)																						
17	TRANSFER CASE OIL (AWD)																						
18	REAR AXLE OIL (AWD)																						
19	PROPELLER SHAFT (AWD)			I																			

Note : *1. For the first time replace the coolant at 60,000 miles (96,000 km) or 60 months. After that replace it every 30,000 miles (48,000 km) or 24 months.

*2. Inspect every 37,500 miles (60,000 km) replace every 75,000 miles (120,000 km) or 60 months

*3. For every 12 months or 10,000 miles (15,000 km), whichever occurs first: "R"

MAINTENANCE UNDER SEVERE USAGE CONDITIONS

F040A02CM-AAT

The following items must be serviced more frequently on cars normally used under severe driving conditions. Refer to the chart below for the appropriate maintenance intervals.

R : Replace I : Inspect and, after inspection, clean, adjust, repair or replace if necessary

MAINTENANCE ITEM	MAINTENANCE OPERATION	MAINTENANCE INTERVALS	DRIVING CONDITION
ENGINE OIL AND FILTER	R	EVERY 3,000 MILES (4,800 KM) OR 3 MONTHS	A, B, C, D, E, F, G, H, I, K
AIR CLEANER FILTER	R	MORE FREQUENTLY	C, E
SPARK PLUGS	R	MORE FREQUENTLY	B, H
TIMING BELT (2.7 V6)	I	EVERY 25,000 MILES (40,000 KM)	D, E, F, G
	R	EVERY 50,000 MILES (80,000 KM) OR 48 MONTHS	
BRAKE PADS, CALIPERS AND ROTORS (Front, Rear)	I	MORE FREQUENTLY	C, D, G, H
PARKING BRAKE	I	MORE FREQUENTLY	C, D, G, H
STEERING GEAR BOX, LINKAGE & BOOTS/ LOWER ARM BALL JOINT	I	MORE FREQUENTLY	C, D, E, F, G
DRIVESHAFTS AND BOOTS	I	EVERY 7,500 MILES (12,000 KM) OR 6 MONTHS	C, E, F
MANUAL TRANSAXLE FLUID	R	EVERY 60,000 MILES (96,000 KM)	C, D, E, G, H, I, J
AUTOMATIC TRANSAXLE FLUID	R	EVERY 30,000 MILES (48,000 KM)	A, C, E, F, G, H, I
CLIMATE CONTROL AIR FILTER (FOR EVAPORATOR AND BLOWER UNIT)	R	MORE FREQUENTLY	C, E
TRANSFER CASE OIL (AWD) *1	R	EVERY 30,000 MILES (48,000 KM)	C, E, G, H, I, J
REAR AXLE OIL (AWD) *1	R	EVERY 60,000 MILES (96,000 KM)	C, E, G, H, I, J
PROPELLER SHAFT (AWD)	I	EVERY 7,500 MILES (12,000 KM) OR 6 MONTHS	C, E

*1. Transfer case Oil and Rear Axle Oil should be changed anytime they have been submerged in water.

EXPLANATION OF SCHEDULED MAINTENANCE ITEMS

SEVERE DRIVING CONDITIONS

- A - Repeatedly driving short distance of less than 5miles(8km) in normal temperature or less than 10miles(16km) in freezing temperature
- B - Extensive engine idling or low speed driving for long distances
- C - Driving on rough, dusty, muddy, unpaved, graveled or salt-spread roads
- D - Driving in areas using salt or other corrosive materials or in very cold weather
- E - Driving in sandy areas
- F - More than 50% driving in heavy city traffic during hot weather above 32°C (90°F)
- G - Driving in mountainous areas
- H - Towing a Trailer, or using a camper, or roof rack
- I - Driving as a patrol car, taxi, other commercial use or vehicle towing
- J - Driving over 100 MPH(170 Km/h)
- K - Frequently driving in stop-and-go conditions

F060M01A-AAT

o Engine Oil and Filter

The engine oil and filter should be changed at the intervals specified in the maintenance schedule. If the car is being driven in severe conditions, more frequent oil and filter changes are required.

F060C01A-AAT

o Fuel Filter

A clogged filter can limit the speed at which the vehicle may be driven, damage the emission system and cause hard starting. If an excessive amount of foreign matter accumulates in the fuel tank, the filter may require replacement more frequently. After installing a new filter, run the engine for several minutes, and check for leaks at the connections. Fuel filters should be installed by trained technicians.

F060B01A-AAT

o Drive Belts

Inspect all drive belts for evidence of cuts, cracks, excessive wear or oil saturation and replace if necessary. Drive belts should be checked periodically for proper tension and adjusted as necessary.

F060D01A-AAT

o Fuel Lines, Fuel Hoses and Connections

Check the fuel lines, fuel hoses and connections for leakage and damage. Have a trained technician replace any damaged or leaking parts immediately.

F060F010-AAT

o Vacuum Hoses

Inspect the surface of hoses for evidence of heat and/or mechanical damage. Hard and brittle rubber, cracking, tears, cuts, abrasions, and excessive swelling indicate deterioration. Particular attention should be paid to examine those hose surfaces nearest to high heat sources, such as the exhaust manifold.

Inspect the hose routing to assure that the hoses do not come in contact with any heat source, sharp edges or moving component which might cause heat damage or mechanical wear. Inspect all hose connections, such as clamps and couplings, to make sure they are secure, and that no leaks are present. Hoses should be replaced immediately if there is any evidence of deterioration or damage.

F065F010-AAT

o Crankcase Ventilation Hose

Inspect the surface of hose for evidence of heat and/or mechanical damage. Hard and brittle rubber, cracking, tears, cuts, abrasions, and excessive swelling indicate deterioration. Particular attention should be paid to examine that hose surface nearest to high heat sources, such as the exhaust manifold.

Inspect the hose routing to assure that the hose does not come in contact with any heat source, sharp edges or moving component which might cause heat damage or mechanical wear. Inspect all hose connections, such as clamps and couplings, to make sure they are secure, and that no leaks are present. Hose should be replaced immediately if there is any evidence of deterioration or damage.

F060G01A-AAT

o Vapor Hose and Fuel Filler Cap

The vapor hose and fuel filler cap should be inspected at those intervals specified in the maintenance schedule. Make sure that a new vapor hose or fuel filler cap is correctly replaced.

F060H01A-AAT

o Air Cleaner Filter

A Genuine Hyundai air cleaner filter is recommended when the filter is replaced.

F060J01A-AAT

o Spark Plugs

Make sure to install new spark plugs of the correct heat range.

F060E01A-AAT

o Timing Belt (2.7L V6 only)

Inspect all parts related to the timing belt for damage and deformation. Replace any damaged parts immediately.

F070C01A-AAT

o Coolant

The coolant should be changed at the intervals specified in the maintenance schedule.

F070E01CM-AAT

o Automatic Transaxle Fluid

The fluid level should be in the "75°C" range of the dipstick, after the engine and transaxle are at normal operating temperature. Check the automatic transaxle fluid level with the engine running and the transaxle in neutral, with the parking brake properly applied. Use HYUNDAI GENUINE ATF SP III, DIAMOND ATF SP III, SK ATF SP III or other brands meeting the SP III specification approved by Hyundai Motor Co. when adding or changing fluid. Using the wrong ATF may result in damage to the ATM.

F070F01A-AAT

o Brake Hoses and Lines

Visually check for proper installation, chafing, cracks, deterioration and any leakage. Replace any deteriorated or damaged parts immediately.

F070G02A-AAT

o Brake Fluid

Check brake fluid level in the brake fluid reservoir. The level should be between "MIN" and "MAX" marks on the side of the reservoir. Use only hydraulic brake fluid conforming to DOT 3 or DOT 4.

F070H01CM-AAT

o Parking Brake

Inspect the parking brake system including the parking brake lever (or the parking brake pedal) and cables. For detailed service procedures, refer to the Shop Manual.

FarmaSOS.com

F070J01A-AAT

o Brake Pads, Calipers and Rotors

Check the pads for excessive wear, discs for run out and wear, and calipers for fluid leakage.

F070K01A-AAT

o Exhaust Pipe and Muffler

Visually inspect the exhaust pipes, muffler and hangers for cracks, deterioration, or damage. Start the engine and listen carefully for any exhaust gas leakage. Tighten connections or replace parts as necessary.

F070L01A-AAT

o Suspension Mounting Bolts

Check the suspension connections for looseness or damage. Retighten to the specified torque.

F070M01A-AAT

o Steering Gear Box, Linkage & Boots/Lower Arm Ball Joint

With the vehicle stopped and engine off, check for excessive free-play in the steering wheel.

Check the linkage for bends or damage. Check the dust boots and ball joints for deterioration, cracks, or damage. Replace any damaged parts.

F070N01A-AAT

o Power Steering Pump, Belt and Hoses

Check the power steering pump and hoses for leakage and damage. Replace any damaged or leaking parts immediately. Inspect the power steering belt for evidence of cuts, cracks, excessive wear, oiliness and proper tension. Replace or adjust it if necessary.

F070P01A-AAT

o Driveshafts and Boots

Check the drive shafts, boots and clamps for cracks, deterioration, or damage. Replace any damaged parts and, if necessary, repack the grease.

F070Q01A-AAT

o Air Conditioning Refrigerant

Check the air conditioning lines and connections for leakage and damage. Check air conditioning performance according to the relevant shop manual if necessary.

CALIFORNIA PERCHLORATE NOTICE

F080A01NF-AAT

Perchlorate Material-special handling may apply, See www.dtsc.ca.gov/hazardouswaste/perchlorate.

Notice to California Vehicle Dismantlers: Perchlorate containing materials, such as airbag inflators, seatbelt pretensioners and keyless remote entry batteries, must be disposed of according to Title 22 California Code of Regulations Section 67384.10 (a).

تلفن شبانه روزی: ۰۲۱-۸۸۶۲۰۸۵

FarmaSOS.com

DO-IT-YOURSELF MAINTENANCE

Engine Compartment	6-2
General Checks	6-4
Checking the Engine Oil	6-5
Checking the Engine Coolant	6-7
Changing the Air Cleaner Filter	6-8
Windshield Wiper Blades	6-9
Checking the Transaxle Oil (Manual)	6-11
Checking the Transaxle Fluid (Automatic)	6-12
Checking the Brakes	6-14
Air Conditioning Care	6-15
Changing the Climate Control Air Filter	6-16
Checking and Replacing Fuses	6-17
Checking the Battery	6-20
Power Steering Fluid Level	6-23
Replacement of Light Bulbs	6-24
Bulb Wattage	6-31
Fuse Panel Description	6-32

6

2 ENGINE COMPARTMENT

G010B01CM-AAT

Gasoline Engine (2.7 V6)

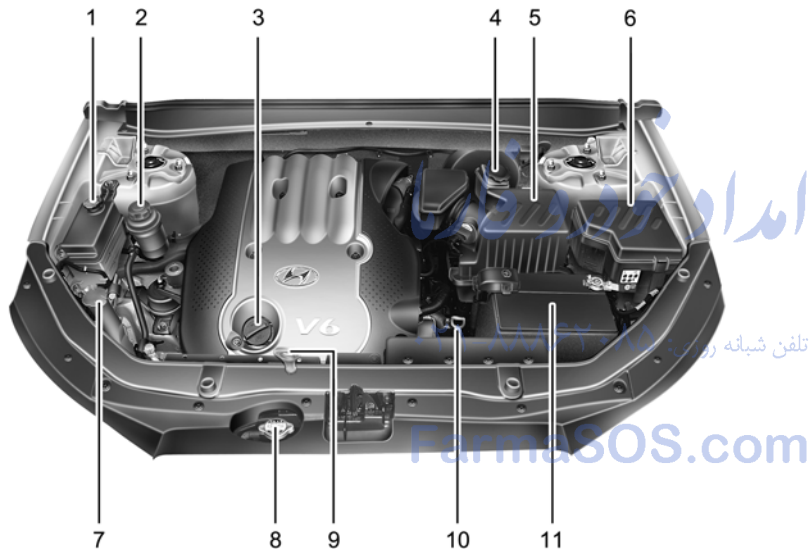
**CAUTION:**

When inspecting or servicing the engine, you should handle tools and other heavy objects carefully so that the plastic cover of the engine is not damaged.

1. Coolant reservoir cap
2. Power steering fluid reservoir
3. Engine oil filler cap
4. Brake fluid reservoir

5. Air cleaner
6. Fuse and relay box
7. Windshield washer fluid reservoir
8. Radiator cap

9. Engine oil level dipstick
10. Automatic transaxle fluid level dipstick (if installed)
11. Battery

OCM055100L

G010C01CM-AAT

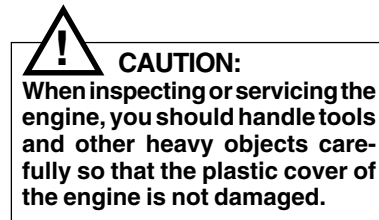
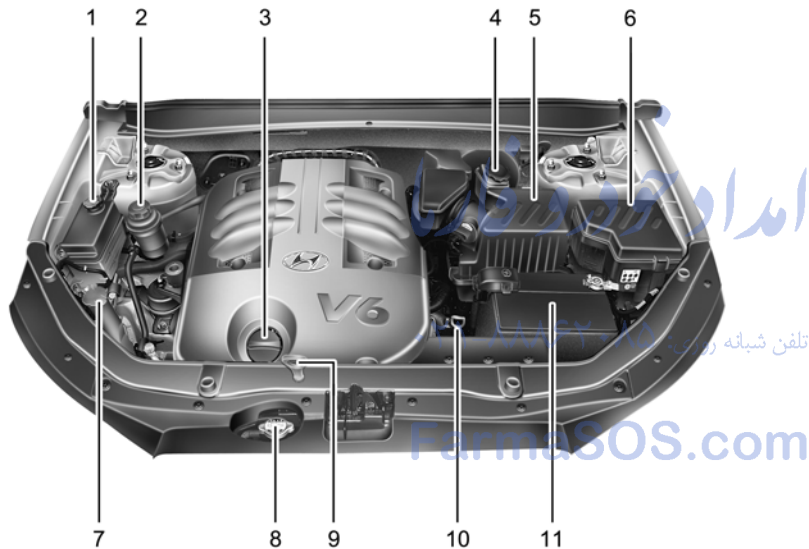
Gasoline Engine (3.3 V6)

OCM055102A

1. Coolant reservoir cap
2. Power steering fluid reservoir
3. Engine oil filler cap
4. Brake fluid reservoir

5. Air cleaner
6. Fuse and relay box
7. Windshield washer fluid reservoir
8. Radiator cap

9. Engine oil level dipstick
10. Automatic transaxle fluid level dipstick
(if installed)
11. Battery

GENERAL CHECKS

G020A01A-AAT

Engine Compartment

The following should be checked regularly:

- o Engine oil level and condition
- o Transaxle fluid level and condition
- o Brake fluid level
- o Clutch fluid level
- o Engine coolant level
- o Windshield washer fluid level
- o Accessory drive belt condition
- o Engine coolant hose condition
- o Fluid leaks (on or below components)
- o Power steering fluid level
- o Battery condition
- o Air filter condition

G020B01A-AAT

Vehicle Exterior

The following should be checked monthly:

- o Overall appearance and condition
- o Wheel condition and wheel nut torque
- o Exhaust system condition
- o Light condition and operation
- o Windshield glass condition
- o Wiper blade condition
- o Paint condition and body corrosion
- o Fluid leaks
- o Door and hood lock condition
- o Tire pressure and condition (including spare tire)

FarmaSOS.com

G020C01A-AAT

Vehicle Interior

The following should be checked each time when the vehicle is driven:

- o Lights operation
- o Windshield wiper operation
- o Horn operation
- o Defroster, heating system operation (and air conditioning, if installed)
- o Steering operation and condition
- o Mirror condition and operation
- o Turn signal operation
- o Accelerator pedal operation
- o Brake operation, including parking brake
- o Manual transaxle operation, including clutch operation
- o Automatic transaxle operation, including "Park" mechanism operation
- o Seat control condition and operation
- o Seat belt condition and operation
- o Sunvisor operation

If you notice anything that does not operate correctly or appears to be functioning correctly, inspect it carefully and seek assistance from your Hyundai dealer if service is needed.

CHECKING THE ENGINE OIL

G030A01A-AAT

Engine oil is essential to the performance and service of the engine. It is suggested that you check the oil level at least once a week in normal use and more often if you are on a trip or driving in severe conditions.

G030B01O-AAT

Recommended Oil

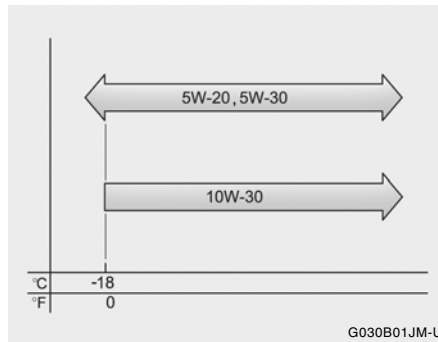

The engine oil quality should meet the following classification.

API SJ, SL or ABOVE,
ILSAC GF-3 or ABOVE

NOTE:

- o For good fuel economy, SAE 5W-20 (5W-30), ILSAC GF-3 engine oil is preferred.
- o If SAE 5W-20, ILSAC GF-3 engine oil is not available, other recommended engine oils for corresponding temperature ranges can be used.



G030C01JM-AAT

To Check the Oil Level

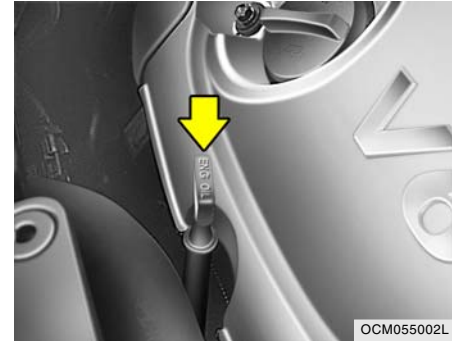

Before checking the oil, warm up the engine to the normal operating temperature and be sure your car is parked on level ground. Turn the engine off.

Wait five minutes, then remove the dipstick, wipe it off, fully reinsert the dipstick and withdraw it again. Then note the highest level the oil has reached on the dipstick. It should be between the upper ("F") and lower ("L") range.

**WARNING:**

Be very careful not to touch the radiator hose when checking the engine oil as it may be hot enough to burn you.

G030D02MC-AAT

Adding Oil

If the oil level is close to or below the "L" mark, add oil until it reaches the "F" mark. To add oil:

1. Remove the oil filler cap by turning it counterclockwise.
2. Add oil, then check the level again. Do not overfill.
3. Replace the cap by turning it clockwise.

The distance between the "F" and "L" marks is equal to about 1 quart of oil.

**CAUTION:**

Slowly pour the recommended oil by using a funnel. Do not overfill so as not to damage engine.

**WARNING:**

Be very careful not to touch the radiator hose when adding the engine oil as it may be hot enough to burn you.

NOTE:

- o It is recommended that the engine oil and filter should be changed by an authorized Hyundai dealer.
- o Always dispose of used engine oil in an environmentally acceptable manner. It is suggested that it be placed in a sealed container and taken to a service station for reclamation. Do not pour the oil on the ground or put it into the household trash.

CHECKING THE ENGINE COOLANT

G050A01TG-AAT

G050B01A-AAT

Recommended Engine Coolant

Use a high quality ethylene-glycol coolant in a 50/50 mix with water. The engine coolant should be compatible with aluminum engine parts. Additional corrosion inhibitors or additives should not be used. The cooling system must be maintained with the correct concentration and type of engine coolant to prevent freezing and corrosion. Never allow the concentration of antifreeze to exceed the 60% level or go below the 35% level, or damage to the cooling system may result. For proper concentration when adding or replacing the engine coolant, refer to the following table.

Ambient temperature °F (°C)	Engine Coolant concentration	
	Antifreeze solution	Water
5 (-15)	35%	65%
-13 (-25)	40%	60%
-31 (-35)	50%	50%
-49 (-45)	60%	40%

PROPOSITION 65 WARNING:

This product contains a chemical known to the State of California to cause cancer. Used engine oil may cause irritation or cancer of the skin if left in contact with the skin for prolonged periods of time. Used engine oil contains chemicals that have caused cancer in laboratory animals. Always protect your skin by washing your hands thoroughly with soap and warm water as soon as possible after handling used oil.

WARNING:

Do not remove the radiator cap when the engine is hot. When the engine is hot, the engine coolant is under pressure and may erupt through the opening if the cap is removed. You could be seriously burned if you do not observe this precaution. Do not remove the radiator cap until the radiator is cool to the touch.

NOTE:

It is recommended that the engine coolant should be changed by an authorized Hyundai dealer.

FarmaSOS.com

G050C01TG-AAT

To Check the Coolant Level

OCM055004L

The coolant level can be seen on the side of the plastic coolant reservoir. The level of the coolant should be between the "L" and "F" lines on the reservoir when the engine is cool. If the level is below the "L" mark, add engine coolant to bring it up between "L" and "F". If the level is low, inspect for coolant leaks and recheck the fluid level frequently. If the level drops again, visit your Hyundai dealer for an inspection and diagnosis of the reason.

**CAUTION:**

- o Engine coolant can damage the finish of your car. If you spill engine coolant on the car, wash it off thoroughly with clean water.
- o The engine in your vehicle has aluminum engine parts and must be protected by an ethylene-glycol base coolant to prevent corrosion and freezing.

Do not use hard water. Hard water can cause engine damage from corrosion, overheating or freezing.

**WARNING:**

The cooling fan is controlled by engine coolant temperature and may sometimes operate even when the engine is not running. Use extreme caution when working near the blades of the cooling fan so that you are not injured by a rotating fan blade. As the engine coolant temperature decreases, the fan will automatically shut off. This is a normal condition.

CHANGING THE AIR CLEANER FILTER

G070A03Y-AAT

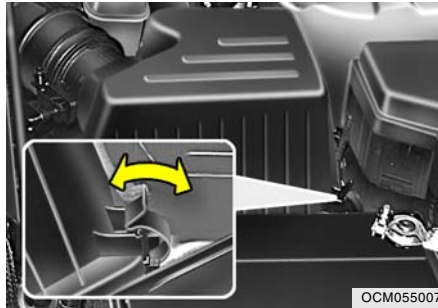

OCM055007

The replacement of air cleaner filter is performed in the following manner.

1. Unsnap the clips around the cover.
2. When this is done, the cover can be lifted off, the old filter removed and the new filter put in its place.

Genuine Hyundai replacement parts are recommended.

**CAUTION:**

- o Operating your vehicle without a proper air filter in place can result in excessive engine wear.
- o When removing the air cleaner filter, be careful that dust or dirt does not enter the air intake. These may result in damage to the air cleaner filter.

WINDSHIELD WIPER BLADES

G080A02A-AAT

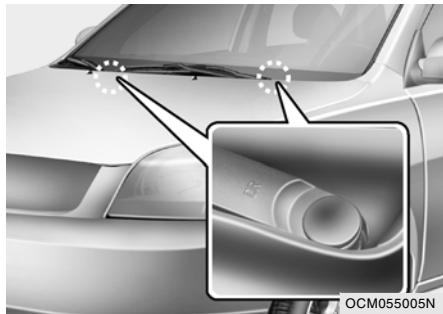

The wiper blades should be carefully inspected from time to time and cleaned to remove accumulations of road film or other debris. To clean the wiper blades and arms, use a clean sponge or cloth with a mild soap or detergent and water. If the wipers continue to streak or smear the glass, replace them with genuine Hyundai replacement parts or their equivalent.



CAUTION:

- o Do not operate the wipers on dry glass. This can result in more rapid wear of the wiper blades and may scratch the glass.
- o Keep the blade rubber out of contact with petroleum products such as engine oil, gasoline, etc.

G080B02CM-AAT

Replacing the Wiper Blades Front window windshield wiper blades

To remove the wiper blade



1. Raise the wiper arm and turn the wiper blade assembly to expose the plastic locking clip.

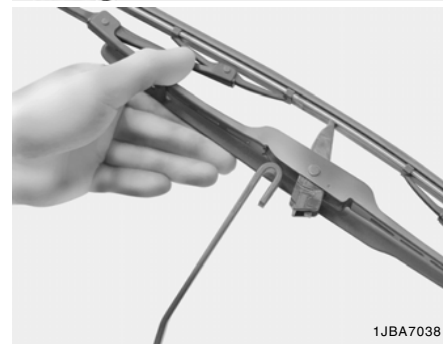
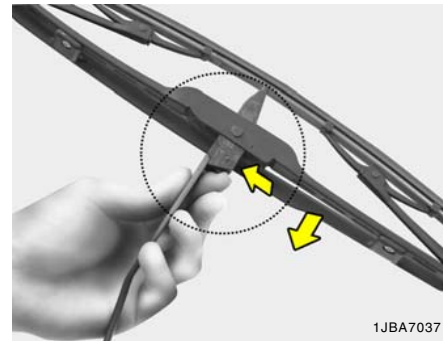

2. Compress the clip and slide the blade assembly downward.
3. Lift it off the arm.

To install the wiper blade

Install the blade assembly in the reverse order of removal.

G080B03CM-AAT

Rear window wiper blade**Type with wiper arm stopper (if installed)**

To prevent damage to the wiper arms or other components, have an authorized Hyundai dealer replace the wiper blade.

**CAUTION:**

- o Do not allow the wiper arm to fall against the windshield, since it may chip or crack the windshield.
- o To remove the rear wiper blade, first removes the head cap. If you excessively raise the rear wiper arm with the head cap installed, it will damage the head cap.

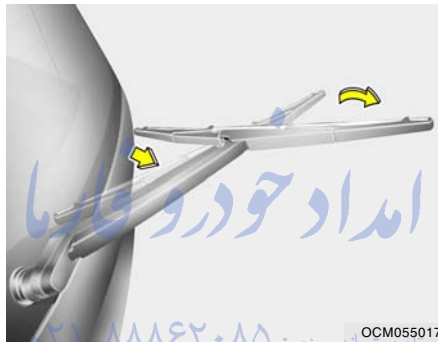
Type without wiper arm stopper (if installed)

1. Raise the wiper arm and pull out the wiper blade assembly.

FarmaSOS.com

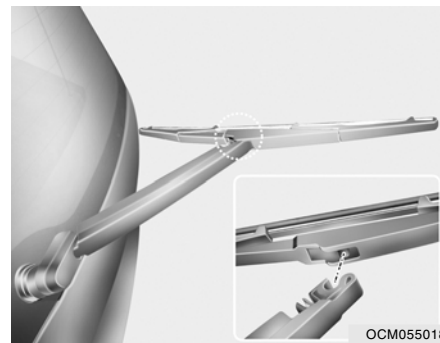

2. Install the new blade assembly by inserting the center part into the wiper arm until it clicks into place.
3. Make sure the blade assembly is installed firmly.
4. Place the wiper arm to the proper position.

FILLING THE WASHER RESERVOIR

G090A01CM-AAT

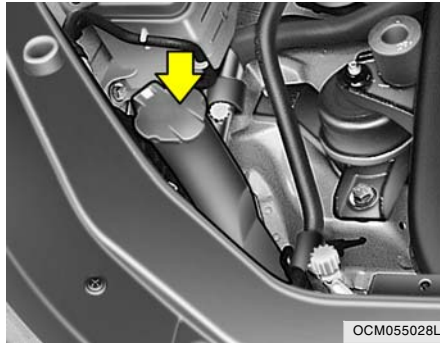

OCM055028L

The washer fluid reservoir supplies fluid to the front and rear washer systems. A good quality washer fluid should be used to fill the washer reservoir. The fluid level should be checked more frequently during inclement weather or whenever the washer system is in more frequent use.



CAUTION:

- o Radiator anti-freeze (engine coolant) should not be used in the washer system because it will damage the car's finish.
- o The washer should not be operated if the washer reservoir is empty. This can damage the washer fluid pump.



WARNING:

- o Windshield washer fluid agents contain some amounts of alcohol and can be flammable under certain circumstances. Do not allow sparks or flame to contact the washer fluid or the washer fluid reservoir. Damage to the vehicle or its occupants could occur.
- o Windshield washer fluid is poisonous to humans and animals. Do not drink windshield washer fluid. Serious injury or death could occur.

CHECKING THE TRANSAXLE OIL (MANUAL)

G100A01MC-GAT

Transaxle lubricant in the manual transaxle should be checked at those intervals specified in the vehicle maintenance schedule in Section 5.



WARNING:

It is always better to check the transaxle oil level when the engine is cool or cold. If the engine is hot, you should exercise great caution to avoid burning yourself on hot engine or exhaust parts.

NOTE:

It is recommended that the manual transaxle fluid should be checked by an authorized Hyundai dealer.

CHECKING THE TRANSAXLE FLUID (AUTOMATIC)

G110A01MC-AAT

Transaxle fluid in the automatic transaxle should be checked at those intervals specified in the vehicle maintenance schedule in Section 5.

NOTE:

Automatic transaxle fluid is basically a red color. As driving distance increases, the fluid color turns darkish red gradually. It is a normal condition and you should not judge the need to replace based upon the changing color. You must replace the automatic transaxle fluid in accordance with intervals specified in the vehicle maintenance schedule in section 5.



CAUTION:

Use of aftermarket ATF additives may cause damage to the automatic transaxle.

Only use HYUNDAI GENUINE ATF SP III, DIAMOND ATF SP III, SK ATF SP III or other brands meeting the SP III specification approved by Hyundai Motor Co.. If you are having your vehicle serviced at a facility other than a Hyundai dealer, verify that the correct ATF is used for your vehicle.



WARNING:

The transaxle fluid level should be checked when the engine is at normal operating temperature. This means that the engine, radiator, exhaust system etc., are very hot. Exercise great care not to burn yourself during this procedure.

G110D02CM-AAT

To Check the Transaxle Fluid Level

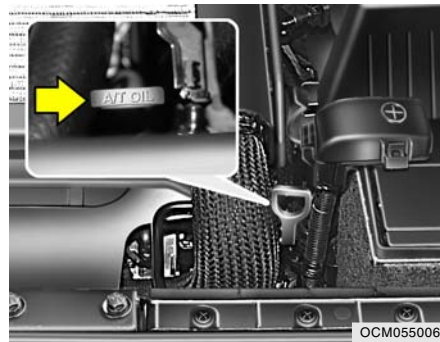

The automatic transaxle fluid level should be checked regularly.

Keep the vehicle on level ground with the parking brake applied and check the fluid level according to the following procedure.

1. Place the shift lever in N(neutral) position and confirm the engine is running at normal idle speed.
2. After the transaxle is warmed up sufficiently [fluid temperature 70~80°C (158~176°F)], for example by 10 minutes usual driving, move the shift lever through all positions then place the shift lever in N(neutral) or P(park) position.

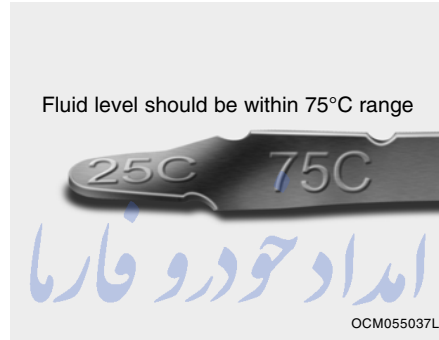

3. Confirm if the fluid level is in the “75°C” range on the level gauge. If the fluid level is lower, add the specified fluid from the fill hole. If the fluid level is higher, drain the fluid from the drain hole.
4. If the fluid level is checked in cold condition [fluid temperature 20~30°C (68~86°F)], add the fluid to the “25°C” line and then recheck the fluid level according to the above step 2.



WARNING:

The cooling fan is controlled by engine coolant temperature and may sometimes operate even when the engine is not running. Use extreme caution when working near the blades of the cooling fan, so that you are not injured by a rotating fan blade. As the engine coolant temperature decreases, the fan will automatically shut off. This is a normal condition.

CHECKING THE BRAKES

G120A01A-AAT

**CAUTION:**

Because brakes are essential to the safe operation of the car, it is suggested that they be checked and inspected by your Hyundai dealer. The brakes should be checked and inspected for wear at those intervals specified in the vehicle maintenance schedule in Section 5.

G120B01A-AAT

Checking the Brake Fluid Level**WARNING:**

Use caution when handling brake fluid. It can damage your vision if it gets into your eyes. It will also damage your vehicle's paint if spilled on it and not removed immediately.

G120C02A-AAT

Recommended Brake Fluid

Use only hydraulic brake fluid conforming to DOT 3 or DOT 4 specifications in your braking system. Follow the instructions printed on the container.

امداد خودرو فارما

تلفن شبانه روزی: ۰۲۱-۸۸۶۲۰۸۵

FarmaSOS.com

G120D01CM-AAT

To Check the Fluid Level

It is normal for the brake fluid level to go down slightly as the brake pads wear. The fluid level in the brake fluid reservoir should be checked periodically. The level should be between the "MIN" and "MAX" marks on the side of the reservoir. If the level is at or below the "MIN" mark, carefully add fluid to bring it up to "MAX".

AIR CONDITIONING CARE

G120E02A-AAT

Adding Brake Fluid



WARNING:

Handle brake fluid carefully. It can damage your vision if it gets into your eyes. Use only DOT 3 or DOT 4 specification fluid from a sealed container. Do not allow the fluid can or reservoir to remain open any longer than required. This will prevent entry of dirt and moisture which can damage the brake system and cause improper operation.

To add brake fluid, first wipe away any dirt then unscrew the fluid reservoir cap. Slowly pour the recommended fluid into the reservoir. Do not overfill. Carefully replace the cap on the reservoir and tighten.

G140A01A-AAT

Keeping the Condenser Clean

The air conditioning condenser (and engine radiator) should be checked periodically for accumulation of dirt, dead insects, leaves, etc. These can interfere with maximum cooling efficiency. When removing such accumulations, brush or hose them away carefully to avoid bending the cooling fins.

امداد خودرو فارس

تلفن شبانه روزی: ۰۲۱-۸۸۶۲۰۸۵

FarmaSOS.com

G140B01A-AAT

Checking the Air Conditioning Operation

1. Start the engine and let it run at a fast idle for several minutes with the air conditioning set at the maximum cold setting.
2. If the air coming out of the in-dash vents is not cold, have the air conditioning system inspected by your Hyundai dealer.



CAUTION:

Running the air conditioning system for extended periods of time with a low refrigerant level may damage the compressor.

G140C01A-AAT

Lubrication

To lubricate the compressor and the seals in the system, the air conditioning should be run for at least 10 minutes each week. This is particularly important during cool weather when the air conditioning system is not otherwise in use.

CHANGING THE CLIMATE CONTROL AIR FILTER (If Installed)

B145A01CM-AAT

(For Evaporator and Blower Unit) (If Installed)

The climate control air filter is located in front of the evaporator unit behind the glove box.

It helps to decrease the amount of pollutants entering the car.

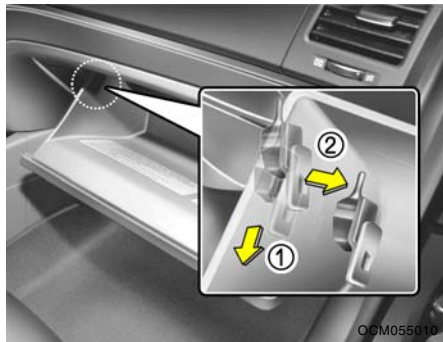

1. Open the glove box and remove the adjusting pins on both sides of the glove box.

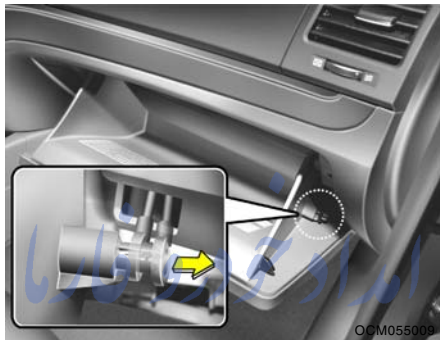

2. Pull the damper strap on the right side of the glove box through the hole.
3. Lower down the glove box completely.

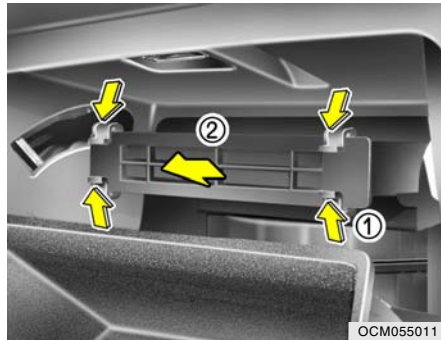

4. Pull out the climate control air filter with the hooks on both sides pressed.

FarmaSOS.com



CAUTION:
Be careful not to press the hooks in the opposite direction.

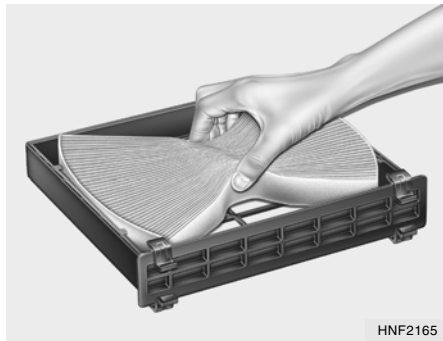

HNF2165

5. Replace the air conditioner filter by lifting it.
6. Installation is the reverse order of disassembly.



CAUTION:
To prevent pollutants from entering the car, be sure to properly install the air conditioner filter.

CHECKING PARKING BRAKE PEDAL

G185A02TG-GAT

(If Installed)

The parking brake pedal should be checked periodically for proper stroke. If you feel looseness in the parking brake pedal when the parking brake is engaged, have your parking brake adjusted by an authorized Hyundai dealer.



CAUTION:
If the parking brake pedal is not adjusted properly, the vehicle may roll backwards when parking on a steep hill.

FarmaSOS.com

CHECKING AND REPLACING FUSES

G200A03A-AAT

Replacing a Fusible Link



OCM054003

A fusible link will melt if the electrical circuits from the battery are ever overloaded, thus preventing damage to the entire wiring harness. (This could be caused by a short in the system drawing too much current.) If this ever happens, have a Hyundai dealer determine the cause, repair the system and replace the fusible link. The fusible links are located in a relay box in the engine compartment for easy inspection.

**CAUTION:**

When replacing a fusible link, never use anything but a new fusible link with the same or lower amperage rating. Never use a piece of wire or a higher-rated fusible link. This could result in serious damage and create a fire hazard.

G200B02HP-AAT

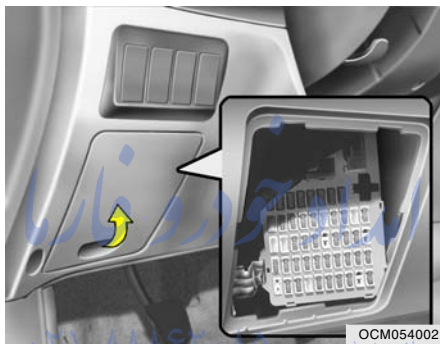
Replacing Accessory Fuses

The fuse box for the lights and other electrical accessories will be found low on the dashboard on the driver's side. Inside the box you will find a list showing the circuits protected by each fuse.

If any of your car's lights or other electrical accessories stop working, a blown (open) fuse could be the reason. If the fuse has burned out, you will see that the metal strip inside the fuse has melted through. If you suspect a blown fuse, follow this procedure:

1. Turn off the ignition and all other switches.
2. Open the fuse box and examine each fuse. Remove each fuse by pulling it toward you (a small "fuse puller" tool is contained in the relay and fuse box of the engine room to simplify this operation).
3. Be sure to check all other fuses even if you find one that appears to have burned out.



G200B02NF

4. Replace the blown fuse by pressing a new fuse of the same rating into place. The fuse should be a snug fit. If it is not, have the fuse clip repaired or replaced by a Hyundai dealer. If you do not have a spare fuse, you may be able to borrow a fuse of the same or lower rating from an accessory you can temporarily get along without (the radio or cigarette lighter, for example). Always remember to replace the borrowed fuse.

**CAUTION:**

A burned-out fuse indicates that there is a problem in the electrical circuit. If you replace a fuse and it blows as soon as the accessory is turned on, the problem is serious and should be referred to a Hyundai dealer for diagnosis and repair. Never replace a fuse with anything except a fuse with the same or a lower amperage rating. A higher capacity fuse could cause damage and create a fire hazard.

NOTE:

See page 6-33 for the fuse panel descriptions.

G200C01CM-GAT

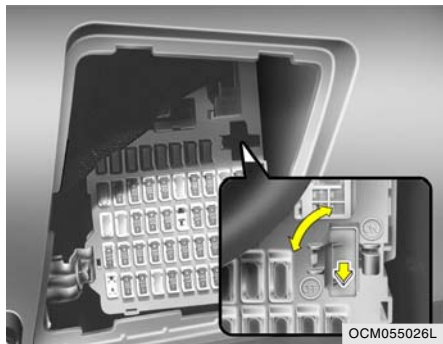
Power connector

Your vehicle is equipped with a power connector to prevent battery discharge if your vehicle is parked without being operated for prolonged periods. Use the following procedures before parking the vehicle for prolonged periods.

1. Turn off the engine.
2. Turn off the headlights and tail lights.
3. Open the driver's side panel cover and pull out the power connector.
4. Insert the power connector in the opposite direction.

NOTE:

- o If the power connector is pulled out of the fuse panel, the warning chime, audio, clock and interior lamps, etc., will not operate. The following items must be reset after replacement.
 - Digital Clock
 - Trip computer
 - Automatic heating and cooling control system
 - Audio
- o Even though the power connector is pulled out, the battery can still be discharged by operation of the headlights or other electrical devices.

FarmaSOS.com

CHECKING THE BATTERY

G210A01A-AAT

**WARNING:**

Batteries can be dangerous! When working with batteries, carefully observe the following precautions to avoid serious injuries.

The fluid in the battery contains a strong solution of sulfuric acid, which is poisonous and highly corrosive. Be careful not to spill it on yourself or the car. If you do spill battery fluid on yourself, immediately do the following:

- o If battery fluid is on your skin, flush the affected areas with water for at least 15 minutes and then seek medical assistance.
- o If battery fluid is in your eyes, rinse out your eyes with water and get medical assistance as soon as possible. While you are being driven to get medical assistance, continue to rinse your eyes by using a sponge or soft cloth saturated with water.
- o If you swallow battery fluid, drink a large quantity of water or milk followed by milk of magnesia, eat a raw egg or drink vegetable oil. Get medical assistance as soon as possible.

While batteries are being charged (either by a battery charger or by the vehicle's generator), they produce explosive gases. Always observe these warnings to prevent injuries from occurring:

- o Charge batteries only in a well ventilated area.
- o Do not permit flames, sparks or smoking in the area.
- o Keep children away from the area.

G210B04A-AAT

Checking the Battery



Keep the battery clean. Any evidence of corrosion around the battery posts or terminals should be removed using a solution of household baking soda and warm water. After the battery terminals are dry, cover them with a light coating of grease.

!

PROPOSITION 65 WARNING:
Battery posts, terminals, and related accessories contain lead and lead compounds, chemicals known to the state of California to cause cancer and reproductive harm.
Batteries also contain other chemicals known to the state of California to cause cancer. Wash hands after handling.

!

WARNING:
Always read the following instructions carefully when handling a battery.
Keep lighted cigarettes and all other flames or sparks away from the battery.
Hydrogen, which is a highly combustible gas, is always present in battery cells and may explode if ignited.
Keep batteries out of the reach of children because batteries contain highly corrosive SULFURIC ACID. Do not allow battery acid to contact your skin, eyes, clothing or paint finish.
If any electrolyte gets into your eyes, flush your eyes with clean water for at least 15 minutes and get immediate medical attention. If possible, continue to apply water with a sponge or cloth until medical attention is received.

**WARNING:**

If electrolyte gets on your skin, thoroughly wash the contacted area.

If you feel a pain or a burning sensation, get medical attention immediately.

Wear eye protection when charging or working near a battery.

Always provide ventilation when working in an enclosed space.



- o When lifting a plastic-cased battery, excessive pressure on the case may cause battery acid to leak, resulting in personal injury. Lift with a battery carrier or with your hands on opposite corners.
- o Never attempt to charge the battery when the battery cables are connected.
- o The electrical ignition system works with high voltage.
Never touch these components with the engine running or the ignition switched on.

CHECKING ELECTRIC COOLING FANS

G220A01A-AAT

**WARNING:**

The cooling fan is controlled by engine coolant temperature and may sometimes operate even when the engine is not running. Use extreme caution when working near the blades of the cooling fan, so that you are not injured by a rotating fan blade. As the engine coolant temperature decreases the fan will automatically shut off. This is a normal condition.

تلفن شبانه روزی: ۰۲۱-۸۸۶۲۰۸۵

FarmaSOS.com

G220B01A-AAT

Checking Engine Cooling Fan

The engine cooling fan should come on automatically if the engine coolant temperature is high.

G220C01A-AAT

Checking Condenser Cooling Fan

The condenser cooling fan should come on automatically whenever the air conditioning is in operation.

POWER STEERING FLUID LEVEL

G230A01MC-AAT

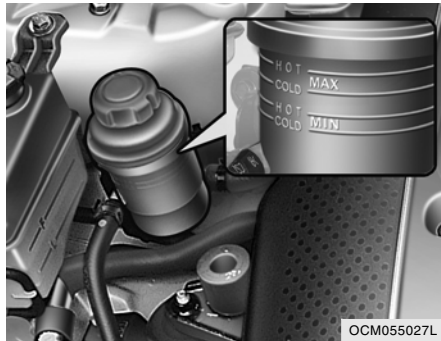

The power steering fluid level should be checked regularly. To check the power steering fluid level, be sure the engine is "OFF", then check to make certain that the power steering fluid level is between the "MAX" and "MIN" level markings on the fluid reservoir.

NOTE:

- Grinding noise from the power steering pump may be heard immediately after the engine is started in extremely cold conditions (below - 4°F). If the noise stops during warm up, there is no abnormal function in the system. It is due to a power steering fluid characteristic in extremely cold conditions.
- Do not start the engine when the power steering oil reservoir is empty.

تلفن شبانه روزی: ۰۲۱-۸۸۶۲۰۸۵

G240A01A-AAT

Power Steering Hoses

It is suggested that you check the power steering hose connections for fluid leakage at those intervals specified in the vehicle maintenance schedule in Section 5. The power steering hoses should be replaced if there is severe surface cracking, pulling, scuffing or worn spots. Deterioration of the hose could cause premature failure.

FOR MORE INFORMATION ABOUT YOUR HYUNDAI

G250A01A-AAT

If you desire additional information about maintaining and servicing your Hyundai, you may purchase a factory Shop Manual at your Hyundai dealer's parts department. This is the same manual used by dealership technicians and while it is highly technical it can be useful in obtaining a better understanding of your car and how it works.

REPLACEMENT OF LIGHT BULBS

G260A01CM-AAT

Before attempting to replace a light bulb, be sure the switch is turned to the "OFF" position.

The next paragraph shows how to reach the light bulbs so they may be changed. Be sure to replace the burned-out bulb with one of the same number and wattage rating.



CAUTION:

- o Keep the lamps out of contact with petroleum products, such as oil, gasoline, etc.
- o After heavy, driving rain or washing, headlight and taillight lenses could appear frosty. This condition is caused by the temperature difference between the lamp inside and outside. This is similar to the condensation on your windows inside your vehicle during the rain and doesn't indicate a problem with your vehicle. If the water leaks into the lamp bulb circuitry, have the vehicle checked by an Authorized Hyundai Dealer.

G270A01CM-GAT

Headlight, Front Turn Signal Light and Front Position Light

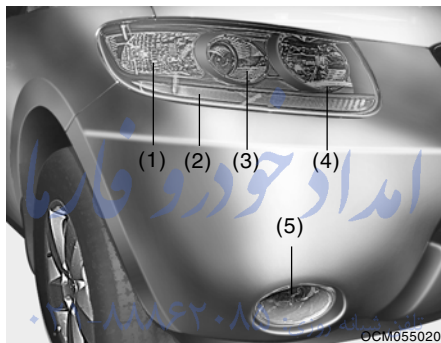

- (1) Turn signal light/Side marker
- (2) Front position light
- (3) Headlight (Low Beam)
- (4) Headlight (High Beam)
- (5) Front fog light

1. Allow the bulb to cool. Wear eye protection.
2. Open the engine hood.
3. Always grasp the bulb by its plastic base, avoid touching the glass.

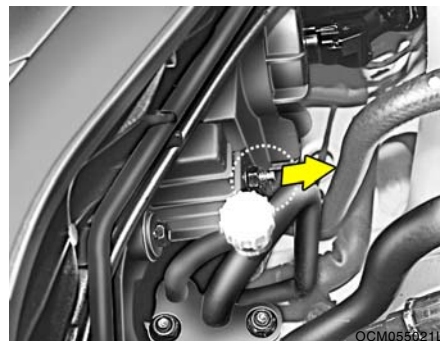
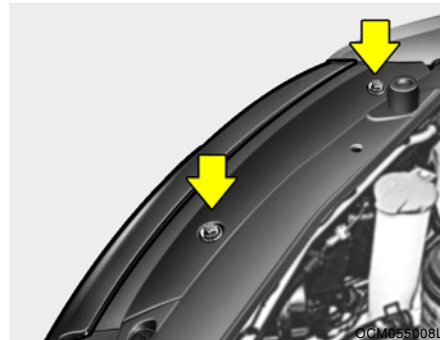

4. Using a wrench, remove the headlight assembly mounting bolts and nut.

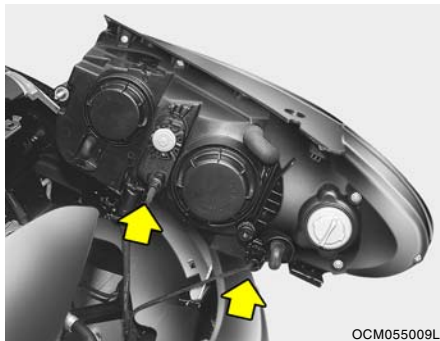

OCM055009L

5. Disconnect the wire harness from the bulb base in the back of the headlight.

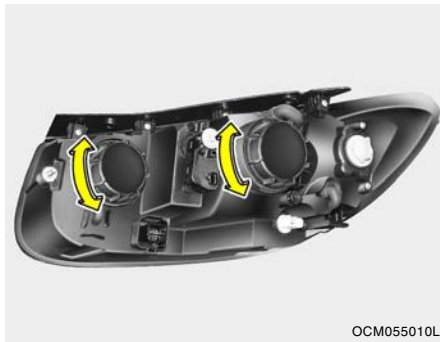

OCM055010L

6. Turn the plastic cover counterclockwise and remove it.

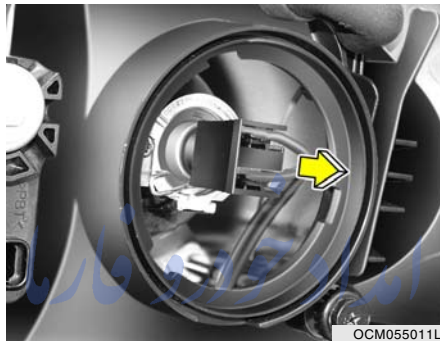

OCM055011L

7. Disconnect the connector from the bulb base in the back of the headlight.

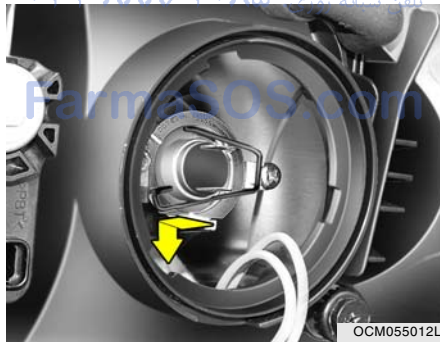

OCM055012L

8. Push the bulb spring to remove the headlight bulb.

9. Remove the protective cap from the replacement bulb and install the new bulb by matching the plastic base with the headlight hole. Reattach the bulb spring and reconnect the connector.
10. Use the protective cap and carton to promptly dispose of the old bulb.
11. Check for proper headlight aim.

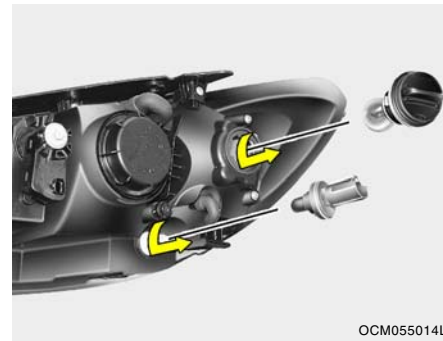

OCM055014L

12. To replace the front turn signal bulb or the front position light bulb, take it out from the bulb holder and install the new bulb.



G270A030

**WARNING:**

This halogen bulb contains gas under pressure and if impacted could shatter, resulting in flying fragments. Always wear eye protection when servicing the bulb. Protect the bulb against abrasions or scratches and against liquids when lighted. Turn the bulb on only when installing in a headlight. Replace the headlight if damaged or cracked. Keep the bulb out of the reach of children and dispose of the used bulb with care.

G270K01CM-GAT

Front Fog Light (If Installed)**NOTE:**

It is recommended that the front fog light bulb be replaced by an authorized Hyundai dealer.

امداد خودرو فارما

تلفن شبانه روزی: ۰۲۱-۸۸۱۶۲۰۸۵

FarmaSOS.com

G270B01CM-AAT

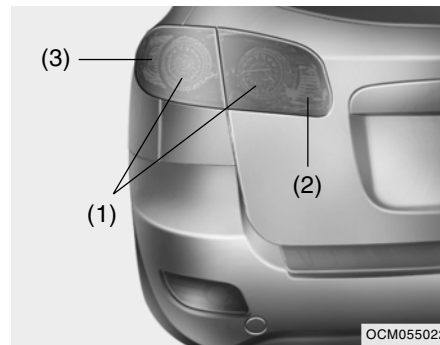
Rear Combination Light

- (1) Stop/Tail light
 - (2) Back-up light
 - (3) Turn signal light/Side marker
1. Open the tail gate.

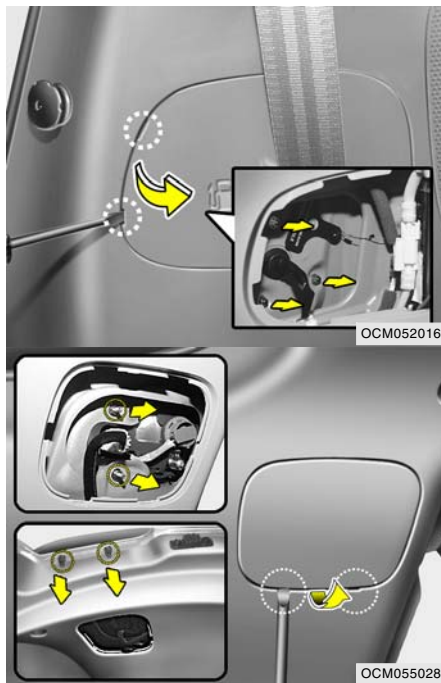

2. Remove the cover with a flat-head screwdriver.
3. Remove the mounting screws of the rear combination light as shown in the photo.

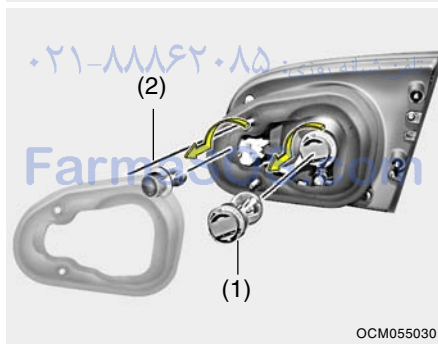
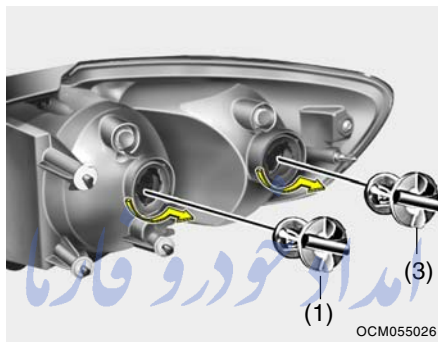

- (1) Stop/Tail light
- (2) Back-up light
- (3) Turn signal light/Side marker

4. To replace the rear combination light, take it out from the bulb holder by turning it counterclockwise.
5. Install the new bulb.

G270I01CM-GAT

High Mounted Rear Stop Light (If Installed)

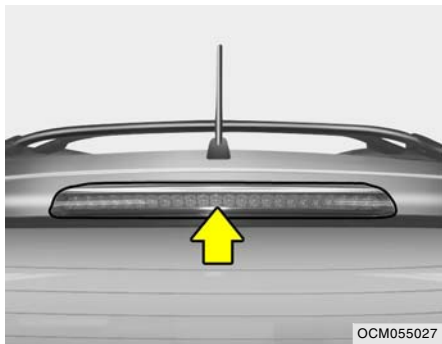

NOTE:

It is recommended that the High-Mounted Rear Stop Light be replaced by an authorized Hyundai Dealer.

G270J01CM-AAT

License Plate Light

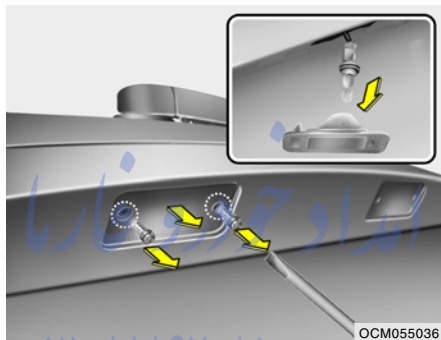

1. Remove the mounting screws of the license plate light cover with a phillips screwdriver.
2. Disconnect the wire harness by turning the bulb cover counterclockwise and take the bulb out from the bulb cover by turning it clockwise.
3. Replace with a new bulb.

G270E01CM-AAT

Side Repeater Light (If installed)

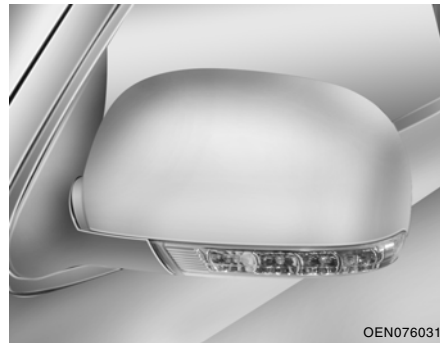

NOTE:

If the light bulb is not operating, have the vehicle checked by an authorized HYUNDAI dealer.

G270G010-GAT

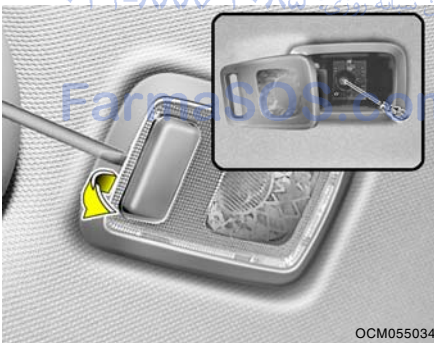
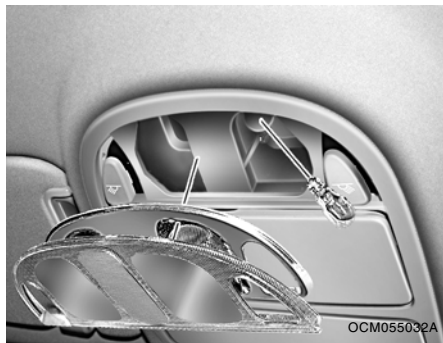
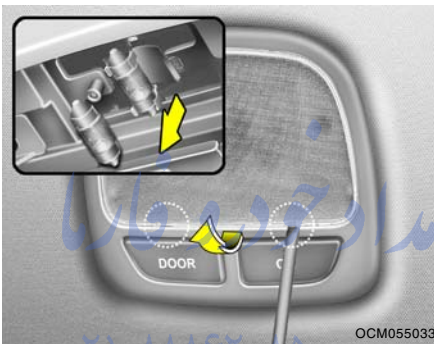
Interior Light (If installed)

1. Remove the cover with a flat-head screwdriver.
2. Replace with a new bulb.

G270C02TB-AAT

Luggage Compartment Light (If Installed)



1. Remove the cover with a flat blade screw driver.
2. Disconnect the wire harness.
3. Replace with a new bulb.

G270C02JM-AAT

Cargo Light



1. Open the tail gate.
2. Remove the cover with a flat-head screwdriver.
3. Replace with a new bulb.

G270H01CM-AAT

Glove Box Light



1. Open the glove box.
2. Remove the cover with a flat-head screwdriver.
3. Disconnect the connector.
4. Replace with a new bulb.

BULB WATTAGE

G280A02CM-AAT

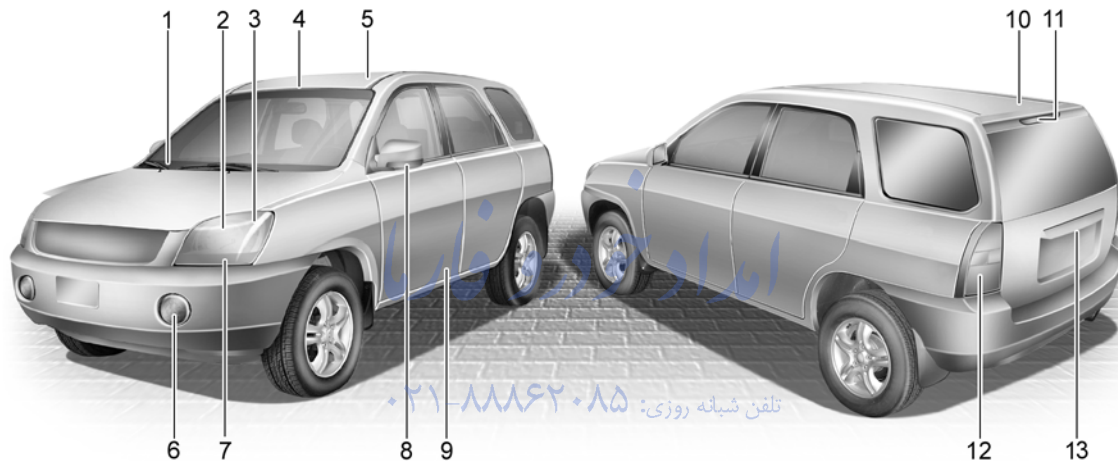

OCM058025M

No.	Part Name	Wattage	Socket Type	No.	Part Name	Wattage	Socket Type
1	Glove Box Light	5	S8.5/8.5	9	Front Door Edge Warning Light (If installed)	5	W2.1 x 4.6D
2	Headlight (Low/High)	55	PX26D	10	Luggage Compartment Light (If installed)	10	S8.5/8.5
3	Turn Signal Light/Side Marker	27	BAY15D	11	High Mounted Rear Stop Light (If installed)	16	W2.1 x 9.5D
4	Map Light	10	W2.1 x 9.5D	12	Rear Combination Light		
5	Interior Light	10	S8.5/8.5		Turn Signal Light	27	BAU15s
6	Front Fog Light (If installed)	27	PG13		Stop/Tail Light	27/8	BAY15D
7	Front Position Light	5	W2.1 x 9.5D		Back-up Light	16	W2.1 x 9.5D
8	Side Repeater Light (If installed)	5	LED	13	License Plate Light	5	W2.1 x 9.5D

FUSE PANEL DESCRIPTION

G200C01CM-AAT

Engine Compartment

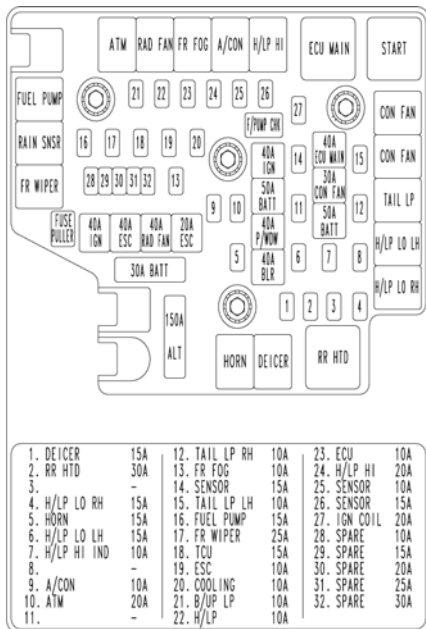

OCM055023N

FUSE	FUSE RATING	CIRCUIT PROTECTED
ALT	150A	GENERATOR
A/CON	10A	A/CON RELAY
RR HTD	30A	RR HTD RELAY
BLR	40A	I/PJUNCTION BOX
BATT	50A	I/PJUNCTION BOX
P/PDW	40A	I/PJUNCTION BOX
ESC #1	40A	ABS CONTROL MODULE, ESC CONTROL MODULE, MULTIPURPOSE CHECK CONNECTOR
ESC #2	20A	ABS CONTROL MODULE, ESC CONTROL MODULE, MULTIPURPOSE CHECK CONNECTOR
DEICER	15A	DEICER RELAY
ECU MAIN	40A	ENGINE CONTROL RELAY
HORN	15A	HORN RELAY
IG COIL	20A	IGNITION COIL #1~#6(GASOLINE), CONDENSOR(GASOLINE)
SENSOR #3	15A	PURGE CONTROL SOLENOID VALVE(GASOLINE), VARIABLE INTAKE MANIFOLD VALVE(GASOLINE), PCM(GASOLINE), OIL CONTROL VALVE(GASOLINE)
RAD FAN	40A	RAD FAN RELAY
CON FAN	30A	CON FAN #1 RELAY, CON FAN #2 RELAY
SENSOR #2	15A	MASS AIR FLOW SENSOR(GASOLINE), OXYGEN SENSOR #1~#4(GASOLINE), PCM(GASOLINE)
SENSOR #1	10A	IMMOBILIZER MODULE, INJECTOR #1~#6(GASOLINE), PCM(GASOLINE), A/CON RELAY, FUEL PUMP RELAY

Note:

Not all fuse panel descriptions in this manual may be applicable to your vehicle. It is accurate at the time of printing. When you inspect the fuse box on your vehicle, refer to the fuse box label.

FUSE	FUSE RATING	CIRCUIT PROTECTED
FUEL PUMP	15A	FUEL PUMP RELAY
H/LP LO LH	15A	H/LP LO LH RELAY
H/LP LO RH	15A	H/LP LO RH RELAY
FR FOG	10A	FR FOG RELAY
H/LP	10A	I/P JUNCTION BOX
FR WIPER	25A	FR WIPER RELAY, RAIN SNSR RELAY, FRONT WIPER MOTOR, MULTIFUNCTION SWITCH
H/LP HI	20A	H/LP HI RELAY
H/LP HI IND	10A	HEAD LAMP, INSTRUMENT CLUSTER
IGN #1	40A	IGNITION SWITCH
IGN #2	40A	IGNITION SWITCH, START RELAY
BATT	50A	I/P JUNCTION BOX
ATM	20A	ATM RELAY(GASOLINE), AWD ECM
TCU	15A	PCM(GASOLINE)
ALT DSL	10A	GENERATOR
ECU	10A	VEHICLE SPEED SENSOR, PCM(GASOLINE), SEMI ACTIVE CONTROL MODULE(GASOLINE)
COOLING	10A	CON FAN #1 RELAY, CON FAN #2 RELAY
B/UP UP	10A	INPUT SPEED SENSOR, OUTPUT SPEED SENSOR, TRANSAXLE RANGE SWITCH, BACK-UP LAMP SWITCH
ESC	10A	ABS CONTROL MODULE, ESC CONTROL MODULE, YAW RATE SENSOR, AWD ECM, STOP LAMP SWITCH(GASOLINE), MULTIPURPOSE CHECK CONNECTOR
TAIL LH	10A	REAR COMBINATION LAMP LH, POSITION LAMP LH
TAIL RH	10A	REAR COMBINATION LAMP RH, POSITION LAMP RH GLOVE BOX LAMP, ICM RELAY BOX
SPARE	10A	-
SPARE	15A	-
SPARE	20A	-
SPARE	25A	-
SPARE	30A	-

G200E01CM-AAT

Inner Panel

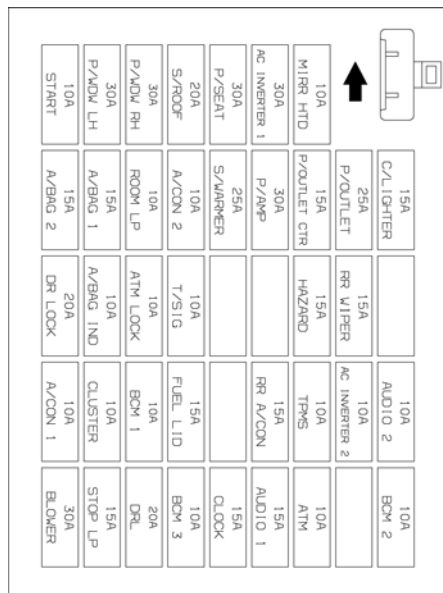

OCM055024N

FUSE	FUSE RATING	CIRCUIT PROTECTED
C/LIGHTER	15A	CIGARETTE LIGHTER
P/OUTLET	25A	FRONT POWER OUTLET, REAR POWER OUTLET
P/OUTLET CTR	15A	CENTER POWER OUTLET
AUDIO #2	10A	POWER OUTSIDE MIRROR SWITCH, AUDIO, ATM KEY LOCK CONTROL MODULE, DIGITAL CLOCK
RR WIPER	15A	MULTIFUNCTION SWITCH, REAR WIPER CONTROL MODULE, REAR WIPER MOTOR
IMS	10A	RAIN SENSOR
BCM #2	10A	RHEOSTAT, BCM, INSTRUMENT CLUSTER
A/CON 2	10A	A/C CONTROL MODULE, INCAR & HUMIDITY SENSOR, HIGH BLOWER RELAY, REAR A/CON SWITCH, ICM RELAY BOX, AQS SENSOR, SUNROOF MOTOR, BLOWER BELAY, ELECTRO CHROMIC MIRROR
BLOWER	30A	BLOWER RELAY, BLOWER MOTOR, A/C CONTROL MODULE
A/CON 1	10A	A/C CONTROL MODULE
A/BAG #1	15A	SRS CONTROL MODULE
A/BAG IND	10A	PAB ON/OFF SWITCH, INSTRUMENT CLUSTER
T/SIG	10A	HAZARD SWITCH
ATM LOCK	10A	MULTIFUNTION SWITCH, STEERING ANGLE SENSOR, ESC SWITCH, ATM KEY LOCK CONTROL MODULE SEAT WARMER MODULE
BCM #1	10A	OIL LEVEL SENSOR MODULE, BCM
CLUSTER	10A	INSTRUMENT CLUSTER, PRE-EXCITATION RESISTOR, BCM, GENERATOR, SEMI ACTIVE CONTROL MODULE (GASOLINE)
START	10A	BURGLAR ALARM RELAY

FUSE	FUSE RATING	CIRCUIT PROTECTED
P/AMP	30A	DELPHI AMP
SWARMER	25A	SEAT WARMER CONTROL MODULE
P/SEAT	30A	POWER SEAT SWITCH
RR A/CON	15A	ICM RELAY BOX
RR FOG/BWS	10A	ICM RELAY BOX
S/ROOF	20A	SUNROOF MOTOR
MIRR HTD	10A	REAR DEFOGGER SWITCH, POWER OUTSIDE MIRROR MOTOR
DR/LOCK	20A	DOOR LOCK (UN) RELAY, ICM RELAY BOX
STOP LP	15A	STOP LAMP SWITCH
FUEL LID	15A	FUEL LID SWITCH
ATM	10A	KEY SOLENOID, SPORTS MODE SWITCH, SEMIACTIVE SOLENOID (GASOLINE) INSTRUMENT CLUSTER, LUGGAGE LAMP, MAP LAMP, REAR PERSONAL LAMP,
ROOM LP	10A	ROOM LAMP, FRONT DOOR LAMP CARGO LAMP, VANITY LAMP SWITCH
BCM #3	10A	DOOR WARNING SWITCH, BCM, SECURITY INDICATOR
CLOCK	15A	A/C CONTROL MODULE, DATA LINK CONNECTOR, DIGITAL CLOCK
AUDIO #1	15A	DELPHI AUDIO
HAZARD	15A	HAZARD SWITCH, HAZARD RELAY
P/WDW LH	30A	POWER WINDOW MAIN SWITCH, REAR POWER WINDOW SWITCH LH
P/WDW RH	30A	POWER WINDOW MAIN SWITCH, REAR POWER WINDOW SWITCH RH
AC INVERTER 1	30A	AC INVERTER
AC INVERTER 2	10A	AC INVERTER
TPMS	10A	TIRE PRESSURE MONITORING SYSTEM
A/BAG 2	15A	AIR BAG
T/SIG	10A	TURN SIGNAL LIGHT
DRL	20A	DAYTIME RUNNING LIGHT (IF INSTALLED)

EMISSION CONTROL SYSTEMS

Emission Control System	7-2
Catalytic Converter	7-3

امداد خودرو فارما

تلفن شبانه روزی: ۰۲۱-۸۸۸۶۲۰۸۵

FarmaSOS.com

7

EMISSION CONTROL SYSTEM

H010A01NF-AAT

Your Hyundai is equipped with an emission control system to meet all emission regulations.

There are three emission control systems which are as follows.

- (1) Crankcase emission control system
- (2) Evaporative emission control system
- (3) Exhaust emission control system

In order to assure the proper function of the emission control systems, it is recommended that you have your car inspected and maintained by an authorized Hyundai dealer in accordance with the maintenance schedule in this manual.

Caution for the Inspection and Maintenance Test (With Electronic Stability Control (ESC) system)

- o To prevent the vehicle from misfiring during dynamometer testing, turn the Electronic Stability Control (ESC) system off by pressing the ESC switch.
- o After dynamometer testing is completed, turn the ESC system back on by pressing the ESC switch again.

H010B01A-AAT

1. Crankcase Emission Control System

The positive crankcase ventilation system is employed to prevent air pollution caused by blow-by gases being emitted from the crankcase. This system supplies filtered air to the crankcase through the air intake hose. Inside the crankcase, the fresh air mixes with blow-by gases, which then pass through the PCV valve and into the induction system.

تلفن شبانه روزی: ۰۲۱-۸۸۶۲۰۸۵

FarmaSOS.com

H010C01S-AAT

2. Evaporative Emission Control (Including ORVR: Onboard Refueling Vapor Recovery) System

The Evaporative Emission Control System is designed to prevent fuel vapors from escaping into the atmosphere.

(The ORVR system is designed to allow the vapors from the fuel tank to be loaded into a canister while refueling at the gas station, preventing the escape of fuel vapors into the atmosphere.)

Canister

Fuel vapors generated inside the fuel tank are absorbed and stored in the canister. When the engine is running, the fuel vapors absorbed in the canister are drawn into the induction system through the purge control solenoid valve.

CATALYTIC CONVERTER

Purge Control Solenoid Valve (PCSV)

The purge control solenoid valve is controlled by the Engine Control Module (ECM); when the engine coolant temperature is low during idling, the PCSV closes so that evaporated fuel is not taken into the engine. After the engine warms-up during ordinary driving, the PCSV opens to introduce evaporated fuel to the engine.

H010D01A-AAT

3. Exhaust Emission Control System

The Exhaust Emission Control System is a highly effective system which controls exhaust emissions while maintaining good vehicle performance.

H020A01A-AAT

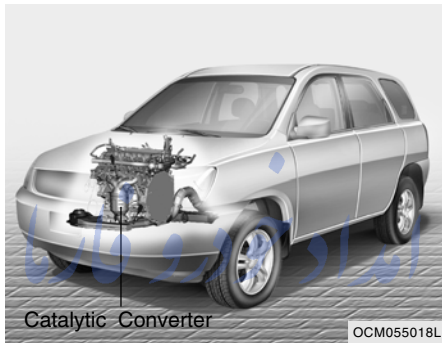

All Hyundai vehicles are equipped with a monolith type three-way catalytic converter to reduce the carbon monoxide, hydrocarbons and nitrogen oxides contained in the exhaust gas. Exhaust gases passing through the catalytic converter cause it to operate at a very high temperature. The introduction of large amounts of unburned gasoline into the exhaust may cause the catalytic converter to overheat and create a fire hazard. This risk may be reduced by observing the following:



WARNING:

- Use unleaded fuel only.
- Maintain the engine in good operating condition. Extremely high catalytic converter temperatures can result from improper operation of the electrical, ignition or multipoint electronic fuel injection.
- If your engine stalls, pings, knocks, or is hard to start, have your Hyundai dealer inspect and repair the problem as soon as possible.
- Avoid driving with a very low fuel level. Running out of gasoline may cause the engine to misfire and result in damage to the catalytic converter.
- Avoid idling the engine for periods longer than 10 minutes.
- The vehicle should not be pushed or pulled to get started. This may cause the catalytic converter to overheat and create a fire hazard.

**WARNING:**

- o Do not touch the catalytic converter or any other part of the exhaust system while the catalytic converter is hot. Shut off the engine, wait for at least one hour before touching the catalytic converter or any other part of the exhaust system.
- o Remember that your Hyundai dealer is your best source of assistance.
- o Do not stop your Hyundai over any combustible material such as grass, paper, leaves or rags. These materials might contact the hot catalytic converter and a fire might result.

امداد خودرو فارما

تلفن شبانه روزی: ۰۲۱-۸۸۸۶۲۰۸۵

FarmaSOS.com

CONSUMER INFORMATION, REPORTING SAFETY DEFECTS & BINDING ARBITRATION OF WARRANTY CLAIMS

Vehicle Identification Number (VIN)	8-2
Engine Number	8-2
Tire Information	8-3
Recommended Inflation Pressures	8-3
Tire Sidewall Labeling	8-6
Tire Terminology and Definitions	8-8
Snow Tires	8-10
Tire Chains	8-10
Tire Rotation	8-11
Tire Balancing	8-12
Tire Traction	8-12
When to Replace Tires	8-12
Tire Aging	8-13
Tire Maintenance	8-13
Spare Tire and Tools	8-14
Warranties for Your Hyundai Vehicle	8-15
Consumer Information	8-15
Reporting Safety Defects	8-17
Binding Arbitration of Warranty Claims (U.S.A Only) ..	8-18

8

VEHICLE IDENTIFICATION NUMBER (VIN)

I010A01CM-AAT

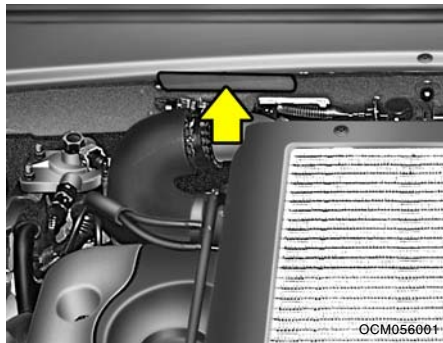

OCM056001

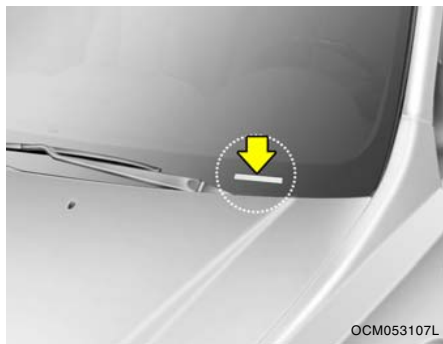

OCM053107L



OCM056002N

The vehicle identification number (VIN) is the number used in registering your car and in all legal matters pertaining to its ownership, etc. It can be found in three different places on your car:

1. On the engine side of the bulkhead between the engine and passenger compartment.
2. On the left top side of the instrument panel where it can be seen by looking down through the windshield.
3. Door edge post (Driver's side).

ENGINE NUMBER

I010B01A-AAT

2.7 V6

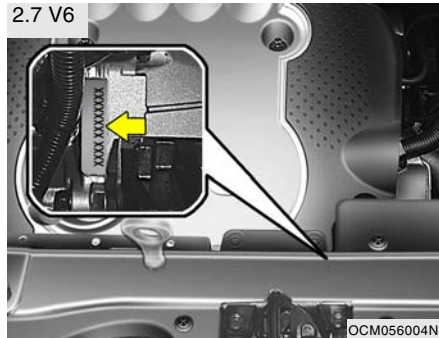

OCM056004N

3.3 V6

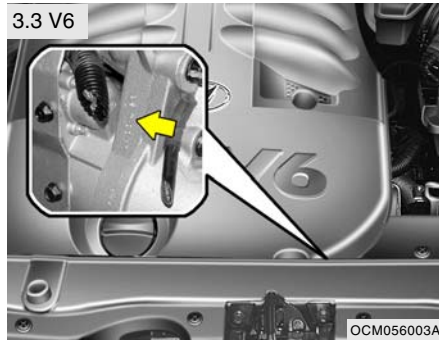

OCM056003A

The engine number is stamped on the engine block as shown in the drawing.

TIRES

I020A02A-AAT

Tire Information

The tires supplied on your new Hyundai are chosen to provide the best performance for normal driving.

If you ever have questions about your tire warranty and where to obtain service, see the tire manufacturer's booklet included with your vehicle's Owner's Manual Literature Kit.

I030A04JM-AAT

Recommended Cold Tire Inflation Pressures



Tire label located on the driver's side of the center pillar outer panel gives the cold tire pressures recommended for your vehicle with the original tire size, the number of people that can be in your vehicle and vehicle capacity weight.

Type A

TIRE AND LOADING INFORMATION PNEUS ET CHARGE INFORMATION				
SEATING CAPACITY NOMBRE DE SIÈGES		TOTAL 5 TOTAL 5	FRONT 2 AVANT 2	REAR 3 ARRIÈRE 3
The combined weight of occupants and cargo should never exceed 420kg or 930lbs. Le poids combiné des occupants et du chargement ne doit jamais excéder 420kg ou 930lb.				
TIRE/ PNEU	SIZE/ DIMENSION	COLD TIRE PRESSURE/ PRESSION À FROID	SEE OWNER'S MANUAL FOR ADDITIONAL INFORMATION	
FRONT/ AVANT	P235 / 70R16	210kPa, 30psi	CONSULTEZ LE GUIDE DU PROPRIÉTAIRE POUR OBTENIR DES RENSEIGNEMENTS ADDITIONNELS	
REAR/ ARRIÈRE	P235 / 70R16	210kPa, 30psi		
SPARE/ SECOURS	T165 / 90R17	420kPa, 60psi		

I030A01CM

Type B

TIRE AND LOADING INFORMATION PNEUS ET CHARGE INFORMATION				
SEATING CAPACITY NOMBRE DE SIÈGES		TOTAL 5 TOTAL 5	FRONT 2 AVANT 2	REAR 3 ARRIÈRE 3
The combined weight of occupants and cargo should never exceed 420kg or 930lbs. Le poids combiné des occupants et du chargement ne doit jamais excéder 420kg ou 930lb.				
TIRE/ PNEU	SIZE/ DIMENSION	COLD TIRE PRESSURE/ PRESSION À FROID	SEE OWNER'S MANUAL FOR ADDITIONAL INFORMATION	
FRONT/ AVANT	P235 / 60R18	210kPa, 30psi	CONSULTEZ LE GUIDE DU PROPRIÉTAIRE POUR OBTENIR DES RENSEIGNEMENTS ADDITIONNELS	
REAR/ ARRIÈRE	P235 / 60R18	210kPa, 30psi		
SPARE/ SECOURS	T165 / 90R17	420kPa, 60psi		

I030A02CM

Type C

TIRE AND LOADING INFORMATION PNEUS ET CHARGE INFORMATION				
SEATING CAPACITY NOMBRE DE SIÈGES		TOTAL 7	FRONT 2 AVANT 2	REAR 5 ARRIÈRE 5
The combined weight of occupants and cargo should never exceed 506kg or 1120lbs. Le poids combiné des occupants et du chargement ne doit jamais excéder 506kg ou 1120lb.				
TIRE/ PNEU	SIZE/ DIMENSION	COLD TIRE PRESSURE/ PRESSION À FROID	SEE OWNER'S MANUAL FOR ADDITIONAL INFORMATION	
FRONT/ AVANT	P235 / 70R16	210kPa, 30psi	CONSULTEZ LE GUIDE DU PROPRIÉTAIRE POUR OBTENIR LES RENSEIGNEMENTS ADDITIONNELS	
REAR/ ARRIÈRE	P235 / 70R16	210kPa, 30psi		
SPARE/ SECOURS	T165 / 90R17	420kPa, 60psi		

1030A03CM

Type D

TIRE AND LOADING INFORMATION PNEUS ET CHARGE INFORMATION				
SEATING CAPACITY NOMBRE DE SIÈGES		TOTAL 7	FRONT 2 AVANT 2	REAR 5 ARRIÈRE 5
The combined weight of occupants and cargo should never exceed 506kg or 1120lbs. Le poids combiné des occupants et du chargement ne doit jamais excéder 506kg ou 1120lb.				
TIRE/ PNEU	SIZE/ DIMENSION	COLD TIRE PRESSURE/ PRESSION À FROID	SEE OWNER'S MANUAL FOR ADDITIONAL INFORMATION	
FRONT/ AVANT	P235 / 60R18	210kPa, 30psi	CONSULTEZ LE GUIDE DU PROPRIÉTAIRE POUR OBTENIR LES RENSEIGNEMENTS ADDITIONNELS	
REAR/ ARRIÈRE	P235 / 60R18	210kPa, 30psi		
SPARE/ SECOURS	T165 / 90R17	420kPa, 60psi		

1030A04CM

These pressures were chosen to provide the most satisfactory combination of ride comfort, tire wear and stability under normal conditions. Tire pressures should be checked at least monthly. Proper tire inflation pressures should be maintained for these reasons:

WARNING:

- o Underinflation also results in excessive wear, poor handling and reduced fuel economy. Wheel deformation also is possible. Keep your tire pressures at the proper levels. If a tire frequently needs refilling, have it checked by your Hyundai Dealer.
- o Overinflation produces a harsh ride, excessive wear at the center of the tire tread, and a greater possibility of damage from road hazards.

WARNING:

- o Inspect your tires frequently for proper inflation as well as wear and damage. Always use a tire pressure gauge.
- o Tires with too much or too little pressure wear unevenly causing poor handling, loss of vehicle control, and sudden tire failure leading to accidents, injuries, and even death. The recommended cold tire pressure for your vehicle can be found in this manual and on the tire label located on the driver's side of the center pillar.
- o Worn tires can cause accidents. Replace tires that are worn, show uneven wear, or are damaged. See page 8-11.
- o Remember to check the pressure of your spare tire. Hyundai recommends that you check the spare every time you check the pressure of the other tires on your vehicle.

**WARNING:**

Overinflation or underinflation can reduce the tire life, adversely affect vehicle handling, and lead to sudden tire failure. This could result in loss of vehicle control and potential injury.

**CAUTION:**

Always observe the following:

- o Check pressures when the tires are cold. (After the vehicle has been parked for at least three hours or hasn't been driven more than one mile (1.6 km) since starting up.)
- o Check the pressure of your spare tire each time you check the pressure of other tires.
- o Never overload your vehicle. Be especially careful about overloading if you equip your vehicle with a luggage rack.
- o Worn, old tires can cause accidents. If your tread is badly worn, or if your tires have been damaged, replace them.

I035A01JM-AAT

Checking Tire Inflation Pressure

Check your tires once a month or more. Also, check the tire pressure of the spare tire.

How to Check

Use a good quality gage to check tire pressure. You can not tell if your tires are properly inflated simply by looking at them. Radial tires may look properly inflated even when they're underinflated. Check the tire's inflation pressure when the tires are cold. - "Cold" means your vehicle has been sitting for at least three hours or driven no more than 1 mile (1.6 km).

Remove the valve cap from the tire valve stem. Press the tire gage firmly onto the valve to get a pressure measurement. If the cold tire inflation pressure matches the recommended pressure on the tire and loading information label, no further adjustment is necessary. If the pressure is low, add air until you reach the recommended amount. If you overfill the tire, release air by pushing on the metal stem in the center of the tire valve. Recheck the tire pressure with the tire gage. Be sure to put the valve caps back on the valve stems. They help prevent leaks by keeping out dirt and moisture.

I030B01CM-AAT

Tire Sidewall Labeling

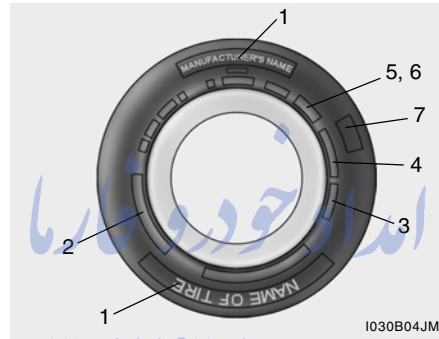

Federal law requires tire manufacturers to place standardized information on the sidewall of all tires. This information identifies and describes the fundamental characteristics of the tire and also provides the tire identification number (TIN) for safety standard certification. The TIN can be used to identify the tire in case of a recall.

1. Manufacturer or Brand name

- o Manufacturer or Brand name is shown.

2. Tire size (example: P235/70R16 104T)

- o The "P" indicates the tire is designed for passenger vehicles. A "T" is the designation for a temporary spare tire.
- o Three-digit number (235): This number gives the width in millimeters of the tire from sidewall edge to sidewall edge.
- o Two-digit number (70): This number, known as the aspect ratio, gives the tire's ratio of height to width.
- o R: The "R" stands for radial.
- o Two-digit number (16): This number is the wheel or rim diameter in inches.
- o Two (or three) digit number (104): This number is the tire's load index. It is a measurement of how much weight each tire can support.

- o T: Speed Rating. The speed rating denotes the speed at which a tire is designed to be driven for extended periods of time. The ratings range from "A" to "Z" (98 to 186 MPH).
- 3. TIN (Tire Identification Number)** for new tire (example: DOT XX XX XXX XXXX)
- o DOT: Abbreviation for the "Department of Transportation". The symbol can be placed above, below or to the left or right of the Tire Identification Number. Indicates tire is in compliance with the U.S. Department of Transportation Motor Vehicle Safety Standards.
 - o 1st two-digit code: Manufacturer's identification mark
 - o 2nd two-digit code: Tire size
 - o 3rd three-digit code: Tire type code (Optional)
 - o 4th four-digit code: Date of Manufacture

- o Four numbers represent the week and year the tire was built. For example, the numbers 3105 means the 31st week of 2005.

4. Tire ply composition and material

- The number of layers or plies of rubbercoated fabric in the tire. Tire manufacturers also must indicate the materials in the tire, which include steel, nylon, polyester, and others. The letter "R" means radial ply construction; the letter "D" means diagonal or bias ply construction; and the letter "B" means belted-bias ply construction.

5. Maximum permissible inflation pressure

- This number is the greatest amount of air pressure that should be put in the tire. Do not exceed the maximum permissible inflation pressure. Refer to the Tire and Loading Information label for recommended inflation pressure.

6. Maximum load rating

- This number indicates the maximum load in kilograms and pounds that can be carried by the tire. When replacing the tires on the vehicle, always use a tire that has the same load rating as the factory installed tire.

7. Uniform Tire Quality Grading (UTQG):

- Tire manufacturers are required to grade tires based on three performance factors: treadwear, traction and temperature resistance. For more information, see Uniform Tire Quality Grading on page 8-16.

1030D01JM-AAT

Tire Terminology And Definitions

Air Pressure: The amount of air inside the tire pressing outward on the tire. Air pressure is expressed in pounds per square inch (psi) or kilopascal (kPa).

Accessory Weight: This means the combined weight of optional accessories. Some examples of optional accessories are, automatic transmission, power seats, and air conditioning.

Aspect Ratio: The relationship of a tire's height to its width.

Belt: A rubber coated layer of cords that is located between the plies and the tread. Cords may be made from steel or other reinforcing materials.

Bead: The tire bead contains steel wires wrapped by steel cords that hold the tire onto the rim.

Bias Ply Tire: A pneumatic tire in which the plies are laid at alternate angles less than 90 degrees to the centerline of the tread.

Cold Tire Pressure: The amount of air pressure in a tire, measured in pounds per square inch (psi) or kilopascals (kPa) before a tire has built up heat from driving.

Curb Weight: This means the weight of a motor vehicle with standard and optional equipment including the maximum capacity of fuel, oil and coolant, but without passengers and cargo.

DOT Markings: A code molded into the sidewall of a tire signifying that the tire is in compliance with the U.S. Department of Transportation motor vehicle safety standards. The DOT code includes the Tire Identification Number (TIN), an alphanumeric designator which can also identify the tire manufacturer, production plant, brand and date of production.

GVWR: Gross Vehicle Weight Rating

GAWR FRT: Gross Axle Weight Rating for the front Axle.

GAWR RR: Gross Axle Weight Rating for the rear axle.

Intended Outboard Sidewall: The side of an asymmetrical tire, that must always face outward when mounted on a vehicle.

Kilopascal (kPa): The metric unit for air pressure.

Load Index: An assigned number ranging from 1 to 279 that corresponds to the load carrying capacity of a tire.

Maximum Inflation Pressure: The maximum air pressure to which a cold tire may be inflated. The maximum air pressure is molded onto the sidewall.

Maximum Load Rating: The load rating for a tire at the maximum permissible inflation pressure for that tire.

Maximum Loaded Vehicle Weight: The sum of curb weight; accessory weight; vehicle capacity weight; and production options weight.

Normal Occupant Weight: The number of occupants a vehicle is designed to seat multiplied by 150 pounds (68 kg).

Occupant Distribution: Designated seating positions.

Outward Facing Sidewall: The side of a asymmetrical tire that has a particular side that faces outward when mounted on a vehicle. The side of the tire that contains a whitewall, bears white lettering or bears manufacturer, brand and or model name molding that is higher or deeper than the same moldings on the other sidewall of the tire.

Passenger (P-Metric) Tire: A tire used on passenger cars and some light duty trucks and multipurpose vehicles.

Recommended Inflation Pressure: Vehicle manufacturer's recommended tire inflation pressure and shown on the tire placard.

Radial Ply tire: A pneumatic tire in which the ply cords that extend to the beads are laid at 90 degrees to the centerline of the tread.

Rim: A metal support for a tire and upon which the tire beads are seated.

Sidewall: The portion of a tire between the tread and the bead.

Speed Rating: An alphanumeric code assigned to a tire indicating the maximum speed at which a tire can operate.

Traction: The friction between the tire and the road surface. The amount of grip provided.

Tread: The portion of a tire that comes into contact with the road.

Treadwear Indicators: Narrow bands, sometimes called "wear bars," that show across the tread of a tire when only 2/32 inch of tread remains.

UTQGS: Uniform Tire Quality Grading Standards, a tire information system that provides consumers with ratings for a tire's traction, temperature and treadwear. Ratings are determined by tire manufacturers using government testing procedures. The ratings are molded into the sidewall of the tire.

Vehicle Capacity Weight: The number of designated seating positions multiplied by 150 lbs. (68 kg) plus the rated cargo and luggage load

Vehicle Maximum Load on the Tire: Load on an individual tire due to curb and accessory weight plus maximum occupant and cargo weight.

Vehicle Normal Load on the Tire: That load on an individual tire that is determined by distributing to each axle its share of the curb weight, accessory weight, and normal occupant weight and driving by 2.

Vehicle Placard: A label permanently attached to a vehicle showing the original equipment tire size and recommended inflation pressure

I040B01JM-AAT

All Season Tires

Hyundai specifies all season tires on some models to provide good performance for use all year round, including snowy and icy road conditions. All season tires are identified by ALL SEASON and/or M+S (Mud and Snow) on the tire sidewall. Snow tires have better snow traction than all season tires and may be more appropriate in some areas.

I040C01JM-AAT

Summer Tires

Hyundai specifies summer tires on some models to provide superior performance on dry roads. Summer tire performance is substantially reduced in snow and ice. Summer tires do not have the tire traction rating M+S (Mud and Snow) on the tire side wall. If you plan to operate your vehicle in snowy or icy conditions, Hyundai recommends the use of snow tires or all season tires on all four wheels.

I040A01O-AAT

Snow Tires

If you equip your car with snow tires, they should be the same size and have the same load capacity as the original tires. Snow tires should be installed on all four wheels; otherwise, poor handling may result.

Snow tires should carry 4 psi (28 kPa) more air pressure than the pressure recommended for the standard tires on the tire label on the driver's side of the center pillar, or up to the maximum pressure shown on the tire sidewall whichever is less.

Do not drive faster than 75 mph (120 km/h) when your car is equipped with snow tires.

I050A01CM-AAT

Tire Chains

When using tire chains, attach them to the drive wheels as follows.

2WD : Front wheels

AWD : All four wheels

In some unavoidable circumstances, install them on only the front wheels, not the rear wheels.

Be sure that the chains are installed in accordance with the manufacturer's instructions.

To minimize tire and chain wear, do not continue to use tire chains when they are no longer needed.

**WARNING:**

- o When driving on roads covered with snow or ice, drive at less than 20 mph.
- o Use the SAE "S" class or wire & plastic chains.
- o Don't use a tire chains on a vehicle equipped with aluminium wheels to prevent damage to the wheel finish. If it is unavoidable, use wire type chains.
- o Use wire chains less than 15mm to prevent damage to the chain's connection.
- o If you hear noise caused by chains contacting the body, retighten the chains to avoid contact with the vehicle body.
- o To prevent body damage, retighten the chains after driving 0.3~0.6 miles.

I060A02A-AAT

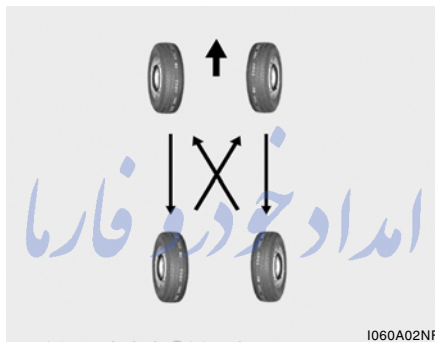
Tire Rotation

I060A02NF

Tires should be rotated every 7,500 miles (12,000 km). If you notice that tires are wearing unevenly between rotations, have the car checked by a Hyundai dealer so the cause may be corrected.

After rotating, adjust the tire pressures and be sure to check the wheel nut torque.

**WARNING:**

- o Do not use the temporary spare tire for tire rotation.
- o Do not mix bias ply and radial ply tires under any circumstances. This may cause unusual handling characteristics that could result in death, serious injury, or property damage.

I070A01A-AAT

Tire Balancing

A tire that is out of balance may affect handling and tire wear. The tires on your Hyundai were balanced before the car was delivered but may need balancing again during the years you own the car. Whenever a tire is dismounted for repair, it should be rebalanced before being reinstalled on the car.

I080A01A-AAT

Tire Traction

Tire traction can be reduced if you drive on worn tires, tires that are improperly inflated or on slippery road surfaces. Tires should be replaced when tread wear indicators appear. To reduce the possibility of losing control, slow down whenever there is rain, snow or ice on the road.

I090A03A-AAT

When to Replace Tires

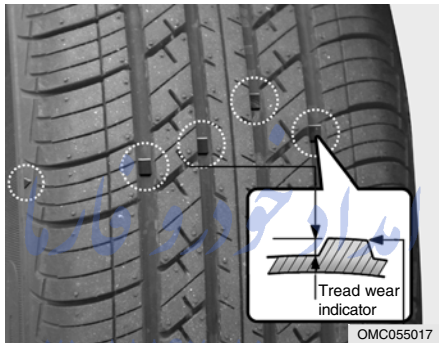

The original tires on your car have tread wear indicators. The location of tread wear indicators is shown by the "TWI" or "△" marks, etc. The tread wear indicators appear when the tread depth is 0.06 in. (1.6 mm). The tire should be replaced when these appear as a solid bar across two or more grooves of the tread. Always replace your tires with those of the recommended size. If you change wheels, the new wheel's rim width and offset must meet Hyundai specification.



WARNING:

To reduce the chance of serious or fatal injuries from an accident caused by tire failure or loss of vehicle control:

- o Replace tires that are worn, show uneven wear, or are damaged. Worn tires can cause loss of braking effectiveness, steering control, and traction.
- o Do not drive your vehicle with too little or too much pressure in your tires. This can lead to uneven wear and tire failure.
- o When replacing tires, never mix radial and bias-ply tires on the same car. You must replace all tires (including the spare) if moving from radial to bias-ply tires.

**WARNING:**

- o Using tires and wheels other than the recommended sizes could cause unusual handling characteristics and poor vehicle control, resulting in a serious accident.
- o Wheels that do not meet Hyundai's specifications may fit poorly and result in damage to the vehicle or unusual handling and poor vehicle control.

I090C01CM-AAT

Tire Aging**WARNING:**

Tires degrade over time, even when they are not being used. Regardless of the remaining tread, it is recommended that tires tread, it is recommended that tires generally be replaced after six (6) years of normal service. Heat caused by not climates or frequent high loading conditions can accelerate the aging process. Failure to follow this Warning can result in sudden tire failure, which could lead to a loss of control and an accident involving serious injury or death.

I090B01CM-AAT

Tire Maintenance

In addition to proper inflation, correct wheel alignment helps to decrease tire wear. If you find a tire is worn unevenly, have your dealer check the wheel alignment.

When you have new tires installed, make sure they are balanced. This will increase vehicle ride comfort and tire life. Additionally, a tire should always be rebalanced if it is removed from the wheel.

SPARE TIRE AND TOOLS



WARNING:

- o Underinflated or overinflated tires can cause poor handling, loss of vehicle control, and sudden tire failure leading to accidents, injuries, and even death. Always check that tires are properly inflated before driving. Refer to pages 2-31 and 8-3 for proper tire pressures and further information.
- o Driving on tires with no or insufficient tread is dangerous. Worn-out tires can result in loss of vehicle control, collisions, and injury and even death. Worn-out tires should be replaced as soon as possible and should never be used for driving. Always check tire tread before driving your car. Refer to this page for further information and tread limits.

I100A01CM-AAT

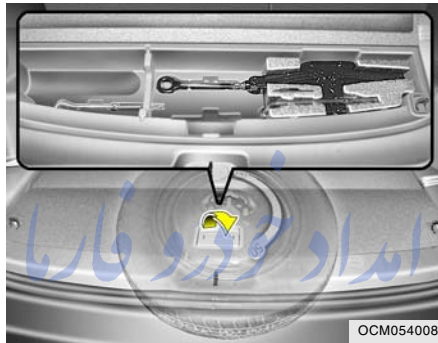

OCM054008

Your Hyundai is delivered with the following:

Spare tire and wheel
 Wheel nut wrench, Wrench bar,
 Jack, Towing hook (if installed)

I110A01A-AAT

Shop Manual

A Hyundai Shop Manual is available from your authorized Hyundai dealer. It's written for professional technicians, but is simple enough for most mechanically-inclined owners to understand.

WARRANTIES FOR YOUR HYUNDAI VEHICLE

I120A03A-AAT

Please consult your Owner's Handbook & Warranty Information booklet for your vehicle's specific warranty coverage.

CONSUMER INFORMATION

I130A01A-AAT

This consumer information has been prepared in accordance with regulations issued by the National Highway Traffic Safety Administration of the U.S. Department of Transportation. It provides the purchasers and/or prospective purchasers of Hyundai automobiles with information on uniform tire quality grading. Your Hyundai dealer will help answer any questions you may have as you read this information.

تلفن شبانه روزی: ۰۲۱-۸۸۱۶۲۰۸۵

FarmaSOS.com

I130B04A-AAT

Tire Quality Grading

Department of Transportation quality grades - All passenger vehicle tires must conform to Federal Safety Standards in addition to these grades. These quality grades are molded on the sidewall.

Treadwear - The treadwear grade is a comparative rating based on the wear rate of the tire when tested under controlled conditions on a specified government test course. For example, a tire graded 150 would wear one and a half (1 - 1/2) times as well on the government course as a tire graded 100. The relative performance of tires depends upon the actual conditions of their use, however, and may depart significantly from the norm due to variations in driving habits, service practices and differences in road characteristics and climate.

Traction AA, A, B, C - The traction grades, from highest to lowest, are AA, A, B, and C. Those grades represent the tire's ability to stop on wet pavement as measured under controlled conditions on specified government test surfaces of asphalt and concrete. A tire marked C may have poor traction performance.



WARNING:

The traction grade assigned to this tire is based on straight-ahead braking traction tests, and does not include acceleration, cornering, hydroplaning, or peak traction characteristics.

Temperature A, B, C - The temperature grades are A (the highest), B, and C, representing the tire's resistance to the generation of heat and its ability to dissipate heat when tested under controlled conditions on a specified indoor laboratory test wheel. Sustained high temperature can cause the material of the tire to degenerate and reduce tire life, and excessive temperature can lead to sudden tire failure. The grade C corresponds to a level of performance which all passenger car tires must meet under the Federal Motor Vehicle Safety Standard No. 109. Grades B and A represent higher levels of performance on the laboratory test wheel than the minimum required by law.



WARNING:

The temperature grade for this tire is established for a tire that is properly inflated and not overloaded. Excessive speed, underinflation, or excessive loading, either separately or in combination, can cause heat buildup and possible tire failure.

Uniform Tire Quality Grading - Quality grades can be found on the tire sidewall between the tread shoulder and the maximum section width.

For example :

Treadwear 200 Traction AA Temperature A

REPORTING SAFETY DEFECTS

I130C02A-AAT

If you believe that your vehicle has a defect which could cause a crash or could cause injury or death, you should immediately inform the National Highway Traffic Safety Administration (NHTSA) in addition to notifying HYUNDAI MOTOR AMERICA. If NHTSA receives similar complaints, it may open an investigation, and if it finds that a safety defect exists in a group of vehicles, it may order a recall and remedy campaign. However, NHTSA cannot become involved in individual problems between you, your dealer, or HYUNDAI MOTOR AMERICA.

To contact NHTSA, you may call the Vehicle Safety Hotline toll-free at 1-888-327-4236 (TTY: 1-800-424-9153); go to <http://www.safercar.gov>; or write to: Administrator, NHTSA, 400 Seventh Street, SW., Washington, DC 20590. You can also obtain other information about motor vehicle safety from <http://www.safercar.gov>.

I130D04A-AAT

Hyundai motor vehicles are designed and manufactured to meet or exceed all applicable safety standards.

For your safety, however, we strongly urge you to read and follow all directions in this Owner's Manual, particularly the information under the headings "**NOTE**", "**CAUTION**" and "**WARNING**".

If, after reading this manual, you have any questions regarding the operation of your vehicle, please contact your nearest Hyundai Motor America Regional Office as listed below:

Eastern Region : Connecticut, Delaware, Maine, Maryland, Massachusetts, New Hampshire, New Jersey, New York, Pennsylvania, Rhode Island, Vermont, Virginia, West Virginia.

Eastern Region
1100 Cranbury South River Road
Jamesburg, NJ 08831
(800) 633-5151

Southern Region: Florida, Georgia, North Carolina, South Carolina.

Southern Region
270 Riverside Parkway, Suite A
Austell, GA 30168
(800) 633-5151

South Central Region: Alabama, Arkansas, Colorado, Kansas, Louisiana, Mississippi, Missouri, New Mexico, Oklahoma, Tennessee, Texas, Wyoming.

South Central Region
1421 South Beltline Road, Suite 400
Coppell, TX 75019
(800) 633-5151

Central Region: Illinois, Indiana, Iowa, Kentucky, Michigan, Minnesota, Nebraska, North Dakota, South Dakota, Ohio, Wisconsin.

Central Region
1705 Sequoia Drive
Aurora, Illinois 60506
(800) 633-5151

Western Region: Alaska, Hawaii, Arizona, California, Idaho, Montana, Nevada, Oregon, Texas, Utah, Washington.

Western Region
10550 Talbert Avenue
P.O.Box 20850
Fountain Valley, California 92728-0850
(800) 633-5151

BINDING ARBITRATION (U.S.A Only)

I140A01A-AAT

Any claim or dispute you may have related to your vehicle's warranty or the duties contemplated under the warranty, including claims related to the refund or partial refund of your vehicle's purchase price (excluding personal injury or product liability claims), shall be resolved by binding arbitration. Binding arbitration shall be administered by and through the National Arbitration Forum (NAF) or the American Arbitration Association (AAA), under the Code of Procedure of the entity you select.

You will not be responsible for paying filing and hearing fees above \$275.00. All other arbitration costs shall be borne by Hyundai Motor America. You are not responsible to pay any of the costs Hyundai incurs.

This Binding Arbitration Agreement shall not deprive you of any remedies available to you under applicable law. The parties are waiving their right to seek remedies in court, including the right to a jury trial.

This Binding Arbitration Agreement shall be governed by and interpreted under the Federal Arbitration Act, 9 U.S.C. sections 1-16. Judgment upon any award may be entered in any court having jurisdiction.

You may revoke this Arbitration Agreement by (1) written notice or (2) electronic notice. Written notice must be delivered (via certified mail) to Hyundai Motor America, Attn: Consumer Affairs, 10550 Talbert Avenue, P.O. Box 20849, Fountain Valley, CA 92728-0849. Electronic notice must be submitted at the following website address: <http://warranty-arbitration.hyundaiUSA.com>. Notice must be received within 90 days after you purchase your vehicle.

VEHICLE SPECIFICATIONS

Dimensions	9-2
Engine	9-3
Lubrication Chart	9-4

امداد خودرو فارما

تلفن شبانه روزی: ۰۲۱-۸۸۸۶۲۰۸۵

FarmaSOS.com

9

J010A01CM-AAT

DIMENSIONS

in. (mm)

Overall length	Standard	183.1 (4650)
	Option	184.1 (4675)
Overall width		74.4 (1890)
Overall height	Standard	67.9 (1725)
	with Roof Rack	70.7 (1795)
Wheel base		106.3 (2700)
Wheel tread	Front	63.6 (1615)
	Rear	63.8 (1620)

J060A01CM-AAT

FUEL SYSTEM

Engine	Fuel tank capacity
2.7L / 3.3L	19.8 us.gal (16.5 imp.gal, 75 liter)

J030A01CM-AAT

TIRE

Type	Size	Inflation pressure kPa (psi)	
		NORMAL LOAD	MAXIMUM LOAD
Full	235/70R16	210(30)	220(32)
	235/60R18		
Temporary	T165/90R17	420(60)	420(60)

J050A01CM-AAT

BRAKE

Type	Dual hydraulic with brake booster
Front brake type	Ventilated disc
Rear brake type	Disc type
Parking brake	Cable operated on rear wheel

ENGINE

J070A03CM-AAT

ITEMS	GASOLINE		
	2.7 L	3.3 L	
Engine Type	6-Cyl., V-type DOHC	6-Cyl., V-type DOHC	
Bore x Stroke in. (mm)	3.41 x 2.95 (86.7 x 75)	3.62 x 3.29 (92 x 83.8)	
Displacement cu.in. (cc)	162.0 (2656)	203.9 (3342)	
Firing order	2 - 3 - 4 - 5 - 6 - 1	1 - 2 - 3 - 4 - 5 - 6	
Valve clearance (warm engine)	Intake	Auto lash	0.28
	Exhaust	Auto lash	0.35
Idle speed (rpm)	680 ± 100	620 ± 100	
Ignition timing (at idle)	BTDC 7° ± 5°	BTDC 10° ± 5°	

FarmaSOS.com

LUBRICATION CHART

J080A07CM-AAT

Item		Oil & Grease Standard	Quantity (US. QTS) (Imp.qts, liter)
Engine Oil	Recommends 	API SJ, SL or ABOVE, ILSAC GF-3 or ABOVE	Drain and refill (With oil filter) Gasoline 2.7L : 4.75 (3.95, 4.5) Gasoline 3.3L : 5.49 (4.57, 5.2)
		SAE 5W-20, 5W-30 SAE 10W-30 (ABOVE -18°C) SAE 15W-40 (ABOVE -13°C) SAE 20W-50 (ABOVE -7°C)	
Transaxle	Manual	HYUNDAI GENUINE PARTS MTF 75W/85 (API GL-4)	Gasoline 2.7L : 2.0 (1.67, 1.75)
	Automatic	HYUNDAI GENUINE ATF SP-III, DIAMOND ATF SP-III, SK ATF SP-III or other brands approved by Hyundai Motor Co.,	Gasoline 2.7L : 8.98 (7.47, 8.5) Gasoline 3.3L : 11.51 (9.59, 10.9)
Transfer case		Hypoid gear oil API GL-5, SAE 70W/90 (SHELL SPIRAX 'X' Equivalent)	0.84 (0.7, 0.8)
Rear Axle		Hypoid gear oil API GL-5, SAE 70W/90 (SHELL SPIRAX 'X' Equivalent)	0.95 (0.79, 0.9)
Coolant		Ethylene glycol base for aluminum radiator	7.39 (6.15, 7)
Power steering gear		PSF-4 TYPE FLUID	1.05 (0.87, 1)
Brakes and clutch fluid		DOT 3, DOT 4 or Equivalent	As required

INDEX

امداد خودرو فارما

تلفن شبانه روزی: ۰۲۱-۸۸۸۶۲۰۸۵

FarmaSOS.com

10

A

AC Inverter	1-87
Air bag	1-44
Air Cleaner Filter	6-16
Air Conditioning	
Care	6-15
Operation	1-132, 6-15
Switch	1-132
Antenna	1-142
Ashtray	1-85
Audio System	
Identifying your audio system	1-147
Controlling how your audio system sounds	1-148
Using general controls	1-151
Using FM/AM tuner controls	1-156
Using CD Player controls	1-159
Playing CDS, MP3 and WMA discs	1-162
Using XM controls	1-168
Using external controls	1-175
Using Rear Seat Entertainment(RSE) system controls	1-172
Rear Seat Entertainment(RSE) system	1-178
RSE control panel operation	1-185
Using the satellite radio	1-193
Using the remote controller	1-196
AWD Lock System	2-20

B

Battery	6-20
Binding Arbitration	8-18

Brake

Anti-lock brake system	2-15
Electronic stability control (ESC) system	2-15
Checking the brakes	6-14
Fluid	6-14
Practices	2-21
Breaking-In your New Hyundai	1-3
Bulb Replacement	6-24

C

California Perchlorate Notice	5-10
Care of Disc	1-146
Catalytic Converter	7-3
Child-Protector Rear Door Lock	1-9
Child Restraint System	1-33
Installing a Child Restraint Seat with the	
"Tether Anchorage" System	1-35
Securing the Child Restraint Seat with the "LATCH" System	1-37
Cigarette Lighter	1-85
Clock	1-84
Combination Light	
Auto light	1-77
Headlight flasher	1-77
Headlight switch	1-76
High-beam switch	1-76
Lane change signal	1-75
Parking light auto off	1-76
Turn signal operation	1-75
Consumer Information	8-15
Conversation mirror	1-95
Cooling Fans	6-22

- Corrosion protection
 Cleaning the interior 4-5
 Protecting your Hyundai from corrosion 4-2
 Washing and waxing 4-4
 Cruise Control 1-120
- D**
 Defrosting / Defogging 1-133
 Door
 Central door lock 1-9
 Door locks 1-7
 Front door edge warning light 1-119
 Drink Holder 1-88
 Driving
 Driving for economy 2-23
 Smooth cornering 2-24
 Winter driving 2-24
- E**
 Emission Control System 7-2
 Engine
 Before starting the engine 2-4
 Compartment 6-2
 Coolant 6-7
 Coolant temperature gauge 1-70
 If the engine overheats 3-4
 Number 8-2
 Oil 6-5
 Starting 2-6
 Engine Exhaust Can Be Dangerous 2-2
- F**
 Fan Speed Control 1-126
 Floor Mat Anchor 1-116
 Fog Light
 Front 1-83
 Front Seats
 Adjustable front seats 1-16
 Adjustable headrests 1-18
 Adjusting seat forward and rearward 1-16
 Adjusting seatback angle 1-17
 Fuel
 Capacity 9-2
 Gauge 1-70
 Recommendations 1-2
 Fuel Filler Lid
 Remote release 1-113
 Full-time AWD Operation 2-17
 Fuses 6-17
 Fuse panel description 6-32
- G**
 General Checks 6-4
 Glove Box 1-95
- H**
 Hazard Warning System 1-83
 Heating and Cooling Control 1-125
 Heating and Ventilation
 Air flow control 1-127

Air intake control switch	1-126
Bi-level heating	1-128
Defrosting / Defogging	1-133
Fan speed control (Blower control)	1-126
Temperature control	1-130
High-Mounted Rear Stop Light	1-112
Hood Release	1-115
Horn	1-119

I

Ignition Switch	2-5
Instrument Cluster and Indicator Lights	1-62
Instrument Panel Light Control (Rheostat)	1-84
Interior Light	1-93

J

Jump Starting	3-3
---------------------	-----

K

Keys	1-3
If you lose your keys	3-21
Positions	2-5

L

Light Bulbs Replacement	6-24
Luggage Compartment	1-109
Cargo security screen	1-109
Luggage Net	1-110
Luggage under tray	1-111

M**Maintenance Intervals**

Explanation of scheduled maintenance items	5-7
Maintenance under severe usage conditions	5-6
Scheduled maintenance	5-4
Service requirements	5-2

Mirrors

Automatic Dimming Rear View Mirror With Compass	1-100
Day-night inside rearview mirror	1-99
Homelink mirror	1-102
Outside rearview mirror	1-97
Outside rearview mirror Heater	1-98

O

Odometer / Trip Odometer	1-71
Occupant Classification System	1-52

P

Parking Brake	1-108
Power Outlet	1-86
Power Steering Fluid Level	6-23

R**Rear Seat**

Adjusting seatback angle	1-22
Folding rear seatback	1-23
Rear Window Defroster Switch	1-88
Reporting Safety Defects	8-17
Risk of Rollover	2-3
Roof Rack	1-111

S	
Seat	
Front	1-16
Rear	1-22
Seat warmer	1-22
Seat Belts	
3-point system	1-31
Pretensioner seat belt	1-41
Adjusting your seat belt	1-30
Care of seat belts	1-29
Precautions	1-27
Shop Manual	8-14
Sound	
Brake pad warning sound	1-69
Speedometer	1-71
Starting Procedure	2-7
Steering Wheel Tilt Lever	1-118
Stereo Sound System	1-144
Sunglass Holder	1-95
Sunroof	1-89
Sun Visor	1-116
T	
Tachometer	1-71
Tail Gate	1-109
Theft-Alarm System	1-11
Ticket Holder	1-118
Tires	
Aging	8-13
Balancing	8-12
Chains	8-10
Changing a flat tire	3-12
If you have a flat tire	3-12
Information	8-3
Maintenance	8-13
Pressure	8-3
Replacement	8-12
Rotation	8-11
Sidewall Labeling	8-6
Snow tires	8-10
Spare tire	3-10
Terminology and Definition	8-8
Tire Pressure Monitoring System (TPMS)	3-5
Traction	8-12
Towing	
A trailer (or vehicle)	2-27
Emergency	3-20
If your car must be towed	3-18
Trailer Connector	2-31
Transaxle	
Automatic	2-10
Automatic transaxle fluid checking	6-12
Manual	2-7
Manual transaxle oil checking	6-11
Trip Computer	1-73
V	
Vehicle Identification Number	8-2
Vehicle Load Limit	2-32

Vehicle Specifications

Engine	9-3
Lubrication chart	9-4
Dimensions	9-2

W

Warning and Indicator Lights	1-64
Windows	
Power	1-15
Windshield Wiper and Washer	1-78
Rear Window wiper and washer switch	1-82
Windshield Wiper Blade De-icer	1-84
Windshield Wiper Blades	6-9
Winter Driving	2-24

تلفن شبانه روزی: ۰۲۱-۸۸۶۲۰۸۵

FarmaSOS.com

A000A01A-AAT

This Owner's Manual should be considered a part of the car and remain with it when it is sold for the use of the next owner.

OWNER'S I.D.		
ORIGINAL OWNER	_____	
ADDRESS	_____	
CITY	STATE	ZIP CODE
_____	_____	_____
DELIVERY DATE	_____	
(Date Sold to Original Retail purchaser)		
DEALER NAME	DEALER NO.	_____
_____	_____	_____
ADDRESS	_____	
CITY	STATE	ZIP CODE
_____	_____	_____

SERVICE STATION INFORMATION FUEL:

UNLEADED gasoline only
Pump Octane Rating of 87 (Research Octane Number 91) or higher.

FUEL TANK CAPACITY

Original, US.gal (Imp.gal., liter) 19.8 (16.5, 75)

TIRE PRESSURE:

See the label on the driver's side of the center pillar outer panel.

OTHER TIRE INFORMATION:

See page 8-3.

HOOD RELEASE:

Pull handle under left side of dash.

ENGINE OIL:

API grade SJ, SL or ABOVE / ILSAC grade GF-3 or ABOVE and fuel efficient oil. Use SAE 5W-20, 5W-30 or 10W-30 if normal temperatures are above 0°F (-18°C). For other viscosity recommendations, see page 6-5 or 9-4.

AUTOMATIC TRANSAXLE:

Apply the parking brake, with the engine running, shift the selector lever through all ranges and return to "N" (Neutral) position. Then check the level of fluid on the dipstick. Use only HYUNDAI GENUINE ATF SP III, DIAMOND ATF SP III, SK ATF SP III or other brands meeting the SP III specification approved by Hyundai Motor Co..

QUICK INDEX

- o Car will not start 3-2
- o Flat tire 3-12
- o Warning light/chime comes on 1-64 ~ 1-70
- o Engine overheats 3-4
- o Towing of your vehicle 3-18
- o Starting the engine 2-4
- o Driving tips for first 1,200 miles (2,000 km) 1-3
- o Scheduled maintenance 5-4
- o Reporting safety defects 8-17

فارس درو فارس
۰۲۱-۸۸۶۲۰۸۰
FarmaS