

	Pictorial index	Search by illustration	
1	For safety and security	Make sure to read through them	
2	Instrument cluster	How to read the gauges and meters, the variety of warning lights and indicators, etc.	
3	Operation of component	Opening and closing the doors and windows, adjustment before driving, etc.	
4	Driving	Operations and advices which are necessary for driving	
5	Lexus Display Audio System	Operating the Lexus Display Audio system	
6	Interior features	Usage of the interior features, etc.	
7	Maintenance and care	Caring for your vehicle and maintenance procedures	
8	When trouble arises	What to do in case of malfunction or emergency	
9	Vehicle specifications	Vehicle specifications, customizable features, etc.	
	Index	Search by symptom	
		Search alphabetically	

For your information..... 8
 Reading this manual 10
 How to search 11
 Pictorial index 12

1 For safety and security

1-1. For safe use
 Before driving 32
 For safety drive 34
 Seat belts 36
 SRS airbags 41
 Airbag manual on-off system 52
 Pop Up Hood..... 54
 Safety information for children 57
 Child restraint systems 58
 Installing child restraints 67
 Exhaust gas precautions 76
 1-2. Theft deterrent system
 Engine immobilizer system. 77
 Double locking system..... 82
 Alarm 83

2 Instrument cluster

2. Instrument cluster
 Warning lights and indicators 90
 Gauges and meters 95
 Multi-information display . 100
 Fuel consumption information..... 106

3 Operation of each components

3-1. Key information
 Keys 112
 3-2. Opening, closing and locking the doors and trunk
 Doors 118
 Trunk 125
 Smart entry & start system 130
 3-3. Adjusting the seats
 Front seats 145
 Rear seats 147
 Driving position memory .. 149
 Head restraints..... 154

3-4. Adjusting the steering wheel and mirrors		
Steering wheel..... 157		
Inside rear view mirror..... 159		
Outside rear view mirrors . 161		
3-5. Opening, closing the windows and moon roof		
Power windows 165		
Moon roof 168		
4 Driving		
4-1. Before driving		
Driving the vehicle..... 174		
Cargo and luggage..... 181		
Trailer towing..... 182		
4-2. Driving procedures		
Engine (ignition) switch.... 190		
Automatic transmission..... 195		
Turn signal lever 201		
Parking brake 203		
4-3. Operating the lights and wipers		
Headlight switch 204		
Automatic High Beam 207		
Fog light switch..... 211		
Windshield wipers and washer 213		
4-4. Refueling		
Opening the fuel tank cap . 219		
4-5. Using the driving support systems		
Cruise control 223	1	
Dynamic radar cruise control 227		
LDA (Lane Departure Alert).... 239	2	
Lexus parking assist-sensor 245	3	
Rear view monitor system. 252		
Driving mode select switch 261	4	
Driving assist systems 263		
PCS (Pre-Crash Safety system) 269	5	
BSM (Blind Spot Monitor) 276		
• The Blind Spot Monitor function 281	6	
• The Rear Crossing Traffic Alert function..... 283	7	
4-6. Driving tips		
Winter driving tips 286	8	

<p>5 Lexus Display Audio system</p> <p>5-1. Basic Operations</p> <p style="padding-left: 20px;">Lexus Display Audio System..... 292</p> <p style="padding-left: 20px;">Steering wheel audio switches..... 298</p> <p style="padding-left: 20px;">USB/AUX ports 299</p> <p>5-2. Setup</p> <p style="padding-left: 20px;">Setup menu..... 300</p> <p style="padding-left: 20px;">General settings..... 301</p> <p style="padding-left: 20px;">Voice settings 304</p> <p style="padding-left: 20px;">Display settings..... 305</p> <p>5-3. Using the audio system</p> <p style="padding-left: 20px;">Selecting the audio source 306</p> <p style="padding-left: 20px;">Optimal use of the audio system 307</p> <p style="padding-left: 20px;">Audio settings 308</p> <p style="padding-left: 20px;">Audio menu screen operation 312</p> <p>5-4. Using the radio</p> <p style="padding-left: 20px;">Radio operation 315</p>	<p>5-5. Playing an audio CD and MP3/WMA/AAC discs</p> <p style="padding-left: 20px;">CD player operation 317</p> <p>5-6. Using an external device</p> <p style="padding-left: 20px;">Listening to an iPod 324</p> <p style="padding-left: 20px;">Using USB memory device 327</p> <p style="padding-left: 20px;">Using the AUX port 332</p> <p>5-7. Connecting Bluetooth®</p> <p style="padding-left: 20px;">Steps for using Bluetooth® devices..... 333</p> <p style="padding-left: 20px;">Registering a Bluetooth® device 335</p> <p style="padding-left: 20px;">Selecting a Bluetooth® device 336</p> <p style="padding-left: 20px;">Connecting a Bluetooth® audio player..... 337</p> <p style="padding-left: 20px;">Connecting a Bluetooth® phone..... 338</p> <p style="padding-left: 20px;">Displaying a Bluetooth® device details..... 339</p> <p style="padding-left: 20px;">Detailed Bluetooth® settings 340</p> <p>5-8. Bluetooth® Audio</p> <p style="padding-left: 20px;">Listening to Bluetooth® Audio..... 341</p>
--	--

5-9. Bluetooth® Phone	
Using a Bluetooth® Phone	343
Making a call.....	345
Receiving a call.....	348
Speaking on the phone	349
Using a Bluetooth® phone messages	351
Using the steering wheel switches.....	354
Bluetooth® phone settings	355
5-10. Phonebook	
Contact settings.....	357
Messaging setting.....	360
5-11. Bluetooth®	
Bluetooth®	361
5-12. Other function	
“Information” screen.....	366
MirrorLink™	367
USB photo.....	369
Speech command system ..	371
6 Interior features	
6-1. Using the air conditioning system	
Automatic air conditioning system	374
Heated steering wheel/ seat heaters/ seat ventilators	385
6-2. Using the interior lights	
Interior lights list.....	387
• Interior lights	388
• Personal lights.....	388
6-3. Using the storage features	
List of storage features.....	389
• Glove box.....	390
• Console box	390
• Cup holders/ Bottle holders.....	391
Trunk features	393
6-4. Using the other interior features	
Other interior features	396
• Sun visors.....	396
• Vanity mirrors	396
• Clock	396
• Power outlet	397
• Armrest	398
• Rear sunshade	398
• Assist grips.....	400
• Coat hooks	400

7 Maintenance and care

- 7-1. Maintenance and care
 - Cleaning and protecting the vehicle exterior 402
 - Cleaning and protecting the vehicle interior 406
- 7-2. Maintenance
 - Maintenance requirements 409
- 7-3. Do-it-yourself maintenance
 - Do-it-yourself service precautions 411
 - Hood 413
 - Positioning a floor jack 414
 - Engine compartment 415
 - Tires 425
 - Tire inflation pressure 435
 - Wheels 437
 - Air conditioning filter 439
 - Electronic key battery 441
 - Checking and replacing fuses 444
 - Light bulbs 448

8 When trouble arises

- 8-1. Essential information
 - Emergency flashers 466
 - If your vehicle has to be stopped in an emergency 467
- 8-2. Steps to take in an emergency
 - If your vehicle needs to be towed 468
 - If you think something is wrong 473
 - Fuel pump shut off system 474
 - If a warning light turns on or a warning buzzer sounds 475
 - If a warning message is displayed 481
 - If you have a flat tire (vehicles with a spare tire) 495
 - If you have a flat tire (vehicles without a spare tire) 506
 - If the engine will not start . 520
 - If the shift lever cannot be shifted from P 522
 - If the electronic key does not operate properly 523
 - If the vehicle battery is discharged 526
 - If your vehicle overheats... 530
 - If the vehicle becomes stuck 533

9 Vehicle specifications

- 9-1. Specifications
 Maintenance data
 (fuel, oil level, etc.)..... 536
 Fuel information..... 547
- 9-2. Customization
 Customizable features 549
- 9-3. Items to initialize
 Items to initialize..... 559

Index

- What to do if...
 (Troubleshooting) 562
 Alphabetical index 566

تلفن شبانه روزی: ۰۲۱-۸۸۶۲۰۸۵

FarmaSOS.com

For vehicles with a navigation system, refer to the “Navigation System Owner’s Manual” for information regarding the equipment listed below.

- Navigation system
- Audio/video system
- Lexus parking assist-sensor
- Lexus parking assist monitor

For your information

Main Owner's Manual

Please note that this manual applies to all models and explains all equipment, including options. Therefore, you may find some explanations for equipment not installed on your vehicle.

All specifications provided in this manual are current at the time of printing. However, because of the Lexus policy of continual product improvement, we reserve the right to make changes at any time without notice.

Depending on specifications, the vehicle shown in the illustrations may differ from your vehicle in terms of color and equipment.

Accessories, spare parts and modification of your Lexus

Both genuine Lexus and a wide variety of other spare parts and accessories for Lexus vehicles are currently available on the market. Should it be determined that any of the genuine Lexus parts or accessories supplied with the vehicle need to be replaced, Lexus recommends that genuine Lexus parts or accessories, be used to replace them. Other parts or accessories of matching quality can also be used. Lexus cannot accept any liability or guarantee spare parts and accessories which are not genuine Lexus products, nor for replacement or installation involving such parts. In addition, damage or performance problems resulting from the use of non-genuine Lexus spare parts or accessories may not be covered under warranty.

Installation of an RF-transmitter system تلفن شبانه روزی

The installation of an RF-transmitter system in your vehicle could affect electronic systems such as:

- Multiport fuel injection system/sequential multiport fuel injection system
- Dynamic radar cruise control system
- Cruise control system
- Anti-lock brake system
- Vehicle dynamics integrated management
- SRS airbag system
- Seat belt pretensioner system

Be sure to check with any authorized Lexus dealer or repairer, or another duly qualified and equipped professional for precautionary measures or special instructions regarding installation of an RF-transmitter system.

Further information regarding frequency bands, power levels, antenna positions and installation provisions for the installation of RF-transmitters, is available on request at any authorized Lexus dealer or repairer, or another duly qualified and equipped professional.

Scrapping of your Lexus

The SRS airbag and seat belt pretensioner devices in your Lexus contain explosive chemicals. If the vehicle is scrapped with the airbags and seat belt pretensioners left as they are, this may cause an accident such as fire. Be sure to have the systems of the SRS airbag and seat belt pretensioner removed and disposed of by a qualified service shop or by any authorized Lexus dealer or repairer, or another duly qualified and equipped professional before you scrap your vehicle.



Your vehicle contains batteries and/or accumulators. Do not discard them into the environment but cooperate with separate collection (Directive 2006/66/EC).

CAUTION

■ General precautions while driving

Driving under the influence: Never drive your vehicle when under the influence of alcohol or drugs that have impaired your ability to operate your vehicle. Alcohol and certain drugs delay reaction time, impair judgment and reduce coordination, which could lead to an accident that could result in death or serious injury.

Defensive driving: Always drive defensively. Anticipate mistakes that other drivers or pedestrians might make and be ready to avoid accidents.

Driver distraction: Always give your full attention to driving. Anything that distracts the driver, such as adjusting controls, talking on a cellular phone or reading can result in a collision with resulting death or serious injury to you, your occupants or others.

■ General precaution regarding children's safety

Never leave children unattended in the vehicle, and never allow children to have or use the key.

Children may be able to start the vehicle or shift the vehicle into neutral. There is also a danger that children may injure themselves by playing with the windows, the moon roof, or other features of the vehicle. In addition, heat build-up or extremely cold temperatures inside the vehicle can be fatal to children.

Reading this manual

- ⚠ CAUTION:**
Explains something that, if not obeyed, could cause death or serious injury to people.
- ⚠ NOTICE:**
Explains something that, if not obeyed, could cause damage to or a malfunction in the vehicle or its equipment.
- 1 2 3 ...** Indicates operating or working procedures. Follow the steps in numerical order.
- ➔** Indicates the action (pushing, turning, etc.) used to operate switches and other devices.
- ⇒** Indicates the outcome of an operation (e.g. a lid opens).
- ➔** Indicates the component or position being explained.
- ⊘** Means “Do not”, “Do not do this”, or “Do not let this happen”.

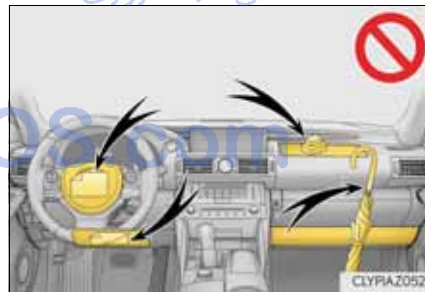
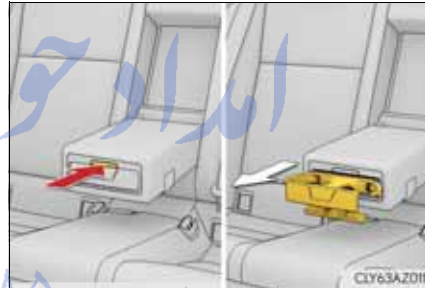

How to search

- Searching by name
 - Alphabetical index P. 566

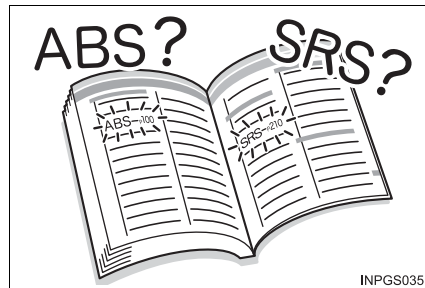

- Searching by installation position
 - Pictorial index P. 12



- Searching by symptom or sound
 - What to do if... (Troubleshooting)..... P. 562



- Searching by title
 - Table of contents P. 2

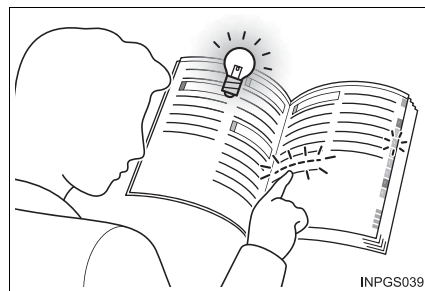

Pictorial index

■ Exterior

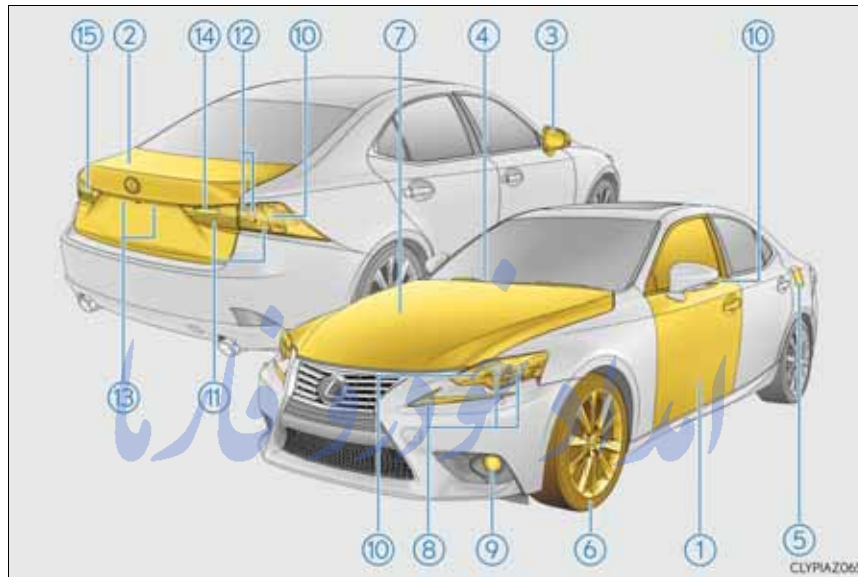

The shape of the headlights may differ depending on the grade, etc. (→P. 448)

- ① Doors. P. 118
 - Locking/unlocking. P. 118
 - Opening/closing the door glasses P. 165
 - Locking/unlocking by using the mechanical key P. 523
 - Warning lights/warning messages P. 477, 483
- ② Trunk. P. 125
 - Opening from inside the cabin P. 125
 - Opening from outside P. 125
 - Opening by using the mechanical key. P. 523
 - Warning lights/warning messages. P. 477, 483
- ③ Outside rear view mirrors P. 161
 - Adjusting the mirror angle P. 161
 - Folding the mirrors P. 162
 - Driving position memory*1 P. 149
 - Defogging the mirrors P. 380

- ④ Windshield wipers P. 213
 - Precautions against winter season P. 286
 - To prevent freezing (windshield wiper de-icer)*¹ P. 381
 - Precautions against car wash P. 404
- ⑤ Fuel filler door P. 219
 - Refueling method P. 219
 - Fuel type/fuel tank capacity P. 538
- ⑥ Tires P. 425
 - Tire size/inflation pressure P. 544
 - Winter tires/tire chain P. 286
 - Checking/rotation/tire pressure warning system*¹ P. 425
 - Coping with flat tires P. 495, 506
- ⑦ Hood P. 413
 - Opening P. 413
 - Engine oil P. 539
 - Coping with overheat P. 530
 - Warning messages P. 483

Light bulbs of the exterior lights for driving

(Replacing method: P. 448, Watts: P. 546)

- ⑧ Headlights/front position lights/daytime running lights P. 204
- ⑨ Front fog lights*¹ P. 211
- ⑩ Turn signal lights P. 201
- ⑪ Tail lights P. 204
- ⑫ Stop lights
 - Emergency brake signal P. 264
- ⑬ License plate lights P. 204
- ⑭ Rear fog light*³ P. 211
 - Back up light*² P. 195
 - Shifting the shift lever to R P. 195
- ⑮ Rear fog light*² P. 211
 - Back up light*³ P. 195
 - Shifting the shift lever to R P. 195

*¹: If equipped

*²: Left-hand drive vehicles

*³: Right-hand drive vehicles

■ Instrument panel (Left-hand drive vehicles)

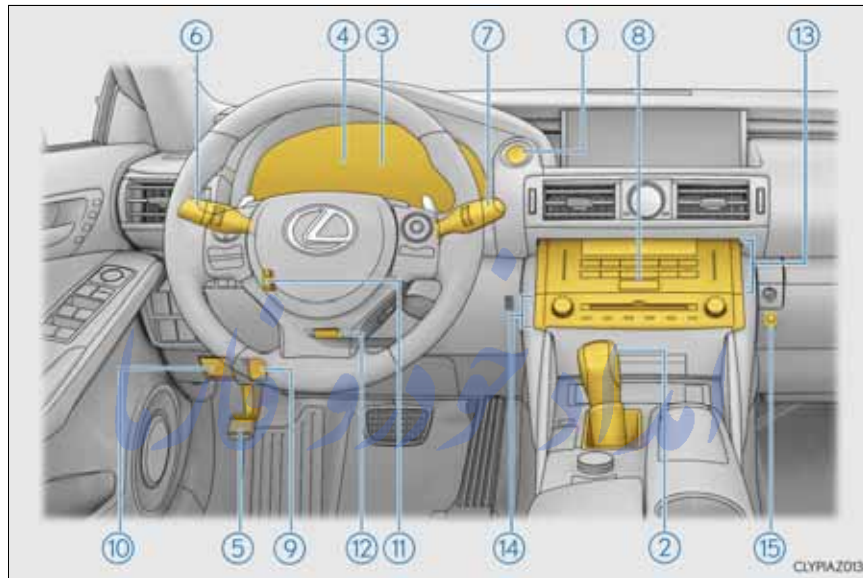

- ① Engine switch P. 190
 Starting the engine/changing the modes P. 190
 Emergency stop of the engine P. 467
 When the engine will not start. P. 520
 Warning messages P. 490
- ② Shift lever P. 195
 Changing the shift position P. 195
 Precautions against towing P. 468
 When the shift lever does not move P. 522
- ③ Meters P. 95
 Reading the meters/adjusting the instrument panel light P. 95
 Warning lights/indicator lights P. 90
 When the warning lights come on. P. 475

④	Multi-information display	P. 100
	Display	P. 100
	When the warning messages are displayed	P. 481
⑤	Parking brake	P. 203
	Applying/releasing	P. 203
	Precautions against winter season	P. 287
	Warning buzzer/message	P. 481
⑥	Turn signal lever	P. 201
	Headlight switch	P. 204
	Headlights/front position lights/tail lights/daytime running lights	P. 204
	Front fog lights* ¹ /rear fog light	P. 211
⑦	Windshield wiper and washer switch	P. 213
	Usage	P. 213
	Adding washer fluid	P. 424
	Warning messages	P. 488
⑧	Emergency flasher switch	P. 466
⑨	Trunk opener	P. 125
⑩	Hood lock release lever	P. 413
⑪	Tilt and telescopic steering control switch* ¹	P. 157
	Adjustment	P. 157
	Driving position memory* ¹	P. 149
⑫	Tilt and telescopic steering lock release lever* ¹	P. 157
	Adjustment	P. 157
⑬	Air conditioning system	P. 374
	Usage	P. 374
	Rear window defogger	P. 380
⑭	Audio system* ²	P. 292
	Audio system	P. 292
	Hands-free system	P. 343
⑮	Trunk opener main switch	P. 126

*¹: If equipped

*²: For vehicles with a navigation system, refer to “Navigation System Owner’s Manual”.

■ Switches (Left-hand drive vehicles)

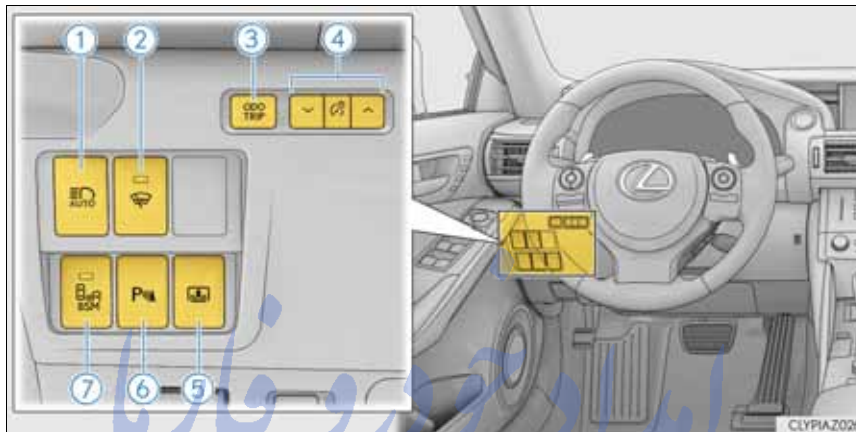

- ① Automatic high beam switch*¹ P. 207
- ② Windshield wiper de-icer switch*¹ P. 381
- ③ Odometer/trip meter and trip meter reset button P. 97
- ④ Instrument panel light control switches P. 98
- ⑤ Rear sunshade switch*¹ P. 398
- ⑥ Lexus parking assist-sensor switch*^{1, 2} P. 245
- ⑦ BSM (Blind Spot Monitor) main switch*¹ P. 276

FarmaSOS.com

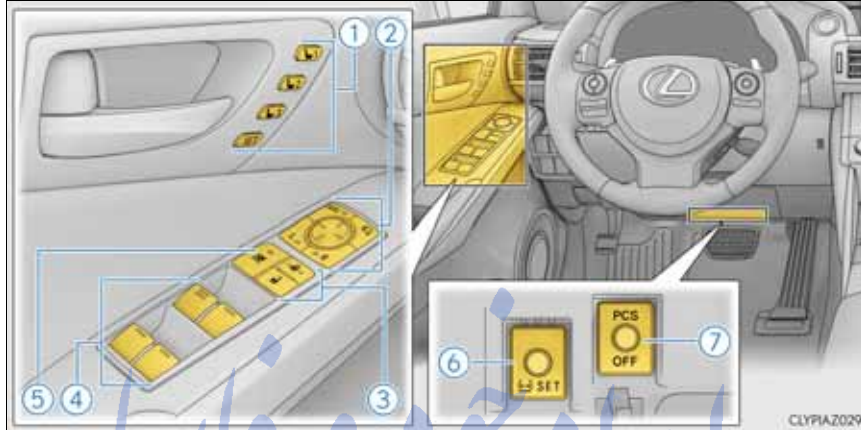

- ① Driving position memory switches*¹ P. 149
- ② Outside rear view mirror switches P. 161
- ③ Door lock switches P. 121
- ④ Power window switches P. 165
- ⑤ Window lock switch P. 165
- ⑥ Tire pressure warning reset switch*¹ P. 427
- ⑦ PCS OFF switch*¹ P. 270

FarmaSOS.com

*¹: If equipped

*²: For vehicles with a navigation system, refer to "Navigation System Owner's Manual".



- ① Audio remote control switches*¹ P. 298
- ② Paddle shift switches. P. 197
- ③ Meter control switches P. 101
- ④ Vehicle-to-vehicle distance button*² P. 230
- ⑤ Cruise control switch*²
 Cruise control*² P. 223
 Dynamic radar cruise control*² P. 227
- ⑥ LDA (Lane Departure Alert) switch*² P. 239
- ⑦ Talk switch*¹ P. 354
- ⑧ Telephone switches*¹ P. 354

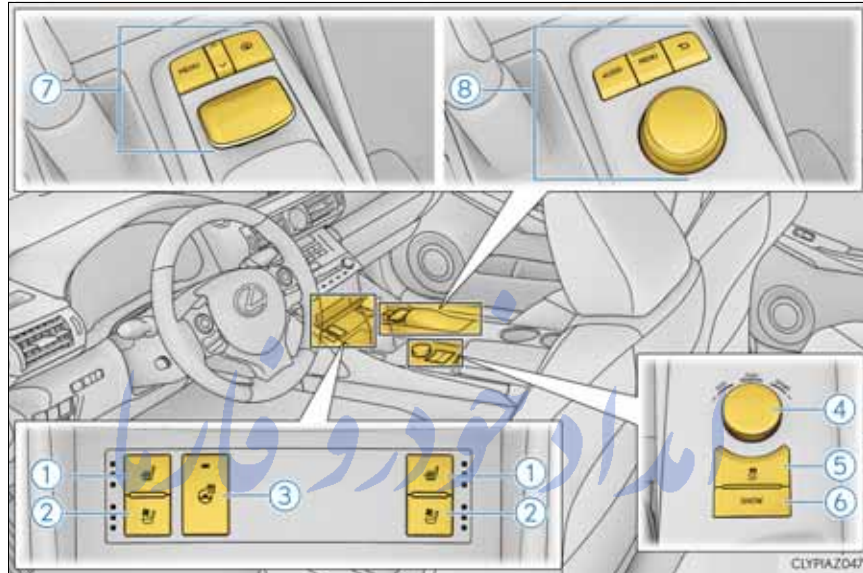

- ① Seat heater switches*² P. 386
- ② Seat ventilator switches*² P. 386
- ③ Heated steering wheel switch*² P. 385
- ④ Driving mode select switch. P. 261
- ⑤ VSC OFF switch. P. 265
- ⑥ Snow mode switch P. 196
- ⑦ Remote Touch*^{2, 3}
- ⑧ Lexus Display Audio controller*² P. 294

*1: For vehicles with a navigation system, refer to “Navigation System Owner’s Manual”.

*2: If equipped

*3: Refer to “Navigation System Owner’s Manual”.

■ Interior (Left-hand drive vehicles)

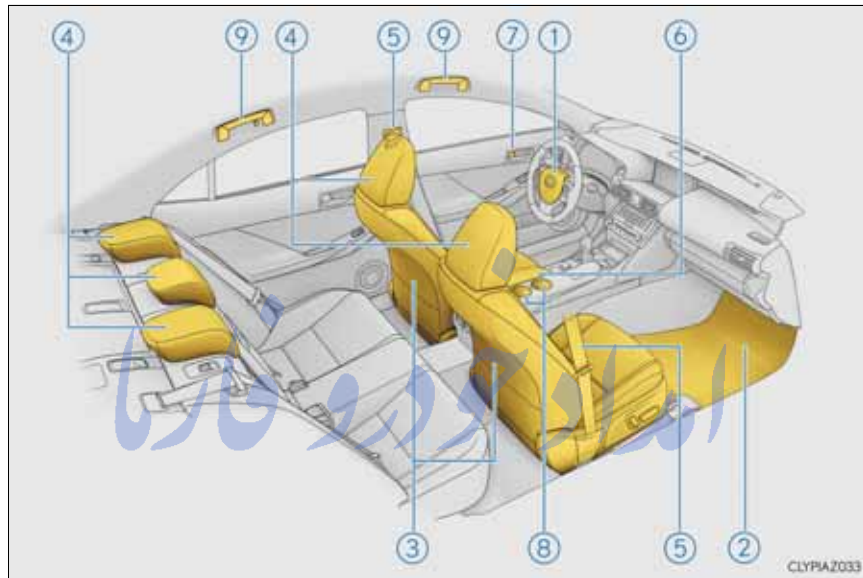

- ① SRS airbags P. 41
 ② Floor mats P. 32
 ③ Front seats P. 145
 ④ Head restraints P. 154
 ⑤ Seat belts P. 36
 ⑥ Console box P. 390
 ⑦ Inside lock buttons P. 121
 ⑧ Cup holders P. 391
 ⑨ Assist grips P. 400

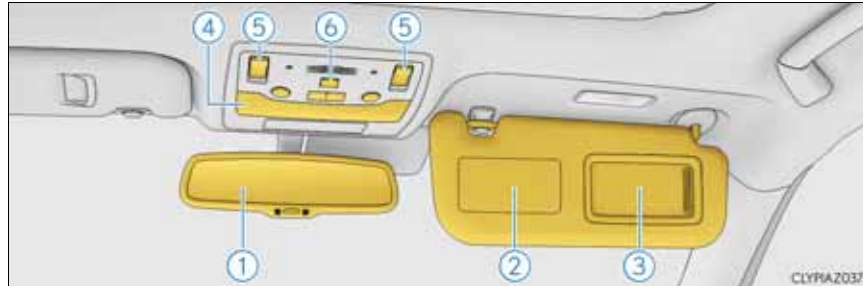

- ① Inside rear view mirrorP. 159
- ② Sun visors*¹P. 396
- ③ Vanity mirrorsP. 396
- ④ Interior lightP. 388
- Personal lights*²P. 388
- ⑤ Moon roof switches*³P. 168
- ⑥ Intrusion sensor cancel switch*³P. 86
- Intrusion sensor and tilt sensor cancel switch*³P. 86

تلفن شبانه روزی: ۰۲۱-۸۸۶۲۰۸۵

FarmaSOS.com

*1: NEVER use a rearward facing child restraint on a seat protected by an ACTIVE AIRBAG in front of it, DEATH or SERIOUS INJURY to the CHILD can occur. (→P. 74)



*2: The illustration shows the front, but they are also equipped in the rear.

*3: If equipped

■ Instrument panel (Right-hand drive vehicles)

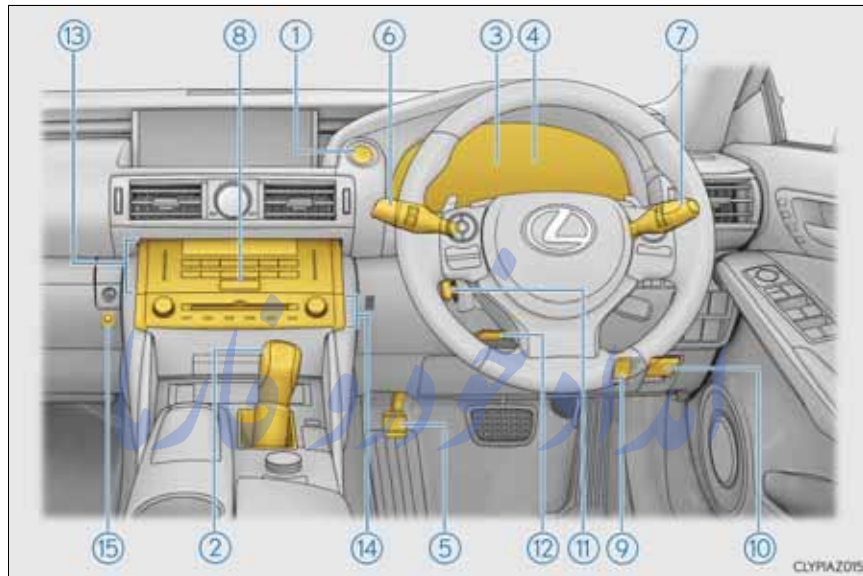

- ① Engine switch P. 190
 Starting the engine/changing the modes P. 190
 Emergency stop of the engine P. 467
 When the engine will not start P. 520
 Warning messages P. 490
- ② Shift lever P. 195
 Changing the shift position P. 195
 Precautions against towing P. 468
 When the shift lever does not move P. 522
- ③ Meters P. 95
 Reading the meters/adjusting the instrument panel light P. 95
 Warning lights/indicator lights P. 90
 When the warning lights come on P. 475

- ④ Multi-information display P. 100
 Display P. 100
 When the warning messages are displayed P. 481
- ⑤ Parking brake P. 203
 Applying/releasing P. 203
 Precautions against winter season P. 287
 Warning buzzer/message P. 481
- ⑥ Turn signal lever P. 201
 Headlight switch P. 204
 Headlights/front position lights/tail lights/daytime running lights P. 204
 Front fog lights*¹/rear fog light P. 211
- ⑦ Windshield wiper and washer switch P. 213
 Usage P. 213
 Adding washer fluid P. 424
 Warning messages P. 488
- ⑧ Emergency flasher switch P. 466
- ⑨ Trunk opener P. 125
- ⑩ Hood lock release lever P. 413
- ⑪ Tilt and telescopic steering control switch*¹ P. 157
 Adjustment P. 157
 Driving position memory*¹ P. 149
- ⑫ Tilt and telescopic steering lock release lever*¹ P. 157
 Adjustment P. 157
- ⑬ Air conditioning system P. 374
 Usage P. 374
 Rear window defogger P. 380
- ⑭ Audio system*² P. 292
 Audio system P. 292
 Hands-free system P. 343
- ⑮ Trunk opener main switch P. 126

*¹: If equipped

*²: For vehicles with a navigation system, refer to "Navigation System Owner's Manual".

■ Switches (Right-hand drive vehicles)

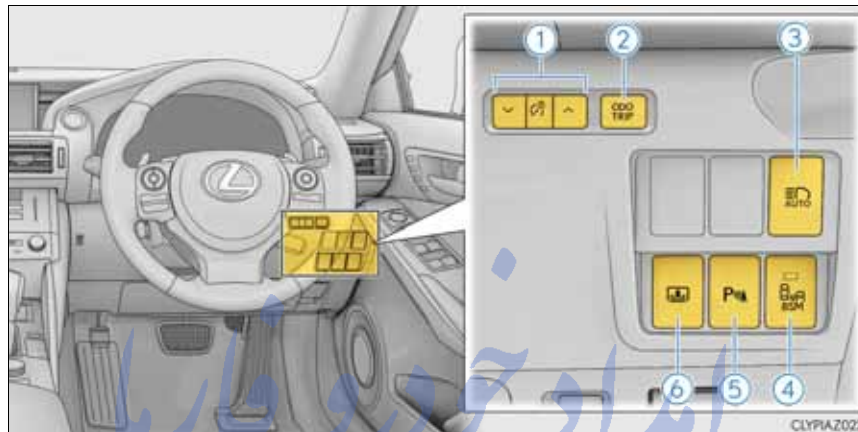

- ① Instrument panel light control switches P. 98
- ② Odometer/trip meter and trip meter reset button P. 97
- ③ Automatic high beam switch*¹ P. 207
- ④ BSM (Blind Spot Monitor) main switch*¹ P. 276
- ⑤ Lexus parking assist-sensor switch*^{1,2}: تلفن شبانه روزی P. 245
- ⑥ Rear sunshade switch*¹ P. 398

FarmaSOS.com

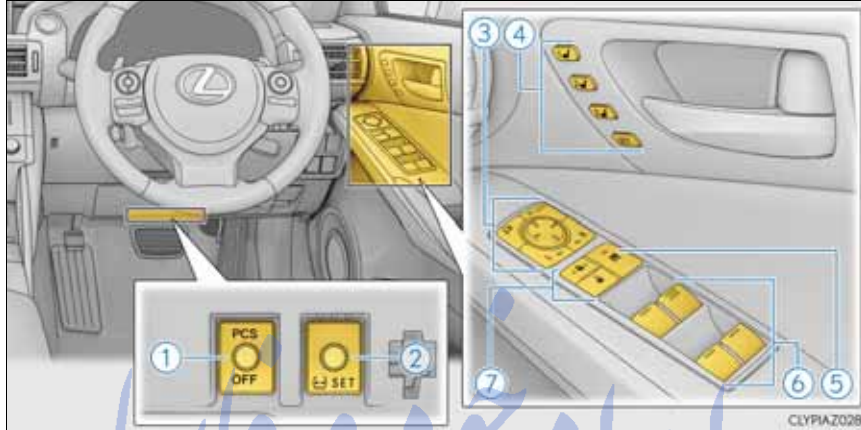

- ① PCS OFF switch*¹ P. 270
- ② Tire pressure warning reset switch P. 427
- ③ Outside rear view mirror switches P. 161
- ④ Driving position memory switches*¹ P. 149
- ⑤ Window lock switch P. 165
- ⑥ Power window switches P. 165
- ⑦ Door lock switches P. 121

FarmaSOS.com

*¹: If equipped

*²: For vehicles with a navigation system, refer to "Navigation System Owner's Manual".



- ① Audio remote control switches*¹ P. 298
- ② Paddle shift switches. P. 197
- ③ Meter control switches P. 101
- ④ Vehicle-to-vehicle distance button*² P. 230
- ⑤ Cruise control switch*²
 Cruise control*² P. 223
 Dynamic radar cruise control*² P. 227
- ⑥ LDA (Lane Departure Alert) switch*² P. 239
- ⑦ Talk switch*¹ P. 354
- ⑧ Telephone switches*¹ P. 354

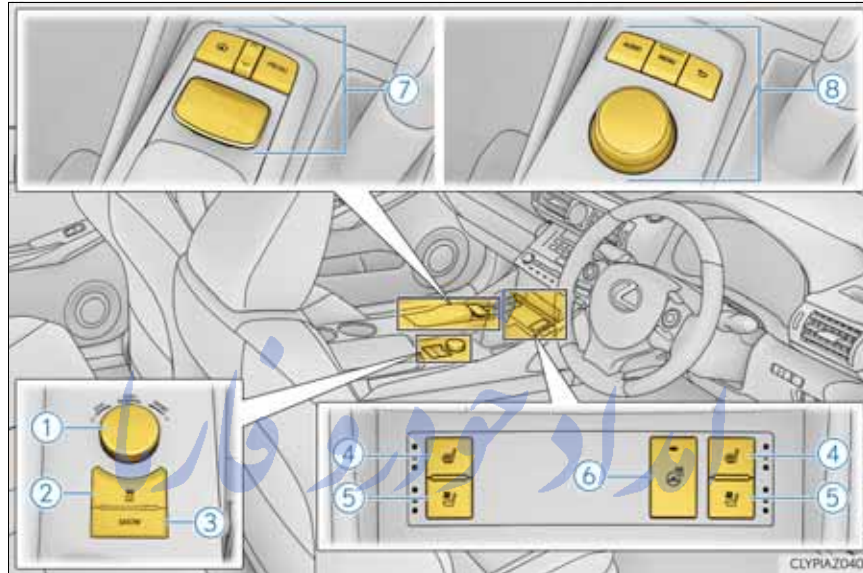

- ① Driving mode select switch. P. 261
- ② VSC OFF switch. P. 265
- ③ Snow mode switch P. 196
- ④ Seat heater switches*² P. 386
- ⑤ Seat ventilator switches*² P. 386
- ⑥ Heated steering wheel switch*² P. 385
- ⑦ Remote Touch*^{2, 3}
- ⑧ Lexus Display Audio controller*² P. 294

*1: For vehicles with a navigation system, refer to “Navigation System Owner’s Manual”.

*2: If equipped

*3: Refer to “Navigation System Owner’s Manual”.

■ Interior (Right-hand drive vehicles)

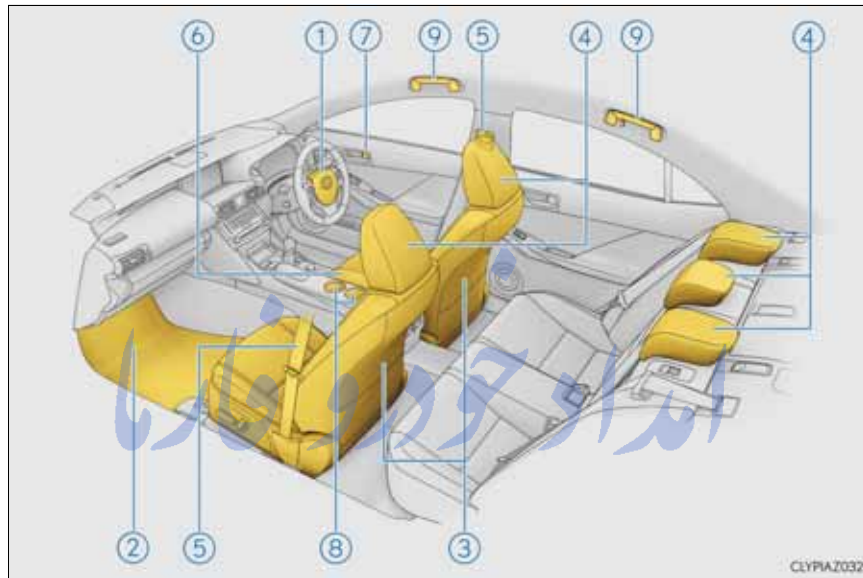

- ① SRS airbags P. 41
 ② Floor mats P. 32
 ③ Front seats P. 145
 ④ Head restraints P. 154
 ⑤ Seat belts P. 36
 ⑥ Console box P. 390
 ⑦ Inside lock buttons P. 121
 ⑧ Cup holders P. 391
 ⑨ Assist grips P. 400

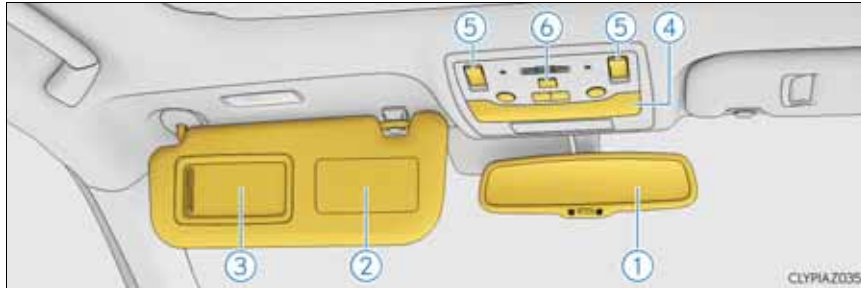

- ① Inside rear view mirrorP. 159
- ② Sun visors*¹P. 396
- ③ Vanity mirrorsP. 396
- ④ Interior lightP. 388
Personal lights*²P. 388
- ⑤ Moon roof switches*³P. 168
- ⑥ Intrusion sensor cancel switch*³P. 86
Intrusion sensor and tilt sensor cancel switch*³P. 86

تلفن شبانه روزی: ۰۲۱-۸۸۶۲۰۸۵

FarmaSOS.com

*1: NEVER use a rearward facing child restraint on a seat protected by an ACTIVE AIRBAG in front of it, DEATH or SERIOUS INJURY to the CHILD can occur. (→P. 74)



*2: The illustration shows the front, but they are also equipped in the rear.

*3: If equipped

امداد خودرو فارما

تلفن شبانه روزی: ۰۲۱-۸۸۸۶۲۰۸۵

FarmaSOS.com

For safety and security

1

1-1. For safe use

Before driving 32

For safety drive 34

Seat belts 36

SRS airbags 41

Airbag manual on-off
system 52

Pop Up Hood 54

Safety information for
children 57

Child restraint systems 58

Installing child restraints 67

Exhaust gas precautions 76

1-2. Theft deterrent system

Engine immobilizer system 77

Double locking system 82

Alarm 83

Before driving

Floor mat

Use only floor mats designed specifically for vehicles of the same model and model year as your vehicle. Fix them securely in place onto the carpet.

- 1 Insert the retaining hooks (clips) into the floor mat eyelets.

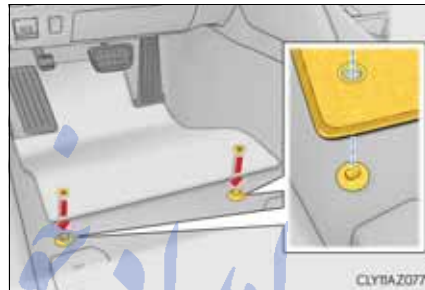

- 2 Turn the upper knob of each retaining hook (clip) to secure the floor mats in place.

*: Always align the \triangle marks.

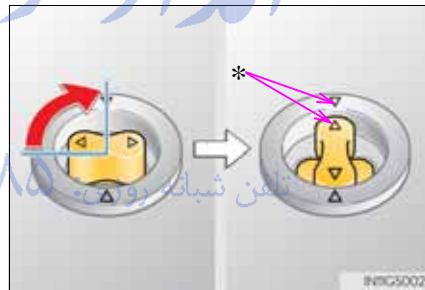

The shape of the retaining hooks (clips) may differ from that shown in the illustration.

⚠ CAUTION

Observe the following precautions.

Failure to do so may cause the driver's floor mat to slip, possibly interfering with the pedals while driving. An unexpectedly high speed may result or it may become difficult to stop the vehicle, leading to an accident, or leading to death or a serious injury.

- When installing the driver's floor mat
 - Do not use floor mats designed for other models or different model year vehicles, even if they are Lexus Genuine floor mats.
 - Only use floor mats designed for the driver's seat.
 - Always install the floor mat securely using the retaining hooks (clips) provided.
 - Do not use two or more floor mats on top of each other.
 - Do not place the floor mat bottom-side up or upside-down.
- Before driving
 - Check that the floor mat is securely fixed in the correct place with all the provided retaining hooks (clips). Be especially careful to perform this check after cleaning the floor.
 - With the engine stopped and the shift lever in P, fully depress each pedal to the floor to make sure it does not interfere with the floor mat



FarmaSOS.com

For safety drive

For safe driving, adjust the seat and mirror to an appropriate position before driving.

Correct driving posture

- ① Adjust the angle of the seatback so that you are sitting straight up and so that you do not have to lean forward to steer. (→P. 145)
- ② Adjust the seat so that you can depress the pedals fully and so that your arms bend slightly at the elbow when gripping the steering wheel. (→P. 145)
- ③ Lock the head restraint in place with the center of the head restraint closest to the top of your ears. (→P. 154)
- ④ Wear the seat belt correctly. (→P. 36)

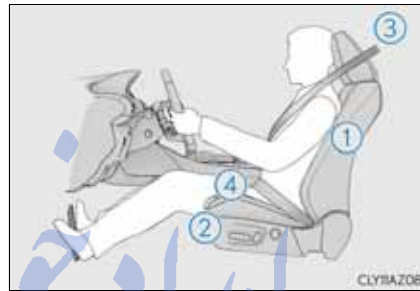

Correct use of the seat belts

Make sure that all occupants are wearing their seat belts before driving the vehicle. (→P. 36)

Use a child restraint system appropriate for the child until the child becomes large enough to properly wear the vehicle's seat belt. (→P. 59)

Adjusting the mirrors

Make sure that you can see backward clearly by adjusting the inside and outside rear view mirrors properly. (→P. 159, 161)

CAUTION

Observe the following precautions.

Failure to do so may result in death or serious injury.

- Do not adjust the position of the driver's seat while driving.
Doing so could cause the driver to lose control of the vehicle.
- Do not place a cushion between the driver or passenger and the seatback.
A cushion may prevent correct posture from being achieved, and reduce the effectiveness of the seat belt and head restraint.
- Do not place anything under the front seats.
Objects placed under the front seats may become jammed in the seat tracks and stop the seat from locking in place. This may lead to an accident and the adjustment mechanism may also be damaged.
- When driving over long distances, take regular breaks before you start to feel tired.
Also, if you feel tired or sleepy while driving, do not force yourself to continue driving and take a break immediately.

تلفن شبانه روزی: ۰۲۱-۸۸۶۲۰۸۵

FarmaSOS.com

Seat belts

Make sure that all occupants are wearing their seat belts before driving the vehicle.

Correct use of the seat belts

- Extend the shoulder belt so that it comes fully over the shoulder, but does not come into contact with the neck or slide off the shoulder.
- Position the lap belt as low as possible over the hips.
- Adjust the position of the seat-back. Sit up straight and well back in the seat.
- Do not twist the seat belt.



Fastening and releasing the seat belt

- ① To fasten the seat belt, push the plate into the buckle until a click sound is heard.
- ② To release the seat belt, press the release button.

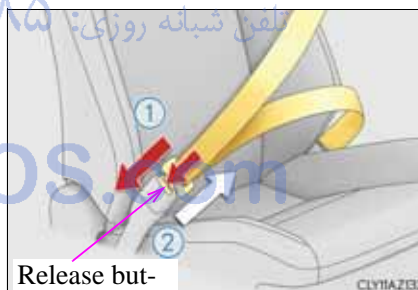

Adjusting the seat belt shoulder anchor height (front seats)

- ① Push the seat belt shoulder anchor down while pressing the release button.
- ② Push the seat belt shoulder anchor up.

Move the height adjuster up and down as needed until you hear a click.



Seat belt pretensioners (front seats)

The pretensioners help the seat belts to quickly restrain the occupant by retracting the seat belts when the vehicle is subjected to certain types of severe frontal collision.

The seat belt pretensioners also activate when the vehicle is subjected to certain types of severe side collision.

The pretensioners do not activate in the event of a minor frontal impact, a minor side impact, a rear impact or a vehicle rollover.

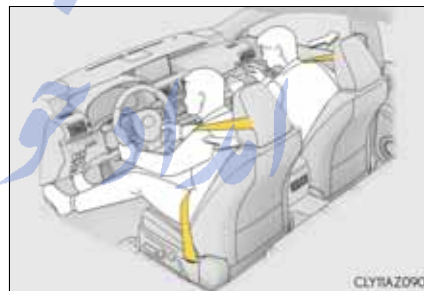

FarmaSOS.com

- After the rear center seat belt has been used
Stow the buckle as shown.

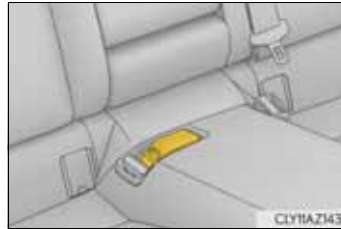

- Emergency locking retractor (ELR)
The retractor will lock the belt during a sudden stop or on impact. It may also lock if you lean forward too quickly. A slow, easy motion will allow the belt to extend so that you can move around fully.
- Child seat belt usage
The seat belts of your vehicle were principally designed for persons of adult size.
 - Use a child restraint system appropriate for the child, until the child becomes large enough to properly wear the vehicle's seat belt. (→P. 59)
 - When the child becomes large enough to properly wear the vehicle's seat belt, follow the instructions regarding seat belt usage. (→P. 36)
- Replacing the belt after the pretensioner has been activated
If the vehicle is involved in multiple collisions, the pretensioner will activate for the first collision, but will not activate for the second or subsequent collisions.
- Seat belt regulations
If seat belt regulations exist in the country where you reside, please contact any authorized Lexus dealer or repairer, or another duly qualified and equipped professional for seat belt replacement or installation.

FarmaSOS.com

⚠ CAUTION

Observe the following precautions to reduce the risk of injury in the event of sudden braking, sudden swerving or an accident.
Failure to do so may cause death or serious injury.

■ Wearing a seat belt

- Ensure that all passengers wear a seat belt.
- Always wear a seat belt properly.
- Each seat belt should be used by one person only. Do not use a seat belt for more than one person at once, including children.
- Lexus recommends that children be seated in the rear seat and always use a seat belt and/or an appropriate child restraint system.
- To achieve a proper seating position, do not recline the seat more than necessary. The seat belt is most effective when the occupants are sitting up straight and well back in the seats.
- Do not wear the shoulder belt under your arm.
- Always wear your seat belt low and snug across your hips.

■ Pregnant women

Obtain medical advice and wear the seat belt in the proper way. (→P. 36)

Women who are pregnant should position the lap belt as low as possible over the hips in the same manner as other occupants, extending the shoulder belt completely over the shoulder and avoiding belt contact with the rounding of the abdominal area.

If the seat belt is not worn properly, not only the pregnant woman, but also the fetus could suffer death or serious injury as a result of sudden braking or a collision.

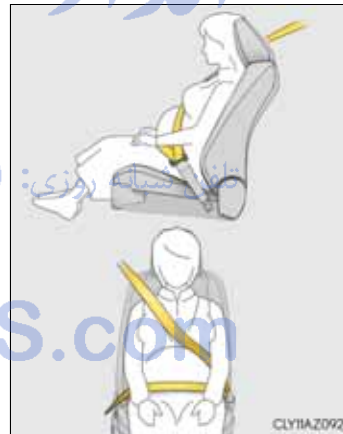

**CAUTION**

- **People suffering illness**
Obtain medical advice and wear the seat belt in the proper way. (→P. 36)
- **When children are in the vehicle**
Do not allow children to play with the seat belt. If the seat belt becomes twisted around a child's neck, it may lead to choking or other serious injuries that could result in death.
If this occurs and the buckle cannot be unfastened, scissors should be used to cut the belt.
- **Seat belt pretensioners**
If the pretensioner has activated, the SRS warning light will come on. In that case, the seat belt cannot be used again and must be replaced at any authorized Lexus dealer or repairer, or another duly qualified and equipped professional.
- **Adjustable shoulder anchor**
Always make sure the shoulder belt is positioned across the center of your shoulder. The belt should be kept away from your neck, but not falling off your shoulder. Failure to do so could reduce the amount of protection in an accident and cause death or serious injuries in the event of a sudden stop, sudden swerve or accident. (→P. 37)
- **Seat belt damage and wear**
 - Do not damage the seat belts by allowing the belt, plate, or buckle to be jammed in the door.
 - Inspect the seat belt system periodically. Check for cuts, fraying, and loose parts. Do not use a damaged seat belt until it is replaced. Damaged seat belts cannot protect an occupant from death or serious injury.
 - Ensure that the belt and plate are locked and the belt is not twisted.
If the seat belt does not function correctly, immediately contact any authorized Lexus dealer or repairer, or another duly qualified and equipped professional.
 - Replace the seat assembly, including the belts, if your vehicle has been involved in a serious accident, even if there is no obvious damage.
 - Do not attempt to install, remove, modify, disassemble or dispose of the seat belts. Have any necessary repairs carried out by any authorized Lexus dealer or repairer, or another duly qualified and equipped professional. Inappropriate handling may lead to incorrect operation.

SRS airbags

The SRS airbags inflate when the vehicle is subjected to certain types of severe impacts that may cause significant injury to the occupants. They work together with the seat belts to help reduce the risk of death or serious injury.

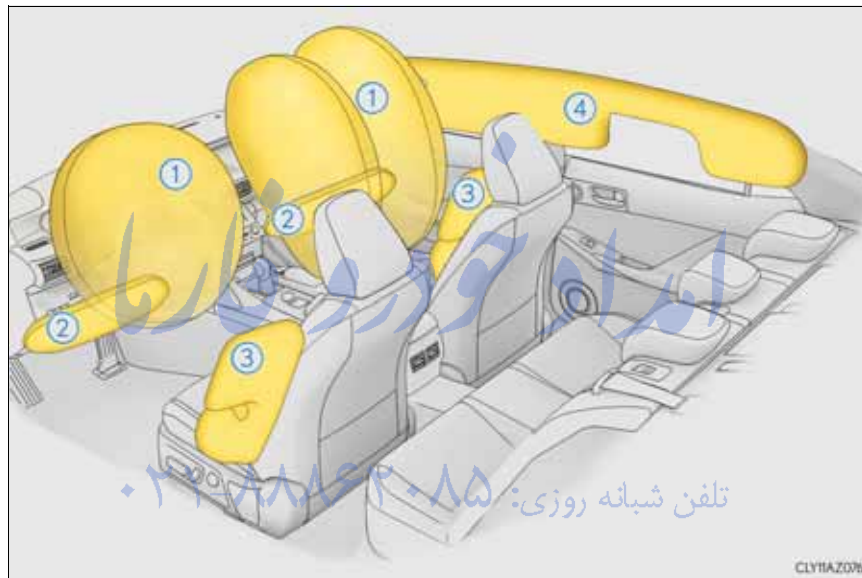

◆ SRS front airbags

- ① SRS driver airbag/front passenger airbag
Can help protect the head and chest of the driver and front passenger from impact with interior components

- ② SRS knee airbags
Can help provide driver and front passenger protection

◆ SRS side and curtain shield airbags

- ③ SRS side airbags
Can help protect the torso of the front seat occupants
- ④ SRS curtain shield airbags
Can help protect primarily the head of occupants in the outer seats

SRS airbag system components

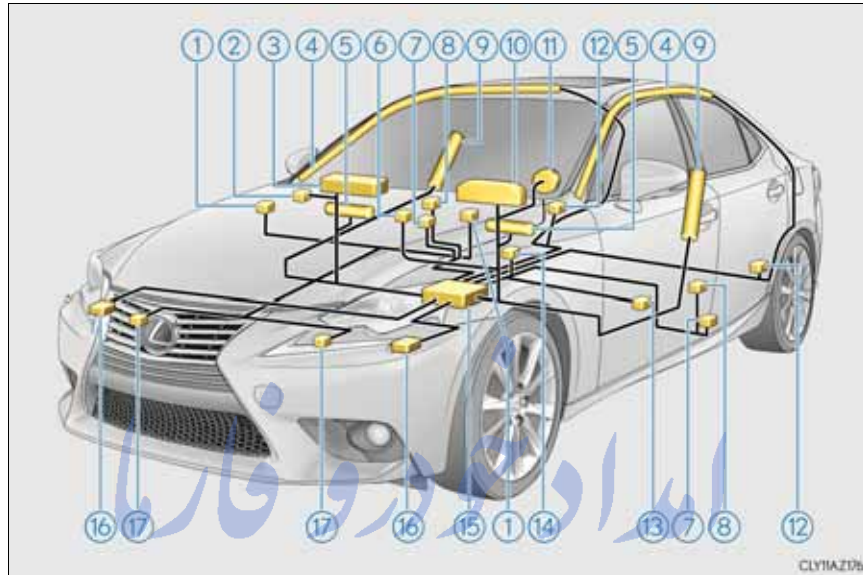

- | | |
|--|------------------------------------|
| ① Pop up hood lifters | ⑨ Front side airbags |
| ② Airbag manual on-off switch | ⑩ SRS warning light |
| ③ Front passenger airbag | ⑪ Driver airbag |
| ④ Curtain shield airbags | ⑫ Side impact sensors (rear) |
| ⑤ Knee airbags | ⑬ Driver's seat position sensor |
| ⑥ "PASSENGER AIR BAG" indicator lights | ⑭ Driver's seat belt buckle switch |
| ⑦ Seat belt pretensioners and force limiters | ⑮ Airbag sensor assembly |
| ⑧ Side impact sensors (front) | ⑯ Front impact sensors |
| | ⑰ Pop up hood sensors |

The main SRS airbag system and Pop Up Hood components are shown above. The SRS airbag system and Pop Up Hood are controlled by the airbag sensor assembly. As the airbags deploy, a chemical reaction in the inflators quickly fills the airbags with non-toxic gas to help restrain the motion of the occupants. When the Pop Up Hood is activated, a non-toxic gas is released due to a chemical reaction in the lifters, which causes the pistons to eject quickly and raise the rear portion of the hood. (Pop Up Hood: →P. 54)

 CAUTION

■ SRS airbag precautions

Observe the following precautions regarding the SRS airbags. Failure to do so may cause death or serious injury.

- The driver and all passengers in the vehicle must wear their seat belts properly.

The SRS airbags are supplemental devices to be used with the seat belts.

- The SRS driver airbag deploys with considerable force, and can cause death or serious injury especially if the driver is very close to the airbag.

Since the risk zone for the driver's airbag is the first 50 - 75 mm (2 - 3 in.) of inflation, placing yourself 250 mm (10 in.) from your driver airbag provides you with a clear margin of safety. This distance is measured from the center of the steering wheel to your breastbone. If you sit less than 250 mm (10 in.) away now, you can change your driving position in several ways:

- Move your seat to the rear as far as you can while still reaching the pedals comfortably.
- Slightly recline the back of the seat.
Although vehicle designs vary, many drivers can achieve the 250 mm (10 in.) distance, even with the driver seat all the way forward, simply by reclining the back of the seat somewhat. If reclining the back of your seat makes it hard to see the road, raise yourself by using a firm, non-slippery cushion, or raise the seat if your vehicle has that feature.
- If your steering wheel is adjustable, tilt it downward. This points the airbag toward your chest instead of your head and neck.

The seat should be adjusted as recommended above, while still maintaining control of the foot pedals, steering wheel, and your view of the instrument panel controls.

FarmaSOS.com

 CAUTION

■ SRS airbag precautions

- The SRS front passenger airbag also deploys with considerable force, and can cause death or serious injury especially if the front passenger is very close to the airbag. The front passenger seat should be as far from the airbag as possible with the seatback adjusted, so the front passenger sits upright.
- Improperly seated and/or restrained infants and children can be killed or seriously injured by a deploying airbag. An infant or child who is too small to use a seat belt should be properly secured using a child restraint system. Lexus strongly recommends that all infants and children be placed in the rear seats of the vehicle and properly restrained. The rear seats are safer for infants and children than the front passenger seat. (→P. 59)
- Do not sit on the edge of the seat or lean against the dashboard.

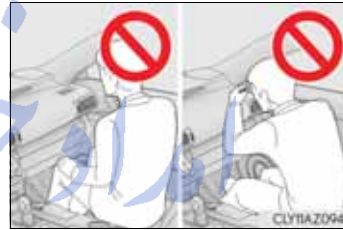

- Do not allow a child to stand in front of the SRS front passenger airbag unit or sit on the knees of a front passenger.
- Do not allow the front seat occupants to hold items on their knees.



- Do not lean against the door, the roof side rail or the front, side and rear pillars.



 CAUTION

■ SRS airbag precautions

- Do not allow anyone to kneel on the passenger seats toward the door or put their head or hands outside the vehicle.



- Do not attach anything to or lean anything against areas such as the dashboard, steering wheel pad and lower portion of the instrument panel. These items can become projectiles when the SRS driver, front passenger and knee airbags deploy.

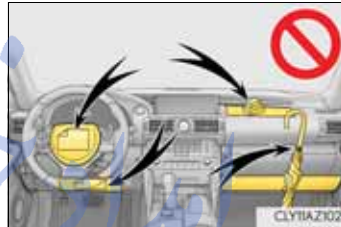

- Do not attach anything to areas such as a door, windshield glass, side door glass, front or rear pillar, roof side rail and assist grip. (Except for the speed limit sticker →P. 509)

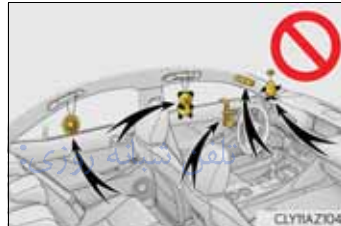

- Do not hang coat hangers or hard objects on the coat hooks. All of these items could become projectiles and may cause death or serious injury, should the SRS curtain shield airbags deploy.
- If a vinyl cover is put on the area where the SRS knee airbag will deploy, be sure to remove it.
- Do not use seat accessories which cover the parts where the SRS side airbags inflate as they may interfere with inflation of the airbags. Such accessories may prevent the side airbags from activating correctly, disable the system or cause the side airbags to inflate accidentally, resulting in death or serious injury.

 CAUTION**■ SRS airbag precautions**

- Do not strike or apply significant levels of force to the area of the SRS airbag components.
Doing so can cause the SRS airbags to malfunction.
- Do not touch any of the component parts immediately after the SRS airbags have deployed (inflated) as they may be hot.
- If breathing becomes difficult after the SRS airbags have deployed, open a door or window to allow fresh air in, or leave the vehicle if it is safe to do so. Wash off any residue as soon as possible to prevent skin irritation.
- If the areas where the SRS airbags are stored, such as the steering wheel pad and front and rear pillar garnishes are damaged or cracked, have them replaced by any authorized Lexus dealer or repairer, or another duly qualified and equipped professional.

■ Modification and disposal of SRS airbag system components

Do not dispose of your vehicle or perform any of the following modifications without consulting any authorized Lexus dealer or repairer, or another duly qualified and equipped professional. The SRS airbags may malfunction or deploy (inflate) accidentally, causing death or serious injury.

- Installation, removal, disassembly and repair of the SRS airbags
- Repairs, modifications, removal or replacement of the steering wheel, instrument panel, dashboard, seats or seat upholstery, front, side and rear pillars or roof side rails
- Repairs or modifications of the front fender, front bumper, or side of the occupant compartment
- Installation of snow plows, winches, etc. to the front grille (bull bars or kangaroo bar etc.)
- Modifications to the vehicle's suspension system
- Installation of electronic devices such as mobile two-way radios, RF-transmitters and CD players
- Modifications to your vehicle for a person with a physical disability

- If the SRS airbags deploy (inflate)
 - Bruising and slight abrasions may result from contact with a deploying (inflating) SRS airbag.
 - A loud noise and white powder will be emitted.
 - Parts of the airbag module (steering wheel hub, airbag cover and inflator) as well as the front seats, parts of the front and rear pillars, and roof side rails, may be hot for several minutes. The airbag itself may also be hot.
 - The windshield may crack.
- SRS airbag deployment conditions (SRS front airbags)
 - The SRS front airbags will deploy in the event of an impact that exceeds the set threshold level (the level of force corresponding to an approximately 20 - 30 km/h [12 - 18 mph] frontal collision with a fixed wall that does not move or deform).

However, this threshold velocity will be considerably higher in the following situations:

 - If the vehicle strikes an object, such as a parked vehicle or sign pole, which can move or deform on impact
 - If the vehicle is involved in an underride collision, such as a collision in which the front of the vehicle “underrides”, or goes under, the bed of a truck
 - Depending on the type of collision, it is possible that only the seat belt pretensioners will activate.
- SRS airbag deployment conditions (SRS side and curtain shield airbags)
 - The SRS side and curtain shield airbags will deploy in the event of an impact that exceeds the set threshold level (the level of force corresponding to the impact force produced by an approximately 1500 kg [3300 lb.] vehicle colliding with the vehicle cabin from a direction perpendicular to the vehicle orientation at an approximate speed of 20 - 30 km/h [12 - 18 mph]).
 - The SRS curtain shield airbags may also deploy in the event of a severe frontal collision.

FarmaSOS.com

- Conditions under which the SRS airbags may deploy (inflate), other than a collision

The SRS front airbags and SRS curtain shield airbags may also deploy if a serious impact occurs to the underside of your vehicle. Some examples are shown in the illustration.

- Hitting a curb, edge of pavement or hard surface
- Falling into or jumping over a deep hole
- Landing hard or falling

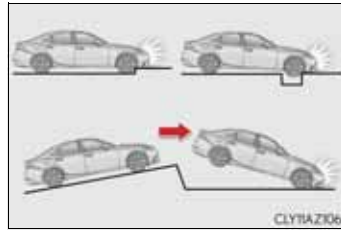

- Types of collisions that may not deploy the SRS airbags (SRS front airbags)

The SRS front airbags do not generally inflate if the vehicle is involved in a side or rear collision, if it rolls over, or if it is involved in a low-speed frontal collision. But, whenever a collision of any type causes sufficient forward deceleration of the vehicle, deployment of the SRS front airbags may occur.

- Collision from the side
- Collision from the rear
- Vehicle rollover



۰۲۱-۸۸۸۶۲۰۸۵ تلفن کجابه روزی

FarmaSOS.com

- Types of collisions that may not deploy the SRS airbags (SRS side and curtain shield airbags)

The SRS side and curtain shield airbags may not activate if the vehicle is subjected to a collision from the side at certain angles, or a collision to the side of the vehicle body other than the passenger compartment.

- Collision from the side to the vehicle body other than the passenger compartment
- Collision from the side at an angle

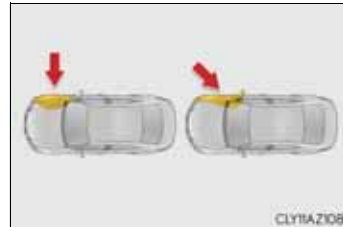

The SRS side airbags do not generally inflate if the vehicle is involved in a frontal or rear collision, if it rolls over, or if it is involved in a low-speed side collision.

- Collision from the front
- Collision from the rear
- Vehicle rollover

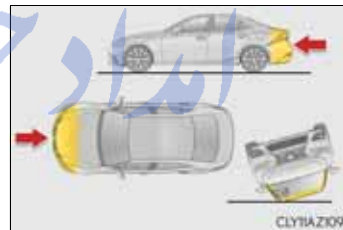

The SRS curtain shield airbags do not generally inflate if the vehicle is involved in a rear collision, if it rolls over, or if it is involved in a low-speed side or low-speed frontal collision.

- Collision from the rear
- Vehicle rollover



- When to contact any authorized Lexus dealer or repairer, or another duly qualified and equipped professional

In the following cases, the vehicle will require inspection and/or repair. Contact any authorized Lexus dealer or repairer, or another duly qualified and equipped professional as soon as possible.

- Any of the SRS airbags have been inflated.
- The front of the vehicle is damaged or deformed, or was involved in an accident that was not severe enough to cause the SRS airbags to inflate.

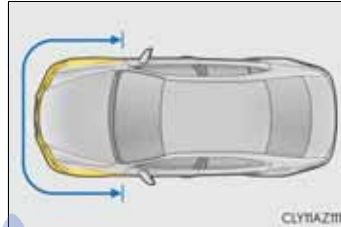

- A portion of a door its surrounding area is damaged or deformed, or the vehicle was involved in an accident that was not severe enough to cause the SRS side and curtain shield airbags to inflate.

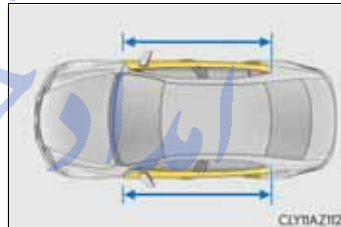

- The pad section of the steering wheel, dashboard near the front passenger airbag or lower portion of the instrument panel is scratched, cracked, or otherwise damaged.

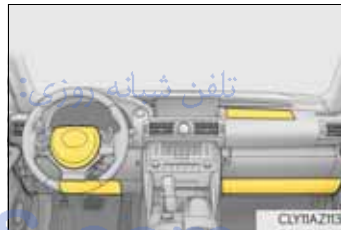

- The surface of the seats with the side air-bag is scratched, cracked, or otherwise damaged.

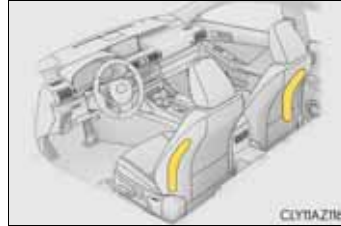

- The portion of the front pillars, rear pillars or roof side rail garnishes (padding) containing the curtain shield airbags inside is scratched, cracked, or otherwise damaged.



امداد خودرو فارما

تلفن شبانه روزی: ۰۲۱-۸۸۸۶۲۰۸۵

FarmaSOS.com

Airbag manual on-off system

This system deactivates the front passenger airbag and front passenger knee airbag.

Only deactivate the airbags when using a child restraint system on the front passenger seat.

① “PASSENGER AIR BAG” indicator

This indicator light turns on when the airbag system is on (only when the engine switch is in IGNITION ON mode).

② Airbag manual on-off switch



Deactivating the front seat passenger airbag and front passenger knee airbag

Insert the mechanical key into the cylinder and rotate to the “OFF” position.

The “OFF” indicator light turns on (only when the engine switch is in IGNITION ON mode).



■ “PASSENGER AIR BAG” indicator information

If any of the following problems occur, it is possible that there is a malfunction in the system. Have the vehicle inspected by any authorized Lexus dealer or repairer, or another duly qualified and equipped professional.

- Neither “ON” nor “OFF” comes on.
- The indicator light does not change when the airbag manual on-off switch is switched to “ON” or “OFF”.

⚠ CAUTION**■ When installing a child restraint system**

For safety reasons, always install a child restraint system in a rear seat. In the event that the rear seat cannot be used, the front seat can be used as long as the airbag manual on-off system is set to off.

If the airbag manual on-off system is left on, the strong impact of the airbag deployment (inflation) may cause serious injury or even death.

■ When a child restraint system is not installed on the front passenger seat

Ensure that the airbag manual on-off system is set to on.

If it is left off, the airbag may not deploy in the event of an accident, which may result in serious injury or even death.

تلفن شبانه روزی: ۰۲۱-۸۸۶۲۰۸۵

FarmaSOS.com

Pop Up Hood

In the event of a frontal collision with a body, such as a pedestrian, the Pop Up Hood system raises the rear portion of the hood to reduce the possibility of a serious impact to the pedestrian's head area by adding clearance to the engine compartment.

Pop Up Hood mechanism

When the sensors located at the back of the front bumper detect an impact with a body, such as a pedestrian, which meets or exceeds the threshold level while the vehicle is being driven within the operational speed range, the system becomes operational and raises the rear portion of the hood.

- ① Sensors
- ② Hood
- ③ Lifters



FarmaSOS.com

Pop Up Hood operational conditions

The Pop Up Hood will operate when the vehicle detects an impact such as the following:

- The front bumper detects a frontal impact equivalent to or greater than that of a pedestrian while the vehicle being driven within the operational speed range of approximately 25 to 55 km/h (16 to 34 mph). (The system is operated by an impact of threshold level or greater, even in the case of a minor collision that may not leave a trace on the front bumper. Also, depending on the impact conditions or vehicle speed, the system may be operated by a collision with a light or small object or a small animal.)
- In other situations the system may operate when an impact is applied to the lower part of the vehicle or front bumper, such as the following:
 - Colliding with a curb
 - Falling into a deep hole
 - Landing hard
 - Hitting the slope of a parking lot, an undulating road, a protruding object or falling object

CAUTION

- When the Pop Up Hood is operated
 - Do not pull the hood lock release lever. Doing so after the Pop Up Hood has operated will further raise the hood and may cause an injury. Do not drive with the hood raised, as doing so may block the driver's vision, possibly causing an accident. Do not forcibly push down the hood. As the popped up hood cannot be lowered by hand, doing so may deform the hood or cause an injury. If the Pop Up Hood has operated, have the vehicle inspected by any authorized Lexus dealer or repairer, or another duly qualified and equipped professional. If the Pop Up Hood has operated, stop the vehicle in a safe place and contact authorized Lexus dealer or repairer, or another duly qualified and equipped professional.
 - Do not touch the lifters immediately after the Pop Up Hood has operated, as the lifters may be hot and burn you.

-
- Pop Up Hood precautions
 - Before scrapping your vehicle, make sure to contact any authorized Lexus dealer or repairer, or another duly qualified and equipped professional.
 - The Pop Up Hood system cannot be reused once it has operated. Have it replaced by any authorized Lexus dealer or repairer, or another duly qualified and equipped professional.
 - Conditions under which the Pop Up Hood may not operate properly

The Pop Up Hood may not operate properly under the following conditions:

 - If a pedestrian collides with the right or left corner of the front bumper or the side of the vehicle. As such impacts may be difficult to detect, the system may not operate.
 - If the vehicle speed is not detected correctly, such as if the vehicle is sliding sideways, the system may not operate properly.
 - Conditions under which the Pop Up Hood may not operate

The Pop Up Hood may not operate in the following situations:

 - Colliding with a lying pedestrian
 - A frontal impact applied to the front bumper while driving at speeds outside of the operational speed range
 - A side impact or rear impact
 - A vehicle rollover (In some accident situations, the Pop Up Hood may operate.)

تلفن شبانه روزی: ۰۲۱-۸۸۸۶۲۰۸۵

FarmaSOS.com

 NOTICE

■ Pop Up Hood precautions

- Make sure to close the hood before driving, as the system may not operate properly if the hood is not fully closed.
- Make sure that all 4 tires are of the specified size and inflated to the specified tire pressure (→P. 544). If tires of a different size are used, the system may not operate properly.
- If something has hit the area around the front bumper, the sensors may be damaged even if the Pop Up Hood has not operated. Have the vehicle inspected by any authorized Lexus dealer or repairer, or another duly qualified and equipped professional.
- Do not remove or repair the parts or wiring of the Pop Up Hood, as doing so may cause accidental operation or prevent the system from operating properly. If repair or replacement is necessary, contact any authorized Lexus dealer or repairer, or another duly qualified and equipped professional.
- Do not remove such components as the front bumper, hood or suspension, or replace them with non-genuine parts, as doing so may prevent the system from operating properly.
- Do not install anything to the front bumper or hood, as doing so may prevent the sensors from detecting an impact correctly and prevent the system from operating properly.
- Do not close the hood with force or apply load to the lifters, as doing so may damage the lifters and prevent the system from operating properly.
- Do not modify the suspension, as changes made to the vehicle height may prevent the system from operating properly. تلفن شبانه روزی:

FarmaSOS.com

Safety information for children

Observe the following precautions when children are in the vehicle.
Use a child restraint system appropriate for the child, until the child becomes large enough to properly wear the vehicle's seat belt.

- It is recommended that children sit in the rear seats to avoid accidental contact with the shift lever, wiper switch etc.
- Use the rear door child-protector lock or the window lock switch to avoid children opening the door while driving or operating the power window accidentally.
- Do not let small children operate equipment which may catch or pinch body parts, such as the power window, hood, trunk, seats etc.

CAUTION

Never leave children unattended in the vehicle, and never allow children to have or use the key.

Children may be able to start the vehicle or shift the vehicle into neutral. There is also a danger that children may injure themselves by playing with the windows, the moon roof or other features of the vehicle. In addition, heat build-up or extremely cold temperatures inside the vehicle can be fatal to children.

FarmaSOS.com

Child restraint systems

Lexus strongly urges the use of child restraint systems.

Points to remember

Studies have shown that installing a child restraint on a rear seat is much safer than installing one on the front passenger seat.

- Choose a child restraint system that suits your vehicle and is appropriate to the age and size of the child.
- For installation details, follow the instructions provided with the child restraint system.
General installation instructions are provided in this manual. (→P. 68)
- If child restraint system regulations exist in the country where you reside, please contact any authorized Lexus dealer or repairer, or another duly qualified and equipped professional for the child restraint system installation.
- Lexus recommends that you use a child restraint system which conforms to the regulation ECE No.44.

تلفن شبانه روزی: ۰۲۱-۸۸۶۲۰۸۵

FarmaSOS.com

Types of child restraints

Child restraint systems are classified into the following 5 groups according to the regulation ECE No.44:

Group 0: Up to 10 kg (22 lb.) (0 - 9 months)

Group 0⁺: Up to 13 kg (28 lb.) (0 - 2 years)

Group I: 9 to 18 kg (20 to 39 lb.) (9 months - 4 years)

Group II: 15 to 25 kg (34 to 55 lb.) (4 years - 7 years)

Group III: 22 to 36 kg (49 to 79 lb.) (6 years - 12 years)

In this owner's manual, the following 3 types of popular child restraint systems that can be secured with the seat belts are explained:

► Baby seat

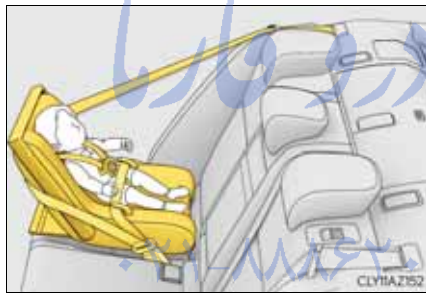

Equal to Group 0 and 0⁺ of ECE No.44

► Child seat



Equal to Group 0⁺ and I of ECE No.44

► Junior seat



Equal to Group II and III of ECE No.44

Child restraint system suitability for various seating positions

Information provided in the table shows your child restraint system suitability for various seating positions.

Seating position Mass groups	Front passenger seat		Rear seat	
	Airbag manual on-off switch		Outboard	Center
	ON	OFF		
0 Up to 10 kg (22 lb.) (0 - 9 months)	X Never put	U* ¹	U* ³ L1* ³	X
0 ⁺ Up to 13 kg (28 lb.) (0 - 2 years)	X Never put	U* ¹	U* ³ L1* ³	X
I 9 to 18 kg (20 to 39 lb.) (9 months - 4 years)	Rear-facing — X Never put	U* ¹	U* ³	X
	Forward-facing — UF* ¹			
II, III 15 to 36 kg (34 to 79 lb.) (4 - 12 years)	UF* ^{1, 2}	U* ^{1, 2}	U* ^{2, 3} L2* ^{2, 3}	X

Key of letters inserted in the above table:

- U: Suitable for “universal” category child restraint system approved for the use in this mass group.
- UF: Suitable for forward-facing “universal” category child restraint system approved for the use in this mass group.
- L1: Suitable for “LEXUS G 0⁺, BABY SAFE PLUS with SEAT BELT FIXATION, BASE PLATFORM” (0 to 13 kg [0 to 28 lb.]) approved for the use in this mass group.
- L2: Suitable for “LEXUS KIDFIX” (15 to 36 kg [34 to 79 lb.]) approved for the use in this mass group.
- X: Not suitable seat position for children in this mass group.

NOTE:

*1: Adjust the front seatback to the most upright position. Move the front seat cushion to the fully rearward.

Adjust the seat cushion to the highest position. When the child restraint system touched the ceiling, lower the seat position.

Follow these procedures

- For installing a baby seat with support base

If the baby seat interferes with the seatback when latching the baby seat into the support base, adjust the seatback rearward until there is no interference.

- For installing a forward-facing child seat

If there is gap between the child seat and the seatback, tilt the seatback rearward until good contact is achieved.

If the seatbelt shoulder anchor is ahead of the child seat belt guide, move the seat cushion forward.

- For installing a junior seat

If the child in your child restraint system is in a very upright position, adjust the seatback to the most comfortable position.

If the seat belt shoulder anchor is ahead of the child seat belt guide, move the seat cushion forward.

*2: Remove the head restraint if it interferes with your child restraint system.

*3: When using the left side seat for the child restraint system, do not sit in the center seat.

The child restraint system mentioned in the table may not be available outside of the EU area.

Other child restraint systems which are different from the systems mentioned in the table can be used, but the suitability of the systems must be carefully checked with the child restraint system manufacturer and retailer.

Child restraint system suitability for various seating positions (with ISOFIX rigid anchors)

Information provided in the table shows your child restraint system suitability for various seating positions.

Mass groups	Size class	Fixture	Vehicle ISOFIX positions
			Rear outboard
Carycot	F	ISO/L1	X
	G	ISO/L2	X
		(1)	X
Group 0 Up to 10 kg (22 lb.)	E	ISO/R1	IL1*, IL2*
		(1)	X
Group 0+ Up to 13 kg (28 lb.)	E	ISO/R1	IL1*, IL2*
	D	ISO/R2	IL1*, IL2*
	C	ISO/R3	IL1*, IL2*
		(1)	X
Group I 9 to 18 kg (20 to 39 lb.)	D	ISO/R2	X
	C	ISO/R3	IL3*
	B	ISO/F2	IUF*, IL2*
	B1	ISO/F2X	IUF*, IL2*
	A	ISO/F3	IUF*, IL2*
		(1)	X
Group II 15 to 25 kg (34 to 55 lb.)		(1)	X
Group III 22 to 36 kg (49 to 79 lb.)		(1)	X

- (1) For the child restraint system which do not carry the ISO/XX size class identification (A to G), for the applicable mass group, the car manufacturer shall indicate the vehicle specific ISOFIX child restraint system(s) recommended for each position.

Key of letters inserted in the above table:

IUF: Suitable for ISOFIX forward-facing child restraint systems of universal category approved for use in this mass group.

IL1: Suitable for “LEXUS MINI” (0 to 13 kg [0 to 28 lb.]) approved for the use in this mass group.

IL2: Suitable for “LEXUS MIDI” (0 to 18 kg [0 to 39 lb.]) approved for the use in this mass group.

When using a “LEXUS MINI” or “LEXUS MIDI”, adjust the support leg and the ISOFIX connectors as follows:

- ① Lock the support leg where 4th hole can be seen. (“LEXUS MIDI” rear-facing, “LEXUS MINI”)
- ② Lock the support leg where 6th hole can be seen. (“LEXUS MIDI” forward-facing only)
- ③ Lock the ISOFIX connectors where numbers 4 and 5 can be seen.



IL3: Refer to the “HTS iZi Kid X3” user manual for fitment method.

X: ISOFIX position not suitable for ISOFIX child restraint systems in this mass group and/or this size class.

*: Remove the head restraint if it interferes with your child restraint system. Do not sit on rear center seat when child restraint system is installed to rear left seat.

The child restraint system mentioned in the table may not be available outside of the EU area.

Other child restraint systems which are different from the systems mentioned in the table can be used, but the suitability of the systems must be carefully checked with the child restraint system manufacturer and retailer.

■ When installing a child restraint system on the front passenger seat

When you have to use a child restraint system on the front passenger seat, adjust the following:

- The seatback to the most upright position
- The seat cushion to the highest position
- The seat cushion to the fully rearward position



■ Selecting an appropriate child restraint system

- Use a child restraint system appropriate for the child until the child becomes large enough to properly wear the vehicle's seat belt.
- If the child is too large for a child restraint system, sit the child on a rear seat and use the vehicle's seat belt. (→P. 36)

⚠ CAUTION

■ Using a child restraint system

The use of a child restraint system not suitable for the vehicle may not properly secure the infant or child. It may result in death or serious injury (in the event of sudden braking or an accident).

تلفن شبانه روزی: ۰۲۱-۸۸۶۲۰۸۵

FarmaSOS.com

 CAUTION

■ Child restraint precautions

- For effective protection in automobile accidents and sudden stops, a child must be properly restrained, using a seat belt or child restraint system depending on the age and size of the child. Holding a child in your arms is not a substitute for a child restraint system. In an accident, the child can be crushed against the windshield, or between you and the vehicle's interior. This may cause death or serious injury to the child in the event of a sudden stop, sudden swerve or accident.
- Lexus strongly urges the use of a proper child restraint system that conforms to the size of the child, installed on the rear seat. According to accident statistics, the child is safer when properly restrained in the rear seat than in the front seat.
- Never use a rear-facing child restraint system on the front passenger seat when the airbag manual on-off switch is on. (→P. 52)
In the event of an accident, the force of the rapid inflation of the front passenger airbag can cause death or serious injury to the child.
- A forward-facing child restraint system may be installed on the front passenger seat only when it is unavoidable. A child restraint system that requires a top tether strap should not be used in the front passenger seat since there is no top tether strap anchor for the front passenger seat. Adjust the seatback as upright as possible and always move the seat as far back as possible because the front passenger airbag could inflate with considerable speed and force. Otherwise, the child may be killed or seriously injured.
- Do not allow the child to lean his/her head or any part of his/her body against the door or the area of the seat, front, center and rear pillars or roof side rails from which the SRS side airbags or SRS curtain shield airbags deploy even if the child is seated in the child restraint system. It is dangerous if the SRS side airbags and curtain shield airbags inflate, and the impact could cause death or serious injury to the child.
- Make sure you have complied with all installation instructions provided by the child restraint manufacturer and that the system is properly secured. If it is not secured properly, it may cause death or serious injury to the child in the event of a sudden stop, sudden swerve or accident.

 CAUTION**■ When children are in the vehicle**

Do not allow children to play with the seat belt. If the seat belt becomes twisted around a child's neck, it may lead to choking or other serious injuries that could result in death.

If this occurs and the buckle cannot be unfastened, scissors should be used to cut the belt.

■ When the child restraint system is not in use

- Keep the child restraint system properly secured on the seat even if it is not in use. Do not store the child restraint system unsecured in the passenger compartment.
- If it is necessary to detach the child restraint system, remove it from the vehicle or store it securely in the trunk. This will prevent it from injuring passengers in the event of a sudden stop, sudden swerve or accident.

امداد خودرو فارما

تلفن شبانه روزی: ۰۲۱-۸۸۸۶۲۰۸۵

FarmaSOS.com

Installing child restraints

Follow the child restraint system manufacturer's instructions. Firmly secure child restraints to the seats using a seat belt or ISOFIX rigid anchors. Attach the top strap when installing a child restraint.

Seat belts (An ELR belt requires a locking clip)



ISOFIX rigid anchors

Lower anchors are provided for the outboard rear seats, behind the anchor covers.



Anchor brackets (for top strap)

An anchor bracket is provided for the outboard rear seats.



Installing child restraints using a seat belt

■ Rear-facing — Baby seat/child seat

- 1 Place the child restraint system on the rear seat facing the rear of the vehicle.



- 2 Run the seat belt through the child restraint system and insert the plate into the buckle. Make sure that the belt is not twisted.

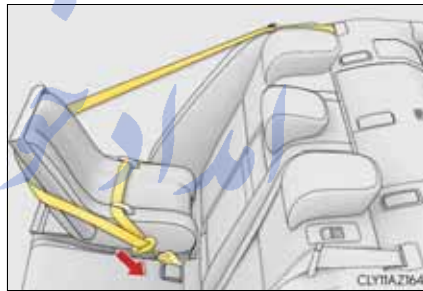

If your child restraint system is not equipped with a lock-off (a seat belt locking feature), secure the child restraint system using a locking clip.



After installing the child restraint system, rock it back and forth to ensure that it is installed securely.

■ Forward-facing — Child seat

- 1 Remove the head restraint if it interferes with your child restraint system.

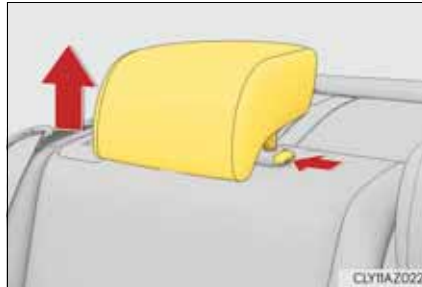

- 2 Place the child restraint system on the seat facing the front of the vehicle.



- 3 Run the seat belt through the child restraint system and insert the plate into the buckle. Make sure that the belt is not twisted.



If your child restraint system is not equipped with a lock-off (a seat belt locking feature), secure the child restraint system using a locking clip.

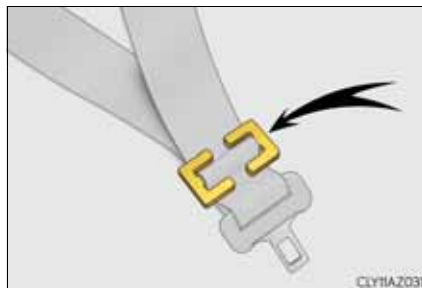

After installing the child restraint system, rock it back and forth to ensure that it is installed securely.

■ Junior seat

- 1 Place the child restraint system on the seat facing the front of the vehicle.



- 2 Sit the child in the child restraint system. Fit the seat belt to the child restraint system according to the manufacturer's instructions and insert the plate into the buckle. Make sure that the belt is not twisted.

Check that the shoulder belt is correctly positioned over the child's shoulder and that the lap belt is as low as possible. (→P. 36)



Removing a child restraint installed with a seat belt

Push the buckle release button and fully retract the seat belt.



Installation with ISOFIX rigid anchor

- 1** Remove the head restraint if it interferes with your child restraint system.

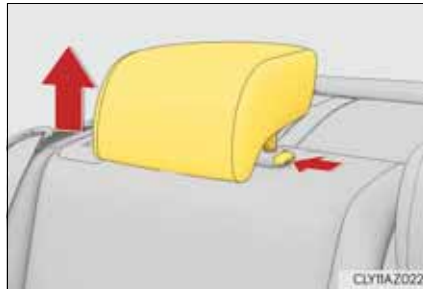

- 2** Latch the buckles onto the exclusive fixing bars.

If the child restraint has a top strap, the top strap should be latched onto the anchor bracket.



Child restraint systems with a top strap

- 1 Remove the head restraint if it interferes with your child restraint system.

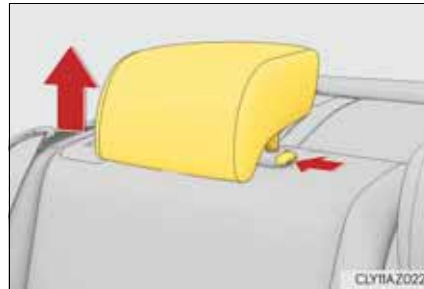

- 2 Secure the child restraint system using the seat belt or ISOFIX rigid anchors.



- 3 Open the anchor bracket cover, latch the hook onto the anchor bracket and tighten the top strap. Make sure the top strap is securely latched.

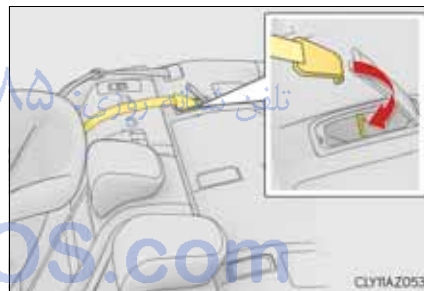

■ When installing a child restraint system

You need a locking clip to install the child restraint system. Follow the instructions provided by the manufacturer of the system. If your child restraint system does not provide a locking clip, you can purchase the following item from any authorized Lexus dealer or repairer, or another duly qualified and equipped professional:

Locking clip for child restraint system
(Part No. 73119-22010)

⚠ CAUTION**■ When installing a child restraint system**

Follow the directions given in the child restraint system installation manual and fix the child restraint system securely in place. If the child restraint system is not correctly fixed in place, the child or other passengers may be seriously injured or even killed in the event of a sudden braking, sudden swerving or an accident.

- If the driver's seat interferes with the child restraint system and prevents it from being attached correctly, attach the child restraint system to the right-hand rear seat (left-hand drive vehicles) or the left-hand rear seat (right-hand drive vehicles).
- Adjust the front passenger seat so that it does not interfere with the child restraint system.
- When installing a forward-facing child restraint system on the front passenger seat, move the seat as far back as possible. Failure to do so may result in death or serious injury if the airbags deploy (inflate).



FarmaSOS.com

⚠ CAUTION

- When installing a child restraint system
 - Never use a rear-facing child restraint system on the front passenger seat when the airbag manual on-off switch is on. (→P. 52)

The force of the rapid inflation of the front passenger airbag can cause death or serious injury to children in the event of an accident.

There is a label(s) on the passenger side sun visor, indicating it is forbidden to attach a rear-facing child restraint system to the front passenger seat.

Details of the label(s) are shown in the illustration below.

CLY1BA60

 CAUTION

- When installing a child restraint system
 - If child restraint system regulations exist in the country where you reside, please contact any authorized Lexus dealer or repairer, or another duly qualified and equipped professional for the child restraint system installation.
 - When a junior seat is installed, always ensure that the shoulder belt is positioned across the center of the child's shoulder. The belt should be kept away from the child's neck, but not so that it could fall off the child's shoulder. Failing to do so may result in death or serious injury in the event of sudden braking, sudden swerving or an accident.
 - Ensure that the belt and plate are securely locked and the seat belt is not twisted.
 - Shake the child restraint system left and right, and forward and backward to ensure that it has been securely installed.
 - After securing a child restraint system, never adjust the seat.
 - Follow all installation instructions provided by the child restraint system manufacturer.
- To correctly attach a child restraint system to the anchors

When using the lower anchors, be sure that there are no foreign objects around the anchors and that the seat belt is not caught behind the child restraint system. Make sure the child restraint system is securely attached, or it may cause death or serious injury to the child or other passengers in the event of a sudden braking, sudden swerve or an accident.

تلفن شبانه روزی: ۰۲۱-۸۸۸۶۲۰۸۵

FarmaSOS.com

Exhaust gas precautions

Harmful substance to the human body is included in exhaust gases if inhaled.

CAUTION

Exhaust gases include harmful carbon monoxide (CO), which is colorless and odorless. Observe the following precautions.

Failure to do so may cause exhaust gases enter the vehicle and may lead to an accident caused by light-headedness, or may lead to death or a serious health hazard.

■ Important points while driving

- Keep the trunk lid closed.
- If you smell exhaust gases in the vehicle even when the trunk lid is closed, open the windows and have the vehicle inspected at any authorized Lexus dealer or repairer, or another duly qualified and equipped professional as soon as possible.

■ When parking

- If the vehicle is in a poorly ventilated area or a closed area, such as a garage, stop the engine.
- Do not leave the vehicle with the engine on for a long time.
If such a situation cannot be avoided, park the vehicle in an open space and ensure that exhaust fumes do not enter the vehicle interior.
- Do not leave the engine running in an area with snow build-up, or where it is snowing. If snowbanks build up around the vehicle while the engine is running, exhaust gases may collect and enter the vehicle.

■ Exhaust pipe

The exhaust system needs to be checked periodically. If there is a hole or crack caused by corrosion, damage to a joint or abnormal exhaust noise, be sure to have the vehicle inspected and repaired by any authorized Lexus dealer or repairer, or another duly qualified and equipped professional.

Engine immobilizer system

The vehicle's keys have built-in transponder chips that prevent the engine from starting if a key has not been previously registered in the vehicle's on-board computer.

Never leave the keys inside the vehicle when you leave the vehicle.

The indicator light flashes after the engine switch has been turned off to indicate that the system is operating.

The indicator light stops flashing after the engine switch has been turned to ACCESSORY or IGNITION ON mode to indicate that the system has been canceled.

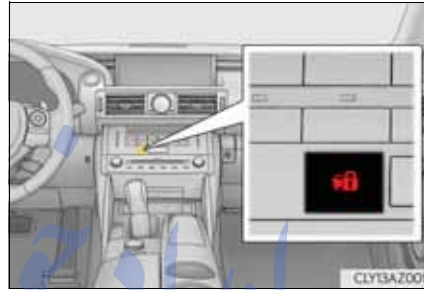

■ System maintenance

The vehicle has a maintenance-free type engine immobilizer system.

■ Conditions that may cause the system to malfunction

- If the grip portion of the key is in contact with a metallic object
- If the key is in close proximity to or touching a key registered to the security system (key with a built-in transponder chip) of another vehicle

FarmaSOS.com

■ Certifications for the engine immobilizer system

TOYOTA
TOYOTA MOTOR CORPORATION
1, TOYOTA-CHO, TOYOTA, AICHI, 471-8572 (Head Office)
or 471-8572 (Research & Development Group) JAPAN
TEL: +81-963-28-2101

R&TTE Declaration of Conformity

We,

Manufacturer's Name: TOYOTA MOTOR CORPORATION
 Manufacturer's Address: 1, Toyota -cho, Toyota, Aichi, 471-8572, Japan

hereby declare under our sole responsibility that the product:

Product Name: Immobilizer
 Product Model: TMIMB-3

to which this declaration relates is in conformity with the essential requirements and other relevant requirements of the R&TTE Directive (1999/5/EC). The product is compliant with the following standards and/or other normative documents:

-Health & safety requirements: EN 60950-1
 -EMC requirements: EN 301 489-01 & EN 301 489-03
 -Effective uses of radio spectrum: EN 300 330-2

Supplementary information:

<p>* CE mark</p>	
<p>* Member states intended for use</p>	<p>EU and EFTA</p>

Date: March 23, 2010

Signature: *Tetsuya Matsuo*
 Tetsuya Matsuo

Hereby, Toyota Motor Corporation, declares that this TMIMB-3 is in compliance with the essential requirements and other relevant provisions of Directive 1999/5/EC.
Toyota Motor Corporation vakuuttaa täten että TMIMB-3 tyyppinen laite on direktiivin 1999/5/EY oleellisten vaatimusten ja sitä koskevien direktiivin muiden ehtojen mukainen.
Hierbij verklaart Toyota Motor Corporation dat het toestel TMIMB-3 in overeenstemming is met de essentiële eisen en de andere relevante bepalingen van richtlijn 1999/5/EG.
Par la présente Toyota Motor Corporation déclare que l'appareil TMIMB-3 est conforme aux exigences essentielles et aux autres dispositions pertinentes de la directive 1999/5/CE.
Härmed intygar Toyota Motor Corporation att denna TMIMB-3 står i överensstämmelse med de väsentliga egenskapskrav och övriga relevanta bestämmelser som framgår av direktiv 1999/5/EG.
Undertegnede Toyota Motor Corporation erklærer herved, at følgende udstyr TMIMB-3 overholder de væsentlige krav og øvrige relevante krav i direktiv 1999/5/EF.
Hiermit erklährt Toyota Motor Corporation, dass sich das Gerät TMIMB-3 in Übereinstimmung mit den grundlegenden Anforderungen und den übrigen einschlägigen Bestimmungen der Richtlinie 1999/5/EG befindet.
ΜΕ ΤΗΝ ΠΑΡΟΥΣΑ Toyota Motor Corporation ΔΗΛΩΝΕΙ ΟΤΙ ΤΜΙΜΒ-3 ΣΥΜΜΟΡΦΩΝΕΤΑΙ ΠΡΟΣ ΤΙΣ ΟΥΣΙΩΔΕΙΣ ΑΠΑΙΤΗΣΕΙΣ ΚΑΙ ΤΙΣ ΛΟΙΠΕΣ ΣΧΕΤΙΚΕΣ ΔΙΑΤΑΞΕΙΣ ΤΗΣ ΟΔΗΓΙΑΣ 1999/5/ΕΚ.
Con la presente Toyota Motor Corporation dichiara che questo TMIMB-3 è conforme ai requisiti essenziali ed alle altre disposizioni pertinenti stabilite dalla direttiva 1999/5/CE.
Por medio de la presente Toyota Motor Corporation declara que el TMIMB-3 cumple con los requisitos esenciales y cualesquiera otras disposiciones aplicables o exigibles de la Directiva 1999/5/CE.
Toyota Motor Corporation declara que este TMIMB-3 está conforme com os requisitos essenciais e outras disposições da Directiva 1999/5/CE.
Hawnhekk, Toyota Motor Corporation, jiddikjara li dan TMIMB-3 jikkonforma mal-htigijiet essenzjali u ma provvedimenti oħrajn relevanti li hemm fid-Dirrettiva 1999/5/EC.
Käesolevaga kinnitab Toyota Motor Corporation seadme TMIMB-3 vastavust direktiivi 1999/5/EÜ põhinõuetele ja nimetatud direktiivist tulenevatele teistele asjakohastele sätetele.

Alulírott, Toyota Motor Corporation nyilatkozik, hogy a TMIMB-3 megfelel a vonatkozó alapvető követelményeknek és az 1999/5/EC irányelv egyéb előírásainak.
Toyota Motor Corporation tímto vyhlasuje, že TMIMB-3 spĺňa základné požiadavky a všetky príslušné ustanovenia Smernice 1999/5/ES.
Toyota Motor Corporation tímto prohlašuje, že tento TMIMB-3 je ve shodě se základními požadavky a dalšími příslušnými ustanoveními směrnice 1999/5/ES.
Toyota Motor Corporation izjavlja, da je ta TMIMB-3 v skladu z bistvenimi zahtevami in ostalimi relevantnimi določili direktive 1999/5/ES.
Šiuo Toyota Motor Corporation deklaruoja, kad šis TMIMB-3 atitinka esminius reikalavimus ir kitas 1999/5/EB Direktyvos nuostatas.
Ar šo Toyota Motor Corporation deklarē, ka TMIMB-3 atbilst Direktīvas 1999/5/EK būtiskajām prasībām un citiem ar to saistītajiem noteikumiem.
Niniejszym Toyota Motor Corporation oświadcza, że TMIMB-3 jest zgodny z zasadniczymi wymogami oraz pozostałymi stosownymi postanowieniami Dyrektywy 1999/5/EC.
Hér með lýsir Toyota Motor Corporation yfir því að TMIMB-3 er í samræmi við grunnkröfur og aðrar kröfur, sem gerðar eru í tilskipun 1999/5/EC.
Toyota Motor Corporation erklærer herved at utstyret TMIMB-3 er i samsvar med de grunnleggende krav og øvrige relevante krav i direktiv 1999/5/EF.
С настоящето, Toyota Motor Corporation, декларира, че TMIMB-3 е в съответствие със съществените изисквания и другите приложими разпоредби на Директива 1999/5/EC.
Prin prezenta, Toyota Motor Corporation, declară că aparatul TMIMB-3 este în conformitate cu cerințele esențiale și cu alte prevederi pertinente ale Directivei 1999/5/CE.
Ovim, Toyota Motor Corporation, izjavljuje da ovaj TMIMB-3 je usklađen sa bitnim zahtjevima i drugim relevantnim odredbama Direktive 1999/5/EC.
Nepermjet kesaj, Toyota Motor Corporation, deklaruj qe ky TMIMB-3 eshte ne pajtim me kerkesat thelbesore dhe dispozitat e tjera perkatese te Direktives 1999/5/EC.
Ovim Toyota Motor Corporation, izjavljuje da je TMIMB-3 u skladu s bitnim zahtjevima i drugim relevantnim odredbama Direktive 1999/5/EC i Pravilnika o RiTT opremi (NN 25/2012).
Ovim, Toyota Motor Corporation, deklarirše da je TMIMB-3 u skladu sa osnovnim zahtjevima i ostalim relevantnim odredbama Direktive 1999/5/EC.

 NOTICE

- To ensure the system operates correctly
Do not modify or remove the system. If modified or removed, the proper operation of the system cannot be guaranteed.

1

For safety and security

امداد خودرو فارما

تلفن شبانه روزی: ۰۲۱-۸۸۸۶۲۰۸۵

FarmaSOS.com

Double locking system

Unauthorized access to the vehicle is prevented by disabling the door unlocking function from both the interior and exterior of the vehicle.

Vehicles employing this system have labels on the window glass of both front doors.



Setting the double locking system

Turn the engine switch off, have all the passengers exit the vehicle and ensure that all the doors are closed.

Using the entry function:

Touch the sensor area on the outside door handle twice within 5 seconds.

Using the wireless remote control:

Press  twice within 5 seconds. تلفن شبانه روزی: ۰۲۱-۸۸۴۲۰۸۵

Canceling the double locking system

Using the entry function: Hold the outside door handle.

Using the wireless remote control: Press  . Farmas08.com

CAUTION

■ Double locking system precaution

Never activate the double locking system when there are people in the vehicle because all the doors cannot be opened from inside the vehicle.

Alarm*

The alarm

The alarm uses light and sound to give an alert when an intrusion is detected.

The alarm is triggered in the following situations when the alarm is set:

- A locked door or trunk is unlocked or opened in any way other than using the entry function or wireless remote control. (The door will lock again automatically.)
- The hood is opened.
- The intrusion sensor detects something moving inside the vehicle. (An intruder gets in the vehicle.) (if equipped)
- The tilt sensor detects a change of vehicle inclination. (if equipped)

Setting the alarm system

Close the doors, trunk and hood, and lock all the doors using the entry function or wireless remote control. The system will be set automatically after 30 seconds.

The indicator light changes from being on to flashing when the system is set.



*: If equipped

Deactivating or stopping the alarm

Do one of the following to deactivate or stop the alarm:

- Unlock the doors or open the trunk using the entry function or wireless remote control.
- Start the engine. (The alarm will be deactivated or stopped after a few seconds.)

■ System maintenance

The vehicle has a maintenance-free type alarm system.

■ Items to check before locking the vehicle

To prevent unexpected triggering of the alarm and vehicle theft, make sure of the following:

- Nobody is in the vehicle.
- The windows and moon roof (if equipped) are closed before the alarm is set.
- No valuables or other personal items are left in the vehicle.

تلفن شبانه روزی: ۰۲۱-۸۸۸۶۲۰۸۵

FarmaSOS.com

■ Triggering of the alarm

The alarm may be triggered in the following situations:
(Stopping the alarm deactivates the alarm system.)

- The doors or trunk are unlocked using the mechanical key.

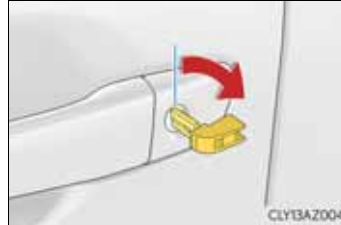

- A person inside the vehicle opens a door, the trunk or hood, or unlocks the vehicle using a inside lock button.

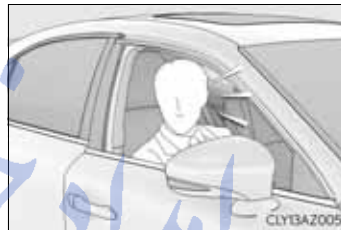

- The battery is recharged or replaced when the vehicle is locked. (→P. 528)

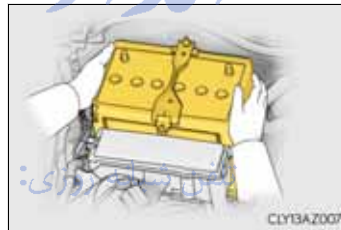

■ Alarm-operated door lock

In the following situations, the doors are locked automatically to prevent intruders:

- The doors are unlocked manually without the mechanical key and the alarm is triggered.
- While the alarm is operating, the doors are unlocked manually without the mechanical key.

⚠ NOTICE

- To ensure the system operates correctly
Do not modify or remove the system. If modified or removed, the proper operation of the system cannot be guaranteed.

Intrusion sensor and tilt sensor (if equipped)

- The intrusion sensor detects intruders or movement in the vehicle.
- The tilt sensor detects changes in vehicle inclination, such as when the vehicle is towed away.

This system is designed to deter and prevent vehicle theft but does not guarantee absolute security against all intrusions.

■ Setting the intrusion sensor and tilt sensor

The intrusion sensor and tilt sensor will be set automatically when the alarm is set. (→P. 83)

■ Canceling the intrusion sensor and tilt sensor

If you are leaving pets or other moving things inside the vehicle, make sure to disable the intrusion sensor and tilt sensor before setting the alarm, as they will respond to movement inside the vehicle.

- 1 Turn the engine switch off.
- 2 Press the intrusion sensor and tilt sensor cancel switch.

Press the switch again to re-enable the intrusion sensor and tilt sensor.

Each time the intrusion sensor is canceled/set, a message will be shown on the multi-information display in the instrument cluster.

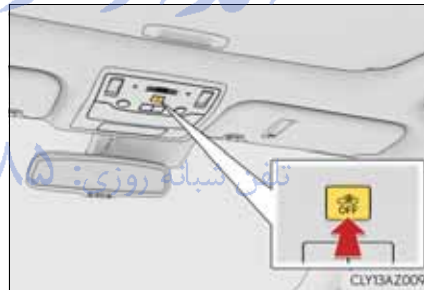

FarmaSOS.com

- Canceling and automatic re-enabling of the intrusion sensor and tilt sensor
 - The alarm will still be set even when the intrusion sensor and tilt sensor are canceled.
 - After the intrusion sensor and tilt sensor are canceled, pressing the engine switch or unlocking the doors using the entry function or wireless remote control will re-enable the intrusion sensor and tilt sensor.
 - The intrusion sensor and tilt sensor will automatically be re-enabled when the alarm system is deactivated.

- Intrusion sensor detection considerations

The sensor may trigger the alarm in the following situations:

- A window or the moon roof is open.
In this case, the sensor may detect the following:
 - Wind or the movement of objects such as leaves and insects inside the vehicle
 - Ultrasonic waves emitted from devices such as the intrusion sensors of other vehicles
 - The movement of people outside the vehicle



- Unstable items, such as dangling accessories or clothes hanging on the coat hooks, are in the vehicle.

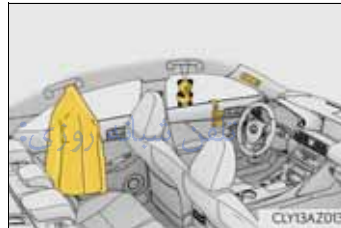

- Places with extreme vibrations or noises, or situations in which the vehicle is subject to repeated impacts or vibrations:
 - When parked in a parking garage
 - When the vehicle is transported on a ferry, trailer, train, etc.
 - When ice adhering to the vehicle is removed
 - When the vehicle is in an automatic or high-pressure car wash
 - When in a hail or lightning storm

- Tilt sensor detection considerations (if equipped)
The sensor may trigger the alarm in the following situations:
 - The vehicle is transported by a ferry, trailer, train, etc.
 - The vehicle is parked in a parking garage.
 - The vehicle is inside a car wash that moves the vehicle.
 - Any of the tires loses air pressure.
 - The vehicle is jacked up.
 - An earthquake occurs or the road caves in.

 NOTICE

- To ensure the intrusion sensor function correctly

- To ensure that the sensors operate properly, do not touch or cover them.



- Do not spray air fresheners or other products directly into the sensor holes.



- Installing accessories other than genuine Lexus parts or leaving objects between the driver's seat and front passenger's seat may reduce the detection performance.

Instrument cluster

2

2. Instrument cluster	
Warning lights and indicators	90
Gauges and meters	95
Multi-information display	100
Fuel consumption information	106

تلفن شبانه روزی: ۰۲۱-۸۸۸۶۲۰۸۵

FarmaSOS.com

Warning lights and indicators

The warning lights and indicators on the instrument cluster and center panel inform the driver of the status of the vehicle's various systems.

For the purpose of explanation, the following illustrations display all warning lights and indicators illuminated.

- ▶ Except F SPORT models



- ▶ F SPORT models



The units used on the meters may differ depending on the target region.

Warning lights

Warning lights inform the driver of malfunctions in the indicated vehicle systems.

*1 	*1 Brake system warning light (→P. 475)	*1 	*1 Automatic headlight leveling system warning light (→P. 476)
*1 	*1 Charging system warning light (→P. 475)		Open door warning light (→P. 477)
*1 	*1 Malfunction indicator lamp (→P. 475)		Low fuel level warning light (→P. 477)
*1 	*1 SRS warning light (→P. 475)		Driver's and front passenger's seat belt reminder light (→P. 477)
*1 	*1 ABS warning light (→P. 476)	*3 	Rear passengers' seat belt reminder lights (→P. 477)
*1 	*1 Electric power steering system warning light (→P. 476)	*1 	*1 Master warning light (→P. 477)
*1, 2 	*1, 2 Pre-crash safety system warning light (→P. 476) (if equipped)	*1 	*1 Tire pressure warning light (→P. 477) (if equipped)
*1 	*1 Slip indicator (→P. 476)		



















*1: These lights turn on when the engine switch is turned to IGNITION ON mode to indicate that a system check is being performed. They will turn off after the engine is on, or after a few seconds. There may be a malfunction in a system if the lights do not come on, or turn off. Have the vehicle inspected by any authorized Lexus dealer or repairer, or another duly qualified and equipped professional.









*2: The light flashes to indicate a malfunction.

*3: This light illuminates on the center panel.

Indicators

The indicators inform the driver of the operating state of the vehicle's various systems.

	Turn signal indicator (→P. 201)		LDA (Lane Departure Alert) indicator (→P. 239) (if equipped)
	Tail light indicator (→P. 204)		Lexus parking assist-sensor indicator (→P. 245) (if equipped)
	Headlight high beam indicator (→P. 204)		*1, 2 Slip indicator (→P. 264)
	Automatic High Beam indicator (→P. 207) (if equipped)		*1 VSC OFF indicator (→P. 265)
	Front fog light indicator (→P. 211) (if equipped)		*1, 3 PCS Pre-crash safety system warning light (→P. 270) (if equipped)
	Rear fog light indicator (→P. 211)		*4, 5 BSM (Blind Spot Monitor) outside rear view mirror indicators (→P. 276) (if equipped)
	Gear Shift Indicator (→P. 199) (if equipped)		*6 Security indicator (→P. 77, 83)
	Cruise control indicator (→P. 223, 227) (if equipped)		*7 Low outside temperature indicator (→P. 95)
	Dynamic radar cruise control indicator (→P. 227) (if equipped)		*1 Eco Driving Indicator Light (→P. 105)

	Cruise control “SET” indicator (→P. 223, 227) (if equipped)		*8 Eco drive mode indicator (→P. 261)
	*9 Eco drive mode indicator (→P. 261)		*8 Snow mode indicator (→P. 196)
	*8 “SPORT” indicator (→P. 261)		*9 Snow mode indicator (→P. 196)
	*9 “SPORT” indicator (→P. 261)		*1, 6 “PASSENGER AIR BAG” indicator (→P. 52)

- *1: These lights turn on when the engine switch is turned to IGNITION ON mode to indicate that a system check is being performed. They will turn off after the engine is on, or after a few seconds. There may be a malfunction in a system if the lights do not come on, or turn off. Have the vehicle inspected by any authorized Lexus dealer or repairer, or another duly qualified and equipped professional.
- *2: The light flashes to indicate that the system is operating.
- *3: The light comes on when the system is turned off. The light flashes faster than usual to indicate that the system is operating. تلفن شبانه روزی:
- *4: In order to confirm operation, the BSM outside rear view mirror indicators illuminate in the following situations:
- When the engine switch is turned to IGNITION ON mode while the BSM main switch is set to ON.
 - When the BSM main switch is set to ON while the engine switch is in IGNITION ON mode.
- If the system is functioning correctly, the BSM outside rear view mirror indicators will turn off after a few seconds.
- If the BSM outside rear view mirror indicators do not illuminate or do not turn off, there may be a malfunction in the system.
- If this occurs, have the vehicle inspected by any authorized Lexus dealer or repairer, or another duly qualified and equipped professional.
- *5: This light illuminates on the outside rear view mirrors.
- *6: This light illuminates on the center panel.
- *7: When the outside temperature is approximately 3°C (37°F) or lower, the indicator will flash for approximately 10 seconds, then stay on.
- *8: Except F SPORT models
- *9: F SPORT models

**CAUTION****■ If a safety system warning light does not come on**

Should a safety system light such as the ABS and SRS warning light not come on when you start the engine, this could mean that these systems are not available to help protect you in an accident, which could result in death or serious injury. Have the vehicle inspected by any authorized Lexus dealer or repairer, or another duly qualified and equipped professional immediately if this occurs.

امداد خودرو فارما

تلفن شبانه روزی: ۰۲۱-۸۸۸۶۲۰۸۵

FarmaSOS.com

Gauges and meters

- ▶ Except F SPORT models



- ▶ F SPORT models (when the main meter is in the center position)



- F SPORT models (when the main meter is in the right-side position)



The units used on the meters may differ depending on the target region.

- ① Engine coolant temperature gauge
Displays the engine coolant temperature
- ② Tachometer
Displays the engine speed in revolutions per minute
- ③ Outside temperature
Displays the outside temperature within the range of -40°C (-40°F) to 50°C (122°F). Low outside temperature indicator comes on when the ambient temperature is 3°C (37°F) or lower.
- ④ Shift position and gear position (\rightarrow P. 195)
- ⑤ Speedometer
- ⑥ Fuel gauge
- ⑦ Multi-information display
Presents the driver with a variety of vehicle data (\rightarrow P. 100)
Displays warning messages in case of a malfunction (\rightarrow P. 481)
- ⑧ Odometer and trip meter display
Odometer:
Displays the total distance the vehicle has been driven
Trip meter:
Displays the distance the vehicle has been driven since the meter was last reset. Trip meters “A” and “B” can be used to record and display different distances independently.

Changing the display

► Odometer/Trip meter

Switches between odometer and trip meter displays. When the trip meter is displayed, pressing and holding the button will reset the trip meter.

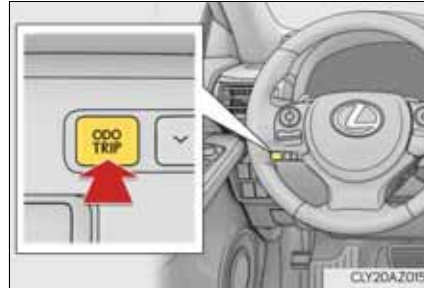

► Main meter (F SPORT models)

Moves between center and right-side positions.



Instrument panel light control

The brightness of the instrument panel lights can be adjusted.

- ① Darker
- ② Brighter

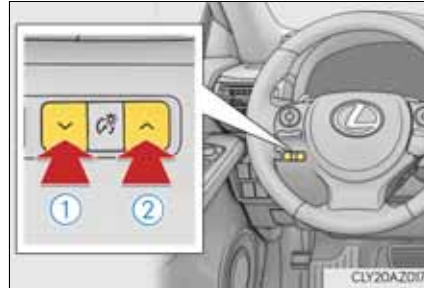

- The meters and display illuminate when
The engine switch is in IGNITION ON mode.
- Instrument panel brightness adjustment
The instrument panel brightness levels when the tail lights are on and off can be adjusted individually. However, when the surroundings are bright (daytime, etc.), turning on the tail lights will not change the instrument panel brightness.
- Outside temperature display
In the following situations, the correct outside temperature may not be displayed, or the display may take longer than normal to change.
 - When stopped, or driving at low speeds (less than 20 km/h [12 mph])
 - When the outside temperature has changed suddenly (at the entrance/exit of a garage, tunnel, etc.)
- Pop-up display
In some situations, such as when a switch operation is performed, a pop-up display, such as the operating methods of the headlight switch, will be temporarily displayed on the multi-information display or the odometer/trip meter screen (F SPORT models only).
The pop-up display function can be set on/off. (→P. 103)
- Liquid crystal display
Small spots or light spots may appear on the display. This phenomenon is characteristic of liquid crystal displays, and there is no problem continuing to use the display.
- Customization
The meter display can be customized on the multi-information display. (→P. 100)

 NOTICE

- To prevent damage to the engine and its components
 - Do not let the indicator needle of the tachometer enter the red zone, which indicates the maximum engine speed.
 - The engine may be overheating if the engine coolant temperature gauge is in the red zone (H). In this case, immediately stop the vehicle in a safe place, and check the engine after it has cooled completely. (→P. 530)

امداد خودرو فارما

تلفن شبانه روزی: ۰۲۱-۸۸۸۶۲۰۸۵

FarmaSOS.com

Multi-information display

The multi-information display presents the driver with a variety of vehicle data.



Drive information

Select to display various drive data. (→P. 101)



Navigation system-linked display (if equipped)

Select to display the following navigation system-linked information.

- Route guidance
- Compass display (north-up display/heading-up display)



Audio system-linked display

Select to enable selection of an audio source or track on the meter using the meter control switches.



Dynamic radar cruise control operation guide (if equipped)

Select to display operation procedures of the dynamic radar cruise control. (→P. 227)

The  tab will change to  when the vehicle is in constant speed control mode. (→P. 232)

If activated, the operational status of the LDA (Lane Departure Alert) system will also be displayed. (→P. 241)



Warning message display

Select to display warning messages and measures to be taken if a malfunction is detected. (→P. 481)





Settings display

Select to change the meter display settings. (→P. 102)

◆ Operating the meter control switches

The multi-information display is operated using the meter control switches.

- ① Select an item/change pages
- ② Enter/Set
 - ▶ Except F SPORT models
- ③ Press: Displays the screen registered to 
- ▶ When no screen has been registered, the drive information screen will be displayed.
- ▶ Press and hold: Registers the currently displayed screen to 
- ▶ When the confirmation screen is displayed, select yes to register the screen. If the selected screen cannot be registered, a registration failure message will be shown.
- ▶ F SPORT models
- ③ Move the main meter
- ④ Return to the previous screen

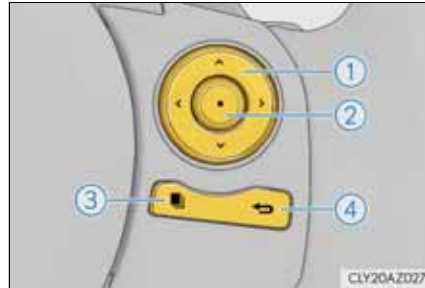

2

Instrument cluster

Drive information

- Current fuel consumption*
Displays the current rate of fuel consumption
- Average fuel economy (after reset/after start/after refuel)*
Displays the average fuel economy since the function was reset, the engine was started, and the vehicle was refueled, respectively
- Average vehicle speed (after reset/after start)*
Displays the average vehicle speed since the function was reset and the engine was started, respectively
- Elapsed time (after reset/after start)*
Displays the elapsed time since the function was reset and the engine was started, respectively

- Distance (driving range/after start)*

Displays the estimated maximum distance that can be driven with the quantity of fuel remaining and the distance driven after the engine was started respectively.

 - This distance is computed based on your average fuel consumption. As a result, the actual distance that can be driven may differ from that displayed.
 - When only a small amount of fuel is added to the tank, the display may not be updated.

When refueling, turn the engine switch off. If the vehicle is refueled without turning the engine switch off, the display may not be updated.
 - Eco Driving Indicator

→P. 105
 - Gear positions

→P. 200
- *: Displayed when the item is set in “Drive Info 1” or “Drive Info 2”. Use these values as a reference.

Settings display

- Language

Select to change the language on the display.
- Units

Select to change the unit of measure for fuel consumption.
- Eco Driving Indicator Light

Select to activate/deactivate the Eco Driving Indicator Light.
-  switch settings (except F SPORT models)

Displays a procedure to register a desired screen to .

You can register 1 screen as a shortcut, which can be displayed by pressing . (→P. 101)
- Drive information 1/Drive information 2

Select to select up to 2 items that will be displayed on the “Drive Info 1” screen and “Drive Info 2” screen respectively. (→P. 101)

■ Pop-up display

Select to set the following pop-up displays, which may appear in some situations, on/off.

- Route guidance display of the navigation system-linked system (if equipped)
- Incoming call display of the hands-free phone system
- Windshield wiper switch operation display (if equipped)
- Headlight switch operation display (if equipped)
- Dynamic radar cruise control operation display (if equipped)
- Instrument panel brightness adjustment display
- Main meter switch operation display (F SPORT models)

■ Accent color (except F SPORT models)

Select to change the accent colors on the screen, such as the cursor color.

■ Needle (F SPORT models)

Select to change the needle color for the tachometer.

■ Speed indicator (F SPORT models)

Select to set the speed indicator on/off.

When set to on, both sides of the displayed speed unit will turn yellow when the vehicle reaches a set speed.

Selectable speed range:

Except U.K.: 50 km/h to 200 km/h (30 mph to 125 mph)*

U.K.: 30 mph to 100 mph (50 km/h to 160 km/h)*

The indicator will illuminate in yellow at an optionally set speed and red at the fixed high speed.

*: Always observe the legal speed limit when driving on public roads.

■ Rev indicator (F SPORT models)



Select to set the rev indicator on/off.

When set to on, the tachometer will show a ring-shaped indicator in red when the engine reaches a set speed.

Selectable engine speed range:
2000 r/min to 6600 r/min



امداد خودرو فارما

تلفن شبانه روزی: ۰۲۱-۸۸۸۶۲۰۸۵

FarmaSOS.com

■ Rev peak (F SPORT models)

Select to set the rev peak on/off.

When set to on and the engine speed reaches or exceeds 5000 r/min, an afterimage of the tachometer will be displayed at the highest engine speed for approximately 0.5 seconds.



■ Initialization

Select to reset the meter display settings. (→P. 550)

■ Eco Driving Indicator

① Eco Driving Indicator Light

During Eco-friendly acceleration (Eco driving), the Eco Driving Indicator Light will turn on. When the acceleration exceeds the Zone of Eco driving, or when the vehicle is stopped, the light turns off.

② Eco Driving Indicator Zone Display

Suggests the Zone of Eco driving with current Eco driving ratio based on acceleration.

③ Eco driving ratio based on acceleration

If the acceleration exceeds the Zone of Eco driving, the right side of the Eco Driving Indicator Zone Display will illuminate.

④ Zone of Eco driving



Eco Driving Indicator will not operate under the following conditions:

- The shift lever is in any position other than D.
- A paddle shift switch is operated.
- Neither normal mode nor Eco drive mode is selected. (→P. 261)
- The vehicle speed is approximately 130 km/h (80 mph) or higher.

■ Suspension of the settings display

In the following situations, the settings display using the meter control switches will be suspended.

- When a warning message appears on the multi-information display
- When the vehicle begins to move

■ Liquid crystal display

→P. 98

 CAUTION

■ The information display at low temperatures

Allow the interior of the vehicle to warm up before using the liquid crystal information display. At extremely low temperatures, the information display monitor may respond slowly, and display changes may be delayed.

For example, there is a lag between the driver's shifting and the new gear number appearing on the display. This lag could cause the driver to downshift again, causing rapid and excessive engine braking and possibly an accident resulting in death or injury.

■ Cautions during setting up the display

As the engine needs to be running during setting up the display, ensure that the vehicle is parked in a place with adequate ventilation. In a closed area such as a garage, exhaust gases including harmful carbon monoxide (CO) may collect and enter the vehicle. This may lead to death or a serious health hazard.

 NOTICE

■ During setting up the display

To prevent battery discharge, ensure that the engine is running while setting up the display features.

تلفن شبانه روزی: ۰۲۱-۸۸۶۲۰۸۵

FarmaSOS.com

Fuel consumption information

Fuel consumption information can be displayed on the navigation system screen or the Lexus Display Audio screen.

► Navigation system

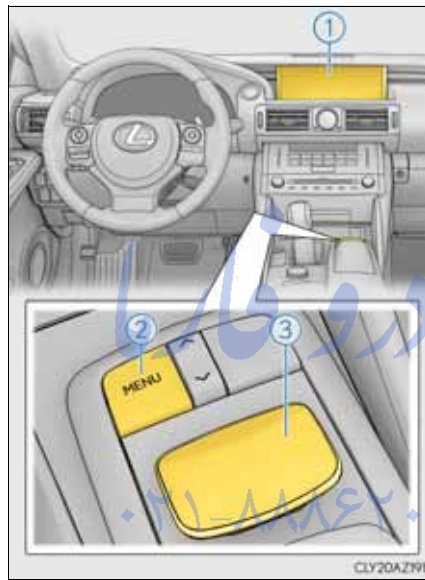

- ① Navigation system screen
- ② "MENU" button
- ③ Remote Touch knob

► Lexus Display Audio system

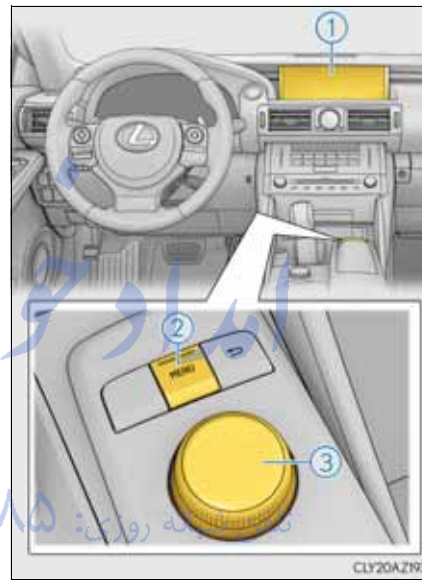

- ① Lexus Display Audio screen
- ② "MENU" button
- ③ Lexus Display Audio controller

Trip information

► Navigation system

Press the “MENU” button on the Remote Touch, and then select “Car” on the “Menu” screen.

If the “Past record” screen is displayed, select “Trip information”.



- ① Resetting the consumption data
- ② Fuel consumption in the past 15 minutes
- ③ Displays the average vehicle speed since the engine was started.
- ④ Displays the elapsed time since the engine was started.
- ⑤ Cruising range (→P. 111)



FarmaSOS.com

► Lexus Display Audio system

Press the “MENU” button on the Lexus Display Audio controller, and then select “Car” on the “MENU” screen.

If the “Trip information” screen does not appear, move the controller to the right and select “Trip information”.



- ① Fuel consumption in the past 15 minutes
- ② Displays the average vehicle speed since the engine was started.
- ③ Displays the elapsed time since the engine was started.
- ④ Cruising range (→P. 111)

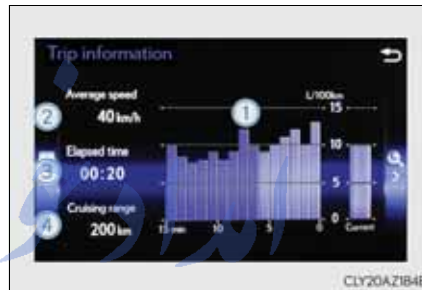

Average fuel consumption for the past 15 minutes is divided by color into past averages and averages attained since the engine switch was last turned to IGNITION ON mode. Use the displayed average fuel consumption as a reference.

The image is an example only.

Past record

► Navigation system

Press the “MENU” button on the Remote Touch, and then select “Car” on the “Menu” screen.

If the “Trip information” screen is displayed, select “Past record”.

- ① Resetting the past record data
- ② Best recorded fuel consumption
- ③ Average fuel consumption
- ④ Previous fuel consumption record
- ⑤ Updating the average fuel consumption data



► Lexus Display Audio system

Press the “MENU” button on the Lexus Display Audio controller, and then select “Car” on the “MENU” screen.

If the “Past record” screen does not appear, move the controller to the right and select “Past record”.

- ① Previous fuel consumption record
- ② Average fuel consumption
- ③ Best recorded fuel consumption

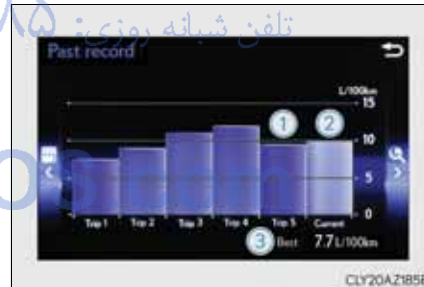

The average fuel consumption history is divided by color into past averages and the average fuel consumption since the last updated. Use the displayed average fuel consumption as a reference.

The image is an example only.

- Updating the past record data
 - ▶ Navigation system
Update the average fuel consumption by selecting “Update” to measure the current fuel consumption again.
 - ▶ Lexus Display Audio system
Update the average fuel consumption by moving the controller to the left and select “Update” to measure the current fuel consumption again.
- Resetting the data
 - ▶ Navigation system
The fuel consumption data can be deleted by selecting “Clear”.
 - ▶ Lexus Display Audio system
The fuel consumption data can be deleted by moving the controller to the left and select “Clear”.
- Cruising range
Displays the estimated maximum distance that can be driven with the quantity of fuel remaining.
This distance is computed based on your average fuel consumption.
As a result, the actual distance that can be driven may differ from that displayed.

تلفن شبانه روزی: ۰۲۱-۸۸۸۶۲۰۸۵

FarmaSOS.com

Operation of
each component

3

- 3-1. Key information
Keys112
- 3-2. Opening, closing and locking
the doors and trunk
Doors118
Trunk..... 125
Smart entry & start system 130
- 3-3. Adjusting the seats
Front seats 145
Rear seats 147
Driving position memory.. 149
Head restraints 154
- 3-4. Adjusting the steering
wheel and mirrors
Steering wheel 157
Inside rear view mirror 159
Outside rear view mirrors . 161
- 3-5. Opening, closing the windows
and moon roof
Power windows..... 165
Moon roof 168

Keys

The keys

The following keys are provided with the vehicle.

- ① Electronic keys
 - Operating the smart entry & start system (→P. 130)
 - Operating the wireless remote control function
- ② Mechanical keys
- ③ Key number plate
- ④ Card key (electronic key) (if equipped)
 - Operating the smart entry & start system (→P. 130)

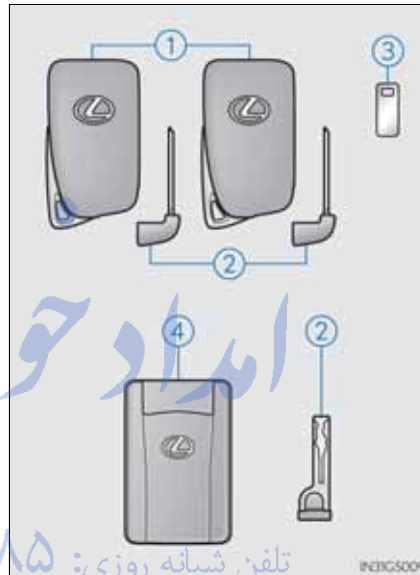

Wireless remote control

- ① Locks the doors (→P. 118)
- ② Closes the windows and moon roof* (→P. 118)
- ③ Unlocks the doors (→P. 118)
- ④ Opens the windows and moon roof* (→P. 118)
- ⑤ Opens the trunk (→P. 126)



*: These settings must be customized at any authorized Lexus dealer or repairer, or another duly qualified and equipped professional.

Using the mechanical key

To take out the mechanical key, push the release button and take the key out.

The mechanical key can only be inserted in one direction, as the key only has grooves on one side. If the key cannot be inserted in a lock cylinder, turn it over and re-attempt to insert it.

After using the mechanical key, store it in the electronic key. Carry the mechanical key together with the electronic key. If the electronic key battery is depleted or the entry function does not operate properly, you will need the mechanical key. (→P. 523)

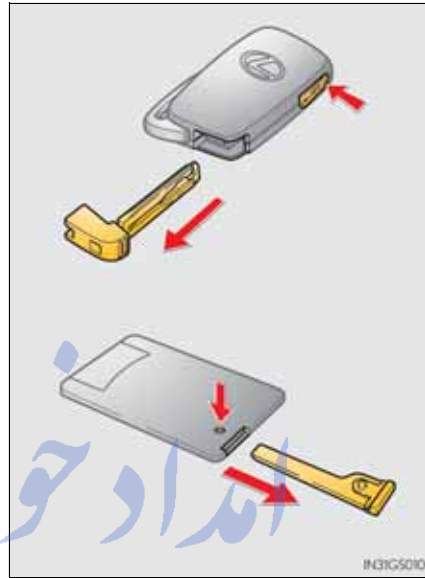

3

Operation of each component

تلفن شبانه روزی: ۰۲۱-۸۸۶۲۰۸۵

FarmaSOS.com

■ Card key (if equipped)

- The card key is not waterproof.
- The mechanical key that is stored inside the card key should be used only if a problem arises, such as when the card key does not operate properly.
- If it is difficult to take out the mechanical key, push down the lock release button using a pen tip etc. If it is still difficult to pull it out, use a coin etc.
- To store the mechanical key in the card key, insert it while pressing the lock release button.

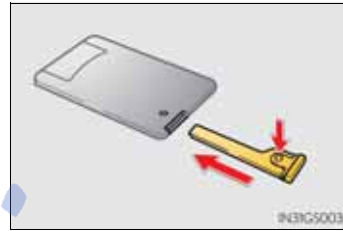

- If the battery cover is not installed and the battery falls out or if the battery was removed because the key got wet, reinstall the battery with the positive terminal facing the Lexus emblem.

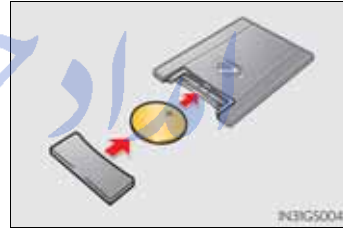

■ When required to leave the vehicle's key with a parking attendant

Set the luggage security system (→P. 126) on and lock the glove box (→P. 390) as circumstances demand.

Remove the mechanical key for your own use and provide the attendant with the electronic key only.

■ If you lose your mechanical keys

New genuine mechanical keys can be made by any authorized Lexus dealer or repairer, or another duly qualified and equipped professional using the other mechanical key and the key number stamped on your key number plate. Keep the plate in a safe place such as your wallet, not in the vehicle.

- When riding in an aircraft
When bringing an electronic key onto an aircraft, make sure you do not press any buttons on the electronic key while inside the aircraft cabin. If you are carrying an electronic key in your bag etc., ensure that the buttons are not likely to be pressed accidentally. Pressing a button may cause the electronic key to emit radio waves that could interfere with the operation of the aircraft.
- Electronic key battery depletion
 - The standard battery life is 1 to 2 years. (The card key battery life is about a year and a half.)
 - If the battery becomes low, an alarm will sound in the cabin when the engine is stopped. (→P. 492)
 - As the electronic key always receives radio waves, the battery will become depleted even if the electronic key is not used. The following symptoms indicate that the electronic key battery may be depleted. Replace the battery when necessary. (→P. 441)
 - The smart entry & start system or the wireless remote control does not operate.
 - The detection area becomes smaller.
 - The LED indicator on the key surface does not turn on.
 - To avoid serious deterioration, do not leave the electronic key within 1 m (3 ft.) of the following electrical appliances that produce a magnetic field:
 - TVs
 - Personal computers
 - Cellular phones, cordless phones and battery chargers
 - Recharging cellular phones or cordless phones
 - Table lamps
 - Induction cookers
- Replacing the battery
→P. 441
- Confirmation of the registered key number
The number of keys already registered to the vehicle can be confirmed. Ask any authorized Lexus dealer or repairer, or another duly qualified and equipped professional for details.
- If a wrong key is used
The key cylinder rotates freely to isolate inside mechanism.



NOTICE

- To prevent key damage
 - Do not drop the keys, subject them to strong shocks or bend them.
 - Do not expose the keys to high temperatures for long periods of time.
 - Do not get the keys wet or wash them in an ultrasonic washer etc.
 - Do not attach metallic or magnetic materials to the keys or place the keys close to such materials.
 - Do not disassemble the keys.
 - Do not attach a sticker or anything else to the surface of the electronic key.
 - Do not place the keys near objects that produce magnetic fields, such as TVs, audio systems and induction cookers, or medical electrical equipment, such as low-frequency therapy equipment.
- Carrying the electronic key on your person

Carry the electronic key 10 cm (3.9 in.) or more away from electric appliances that are turned on. Radio waves emitted from electric appliances within 10 cm (3.9 in.) of the electronic key may interfere with the key, causing the key to not function properly.
- In case of a smart entry & start system malfunction or other key-related problems

Take your vehicle with all the electronic keys provided with your vehicle, including the card key, to any authorized Lexus dealer or repairer, or another duly qualified and equipped professional.

تلفن شبانه روزی: ۰۲۱-۸۸۸۶۲۰۸۵

FarmaSOS.com

 NOTICE

■ When an electronic key is lost

If the electronic key remains lost, the risk of vehicle theft increases significantly. Visit any authorized Lexus dealer or repairer, or another duly qualified and equipped professional immediately with all remaining electronic keys and the card key that were provided with your vehicle.

■ Handling the card key

- Do not apply excess force when inserting the mechanical key into the card key. Doing so may damage the card key.
- If the battery or card key terminals get wet, the battery may corrode. If the key is dropped into water, or if drinking water etc. is spilled on the key, immediately remove the battery cover and wipe the battery and terminals. (To remove the battery cover, lightly grasp and pull it.) If the battery is corroded, have any authorized Lexus dealer or repairer, or another duly qualified and equipped professional replace the battery.
- Do not crush the battery cover or use a screwdriver to remove the battery cover. Forcibly removing the battery cover may bend or damage the key.
- If the battery cover is frequently removed, the battery cover may become loose.
- When installing the battery, make sure to check the direction of the battery. Installing the battery in the wrong direction may cause the battery to deplete rapidly.
- The surface of the card key may be damaged, or its coating may peel off in the following situations:
 - The card key is carried together with hard objects, such as coins and keys.
 - The card key is scraped with a sharp object, such as the tip of a mechanical pencil.
 - The surface of the card key is wiped with thinner or benzene.

FarmaSOS.com

Doors

Unlocking and locking the doors from the outside

The vehicle can be locked and unlocked using the entry function, wireless remote control or door lock switches.

◆ Entry function (if equipped)

Carry the electronic key to enable this function.

- ① Grip the handle to unlock the doors.

Make sure to touch the sensor on the back of the handle.

The doors cannot be unlocked for 3 seconds after the doors are locked.

- ② Touch the lock sensor (indentation on the upper part of the door handle) to lock the doors.



◆ Wireless remote control

- ① Locks all the doors

Press and hold to close the windows and moon roof.*

- ② Unlocks all the doors

Press and hold to open the windows and moon roof.*

*: These settings must be customized at any authorized Lexus dealer or repairer, or another duly qualified and equipped professional.



- Operation signals

The emergency flashers flash to indicate that the doors have been locked/unlocked. (Locked: once; Unlocked: twice)

A buzzer sounds to indicate that the windows and moon roof are operating.

- Security feature

If a door is not opened within approximately 30 seconds after the vehicle is unlocked, the security feature automatically locks the vehicle again.

- Welcome light illumination control

The front position, tail and license plate lights automatically turn on at night when the doors are unlocked using the entry function or wireless remote control if the light switch is in the "AUTO" position.

- When the door cannot be locked by the lock sensor on the upper part of the door handle (vehicles with entry function)

If the door will not lock even when the top-side sensor area is touched, try touching both the topside and underside sensor areas at the same time.



- Door lock buzzer

If an attempt to lock the doors is made when a door is not fully closed, a buzzer sounds continuously for 5 seconds. Fully close the door to stop the buzzer, and lock the vehicle once more.

- Setting the alarm (if equipped)

Locking the doors will set the alarm system. (→P. 83)

- If the smart entry & start system or the wireless remote control does not operate properly

Use the mechanical key to lock and unlock the doors. (→P. 523)

Replace the key battery with a new one if it is depleted. (→P. 441)

⚠ CAUTION

- When closing the windows or moon roof using wireless remote control
Observe the following precautions.
Failing to do so may result in death or serious injury.
 - Check to make sure that all passengers do not have any part of their body in a position where it could be caught when a window or moon roof is being operated.
 - To prevent inadvertent power windows and moon roof operation, never let a small child have and use the wireless remote control.
- Jam protection function
 - Never try jamming any part of your body to activate the jam protection function intentionally.
 - The jam protection function may not work if something gets caught just before the window or moon roof fully closes.

امداد خودرو فارما

تلفن شبانه روزی: ۰۲۱-۸۸۸۶۲۰۸۵

FarmaSOS.com

Unlocking and locking the doors from the inside

◆ Door lock switches

- ① Locks all the doors
- ② Unlocks all the doors

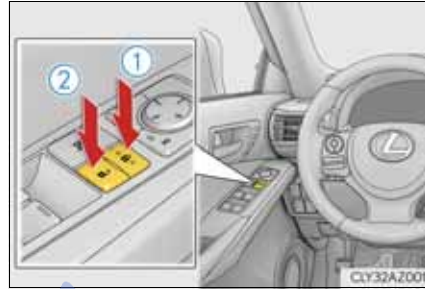

◆ Inside lock buttons

- ① Locks the door
 - ② Unlocks the door
- The front doors can be opened by pulling the inside handle even if the lock buttons are in the lock position.

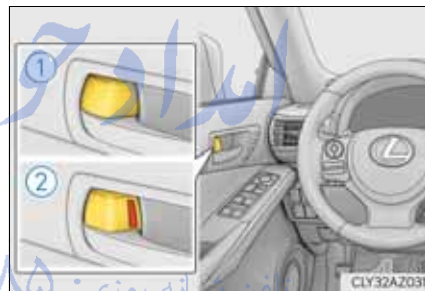

Locking the front doors from the outside without a key

- 1 Move the inside lock button to the lock position.
- 2 Close the door while pulling the door handle.

The door cannot be locked if the engine switch is in ACCESSORY or IGNITION ON mode, or the electronic key is left inside the vehicle. However, the key may not be detected correctly and the door may be locked.

Rear door child-protector lock

The door cannot be opened from inside the vehicle when the lock is set.

- ① Unlock
- ② Lock

These locks can be set to prevent children from opening the rear doors. Push down on each rear door switch to lock both rear doors.



Automatic door locking and unlocking systems





The following functions can be set or canceled:

For instructions on customizing, refer to P. 549.



Function	Operation
Speed linked door locking function	All the doors are locked when the vehicle speed is approximately 20 km/h (12 mph) or higher.
Shift position linked door locking function	Shifting the shift lever out of P locks all the doors.
Shift position linked door unlocking function	All doors are automatically unlocked when shifting the shift lever to P.
Driver's door linked door unlocking function	All doors are automatically unlocked when driver's door is opened.

■ Switching the door unlock function (vehicles with entry function)

It is possible to set which doors the entry function unlocks using the wireless remote control.

- 1 Turn the engine switch off.
- 2 Cancel the intrusion sensor and tilt sensor of the alarm system to prevent unintended triggering of the alarm while changing the settings. (if equipped) (→P. 86)
- 3 When the indicator light on the key surface is not on, press and hold  ,  or  for approximately 5 seconds while pressing and holding  .

The setting changes each time an operation is performed, as shown below. (When changing the setting continuously, release the buttons, wait for at least 5 seconds, and repeat step 3.)

Multi-information display	Unlocking function	Beep
 (Left-hand drive vehicles)	Holding the driver's door handle unlocks only the driver's door.	Exterior: Beeps 3 times Interior: Pings once
 (Right-hand drive vehicles)	Holding a passenger's door handle unlocks all the doors.	
	Holding a door handle unlocks all the doors.	Exterior: Beeps twice Interior: Pings once

For vehicles with an alarm: To prevent unintended triggering of the alarm, unlock the doors using the wireless remote control and open and close a door once after the settings have been changed. (If a door is not opened within 30 seconds after  is pressed, the doors will be locked again and the alarm will automatically be set.)

In a case that the alarm is triggered, immediately stop the alarm. (→P. 84)

- Impact detection door lock release system
In the event that the vehicle is subject to a strong impact, all the doors are unlocked. Depending on the force of the impact or the type of accident, however, the system may not operate.
- Using the mechanical key
The doors can also be locked and unlocked with the mechanical key. (→P. 523)
- Conditions affecting the operation of the smart entry & start system or wireless remote control
→P. 132
- Customization
Settings (e.g. unlocking function using a key) can be changed.
(Customizable features: →P. 549)

**CAUTION**

- To prevent an accident
Observe the following precautions while driving the vehicle.
Failure to do so may result in a door opening and an occupant being thrown out of the vehicle, resulting in death or serious injury.
 - Ensure that all doors are properly closed.
 - Do not pull the inside handle of the doors while driving.
Be especially careful with the front doors, as the doors may be opened even if the inside lock buttons are in locked position.
 - Set the rear door child-protector locks when children are seated in the rear seats.

FarmaSOS.com

Trunk

The trunk can be opened using the trunk opener, entry function or wireless remote control.

Opening the trunk from inside the vehicle

Press the opener switch.



Opening the trunk from outside the vehicle

◆ Trunk button

Vehicles with entry function:

While carrying the electronic key, press the button on the trunk lid.

When all the doors are unlocked with the power door lock system, the trunk can be opened without carrying the electronic key.

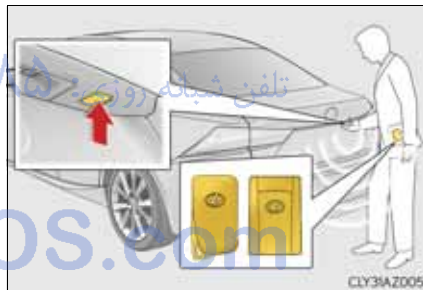

Vehicles without entry function:

Unlock all the doors with the power door lock system and press the button on the trunk lid.

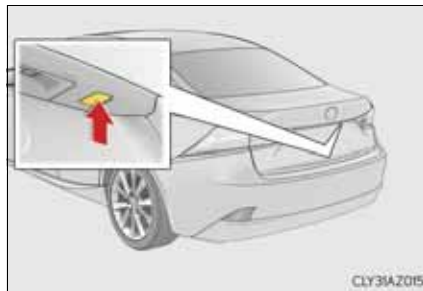

◆ Wireless remote control

Press and hold the switch.



When closing the trunk

Using the trunk grip, lower the trunk without applying force to the side and push the trunk down from the outside to close it.

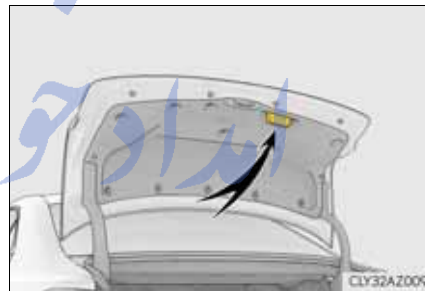

Luggage security system

To protect luggage stored in the trunk against theft, the luggage security system can be set to on.

- 1 Folding type rear seats only: Move the luggage security system levers to the lock position.

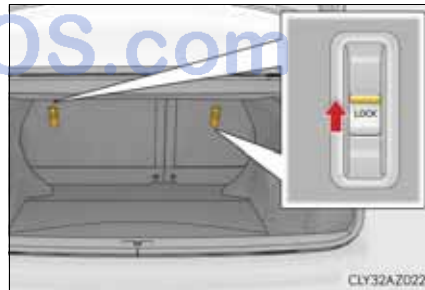

- 2** To disable the trunk opener, turn the main switch in the glove box off

- ① On
- ② Off

When the main switch is off, the trunk lid cannot be opened even with the wireless remote control or entry function.

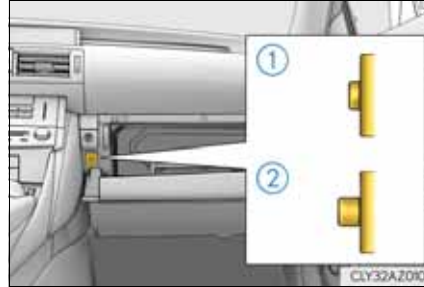

- Trunk light
 - The trunk light turns on when the trunk is opened.
- Function to prevent the trunk being locked with the electronic key inside
 - When all doors are locked, closing the trunk lid with the electronic key left inside the trunk will sound an alarm. In this case, the trunk lid can be opened pressing the trunk release button on the trunk lid.
 - If the spare electronic key is put in the trunk with all the doors locked, the key confinement prevention function is activated so the trunk can be opened. In order to prevent theft, take all electronic keys with you when leaving the vehicle.
 - If the electronic key is put in the trunk with all the doors locked, the key may not be detected depending on the location of the key and the surrounding radio wave conditions. In this case, the key confinement prevention function cannot be activated, causing the doors to lock when the trunk is closed. Make sure to check where the key is before closing the trunk.
 - The key confinement prevention function cannot be activated if any one of the doors is unlocked. In this case, open the trunk using the trunk opener.
- Using the mechanical key
 - The trunk can be also opened using the mechanical key. (→P. 523)
- If the smart entry & start system or the wireless remote control does not operate properly
 - Use the mechanical key to unlock the trunk. (→P. 523)
 - Replace the key battery with a new one if it is depleted. (→P. 441)
- When leaving a key to the vehicle with a parking attendant
 - P. 114
- Customization
 - The trunk unlocking operation can be changed. (Customizable features: →P. 549)

 CAUTION

Observe the following precautions.

Failure to do so may result in death or serious injury.

■ Before driving

- Make sure that the trunk lid is fully closed. If the trunk lid is not fully closed, it may open unexpectedly while driving and hit near-by objects or luggage in the trunk may be thrown out, causing an accident.
- Do not allow children to play in the trunk.
If a child is accidentally locked in the trunk, they could suffer from heat exhaustion, suffocation or other injuries.
- Do not allow a child to open or close the trunk lid.
Doing so may cause the trunk lid to open unexpectedly, or cause the child's hands, head, or neck to be caught by the closing trunk lid.

■ Important points while driving

Never let anyone sit in the trunk. In the event of sudden braking or a collision, they are susceptible to death or serious injury.

تلفن شبانه روزی: ۰۲۱-۸۸۸۶۲۰۸۵

FarmaSOS.com

 CAUTION

■ Using the trunk

Observe the following precautions.

Failure to do so may cause parts of the body to be caught, resulting in serious injury.

- Remove any heavy loads, such as snow and ice, from the trunk lid before opening it. Failure to do so may cause the trunk lid to suddenly shut again after it is opened.
- When opening or closing the trunk lid, thoroughly check to make sure the surrounding area is safe.
- If anyone is in the vicinity, make sure they are safe and let them know that the trunk is about to open or close.
- Use caution when opening or closing the trunk lid in windy weather as it may move abruptly in strong wind.

- The trunk lid may suddenly shut if it is not opened fully. It is more difficult to open or close the trunk lid on an incline than on a level surface, so beware of the trunk lid unexpectedly opening or closing by itself. Make sure that the trunk lid is fully open and secure before using the trunk.



- When closing the trunk lid, take extra care to prevent your fingers etc. from being caught.
- When closing the trunk lid, make sure to press it lightly on its outer surface. If the trunk handle is used to fully close the trunk lid, it may result in hands or arms being caught.



- Do not attach any accessories other than genuine Lexus parts to the trunk lid. Such additional weight on the trunk lid may cause the lid to suddenly shut again after it is opened.

Smart entry & start system

The following operations can be performed simply by carrying the electronic key (including the card key) on your person, for example in your pocket. The driver should always carry the electronic key.

- Locks and unlocks the doors (vehicles with entry function) (→P. 118)
- Opens the trunk (vehicles with entry function) (→P. 125)
- Starts the engine (→P. 190)

■ Antenna location

- ① Antennas outside the cabin (vehicles with entry function)
- ② Antennas inside the cabin
- ③ Antenna inside the trunk
- ④ Antenna outside the trunk (vehicles with entry function)

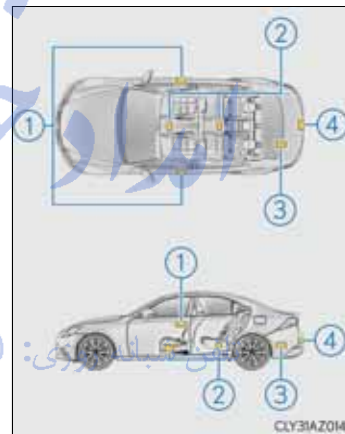

■ Effective range (areas within which the electronic key is detected)

- When locking or unlocking the doors (vehicles with entry function)

The system can be operated when the electronic key is within about 0.7 m (2.3 ft.) of an outside door handle. (Only the doors detecting the key can be operated.)



- When opening the trunk (vehicles with entry function)

The system can be operated when the electronic key is within about 0.7 m (2.3 ft.) of the trunk release button.

- When starting the engine or changing engine switch modes

The system can be operated when the electronic key is inside the vehicle.



■ Battery-saving function (vehicles with entry function)

The battery-saving function will be activated in order to prevent the electronic key battery and the battery from being discharged while the vehicle is not in operation for a long time.

- In the following situations, the smart entry & start system may take some time to unlock the doors.
 - The electronic key has been left within approximately 2 m (6 ft.) of the outside of the vehicle for 10 minutes or longer.
 - The smart entry & start system has not been used for 5 days or longer.
- If the smart entry & start system has not been used for 14 days or longer, the doors cannot be unlocked at any door except the driver's door. In this case, hold the driver's door handle, or use the wireless remote control or mechanical key, to unlock the doors.

■ Electronic Key battery-Saving Function

When battery-saving mode is set, battery depletion is minimized by stopping the electronic key from receiving radio waves.

Press  twice while pressing and holding . Confirm that the electronic key indicator flashes 4 times.

While the battery-saving mode is set, the smart entry & start system cannot be used. To cancel the function, press any of the electronic key buttons.

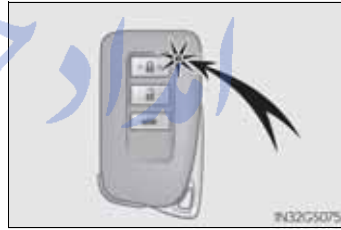

تلفن شبانه روزی: ۰۲۱-۸۸۶۲۰۸۵

FarmaSOS.com

■ Conditions affecting operation

The smart entry & start system uses weak radio waves. In the following situations, the communication between the electronic key and the vehicle may be affected, preventing the smart entry & start system, wireless remote control and engine immobilizer system from operating properly. (Ways of coping: →P. 523)

- When the electronic key battery is depleted
- Near a TV tower, electric power plant, gas station, radio station, large display, airport or other facility that generates strong radio waves or electrical noise
- When carrying a portable radio, cellular phone, cordless phone or other wireless communication device
- When the electronic key is in contact with, or is covered by the following metallic objects
 - Cards to which aluminum foil is attached
 - Cigarette boxes that have aluminum foil inside
 - Metallic wallets or bags
 - Coins
 - Hand warmers made of metal
 - Media such as CDs and DVDs
- When other wireless keys (that emit radio waves) are being used nearby
- When carrying the electronic key together with the following devices that emit radio waves
 - Another vehicle's electronic key or a wireless key that emits radio waves
 - Personal computers or personal digital assistants (PDAs)
 - Digital audio players
 - Portable game systems
- If window tint with a metallic content or metallic objects are attached to the rear window

FarmaSOS.com

- Note for the entry function (if equipped)
 - Even when the electronic key is within the effective range (detection areas), the system may not operate properly in the following cases:
 - The electronic key is too close to the window or outside door handle, near the ground, or in a high place when the doors are locked or unlocked.
 - The electronic key is near the ground or in a high place, or too close to the rear bumper center when the trunk is opened.
 - Do not leave the electronic key on top of the instrument panel or near the door pockets when exiting the vehicle. Depending on the radio wave reception conditions, it may be detected by the antenna outside the cabin and the doors will become lockable from the outside, possibly trapping the electronic key inside the vehicle.
 - As long as the electronic key is within the effective range, the doors may be locked or unlocked by anyone. However, only the doors detecting the electronic key can be used to unlock the vehicle.
 - The doors may unlock or lock if a large amount of water splashes on the door handle, such as in the rain or in a car wash, when the electronic key is within the effective range. (The doors will automatically be locked after approximately 30 seconds if the doors are not opened and closed.)
 - If the wireless remote control is used to lock the doors when the electronic key is near the vehicle, there is a possibility that the door may not be unlocked by the entry function. (Use the wireless remote control to unlock the doors.)
 - Touching the door lock or unlock sensor while wearing gloves may prevent lock or unlock operation.
 - If the door handle becomes wet while the electronic key is within the effective range, the door may lock and unlock repeatedly. In this case, follow the following correction procedures to wash the vehicle: *تلفن شبانه روزی*
 - Place the electronic key in a location 2 m (6 ft.) or more away from the vehicle. (Take care to ensure that the key is not stolen.)
 - Set the electronic key to battery-saving mode to disable the smart entry & start system. (→P. 131)
 - If the electronic key is inside the vehicle and a door handle becomes wet during a car wash, a message may be shown on the multi-information display and a buzzer will sound outside the vehicle. To turn off the alarm, lock all the doors.
 - The lock sensor may not work properly if it comes into contact with ice, snow, mud, etc. Clean the lock sensor and attempt to operate it again, or use the lock sensor on the lower part of the door handle.
 - A sudden handle operation or a handle operation immediately after entering the effective range may prevent the doors from being unlocked. Touch the door unlock sensor and check that the doors are unlocked before pulling the door handle again.
 - Unlocking the vehicle may take more time if another electronic key is within the effective range.

- Note for the push-start function
 - Even when the electronic key is within the effective range (detection areas), the system may not operate properly when the electronic key is on the instrument panel, rear package tray or floor, or in the door pockets or glove box when the engine is started or engine switch modes are changed.
 - Even if the electronic key is not inside the vehicle, it may be possible to start the engine if the electronic key is near the window.
- When the vehicle is not driven for extended periods
 - Vehicles with entry function: To prevent theft of the vehicle, do not leave the electronic key within 2 m (6 ft.) of the vehicle.
 - The smart entry & start system can be deactivated in advance. (→P. 549)
- To operate the system properly
 - Make sure to carry the electronic key when operating the system. Do not get the electronic key too close to the vehicle when operating the system from the outside of the vehicle.
Depending on the position and holding condition of the electronic key, the key may not be detected correctly and the system may not operate properly. (The alarm may go off accidentally, or the door lock prevention function may not operate.)
 - Do not leave the electronic key inside the luggage compartment.
The key confinement prevention function may not operate, depending on the location of the key (close to a spare tire [if equipped], the inside edge of the luggage compartment), conditions (inside a metal bag, close to metallic objects) and the radio waves in the surrounding area. (→P. 127)
- If the smart entry & start system does not operate properly
 - Locking and unlocking the doors and opening the trunk: Use the mechanical key. (→P. 523)
 - Starting the engine: →P. 524
- Customization
 - Settings (e. g. smart entry & start system) can be changed. (Customizable features: →P. 549)
- If the smart entry & start system has been deactivated in a customized setting
 - Locking and unlocking the doors and opening the trunk: Use the wireless remote control or mechanical key. (→P. 118, 126, 523)
 - Starting the engine and changing engine switch modes: →P. 524
 - Stopping the engine: →P. 190

■ Certification for the smart entry & start system

Hereby, Tokai Rika Co., Ltd., declares that this BG1EW is in compliance with the essential requirements and other relevant provisions of Directive 1999/5/EC.
Tokai Rika Co., Ltd. vakuuttaa täten että BG1EW tyyppinen laite on direktiivin 1999/5/EY oleellisten vaatimusten ja sitä koskevien direktiivin muiden ehtojen mukainen.
Hierbij verklaart Tokai Rika Co., Ltd. dat het toestel BG1EW in overeenstemming is met de essentiële eisen en de andere relevante bepalingen van richtlijn 1999/5/EG.
Par la présente Tokai Rika Co., Ltd. déclare que l'appareil BG1EW est conforme aux exigences essentielles et aux autres dispositions pertinentes de la directive 1999/5/CE.
Härmed intygar Tokai Rika Co., Ltd. att denna BG1EW står i överensstämmelse med de väsentliga egenskapskrav och övriga relevanta bestämmelser som framgår av direktiv 1999/5/EG.
Undertegnede Tokai Rika Co., Ltd. erklærer herved, at følgende udstyr BG1EW overholder de væsentlige krav og øvrige relevante krav i direktiv 1999/5/EF.
Hiermit erkläre Tokai Rika Co., Ltd., dass sich das Gerät BG1EW in Übereinstimmung mit den grundlegenden Anforderungen und den übrigen einschlägigen Bestimmungen der Richtlinie 1999/5/EG befindet.
ΜΕ ΤΗΝ ΠΑΡΟΥΣΑ Tokai Rika Co., Ltd. ΔΗΛΩΝΕΙ ΟΤΙ BG1EW ΣΥΜΜΟΡΦΩΝΕΤΑΙ ΠΡΟΣ ΤΙΣ ΟΥΣΙΩΔΕΙΣ ΑΠΑΙΤΗΣΕΙΣ ΚΑΙ ΤΙΣ ΛΟΙΠΕΣ ΣΧΕΤΙΚΕΣ ΔΙΑΤΑΞΕΙΣ ΤΗΣ ΟΔΗΓΙΑΣ 1999/5/ΕΚ.
Con la presente Tokai Rika Co., Ltd. dichiara che questo BG1EW è conforme ai requisiti essenziali ed alle altre disposizioni pertinenti stabilite dalla direttiva 1999/5/CE.
Por medio de la presente Tokai Rika Co., Ltd. declara que el BG1EW cumple con los requisitos esenciales y cualesquiera otras disposiciones aplicables o exigibles de la Directiva 1999/5/CE.
Tokai Rika Co., Ltd. declara que este BG1EW está conforme com os requisitos essenciais e outras disposições da Directiva 1999/5/CE.
Hawnhekk, Tokai Rika Co., Ltd., jiddikjara li dan BG1EW jikkonforma mal-htigijiet essenzjali u ma provvedimenti oħrajn relevanti li hemm fid-Direttiva 1999/5/EC.
Käesolevaga kinnitab Tokai Rika Co., Ltd. seadme BG1EW vastavust direktiivi 1999/5/EÜ põhinõuetele ja nimetatud direktiivist tulenevatele teistele asjakohastele sätetele.
Alulirott, Tokai Rika Co., Ltd. nyilatkozom, hogy a BG1EW megfelel a vonatkozó alapvető követelményeknek és az 1999/5/EC irányelv egyéb előírásainak.

Tokai Rika Co., Ltd. týmto vyhlasuje, že BG1EW spĺňa základné požiadavky a všetky príslušné ustanovenia Smernice 1999/5/ES.
Tokai Rika Co., Ltd. tímto prohlašuje, že tento BG1EW je ve shodě se základními požadavky a dalšími příslušnými ustanoveními směrnice 1999/5/ES.
Tokai Rika Co., Ltd. izjavlja, da je ta BG1EW v skladu z bistvenimi zahtevami in ostalimi relevantnimi določili direktive 1999/5/ES.
Šiuo Tokai Rika Co., Ltd. deklaruoja, kad šis BG1EW atitinka esminius reikalavimus ir kitas 1999/5/EB Direktyvos nuostatas.
Ar šo Tokai Rika Co., Ltd. deklarē, ka BG1EW atbilst Direktīvas 1999/5/EK būtiskajām prasībām un citiem ar to saistītajiem noteikumiem.
Niniejszym Tokai Rika Co., Ltd. oświadcza, że BG1EW jest zgodny z zasadniczymi wymogami oraz pozostałymi stosownymi postanowieniami Dyrektywy 1999/5/EC.
Hér með lýsir Tokai Rika Co., Ltd. yfir því að BG1EW er í samræmi við grunnkröfur og aðrar kröfur, sem gerðar eru í tilskipun 1999/5/EC.
Tokai Rika Co., Ltd. erklærer herved at utstyret BG1EW er i samsvar med de grunnleggende krav og øvrige relevante krav i direktiv 1999/5/EF.
С настоящето, Tokai Rika Co., Ltd., декларира, че BG1EW е в съответствие със съществените изисквания и другите приложими разпоредби на Директива 1999/5/EC.
Prin prezenta, Tokai Rika Co., Ltd., declară că aparatul BG1EW este în conformitate cu cerințele esențiale și cu alte prevederi pertinente ale Directivei 1999/5/CE.
Ovim, Tokai Rika Co., Ltd., izjavjuje da ovaj BG1EW je usklađen sa bitnim zahtjevima i drugim relevantnim odredbama Direktive 1999/5/EC.
Nepermjet kesaj, Tokai Rika Co., Ltd., deklaroj qe ky BG1EW eshte ne pajtim me kerkesat thelbesore dhe dispozitat e tjera perkatese te Direktives 1999/5/EC.
Ovim Tokai Rika Co., Ltd., izjavjuje da je BG1EW u skladu s bitnim zahtjevima i drugim relevantnim odredbama Direktive 1999/5/EC i Pravilnika o RiTT opremi (NN 25/2012).
Ovim, Tokai Rika Co., Ltd., deklarise da je BG1EW u skladu sa osnovnim zahtevima i ostalim relevantnim odredbama Direktive 1999/5/EC.

The DECLARATION of CONFORMITY (DoC) is available at the following address:

<http://www.tokai-rika.co.jp/pc/>



Hereby, Tokai Rika Co., Ltd., declares that this B90UM is in compliance with the essential requirements and other relevant provisions of Directive 1999/5/EC.
Tokai Rika Co., Ltd. vakuuttaa täten että B90UM tyyppinen laite on direktiivin 1999/5/EY oleellisten vaatimusten ja sitä koskevien direktiivin muiden ehtojen mukainen.
Hierbij verklaart Tokai Rika Co., Ltd. dat het toestel B90UM in overeenstemming is met de essentiële eisen en de andere relevante bepalingen van richtlijn 1999/5/EG.
Par la présente Tokai Rika Co., Ltd. déclare que l'appareil B90UM est conforme aux exigences essentielles et aux autres dispositions pertinentes de la directive 1999/5/CE.
Härmed intygar Tokai Rika Co., Ltd. att denna B90UM står i överensstämmelse med de väsentliga egenskapskrav och övriga relevanta bestämmelser som framgår av direktiv 1999/5/EG.
Undertegnede Tokai Rika Co., Ltd. erklærer herved, at følgende udstyr B90UM overholder de væsentlige krav og øvrige relevante krav i direktiv 1999/5/EF.
Hiermit erkläre Tokai Rika Co., Ltd., dass sich das Gerät B90UM in Übereinstimmung mit den grundlegenden Anforderungen und den übrigen einschlägigen Bestimmungen der Richtlinie 1999/5/EG befindet.
ΜΕ ΤΗΝ ΠΑΡΟΥΣΑ Tokai Rika Co., Ltd. ΔΗΛΩΝΕΙ ΟΤΙ Β90UM ΣΥΜΜΟΡΦΩΝΕΤΑΙ ΠΡΟΣ ΤΙΣ ΟΥΣΙΩΔΕΙΣ ΑΠΑΙΤΗΣΕΙΣ ΚΑΙ ΤΙΣ ΛΟΙΠΕΣ ΣΧΕΤΙΚΕΣ ΔΙΑΤΑΞΕΙΣ ΤΗΣ ΟΔΗΓΙΑΣ 1999/5/ΕΚ.
Con la presente Tokai Rika Co., Ltd. dichiara che questo B90UM è conforme ai requisiti essenziali ed alle altre disposizioni pertinenti stabilite dalla direttiva 1999/5/CE.
Por medio de la presente Tokai Rika Co., Ltd. declara que el B90UM cumple con los requisitos esenciales y cualesquiera otras disposiciones aplicables o exigibles de la Directiva 1999/5/CE.
Tokai Rika Co., Ltd. declara que este B90UM está conforme com os requisitos essenciais e outras disposições da Directiva 1999/5/CE.
Hawnhekk, Tokai Rika Co., Ltd., jiddikjara li dan B90UM jikkonforma mal-htigijiet essenzjali u ma provvedimenti oħrajn rilevanti li hemm fid-Dirrettiva 1999/5/EC.
Käesolevaga kinnitab Tokai Rika Co., Ltd. seadme B90UM vastavust direktiivi 1999/5/EÜ põhinõuetele ja nimetatud direktiivist tulenevatele teistele asjakohastele sätetele.
Alulirott, Tokai Rika Co., Ltd. nyilatkozom, hogy a B90UM megfelel a vonatkozó alapvető követelményeknek és az 1999/5/EC irányelv egyéb előírásainak.

Tokai Rika Co., Ltd. týmto vyhlasuje, že B90UM spĺňa základné požiadavky a všetky príslušné ustanovenia Smernice 1999/5/ES.
Tokai Rika Co., Ltd. tímto prohlašuje, že tento B90UM je ve shodě se základními požadavky a dalšími příslušnými ustanoveními směrnice 1999/5/ES.
Tokai Rika Co., Ltd. izjavlja, da je ta B90UM v skladu z bistvenimi zahtevami in ostalimi relevantnimi določili direktive 1999/5/ES.
Šiuo Tokai Rika Co., Ltd. deklaruoja, kad šis B90UM atitinka esminius reikalavimus ir kitas 1999/5/EB Direktyvos nuostatas.
Ar šo Tokai Rika Co., Ltd. deklarē, ka B90UM atbilst Direktīvas 1999/5/EK būtiskajām prasībām un citiem ar to saistītajiem noteikumiem.
Niniejszym Tokai Rika Co., Ltd. oświadcza, że B90UM jest zgodny z zasadniczymi wymogami oraz pozostałymi stosownymi postanowieniami Dyrektywy 1999/5/EC.
Hér með lýsir Tokai Rika Co., Ltd. yfir því að B90UM er í samræmi við grunnkröfur og aðrar kröfur, sem gerðar eru í tilskipun 1999/5/EC.
Tokai Rika Co., Ltd. erklærer herved at utstyret B90UM er i samsvar med de grunnleggende krav og øvrige relevante krav i direktiv 1999/5/EF.
С настоящето, Tokai Rika Co., Ltd., декларира, че B90UM е в съответствие със съществените изисквания и другите приложими разпоредби на Директива 1999/5/EC.
Prin prezenta, Tokai Rika Co., Ltd., declară că aparatul B90UM este in conformitate cu cerințele esențiale și cu alte prevederi pertinente ale Directivei 1999/5/CE.
Ovim, Tokai Rika Co., Ltd., izjavljuje da ovaj B90UM je usklađen sa bitnim zahtjevima i drugim relevantnim odredbama Direktive 1999/5/EC.
Nepermjet kesaj, Tokai Rika Co., Ltd., deklaroj qe ky B90UM eshte ne pajtim me kerkesat thelbesore dhe dispozitat e tjera perkatese te Direktives 1999/5/EC.
Ovim Tokai Rika Co., Ltd., izjavljuje da je B90UM u skladu s bitnim zahtjevima i drugim relevantnim odredbama Direktive 1999/5/EC i Pravilnika o RiTT opremi (NN 25/2012).
Ovim, Tokai Rika Co., Ltd., deklarirše da je B90UM u skladu sa osnovnim zahtevima i ostalim relevantnim odredbama Direktive 1999/5/EC.

The DECLARATION of CONFORMITY (DoC) is available at the following address:

<http://www.tokai-rika.co.jp/pc/>



TOYOTA**TOYOTA MOTOR CORPORATION**

1, TOYOTA-CHO, TOYOTA, AICHI, 471-8571 (Head Office)
or 471-8572 (Research & Development Group) JAPAN
TEL.: +81-565-26-2121

R&TTE Declaration of Conformity

We,

Manufacturer's Name: TOYOTA MOTOR CORPORATION
Manufacturer's Address: 1, Toyota -cho, Toyota, Aichi, 471-8572, Japan

hereby declare under our sole responsibility that the product:

Product Name: LF Oscillator
Product Model: TMLF12-1

to which this declaration relates is in conformity with the essential requirements and other relevant requirements of the R&TTE Directive (1999/5/EC). The product is compliant with the following standards and/or other normative documents:

-Health & safety requirements: EN 60950-1
-EMC requirements: EN 301 489-01 & EN 301 489-03
-Effective uses of radio spectrum: EN 300 330-2

Supplementary information:

* CE mark	
* Member states intended for use	EU and EFTA

Date: May 22, 2012

Signature: 
Tetsuya Matsuo

3

Operation of each component

Hereby, Toyota Motor Corporation, declares that this TMLF12-1 is in compliance with the essential requirements and other relevant provisions of Directive 1999/5/EC.
Toyota Motor Corporation vakuuttaa täten että TMLF12-1 tyyppinen laite on direktiivin 1999/5/EY oleellisten vaatimusten ja sitä koskevien direktiivin muiden ehtojen mukainen.
Hierbij verklaart Toyota Motor Corporation dat het toestel TMLF12-1 in overeenstemming is met de essentiële eisen en de andere relevante bepalingen van richtlijn 1999/5/EG.
Par la présente Toyota Motor Corporation déclare que l'appareil TMLF12-1 est conforme aux exigences essentielles et aux autres dispositions pertinentes de la directive 1999/5/CE.
Härmed intygar Toyota Motor Corporation att denna TMLF12-1 står i överensstämmelse med de väsentliga egenskapskrav och övriga relevanta bestämmelser som framgår av direktiv 1999/5/EG.
Undertegnede Toyota Motor Corporation erklærer herved, at følgende udstyr TMLF12-1 overholder de væsentlige krav og øvrige relevante krav i direktiv 1999/5/EF.
Hiermit erklart Toyota Motor Corporation, dass sich das Gerät TMLF12-1 in Übereinstimmung mit den grundlegenden Anforderungen und den übrigen einschlägigen Bestimmungen der Richtlinie 1999/5/EG befindet.
ΜΕ ΤΗΝ ΠΑΡΟΥΣΑ Toyota Motor Corporation ΔΗΛΩΝΕΙ ΟΤΙ ΤΜΛF12-1 ΣΥΜΜΟΡΦΟΝΕΤΑΙ ΠΡΟΣ ΤΙΣ ΟΥΣΙΩΔΕΙΣ ΑΠΑΙΤΗΣΕΙΣ ΚΑΙ ΤΙΣ ΛΟΙΠΕΣ ΣΧΕΤΙΚΕΣ ΔΙΑΤΑΞΕΙΣ ΤΗΣ ΟΔΗΓΙΑΣ 1999/5/ΕΚ. تلفن شبانه روزی
Con la presente Toyota Motor Corporation dichiara che questo TMLF12-1 è conforme ai requisiti essenziali ed alle altre disposizioni pertinenti stabilite dalla direttiva 1999/5/CE.
Por medio de la presente Toyota Motor Corporation declara que el TMLF12-1 cumple con los requisitos esenciales y cualesquiera otras disposiciones aplicables o exigibles de la Directiva 1999/5/CE.
Toyota Motor Corporation declara que este TMLF12-1 está conforme com os requisitos essenciais e outras disposições da Directiva 1999/5/CE.
Hawnhekk, Toyota Motor Corporation, jiddikjara li dan TMLF12-1 jikkonforma mal-htigijiet essenzjali u ma provvedimenti oħrajn relevanti li hemm fid-Dirrettiva 1999/5/EC.
Käesolevaga kinnitab Toyota Motor Corporation seadme TMLF12-1 vastavust direktiivi 1999/5/EÜ põhinõuetele ja nimetatud direktiivist tulenevatele teistele asjakohastele sätetele.

Alulírott, Toyota Motor Corporation nyilatkozom, hogy a TMLF12-1 megfelel a vonatkozó alapvető követelményeknek és az 1999/5/EC irányelv egyéb előírásainak.
Toyota Motor Corporation tímto vyhlasuje, že TMLF12-1 splňa základné požiadavky a všetky príslušné ustanovenia Smernice 1999/5/ES.
Toyota Motor Corporation tímto prohlašuje, že tento TMLF12-1 je ve shodě se základními požadavky a dalšími příslušnými ustanoveními směrnice 1999/5/ES.
Toyota Motor Corporation izjavlja, da je ta TMLF12-1 v skladu z bistvenimi zahtevami in ostalimi relevantnimi določili direktive 1999/5/ES.
Šiuo Toyota Motor Corporation deklaruoja, kad šis TMLF12-1 atitinka esminius reikalavimus ir kitas 1999/5/EB Direktyvos nuostatas.
Ar šo Toyota Motor Corporation deklarē, ka TMLF12-1 atbilst Direktīvas 1999/5/EK būtiskajām prasībām un citiem ar to saistītajiem noteikumiem.
Niniejszym Toyota Motor Corporation oświadcza, że TMLF12-1 jest zgodny z zasadniczymi wymogami oraz pozostałymi stosownymi postanowieniami Dyrektywy 1999/5/EC.
Hér með lýsir Toyota Motor Corporation yfir því að TMLF12-1 er í samræmi við grunnkröfur og aðrar kröfur, sem gerðar eru í tilskipun 1999/5/EC.
Toyota Motor Corporation erklærer herved at utstyret TMLF12-1 er i samsvar med de grunnleggende krav og øvrige relevante krav i direktiv 1999/5/EF.
С настоящето, Toyota Motor Corporation, декларира, че TMLF12-1 е в съответствие със съществените изисквания и другите приложими разпоредби на Директива 1999/5/EC.
Prin prezenta, Toyota Motor Corporation, declară că aparatul TMLF12-1 este în conformitate cu cerințele esențiale și cu alte prevederi pertinente ale Directivei 1999/5/CE.
Ovim, Toyota Motor Corporation, izjavljuje da ovaj TMLF12-1 je usklađen sa bitnim zahtjevima i drugim relevantnim odredbama Direktive 1999/5/EC.
Nepermjet kesaj, Toyota Motor Corporation, deklaruj qe ky TMLF12-1 eshte ne pajtim me kerkesat thelbesore dhe dispozitat e tjera perkatese te Direktives 1999/5/EC.
Ovim Toyota Motor Corporation, izjavljuje da je TMLF12-1 u skladu s bitnim zahtjevima i drugim relevantnim odredbama Direktive 1999/5/EC i Pravilnika o RiTT opremi (NN 25/2012).
Ovim, Toyota Motor Corporation, deklarirše da je TMLF12-1 u skladu sa osnovnim zahtevima i ostalim relevantnim odredbama Direktive 1999/5/EC.



The latest "DECLARATION of CONFORMITY" (DoC) is available at the following address:
<http://is-serv.isd.denso.co.jp:81/en/products/oem/index.html>

Hereby, DENSO CORPORATION declares that this 14CCB is in compliance with the essential requirements and other relevant provisions of Directive 1999/5/EC.

DENSO CORPORATION vakuuttaa täten että 14CCB tyyppinen laite on direktiivin 1999/5/EY oleellisten vaatimusten ja sitä koskevien direktiivin muiden ehtojen mukainen.

Hierbij verklaart DENSO CORPORATION dat het toestel 14CCB in overeenstemming is met de essentiële eisen en de andere relevante bepalingen van richtlijn 1999/5/EG.

Par la présente DENSO CORPORATION déclare que l'appareil 14CCB est conforme aux exigences essentielles et aux autres dispositions pertinentes de la directive 1999/5/CE.

Härmed intygar DENSO CORPORATION att denna 14CCB står i överensstämmelse med de väsentliga egenskapskrav och övriga relevanta bestämmelser som framgår av direktiv 1999/5/EG.

Undertegnede DENSO CORPORATION erklærer herved, at følgende udstyr 14CCB overholder de væsentlige krav og øvrige relevante krav i direktiv 1999/5/EF.

Hiermit erklärt DENSO CORPORATION, dass sich das Gerät 14CCB in Übereinstimmung mit den grundlegenden Anforderungen und den übrigen einschlägigen Bestimmungen der Richtlinie 1999/5/EG befindet.

ME THN ΠΑΡΟΥΣΑ DENSO CORPORATION ΔΗΛΩΝΕΙ ΟΤΙ 14CCB ΣΥΜΜΟΡΦΩΝΕΤΑΙ ΠΡΟΣ ΤΙΣ ΟΥΣΙΩΔΕΙΣ ΑΠΑΙΤΗΣΕΙΣ ΚΑΙ ΤΙΣ ΛΟΙΠΕΣ ΣΧΕΤΙΚΕΣ ΔΙΑΤΑΞΕΙΣ ΤΗΣ ΟΔΗΓΙΑΣ 1999/5/ΕΚ.

Con la presente DENSO CORPORATION dichiara che questo 14CCB è conforme ai requisiti essenziali ed alle altre disposizioni pertinenti stabilite dalla direttiva 1999/5/CE.

Por medio de la presente DENSO CORPORATION declara que el 14CCB cumple con los requisitos esenciales y cualesquiera otras disposiciones aplicables o exigibles de la Directiva 1999/5/CE.

DENSO CORPORATION declara que este 14CCB está conforme com os requisitos essenciais e outras disposições da Directiva 1999/5/CE.

Hawnhekk, DENSO CORPORATION, jiddikjara li dan 14CCB jikkonforma mal-htigijiet essenzjali u ma provvedimenti oħrajn relevanti li hemm fid-Dirrettiva 1999/5/EC.

Käesolevaga kinnitab DENSO CORPORATION seadme 14CCB vastavust direktiivi 1999/5/EÜ põhinõuetele ja nimetatud direktiivist tulenevatele teistele asjakohastele sätetele.

Alulírott, DENSO CORPORATION nyilatkozom, hogy a 14CCB megfelel a vonatkozó alapvető követelményeknek és az 1999/5/EC irányelv egyéb előírásainak.

DENSO CORPORATION tímto vyhlasuje, že 14CCB spĺňa základné požiadavky a všetky príslušné ustanovenia Smernice 1999/5/ES.

DENSO CORPORATION tímto prohlašuje, že tento 14CCB je ve shodě se základními požadavky a dalšími příslušnými ustanoveními směrnice 1999/5/ES.

DENSO CORPORATION izjavlja, da je ta 14CCB v skladu z bistvenimi zahtevami in ostalimi relevantnimi določili direktive 1999/5/ES.

Šiuo DENSO CORPORATION deklaruoja, kad šis 14CCB atitinka esminius reikalavimus ir kitas 1999/5/EB Direktyvos nuostatas.

Ar šo DENSO CORPORATION deklarē, ka 14CCB atbilst Direktīvas 1999/5/EK būtiskajām prasībām un citiem ar to saistītajiem noteikumiem.

Niniejszym DENSO CORPORATION oświadcza, że 14CCB jest zgodny z zasadniczymi wymogami oraz pozostałymi stosownymi postanowieniami Dyrektywy 1999/5/EC.

Hér með lýsir DENSO CORPORATION yfir því að 14CCB er í samræmi við grunnkröfur og aðrar kröfur, sem gerðar eru í tilskipun 1999/5/EC.

DENSO CORPORATION erklærer herved at udstyret 14CCB er i samsvar med de grundlæggende krav og øvrige relevante krav i direktiv 1999/5/EF.

С настоящето, DENSO CORPORATION, декларира, че 14CCB е в съответствие със съществените изисквания и другите приложими разпоредби на Директива 1999/5/EC.

Prin prezenta, DENSO CORPORATION, declară că aparatul 14CCB este în conformitate cu cerințele esențiale și cu alte prevederi pertinente ale Directivei 1999/5/CE.

Ovim, DENSO CORPORATION, izjavljuje da ovaj 14CCB je usklađen sa bitnim zahtjevima i drugim relevantnim odredbama Direktive 1999/5/EC.

Ovim, DENSO CORPORATION, deklarirše da je 14CCB u skladu sa osnovnim zahtjevima i ostalim relevantnim odredbama Direktive 1999/5/EC.

Ovim DENSO CORPORATION, izjavljuje da je 14CCB u sklau s bitnim zahtjevima i drugim relevantnim odredbama Direktive 1999/5/EC i Pravilnika o RiTT opremi (NN 25/2012).

 CAUTION

■ Caution regarding interference with electronic devices

- People with implanted pacemakers or cardiac defibrillators should maintain a reasonable distance between themselves and the smart entry & start system antennas.

(→P. 130)

The radio waves may affect the operation of such devices. If necessary, the entry function can be disabled. Ask any authorized Lexus dealer or repairer, or another duly qualified and equipped professional for details, such as the frequency of radio waves and timing of emitting the radio waves. Then, consult your doctor to see if you should disable the entry function.

- Users of any electrical medical device other than implanted pacemakers and implanted cardiac defibrillators should consult the manufacturer of the device for information about its operation under the influence of radio waves.

Radio waves could have unexpected effects on the operation of such medical devices.

Ask any authorized Lexus dealer or repairer, or another duly qualified and equipped professional for details on disabling the entry function.

تلفن شبانه روزی: ۰۲۱-۸۸۸۶۲۰۸۵

FarmaSOS.com

Front seats

Adjustment procedure

► Power seat

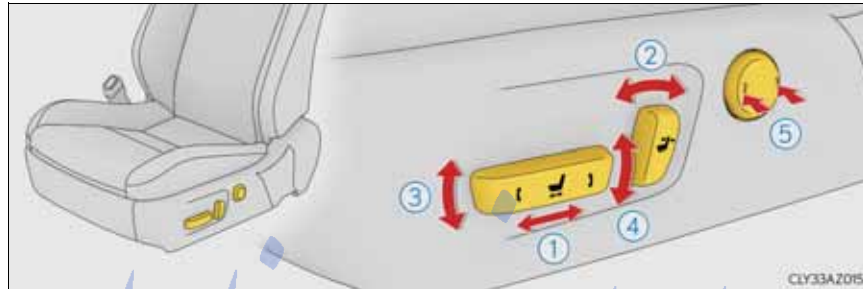

► Manual seat



- | | |
|---|---|
| ① Seat position adjustment | ④ Seat cushion (rear) angle adjustment |
| ② Seatback angle adjustment | ⑤ Lumbar support adjustment (if equipped) |
| ③ Seat cushion (front) angle adjustment | ⑥ Vertical height adjustment |

3

Operation of each component

- Power easy access system (if equipped)
The driver's seat and steering wheel move in accordance with engine switch mode and the driver's seat belt condition. (→P. 151)
- When adjusting the seat
If the head restraint touches the ceiling or rear seats while the seat is being adjusted, lower the head restraint until it no longer touches the ceiling or rear seats.

⚠ CAUTION

- When adjusting the seat position
 - Take care when adjusting the seat position to ensure that other passengers are not injured by the moving seat.
 - Do not put your hands under the seat or near the moving parts to avoid injury. Fingers or hands may become jammed in the seat mechanism.
 - Make sure to leave enough space around the feet so they do not get stuck.
- Seat adjustment
To reduce the risk of sliding under the lap belt during a collision, do not recline the seat more than necessary.
If the seat is too reclined, the lap belt may slide past the hips and apply restraint forces directly to the abdomen, or your neck may contact the shoulder belt, increasing the risk of death or serious injury in the event of an accident.
Adjustments should not be made while driving as the seat may unexpectedly move and cause the driver to lose control of the vehicle.

FarmaSOS.com

Rear seats (folding type)*

The rear seatbacks can be folded down.

Folding down the rear seatbacks

- 1 Check that the luggage security system lever in the trunk is in the unlock position.
- 2 Pull the seatback lock release lever and fold the seatback down.
To return the rear seatbacks to their original position, lift them up until they lock.

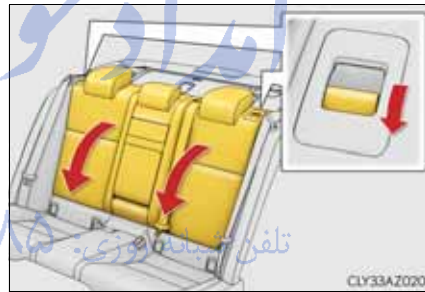
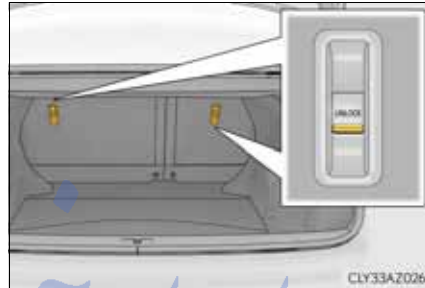

3

Operation of each component

FarmaSOS.com

*: If equipped

Luggage security system

→P. 126

⚠ CAUTION

Observe the following precautions. Failure to do so may result in death or serious injury.

- When folding the rear seatbacks down
 - Do not fold the seatbacks down while driving.
 - Stop the vehicle on level ground, set the parking brake and shift the shift lever to P.
 - Do not allow anyone to sit on a folded seatback or in the trunk while driving.
 - Do not allow children to enter the trunk.
- After returning the rear seatback to the upright position
 - Make sure that the seatback is securely locked in position by lightly pushing it back and forth.
If the seatback is not securely locked, the red marking will be visible on the seatback lock release knob. Make sure that the red marking is not visible.



- Check that the seat belts are not twisted or caught in the seatback.

FarmaSOS.com

Driving position memory*

Your preferred driving position (the position of the driver's seat, steering wheel and outside rear view mirrors) can be memorized and recalled by pressing a button. It is also possible to set this function to activate automatically when the doors are unlocked.

Three different driving positions can be entered into memory.

Entering a position to memory

- 1 Check that the shift lever is in P.
- 2 Turn the engine switch to IGNITION ON mode.
- 3 Adjust the driver's seat, steering wheel, and outside rear view mirrors to the desired positions.
- 4 While pressing the "SET" button, or within 3 seconds after the "SET" button is pressed, press button "1", "2" or "3" until a buzzer sounds.

If the selected button has already been preset, the previously recorded position will be overwritten.

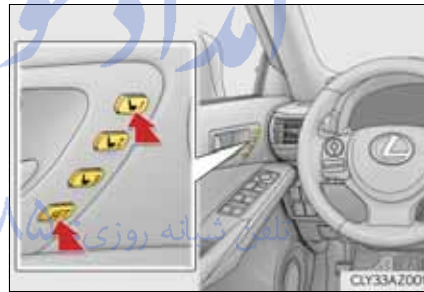

3

Operation of each component

FarmaSOS.com

*: If equipped

Recalling the memorized position

- 1 Check that the shift lever is in P.
- 2 Turn the engine switch to IGNITION ON mode.
- 3 Press button “1”, “2” or “3” to recall the desired position.

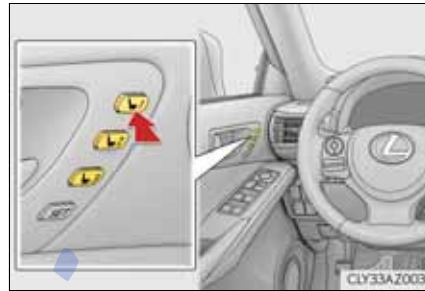

- When you want to stop the position recall operation part-way through Perform any of the following operations:
 - Press the “SET” button.
 - Press button “1”, “2” or “3”.
 - Adjust the seat using the switches (only cancels seat position recall).
- The adjusted positions that can be memorized
The adjusted positions other than the position adjusted by lumbar support switch can be memorized.

تلفن شبانه روزی: ۰۲۱-۸۸۶۲۰۸۵

FarmaSOS.com

Power easy access system

The auto away/return function enables easy access by activating when the driver attempts to enter or exit the vehicle.



■ Auto away function when exiting the vehicle

When all of the following actions have been performed, the steering wheel will move up and back to the point farthest away from the driver and the seat will move backward:

- The shift lever has been shifted to P.
- The engine switch has been turned off.
- The driver's seat belt has been unfastened.

■ Auto return function when entering the vehicle

When either of the following actions has been performed, the steering wheel will move toward the driver and seat will move forward:

- The engine switch has been turned to ACCESSORY mode.
- The driver's seat belt has been fastened.

Linking driving position memory with door unlock operation

A desired driving position can be recalled linked with the unlocking of the door.

■ Setting procedure

Record your driving position to button “1”, “2” or “3” before performing the following:

Carrying only the key (including the card key) to which you want to link the driving position, shift the shift lever to P and then close the driver’s door.

If 2 or more keys are in the vehicle, the driving position cannot be linked properly.

- 1 Turn the engine switch to IGNITION ON mode and recall the position which you want to link.
- 2 While pressing the button to recall the position, press the driver’s door lock switch (either lock or unlock) until the buzzer sounds.

The driving position is recalled when the driver’s door is unlocked using the entry function or wireless remote control and the driver’s door is opened.

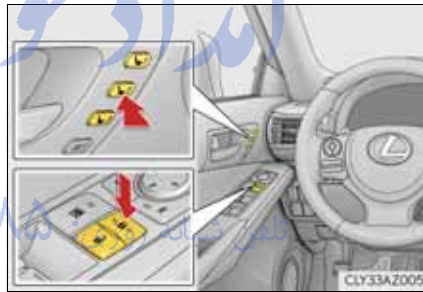

■ Cancellation procedure

Carry only the key to which you want to cancel the linked door unlock operation.

If 2 or more keys are in the vehicle, the driving position cannot be canceled properly.

- 1 Turn the engine switch to IGNITION ON mode.
- 2 While pressing the “SET” button, press the driver’s door lock switch (either lock or unlock) until the buzzer sounds.

- When driving position memory is linked with door unlock operation
If the driver's door is opened, the driver's seat will move toward the memorized position but stop slightly beforehand to allow easy access to the vehicle. Turning the engine switch to ACCESSORY or IGNITION ON mode, or fastening the driver's seat belt moves the seat fully into the memorized position.
- Operating the driving position memory after turning the engine switch off
Memorized seat positions can be activated up to 180 seconds after the driver's door is opened and another 60 seconds after it is closed again. Memorized steering wheel position can be activated by pressing the engine switch.
- Correct seat position
When the seat is in the most forward or most backward position, and the seat is being moved in those directions, the system may not correctly recognize the current position and the memorized position will not be correctly recalled.
- The auto away function for exiting
If the seat is already close to the rearmost position, the auto away function may not operate when the driver exits the vehicle.
- When the driving position is recalled by a memory linked door unlock operation
 - Since each memorized driving position is registered to a specific electronic key, the driving position recalled may be different depending on the carried key.
 - When only doors other than the driver's door are unlocked by the smart entry & start system, the driving position will not be recalled. In this case, press a driving position memory button to recall the desired driving position.
- Customization
The distance that the driver's seat moves backward during the auto away function can be changed. (Customizable features: →P. 549) تلفن تسيبانه

 CAUTION

- Seat adjustment caution
Take care during seat adjustment so that the seat does not strike the rear passenger or squeeze your body against the steering wheel.

Head restraints

Head restraints are provided for all seats.

Front seats

- ① Up
Pull the head restraints up.
- ② Down
Push the head restraint down while pressing the lock release button.

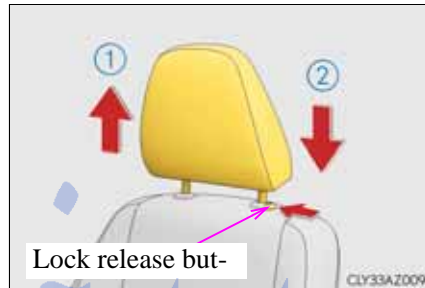

Rear seats

- ① Up
Pull the head restraints up.
- ② Down
Push the head restraint down while pressing the lock release button.

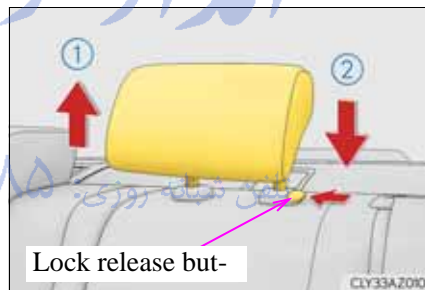

FarmaSOS.com

- Removing the head restraints

Pull the head restraint up while pressing the lock release button.

If the head restraint touches the ceiling, making the removal difficult, change the seat height or angle.



- Installing the head restraints

- ▶ Front seats

Align the head restraint with the installation holes and push it down to the lock position. Press and hold the lock release button when lowering the head restraint.



- ▶ Rear seats

Align the head restraint with the installation holes and push it down to the lowest lock position while pressing the lock release button.



■ Adjusting the height of the head restraints

Make sure that the head restraints are adjusted so that the center of the head restraint is closest to the top of your ears.

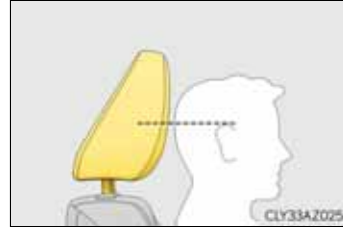

■ Adjusting the rear seat head restraint

Always raise the head restraint one level from the stowed position when using.

⚠ CAUTION

■ Head restraint precautions

Observe the following precautions regarding the head restraints. Failure to do so may result in death or serious injury.

- Use the head restraints designed for each respective seat.
- Adjust the head restraints to the correct position at all times.
- After adjusting the head restraints, push down on them and make sure they are locked in position.
- Do not drive with the head restraints removed.

تلفن شبانه روزی: ۰۲۱-۸۸۶۲۰۸۵

FarmaSOS.com

Steering wheel

Adjustment procedure

► Power type

Operating the switch moves the steering wheel in the following directions:

- ① Up
- ② Down
- ③ Toward the driver
- ④ Away from the driver

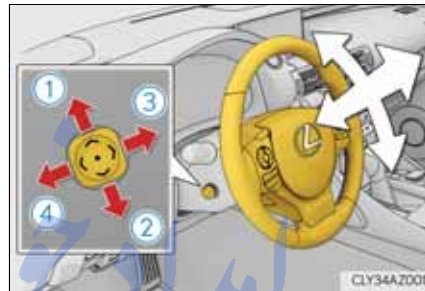

► Manual type

- 1 Hold the steering wheel and push the lever down.

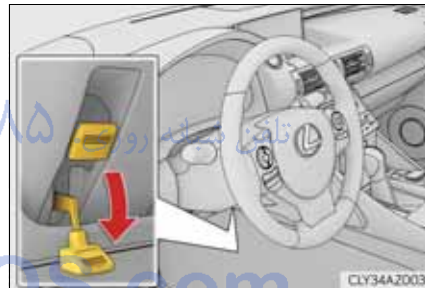

- 2 Adjust to the ideal position by moving the steering wheel horizontally and vertically.

After adjustment, pull the lever up to secure the steering wheel.

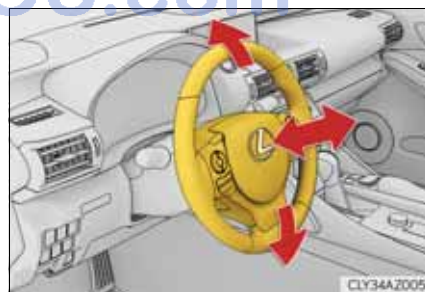

3

Operation of each component

Horn

To sound the horn, press on or close to the  mark.

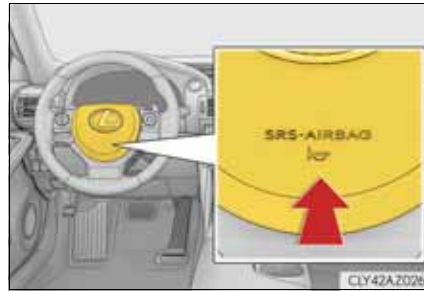

- The steering wheel can be adjusted when (power type)
The engine switch is in ACCESSORY or IGNITION ON mode*.
- *: If the driver's seat belt is fastened, the steering wheel can be adjusted regardless of engine switch mode.
- Automatic adjustment of the steering position (if equipped)
A desired steering position can be entered to memory and recalled automatically by the driving position memory system. (→P. 149)
- Power easy access system (if equipped)
The steering wheel and driver's seat move in accordance with engine switch mode and the driver's seat belt condition. (→P. 151)

⚠ CAUTION

- Caution while driving
Do not adjust the steering wheel while driving.
Doing so may cause the driver to mishandle the vehicle and cause an accident, resulting in death or serious injury.
- After adjusting the steering wheel (manual type)
Make sure that the steering wheel is securely locked.
Otherwise, the steering wheel may move suddenly, possibly causing an accident, and resulting in death or serious injury. Also, the horn may not sound if the steering wheel is not securely locked.

Inside rear view mirror

The rear view mirror's position can be adjusted to enable sufficient confirmation of the rear view.

Adjusting the height of rear view mirror

The height of the rear view mirror can be adjusted to suit your driving posture.

Adjust the height of the rear view mirror by moving it up and down.

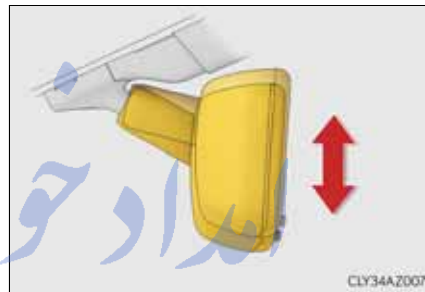

Anti-glare function

◆ Manual anti-glare inside rear view mirror

Reflected light from the headlights of vehicles behind can be reduced by operating the lever.

- ① Normal position
- ② Anti-glare position



3

Operation of each component

◆ Auto anti-glare inside rear view mirror

Responding to the level of brightness of the headlights of vehicles behind, the reflected light is automatically reduced.

Changing automatic anti-glare function mode

ON/OFF

When the automatic anti-glare function is in ON mode, the indicator illuminates.

The function will set to ON mode each time the engine switch is turned to IGNITION ON mode.

Pressing the button turns the function to OFF mode. (The indicator also turns off.)

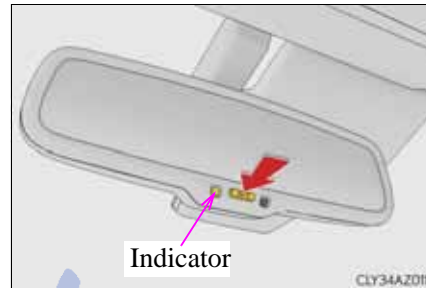

- To prevent sensor error (vehicles with auto anti-glare inside rear view mirror)

To ensure that the sensors operate properly, do not touch or cover them.



⚠ CAUTION

Do not adjust the position of the mirror while driving. Doing so may lead to mishandling of the vehicle and cause an accident, resulting in death or serious injury.

Outside rear view mirrors

Adjustment procedure

- 1** To select a mirror to adjust, press the switch.

- ① Left
- ② Right

Pressing the same switch again will put the switch in neutral.

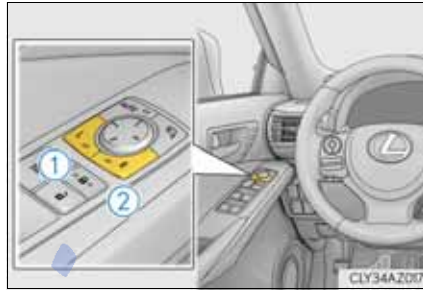

- 2** To adjust the mirror, press the switch.

- ① Up
- ② Right
- ③ Down
- ④ Left

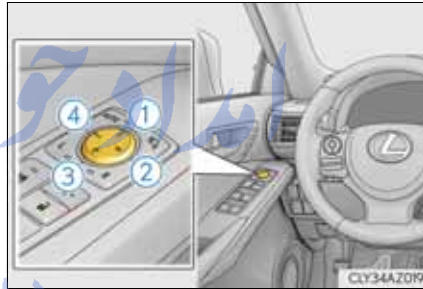

3

Operation of each component

تلفن شبانه روزی: ۰۲۱-۸۸۶۲۰۸۵

FarmaSOS.com

Automatically folding and extending the mirrors

■ Using the switch

Press the switch to fold the mirrors.

Press it again to extend them to the original position.

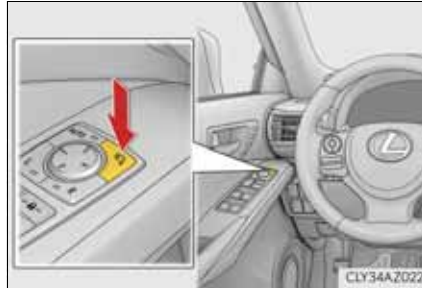

■ Setting automatic mode (if equipped)

Automatic mode allows the folding or extending of the mirrors to be linked to locking/unlocking of the doors.

Press the “AUTO” switch to set automatic mode.

The indicator will come on.

Pressing the switch once more will return to manual mode.

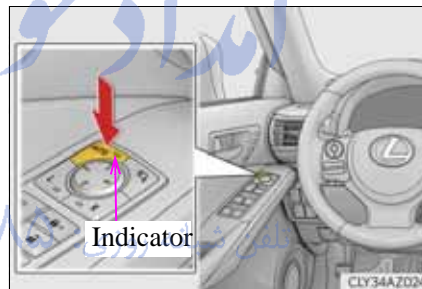

FarmaSOS.com

- Mirror angle can be adjusted when
The engine switch is in ACCESSORY or IGNITION ON mode.
- Linked mirror function when reversing (if equipped)
 - When either “L” or “R” of the mirror select switch is selected, the outside rear view mirrors will automatically angle downwards when the vehicle is reversing in order to give a better view of the ground. To disable this function, select neither “L” nor “R”.
 - If the mirror angle adjustment switch is operated while the linked mirror function is in operation, the angle and position of the mirrors can be remembered, and the mirrors will operate at the angle adjusted to the last time the linked mirror function was operated.
However, because the mirrors move based on the angle they are in when the linked mirror function is not operating, the mirror angle when the linked mirror function is operating will also be changed if the mirrors are adjusted while the function is not operating.
- When the mirrors are fogged up
The outside rear view mirrors can be cleared using the mirror defoggers. Turn on the rear window defogger to turn on the outside rear view mirror defoggers. (→P. 380)
- Automatic adjustment of the mirror angle (if equipped)
A desired mirror face angle can be entered to memory and recalled automatically by the driving position memory. (→P. 149)
- Auto anti-glare function (if equipped)
When the anti-glare inside rear view mirror is set to automatic mode, the outside rear view mirrors will activate in conjunction with the anti-glare inside rear view mirror to reduce reflected light. (→P. 160)
- Using automatic mode in cold weather
When automatic mode is used in cold weather, the door mirror could freeze up and automatic stowing and return may not be possible. In this case, remove any ice and snow from the door mirror, then either operate the mirror using manual mode or move the mirror by hand.
- Customization
The automatic mirror folding and extending operation can be changed. (Customizable features: →P. 549)

 CAUTION**■ Important points while driving**

Observe the following precautions while driving.

Failure to do so may result in loss of control of the vehicle and cause an accident, resulting in death or serious injury.

- Do not adjust the mirrors while driving.
- Do not drive with the mirrors folded.
- Both the driver and passenger side mirrors must be extended and properly adjusted before driving.

■ When a mirror is moving

To avoid personal injury and mirror malfunction, be careful not to get your hand caught by the moving mirror.

■ When the mirror defoggers are operating

Do not touch the rear view mirror surfaces, as they can become very hot and burn you.

امداد خودرو فارما
تلفن شبانه روزی: ۰۲۱-۸۸۸۶۲۰۸۵

FarmaSOS.com

Power windows

Opening and closing procedures

The power windows can be opened and closed using the switches. Operating the switch moves the windows as follows:

- ① Closing
- ② One-touch closing*
- ③ Opening
- ④ One-touch opening*

*: To stop the window partway, operate the switch in the opposite direction.

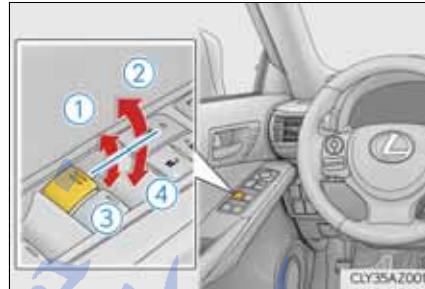

Window lock switch

Press the switch to lock the passenger window switches.

The indicator will come on.

Use this switch to prevent children from accidentally opening or closing a passenger window.

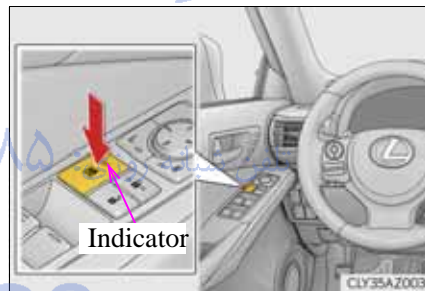

3

Operation of each component

FarmaSOS.com

- The power windows can be operated when
The engine switch is in IGNITION ON mode.
- Operating the power windows after turning the engine off
The power windows can be operated for approximately 45 seconds after the engine switch is turned to ACCESSORY mode or turned off. They cannot, however, be operated once either front door is opened.
- Jam protection function
If an object becomes caught between the window and the window frame, window travel is stopped and the window is opened slightly.
- When the power window does not close normally
If the jam protection function is operating abnormally and a window cannot be closed, perform the following operations using the power window switch on the relevant door.
 - After stopping the vehicle, the window can be closed by holding the power window switch in the one-touch closing position while the engine switch is turned to IGNITION ON mode.
 - If the window still cannot be closed even by carrying out the operation as explained above, initialize the function by performing the following procedure.
 - 1 Hold the power window switch in the one-touch closing position. Continue holding the switch for a further 6 seconds after the window has closed.
 - 2 Hold the power window switch in the one-touch opening position. Continue holding the switch for a further 2 seconds after the window has opened completely.
 - 3 Hold the power window switch in the one-touch closing position once again. Continue holding the switch for a further 2 seconds after the window has closed.

If you release the switch while the window is moving, start again from the beginning.

If the window continues to close but then re-open slightly even after performing the above procedure correctly, have the vehicle inspected by any authorized Lexus dealer or repairer, or another duly qualified and equipped professional.

- Door lock linked window operation
 - The power windows can be opened and closed using the mechanical key.* (→P. 523)
 - The power windows can be opened and closed using the wireless remote control.* (→P. 118)
- *: These settings must be customized at any authorized Lexus dealer or repairer, or another duly qualified and equipped professional.
- When the battery is disconnected
The window lock switch is disabled. If necessary, press the window lock switch after reconnecting the battery.
- Power windows open warning buzzer
The buzzer sounds and a message is shown on the multi-information display in the instrument cluster when the engine switch is turned off and the driver's door is opened with the power windows open.
- Customization
Settings (e.g. linked door lock operation) can be changed.
(Customizable features: →P. 549)

 CAUTION

Observe the following precautions.
Failure to do so may result in death or serious injury.

- Closing the windows
 - Check to make sure that all passengers do not have any part of their body in a position where it could be caught when a window is being operated.
 - Do not allow children to operate the power windows.
Closing a power window on someone can cause serious injury, and in some instances, even death.
- Jam protection function
 - Never use any part of your body to intentionally activate the jam protection function.
 - The jam protection function may not work if something gets caught just before the window fully closes.

Moon roof*

Use the overhead switches to open and close the moon roof and tilt it up and down.

Opening and closing

① Opens the moon roof*

The moon roof stops slightly before the fully open position to reduce wind noise.

Press the switch again to fully open the moon roof.

② Closes the moon roof*

*: Lightly press either way of the moon roof switch to stop the moon roof partway.

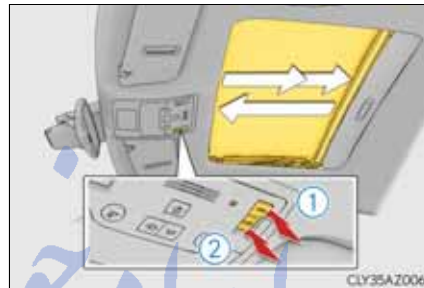

Tilting up and down

① Tilts the moon roof up*

② Tilts the moon roof down*

*: Lightly press either way of the moon roof switch to stop the moon roof partway.



*: If equipped

- The moon roof can be operated when
The engine switch is in IGNITION ON mode.
 - Operating the moon roof after turning the engine off
The moon roof can be operated for approximately 45 seconds after the engine switch is turned to ACCESSORY mode or turned off. It cannot, however, be operated once either front door is opened.
 - Jam protection function
If an object is detected between the moon roof and the frame while the moon roof is closing or tilting down, travel is stopped and the moon roof opens slightly.
 - Sunshade
The sunshade can be opened and closed manually. However, the sunshade will open automatically when the moon roof is opened.
 - Door lock linked moon roof operation
 - The moon roof can be opened and closed using the mechanical key.* (→P. 523)
 - The moon roof can be opened and closed using the wireless remote control.* (→P. 118)
- *: These settings must be customized at any authorized Lexus dealer or repairer, or another duly qualified and equipped professional.

تلفن شبانه روزی: ۰۲۱-۸۸۶۲۰۸۵

FarmaSOS.com

■ When the moon roof does not close normally

Perform the following procedure:

● If the moon roof closes but then re-opens slightly

1 Stop the vehicle.

2 Press and hold the “CLOSE” switch.*1

The moon roof will close, reopen and pause for approximately 10 seconds.*2 Then it will close again, tilt up and pause for approximately 1 second. Finally, it will tilt down, open and close.

3 Check to make sure that the moon roof is completely closed and then release the switch.

● If the moon roof tilts down but then tilts back up

1 Stop the vehicle.

2 Press and hold the “UP” switch*1 until the moon roof moves into the tilt up position and stops.

3 Release the “UP” switch once and then press and hold the “UP” switch again.*1

The moon roof will pause for approximately 10 seconds in the tilt up position.*2 Then it will adjust slightly and pause for approximately 1 second. Finally, it will tilt down, open and close.

4 Check to make sure that the moon roof is completely closed and then release the switch.

*1: If the switch is released at the incorrect time, the procedure will have to be performed again from the beginning.

*2: If the switch is released after the above mentioned 10 second pause, automatic operation will be disabled. In that case, press and hold the “CLOSE” or “UP” switch, and the moon roof will tilt up and pause for approximately 1 second. Then it will tilt down, open and close. Check to make sure that the moon roof is completely closed and then release the switch.

If the moon roof does not fully close even after performing the above procedure correctly, have the vehicle inspected by any authorized Lexus dealer or repairer, or another duly qualified and equipped professional.

- Moon roof open warning buzzer
The buzzer sounds and a message is shown on the multi-information display in the instrument cluster when the engine switch is turned off and the driver's door is opened with the moon roof open.
- Customization
Settings (e.g. linked door lock operation) can be changed.
(Customizable features: →P. 549)

 **CAUTION**

Observe the following precautions.
Failure to do so may cause death or serious injury.

- Opening the moon roof
 - Do not allow any passengers to put their hands or heads outside the vehicle while it is moving.
 - Do not sit on top of the moon roof.
- Closing the moon roof
 - Check to make sure that all passengers do not have any part of their body in a position where it could be caught when the moon roof is being operated.
 - Do not allow children to operate the moon roof.
Closing the moon roof on someone can cause death or serious injury.
- Jam protection function
 - Never use any part of your body to intentionally activate the jam protection function.
 - The jam protection function may not work if something gets caught just before the moon roof fully closes.

3

Operation of each component

FarmaSOS.com

امداد خودرو فارما

تلفن شبانه روزی: ۰۲۱-۸۸۸۶۲۰۸۵

FarmaSOS.com

Driving

4

4-1. Before driving	4-5. Using the driving support systems
Driving the vehicle..... 174	Cruise control 223
Cargo and luggage 181	Dynamic radar cruise control..... 227
Trailer towing..... 182	LDA (Lane Departure Alert) ... 239
4-2. Driving procedures	Lexus parking assist-sensor 245
Engine (ignition) switch.... 190	Rear view monitor system 252
Automatic transmission 195	Driving mode select switch 261
Turn signal lever 201	Driving assist systems 263
Parking brake 203	PCS (Pre-Crash Safety system)..... 269
4-3. Operating the lights and wipers	BSM (Blind Spot Monitor) 276
Headlight switch 204	• The Blind Spot Monitor function..... 281
Automatic High Beam 207	• The Rear Crossing Traffic Alert function 283
Fog light switch 211	4-6. Driving tips
Windshield wipers and washer 213	Winter driving tips 286
4-4. Refueling	
Opening the fuel tank cap . 219	

Driving the vehicle

The following procedures should be observed to ensure safe driving:

Starting the engine

→P. 190

Driving

- 1 With the brake pedal depressed, shift the shift lever to D. (→P. 195)
- 2 Release the parking brake. (→P. 203)
- 3 Gradually release the brake pedal and gently depress the accelerator pedal to accelerate the vehicle.

Stopping

- 1 With the shift lever in D, depress the brake pedal.
- 2 If necessary, set the parking brake.
If the vehicle is to be stopped for an extended period of time, shift the shift lever to P or N. (→P. 195)

Parking the vehicle

- 1 With the shift lever in D, depress the brake pedal.
- 2 Set the parking brake. (→P. 203)
- 3 Shift the shift lever to P. (→P. 195)
If parking on a hill, block the wheels as needed.
- 4 Press the engine switch to stop the engine.
- 5 Lock the door, making sure that you have the electronic key on your person.

Starting off on a steep uphill

- 1 Make sure that the parking brake is set and shift the shift lever to D.
- 2 Gently depress the accelerator pedal.
- 3 Release the parking brake.

- When starting off on an uphill
The hill-start assist control will activate. (→P. 263)
- Driving in the rain
 - Drive carefully when it is raining, because visibility will be reduced, the windows may become fogged-up, and the road will be slippery.
 - Drive carefully when it starts to rain, because the road surface will be especially slippery.
 - Refrain from high speeds when driving on an expressway in the rain, because there may be a layer of water between the tires and the road surface, preventing the steering and brakes from operating properly.
- Engine speed while driving
In the following conditions, the engine speed may become high while driving. This is due to automatic up-shifting control or down-shifting implementation to meet driving conditions. It does not indicate sudden acceleration.
 - The vehicle is judged to be driving uphill or downhill
 - When the accelerator pedal is released
 - When the brake pedal is depressed while sport mode is selected
- Breaking in your new Lexus
To extend the life of the vehicle, observing the following precautions is recommended:
 - For the first 300 km (186 miles):
Avoid sudden stops.
 - For the first 800 km (500 miles):
Do not tow a trailer.
 - For the first 1000 km (621 miles):
 - Do not drive at extremely high speeds.
 - Avoid sudden acceleration.
 - Do not drive continuously in low gears.
 - Do not drive at a constant speed for extended periods.
- Drum-in-disc type parking brake system
Your vehicle has a drum-in-disc type parking brake system. This type of brake system needs bedding-down of the brake shoes periodically or whenever the parking brake shoes and/or drum are replaced. Have any authorized Lexus dealer or repairer, or another duly qualified and equipped professional, perform the bedding down operation.
- Operating your vehicle in a foreign country
Comply with the relevant vehicle registration laws and confirm the availability of the correct fuel. (→P. 538)

 CAUTION

Observe the following precautions.
Failure to do so may result in death or serious injury.

■ When starting the vehicle

Always keep your foot on the brake pedal while stopped with the engine running. This prevents the vehicle from creeping.

■ When driving the vehicle

- Do not drive if you are unfamiliar with the location of the brake and accelerator pedals to avoid depressing the wrong pedal.
 - Accidentally depressing the accelerator pedal instead of the brake pedal will result in sudden acceleration that may lead to an accident.
 - When backing up, you may twist your body around, leading to a difficulty in operating the pedals. Make sure to operate the pedals properly.
 - Make sure to keep a correct driving posture even when moving the vehicle only slightly. This allows you to depress the brake and accelerator pedals properly.
 - Depress the brake pedal using your right foot. Depressing the brake pedal using your left foot may delay response in an emergency, resulting in an accident.
- Do not drive the vehicle over or stop the vehicle near flammable materials. The exhaust system and exhaust gases can be extremely hot. These hot parts may cause a fire if there is any flammable material nearby.
- During normal driving, do not turn off the engine. Turning the engine off while driving will not cause loss of steering or braking control, but the power assist to these systems will be lost. This will make it more difficult to steer and brake, so you should pull over and stop the vehicle as soon as it is safe to do so.
However, in the event of an emergency, such as if it becomes impossible to stop the vehicle in the normal way: →P. 467
- Use engine braking (downshift) to maintain a safe speed when driving down a steep hill.
Using the brakes continuously may cause the brakes to overheat and lose effectiveness. (→P. 195)
- Do not adjust the positions of the steering wheel, the seat, or the inside or outside rear view mirrors while driving.
Doing so may result in a loss of vehicle control.
- Always check that all passengers' arms, heads or other parts of their body are not outside the vehicle.

 CAUTION

Observe the following precautions.
Failure to do so may result in death or serious injury.

- When driving on slippery road surfaces
 - Sudden braking, acceleration and steering may cause tire slippage and reduce your ability to control the vehicle.
 - Sudden acceleration, engine braking due to shift changing, or changes in engine speed could cause the vehicle to skid.
 - After driving through a puddle, depress the brake pedal to make sure that the brakes are functioning properly. Wet brake pads may prevent the brakes from functioning properly. If the brakes on only one side are wet and not functioning properly, steering control may be affected.
- When shifting the shift lever
 - Do not let the vehicle roll backward while the shift lever is in a driving position, or roll forward while the shift lever is in R.
Doing so may cause the engine to stall or lead to poor brake and steering performance, resulting in an accident or damage to the vehicle.
 - Do not shift the shift lever to P while the vehicle is moving.
Doing so can damage the transmission and may result in a loss of vehicle control.
 - Do not shift the shift lever to R while the vehicle is moving forward.
Doing so can damage the transmission and may result in a loss of vehicle control.
 - Do not shift the shift lever to D while the vehicle is moving backward.
Doing so can damage the transmission and may result in a loss of vehicle control.
 - Moving the shift lever to N while the vehicle is moving will disengage the engine from the transmission. Engine braking is not available when N is selected.
 - Be careful not to shift the shift lever with the accelerator pedal depressed. Shifting the shift lever to a gear other than P or N may lead to unexpected rapid acceleration of the vehicle that may cause an accident and result in death or serious injury.
- If you hear a squealing or scraping noise (brake pad wear indicators)

Have the brake pads checked and replaced by any authorized Lexus dealer or repairer, or another duly qualified and equipped professional as soon as possible.
Rotor damage may result if the pads are not replaced when needed.

Moderate levels of brake pad and disc wear allow enhanced braking power. As a result, the discs may wear more quickly than conventional brake discs. Therefore, when replacing the brake pads, Lexus recommends that you also have the thickness of the discs measured.
It is dangerous to drive the vehicle when the wear limits of the brake pads and/or those of the brake discs are exceeded.

⚠ CAUTION

Observe the following precautions.

Failure to do so may result in death or serious injury.

■ When the vehicle is stopped

- Do not race the engine.
If the shift lever is any position other than P or N, the vehicle may accelerate suddenly and unexpectedly, causing an accident.
- In order to prevent accidents due to the vehicle rolling away, always keep depressing the brake pedal while the engine is running, and apply the parking brake as necessary.
- If the vehicle is stopped on an incline, in order to prevent accidents caused by the vehicle rolling forward or backward, always depress the brake pedal and securely apply the parking brake as needed.
- Avoid revving or racing the engine.
Running the engine at high speed while the vehicle is stopped may cause the exhaust system to overheat, which could result in a fire if combustible material is nearby.

■ When the vehicle is parked

- Do not leave glasses, cigarette lighters, spray cans, or soft drink cans in the vehicle when it is in the sun.
Doing so may result in the following:
 - Gas may leak from a cigarette lighter or spray can, and may lead to a fire.
 - The temperature inside the vehicle may cause the plastic lenses and plastic material of glasses to deform or crack.
 - Soft drink cans may fracture, causing the contents to spray over the interior of the vehicle, and may also cause a short circuit in the vehicle's electrical components.
- Do not leave cigarette lighters in the vehicle. If a cigarette lighter is in a place such as the glove box or on the floor, it may be lit accidentally when luggage is loaded or the seat is adjusted, causing a fire.
- Do not attach adhesive discs to the windshield or windows. Do not place containers such as air fresheners on the instrument panel or dashboard. Adhesive discs or containers may act as lenses, causing a fire in the vehicle.
- Do not leave a door or window open if the curved glass is coated with a metallized film such as a silver-colored one. Reflected sunlight may cause the glass to act as a lens, causing a fire.
- Always apply the parking brake, shift the shift lever to P, stop the engine and lock the vehicle.
Do not leave the vehicle unattended while the engine is running.
- Do not touch the exhaust pipes while the engine is running or immediately after turning the engine off.
Doing so may cause burns.

 **CAUTION**

Observe the following precautions.
Failure to do so may result in death or serious injury.

■ When taking a nap in the vehicle

Always turn the engine off. Otherwise, if you accidentally move the shift lever or depress the accelerator pedal, this could cause an accident or fire due to engine overheating. Additionally, if the vehicle is parked in a poorly ventilated area, exhaust gases may collect and enter the vehicle, leading to death or a serious health hazard.

■ When braking

● When the brakes are wet, drive more cautiously.

Braking distance increases when the brakes are wet, and this may cause one side of the vehicle to brake differently than the other side. Also, the parking brake may not securely hold the vehicle.

● If the power brake assist function does not operate, do not follow other vehicles closely and avoid hills or sharp turns that require braking.
In this case, braking is still possible, but the brake pedal should be depressed more firmly than usual. Also, the braking distance will increase. Have your brakes fixed immediately.

● Do not pump the brake pedal if the engine stalls.

Each push on the brake pedal uses up the reserve for the power-assisted brakes.

● The brake system consists of 2 individual hydraulic systems; if one of the systems fails, the other will still operate. In this case, the brake pedal should be depressed more firmly than usual and the braking distance will increase.
Have your brakes fixed immediately.

■ If the vehicle becomes stuck

Do not spin the wheels excessively when any of the tires is up in the air, or the vehicle is stuck in sand, mud, etc. This may damage the driveline components or propel the vehicle forward or backward, causing an accident.



NOTICE

■ When driving the vehicle

- Do not depress the accelerator and brake pedals at the same time during driving, as this may restrain driving torque.
- Do not use the accelerator pedal or depress the accelerator and brake pedals at the same time to hold the vehicle on a hill.

■ When parking the vehicle

Always shift the shift lever to P. Failure to do so may cause the vehicle to move or the vehicle may accelerate suddenly if the accelerator pedal is accidentally depressed.

■ Avoiding damage to vehicle parts

- Do not turn the steering wheel fully in either direction and hold it there for an extended period of time.
Doing so may damage the power steering motor.
- When driving over bumps in the road, drive as slowly as possible to avoid damaging the wheels, underside of the vehicle, etc.

■ If you get a flat tire while driving

A flat or damaged tire may cause the following situations. Hold the steering wheel firmly and gradually depress the brake pedal to slow down the vehicle.

- It may be difficult to control your vehicle.
- The vehicle will make abnormal sounds or vibrations.
- The vehicle will lean abnormally.

Information on what to do in case of a flat tire (→P. 495, 506)

■ When encountering flooded roads

Do not drive on a road that has flooded after heavy rain etc. Doing so may cause the following serious damage to the vehicle:

- Engine stalling
- Short in electrical components
- Engine damage caused by water immersion

In the event that you drive on a flooded road and the vehicle is flooded, be sure to have any authorized Lexus dealer or repairer, or another duly qualified and equipped professional check the following:

- Brake function
- Changes in quantity and quality of oil and fluid used for the engine, transmission, differentials, etc.
- Lubricant condition for the propeller shaft, bearings and suspension joints (where possible), and the function of all joints, bearings, etc.

Cargo and luggage

Take notice of the following information about storage precautions, cargo capacity and load:

CAUTION

- Things that must not be carried in the trunk
 - The following things may cause a fire if loaded in the trunk:
 - Receptacles containing gasoline
 - Aerosol cans
- Storage precautions
 - Observe the following precautions.
Failure to do so may prevent the pedals from being depressed properly, may block the driver's vision, or may result in items hitting the driver or passengers, possibly causing an accident.
 - Stow cargo and luggage in the trunk whenever possible.
 - To prevent cargo and luggage from sliding forward during braking, do not stack anything in the enlarged trunk. Keep cargo and luggage low, as close to the floor as possible.
 - When you fold down the rear seats, long items should not be placed directly behind the front seats.
 - Never allow anyone to ride in the enlarged trunk. It is not designed for passengers. They should ride in their seats with their seat belts properly fastened.
 - Do not place cargo or luggage in or on the following locations.
 - At the feet of the driver
 - On the front passenger or rear seats (when stacking items)
 - On the package tray
 - On the instrument panel
 - On the dashboard
 - In front of the navigation system screen (if equipped) or Lexus Display Audio screen (if equipped)
 - Secure all items in the occupant compartment.
- Load and distribution
 - Do not overload your vehicle.
 - Do not apply loads unevenly.
Improper loading may cause deterioration of steering or braking control which may cause death or serious injury.

Trailer towing (vehicles with a towing package)

The strain of towing a trailer will have a negative impact on the running performance, handling, fuel consumption and endurance of your vehicle. Use the vehicle features in the correct manner and operate the vehicle with care for safer driving and optimal comfort. Damage and/or malfunctions that occur as a result of towing performed for commercial purposes are not covered by the Lexus warranty.

Ask your local authorized Lexus dealer or repairer, or another duly qualified and equipped professional for further details before towing, as there are additional legal requirements in some countries.

◆ Weight limits

Check the allowable towing capacity, GVM (Gross Vehicle Mass), MPAC (Maximum Permissible Axle Capacity), and permissible draw bar load before towing. (→P. 536)

◆ Towing hitch/bracket

Lexus recommends the use of the Lexus hitch/bracket for your vehicle. Other products of a suitable nature and comparable quality may also be used. تلفن شبانه روزی: ۰۲۱-۸۸۶۲۰۸۵

◆ To prevent an accident

The handling of the vehicle will feel different when towing a trailer. Beware of the 3 most common causes of towing-related accidents: driver error, excessive speed, and overloading.

Important points regarding trailer loads

■ Total trailer weight and permissible drawbar load

① Total trailer weight

Weight of the trailer itself plus the trailer load should be within the maximum towing capacity. Exceeding this weight is dangerous. (→P. 536)

When the total trailer weight is greater than the vehicle weight, we recommend the use of a friction stabilizer (sway control device).

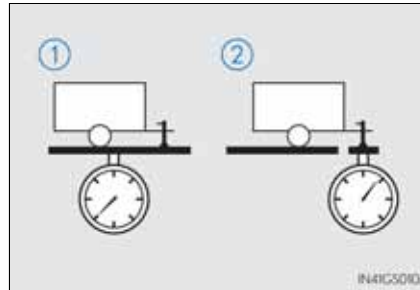

② Permissible drawbar load

Allocate the trailer load so that the drawbar load is greater than 25 kg (55.1 lb.) or 4% of the towing capacity. Do not let the drawbar load exceed the indicated weight. (→P. 536)

■ Information tag (manufacturer's label)

▶ Type A

▶ Type B

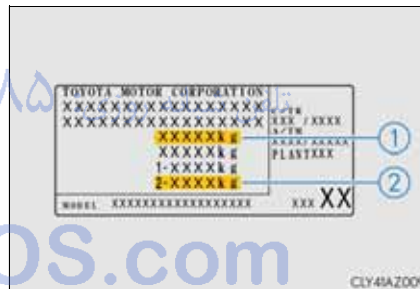
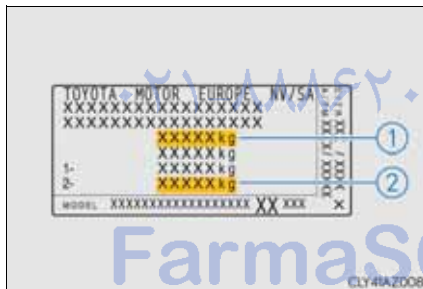

① Gross vehicle mass

The combined weight of the driver, passengers, towing hitch, total curb mass and drawbar load should not exceed the gross vehicle mass by more than 100 kg (220.5 lb.). Exceeding this weight is dangerous.

② Maximum permissible rear axle capacity

The weight borne by the rear axle should not exceed the maximum permissible axle capacity by 15% or more. Exceeding this weight is dangerous.

The values for towing capacity were derived from testing conducted at sea level. Take note that engine output and towing capacity will be reduced at high altitudes.

 CAUTION

- When the gross vehicle mass limit or maximum permissible axle capacity is exceeded
Do not exceed the established speed limit for towing a trailer in built-up areas or 100 km/h (62 mph), whichever is the lower.

امداد خودرو فارما

تلفن شبانه روزی: ۰۲۱-۸۸۸۶۲۰۸۵

FarmaSOS.com

Installation positions for the towing hitch/bracket and hitch ball

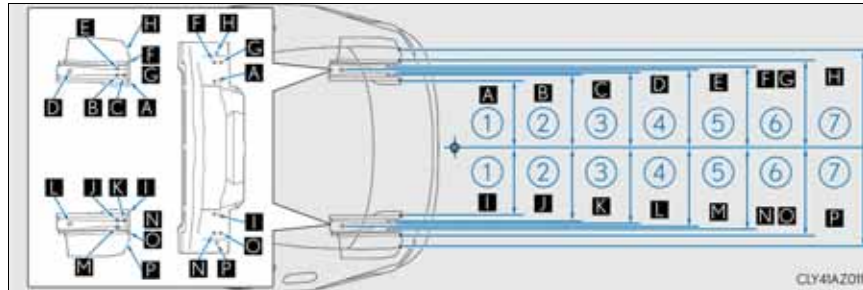

- | | |
|---------------------|---------------------|
| ① 436 mm (17.2 in.) | ⑤ 520 mm (20.5 in.) |
| ② 475 mm (18.7 in.) | ⑥ 560 mm (22.0 in.) |
| ③ 476 mm (18.7 in.) | ⑦ 622 mm (24.5 in.) |
| ④ 502 mm (19.8 in.) | |

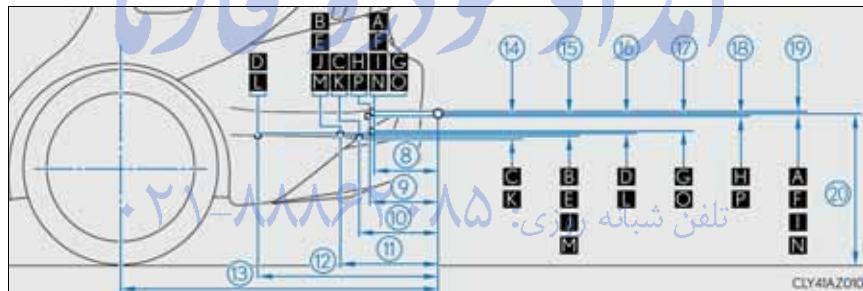

- | | |
|----------------------|---------------------|
| ⑧ 308 mm (12.1 in.) | ⑮ 53 mm (2.1 in.) |
| ⑨ 318 mm (12.5 in.) | ⑯ 42 mm (1.7 in.) |
| ⑩ 342 mm (13.5 in.) | ⑰ 34 mm (1.3 in.) |
| ⑪ 394 mm (15.5 in.) | ⑱ 6 mm (0.2 in.) |
| ⑫ 704 mm (27.7 in.) | ⑲ 11 mm (0.4 in.) |
| ⑬ 1138 mm (44.8 in.) | ⑳ 390 mm (15.4 in.) |
| ⑭ 58 mm (2.3 in.) | |

- Tire information
 - Increase the tire inflation pressure to 20.0 kPa (0.2 kgf/cm² or bar, 3 psi) greater than the recommended value when towing. (→P. 544)
 - Increase the air pressure of the trailer tires in accordance with the total trailer weight and according to the values recommended by the manufacturer of your trailer.
- Break-in schedule

Lexus recommends that vehicles fitted with new power train components should not be used for towing trailers for the first 800 km (500 miles).
- Safety checks before towing
 - Check that the maximum load limit for the towing hitch/bracket hitch ball is not exceeded. Bear in mind that the coupling weight of the trailer will add to the load exerted on the vehicle. Also make sure that you will not be towing a load that exceeds the maximum permissible axle capacity.
 - Ensure that the trailer load is secure.
 - Supplementary outside rear view mirrors should be added to the vehicle if the traffic behind cannot be clearly seen with standard mirrors. Adjust the extending arms of these mirrors on both sides of the vehicle so that they always provide maximum visibility of the road behind.
- Maintenance
 - Maintenance must be performed more frequently when using the vehicle for towing due to the greater weight burden placed on the vehicle compared to normal driving.
 - Retighten all bolts securing the hitching ball and bracket after towing for approximately 1000 km (600 miles).

 NOTICE

- When the rear bumper strengthening material is aluminum

Ensure the steel bracket part does not come directly in contact with that area. When steel and aluminum come into contact, there is a reaction similar to corrosion, which will weaken the section concerned and may result in damage. Apply a rust inhibitor to parts that will come in contact when attaching a steel bracket.

Guidance

Your vehicle will handle differently when towing a trailer. In order to avoid accident, death or serious injury, keep the following in mind when towing:

- Checking connections between trailer and lights

Stop the vehicle and check the operation of the connection between the trailer and lights after driving for a brief period as well as before starting off.

- Practicing driving with a coupled trailer

- Get the feel for turning, stopping and reversing with the trailer coupled by practicing in an area with no or light traffic.
- When reversing with a coupled trailer, hold the section of the steering wheel nearest to you and rotate clockwise to turn the trailer left or counterclockwise to turn it right. Always rotate a little at a time to prevent steering error. Have someone guide you when reversing to lessen the risk of an accident.

- Increasing vehicle-to-vehicle distance

At a speed of 10 km/h (6 mph), the distance to the vehicle running ahead of you should be equivalent to or greater than the combined length of your vehicle and trailer. Avoid sudden braking that may cause skidding. Otherwise, the vehicle may spin out of control. This is especially true when driving on wet or slippery road surfaces.

- Sudden acceleration/steering input/cornering

Executing sharp turns when towing may result in the trailer colliding with your vehicle. Decelerate well in advance when approaching turns and take them slowly and carefully to avoid sudden braking.

- Important points regarding turning

The wheels of the trailer will travel closer to the inside of the curve than the wheels of the vehicle. To make allowance for this, take the turns wider than you would normally do.

- Important points regarding stability
Vehicle movement resulting from uneven road surfaces and strong crosswinds will affect handling. The vehicle may also be rocked by passing buses or large trucks. Frequently check behind when moving alongside such vehicles. As soon as such vehicle movement occurs, immediately start to decelerate smoothly by slowly applying the brakes. Always steer the vehicle straight ahead while braking.
- Passing other vehicles
Consider the total combined length of your vehicle and trailer and ensure that the vehicle-to-vehicle distance is sufficient before executing lane changes.
- Transmission information
To maintain engine braking efficiency, when using engine braking when driving on a long steep downward grade, do not use the transmission in D. The vehicle must be driven in gear shift position “4” in M mode. (→P. 198)
- If the engine overheats
Towing a loaded trailer up a long, steep incline in temperatures exceeding 30°C (85°F) may result in the engine overheating. If the engine coolant temperature gauge indicates that the engine is overheating, turn the air conditioning off immediately, leave the road and stop the vehicle in a safe place.
(→P. 530)
- When parking the vehicle
Always place wheel chocks under the wheels of both the vehicle and trailer. Firmly set the parking brake and shift the shift lever to P.

 CAUTION

- To avoid accident or injury
 - Do not tow a trailer when the compact spare tire is installed on your vehicle.
 - Do not tow the vehicle when the tire installed is repaired with the emergency tire puncture repair kit.
- Vehicle speed in towing
 - Observe the legal maximum speeds for trailer towing.
- Before descending hills or long declines
 - Reduce speed and downshift. However, never downshift suddenly while descending steep or long downhill grades.
- Operation of the brake pedal
 - Do not hold the brake pedal depressed often or for long periods of time. Doing so may result in the brake overheating or reduce braking effects.

 NOTICE

- For vehicles with an emergency tire puncture repair kit (if equipped)
 - Do not tow anything if a tire that has been repaired using the emergency tire puncture repair kit is installed. The load on the tire may cause unexpected damage to the tire.

تلفن شبانه روزی: ۰۲۱-۸۸۶۲۰۸۵

FarmaSOS.com

Engine (ignition) switch

Performing the following operations when carrying the electronic key on your person starts the engine or changes engine switch modes.

Starting the engine

- 1 Check that the parking brake is set.
- 2 Check that the shift lever is in P.
- 3 Firmly depress the brake pedal.



and a message will be displayed on the multi-information display.

If it is not displayed, the engine cannot be started.

- 4 Press the engine switch.

The engine will crank until it starts or for up to 30 seconds, whichever is less.

Continue depressing the brake pedal until the engine is completely started.

The engine can be started from any engine switch mode.

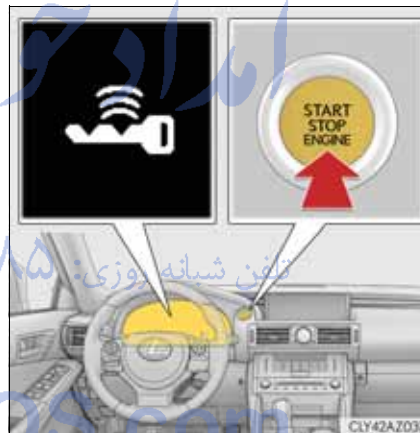

Stopping the engine

- 1 Stop the vehicle.
- 2 Shift the shift lever to P.
- 3 Set the parking brake. (→P. 203)
- 4 Press the engine switch.
- 5 Release the brake pedal and check that the display on the meters is off.

Changing engine switch modes

Modes can be changed by pressing the engine switch with brake pedal released. (The mode changes each time the switch is pressed.)

① Off*

The emergency flashers can be used.
The multi-information display will not be displayed.

② ACCESSORY mode

Some electrical components such as the audio system can be used.
“ACCESSORY” will be displayed on the meters.

③ IGNITION ON mode

All electrical components can be used.
“IGNITION ON” will be displayed on the meters.

*: If the shift lever is in a position other than P when turning off the engine, the engine switch will be turned to ACCESSORY mode, not to off.

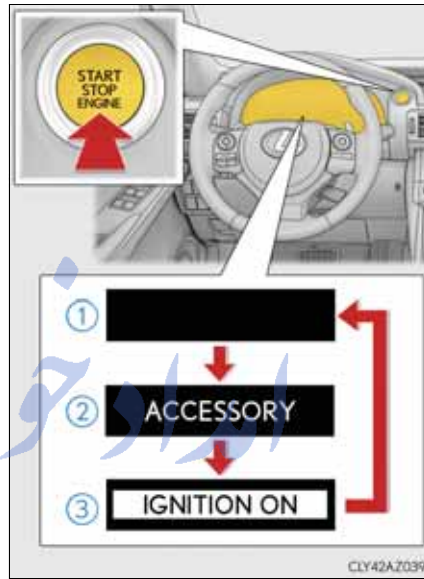

When stopping the engine with the shift lever in a position other than P

If the engine is stopped with the shift lever in a position other than P, the engine switch will not be turned off but instead be turned to ACCESSORY mode. Perform the following procedure to turn the switch off:

- ① Check that the parking brake is set.
- ② Shift the shift lever to P.
- ③ Check that “Turn Power OFF” is displayed on the multi-information display and then press the engine switch once.
- ④ Check that “Turn Power OFF” on the multi-information display is off.

- Auto power off function

If the vehicle is left in ACCESSORY mode for more than 20 minutes or IGNITION ON mode (the engine is not running) for more than an hour with the shift lever in P, the engine switch will automatically turn off. However, this function cannot entirely prevent battery discharge. Do not leave the vehicle with the engine switch in ACCESSORY or IGNITION ON mode for long periods of time when the engine is not running.

- Electronic key battery depletion

→P. 115

- Conditions affecting operation

→P. 132

- Notes for the entry function

→P. 133

- If the engine does not start

- Check that the shift lever is securely set in P. The engine may not start if the shift lever is displaced out of P.
- The engine immobilizer system may not have been deactivated. (→P. 77)
Contact any authorized Lexus dealer or repairer, or another duly qualified and equipped professional.

- Steering lock

After turning the engine switch off and opening and closing the doors, the steering wheel will be locked due to the steering lock function. Operating the engine switch again automatically cancels the steering lock.

- When the steering lock cannot be released

“Steering Lock active” will be displayed on the multi-information display.

Check that the shift lever is in P. Press the engine switch while turning the steering wheel left and right.



- Steering lock motor overheating prevention

To prevent the steering lock motor from overheating, operation of the motor may be suspended if the engine is turned on and off repeatedly in a short period of time. In this case, refrain from operating the engine switch. After about 10 seconds, the steering lock motor will resume functioning.

- When “Check Entry & Start System” is displayed on the multi-information display
The system may be malfunctioning. Have the vehicle inspected by any authorized Lexus dealer or repairer, or another duly qualified and equipped professional immediately.
- If the electronic key battery is depleted
→P. 520
- Operation of the engine switch
 - When operating the engine switch, one short, firm press is enough. If the switch is pressed improperly, the engine may not start or the engine switch mode may not change. It is not necessary to press and hold the switch.
 - If attempting to restart the engine immediately after turning the engine switch off, the engine may not start in some cases. After turning the engine switch off, please wait a few seconds before restarting the engine.
- If the smart entry & start system has been deactivated by a customized setting
→P. 523

⚠ CAUTION

■ When starting the engine

Always start the engine while sitting in the driver's seat. Do not depress the accelerator pedal while starting the engine under any circumstances. Doing so may cause an accident resulting in death or serious injury.

■ Caution while driving

If engine failure occurs while the vehicle is moving, do not lock or open the doors until the vehicle reaches a safe and complete stop. Activation of the steering lock in this circumstance may lead to an accident, resulting in death or serious injury.

■ Stopping the engine in an emergency

If you want to stop the engine in an emergency while driving the vehicle, press and hold the engine switch for more than 2 seconds, or press it briefly 3 times or more in succession. (→P. 467)

However, do not touch the engine switch while driving except in an emergency. Turning the engine off while driving will not cause loss of steering or braking control, but the power assist to these systems will be lost. This will make it more difficult to steer and brake, so you should pull over and stop the vehicle as soon as it is safe to do so.

 NOTICE

- To prevent battery discharge
 - Do not leave the engine switch in ACCESSORY or IGNITION ON mode for long periods of time without the engine running.
 - If “ACCESSORY” or “IGNITION ON” is displayed on the meters while the engine is not running, the engine switch is not off. Exit the vehicle after turning the engine switch off.
 - Do not stop the engine when the shift lever is in a position other than P. If the engine is stopped in another shift lever position, the engine switch will not be turned off but instead be turned to ACCESSORY mode. If the vehicle is left in ACCESSORY mode, battery discharge may occur.
- When starting the engine
 - Do not race a cold engine.
 - If the engine becomes difficult to start or stalls frequently, have your vehicle checked by any authorized Lexus dealer or repairer, or another duly qualified and equipped professional immediately.
- Symptoms indicating a malfunction with the engine switch

If the engine switch seems to be operating somewhat differently than usual, such as the switch sticking slightly, there may be a malfunction. Contact any authorized Lexus dealer or repairer, or another duly qualified and equipped professional immediately.

تلفن شبانه روزی: ۰۲۱-۸۸۶۲۰۸۵

FarmaSOS.com

Automatic transmission

Shifting the shift lever

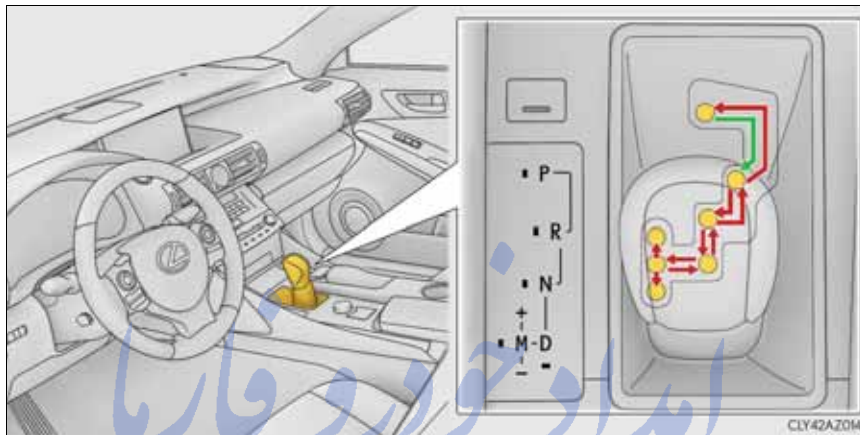

← While the engine switch is in IGNITION ON mode, move the shift lever with the brake pedal depressed.

When shifting the shift lever between P and D, make sure that the vehicle is completely stopped.

تلفن شبانه روزی: ۰۲۱-۸۸۶۲۰۸۵

FarmaSOS.com

Shift position purpose

Shift position	Objective or function
P	Parking the vehicle/starting the engine
R	Reversing
N	Neutral
D	Normal driving* ¹
M	M mode driving* ² (→P. 198)

*¹: To improve fuel efficiency and reduce noise, shift the shift lever to D for normal driving.

*²: Any gear range can be fixed when driving in M mode.

Selecting the driving mode

- Sport mode/Eco drive mode
→P. 261
- Snow mode

Snow mode can be selected to suit the conditions when driving on slippery road surfaces, such as snow.

Press the switch.

Press the switch again to return to normal mode.



Selecting shift ranges in the D position

To drive using temporary shift range selection, operate the “-” paddle shift switch. The shift range can then be selected by operating the “-” and “+” paddle shift switches. Changing the shift range allows restriction of the highest gear, preventing unnecessary upshifting and enabling the level of engine braking force to be selected.

① Upshifting

② Downshifting

The selected shift range, from D1 to D6, will be displayed in the meter.

To return to normal D position driving, the “+” paddle shift switch must be held down for a period of time.

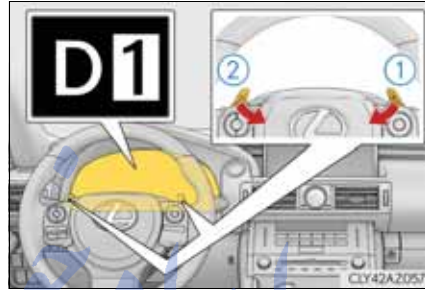

■ Shift ranges and their functions

Meter display	Function
D2 - D6	A gear in the range between 1 and the selected gear is automatically chosen depending on vehicle speed and driving conditions
D1	1st gear is set

A lower shift range will provide greater engine braking forces than a higher shift range.

FarmaSOS.com

Selecting gears in the M position

To enter M mode, shift the shift lever to M. Gears can then be selected by operating the shift lever or paddle shift switches, allowing you to drive in the gear of your choice.

① Upshifting

② Downshifting

The gear changes once every time the shift lever or paddle shift switch is operated.

The selected gear, from M1 to M6, will be fixed and displayed in the meter.

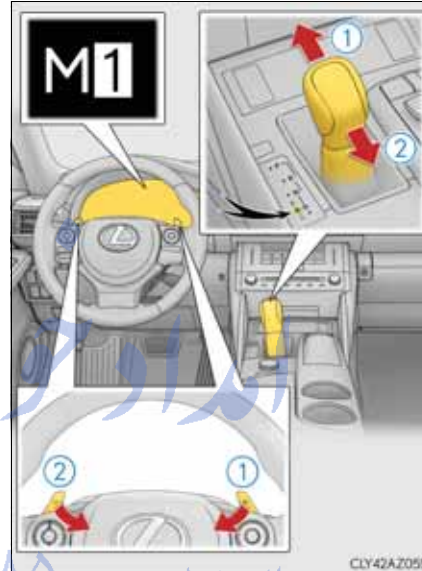

When in the M position, the gear will not change unless the shift lever or paddle shift switches are operated.

However, even when in the M position, the gears will be automatically changed in the following situation:

- When vehicle speed drops (downshift only).
- When the automatic transmission fluid or engine coolant temperature is low.
- When automatic transmission fluid temperature is high.
- When the needle of the tachometer is in the red zone (the range which exceeds the allowable revs of the engine).

In the following situations, the gear will not shift even if the shift lever or paddle shift switches are operated.

- “1st Gear not available due to slippery road surface” is displayed on the multi information display.
- The vehicle speed is low (upshift only).

Gear Shift Indicator (if equipped)

The Gear Shift Indicator display is a guide to help the driver achieve improved fuel economy and reduced exhaust emissions within limits of engine performance.

- ① When not in operation
- ② Shift-up indicator

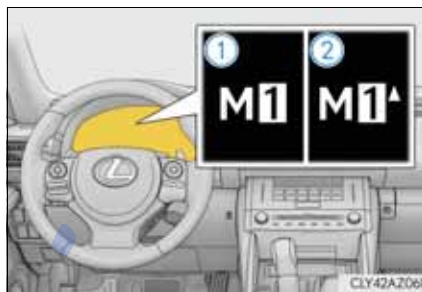

- Gear Shift Indicator function
 - This function automatically operates during M mode.
 - By following the Shift-up indicator and shifting up accordingly, it is possible to achieve improved fuel economy and reduced exhaust emissions.
 - The Gear Shift Indicator does not have a similar function for down-shifting.
 - Depending on the driving conditions, the Gear Shift Indicator may not display the Shift-up indicator while driving in M mode.

- When the “-” paddle shift switch is operated with the shift lever in the D position
A shift range will be automatically selected. The highest gear of the first shift range will be one gear lower than the gear in use during normal D position driving.
- Automatic deactivation of shift range selection in the D position
Shift range selection in the D position will be deactivated in the following situations:
 - When the vehicle comes to a stop
 - If the accelerator pedal is depressed for more than a certain period of time
 - When the shift lever is shifted to a position other than D
- To protect the automatic transmission
“Transmission Fluid High Temperature” is displayed on the multi-information display and a function is adopted that automatically selects a higher shift range when the fluid temperature is high. Have the vehicle inspected by any authorized Lexus dealer or repairer, or another duly qualified and equipped professional.

- Downshifting restriction warning buzzer

To help ensure safety and driving performance, downshifting operation may sometimes be restricted. In some circumstances, downshifting may not be possible even when the shift lever or paddle shift switch is operated. (A buzzer will sound twice.)

- Snow mode automatic deactivation

Snow mode is automatically deactivated if the engine switch is turned off after driving in snow mode.

- Multi-information display

When the shift lever is shifted to the M position, the current gear position is displayed on the multi-information display.



- When driving with cruise control or dynamic radar cruise control activated

Even when performing the following actions with the intent of enabling engine braking, engine braking will not activate because cruise control or dynamic radar cruise control will not be canceled.

- While driving in the D position, downshifting to 5 or 4. (→P. 223, 227)
- When switching the driving mode to sport mode while driving in D position. (→P. 261)

- If the shift lever cannot be shifted from P →P. 522

- AI-SHIFT

The AI-SHIFT automatically selects the suitable gear according to driver performance and driving conditions.

The AI-SHIFT automatically operates when the shift lever is in D. (Shifting the shift lever to the M position cancels the function.)

⚠ CAUTION

- When driving on slippery road surfaces

Be careful of downshifting and sudden acceleration, as this could result in the vehicle skidding to the side or spinning.

Turn signal lever

Operating instructions

The lever will return to its original position immediately after operation.

- ① Right turn
- ② Lane change to the right (move the lever partway and release it)
The right hand signals will flash 3 times.
- ③ Lane change to the left (move the lever partway and release it)
The left hand signals will flash 3 times.
- ④ Left turn

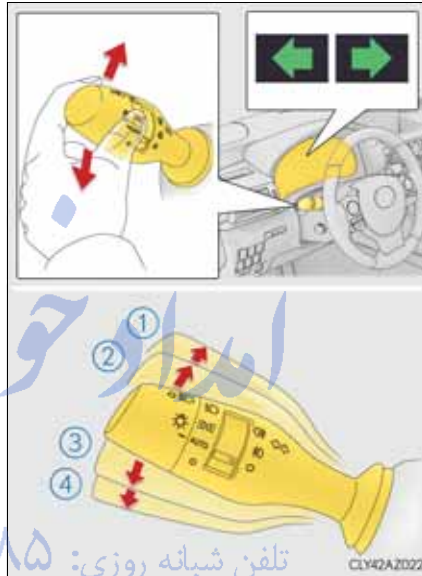

- If the turn signals do not stop flashing after turning left or right, or if you want to stop them flashing

Operate the lever in the opposite direction to either position ② or ③.
If you move the lever to either position ① or ④, the selected turn signals will flash.

- Turn signals can be operated when
The engine switch is in IGNITION ON mode.
- If the indicator flashes faster than usual
Check that a light bulb in the front or rear turn signal lights has not burned out.
- If the turn signals stop flashing before a lane change has been performed
Operate the lever again.
- Customization
The number of times the turn signals flash during a lane change can be changed.
(Customizable feature →P. 549)

امداد خودرو فارما

تلفن شبانه روزی: ۰۸۵-۸۸۸۶۲۰۲۱

FarmaSOS.com

Parking brake

Operating instructions

To set the parking brake, fully depress the parking brake pedal with your left foot while depressing the brake pedal with your right foot. (Depressing the pedal again releases the parking brake.)

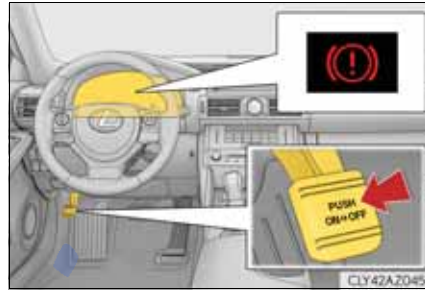

- Parking brake engaged warning buzzer
→P. 484
- Usage in winter time
→P. 286

NOTICE

- Before driving
Fully release the parking brake.
Driving the vehicle with the parking brake set will lead to brake components overheating, which may affect braking performance and increase brake wear.

Headlight switch

The headlights can be operated manually or automatically.

Operating instructions

Turning the end of the lever turns on the lights as follows:

- ① ☹️ The front position, tail, license plate and instrument panel lights turn on.
- ② ☹️ The headlights and all lights listed above turn on.
- ③ AUTO The headlights, daytime running lights and all the lights listed above turn on and off automatically.
(When the engine switch is in IGNITION ON mode.)
- ④ ○ The daytime running lights turn on.

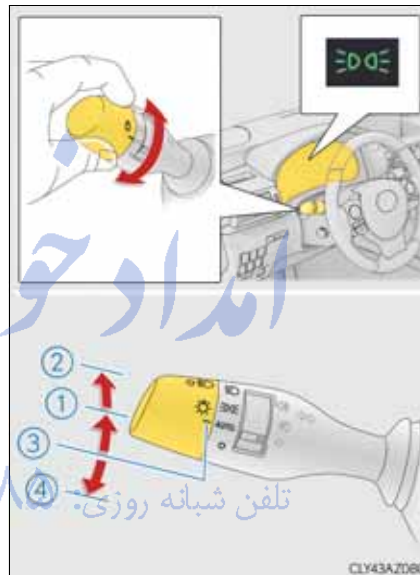

Turning on the high beam headlights

- ① With the headlights on, push the lever away from you to turn on the high beams.

Pull the lever toward you to the center position to turn the high beams off.

- ② Pull the lever toward you and release it to flash the high beams once.

You can flash the high beams with the headlights on or off.

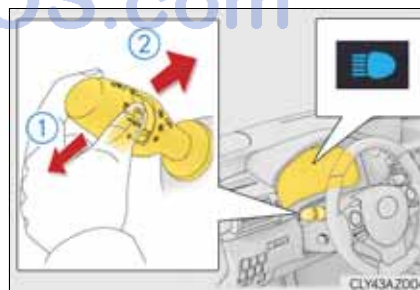

Follow me home system

This system allows the headlights and front position lights to be turned on for 30 seconds when the engine switch is off.

Pull the lever toward you and release it with the light switch is in **AUTO** or **⊖** after turning the engine switch off.

Pull the lever toward you and release it again to turn off the lights.

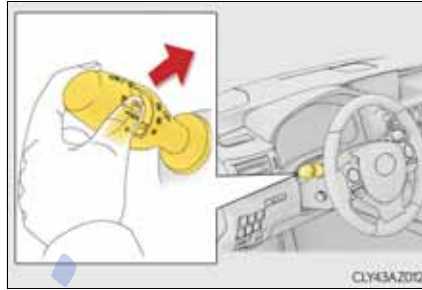

Daytime running light system

To make your vehicle more visible to other drivers, the front position lights turn on automatically (at an increased intensity) whenever the engine is started and the parking brake is released. Daytime running lights are not designed for use at night.

Headlight control sensor

The sensor may not function properly if an object is placed on the sensor, or anything that blocks the sensor is affixed to the windshield.

Doing so interferes with the sensor detecting the level of ambient light and may cause the automatic headlight system to malfunction.



Automatic light off system

- When the light switch is in **⊖** or **⊕**: The headlights and front fog lights turn off automatically if the engine switch is turned to **ACCESSORY** mode or turned off.

- When the light switch is in **AUTO**: The headlights and all lights turn off automatically if the engine switch is turned to **ACCESSORY** mode or turned off.

To turn the lights on again, turn the engine switch to **IGNITION ON** mode, or turn the light switch off once and then back to **⊖** or **⊕**.

If any of the doors or trunk lid is left open, the lights automatically turn off after 20 minutes.

- Light reminder buzzer
A buzzer sounds when the engine switch is turned off or turned to ACCESSORY mode and the driver's door is opened while the lights are turned on.
- Automatic headlight leveling system
The level of the headlights is automatically adjusted according to the number of passengers and the loading condition of the vehicle to ensure that the headlights do not interfere with other road users.
- Operation guide display (vehicles with rain-sensing windshield wipers only)
When the headlight switch is operated to and from the "AUTO" position, the current status is displayed on the meters for a few seconds to show that AUTO mode is activated/deactivated. (→P. 103)
- Customization
Settings (e.g. light sensor sensitivity) can be changed.
(Customizable features: →P. 555)

 NOTICE

- To prevent battery discharge
Do not leave the lights on longer than necessary when the engine is not running.

تلفن شبانه روزی: ۰۲۱-۸۸۸۶۲۰۸۵

FarmaSOS.com

Automatic High Beam*

The Automatic High Beam uses an in-vehicle camera sensor to assess the brightness of streetlights, the lights of oncoming and preceding vehicles, etc., and automatically turns the high beam on or off as necessary.

Activating the Automatic High Beam system

- 1 Push the lever away from you with the headlight switch in the AUTO or  position.

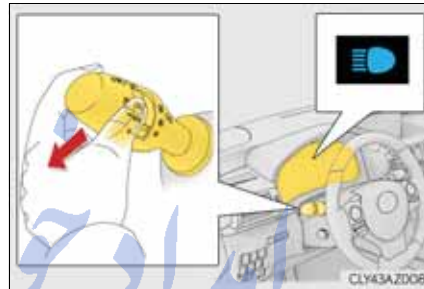

- 2 Press the Automatic High Beam switch.

The Automatic High Beam indicator will come on when the headlights are turned on automatically to indicate that the system is active.



FarmaSOS.com

*: If equipped

High beam automatic turning on or off conditions

When all of the following conditions are met, the high beam will be automatically turned on (after approximately 1 second):

- Vehicle speed is above approximately 40 km/h (25 mph).
- The area ahead of the vehicle is dark.
- There are no oncoming or preceding vehicles with headlights or tail lights turned on.
- There are few streetlights on the road ahead.

If any of the following conditions are met, the high beam will be automatically turned off:

- Vehicle speed drops below approximately 30 km/h (19 mph).
- The area ahead of the vehicle is not dark.
- Oncoming or preceding vehicles have headlights or tail lights turned on.
- There are many streetlights on the road ahead.

Turning the high beam on/off manually

■ Switching to low beam

Pull the lever to the original position.

The Automatic High Beam indicator will turn off.

Push the lever away from you to activate the Automatic High Beam system again.



■ Switching to high beam

Press the Automatic High Beam switch.

The Automatic High Beam indicator will turn off and the high beam indicator will turn on.

Press the switch to activate the Automatic High Beam system again.

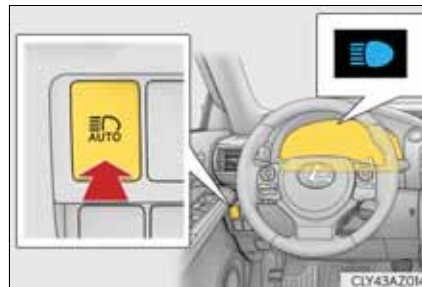

- The Automatic High Beam can be operated when
The engine switch is in IGNITION ON mode.
- Camera sensor detection information
 - High beam may not be automatically turned off in the following situations:
 - When oncoming vehicles suddenly appear from a curve
 - When the vehicle is cut in front of by another vehicle
 - When oncoming or preceding vehicles are hidden from sight due to repeated curves, road dividers or roadside trees
 - High beam may be turned off if an oncoming vehicle that is using fog lights without using the headlights is detected.
 - House lights, street lights, red traffic signals, and illuminated billboards or signs may cause the high beam to turn off.
 - The following factors may affect the amount of time taken to turn high beam on or off:
 - The brightness of headlights, fog lights, and tail lights of oncoming and preceding vehicles
 - The movement and direction of oncoming and preceding vehicles
 - When an oncoming or preceding vehicle only has operational lights on one side
 - When an oncoming or preceding vehicle is a two-wheeled vehicle
 - The condition of the road (gradient, curve, condition of the road surface etc.)
 - The number of passengers and amount of luggage
 - High beam may be turned on or off when unexpected by the driver.
 - Small vehicles, such as bicycles, may not be detected.
 - In the situations below, the system may not be able to correctly detect the surrounding brightness levels, and may flash or expose nearby pedestrians to the high beam. Therefore, you should consider turning the high beams on or off manually rather than relying on the Automatic High Beam system.
 - In bad weather (rain, snow, fog, sandstorms etc.)
 - The windshield is obscured by fog, mist, ice, dirt etc.
 - The windshield is cracked or damaged.
 - The camera sensor is deformed or dirty.
 - Surrounding brightness levels are equal to those of headlights, tail lights or fog lights.
 - Vehicles ahead have headlights or tail lights that are either switched off, dirty, changing color, or have improperly adjusted aim.
 - When driving through an area of intermittently changing brightness and darkness.
 - When frequently and repeatedly driving ascending/descending roads, or roads with rough, bumpy or uneven surfaces (such as stone-paved roads, gravel tracks etc.).
 - When frequently and repeatedly taking curves or driving on a winding road.
 - There is a highly reflective object ahead of the vehicle, such as a sign or a mirror.
 - The vehicle's headlights are damaged or dirty.
 - The vehicle is listing or titling, due to a flat tire, a trailer being towed etc.
 - The driver believes that the high beam may be causing problems or distress to other drivers or pedestrians nearby.

- The vehicle is used in a territory in which vehicles travel on the opposite side of the road of the country for which the vehicle is approved, for example using a vehicle designed for right-hand traffic in a left-hand traffic territory, or vice versa.

⚠ CAUTION

■ Limitations of the Automatic High Beam

Do not rely on the Automatic High Beam. Always drive safely, taking care to observe your surroundings and turning high beam on or off manually if necessary.

⚠ NOTICE

■ Notes when using the Automatic High Beam system

Observe the following to ensure that the Automatic High Beam functions correctly.



- Do not touch the camera sensor.
- Do not subject the camera sensor to a strong impact.
- Do not disassemble the camera sensor.
- Do not spill liquid onto the camera sensor.
- Do not apply window tinting or stickers to the camera sensor or the area of windshield near the camera sensor.
- Do not place items on the dashboard. There is a possibility that the camera sensor will mistake items reflected in the windshield for streetlights, the headlights of other vehicles, etc.
- Do not install a parking tag or any other accessories near or around the camera sensor.
- Do not overload the vehicle.
- Do not modify the vehicle.
- Do not replace windshield with non-genuine windshield.
Contact any authorized Lexus dealer or repairer, or another duly qualified and equipped professional.

Fog light switch

The fog lights secure excellent visibility in difficult driving conditions, such as in rain and fog.

► Front and rear fog light switch

- ① ○ Turns the front and rear fog lights off
- ② ㊦ Turns the front fog lights on
- ③ ㊧ Turns both front and rear fog lights on

Releasing the switch ring returns it to ㊦.

Operating the switch ring again turns only the rear fog light off.

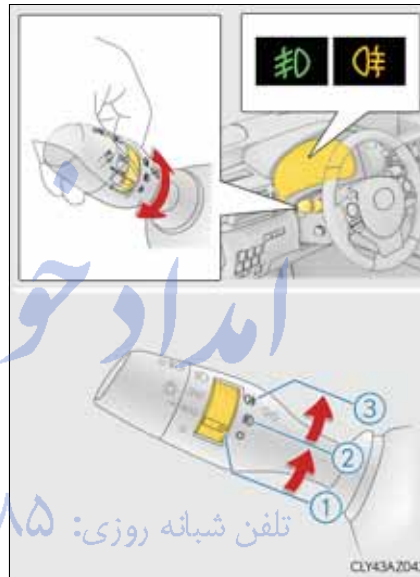

► Rear fog light switch

- ① ○ Turns the rear fog light off
- ② ㊧ Turns the rear fog light on

Releasing the switch ring returns it to ○.

Operating the switch ring again turns only the rear fog light off.

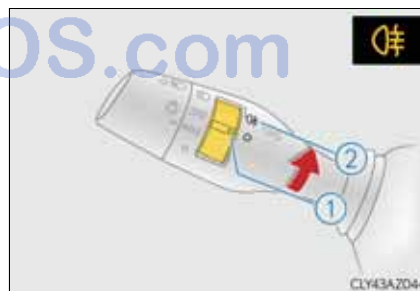

- Fog lights can be used when
 - ▶ Vehicles with a front and rear fog light switch
Front fog lights: The headlights or the front position lights are turned on.
Rear fog light: The front fog lights are turned on.
 - ▶ Vehicles with a rear fog light switch
The headlights or the front position lights are turned on.
- Operation guide display (vehicles with rain-sensing windshield wipers only)
When the fog light switch is operated, the current status is displayed on the meters for a few seconds. (→P. 103)

امداد خودرو فارما

تلفن شبانه روزی: ۰۲۱-۸۸۸۶۲۰۸۵

FarmaSOS.com

Windshield wipers and washer

Operating the wiper lever

Operate the lever as follows to operate the wipers. The lever will return to its original position immediately after operation.

► Intermittent windshield wipers with interval adjuster

- ① ○ Move the lever up by 2 levels
- ② △ Move the lever up by 1 level
- ③ ▽ Move the lever down by 1 level
- ④ ≡ Move the lever down by 2 levels



Operation Status before operation	○	△	▽	≡
Off	Temporary operation	Temporary operation	Intermittent operation	High speed operation
Intermittent operation	Off	Off	Low speed operation	High speed operation
Low speed operation	Off	Intermittent operation	High speed operation	High speed operation
High speed operation	Off	Low speed operation	No change	No change

Wiper intervals can be adjusted when intermittent operation is selected.

- ⑤ Increases the intermittent windshield wiper frequency
- ⑥ Decreases the intermittent windshield wiper frequency



- ⑦ Washer/wiper dual operation

The wipers will automatically operate a couple of times after the washer squirts.

When the headlights are on and the lever is pulled and held, the headlight cleaners will operate once. After this, the headlight cleaners will operate every 5th time the lever is pulled.

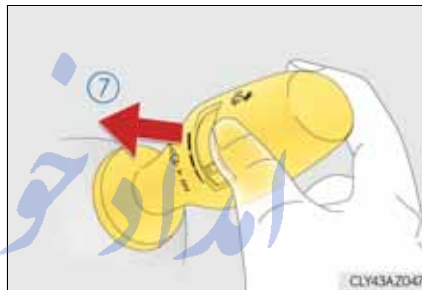

تلفن شبانه روزی: ۰۲۱-۸۸۸۶۲۰۸۵

FarmaSOS.com

► Rain-sensing windshield wipers

- ① ○ Move the lever up by 2 levels
- ② △ Move the lever up by 1 level
- ③ ▽ Move the lever down by 1 level
- ④ ≡ Move the lever down by 2 levels
- ⑤  AUTO AUTO mode on/off switch

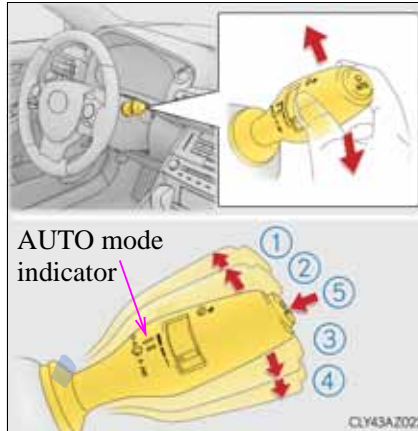

With AUTO mode selected, the wipers will operate automatically when the sensor detects falling rain. The system automatically adjusts wiper timing in accordance with rain volume and vehicle speed.

The AUTO mode indicator will turn on when AUTO mode is selected.

Status before operation \ Operation		Operation			
		○	△	▽	≡
Off		Temporary operation	Temporary operation	Low speed operation	High speed operation
Low speed operation		Off	Off	High speed operation	High speed operation
High speed operation		Off	Low speed operation	No change	No change
AUTO mode	Intermittent operation	Off	Temporary operation*1	Low speed operation*2	High speed operation*2
	Continuously		No change		

*1: After temporary operation, the mode will return to AUTO mode.

*2: AUTO mode will be canceled.

When AUTO mode is selected, the sensor sensitivity can be adjusted by turning the switch ring.

- ⑥ Increases the sensitivity
- ⑦ Decreases the sensitivity



- ⑧ Washer/wiper dual operation

The wipers will automatically operate a couple of times after the washer squirts.

When the headlights are on and the lever is pulled and held, the headlight cleaners will operate once. After this, the headlight cleaners will operate every 5th time the lever is pulled.

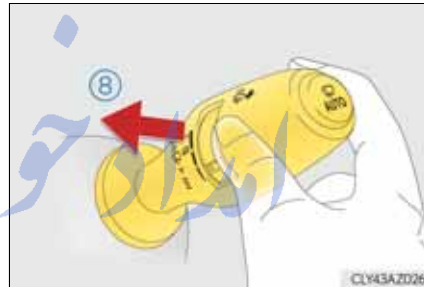

Switching between the intermittent windshield wipers and rain-sensing windshield wipers (vehicles with rain-sensing windshield wipers)

The wipers can be used as intermittent windshield wipers, which operate regardless of vehicle speed or amount of raindrops. The intermittent windshield wiper operation can be switched when the vehicle is stopped and the wiper is off. The wiper operation cannot be switched during AUTO mode or while the intermittent windshield wipers are operating.

Press and hold  until the AUTO mode indicator stops flashing.

If  is pressed and held until the AUTO mode indicator stops flashing again, it will return to its previous state.

The wiper can be switched when the vehicle is stopped and the wipers are off.



- The windshield wiper and washer can be operated when
The engine switch is in IGNITION ON mode.
 - Dripping prevention wiper sweep
After performing a washing and wiping operation several times, the wipers operate one more time after a short delay to prevent dripping.
However, the last sweep will not happen if the vehicle is traveling above 170 km/h (106 mph).
 - Effects of vehicle speed on wiper operation (vehicles with rain-sensing windshield wipers)
Vehicle speed affects the following even when the wipers are not in AUTO mode.
 - Intermittent wiper interval
 - Wiper operation when the washer is being used (delay until drip prevention wiper sweep occurs)
 With low speed windshield wiper operation selected, wiper operation will be switched from low speed to intermittent wiper operation only when the vehicle is stationary.
 - Raindrop sensor (vehicles with rain-sensing windshield wipers)
 - The raindrop sensor judges the amount of raindrops.
An optical sensor is adopted. It may not operate properly when sunlight from the rising or setting of the sun intermittently strikes the windshield, or if bugs etc. are present on the windshield.
-
- If the wiper is turned to AUTO mode while the engine switch is in IGNITION ON mode, the wipers will operate once to show that AUTO mode is activated.
 - If the temperature of the raindrop sensor is 85°C (185°F) or higher, or -30°C (-22°F) or lower, automatic operation may not occur. In this case, operate the wipers in any mode other than AUTO mode.
- When the windshield wipers are in temporary operation (vehicles with rain-sensing windshield wipers)
AUTO mode cannot be activated even if  is pressed.
 - If no windshield washer fluid sprays
Check that the washer nozzles are not blocked if there is washer fluid in the windshield washer fluid reservoir.
 - Operation guide display (vehicles with rain-sensing windshield wipers only)
When the windshield wiper switch is operated to activate AUTO mode or when the rain-sensing level is adjusted, the current status is displayed on the meters for a few seconds. (→P. 103)

 CAUTION

■ Caution regarding the use of windshield wipers in AUTO mode

The windshield wipers may operate unexpectedly if the sensor is touched or the windshield is subject to vibration in AUTO mode. Take care that your fingers or anything else do not become caught in the windshield wipers.

■ Caution regarding the use of washer fluid

When it is cold, do not use the washer fluid until the windshield becomes warm. The fluid may freeze on the windshield and cause low visibility. This may lead to an accident, resulting in death or serious injury.

 NOTICE

■ When the windshield is dry

Do not use the wipers, as they may damage the windshield.

■ When there is no washer fluid spray from the nozzle

Damage to the washer fluid pump may be caused if the lever is pulled toward you and held continually.

■ When a nozzle becomes blocked

In this case, contact any authorized Lexus dealer or repairer, or another duly qualified and equipped professional.

Do not try to clear it with a pin or other object. The nozzle will be damaged.

تلفن شبانه روزی: ۰۲۱-۸۸۶۲۰۸۵

FarmaSOS.com

Opening the fuel tank cap

Perform the following steps to open the fuel tank cap:

Before refueling the vehicle

- Close all the doors and windows, and turn the engine switch off.
- Confirm the type of fuel.

■ Fuel types

EU area:

Unleaded gasoline conforming to European standard EN228, Research Octane Number of 95 or higher

Except EU area:

Unleaded gasoline, Research Octane Number of 95 or higher

■ Use of ethanol blended gasoline in a gasoline engine

Lexus allows the use of ethanol blended gasoline where the ethanol content is up to 10%. Make sure that the ethanol blended gasoline to be used has a Research Octane Number that follows the above.

تلفن شبانه روزی: ۰۲۱-۸۸۶۲۰۸۵

FarmaSOS.com

 CAUTION

■ When refueling the vehicle

Observe the following precautions while refueling the vehicle. Failure to do so may result in death or serious injury.

- After exiting the vehicle and before opening the fuel door, touch an unpainted metal surface to discharge any static electricity. It is important to discharge static electricity before refueling because sparks resulting from static electricity can cause fuel vapors to ignite while refueling.
- Always hold the grips on the fuel tank cap and turn it slowly to remove it. A whooshing sound may be heard when the fuel tank cap is loosened. Wait until the sound cannot be heard before fully removing the cap. In hot weather, pressurized fuel may spray out the filler neck and cause injury.
- Do not allow anyone that has not discharged static electricity from their body to come close to an open fuel tank.
- Do not inhale vaporized fuel. Fuel contains substances that are harmful if inhaled.
- Do not smoke while refueling the vehicle. Doing so may cause the fuel to ignite and cause a fire.
- Do not return to the vehicle or touch any person or object that is statically charged. This may cause static electricity to build up, resulting in a possible ignition hazard.

■ When refueling

Observe the following precautions to prevent fuel overflowing from the fuel tank:

- Securely insert the fuel nozzle into the fuel filler neck.
- Stop filling the tank after the fuel nozzle automatically clicks off.
- Do not top off the fuel tank.

 NOTICE

■ Refueling

Do not spill fuel during refueling.

Doing so may damage the vehicle, such as causing the emission control system to operate abnormally or damaging fuel system components or the vehicle's painted surface.

Opening the fuel tank cap

- 1 With the doors unlocked, press the center of the rear edge of the fuel filler door.

Push until you hear a click and take your hand away to slightly open the fuel filler door. Then open the door fully by hand.



- 2 Turn the fuel tank cap slowly to remove it and put it into the holder on the fuel filler door.

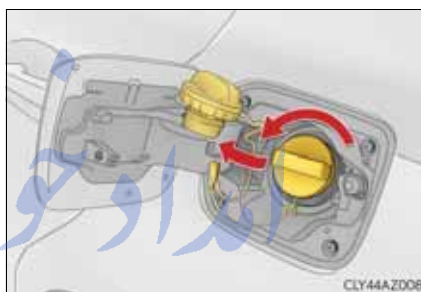

- If the fuel filler door cannot be opened
Remove the cover inside the trunk and pull the lever to open the fuel filler door if the fuel filler door cannot be opened by pressing the rear edge of the fuel filler door.

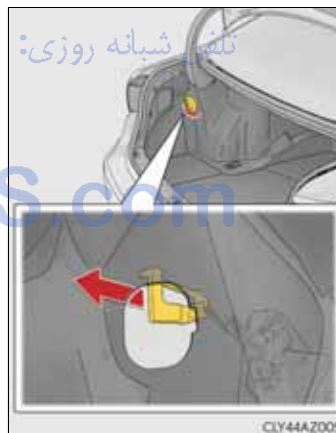

Closing the fuel tank cap

- 1 After refueling, turn the fuel tank cap until you hear a click. Once the cap is released, it will turn slightly in the opposite direction.

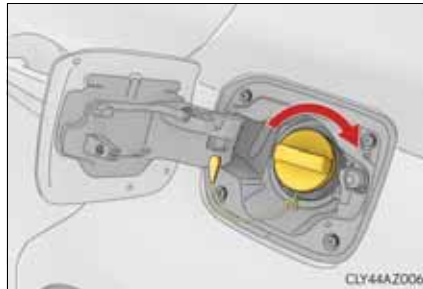

- 2 Close the fuel filler door, and press the center of the rear edge of the fuel filler door until you hear a click.

When you lock the doors, the fuel filler door will also lock.



■ Fuel filler door lock condition

The fuel filler door may not be locked even when the vehicle's doors are locked in the following situations:

- When operating the door lock button inside the vehicle
- When the automatic door locking system is operated (→P. 122)
- When the fuel filler door is closed after the vehicle's doors are locked

⚠ CAUTION

■ When replacing the fuel tank cap

Do not use anything but a genuine Lexus fuel tank cap designed for your vehicle. Doing so may cause a fire or other incident which may result in death or serious injury.

Cruise control*

Summary of functions

Use the cruise control to maintain a set speed without depressing the accelerator pedal.

- ① Indicators
- ② Cruise control switch

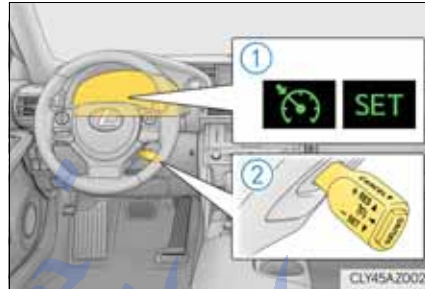

Setting the vehicle speed

- 1 Press the “ON/OFF” button to activate the cruise control.
Cruise control indicator will come on.
Press the button again to deactivate the cruise control.



- 2 Accelerate or decelerate the vehicle to the desired speed, and push the lever down to set the speed.
“SET” indicator will come on.
The vehicle speed at the moment the lever is released becomes the set speed.

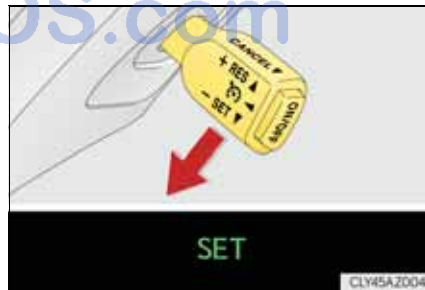

*: If equipped

Adjusting the set speed

To change the set speed, operate the lever until the desired set speed is obtained.

- ① Increases the speed
- ② Decreases the speed

Fine adjustment: Momentarily move the lever in the desired direction.

Large adjustment: Hold the lever in the desired direction.



The set speed will be increased or decreased as follows:

Fine adjustment: By approximately 1.6 km/h (1 mph) each time the lever is operated.

Large adjustment: The set speed can be increased or decreased continually until the lever is released.

Canceling and resuming the constant speed control

- ① Pulling the lever toward you cancels the constant speed control.
The speed setting is also canceled when the brakes are applied.
- ② Pushing the lever up resumes the constant speed control.

Resuming is available when the vehicle speed is more than approximately 40 km/h (25 mph).

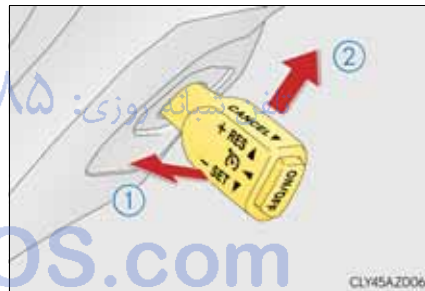

- Cruise control can be set when
 - The shift lever is in D.
 - Range 4 or higher of D has been selected by using the paddle shift.
 - Vehicle speed is above approximately 40 km/h (25 mph).
- Accelerating after setting the vehicle speed
 - The vehicle can be accelerated normally. After acceleration, the set speed resumes.
 - Even without canceling the cruise control, the set speed can be increased by first accelerating the vehicle to the desired speed and then pushing the lever down to set the new speed.
- Automatic cruise control cancelation

Cruise control will stop maintaining the vehicle speed in any of the following situations.

 - Actual vehicle speed falls more than approximately 16 km/h (10 mph) below the preset vehicle speed.
At this time, the memorized set speed is not retained.
 - Actual vehicle speed is below approximately 40 km/h (25 mph).
 - VSC is activated.
 - TRC is activated for a period of time.
 - When the VSC or TRC system is turned off by pressing the VSC OFF switch.
- If the warning message for the cruise control is shown on the multi-information display

Press the “ON/OFF” button once to deactivate the system, and then press the button again to reactivate the system.

If the cruise control speed cannot be set or if the cruise control cancels immediately after being activated, there may be a malfunction in the cruise control system. Have the vehicle inspected by any authorized Lexus dealer or repairer, or another duly qualified and equipped professional.

**CAUTION**

- To avoid operating the cruise control by mistake
Switch the cruise control off using the “ON/OFF” button when not in use.
- Situations unsuitable for cruise control
Do not use cruise control in any of the following situations.
Doing so may result in loss of control and could cause an accident resulting in death or serious injury.
 - In heavy traffic
 - On roads with sharp bends
 - On winding roads
 - On slippery roads, such as those covered with rain, ice or snow
 - On steep hills
Vehicle speed may exceed the set speed when driving down a steep hill.
 - When your vehicle is towing a trailer or during emergency towing

امداد خودرو فارما

تلفن شبانه روزی: ۰۲۱-۸۸۸۶۲۰۸۵

FarmaSOS.com

Dynamic radar cruise control*

Summary of functions

Dynamic radar cruise control supplements conventional cruise control with a vehicle-to-vehicle distance control. In vehicle-to-vehicle distance control mode, the vehicle automatically accelerates or decelerates in order to maintain a set following distance from vehicles ahead.

- ① Vehicle-to-vehicle distance button
- ② Display
- ③ Set speed
- ④ Indicators
- ⑤ Cruise control switch



4

Driving

تلفن شبانه روزی: ۰۲۱-۸۸۶۲۰۸۵

FarmaSOS.com

*: If equipped

Setting the vehicle speed (vehicle-to-vehicle distance control mode)

- 1 Press the “ON/OFF” button to activate the cruise control.

Dynamic radar cruise control indicator will come on.

Press the button again to deactivate the cruise control.



- 2 Accelerate or decelerate the vehicle to the desired speed, and push the lever down to set the speed.

“SET” indicator will be displayed.

The vehicle speed at the moment the lever is released becomes the set speed.



تلفن شبانه روزی: ۰۲۱-۸۸۸۶۲۰۸۵

FarmaSOS.com

Adjusting the set speed

To change the set speed, operate the lever until the desired set speed is displayed.

- ① Increases the speed
- ② Decreases the speed

Fine adjustment: Momentarily move the lever in the desired direction.

Large adjustment: Hold the lever in the desired direction.



In the vehicle-to-vehicle distance control mode, the set speed will be increased or decreased as follows:

- When the set speed is shown in “MPH”
 - Fine adjustment: By approximately 8 km/h (5 mph) each time the lever is operated
 - Large adjustment: By approximately 8 km/h (5 mph) for each 0.3 seconds the lever is held
- When the set speed is shown in “km/h”
 - Fine adjustment: By approximately 5 km/h (3.1 mph) each time the lever is operated
 - Large adjustment: By approximately 5 km/h (3.1 mph) for each 0.3 seconds the lever is held

In the constant speed control mode (→P. 232), the set speed will be increased or decreased as follows:

Fine adjustment: By approximately 1.6 km/h (1 mph) each time the lever is operated

Large adjustment: The set speed can be increased or decreased continually until the lever is released.

Changing the vehicle-to-vehicle distance

Pressing the button changes the vehicle-to-vehicle distance as follows:

- ① Long
- ② Medium
- ③ Short

The vehicle-to-vehicle distance is set automatically to long mode when the engine switch is turned to IGNITION ON mode.

If a vehicle is running ahead of you, the preceding vehicle mark will also be displayed.

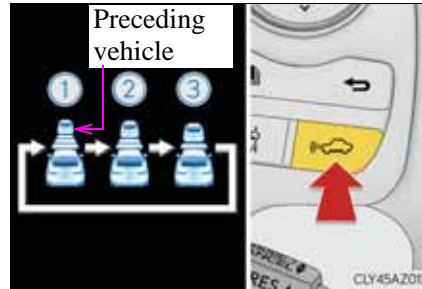

Vehicle-to-vehicle distance settings

Select a distance from the table below. Note that the distances shown correspond to a vehicle speed of 80 km/h (50 mph). Vehicle-to-vehicle distance increases/decreases in accordance with vehicle speed.

Distance options	Vehicle-to-vehicle distance
Long	Approximately 50 m (160 ft.)
Medium	Approximately 40 m (130 ft.)
Short	Approximately 30 m (100 ft.)

Canceling and resuming the speed control

- ① Pulling the lever toward you cancels the cruise control.

The speed setting is also canceled when the brakes are applied.

- ② Pushing the lever up resumes the cruise control and returns vehicle speed to the set speed.

Resuming is available when the vehicle speed is more than approximately 40 km/h (25 mph).

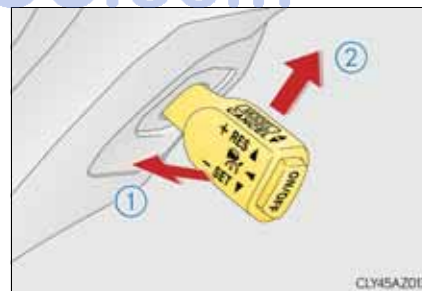

Driving in vehicle-to-vehicle distance control mode

This mode employs a radar sensor to detect the presence of vehicles up to approximately 120 m (400 ft.) ahead, determines the current vehicle-to-vehicle following distance, and operates to maintain a suitable following distance from the vehicle ahead.

Note that vehicle-to-vehicle distance will close in when traveling on long downhill slopes.

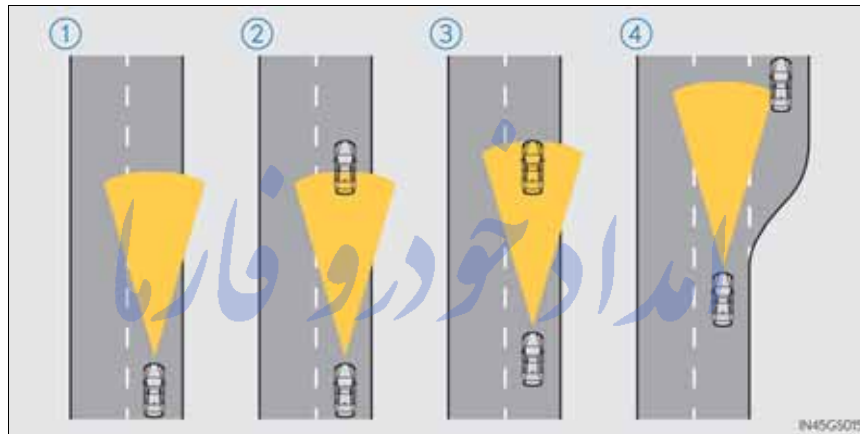

- ① **Example of constant speed cruising**
When there are no vehicles ahead
تلفن شبانه روزی: ۰۲۱-۸۸۸۸۸۸۸۸
The vehicle travels at the speed set by the driver. The desired vehicle-to-vehicle distance can also be set by operating the vehicle-to-vehicle distance control.
- ② **Example of deceleration cruising**
When the vehicle ahead is driving slower than the set speed
The system automatically decelerates your vehicle. When a greater reduction in vehicle speed is necessary, the system applies the brakes. A warning tone warns you when the system cannot decelerate sufficiently to prevent your vehicle from closing in on the vehicle ahead.
- ③ **Example of follow-up cruising**
When following a vehicle driving slower than the set speed
The system continues follow-up cruising while adjusting for changes in the speed of the vehicle ahead in order to maintain the vehicle-to-vehicle distance set by the driver.
- ④ **Example of acceleration**
When there are no longer any vehicles ahead driving slower than the set speed

The system accelerates until the set speed is reached. The system then returns to constant speed cruising.

Approach warning

When your vehicle is too close to a vehicle ahead, and sufficient automatic deceleration via the cruise control is not possible, the display will flash and the buzzer will sound to alert the driver. An example of this would be if another driver cuts in front of you while you are following a vehicle. Apply the brakes to ensure an appropriate vehicle-to-vehicle distance.

■ Warnings may not occur when

In the following instances, there is a possibility that the warnings will not occur:

- When the speed of the vehicle ahead matches or exceeds your vehicle speed
- When the vehicle ahead is traveling at an extremely slow speed
- Immediately after the cruise control speed was set
- At the instant the accelerator is applied

Selecting conventional constant speed control mode

When constant speed mode is selected, your vehicle will maintain a set speed without controlling the vehicle-to-vehicle distance. Select this mode only when vehicle-to-vehicle distance control mode does not function correctly due to dirt etc.

- ① Press the “ON/OFF” button to activate the cruise control.

Press the button again to deactivate the cruise control.

- ② Switch to constant speed control mode.

(Push the lever forward and hold for approximately 1 second.)

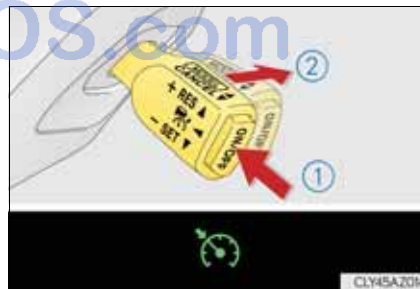

Constant speed control mode indicator will come on.

When in constant speed control mode, to return to vehicle-to-vehicle distance control mode, push the lever forward again and hold for approximately 1 second.

After the desired speed has been set, it is not possible to return to vehicle-to-vehicle distance control mode.

If the engine switch is turned off and then turned to IGNITION ON mode again, the vehicle will automatically return to vehicle-to-vehicle distance control mode.

Adjusting the speed setting: →P. 224

Canceling and resuming the speed setting: →P. 224

امداد خودرو فارما

تلفن شبانه روزی: ۰۲۱-۸۸۸۶۲۰۸۵

FarmaSOS.com

- Dynamic radar cruise control can be set when
 - The shift lever is in D.
 - Range 4 or higher of D has been selected by using the paddle shift.
 - Vehicle speed is above approximately 50 km/h (30 mph).
- Accelerating after setting the vehicle speed

The vehicle can accelerate normally. After acceleration, the set speed resumes. However, during vehicle-to-vehicle distance control mode, the vehicle speed may decrease below the set speed in order to maintain the distance to the vehicle ahead.
- Automatic cancelation of vehicle-to-vehicle distance control

Vehicle-to-vehicle distance control driving is automatically canceled in the following situations:

 - Actual vehicle speed falls below approximately 40 km/h (25 mph).
 - VSC is activated.
 - TRC is activated for a period of time.
 - When the VSC or TRC system is turned off by pressing the VSC OFF switch.
 - The sensor cannot operate correctly because it is covered in some way.
 - The windshield wipers are operating at high speed (when the wipers are in AUTO mode or the high speed wiper operation).
 - When snow mode is set.
 - Pre-crash braking is activated.

If vehicle-to-vehicle distance control driving is automatically canceled for any other reason, there may be a malfunction in the system. Contact any authorized Lexus dealer or repairer, or another duly qualified and equipped professional.
- Automatic cancelation of constant speed control

The cruise control will stop maintaining the vehicle speed in the following situations:

 - Actual vehicle speed is more than approximately 16 km/h (10 mph) below the set vehicle speed.
At this time, the memorized set speed is not retained.
 - Vehicle speed falls below approximately 40 km/h (25 mph).
 - VSC is activated.
 - TRC is activated for a period of time.
 - When the VSC or TRC system is turned off by pressing the VSC OFF switch.
 - Pre-crash braking is activated.

■ Radar sensor and grille cover

Always keep the sensor and grille cover clean to ensure that the vehicle-to-vehicle distance control operates properly. (Some obstructions, such as snow, ice and plastic objects, cannot be detected by the obstruction sensor.)

Dynamic radar cruise control is canceled if an obstruction is detected.

- ① Grille cover
- ② Radar sensor

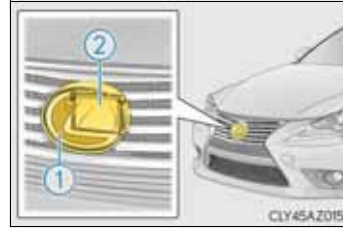
**■ Operation guide display**

When the dynamic radar cruise control switch is operated, a guidance display is shown on the meters for a few seconds as to how to operate the dynamic radar cruise control switch or distance switch. (→P. 103)

■ Warning messages and buzzers for dynamic radar cruise control

Warning messages and buzzers are used to indicate a system malfunction or to inform the driver of the need for caution while driving. (→P. 485)

تلفن شبانه روزی: ۰۲۱-۸۸۶۲۰۸۵

FarmaSOS.com

■ Certification

CE 1731

The latest "DECLARATION of CONFORMITY"(DoC) is available at the following:
DoC address: FUJITSU TEN LIMITED
2-28, Goshō-dori 1-chome, Hyogo-ku, Kobe, 652-8510, Japan

<p>С настоящето, FUJITSU TEN LIMITED, декларира, че FT0041A е в съответствие със съществените изисквания и другите приложими разпоредби на Директива 1999/5/EC.</p>
<p>FUJITSU TEN LIMITED tímto prohlašuje, že tento FT0041A je ve shodě se základními požadavky a dalšími příslušnými ustanoveními směrnice 1999/5/ES.</p>
<p>Undertegnede FUJITSU TEN LIMITED erklærer herved, at følgende udstyr FT0041A overholder de væsentlige krav og øvrige relevante krav i direktiv 1999/5/EF.</p>
<p>Hiermit erklärt FUJITSU TEN LIMITED, dass sich das Gerät FT0041A in Übereinstimmung mit den grundlegenden Anforderungen und den übrigen einschlägigen Bestimmungen der Richtlinie 1999/5/EG befindet.</p>
<p>Käesolevaga kinnitab FUJITSU TEN LIMITED seadme FT0041A vastavust direktiivi 1999/5/EÜ põhinõuetele ja nimetatud direktiivist tulenevatele teistele asjakohastele sätetele.</p>
<p>Hereby, FUJITSU TEN LIMITED, declares that this FT0041A is in compliance with the essential requirements and other relevant provisions of Directive 1999/5/EC.</p>
<p>Por medio de la presente FUJITSU TEN LIMITED declara que el FT0041A cumple con los requisitos esenciales y cualesquiera otras disposiciones aplicables o exigibles de la Directiva 1999/5/CE.</p>
<p>ΜΕ ΤΗΝ ΠΑΡΟΥΣΑ FUJITSU TEN LIMITED ΔΗΛΩΝΕΙ ΟΤΙ FT0041A ΣΥΜΜΟΡΦΩΝΕΤΑΙ ΠΡΟΣ ΤΙΣ ΟΥΣΙΩΔΕΙΣ ΑΠΑΙΤΗΣΕΙΣ ΚΑΙ ΤΙΣ ΛΟΙΠΕΣ ΣΧΕΤΙΚΕΣ ΔΙΑΤΑΞΕΙΣ ΤΗΣ ΟΔΗΓΙΑΣ 1999/5/ΕΚ.</p>
<p>Par la présente FUJITSU TEN LIMITED déclare que l'appareil FT0041A est conforme aux exigences essentielles et aux autres dispositions pertinentes de la directive 1999/5/CE.</p>
<p>Con la presente FUJITSU TEN LIMITED dichiara che questo FT0041A è conforme ai requisiti essenziali ed alle altre disposizioni pertinenti stabilite dalla direttiva 1999/5/CE.</p>
<p>Ar šo FUJITSU TEN LIMITED deklarē, ka FT0041A atbilst Direktīvas 1999/5/EK būtiskajām prasībām un citiem ar to saistītajiem noteikumiem.</p>
<p>Šiuo FUJITSU TEN LIMITED deklaruoja, kad šis FT0041A atitinka esminius reikalavimus ir kitas 1999/5/EB Direktyvos nuostatas.</p>
<p>Hierbij verklaart FUJITSU TEN LIMITED dat het toestel FT0041A in overeenstemming is met de essentiële eisen en de andere relevante bepalingen van richtlijn 1999/5/EG.</p>

Hawnhekk, FUJITSU TEN LIMITED, jiddikjara li dan FT0041A jikkonforma mal-htigijiet essenzjali u ma provvedimenti oħrajn relevanti li hemm fid-Dirrettiva 1999/5/EC.
Alulírott, FUJITSU TEN LIMITED nyilatkozom, hogy a FT0041A megfelel a vonatkozó alapvető követelményeknek és az 1999/5/EC irányelv egyéb előírásainak.
Niniejszym FUJITSU TEN LIMITED oświadcza, że FT0041A jest zgodny z zasadniczymi wymogami oraz pozostałymi stosownymi postanowieniami Dyrektywy 1999/5/EC.
FUJITSU TEN LIMITED declara que este FT0041A está conforme com os requisitos essenciais e outras disposições da Directiva 1999/5/CE.
Prin prezenta, FUJITSU TEN LIMITED, declară că aparatul FT0041A este în conformitate cu cerințele esențiale și cu alte prevederi pertinente ale Directivei 1999/5/CE.
FUJITSU TEN LIMITED izjavlja, da je ta FT0041A v skladu z bistvenimi zahtevami in ostalimi relevantnimi določili direktive 1999/5/ES.
FUJITSU TEN LIMITED tímto vyhlasuje, že FT0041A splňuje základné požiadavky a všetky príslušné ustanovenia Smernice 1999/5/ES.
FUJITSU TEN LIMITED vakuuttaa täten että FT0041A tyyppinen laite on direktiivin 1999/5/EY oleellisten vaatimusten ja sitä koskevien direktiivin muiden ehtojen mukainen.
Härmed intygar FUJITSU TEN LIMITED att denna FT0041A står i överensstämmelse med de väsentliga egenskapskrav och övriga relevanta bestämmelser som framgår av direktiv 1999/5/EG.
Hér með lýsir FUJITSU TEN LIMITED yfir því að FT0041A er í samræmi við grunnkröfur og aðrar kröfur, sem gerðar eru í tilskipun 1999/5/EC.
FUJITSU TEN LIMITED erklærer herved at utstyret FT0041A er i samsvar med de grunnleggende krav og øvrige relevante krav i direktiv 1999/5/EF.
Ovim , FUJITSU TEN LIMITED, izjavljuje da ovaj FT0041A je usklađen sa bitnim zahtjevima i drugim relevantnim odredbama Direktive 1999/5/EC.

امداد خودرو فارما

تلفن شبانه روزی: ۰۲۱-۸۸۸۶۲۰۸۵

FarmaSOS.com

 CAUTION

امداد خودرو فارما

تلفن شبانه روزی: ۰۲۱-۸۸۸۶۲۰۸۵

FarmaSOS.com

4

Driving

■ Before using dynamic radar cruise control

Do not overly rely on vehicle-to-vehicle distance control.

Be aware of the set speed. If automatic deceleration/acceleration is not appropriate, adjust the vehicle speed, as well as the distance between your vehicle and vehicles ahead by applying the brakes etc.

■ Cautions regarding the driving assist systems

Observe the following precautions.

Failure to do so may cause an accident resulting in death or serious injury.

● Assisting the driver to measure following distance

The dynamic radar cruise control is only intended to help the driver in determining the following distance between the driver's own vehicle and a designated vehicle traveling ahead. It is not a mechanism that allows careless or inattentive driving, and it is not a system that can assist the driver in low-visibility conditions. It is still necessary for driver to pay close attention to the vehicle's surroundings.

● Assisting the driver to judge proper following distance

The dynamic radar cruise control determines whether the following distance between the driver's own vehicle and a designated vehicle traveling ahead is appropriate or not. It is not capable of making any other type of judgement. Therefore, it is absolutely necessary for the driver to remain vigilant and to determine whether or not there is a possibility of danger in any given situation.

● Assisting the driver to operate the vehicle

The dynamic radar cruise control has no capability to prevent or avoid a collision with a vehicle traveling ahead. Therefore, if there is ever any danger, the driver must take immediate and direct control of the vehicle and act appropriately in order to ensure the safety of all involved.

■ To avoid inadvertent cruise control activation

Switch the cruise control off using the "ON/OFF" button when not in use.

■ Situations unsuitable for dynamic radar cruise control

Do not use dynamic radar cruise control in any of the following situations.

Doing so may result in inappropriate speed control and could cause an accident resulting in death or serious injury.

● In heavy traffic

● On roads with sharp bends

● On winding roads

● On slippery roads, such as those covered with rain, ice or snow

● On steep downhill, or where there are sudden changes between sharp up and down gradients

Vehicle speed may exceed the set speed when driving down a steep hill.

● At entrances to expressways

● When weather conditions are bad enough that they may prevent the sensors from functioning correctly (fog, snow, sandstorm, heavy rain, etc.)

● When an approach warning buzzer is heard often

● When your vehicle is towing a trailer or during emergency towing

 CAUTION

■ When the sensor may not be correctly detecting the vehicle ahead

Apply the brakes as necessary when any of the following types of vehicles are in front of you.

As the sensor may not be able to correctly detect these types of vehicles, the approach warning (→P. 232) will not be activated, and a fatal or serious accident may result.

- Vehicles that cut in suddenly
- Vehicles traveling at low speeds
- Vehicles that are not moving
- Vehicles with small rear ends (trailers with no load on board etc.)
- Motorcycles traveling in the same lane

■ Conditions under which the vehicle-to-vehicle distance control may not function correctly

Apply the brakes as necessary in the following conditions as the radar sensor may not be able to correctly detect vehicles ahead, and a fatal or serious accident may result:

- When water or snow thrown up by the surrounding vehicles hinders the functioning of the sensor
- When your vehicle is pointing upwards (caused by a heavy load in the trunk etc.)
- When the road curves or when the lanes are narrow
- When steering wheel operation or your position in the lane is unstable
- When the vehicle ahead of you decelerates suddenly

■ Handling the radar sensor

Observe the following to ensure the cruise control system can function effectively.

Otherwise, the system may not function correctly and could result in an accident.

- Keep the sensor and grille cover clean at all times.
Clean the sensor and grille cover with a soft cloth so you do not mark or damage them.
- Do not subject the sensor or surrounding area to a strong impact.
If the sensor moves even slightly off position, the system may malfunction. If the sensor or surrounding area is subject to a strong impact, always have the area inspected and adjusted by any authorized Lexus dealer or repairer, or another duly qualified and equipped professional.
- Do not disassemble the sensor.
- Do not attach accessories or stickers to the sensor, grille cover or surrounding area.
- Do not modify or paint the sensor and grille cover.
- Do not replace them with non-genuine parts.

LDA (Lane Departure Alert)*

Summary of function

While driving on a road that has lane markers, this system recognizes the lane markers using a camera as a sensor to alert the driver when the vehicle deviates from its lane.

If the system judges that the vehicle has deviated from its lane, it alerts the driver using a buzzer and indications on the multi-information display.

Camera sensor

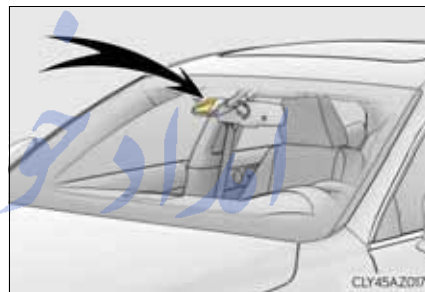

تلفن شبانه روزی: ۰۲۱-۸۸۸۶۲۰۸۵

FarmaSOS.com

*: If equipped

Turning the LDA system on

Press the LDA switch to activate the system.

The LDA indicator and lane lines will come on.

Press the switch again to turn the LDA system off.

The LDA system will remain on or off even if the engine switch is turned to IGNITION ON mode.

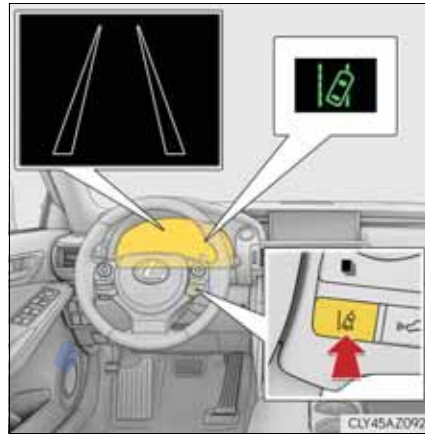

Operating conditions

- When the vehicle speed is approximately 50 km/h (32 mph) or more
- When the lane width is more than approximately 2.5 m (8.2 ft.)
- When driving on a straight road or through a curve with a radius of more than approximately 100 m (328 ft.)

4

Driving

تلفن شبانه روزی: ۰۲۱-۸۸۶۲۰۸۵

FarmaSOS.com

Indication on the multi-information display

When the inside of both lane lines turn white:

Indicates that both right and left lane markers are recognized.

If the vehicle deviates from the lane, the lane line on the side the vehicle has deviated from will flash in yellow. (→P. 482)



When the inside of either lane line turns white:

Indicates that the lane marker on the white-marked side is recognized.

If the vehicle deviates from the side of a lane with recognized lane markers, the lane line will flash in yellow. (→P. 482)

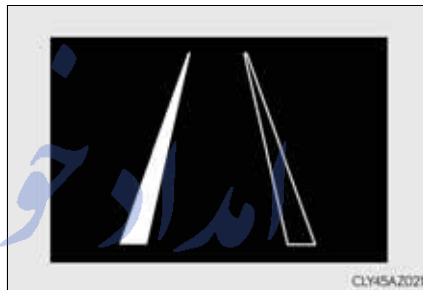

When the inside of both lane lines are black:

Indicates that no lane markers are recognized or the LDA system is temporarily canceled.



■ Temporary cancelation of the LDA system functions

If any of the following occurs, the LDA system functions will be temporarily canceled. The functions will resume after the necessary operating conditions have returned.

- The turn signal lever is operated.
- The vehicle speed deviates from the operating range of the LDA system functions.
- When the lane lines cannot be recognized while driving.
- When the lane departure warning sounds.
The lane departure warning function will not operate again for a several seconds after it has been activated, even if the vehicle leaves the lane again.

■ The lane departure warning

Depending on the audio system sound level or air conditioning fan noise while the audio system or air conditioning system is in use, it may be difficult to hear the warning sound.

■ After the vehicle has been parked in the sun

The LDA system may not be available and a warning message (→P. 485) will be displayed for a while after driving has started. When the temperature in the cabin decreases and the temperature around the camera sensor (→P. 242) becomes suitable for its operation, the functions will begin to operate.

■ If there are lane markers on only one side of the vehicle

The lane departure warning will not operate for the side on which lane markers could not be recognized.

■ Conditions in which the function may not operate correctly

In the following situations, the camera sensor may be unable to recognize lane markers causing the lane departure warning function to operate incorrectly. However, this does not indicate a malfunction.

- When driving through an area with no lane markers, such as a tollbooth, a crossing or before a ticket checkpoint
- When driving on a sharp curve
- When lane markers are extremely narrow or extremely wide
- When the vehicle leans to one side an unusual amount due to a heavy load or improper tire inflation pressure
- When the following distance between your vehicle and the vehicle ahead is extremely short
- When the lane markers are yellow (These may be more difficult for the system to recognize compared to white markers.)
- When the lane markers are broken, Botts' dots (raised pavement markers) or stones
- When the lane markers are on a curb etc.
- When lane markers are obscured or partially obscured by sand, dirt, etc.
- When there are shadows on the road running parallel with lane markers, or if a shadow covers the lane markers
- When driving on a particularly bright road surface, such as concrete

- When driving on a road surface that is bright due to reflected light
- When driving in a location where the light level changes rapidly, such as the entrance to or exit from a tunnel
- When sunlight or the headlights of oncoming vehicles are shining directly into the camera lens
- When driving on roads that are branching or merging
- When driving on a road surface that is wet due to rain, previous rainfall, standing water, etc.
- When the vehicle experiences strong up-and-down motion such as when driving on an extremely rough road or on a seam in the pavement
- When headlight brightness at nighttime is reduced due to dirt on the lenses, or when the headlights are misaligned
- When driving on winding roads or roads that are uneven
- When driving on rough or unpaved roads
- When changing the tires
Depending on the tires used, sufficient performance may not be maintainable.
- Warning messages for the LDA system
Warning messages are used to indicate a system malfunction or to inform the driver of the need for caution while driving. (→P. 485)

تلفن شبانه روزی: ۰۲۱-۸۸۸۶۲۰۸۵

FarmaSOS.com

 CAUTION**■ Before using the LDA system**

Do not rely solely on the LDA system. The LDA system does not drive the vehicle automatically, nor does it reduce the amount of care you need to take. As such, the driver must always assume full responsibility for understanding his/her surroundings, for operating the steering wheel to correct the driving line, and for driving safely.

Inappropriate or negligent driving could lead to an accident.

■ To avoid operating the LDA by mistake

Switch the LDA system off using the LDA switch when not in use.

■ Situations unsuitable for LDA system

Do not use the LDA system in any of the following situations.

Otherwise, the system may not function correctly and could result in an accident.

- When driving with tire chains, a spare tire, or similar equipment
- When there are objects or structures along the roadside that might be misinterpreted as lane markers (such as guardrails, a curb, reflector posts, etc.)
- When driving on snowy roads
- When pavement lane markers are difficult to see due to rain, snow, fog, sand dust etc.
- When there are visible lines on the pavement from road repairs, or if the remains of old lane markers are still visible on the road
- When driving on a road with lane closures due to maintenance, or when driving in a temporary lane

 NOTICE

- To prevent damage to or incorrect operation of the LDA system
 - Do not modify the headlights or attach stickers to the surface of the lights.
 - Do not modify the suspension or replace it with non-genuine parts.
 - Do not install or place anything on the hood or the grille. Also, do not install a grille guard (bull bars, kangaroo bar etc.).
 - If your windshield needs repairs, contact any authorized Lexus dealer or repairer, or another duly qualified and equipped professional.
 - Camera sensor

Observe the following to ensure that the LDA system functions correctly.

 - Keep the windshield clean at all times.
Performance could be affected if the windshield is dirty, or if raindrops, condensation or ice are adhering to the windshield.
 - Do not attach a sticker or other items to the windshield near the camera sensor.
- 
- Do not spill liquid onto the camera sensor.
 - Do not attach window tinting to the windshield.
 - Do not install an antenna in front of the camera lens.
 - If the windshield is fogged up, use the windshield defogger to remove fog from the windshield.
When it is cold, using the heater with air blowing to the feet may allow the upper part of the windshield to fog up. This will have a negative effect on the images.
 - Do not scratch the camera lens, or let it get dirty.
When cleaning the inside of the windshield, be careful not to get any glass cleaner etc. on the lens. Also, do not touch the lens.
For lens repair, contact any authorized Lexus dealer or repairer, or another duly qualified and equipped professional.
 - Do not change the installation position or direction of the camera sensor or remove it. The direction of the camera sensor is precisely adjusted.
 - Do not subject the camera sensor to strong impact or force, and do not disassemble the camera sensor.
 - Do not replace windshield with non-genuine windshield.
Contact any authorized Lexus dealer or repairer, or another duly qualified and equipped professional.

Lexus parking assist-sensor*

The distance from your vehicle to nearby obstacles when parallel parking or maneuvering into a garage is measured by the sensors and communicated via the multi-information display, Lexus Display Audio screen (if equipped) and a buzzer. Always check the surrounding area when using this system.

■ Types of sensors



- ① Front center sensors
- ② Front corner sensors
- ③ Rear corner sensors
- ④ Rear center sensors

■ Lexus parking assist-sensor switch

Turns the Lexus parking assist-sensor on/off

When on, the indicator light comes on to inform the driver that the system is operational.

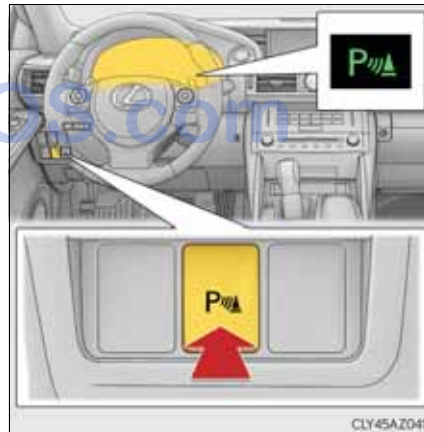

*: If equipped

Display

When the sensors detect an obstacle, a graphic is shown on the multi-information display and Lexus Display Audio screen (if equipped) depending on the position and distance to the obstacle.

■ Multi-information display

- ① Front corner sensor detection
- ② Front center sensor detection
- ③ Rear corner sensor detection
- ④ Rear center sensor detection

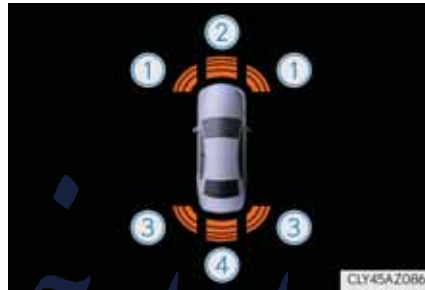

■ Lexus Display Audio screen (if equipped)

- ① When the rear view monitor system is not displayed

A graphic is automatically displayed when an obstacle is detected. The screen can be set so that the graphic is not displayed. (→P. 253)

: Select to mute the buzzer sounds.

- ② When the rear view monitor system is displayed (insert display)





A simplified image is displayed on the upper right corner of the Lexus Display Audio screen when an obstacle is detected.



Sensor detection display, obstacle distance

- Multi-information display and Lexus Display Audio screen (if equipped)

Sensors that detect an obstacle will illuminate continuously or blink.

Display	Insert display (Lexus Display Audio screen only)	Approximate distance to obstacle	
		Front corner sensor/ front center sensor	Rear corner sensor/ rear center sensor
 (continuous)	 (blinking slowly)	Front center sensor only: 100 cm (3.3 ft.) to 50 cm (1.6 ft.)	Rear center sensor only: 150 cm (4.9 ft.) to 60 cm (2.0 ft.)
 (continuous)	 (blinking)	50 cm (1.6 ft.) to 40 cm (1.3 ft.)	60 cm (2.0 ft.) to 45 cm (1.5 ft.)
 (continuous)	 (blinking rapidly)	40 cm (1.3 ft.) to 30 cm (1.0 ft.)	Rear corner sensor: 45 cm (1.5 ft.) to 30 cm (1.0 ft.) Rear center sensor: 45 cm (1.5 ft.) to 35 cm (1.1 ft.)
 (blinking* ¹ or continuous* ²)	 (continuous)	Less than 30 cm (1.0 ft.)	Rear corner sensor: Less than 30 cm (1.0 ft.) Rear center sensor: Less than 35 cm (1.1 ft.)

*¹: Multi-information display

*²: Lexus Display Audio screen

■ Buzzer operation and distance to an obstacle

A buzzer sounds when the sensors are operating.

- The buzzer beeps faster as the vehicle approaches an obstacle. When the vehicle comes within the following distance of the obstacle, the buzzer sounds continuously:
 - Front center sensors: Approximately 30 cm (1.0 ft.)
 - Corner sensors: Approximately 30 cm (1.0 ft.)
 - Rear center sensors: Approximately 35 cm (1.1 ft.)
- When 2 or more obstacles are detected simultaneously, the buzzer system responds to the nearest obstacle. If one or both come within the above distances, the beep will repeat a long tone, followed by fast beeps.

Detection range of the sensors

- ① Approximately 100 cm (3.3 ft.)
- ② Approximately 150 cm (4.9 ft.)
- ③ Approximately 50 cm (1.6 ft.)
- ④ Approximately 60 cm (2.0 ft.)

The diagram shows the detection range of the sensors. Note that the sensors cannot detect obstacles that are extremely close to the vehicle.

The range of the sensors may change depending on the shape of the object etc.

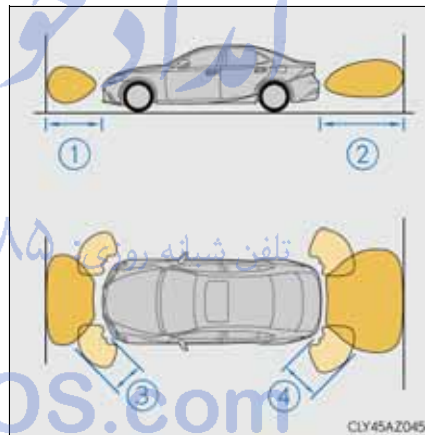

Setting up Lexus parking assist-sensor

You can change the warning beep volume and Lexus Display Audio screen operating conditions.

- 1 Press the “MENU” button on the Lexus Display Audio controller. (→P. 294)
- 2 Select “Setup” on the “Menu” screen.
- 3 Select “Vehicle” on the “Setup” screen.
- 4 Select “LEXUS park assist” on the “Vehicle settings” screen.
- 5 Select the desired button.
 - ① The alert volume can be adjusted.
 - ② On or off can be selected for Lexus parking assist-sensor display.
 - ③ Front or rear center sensors display and tone indication can be set.



- The Lexus parking assist-sensor can be operated when
 - Front center sensors:
 - The engine switch is in IGNITION ON mode.
 - The shift lever is in a position other than P or R.
 - The vehicle speed is less than about 10 km/h (6 mph).
 - Front corner sensors:
 - The engine switch is in IGNITION ON mode.
 - The shift lever is in a position other than P.
 - The vehicle speed is less than about 10 km/h (6 mph).
(At any speed when the shift lever is in R)
 - Rear corner and rear center sensors:
 - The engine switch is in IGNITION ON mode.
 - The shift lever is in R.

- Lexus parking assist-sensor display

When an obstacle is detected while the rear view monitor system is in use, the warning indicator will appear in the top right of the screen even if the display setting has been set to off.

- Sensor detection information
 - The sensor's detection areas are limited to the areas around the vehicle's front corner and rear bumpers.
 - Certain vehicle conditions and the surrounding environment may affect the ability of the sensor to correctly detect obstacles. Particular instances where this may occur are listed below.
 - There is dirt, snow or ice on the sensor. (Wiping the sensors will resolve this problem.)
 - The sensor is frozen. (Thawing the area will resolve this problem.)
In especially cold weather, if a sensor is frozen the screen may show an abnormal display, or obstacles may not be detected.
 - The sensor is covered in any way.
 - The vehicle is leaning considerably to one side.
 - On an extremely bumpy road, on an incline, on gravel, or on grass.
 - The vicinity of the vehicle is noisy due to vehicle horns, motorcycle engines, air brakes of large vehicles, or other loud noises producing ultrasonic waves.
 - There is another vehicle equipped with parking assist sensors in the vicinity.
 - The sensor is coated with a sheet of spray or heavy rain.
 - The vehicle is equipped with a fender pole or wireless antenna.
 - Towing eyelets are installed.
 - The bumper or sensor receives a strong impact.
 - The vehicle is approaching a tall or curved curb.
 - In harsh sunlight or intense cold weather.
 - The area directly under the bumpers is not detected.
 - If obstacles draw too close to the sensor.
 - A non-genuine Lexus suspension (lowered suspension etc.) is installed.
 - People may not be detected if they are wearing certain types of clothing.

In addition to the examples above, there are instances in which, because of their shape, signs and other objects may be judged by the sensor to be closer than they are.

 - The shape of the obstacle may prevent the sensor from detecting it. Pay particular attention to the following obstacles:
 - Wires, fences, ropes, etc.
 - Cotton, snow and other materials that absorb sound waves
 - Sharply-angled objects
 - Low obstacles
 - Tall obstacles with upper sections projecting outwards in the direction of your vehicle
 - The following situations may occur during use.
 - Depending on the shape of the obstacle and other factors, the detection distance may shorten, or detection may be impossible.
 - Obstacles may not be detected if they are too close to the sensor.
 - There will be a short delay between obstacle detection and display. Even at slow speeds, there is a possibility that the obstacle will come within the sensor's detection areas before the display is shown and the warning beep sounds.
 - Thin posts or objects lower than the sensor may not be detected when approached, even if they have been detected once.
 - It might be difficult to hear beeps due to the volume of the audio system or air flow noise of the air conditioning system.

- If a message is displayed on the multi-information display
→P. 483

امداد خودرو فارما

تلفن شبانه روزی: ۰۲۱-۸۸۸۶۲۰۸۵

FarmaSOS.com

4

Driving

 CAUTION

- When using the Lexus parking assist-sensor
Observe the following precautions.
Failing to do so may result in the vehicle being unable to be driven safely and possibly cause an accident.
 - Do not use the sensor at speeds in excess of 10 km/h (6 mph).
 - The sensors' detection areas and reaction times are limited. When moving forward or reversing, check the areas surrounding the vehicle (especially the sides of the vehicle) for safety, and drive slowly, using the brake to control the vehicle's speed.
 - Do not install accessories within the sensors' detection areas.

 NOTICE

- When using Lexus parking assist-sensor
In the following situations, the system may not function correctly due to a sensor malfunction etc. Have the vehicle checked by any authorized Lexus dealer or repairer, or another duly qualified and equipped professional.
 - The Lexus parking assist-sensor operation display flashes, and a beep sounds when no obstacles are detected.
 - If the area around a sensor collides with something, or is subjected to strong impact.
 - If the bumper or grille collides with something.
 - If the display shows continuously without beeping, except when the buzzer mute switch has been turned on.
 - If a display error occurs, first check the sensor.
If the error occurs even when there is no ice, snow or mud on the sensor, it is likely that the sensor is malfunctioning.
- Notes when washing the vehicle
Do not apply intensive bursts of water or steam to the sensor area.
Doing so may result in the sensor malfunctioning.

Rear view monitor system*

The rear view monitor system assists the driver by displaying guide lines and an image of the view behind the vehicle while backing up, for example while parking.

The screen illustrations used in this text are intended as examples, and may differ from the image that is actually displayed on the screen.

The rear view image is displayed when the shift position is in R and the engine switch is in IGNITION ON mode.

The rear view monitor system will be deactivated when the shift lever is in any position other than R.

When the shift lever is shifted to the R position and any mode button (such as "MENU") is pressed, the rear view monitor system is canceled, and the screen is switched to the mode of the button that was pressed.

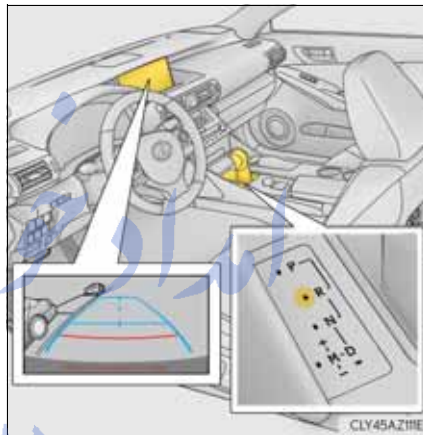

تلفن شبانه روزی: ۰۲۱-۸۸۶۲۰۸۵

FarmaSOS.com

*: If equipped

Using the rear view monitor system

■ Screen description

The rear view monitor system screen will be displayed if the shift lever is shifted to R while the engine switch is in IGNITION ON mode.

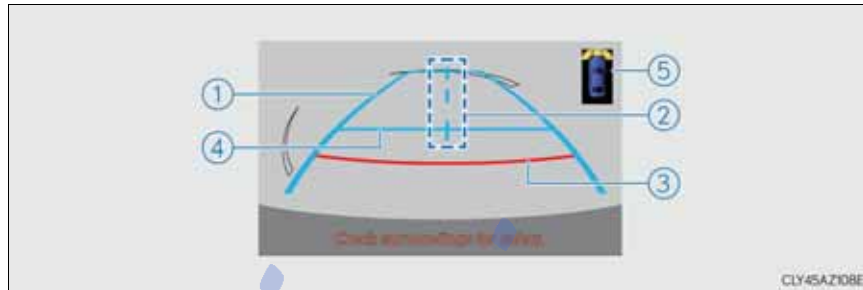

- ① Vehicle width guide lines
The line indicates a guide path when the vehicle is being backed straight up.
The displayed width is wider than the actual vehicle width.
- ② Vehicle center guide lines
These lines indicate the estimated vehicle center on the ground.
- ③ Distance guide line
The line shows points approximately 0.5 m (1.5 ft.) (red) from the center of the edge of the bumper.
- ④ Distance guide line
The line shows distance behind the vehicle, a point approximately 1 m (3 ft.) (blue) from the edge of the bumper.
- ⑤ Lexus parking assist-sensor display (if equipped)
If an obstacle is detected while the Lexus parking assist-sensor is on, a display is shown at the top right corner of the screen.

Rear view monitor system precautions

■ Area displayed on screen

The rear view monitor system displays an image of the view from the bumper of the rear area of the vehicle.

To adjust the image on the rear view monitor system screen.
(→P. 305)

- The area displayed on the screen may vary according to vehicle orientation conditions.
- Objects which are close to either corner of the bumper or under the bumper cannot be seen on the screen.
- The camera uses a special lens. The distance of the image that appears on the screen differs from the actual distance.
- Items which are located higher than the camera may not be displayed by the monitor.

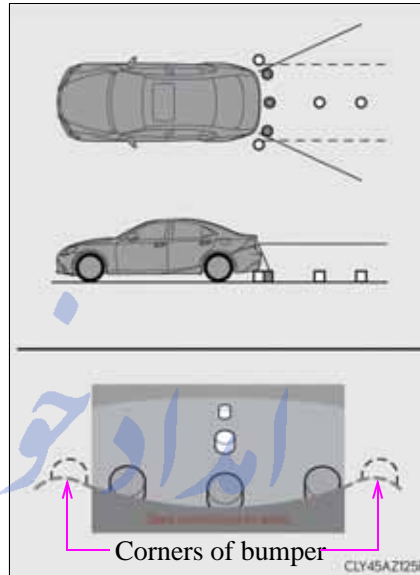

■ Rear view monitor system camera

The camera for the rear view monitor system is located above the license plate.



● Using the camera

If the camera lens becomes dirty, it cannot transmit a clear image. If water droplets, snow or mud adhere to the lens, rinse it with water and

wipe with a soft cloth. If the lens is extremely dirty, wash it with a mild cleanser and rinse.

امداد خودرو فارما

تلفن شبانه روزی: ۰۲۱-۸۸۸۶۲۰۸۵

FarmaSOS.com

- Differences between the screen and the actual road

The distance guide lines and the vehicle width guide lines may not actually be parallel with the dividing lines of the parking space, even when they appear to be so. Be sure to check visually.

The distances between the vehicle width guide lines and the left and right dividing lines of the parking space may not be equal, even when they appear to be so. Be sure to check visually.

The distance guide lines give a distance guide for flat road surfaces. In any of the following situations, there is a margin of error between the fixed guide lines on the screen and the actual distance/course on the road.

- When the ground behind the vehicle slopes up sharply

The distance guide lines will appear to be closer to the vehicle than the actual distance. Because of this, objects will appear to be farther away than they actually are. In the same way, there will be a margin of error between the guidelines and the actual distance/course on the road.

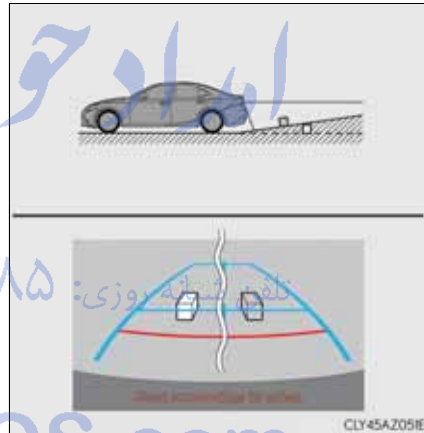

- When the ground behind the vehicle slopes down sharply

The distance guide lines will appear to be further from the vehicle than the actual distance. Because of this, objects will appear to be closer than they actually are. In the same way, there will be a margin of error between the guidelines and the actual distance/course on the road.

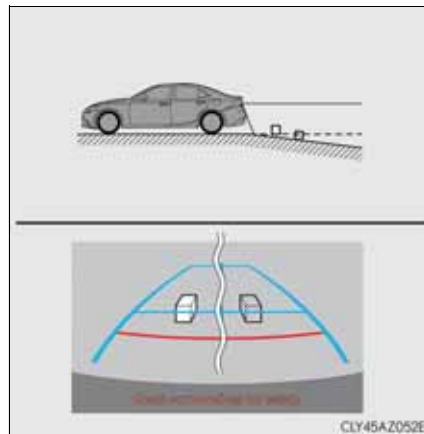

- When any part of the vehicle sags

When any part of the vehicle sags due to the number of passengers or the distribution of the load, there is a margin of error between the fixed guide lines on the screen and the actual distance/course on the road.

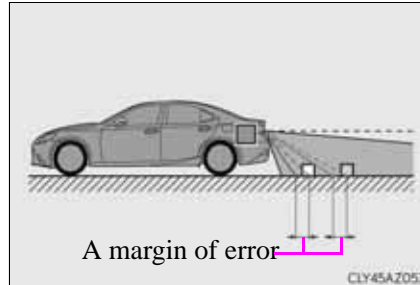

- When approaching three-dimensional objects

The distance guide lines are displayed according to flat surfaced objects (such as the road). It is not possible to determine the position of three-dimensional objects (such as vehicles) using the distance guide lines. When approaching a three-dimensional object that extends outward (such as the flatbed of a truck), be careful of the following.

- Distance guidelines

Visually check the surroundings and the area behind the vehicle. On the screen, it appears that a truck is parked at point ②. However, in reality if you back up to point ①, you will hit the truck. On the screen, it appears that ① is closest and ③ is furthest away. However, in reality, the distance to ① and ③ is the same, and ② is farther than ① and ③.

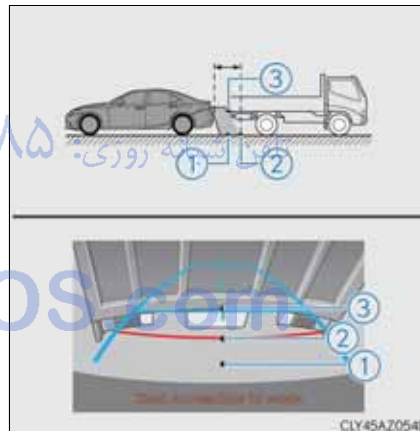

- Vehicle width guide lines

Visually check the surroundings and the area behind the vehicle. In the case shown below, the truck appears to be outside of the vehicle width guide lines and the vehicle does not look as if it hits the truck. However, the rear body of the truck may actually cross over the vehicle width guide lines. In reality if you back up as guided by the vehicle width guide lines, the vehicle may hit the truck.

Vehicle width guide lines

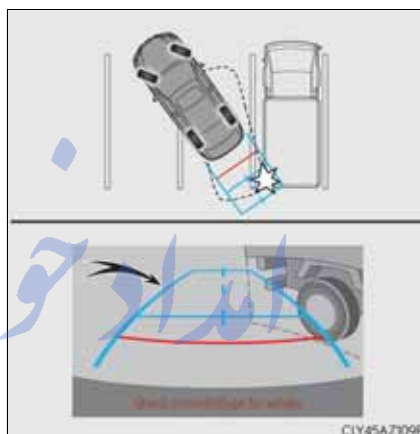

انداز خودرو فارما

4

Driving

تلفن شبانه روزی: ۰۲۱-۸۸۸۶۲۰۸۵

FarmaSOS.com

Things you should know

■ If you notice any symptoms

If you notice any of the following symptoms, refer to the likely cause and the solution, and re-check.

If the symptom is not resolved by the solution, have the vehicle inspected by any authorized Lexus dealer or repairer, or another duly qualified and equipped professional.

Likely cause	Solution
<input type="checkbox"/> The image is difficult to see	
<ul style="list-style-type: none"> • The vehicle is in a dark area • The temperature around the lens is either high or low • The outside temperature is low • There are water droplets on the camera • It is raining or humid • Foreign matter (mud etc.) is adhering to the camera • There are scratches on the camera • Sunlight or headlights are shining directly into the camera • The vehicle is under fluorescent lights, sodium lights, mercury lights etc. 	<p>If this happens due to these causes, it does not indicate a malfunction. Back up while visually checking the vehicle's surroundings. (Use the monitor again once conditions have been improved.)</p> <p>To adjust the image on the rear view monitor system screen. (→P. 305)</p>
<input type="checkbox"/> The image is blurry	
Dirt or foreign matter (such as water droplets, snow, mud etc.) is adhering to the camera.	Rinse the camera lens with water and wipe it clean with a soft cloth. Wash with a mild soap if the dirt is stubborn.
<input type="checkbox"/> The image is out of alignment	
The camera or surrounding area has received a strong impact.	Have the vehicle inspected by any authorized Lexus dealer or repairer, or another duly qualified and equipped professional.
<input type="checkbox"/> The fixed guide lines are very far out of alignment	
<ul style="list-style-type: none"> • The vehicle is tilted (there is a heavy load on the vehicle, tire pressure is low due to a tire puncture, etc.) • The vehicle is used on an incline. 	<p>If this happens due to these causes, it does not indicate a malfunction. Back up while visually checking the vehicle's surroundings.</p>

The camera position is out of alignment.

Have the vehicle inspected by any authorized Lexus dealer or repairer, or another duly qualified and equipped professional.

امداد خودرو فارما

تلفن شبانه روزی: ۰۲۱-۸۸۸۶۲۰۸۵

FarmaSOS.com

4

Driving

 CAUTION

■ When using the rear view monitor system

The rear view monitor system is a supplemental device intended to assist the driver when backing up. When backing up, be sure to check visually behind and all around the vehicle before proceeding.

Observe the following precautions to avoid an accident that could result in death or serious injuries.

- Never depend on the rear view monitor system entirely when backing up. The image and the position of the guide lines displayed on the screen may differ from the actual state.
Use caution, just as you would when backing up any vehicle.
- Be sure to back up slowly, depressing the brake pedal to control vehicle speed.
- The instructions given are only guidelines.
When and how much to turn the steering wheel will vary according to traffic conditions, road surface conditions, vehicle condition, etc. when parking. It is necessary to be fully aware of this before using the rear view monitor system.
- When parking, be sure to check that the parking space will accommodate your vehicle before maneuvering into it.
- Do not use the rear view monitor system in the following cases:
 - On icy or slick road surfaces, or in snow
 - When using tire chains or the compact spare tire
 - When the trunk lid is not closed completely
 - On roads that are not flat or straight, such as curves or slopes.
- In low temperatures, the screen may darken or the image may become faint. The image could distort when the vehicle is moving, or you may become unable to see the image on the screen. Be sure to check direct visually and with the mirrors all around the vehicle before proceeding.
- If the tire sizes are changed, the position of the fixed guide lines displayed on the screen may change.
- The camera uses a special lens. The distances between objects and pedestrians that appear in the image displayed on the screen will differ from the actual distances.
(→P. 259)



NOTICE

■ How to use the camera

- The rear view monitor system may not operate properly in the following cases.
 - If the back of the vehicle is hit, the position and mounting angle of the camera may change.
 - As the camera has a water proof construction, do not detach, disassemble or modify it. This may cause incorrect operation.
 - Do not strongly rub the camera lens. If the camera lens is scratched, it cannot transmit a clear image.
 - Do not allow organic solvent, car wax, window cleaner or glass coat to adhere to the camera. If this happens, wipe it off as soon as possible.
 - If the temperature changes rapidly, such as when hot water is poured on the vehicle in cold weather, the system may not operate normally.
 - When washing the vehicle, do not apply intensive bursts of water to the camera or camera area. Doing so may result in the camera malfunctioning.
 - When the camera is used under fluorescent lights, sodium light or mercury light etc., the lights and the illuminated areas may appear to flicker.
- Do not expose the camera to strong impact as this could cause a malfunction. If this happens, have the vehicle inspected by any authorized Lexus dealer or repairer, or another duly qualified and equipped professional as soon as possible.

تلفن شبانه روزی: ۰۲۱-۸۸۶۲۰۸۵

FarmaSOS.com

Driving mode select switch

The driving modes can be selected to suit driving condition.

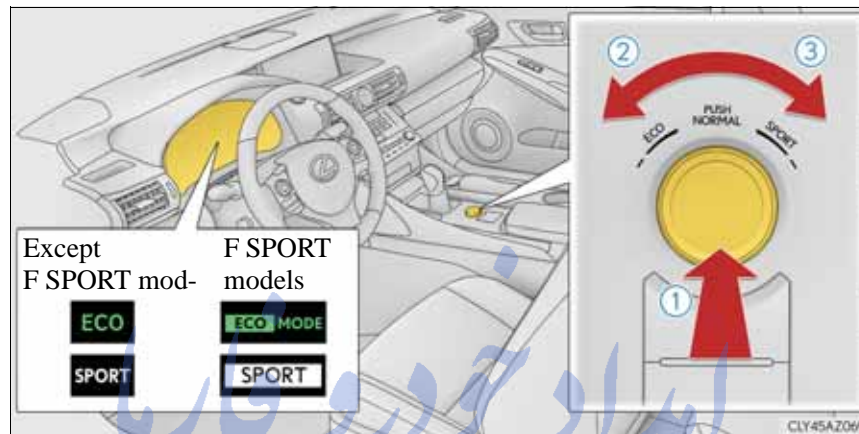

① Normal mode

For normal driving.

Press the switch to change the driving mode to normal mode when selected to Eco drive mode or sport mode.

② Eco drive mode

Use Eco drive mode to help achieve low fuel consumption during trips that involve frequent accelerating.

When not in Eco drive mode and the driving mode select switch is turned to the left, the Eco drive mode indicator comes on.

③ Sport mode

Assists acceleration response by controlling the transmission and steering. Suitable for when precise handling is desirable, for example when driving on mountain roads.

When not in sport mode and the driving mode select switch is turned to the right, the "SPORT" indicator comes on.

- Operation of the air conditioning system in Eco drive mode
Eco drive mode controls the heating/cooling operations and fan speed of the air conditioning system to enhance fuel efficiency (→P. 374). To improve air conditioning performance, adjust the fan speed or turn off Eco drive mode.
- Sport mode automatic deactivation
Sport mode is automatically deactivated if the engine switch is turned off after driving in sport mode.

امداد خودرو فارما

تلفن شبانه روزی: ۰۲۱-۸۸۸۶۲۰۸۵

FarmaSOS.com

Driving assist systems

To help enhance driving safety and performance, the following systems operate automatically in response to various driving situations. Be aware, however, that these systems are supplementary and should not be relied upon too heavily when operating the vehicle.

◆ ABS (Anti-lock Brake System)

Helps to prevent wheel lock when the brakes are applied suddenly, or if the brakes are applied while driving on a slippery road surface

◆ Brake assist

Generates an increased level of braking force after the brake pedal is depressed when the system detects a panic stop situation

◆ VSC (Vehicle Stability Control)

Helps the driver to control skidding when swerving suddenly or turning on slippery road surfaces

◆ VSC+ (Vehicle Stability Control+)

Provides cooperative control of the ABS, TRC, VSC and EPS. Helps to maintain directional stability when swerving on slippery road surfaces by controlling steering performance.

◆ TRC (Traction Control)

Helps to maintain drive power and prevent the drive wheels from spinning when starting the vehicle or accelerating on slippery roads

◆ Hill-start assist control

Prevents the vehicle from rolling backward when starting on an incline or slippery slope

◆ EPS (Electric Power Steering)

Employs an electric motor to reduce the amount of effort needed to turn the steering wheel

◆ VDIM (Vehicle Dynamics Integrated Management)

Provides integrated control of the ABS, brake assist, TRC, VSC, hill-start assist control and EPS systems

Helps to maintain vehicle stability when swerving on slippery road surfaces by controlling the brakes, engine output

◆ PCS (Pre-Crash Safety system) (if equipped)

→P. 276

◆ Emergency brake signal

When the brakes are applied suddenly, the stop lights automatically flash to alert the vehicle behind

◆ BSM (Blind Spot Monitor) (if equipped)

→P. 285

When the TRC/VSC systems are operating

The slip indicator light will flash while the TRC/VSC systems are operating.

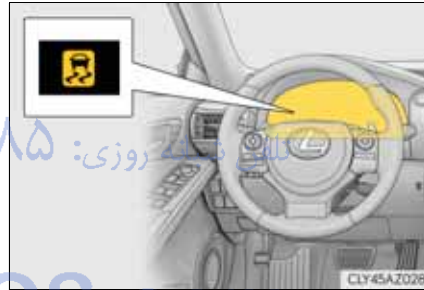

Disabling the TRC/VSC systems

If the vehicle gets stuck in fresh snow or mud, the TRC and VSC systems may reduce power from the engine to the wheels. Pressing VSC OFF switch to turn the system off may make it easier for you to rock the vehicle in order to free it.

■ Turning off the TRC system only

To turn the TRC system off, quickly press and release the switch.

The “TRC OFF” will be shown on the multi-information display. Press the switch again to turn the system back on.

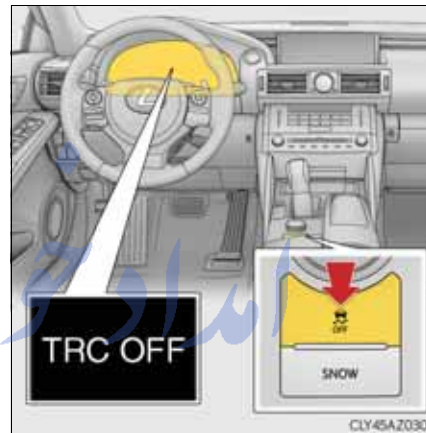

■ Turning off both TRC and VSC systems

To turn the TRC and VSC systems off, press and hold the switch for more than 3 seconds while the vehicle is stopped.

The VSC OFF indicator light will come on and the “TRC OFF” will be shown on the multi-information display.*

Press the switch again to turn the systems back on.

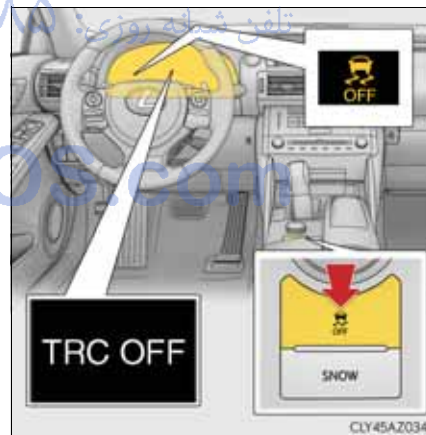

*: On vehicles with pre-crash safety system, pre-crash brake assist and pre-crash braking will also be disabled. The pre-crash safety system warning light will come on and the message will be shown on the multi-information display. (→P. 276)

- When the battery is disconnected
The steering wheel may move from its straight forward position, but this will be corrected automatically when driving.
- Sounds and vibrations caused by the ABS, brake assist, TRC, VSC and hill-start assist control systems
 - A sound may be heard from the engine compartment when the brake pedal is depressed repeatedly, when the engine is started or just after the vehicle begins to move. This sound does not indicate that a malfunction has occurred in any of these systems.
 - Any of the following conditions may occur when the above systems are operating. None of these indicates that a malfunction has occurred.
 - Vibrations may be felt through the vehicle body and steering.
 - A motor sound may be heard after the vehicle comes to a stop.
 - The brake pedal may pulsate slightly after the ABS is activated.
 - The brake pedal may move down slightly after the ABS is activated.
- EPS operation sound
When the steering wheel is operated, a motor sound may be heard. This does not indicate a malfunction.
- Reactivation of the TRC/VSC systems
Even after the TRC/VSC systems have been turned off, turning the engine off and then on again will automatically reactivate the TRC/VSC systems.
- Reactivation of the TRC system linked to vehicle speed
When only the TRC system is turned off, the TRC system will turn on when vehicle speed increases. However, when both TRC and VSC systems are turned off, the systems will not turn on even when vehicle speed increases.
- Reduced effectiveness of the EPS system
The effectiveness of the EPS system is reduced to prevent the system from overheating when there is frequent steering input over an extended period of time. The steering wheel may feel heavy as a result. Should this occur, refrain from excessive steering input or stop the vehicle and turn the engine off. The EPS system should return to normal within 10 minutes.

■ Operating conditions of hill-start assist control

When the following four conditions are met, the hill-start assist control will operate:

- The shift lever is in a position other than P or N (when starting off forward/backward on an upward incline).
- The vehicle is stopped.
- The accelerator pedal is not depressed.
- The parking brake is not engaged.

■ Automatic system cancelation of hill-start assist control

The hill-start assist control will turn off in any of the following situations:

- The shift lever is moved to P or N.
- The accelerator pedal is depressed.
- The parking brake is engaged.
- Approximately 2 seconds elapse after the brake pedal is released.

■ Operating conditions of emergency brake signal

When the following three conditions are met, the emergency brake signal will operate:

- The emergency flashers are off.
- Actual vehicle speed is over 55 km/h (35 mph).
- The brake pedal is depressed in a manner that cause the system to judge from the vehicle deceleration that this is a sudden braking operation.

■ Automatic system cancelation of emergency brake signal

The emergency brake signal will turn off in any of the following situations:

- The emergency flashers are turned on.
- The brake pedal is released.
- The system judges from the vehicle deceleration that is not a sudden braking operation.

FarmaSOS.com

⚠ CAUTION

- The ABS does not operate effectively when
 - The limits of tire gripping performance have been exceeded (such as excessively worn tires on a snow covered road).
 - The vehicle hydroplanes while driving at high speed on wet or slick roads.
- Stopping distance when the ABS is operating may exceed that of normal conditions

The ABS is not designed to shorten the vehicle's stopping distance. Always maintain a safe distance from the vehicle in front of you, especially in the following situations:

 - When driving on dirt, gravel or snow-covered roads
 - When driving with tire chains
 - When driving over bumps in the road
 - When driving over roads with potholes or uneven surfaces
- TRC may not operate effectively when

Directional control and power may not be achievable while driving on slippery road surfaces, even if the TRC system is operating. Drive the vehicle carefully in conditions where stability and power may be lost.
- Hill- start assist control does not operate effectively when
 - Do not overly rely on hill-start assist control. Hill-start assist control may not operate effectively on steep inclines and roads covered with ice.
 - Unlike the parking brake, hill-start assist control is not intended to hold the vehicle stationary for an extended period of time. Do not attempt to use hill-start assist control to hold the vehicle on an incline, as doing so may lead to an accident.
- When the VSC is activated

The slip indicator light flashes. Always drive carefully. Reckless driving may cause an accident. Exercise particular care when the indicator light flashes.
- When the TRC/VSC systems are turned off

Be especially careful and drive at a speed appropriate to the road conditions. As these are the systems to ensure vehicle stability and driving force, do not turn the TRC/VSC systems off unless necessary.
- Replacing tires

Make sure that all tires are of the specified size, brand, tread pattern and total load capacity. In addition, make sure that the tires are inflated to the recommended tire inflation pressure level.

The ABS, TRC and VSC systems will not function correctly if different tires are installed on the vehicle.

Contact any authorized Lexus dealer or repairer, or another duly qualified and equipped professional for further information when replacing tires or wheels.
- Handling of tires and the suspension

Using tires with any kind of problem or modifying the suspension will affect the driving assist systems, and may cause a system to malfunction.

PCS (Pre-Crash Safety system)*

When the radar sensor detects the possibility of a frontal collision, brakes are automatically engaged to lessen impact as well as vehicle damage.

The pre-crash safety system can be turned on and off as necessary by operating the switch. (→P. 277)

◆ Pre-crash warning

When a high possibility of a frontal collision is detected, the pre-crash safety system warning light flashes, a buzzer sounds and a message is shown on the multi-information display to urge the driver to take evasive action.

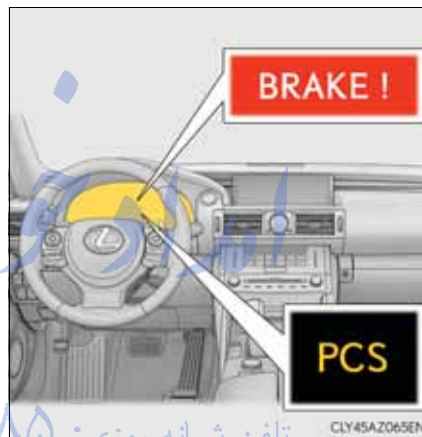

◆ Pre-crash brake assist

When there is a high possibility of a frontal collision, the system applies greater braking force in relation to how strongly the brake pedal is depressed. The system may not warn the driver using a warning light, warning display and buzzer when the system detects and judges braking operations.

◆ Pre-crash braking

When there is a high possibility of a frontal collision, the system warns the driver using a warning light, warning display and buzzer. If the system determines that a collision is unavoidable, the brakes are automatically applied to reduce the collision speed.

*: If equipped

Disabling pre-crash safety system

- ① Enabled
- ② Disabled

The pre-crash safety system warning light comes on when pre-crash safety system is disabled.

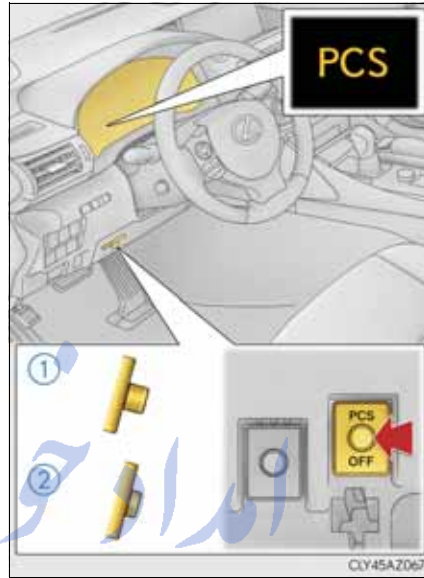

Radar sensor

The radar sensor detects vehicles or other obstacles on or near the road ahead and determines whether a collision is imminent based on the position, speed, and heading of the obstacles.



- The pre-crash safety system is operational when
 - The PCS OFF switch is not pressed and the following conditions are met:
 - Pre-crash warning:
 - Vehicle speed is greater than about 15 km/h (10 mph).
 - The speed at which your vehicle is approaching the obstacle or the vehicle running ahead of you is greater than about 15 km/h (10 mph).
 - Pre-crash brake assist:
 - The VSC OFF switch is not pressed.
 - Vehicle speed is greater than about 30 km/h (19 mph).
 - The speed at which your vehicle is approaching the obstacle or the vehicle running ahead of you is greater than about 30 km/h (19 mph).
 - The brake pedal is depressed.
 - Pre-crash braking:
 - The VSC OFF switch is not pressed.
 - Vehicle speed is greater than about 15 km/h (10 mph).
 - The speed at which your vehicle is approaching the obstacle or the vehicle running ahead of you is greater than about 15 km/h (10 mph).
- Conditions that may trigger the system even if there is no danger of a collision
 - When there is an object by the roadside at the entrance to a curve
 - When passing an oncoming vehicle on a curve
 - When driving over a narrow iron bridge
 - When there is a metal object on the road surface
 - When driving on an uneven road surface
 - When passing an oncoming vehicle on a left-turn (left-hand drive vehicles) or right-turn (right-hand drive vehicles)
 - When your vehicle rapidly closes on the vehicle in front
 - When a grade separation/interchange, sign, billboard, or other structure appears to be directly in the vehicle's line of travel
 - When there is a metal plate in the road in front of the vehicle on a downhill slope
 - When climbing a steep hill causes an overhead billboard or other metallic structure to appear directly in the vehicle's line of travel
 - When driving under an overpass
 - When an extreme change in vehicle height occurs
 - When passing through certain toll gates
 - When passing through a tunnel
 - When the radar sensor moves off position due to its surrounding area being subjected to a strong impact

When the system is activated in the situations described above, there is also a possibility that the brakes will be applied with a force greater than normal.

- **Obstacles not detected**
The sensor cannot detect plastic obstacles such as traffic cones. There may also be occasions when the sensor cannot detect pedestrians, animals, bicycles, motorcycles, trees, or snowdrifts.
- **Situations in which the pre-crash safety system does not function properly**
The system may not function effectively in situations such as the following:
 - On roads with sharp bends or uneven surfaces
 - If a vehicle suddenly moves in front of your vehicle, such as at an intersection
 - If a vehicle suddenly cuts in front of your vehicle, such as when overtaking
 - In inclement weather such as heavy rain, fog, snow or sand storms
 - If the vehicle is skidding when VSC is not operating
 - When an extreme change in vehicle height occurs
 - When only part of your vehicle's front end collides with, or contacts, a vehicle or object in a frontal collision
 - When the radar sensor moves off position due to its surrounding area being subjected to a strong impact
- **Automatic cancelation of the pre-crash safety system**
When a malfunction occurs due to sensor contamination, etc. that results in the sensors being unable to detect obstacles, the pre-crash safety system will be automatically disabled. In this case, the system will not activate even if there is a collision possibility.
- **When there is a malfunction in the system**
The pre-crash safety system warning light will flash and warning messages will be displayed. (→P. 476, 486)

FarmaSOS.com

■ Certification

CE 1731

The latest "DECLARATION of CONFORMITY"(DoC) is available at the following:

DoC address: FUJITSU TEN LIMITED

2-28, Goshō-dori 1-chome, Hyogo-ku, Kobe, 652-8510, Japan

<p>С настоящето, FUJITSU TEN LIMITED, декларира, че FT0041A е в съответствие със съществените изисквания и другите приложими разпоредби на Директива 1999/5/EC.</p>
<p>FUJITSU TEN LIMITED tímto prohlašuje, že tento FT0041A je ve shodě se základními požadavky a dalšími příslušnými ustanoveními směrnice 1999/5/ES.</p>
<p>Undertegnede FUJITSU TEN LIMITED erklærer herved, at følgende udstyr FT0041A overholder de væsentlige krav og øvrige relevante krav i direktiv 1999/5/EF.</p>
<p>Hiermit erklärt FUJITSU TEN LIMITED, dass sich das Gerät FT0041A in Übereinstimmung mit den grundlegenden Anforderungen und den übrigen einschlägigen Bestimmungen der Richtlinie 1999/5/EG befindet.</p>
<p>Käesolevaga kinnitab FUJITSU TEN LIMITED seadme FT0041A vastavust direktiivi 1999/5/EÜ põhinõuetele ja nimetatud direktiivist tulenevatele teistele asjakohastele sätetele.</p>
<p>Hereby, FUJITSU TEN LIMITED, declares that this FT0041A is in compliance with the essential requirements and other relevant provisions of Directive 1999/5/EC.</p>
<p>Por medio de la presente FUJITSU TEN LIMITED declara que el FT0041A cumple con los requisitos esenciales y cualesquiera otras disposiciones aplicables o exigibles de la Directiva 1999/5/CE.</p>
<p>ΜΕ ΤΗΝ ΠΑΡΟΥΣΑ FUJITSU TEN LIMITED ΔΗΛΩΝΕΙ ΟΤΙ FT0041A ΣΥΜΜΟΡΦΩΝΕΤΑΙ ΠΡΟΣ ΤΙΣ ΟΥΣΙΩΔΕΙΣ ΑΠΑΙΤΗΣΕΙΣ ΚΑΙ ΤΙΣ ΛΟΙΠΕΣ ΣΧΕΤΙΚΕΣ ΔΙΑΤΑΞΕΙΣ ΤΗΣ ΟΔΗΓΙΑΣ 1999/5/ΕΚ.</p>
<p>Par la présente FUJITSU TEN LIMITED déclare que l'appareil FT0041A est conforme aux exigences essentielles et aux autres dispositions pertinentes de la directive 1999/5/CE.</p>
<p>Con la presente FUJITSU TEN LIMITED dichiara che questo FT0041A è conforme ai requisiti essenziali ed alle altre disposizioni pertinenti stabilite dalla direttiva 1999/5/CE.</p>
<p>Ar šo FUJITSU TEN LIMITED deklarē, ka FT0041A atbilst Direktīvas 1999/5/EK būtiskajām prasībām un citiem ar to saistītajiem noteikumiem.</p>
<p>Šiuo FUJITSU TEN LIMITED deklaruoja, kad šis FT0041A atitinka esminius reikalavimus ir kitas 1999/5/EB Direktyvos nuostatas.</p>
<p>Hierbij verklaart FUJITSU TEN LIMITED dat het toestel FT0041A in overeenstemming is met de essentiële eisen en de andere relevante bepalingen van richtlijn 1999/5/EG.</p>

Hawnhekk, FUJITSU TEN LIMITED, jiddikjara li dan FT0041A jikkonforma mal-htigijiet essenzjali u ma provvedimenti oħrajn relevanti li hemm fid-Dirrettiva 1999/5/EC.
Alulírott, FUJITSU TEN LIMITED nyilatkozom, hogy a FT0041A megfelel a vonatkozó alapvető követelményeknek és az 1999/5/EC irányelv egyéb előírásainak.
Niniejszym FUJITSU TEN LIMITED oświadcza, że FT0041A jest zgodny z zasadniczymi wymogami oraz pozostałymi stosownymi postanowieniami Dyrektywy 1999/5/EC.
FUJITSU TEN LIMITED declara que este FT0041A está conforme com os requisitos essenciais e outras disposições da Directiva 1999/5/CE.
Prin prezenta, FUJITSU TEN LIMITED, declară că aparatul FT0041A este în conformitate cu cerințele esențiale și cu alte prevederi pertinente ale Directivei 1999/5/CE.
FUJITSU TEN LIMITED izjavlja, da je ta FT0041A v skladu z bistvenimi zahtevami in ostalimi relevantnimi določili direktive 1999/5/ES.
FUJITSU TEN LIMITED tímto vyhlasuje, že FT0041A splňuje základné požiadavky a všetky príslušné ustanovenia Smernice 1999/5/ES.
FUJITSU TEN LIMITED vakuuttaa täten että FT0041A tyyppinen laite on direktiivin 1999/5/EY oleellisten vaatimusten ja sitä koskevien direktiivin muiden ehtojen mukainen.
Härmed intygar FUJITSU TEN LIMITED att denna FT0041A står i överensstämmelse med de väsentliga egenskapskrav och övriga relevanta bestämmelser som framgår av direktiv 1999/5/EG.
Hér með lýsir FUJITSU TEN LIMITED yfir því að FT0041A er í samræmi við grunnkröfur og aðrar kröfur, sem gerðar eru í tilskipun 1999/5/EC.
FUJITSU TEN LIMITED erklærer herved at utstyret FT0041A er i samsvar med de grunnleggende krav og øvrige relevante krav i direktiv 1999/5/EF.
Ovim , FUJITSU TEN LIMITED, izjavljuje da ovaj FT0041A je usklađen sa bitnim zahtjevima i drugim relevantnim odredbama Direktive 1999/5/EC.

امداد خودرو فارما

تلفن شبانه روزی: ۰۲۱-۸۸۸۶۲۰۸۵

FarmaSOS.com



امداد خودرو فارما

تلفن شبانه روزی: ۰۲۱-۸۸۸۶۲۰۸۵

FarmaSOS.com

4

Driving

■ Limitations of the pre-crash safety system

Do not overly rely on the pre-crash safety system. Always drive safely, taking care to observe your surroundings and checking for any obstacles or other road hazards.

Failure to do so may cause an accident resulting in death or serious injury.

■ Handling the radar sensor

Observe the following to ensure the pre-crash safety system can function effectively. Otherwise, the system may not function correctly and could result in an accident.

- Keep the sensor and grille cover clean at all times.
Clean the sensor and grille cover with a soft cloth so you do not mark or damage them.
- Do not subject the sensor or surrounding area to a strong impact.
If the sensor moves even slightly off position, the system may malfunction. If the sensor or surrounding area is subject to a strong impact, always have the area inspected and adjusted by any authorized Lexus dealer or repairer, or another duly qualified and equipped professional.
- Do not disassemble the sensor.
- Do not attach accessories or stickers to the sensor, grille cover or surrounding area.
- Do not modify or paint the sensor and grille cover.
- Do not replace them with non-genuine parts.

■ Cautions regarding the assist contents of the system

By means of alarms and brake control, the pre-crash safety system is intended to assist the driver in avoiding collisions through the process of LOOK-JUDGE-ACT. There are limits to the degree of assistance the system can provide, so please keep in mind the following important points.

- Assisting the driver in watching the road
The pre-crash safety system is only able to detect obstacles directly in front of the vehicle, and only within a limited range. It is not a mechanism that allows careless or inattentive driving, and it is not a system that can assist the driver in low-visibility conditions. It is still necessary for the driver to pay close attention to the vehicle's surroundings.
- Assisting the driver in making correct judgment
When attempting to estimate the possibility of a collision, the only data available to the pre-crash safety system is that from obstacles it has detected directly in front of the vehicle. Therefore, it is absolutely necessary for the driver to remain vigilant and to determine whether or not there is a possibility of collision in any given situation.
- Assisting the driver in taking action
The pre-crash safety system's braking assist feature is designed to help reduce the severity of a collision, and so only acts when the system has judged that a collision is unavoidable. This system by itself is not capable of automatically avoiding a collision or bringing the vehicle to a stop safely. For this reason, when encountering a dangerous situation the driver must take direct and immediate action in order to ensure the safety of all involved.

BSM (Blind Spot Monitor)*

Summary of the Blind Spot Monitor

The Blind Spot Monitor is a system that has 2 functions;

- The Blind Spot Monitor function
Assists the driver in making the decision when changing lanes
- The Rear Crossing Traffic Alert function (if equipped)
Assists the driver when backing up

These functions use same sensors.

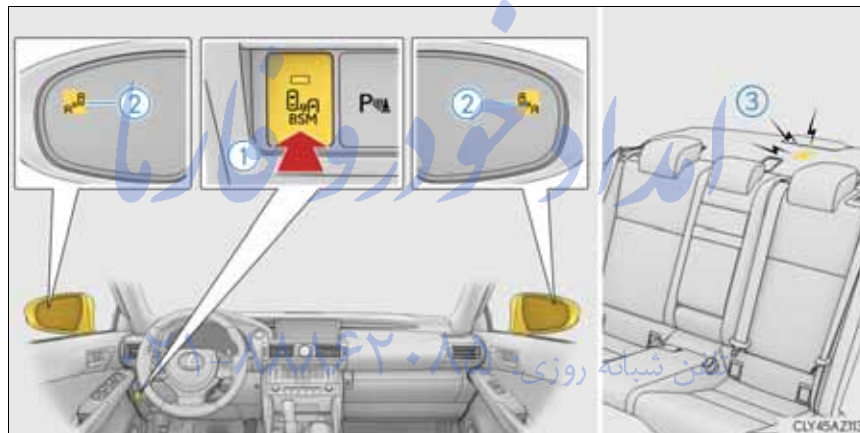

① BSM main switch

Pressing the switch turns the system on or off. When the switch is set to on, the switch's indicator illuminates and the buzzer sounds. Common switch for Blind Spot Monitor function and Rear Crossing Traffic Alert function.

② Outside rear view mirror indicators

Blind Spot Monitor function:

When a vehicle is detected in the blind spot, the outside rear view mirror indicator comes on while the turn signal lever is not operated and the outside rear view mirror indicator flashes while the turn signal lever is operated.

Rear Crossing Traffic Alert function:

When a vehicle approaching from the right or left rear of the vehicle is detected, the outside rear view mirror indicators flash.

③ Rear Crossing Traffic Alert buzzer (Rear Crossing Traffic Alert function only)

When a vehicle approaching from the right or left rear of the vehicle is detected, a buzzer sounds from behind the rear seat.

*: If equipped

- The outside rear view mirror indicators visibility
When under strong sunlight, the outside rear view mirror indicator may be difficult to see.
- Rear Crossing Traffic Alert buzzer hearing
Rear Crossing Traffic Alert function may be difficult to hear over loud noises such as high audio volume.
- When there is a malfunction in the Blind Spot Monitor
If a system malfunction is detected due to any of the following reasons, warning messages will be displayed: (→P. 485, 486)
 - There is a malfunction with the sensors
 - The sensors have become dirty
 - The outside temperature is extremely high or low
 - The sensor voltage has become abnormal
- Certification for the Blind Spot Monitor
 - ▶ For vehicles sold in Russia
type approval number : POCC DE.ML05.H01144



ML05

تلفن شبانه روزی: ۰۸۵-۸۸۶۲۰۲۱

- ▶ For vehicles sold in Ukraine
type approval number : UA1.155.0029691-12



155

► Except for vehicles sold in Russia and Ukraine

CE 0700

The latest "DECLARATION of CONFORMITY"(DoC) is available at the following:

DoC address : <http://continental.automotive-approvals.de/index.php?produkt=SRR2-A>

CONTINENTAL tímto prohlašuje, že tento SRR2-A je ve shodě se základními požadavky a dalšími příslušnými ustanoveními směrnice 1999/5/ES.
Undertegnede CONTINENTAL erklærer herved, at følgende udstyr SRR2-A overholder de væsentlige krav og øvrige relevante krav i direktiv 1999/5/EF.
Hiermit erklärt CONTINENTAL, dass sich das Gerät SRR2-A in Übereinstimmung mit den grundlegenden Anforderungen und den übrigen einschlägigen Bestimmungen der Richtlinie 1999/5/EG befindet.
Käesolevaga kinnitab CONTINENTAL seadme SRR2-A vastavust direktiivi 1999/5/EÜ põhinõuetele ja nimetatud direktiivist tulenevatele teistele asjakohastele sätetele.
Hereby, CONTINENTAL, declares that this SRR2-A is in compliance with the essential requirements and other relevant provisions of Directive 1999/5/EC.
Por medio de la presente CONTINENTAL declara que el SRR2-A cumple con los requisitos esenciales y cualesquiera otras disposiciones aplicables o exigibles de la Directiva 1999/5/CE.
ΜΕ ΤΗΝ ΠΑΡΟΥΣΑ CONTINENTAL ΔΗΛΩΝΕΙ ΟΤΙ SRR2-A ΣΥΜΜΟΡΦΟΝΕΤΑΙ ΠΡΟΣ ΤΙΣ ΟΥΣΙΩΔΕΙΣ ΑΠΑΙΤΗΣΕΙΣ ΚΑΙ ΤΙΣ ΛΟΙΠΕΣ ΣΧΕΤΙΚΕΣ ΔΙΑΤΑΞΕΙΣ ΤΗΣ ΟΔΗΓΙΑΣ 1999/5/EK.
Par la présente CONTINENTAL déclare que l'appareil SRR2-A est conforme aux exigences essentielles et aux autres dispositions pertinentes de la directive 1999/5/CE.
Con la presente CONTINENTAL dichiara che questo SRR2-A è conforme ai requisiti essenziali ed alle altre disposizioni pertinenti stabilite dalla direttiva 1999/5/CE.
Ar šo CONTINENTAL deklarē, ka SRR2-A atbilst Direktīvas 1999/5/EK būtiskajām prasībām un citiem ar to saistītajiem noteikumiem.
Šiuo CONTINENTAL deklaruoja, kad šis SRR2-A atitinka esminius reikalavimus ir kitas 1999/5/EB Direktyvos nuostatas.

تلفن شبانه روزی: ۰۲۱-۸۸۶۲۰۸۵

FarmaSOS.com

Hierbij verklaart CONTINENTAL dat het toestel SRR2-A in overeenstemming is met de essentiële eisen en de andere relevante bepalingen van richtlijn 1999/5/EG.
Hawnhekk, CONTINENTAL, jiddikjara li dan SRR2-A jikkonforma mal-htigjijiet essenzjali u ma provvedimenti oħrajn relevanti li hemm fid-Direttiva 1999/5/EC.
Alulírott, CONTINENTAL nyilatkozik, hogy a SRR2-A megfelel a vonatkozó alapvető követelményeknek és az 1999/5/EC irányelv egyéb előírásainak.
Niniejszym CONTINENTAL oświadcza, że SRR2-A jest zgodny z zasadniczymi wymogami oraz pozostałymi stosownymi postanowieniami Dyrektywy 1999/5/EC.
CONTINENTAL declara que este SRR2-A está conforme com os requisitos essenciais e outras disposições da Directiva 1999/5/CE.
CONTINENTAL izjavlja, da je ta SRR2-A v skladu z bistvenimi zahtevami in ostalimi relevantnimi določili direktive 1999/5/ES.
CONTINENTAL tímto vyhlasuje, že SRR2-A splňuje základné požiadavky a všetky príslušné ustanovenia Smernice 1999/5/ES.
CONTINENTAL vakuuttaa täten että SRR2-A tyyppinen laite on direktiivin 1999/5/EY oleellisten vaatimusten ja sitä koskevien direktiivin muiden ehtojen mukainen.
Härmed intygar CONTINENTAL att denna SRR2-A står i överensstämmelse med de väsentliga egenskapskrav och övriga relevanta bestämmelser som framgår av direktiv 1999/5/EG.
Hér með lýsir CONTINENTAL yfir því að SRR2-A er í samræmi við grunnkröfur og aðrar kröfur, sem gerðar eru í tilskipun 1999/5/EC.
CONTINENTAL erklærer herved at utstyret SRR2-A er i samsvar med de grunnleggende krav og øvrige relevante krav i direktiv 1999/5/EF.
С настоящето, CONTINENTAL, декларира, че SRR2-A е в съответствие със съществените изисквания и другите приложими разпоредби на Директива 1999/5/EC.
Prin prezenta, CONTINENTAL, declară că aparatul SRR2-A este în conformitate cu cerințele esențiale și cu alte prevederi pertinente ale Directivei 1999/5/CE.
“Ovim, CONTINENTAL, izjavljuje da ovaj SRR2-A je uskladen sa bitnim zahtjevima i drugim relevantnim odredbama Direktive 1999/5/EC.”
Ovim CONTINENTAL, izjavljuje da je SRR2-A u skladu s bitnim zahtjevima i drugim relevantnim odredbama Direktive 1999/5/EC i Pravilnika o RiTT opremi(NN25/2012)

تلفن شبانه روزی: ۰۲۱-۸۸۸۸۰۸۵

FarmaSOS.com

⚠ CAUTION**■ Handling the radar sensor**

One Blind Spot Monitor sensor is installed inside the left and right side of the vehicle rear bumper respectively. Observe the following to ensure the Blind Spot Monitor can function correctly.

- Keep the sensor and its surrounding area on the bumper clean at all times.

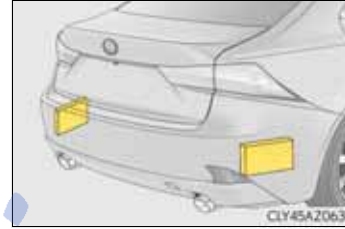

- Do not subject the sensor or surrounding area on the bumper to a strong impact. If the sensor moves even slightly off position, the system may malfunction and vehicles that enter the detection area may not be detected. If the sensor or surrounding area is subject to a strong impact, always have the area inspected by any authorized Lexus dealer or repairer, or another duly qualified and equipped professional.
- Do not disassemble the sensor.
- Do not attach accessories or stickers to the sensor or surrounding area on the bumper.
- Do not modify the sensor or surrounding area on the bumper.
- Do not paint the sensor or surrounding area on the bumper.

The Blind Spot Monitor function

The Blind Spot Monitor function uses radar sensors to detect vehicles that are traveling in an adjacent lane in the area that is not reflected in the outside rear view mirror (the blind spot), and advises the driver of the vehicles existence via the outside rear view mirror indicator.

The Blind Spot Monitor function detection areas

The areas that vehicles can be detected in are outlined below.

The range of the detection area extends to:

- ① Approximately 3.5 m (11.5 ft.) from the side of the vehicle
The first 0.5 m (1.6 ft.) from the side of the vehicle is not in the detection area
- ② Approximately 3 m (9.8 ft.) from the rear bumper
- ③ Approximately 1 m (3.3 ft.) forward of the rear bumper



⚠ CAUTION

■ Cautions regarding the use of the system

The driver is solely responsible for safe driving. Always drive safely, taking care to observe your surroundings.

The Blind Spot Monitor function is a supplementary function which alerts the driver that a vehicle is present in the blind spot. Do not overly rely on the Blind Spot Monitor function. The function cannot judge if it is safe to change lanes, therefore over reliance could cause an accident resulting in death or serious injury.

According to conditions, the system may not function correctly. Therefore the driver's own visual confirmation of safety is necessary.

- The Blind Spot Monitor function is operational when
 - The BSM main switch is set to on
 - Vehicle speed is greater than approximately 16 km/h (10 mph).
 - The Blind Spot Monitor function will detect a vehicle when
 - A vehicle in an adjacent lane overtakes your vehicle.
 - Another vehicle enters the detection area when it changes lanes.
 - Conditions under which the Blind Spot Monitor function will not detect a vehicle
The Blind Spot Monitor function is not designed to detect the following types of vehicles and/or objects:
 - Small motorcycles, bicycles, pedestrians etc.*
 - Vehicles traveling in the opposite direction
 - Guardrails, walls, signs, parked vehicles and similar stationary objects*
 - Following vehicles that are in the same lane*
 - Vehicles driving 2 lanes across from your vehicle*
- *: Depending on conditions, detection of a vehicle and/or object may occur.
- Conditions under which the Blind Spot Monitor function may not function correctly
 - The Blind Spot Monitor function may not detect vehicles correctly in the following conditions:
 - During bad weather such as heavy rain, fog, snow etc.
 - When ice or mud etc. is attached to the rear bumper
 - When driving on a road surface that is wet due to rain, standing water etc.
 - When there is a significant difference in speed between your vehicle and the vehicle that enters the detection area
 - When a vehicle is in the detection area from a stop and remains in the detection area as your vehicle accelerates
 - When driving up or down consecutive steep inclines, such as hills, a dip in the road etc.
 - When multiple vehicles approach with only a small gap between each vehicle
 - When vehicle lanes are wide, and the vehicle in the next lane is too far away from your vehicle
 - When the vehicle that enters the detection area is traveling at about the same speed as your vehicle
 - When there is a significant difference in height between your vehicle and the vehicle that enters the detection area
 - Directly after the BSM main switch is set to on
 - When your vehicle is towing a trailer
 - Instances of the Blind Spot Monitor function unnecessarily detecting a vehicle and/ or object may increase under the following conditions:
 - When there is only a short distance between your vehicle and a guardrail, wall etc.
 - When there is only a short distance between your vehicle and a following vehicle
 - When vehicle lanes are narrow and a vehicle driving 2 lanes across from your vehicle enters the detection area

- When items such as a bicycle carrier are installed on the rear of the vehicle

امداد خودرو فارما

تلفن شبانه روزی: ۰۲۱-۸۸۸۶۲۰۸۵

FarmaSOS.com

The Rear Crossing Traffic Alert function (if equipped)

The Rear Crossing Traffic Alert functions when your vehicle is in reverse. It can detect other vehicles approaching from the right or left rear of the vehicle. It uses radar sensors to alert the driver of the other vehicle's existence through flashing the outside rear view mirror indicators and sounding a buzzer.

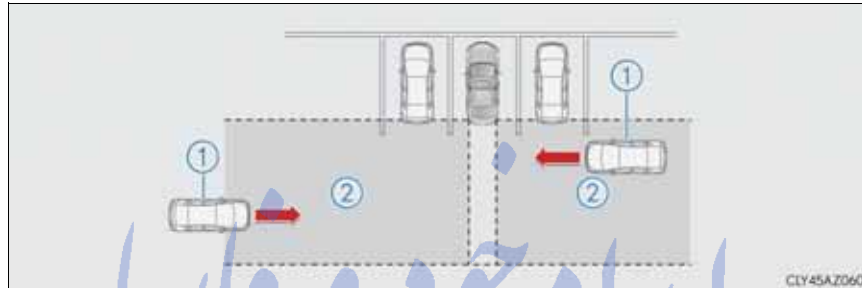

① Approaching vehicles ② Detection areas

⚠ CAUTION

■ Cautions regarding the use of the system

The driver is solely responsible for safe driving. Always drive safely, taking care to observe your surroundings.

The Rear Traffic Alert function is only an assist and is not a replacement for careful driving. Driver must be careful when backing up, even when using Rear Traffic Alert function. The driver's own visual confirmation of behind you and your vehicle is necessary and be sure there are no pedestrians, other vehicles etc. before backing up. Failure to do so could cause death or serious injury.

According to conditions, the system may not function correctly. Therefore the driver's own visual confirmation of safety is necessary.

The Rear Crossing Traffic Alert function detection areas

The areas that vehicles can be detected in are outlined below.

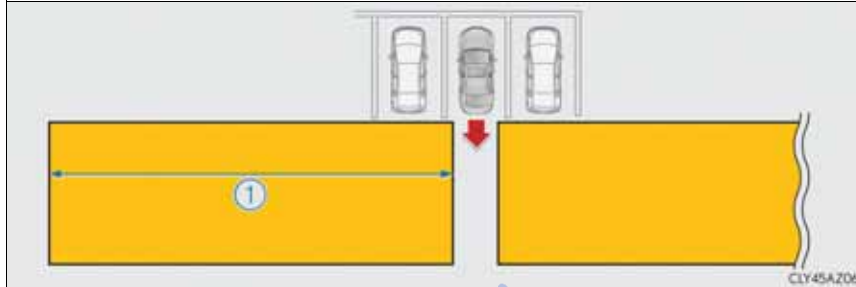

To give the driver a more consistent time to react, the buzzer can alert for faster vehicles from farther away.

Example:

Approaching vehicle	Speed	① Approximate alert distance
Fast	28 km/h (18 mph)	20 m (65 ft.)
Slow	8 km/h (5 mph)	5.5 m (18 ft.)

- The Rear Crossing Traffic Alert function is operational when
 - The BSM main switch is set to on.
 - The shift lever is in R.
 - Vehicle speed is less than approximately 8 km/h (5 mph).
 - Approaching vehicle speed is between approximately 8 km/h (5 mph) and 28 km/h (18 mph).

- Conditions under which the Rear Crossing Traffic Alert function will not detect a vehicle

The Rear Crossing Traffic Alert function is not designed to detect the following types of vehicles and/or objects.

- Small motorcycles, bicycles, pedestrians etc.*
- Vehicles approaching from directly behind
- Guardrails, walls, signs, parked vehicles and similar stationary objects*
- Vehicles moving away from your vehicle
- Vehicles approaching from the parking spaces next to your vehicle*
- Vehicles backing up in the parking space next to your vehicle

*: Depending on conditions, detection of a vehicle and/or object may occur.

- Conditions under which the Rear Crossing Traffic Alert function may not function correctly

The Rear Crossing Traffic Alert function may not detect vehicles correctly in the following conditions:

- During bad weather such as heavy rain, fog, snow etc.
- When ice or mud etc. is attached to the rear bumper
- When multiple vehicles approach continuously
- Shallow angle parking
- When a vehicle is approaching at high speed
- When parking on a steep incline, such as hills, a dip in the road etc.
- Directly after the BSM main switch is set to on
- When your vehicle is towing a trailer
- Directly after the engine is started with the BSM main switch on
- Vehicles that the sensors cannot detect because of obstacles

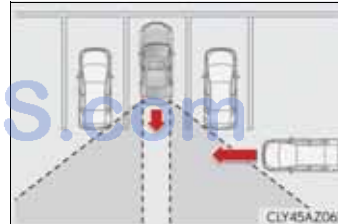

Winter driving tips

Carry out the necessary preparations and inspections before driving the vehicle in winter. Always drive the vehicle in a manner appropriate to the prevailing weather conditions.

Preparation for winter

- Use fluids that are appropriate to the prevailing outside temperatures.
 - Engine oil
 - Engine coolant
 - Washer fluid
- Have a service technician inspect the condition of the battery.
- Have the vehicle fitted with four snow tires or purchase a set of tire chains for the rear tires.*

Ensure that all tires are the specified size and brand, and that chains match the size of the tires.

*: Tire chains cannot be mounted on the 18-inch tires.

Before driving the vehicle

Perform the following according to the driving conditions:

- Do not try to forcibly open a window or move a wiper that is frozen. Pour warm water over the frozen area to melt the ice. Wipe away the water immediately to prevent it from freezing.
- To ensure proper operation of the climate control system fan, remove any snow that has accumulated on the air inlet vents in front of the windshield.
- Check for and remove any excess ice or snow that may have accumulated on the exterior lights, vehicle's roof, chassis, around the tires or on the brakes.
- Remove any snow or mud from the bottom of your shoes before getting in the vehicle.

When driving the vehicle

Accelerate the vehicle slowly, keep a safe distance between you and the vehicle ahead, and drive at a reduced speed suitable to road conditions.

When parking the vehicle

Park the vehicle and move the shift lever to P without setting the parking brake. The parking brake may freeze up, preventing it from being released. If necessary, block the wheels to prevent inadvertent sliding or creeping.

Selecting tire chains

- ▶ Except vehicles with 18-inch tires

Use the correct tire chain size when mounting the tire chains.
Chain size is regulated for each tire size.

- ① Side chain
(3 mm [0.12 in.] in diameter)
- ② Cross chain
(4 mm [0.16 in.] in diameter)

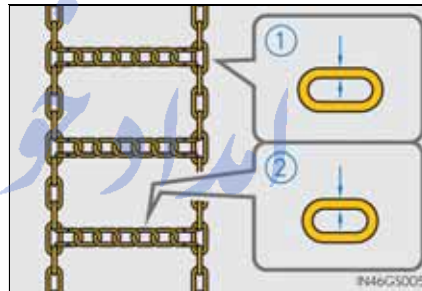

- ▶ Vehicles with 18-inch tires

Tire chains cannot be mounted on the 18-inch tires. تلفن شبانه ۰۲۱۸۸۶۲۸۸۸۸۸۸۸
Snow tires should be used instead.

Regulations on the use of tire chains

Regulations regarding the use of tire chains vary depending on location and type of road. Always check local regulations before installing chains.

■ Tire chain installation

Observe the following precautions when installing and removing chains:

- Install and remove tire chains in a safe location.
- Install tire chains on the rear tires. Do not install tire chains on the front tires.
- Install tire chains on rear tires as tightly as possible. Retighten chains after driving 0.5 — 1.0 km (1/4 — 1/2 mile).
- Install tire chains following the instructions provided with the tire chains.

 CAUTION

■ Driving with snow tires

Observe the following precautions to reduce the risk of accidents. Failure to do so may result in a loss of vehicle control and cause death or serious injury.

- Use tires of the specified size.
- Maintain the recommended level of air pressure.
- Do not drive at speeds in excess of the speed limit or the speed limit specified for the snow tires being used.
- Use snow tires on all, not just some wheels.

■ Driving with tire chains (except vehicles with 18-inch tires)

Observe the following precautions to reduce the risk of accidents. Failure to do so may result in the vehicle being unable to be driven safely, and may cause death or serious injury.

- Do not drive in excess of the speed limit specified for the tire chains being used, or 50 km/h (30 mph), whichever is lower.
- Avoid driving on bumpy road surfaces or over potholes.
- Avoid sudden acceleration, abrupt steering, sudden braking and shifting operations that cause sudden engine braking.
- Slow down sufficiently before entering a curve to ensure that vehicle control is maintained.
- Do not use LDA (Lane Departure Alert) system.

 NOTICE

■ Repairing or replacing snow tires

Request repairs or replacement of snow tires from Lexus dealers or legitimate tire retailers. This is because the removal and attachment of snow tires affects the operation of the tire pressure warning valves and transmitters.

■ Fitting tire chains (except vehicles with 18-inch tires)

The tire pressure warning valves and transmitters may not function correctly when tire chains are fitted.

امداد خودرو فارما

تلفن شبانه روزی: ۰۲۱-۸۸۸۶۲۰۸۵

FarmaSOS.com

4

Driving

5-1. Basic Operations	
Lexus Display Audio System	292
Steering wheel audio switches	298
USB/AUX ports.....	299
5-2. Setup	
Setup menu	300
General settings	301
Voice settings	304
Display settings.....	305
5-3. Using the audio system	
Selecting the audio source.....	306
Optimal use of the audio system.....	307
Audio settings	308
Audio menu screen operation.....	312
5-4. Using the radio	
Radio operation.....	315
5-5. Playing an audio CD and MP3/WMA/AAC discs	
CD player operation.....	317

Lexus Display Audio system

5

5-6. Using an external device	5-9. Bluetooth® Phone
Listening to an iPod 324	Using a Bluetooth®
Using USB memory	Phone 343
device 327	Making a call 345
Using the AUX port 332	Receiving a call 348
5-7. Connecting Bluetooth®	Speaking on the phone..... 349
Steps for using Bluetooth®	Using a Bluetooth® phone
devices 333	messages 351
Registering a Bluetooth®	Using the steering wheel
device 335	switches 354
Selecting a Bluetooth®	Bluetooth® phone settings 355
device 336	5-10. Phonebook
Connecting a Bluetooth®	Contact settings..... 357
audio player 337	Messaging setting 360
Connecting a Bluetooth®	5-11. Bluetooth®
phone 338	Bluetooth® 361
Displaying a Bluetooth®	5-12. Other function
device details 339	“Information” screen 366
Detailed Bluetooth®	MirrorLink™ 367
settings 340	USB photo 369
5-8. Bluetooth® Audio	Speech command system.. 371
Listening to Bluetooth®	
Audio 341	

Lexus Display Audio System*

Use the following buttons to start listening to the audio system.

Display Audio operation buttons

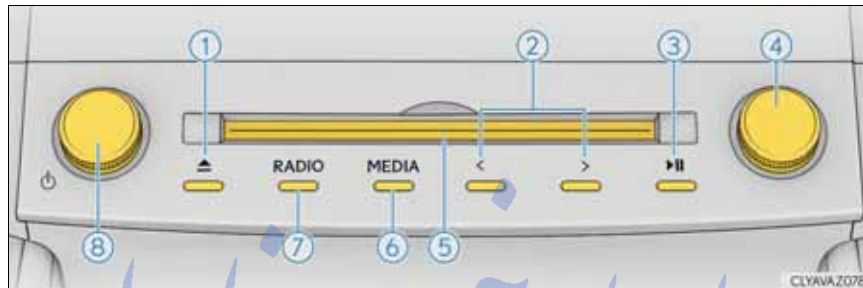

- ① Eject a disc.
- ② Seek up or down for a radio station, or to access a desired track or file.
- ③ Except radio and A/V mode: Pause or resume playing a track.
Radio and A/V mode: Turn mute on/off
- ④ Select a radio station band, track or file.
- ⑤ Disc slot
- ⑥ Display the media top screen.
- ⑦ Display the radio top screen.
- ⑧ Press to turn the audio system on/off, and turn to adjust the volume.

*: If equipped

■ “MENU” screen

To display the “MENU” screen, press  button on the controller unit.



Button	Function
“Audio”	Display the audio top screen (→P. 315, 317, 324, 327, 332, 341)
“Climate”	Automatic air conditioning system (→P. 374)
“Telephone”	Display the phone top screen (→P. 343)
“Car”	Consumption information (→P. 107)
“Info”	Display the “Information” screen (→P. 366)
“Setup”	Setup menu (→P. 300)
“Display”	Display settings (→P. 305)

Lexus Display Audio controller

By using the Lexus Display Audio controller, you can control the audio system, hands-free system, etc.

- ① Display the “Source” screen or audio top screen (→P. 306)
- ② Display the “MENU” screen (→P. 293)
- ③ Display the previous screen
- ④ Turn or move the controller to select a function and number.

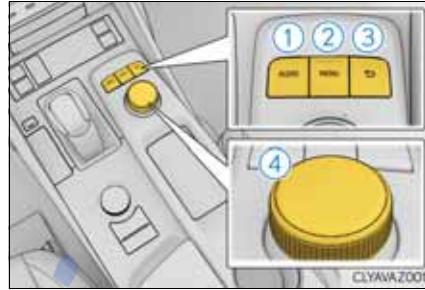

Move the controller to display the left or right side of screen.

Push the controller to enter the selected function and number.

■ Using the Lexus Display Audio controller

- ① Select: Turn or move the controller.
- ② Enter: Push the controller.

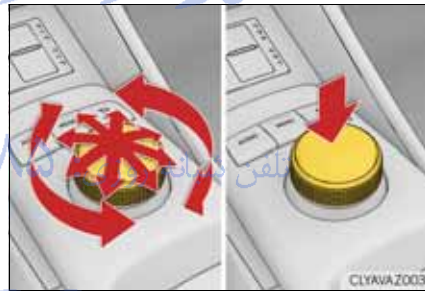

FarmaSOS.com

■ Basic screen operation

When a list is displayed, use the appropriate button to scroll through the list.

- ① Indicator turns on when you can select the list by turning the controller.
- ② Indicator turns on when you can return to the previous screen by pressing the  button.
- ③ Indicator turns on when you can move the controller left to view additional screen text.
- ④ Indicator turns on when you can move the controller right to view additional screen text.



تلفن شبانه روزی: ۰۲۱-۸۸۶۲۰۸۵

FarmaSOS.com

Inputting letters and numbers

■ Input mode

Letters and numbers are inputted via the screen.

- ① Turn the controller to select the desired character and press the controller to input the character.
- ② When this indicator is shown, you can change input fields by moving the controller forward.
- ③ When this indicator is shown, you can change character types by moving the controller to the right and then selecting the desired character type.
- ④ Select to erase characters one by one. Select and hold to erase all characters.
- ⑤ Select to complete data input.

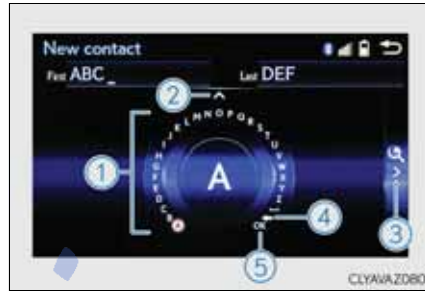

■ Input field mode

When in the input field you can move the cursor to the desired position.

- ① Turn the controller to move the cursor left or right.
- ② When this indicator is shown, you can move the cursor to the right input field by moving the controller to the right.
- ③ When this indicator is shown, you can move the cursor to the left input field by moving the controller to the left.
- ④ When this indicator is shown, you can change to input mode by moving the controller backward.



- When using the screen
 - Under extremely cold conditions, the Lexus Display Audio controller may react slowly.
 - If the screen is cold, the display may be dark, or the system may seem to be operating slightly slower than normal.
 - The screen may seem dark and hard to see when viewed through sunglasses. Change your angle of viewing, adjust the display on the “Display” screen (→P. 305) or remove your sunglasses.
- Using cellular phones

Interference may be heard through the audio system's speakers if a cellular phone is being used inside or close to the vehicle while the audio system is operating.

 CAUTION

- Using the Lexus Display Audio controller

Be careful when touching the Lexus Display Audio controller in extreme temperatures as it may become very hot or cold due to the temperature inside the vehicle.
- Laser product

This product is a class 1 laser product.

Do not open the cover of the player or attempt to repair the unit yourself. Refer servicing to qualified personnel.

 NOTICE

- To prevent Lexus Display Audio controller malfunction
 - Do not allow the Lexus Display Audio controller to come into contact with food, liquid, stickers or lit cigarettes as doing so may cause it to change color, emit a strange odor or stop functioning.
 - Do not subject the Lexus Display Audio controller to excessive pressure or strong impact as the controller may bend or break off.
- To prevent battery discharge

Do not leave the audio system on longer than necessary when the engine is off.
- To avoid damaging the audio system

Take care not to spill drinks or other fluids on the audio system.

Steering wheel audio switches

Some audio features can be controlled using the switches on the steering wheel.

Operation may differ depending on the type of audio system or navigation system. For details, refer to the manual provided with the audio system or navigation system.

Operating the audio system using the steering wheel switches

- ① Volume switch
 - Increases/decreases volume
 - Press and hold: Continuously increases/decreases volume
- ② Radio mode:
 - Press (except manual mode): Select a radio station
 - Press (manual mode): Seek up/down
 - Press and hold (manual mode): Continuously seek up/down
- ③ “MODE” switch
 - Turns the power on, selects audio source
 - Press and hold this switch to mute or pause the current operation. To cancel the mute or pause, press and hold.

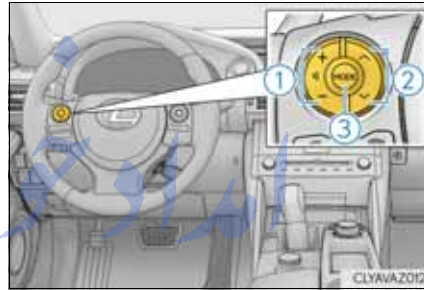

⚠ CAUTION

- To reduce the risk of an accident
Exercise care when operating the audio switches on the steering wheel.

USB/AUX ports

Connect an iPod, USB memory device or portable audio player to the USB/AUX port as indicated below. Select “iPod”, “USB”, “AUX” or “A/V” on the audio source selection screen and the device can be operated via Display Audio system.

Connecting using the USB/AUX port

■ iPod

Open the cover and connect an iPod using an iPod cable.

Turn on the power of the iPod if it is not turned on.

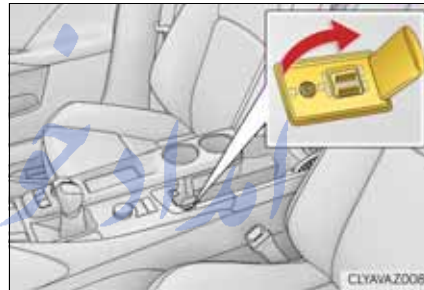

■ USB memory

Open the cover and connect the USB memory device.

Turn on the power of the USB memory device if it is not turned on.

■ Portable audio player

Open the cover and connect the portable audio player.

Turn on the power of the portable audio player if it is not turned on.

■ iPod video and A/V

To operate the video functions such as iPod video or A/V, a 4-pole AUX cable is necessary. However, depending on the cable specifications, the video function may not work properly. For more information consult any authorized Lexus dealer or repairer, or another duly qualified and equipped professional.

⚠ CAUTION

■ While driving

Do not connect a device or operate the device controls.

Setup menu

The Display Audio system can be adjusted to the desired settings.

Display “Setup” screen

Go to “Setup”:  → “Setup”

- ① Change the settings for operation sounds, screen animation, etc. (→P. 301)
- ② Adjust the settings for voice guidance volume. (→P. 304)
- ③ Change the settings for registering, removing, connecting and disconnecting Bluetooth® devices. (→P. 334)
- ④ Change the settings for FM radio, iPod, etc. (→P. 308)
- ⑤ Change the settings for vehicle customization. (→P. 549)
- ⑥ Change the settings for phone sound, phonebook, etc. (→P. 355)

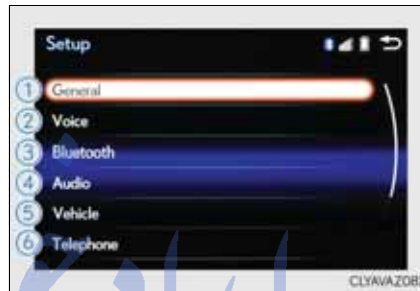

FarmaSOS.com

General settings

Settings are available for adjusting the operation sounds, screen animation, etc.

Screen for general settings

Go to “General settings”:  → “Setup” → “General”

① Change language.

The selectable languages may differ depending on the model or region.

② Change the distance unit.

③ Set the beep sound on/off.

④ Change the button color.

⑤ Change the startup image and screen off image. (→P. 302)

⑥ Set the animation effect on/off.

⑦ Delete personal data (→P. 303)

⑧ Update program versions.

For details, contact any authorized Lexus dealer or repairer, or another duly qualified and equipped professional.

⑨ Update gracenote database versions.

For details, contact any authorized Lexus dealer or repairer, or another duly qualified and equipped professional.

⑩ Display the open source license.



Customizing images

- 1 Go to “Customize images”:  → “Setup” → “General” → “Customize images”
- 2 Select “Set images” and then select the desired image.
 - 1 Set as startup image.
 - 2 Set as screen off image.
 - 3 Set as startup image and screen off image.

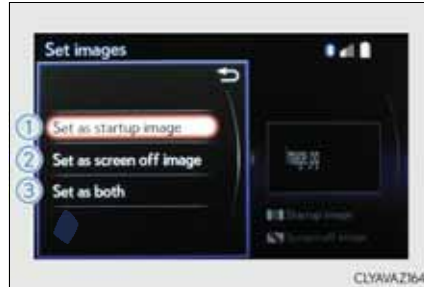

- Adding an image
 - 1 Connect a USB memory device. (→P. 299)
 - 2 Select “Copy from USB” on the “Customize images” screen and then select the desired image.
 - 3 Move the controller to the left and then select “Copy”.

Up to 10 images can be downloaded.
- Deleting images

Select “Delete images” on the “Customize images” screen and then select the desired images.

- USB memory

When saving the images to a USB memory device, name the folder that the images are saved to “Image”.

- Compatible device formats

The following device format can be used:

- The image’s file format must be JPEG
- USB communication format: USB2.0 FS (480 Mbps)
- File system format: FAT16/32 (Windows)
- Correspondence class: Mass storage class

- JPEG file compatibility

Compatible image size: Maximum 10MB

**NOTICE**

- If the console box lid cannot be fully closed
→P. 331
- To prevent damage to the USB memory device or its terminals
→P. 331

Deleting personal data

- 1  → “Setup” → “General” → “Delete personal data”
- 2 Select “Delete”.

Check carefully beforehand, as data cannot be retrieved once deleted.

The following personal data will be deleted or changed to its default settings.

- Phonebook data
- Voice tag
- Call history data
- Favorite data
- Bluetooth® devices data
- Phone sound settings
- Detailed Bluetooth® settings
- Audio/video setting
- Preset switch data
- Last used radio station
- Customized image data
- FM info setting
- iPod tagging information
- Software update history
- Software update detail information
- Phone display setting
- Contact/call history setting
- Messaging setting

Voice settings

This screen is used for guidance for speech command system setting.

Go to “Voice settings”:  → “Setup” → “Voice”

- ① Adjust the voice guidance volume setting.

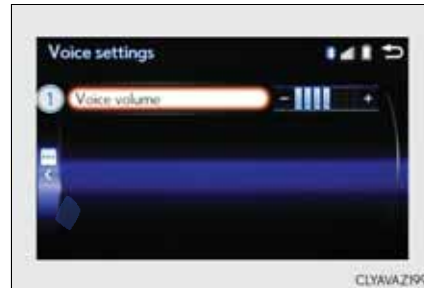

- Return to the default settings
Move the controller to the left and select “Default”.

تلفن شبانه روزی: ۰۲۱-۸۸۶۲۰۸۵

FarmaSOS.com

Display settings

Settings are available for adjusting the contrast and brightness of the screen.

The display can also be turned off.



Screen for display settings

Go to “Display”:  → “Display”

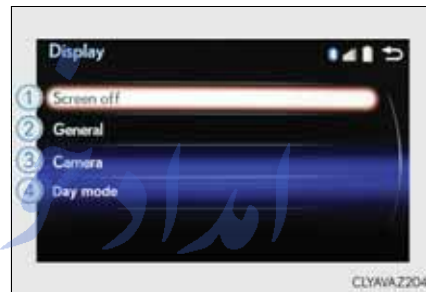
- ① Turn off screen.
- ② Adjust screen quality.
- ③ Adjust screen quality of the rear view monitor camera.
- ④ Change to day mode.



Screen off

This setting turns the screen off. To turn it on, press any button such as  or .

If a screen off image has been set, the set image will be displayed.

Day mode

When the headlights are turned on, the screen dims.

However, the screen can be switched to day mode by selecting “Day mode”.

The screen will stay in day mode when the headlights are turned on until “Day mode” is selecting again.

Adjusting the screen quality

- ① Select “General” or “Camera” on the “Display” screen or select “Display” on each audio menu screen. (→P. 312)
- ② Adjust the display as desired by turning the controller clockwise (+) or counterclockwise (-).

To select “Contrast”, “Brightness”, “Colour” or “Tone”, move the controller to the left. (when “Display” is selected, “Colour” and “Tone” are available.)

- Changing the sample image (when “General” is selected)
Move the controller to the right and select the desired sample image.

امداد خودرو فارما



تلفن شبانه روزی: ۰۲۱-۸۸۸۶۲۰۸۵

FarmaSOS.com

Selecting the audio source

Switching between audio sources such as radio and CD are explained in this section.

Changing audio source

- 1 Press the  button to display the “Source” screen.
If the “Source” screen is not displayed, press the  button again.
- 2 Select the desired audio source.
The audio source can be selected by pressing the “RADIO” or “MEDIA” button.

Using the steering wheel switches to change audio sources

Press the “MODE” switch when the audio system is turned on. The audio source changes each time the “MODE” switch is pressed.

■ Rearranging the list

The listing order of the source list can be rearranged.

- 1 Move the controller to the left while on the “Source” screen.
- 2 Select “Audio source select”.
- 3 Select an item you wish to move and then select where to move the item to.

FarmaSOS.com

Optimal use of the audio system

On the “Sound settings” screen, sound quality (Treble/Mid/Bass), volume balance and DSP settings can be adjusted.

How to adjust the sound settings and sound quality

Go to “Sound settings”:  → “Setup” → “Audio” → “Sound settings”

To change between the sound setting screen and DSP setting screen, move the controller to the right then select the desired screen.

▶ “Sound”

- ① ② ③ Adjust the treble, mid or bass.
- ④ Adjust the front/rear audio balance.
- ⑤ Adjust the left/right audio balance.

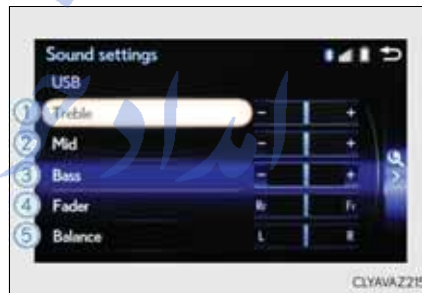

▶ “DSP”

- ① Set the automatic sound levelizer (ASL) on/off



- The sound quality level is adjusted individually
The treble, mid and bass levels can be adjusted for each audio mode separately.
- About Automatic Sound Levelizer (ASL)
ASL automatically adjusts the volume and tone quality according to the vehicle speed.

Audio settings

Screen for audio settings

Go to “Audio settings”:  → “Setup” → “Audio”

- ① Change sound settings (→P. 307)
- ② Change FM radio settings (→P. 309)
- ③ Change DAB settings (→P. 309)
- ④ Change iPod settings (→P. 310)
- ⑤ Change USB settings (→P. 310)
- ⑥ Change A/V settings (→P. 311)
- ⑦ Change the cover art settings (→P. 311)



تلفن شبانه روزی: ۰۲۱-۸۸۸۶۲۰۸۵

FarmaSOS.com

Changing FM radio settings

- ① Change the order of the station list
- ② Select to set the traffic announcement interrupt operation on/off
- ③ Select to set the alternative frequency network following operation on/off



When traffic announcement is set to on, the radio will begin seeking a TP station. (→P. 316)

When alternative frequency is set to on, a station providing good reception is automatically selected if current reception worsens.

- ④ Select to set the region code change operation on/off
- ⑤ Select to set the FM Radio text feature on/off

When region code change operation is set to on, programs will switch over to a broadcasting station within the same local program network.

Changing DAB settings

- ① Update the DAB station list
- ② Select to set the L-band on/off
- ③ Select to set traffic announcement operation on/off



When set to off, the physical channel range for tune operations is limited to Band III except preset operations.

When set to on, the physical channel range for tune operations is Band III and L-band.

When traffic announcement is set to on, the tuner will automatically seek a station that regularly broadcasts traffic information and the station will broadcast when the traffic information program starts.

- ④ Select to set alternative frequency network following operation on/off
- ⑤ Select to set the DAB radio text feature on/off

When alternative frequency is set to on, a station providing good reception is automatically selected if current reception worsens.

Changing iPod settings

- ① Change the screen size (video mode)
- ② Change the cover art settings (→P. 311)
- ③ Adjust the screen quality (video mode) (→P. 305)
- ④ Change video sound input port



Changing USB settings

- ① Change the screen size (video mode)
- ② Change the cover art settings (→P. 311)
- ③ Adjust the screen quality (video mode) (→P. 305)

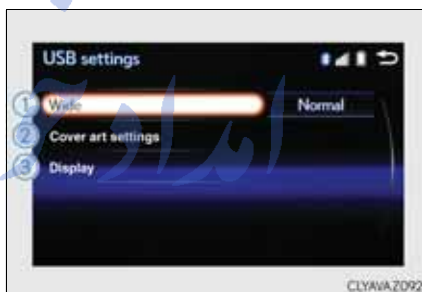

تلفن شبانه روزی: ۰۲۱-۸۸۶۲۰۸۵

FarmaSOS.com

Changing A/V settings

- ① Change the screen size
- ② Change the video signal
- ③ Adjust the screen quality (→P. 305)



Changing the cover art settings

- ① Select to set the cover art display of DISC mode on/off.
- ② Select to set the cover art display of USB mode on/off.
- ③ Change the priority of the cover art display for USB mode.
- ④ Select to set the cover art display of iPod mode on/off.
- ⑤ Change the priority of the cover art display for iPod mode.

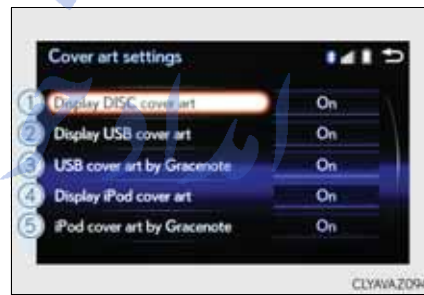

Audio menu screen operation

You can change the settings and control functions for each audio source.

Audio menu screen

To display the audio menu screen, move the controller to the left while on an audio top screen.

► FM or AM radio

- ① Seek a station of the nearest frequency (stops when a station is found) (manual mode)
- ② Change FM radio settings (→P. 309)
- ③ Change DAB settings (→P. 309)

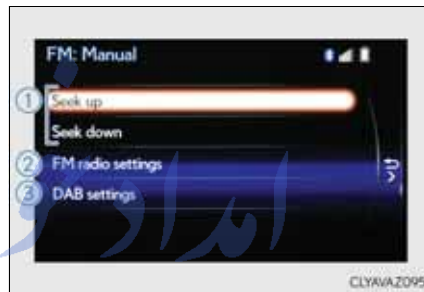

► DAB

- ① Adjust the playback offset time on time shift mode
- ② Cancel time shift operation
- ③ Select an ensemble (manual mode)
- ④ Select a service (manual mode)
- ⑤ Change FM radio settings (→P. 309)
- ⑥ Change DAB settings (→P. 309)



► CD, MP3/WMA/AAC disc, USB, Bluetooth® or iPod

- ① Play or pause a track/file/song
- ② Select a track/file/song
- ③ Select a folder/album (MP3/WMA/AAC disc or USB)
- ④ Select and hold: Fast-forward or reverse a track/file/song
- ⑤ Select a repeat mode. (→P. 314)
- ⑥ Select a random/shuffle play mode. (→P. 314)
- ⑦ Select the full screen mode. (USB video or iPod video mode)
- ⑧ Change USB settings (USB) (→P. 310)
- ⑨ Change iPod settings (iPod) (→P. 310)
- ⑩ Connect a Bluetooth® device (Bluetooth®) (→P. 336)
- ⑪ Change the cover art settings (→P. 311) (CD or MP3/WMA/AAC disc)





► AUX or A/V

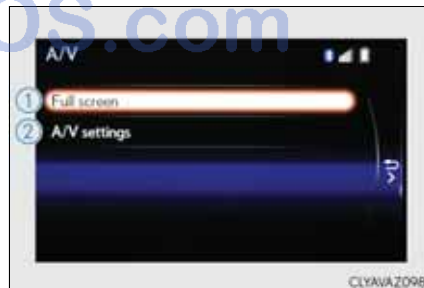

- ① Select the full screen mode (A/V)
- ② Change A/V settings (A/V) (→P. 311)



Repeat play

Mode	Action	Target audio source
	File/track/song repeat	All media
	Folder repeat	MP3/WMA/AAC disc, USB
	Album repeat	USB, Bluetooth®

Random/shuffle playback

Mode	Action	Target audio source
	Random/shuffle play of the disc/ folder/album	All media
	Random play of all folders	MP3/WMA/AAC disc, USB
	Random/shuffle play of all albums	USB, iPod, Bluetooth®

تلفن شبانه روزی: ۰۲۱-۸۸۶۲۰۸۵

FarmaSOS.com

Radio operation

Select “AM”, “FM” or “DAB” on the “Source” screen to begin listening to the radio.

Radio top screen

Pressing the “RADIO” button displays the radio top screen from any screen of the selected source.

- Menu screen
→P. 312

Changing the top screen mode

Move the controller to the right to display the right menu screen.

- ① Change the radio top screen to the preset selection screen.
- ② Change the radio top screen to the station list selection screen. (FM and DAB)
- ③ Change the radio top screen to the manual selection screen.
- ④ Change the radio top screen to the time shift operation screen. (DAB) (→P. 316)

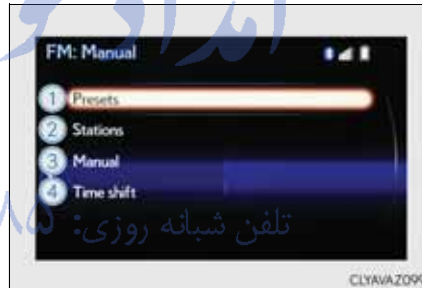

Selecting a station

Tune in to the desired station using one of the following methods.

- Seek tuning

Manual screen: Press or press and hold “<” or “>” button.

Preset or station list screen: Press and hold “<” or “>” button.

Seek tuning can also be operated on the menu screen. (→P. 312)

The radio will begin seeking up or down for a station of the nearest frequency and will stop when a station is found.

- Manual tuning (manual screen)

Turn the right side knob (left-hand drive vehicle), left side knob (right-hand drive vehicle) on the audio panel or turn the controller.
- Station list (preset or station list screen)

Select the desired station by pressing “<” or “>”, turn the right side knob (left-hand drive vehicle), left side knob (right-hand drive vehicle) on the audio panel or controller.

Setting station presets (preset screen)

Radio stations can be preset.

- 1 Search for desired stations.
- 2 Turn the controller to select one of the preset stations and then press the controller until you hear a beep while on the preset selection screen.

Time shift operation (DAB)

The broadcast you are currently listening to can be re-listened to at any time.

- 1 Move the controller to the right and then select “Time shift”.
- 2 Turn the right side knob (left-hand drive vehicle) or left side knob (right-hand drive vehicle) on the audio panel to set the desired offset.

An offset playback time can also be set on the menu screen. (→P. 312)

To cancel the time shift operation while in time shift mode, move the controller to the left and select “Time shift off”. If the time shift display is left showing “-0' 00” for 6 seconds without any operation, the time shift operation will be canceled.

- Reception sensitivity
 - Maintaining perfect radio reception at all times is difficult due to the continually changing position of the antenna, differences in signal strength and surrounding objects, such as trains, transmitters, etc.
 - The radio antenna is mounted inside the rear window. To maintain clear radio reception, do not attach metallic window tinting or other metallic objects to the antenna wire mounted inside the rear window.
- Traffic announcement operation

When traffic announcement is set to on, “TP” will appear on the screen and the radio will begin seeking a TP station. If the radio seeks out a TP station, the program name will appear on the screen. If a traffic announcement station is received, the radio will be switched to the traffic information program automatically. When the program ends, the initial operation will resume.

CD player operation

Insert a disc, press the “MEDIA” button or select “DISC” on the “Source” screen with a disc inserted to begin listening to a disc.

Audio disc top screen

Pressing the “MEDIA” button displays the audio disc top screen from any screen of the selected source.

- Menu screen
→P. 312
- Selecting a track/file
Press the “<” or “>” button, turn the right side knob (left-hand drive vehicle) or left side knob (right-hand drive vehicle) on the audio panel to select the desired track/file number.
To fast-forward or rewind, press and hold the “<” or “>” button.
- Selecting the track by the list (CD)
Move the controller to the right and then select the desired track.
- Selecting a folder (MP3/WMA/AAC disc)
 - 1 Move the controller to the right and then select “Folders”.
 - 2 Select the desired folder. Then select a file to begin using the selected folder.
- Selecting a file by the selected folder (MP3/WMA/AAC disc)
 - 1 Move the controller to the right and then select “Files”.
 - 2 Select the desired file.

■ Error messages

If an error message is displayed, refer to the following table and take the appropriate measures. If the problem is not rectified, take the vehicle to any authorized Lexus dealer or repairer, or another duly qualified and equipped professional.

Message	Cause	Correction procedures
“Check disc”	<ul style="list-style-type: none"> • The disc is dirty or damaged. • The disc is inserted upside down. • The disc is not playable with the player. 	<ul style="list-style-type: none"> • Clean the disc. • Insert the disc correctly. • Confirm the disc is playable with the player.
“DISC error”	There is a malfunction within the system.	Eject the disc.
“No music files found.”	No playable data is included on the disc.	Eject the disc.

■ Discs that can be used

Discs with the marks shown below can be used. Playback may not be possible depending on recording format or disc features, or due to scratches, dirt or deterioration.



CDs with copy-protection features may not play correctly.

■ Music disc player protection feature

To protect the internal components, playback is automatically stopped when a problem is detected.

■ If a disc is left inside the Music disc player or in the ejected position for extended periods

Disc may be damaged and may not play properly.

■ Lens cleaners

Do not use lens cleaners. Doing so may damage the Music disc player.

■ MP3, WMA and AAC files

MP3 (MPEG Audio LAYER3) is a standard audio compression format.

Files can be compressed to approximately 1/10 of their original size by using MP3 compression.

WMA (Windows Media Audio) is a Microsoft audio compression format.

This format compresses audio data to a size smaller than that of the MP3 format.

AAC is short for Advanced Audio Coding and refers to an audio compression technology standard used with MPEG2 and MPEG4.

MP3, WMA and AAC file and media/formats compatibility are limited.

- MP3 file compatibility
 - Compatible standards
MP3 (MPEG1 LAYER3, MPEG2 LSF LAYER3)
 - Compatible sampling frequencies
MPEG1 LAYER3: 32, 44.1, 48 (kHz)
MPEG2 LSF LAYER3: 16, 22.05, 24 (kHz)
 - Compatible bit rates (compatible with VBR)
MPEG1 LAYER3: 32-320 (kbps)
MPEG2 LSF LAYER3: 8-160 (kbps)
 - Compatible channel modes: stereo, joint stereo, dual channel and monaural
- WMA file compatibility
 - Compatible standards
WMA Ver. 7, 8, 9 (only compatible with Windows Media Audio Standard)
 - Compatible sampling frequencies
32, 44.1, 48 (kHz)
 - Compatible bit rates (only compatible with 2-channel playback)
Ver. 7, 8: CBR 48-192 (kbps)
Ver. 9: CBR 48-320 (kbps)
- AAC file compatibility
 - Compatible standards
MPEG4/AAC-LC
 - Compatible sampling frequencies
11.025/12/16/22.05/24/32/44.1/48 (kHz)
 - Compatible bit rates
16-320 (kbps)
 - Compatible channel modes: 1ch and 2ch
- Compatible media
Media that can be used for MP3, WMA and AAC playback are CD-Rs and CD- RWs.
Playback in some instances may not be possible if the CD-R or CD-RW is not finalized. Playback may not be possible or the audio may jump if the disc is scratched or marked with fingerprints.
- Compatible disc formats
The following disc formats can be used.
 - Disc formats: CD-ROM Mode 1 and Mode 2
CD-ROM XA Mode 2, Form 1 and Form 2
 - File formats: ISO9660 Level 1, Level 2, (Romeo, Joliet)
UDF (2.01 or lower)
 MP3, WMA and AAC files written in any format other than those listed above may not play correctly, and their file names and folder names may not be displayed correctly.

Items related to standards and limitations are as follows.

 - Maximum directory hierarchy: 8 levels (including the root)
 - Maximum length of folder names/file names: 32 characters
 - Maximum number of folders: 192 (including the root)
 - Maximum number of files per disc: 255

- File names

The only files that can be recognized as MP3/WMA/AAC and played are those with the extension .mp3, .wma or .m4a.
- Discs containing multi-session recordings

As the audio system is compatible with multi session discs, it is possible to play discs that contain MP3, WMA and AAC files. However, only the first session can be played.
- ID3, WMA and AAC tags

ID3 tags can be added to MP3 files, making it possible to record the track title, artist name, etc.

The system is compatible with ID3 Ver. 1.0, 1.1, and Ver. 2.2, 2.3 ID3 tags. (The number of characters is based on ID3 Ver. 1.0 and 1.1.)

WMA tags can be added to WMA files, making it possible to record the track title and artist name in the same way as with ID3 tags.

AAC tags can be added to AAC files, making it possible to record the track title and artist name in the same way as with ID3 tags.
- MP3, WMA and AAC playback

When a disc containing MP3, WMA or AAC files is inserted, all files on the disc are first checked. Once the file check is finished, the first MP3, WMA or AAC file is played. To make the file check finish more quickly, we recommend you do not write any files to the disc other than MP3, WMA or AAC files or create any unnecessary folders.

Discs that contain a mixture of music data and MP3, WMA or AAC format data cannot be played.
- Extensions

If the file extensions .mp3, .wma and .m4a are used for files other than MP3, WMA and AAC files, they may be mistakenly recognized and played as MP3, WMA and AAC files. This may result in large amounts of interference and damage to the speakers.
- Playback
 - To play MP3 files with steady sound quality, we recommend a fixed bit rate of at least 128 kbps and a sampling frequency of 44.1 kHz.
 - CD-R or CD-RW playback may not be possible in some instances, depending on the characteristics of the disc.
 - There is a wide variety of freeware and other encoding software for MP3, WMA and AAC files on the market, and depending on the status of the encoding and the file format, poor sound quality or noise at the start of playback may result. In some cases, playback may not be possible at all.
 - When files other than MP3, WMA or AAC files are recorded on a disc, it may take more time to recognize the disc and in some cases, playback may not be possible at all.
 - Microsoft, Windows, and Windows Media are the registered trademarks of Microsoft Corporation in the U.S.A. and other countries.

- The Gracenote® media database
 - Gracenote, the Gracenote logo and logotype, “Powered by Gracenote”, MusicID, Playlist Plus and MediaVOCS are either registered trademarks or trademarks of Gracenote, Inc. in the United States



Gracenote® End User License Agreement - Music

This application or device contains software from Gracenote, Inc. of Emeryville, California (“Gracenote”). The software from Gracenote (the “Gracenote Software”) enables this application to perform disc and/or file identification and obtain music-related information, including name, artist, track, and title information (“Gracenote Data”) from online servers or embedded databases (collectively, “Gracenote Servers”) and to perform other functions. You may use Gracenote Data only by means of the intended End-User functions of this application or device.

This application or device may contain content belonging to Gracenote’s providers. If so, all of the restrictions set forth herein with respect to Gracenote Data shall also apply to such content and such content providers shall be entitled to all of the benefits and protections set forth herein that are available to Gracenote.

You agree that you will use Gracenote Data, the Gracenote Software, and Gracenote Servers for your own personal non-commercial use only. You agree not to assign, copy, transfer or transmit the Gracenote Software or any Gracenote Data to any third party. YOU AGREE NOT TO USE OR EXPLOIT GRACENOTE DATA, THE GRACENOTE SOFTWARE, OR GRACENOTE SERVERS, EXCEPT AS EXPRESSLY PERMITTED HEREIN.

You agree that your non-exclusive license to use the Gracenote Data, the Gracenote Software, and Gracenote Servers will terminate if you violate these restrictions. If your license terminates, you agree to cease any and all use of the Gracenote Data, the Gracenote Software, and Gracenote Servers. Gracenote reserves all rights in Gracenote Data, the Gracenote Software, and the Gracenote Servers, including all ownership rights. Under no circumstances will Gracenote become liable for any payment to you for any information that you provide. You agree that Gracenote, Inc. may enforce its rights under this Agreement against you directly in its own name.

FarmaSOS.com

The Gracenote service uses a unique identifier to track queries for statistical purposes. The purpose of a randomly assigned numeric identifier is to allow the Gracenote service to count queries without knowing anything about who you are. For more information, see the web page for the Gracenote Privacy Policy for the Gracenote service.

The Gracenote Software and each item of Gracenote Data are licensed to you "AS IS." Gracenote makes no representations or warranties, express or implied, regarding the accuracy of any Gracenote Data from the Gracenote Servers. Gracenote reserves the right to delete data from the Gracenote Servers or to change data categories for any cause that Gracenote deems sufficient. No warranty is made that the Gracenote Software or Gracenote Servers are error-free or that functioning of Gracenote Software or Gracenote Servers will be uninterrupted. Gracenote is not obligated to provide you with new enhanced or additional data types or categories that Gracenote may provide in the future and is free to discontinue its services at any time.

GRACENOTE DISCLAIMS ALL WARRANTIES EXPRESS OR IMPLIED, INCLUDING, BUT NOT LIMITED TO, IMPLIED WARRANTIES OF MERCHANTABILITY, FITNESS FOR A PARTICULAR PURPOSE, TITLE, AND NON-INFRINGEMENT. GRACENOTE DOES NOT WARRANT THE RESULTS THAT WILL BE OBTAINED BY YOUR USE OF THE GRACENOTE SOFTWARE OR ANY GRACENOTE SERVER. IN NO CASE WILL GRACENOTE BE LIABLE FOR ANY CONSEQUENTIAL OR INCIDENTAL DAMAGES OR FOR ANY LOST PROFITS OR LOST REVENUES.

© 2012 Gracenote, Inc. All rights reserved.

امداد خودرو فارما

تلفن شبانه روزی: ۰۲۱-۸۸۸۶۲۰۸۵

FarmaSOS.com

 NOTICE

■ Discs and adapters that cannot be used

Do not use the following types of discs.

Also, do not use 8 cm (3 in.) disc adapters, Dual Discs or printable discs.

Doing so may damage the player and/or disc insert/eject function.

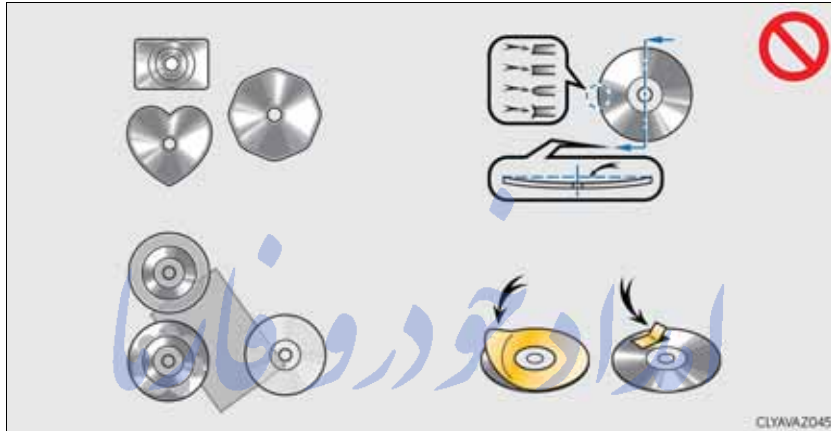

- Discs that have a diameter that is not 12 cm (4.7 in.).
 - Low-quality or deformed discs.
 - Discs with a transparent or translucent recording area.
 - Discs that have tape, stickers or labels attached to them, or that have had the label peeled off.
- Player precautions
- Failure to follow the precautions below may result in damage to the discs or the player itself.
- Do not insert anything other than discs into the disc slot.
 - Do not apply oil to the player.
 - Store discs away from direct sunlight.
 - Never try to disassemble any part of the player.

Listening to an iPod

Connecting an iPod enables you to enjoy music from the vehicle speakers.

Press the “MEDIA” button or select “iPod” on the “Source” screen.

Connecting an iPod

→P. 312

iPod top screen

Pressing the “MEDIA” button displays the iPod top screen from any screen of the selected source.

- Menu screen

→P. 312

- Selecting a song

Press the “<” or “>” button, turn the right side knob (left-hand drive vehicle) or left side knob (right-hand drive vehicle) on the audio panel to select the desired song number.

To fast-forward or rewind, press and hold the “<” or “>” button.

- Selecting a play mode

1 Move the controller to the right and then select “Browse”.

2 Select the desired play mode, and then select a song to begin using the selected play mode.

- Displaying the now playing list

Move the controller to the right and then select “Now playing list”.

- About iPod



- “Made for iPod” and “Made for iPhone” mean that an electronic accessory has been designed to connect specifically to an iPod, or iPhone, respectively, and has been certified by the developer to meet Apple performance standards.
 - Apple is not responsible for the operation of this device or its compliance with safety and regulatory standards. Please note that the use of this accessory with iPod or iPhone may affect wireless performance.
 - iPhone, iPod, iPod classic, iPod nano and iPod touch are trademarks of Apple Inc., registered in the U.S. and other countries.
- iPod cover art
- Depending on the iPod and songs in the iPod, iPod cover art may be displayed.
 - This function can be changed to on/off. (→P. 311)
 - It may take time to display iPod cover art, and the iPod may not be operated while the cover art display is in process.
- iPod functions
- When an iPod is connected and the audio source is changed to iPod mode, the iPod will resume play from the same point in which it was last used.
 - Depending on the iPod that is connected to the system, certain functions may not be available. If a function is unavailable due to a malfunction (as opposed to a system specification), disconnecting the device and reconnecting it may resolve the problem.
 - Depending on the iPod, while connected to the system, the iPod cannot be operated with its own controls. It is necessary to use the controls of the vehicle's audio system instead.
 - When the battery level of an iPod is very low, the iPod may not operate. If so, charge the iPod before use.
 - Compatible models (→P. 326)
- Error messages

Message	Cause/Correction procedures
“Connection error.”	This indicates a problem in the iPod or its connection.
“There are no songs available for playback.”	This indicates that there is no music data in the iPod.
“No items available.”	This indicates that songs are not found in a selected playlist.
“Check the iPod firmware version.”	This indicates that the software version is not compatible. Please check the compatible models.(→P. 326)
“iPod authorization failed.”	This indicates that the display audio system failed to authorize the iPod. Please check your iPod.

■ iPod problems

To resolve most problems encountered when using your iPod, disconnect your iPod from the vehicle iPod connection and reset it. For instructions on how to reset your iPod, refer to your iPod Owner's Manual.

■ Compatible models

The following iPod®, iPod nano®, iPod classic®, iPod touch® and iPhone® devices can be used with this system.

● Made for

- iPod touch (5th generation)
- iPod touch (4th generation)
- iPod touch (3rd generation)
- iPod touch (2nd generation)
- iPod touch (1st generation)
- iPod classic
- iPod with video
- iPod nano (7th generation)
- iPod nano (6th generation)
- iPod nano (5th generation)
- iPod nano (4th generation)
- iPod nano (3rd generation)
- iPod nano (2nd generation)
- iPod nano (1st generation)
- iPhone 5
- iPhone 4S
- iPhone 4
- iPhone 3GS
- iPhone 3G
- iPhone

Depending on differences between models or software versions etc., some models might be incompatible with this system.

■ To use the video mode

To operate the video functions such as iPod video, a 4-pole AUX cable is necessary. However, depending on the cable specifications, the video function may not work properly. For more information consult any authorized Lexus dealer or repairer, or another duly qualified and equipped professional.



NOTICE

■ If the console box lid cannot be fully closed

Depending on the size and shape of the iPod that is connected to the system, the auxiliary box lid may not close fully. In this case, do not forcibly close the lid as this may damage the iPod or the terminals, etc.

■ To prevent damage to the iPod or its terminals

- Do not leave the iPod in the vehicle. The temperature inside the vehicle may become high, resulting in damage to the iPod.
- Do not push down on or apply unnecessary pressure to the iPod while it is connected.
- Do not insert foreign objects into the port.

Using USB memory device

Connecting a USB memory device enables you to enjoy music from the vehicle speakers.

Select “USB1” or “USB2” on the “Source” screen.

Connecting a USB memory device

→P. 299

USB top screen

Pressing the “MEDIA” button displays the USB top screen from any screen of the selected source.

USB audio

Moving the controller to the right and selecting “Play music” while the USB video screen is displayed changes to USB audio mode.

- Menu screen

→P. 312

- Selecting a file

Press the “<” or “>” button, turn the right side knob (left-hand drive vehicle) or left side knob (right-hand drive vehicle) on the audio panel to select the desired file number.

To fast-forward or rewind, press and hold the “<” or “>” button.

- Selecting a play mode

- 1 Move the controller to the right and select “Browse”.
- 2 Select the desired play mode, and select a file to begin the selected play mode.

- Displaying the now playing list

Move the controller to the right and select “Now playing list”.

USB video

Moving the controller to the right and selecting “Play Video” while the USB video screen is displayed changes to USB video mode.

This function cannot be used while USB photo or MirrorLink™ is in use.

- Menu screen

→P. 312

- Selecting a file

Press the “<” or “>” button, turn the right side knob (left-hand drive vehicle) or left side knob (right-hand drive vehicle) on the audio panel to select the desired file number.

To fast-forward or reverse, press and hold the “<” or “>” button.

- Selecting a folder

- 1 Move the controller to the right and select “Browse”.
- 2 Select the desired folder, then select a file to begin using the selected folder.

- Displaying the now playing list

Move the controller to the right and select “Now playing list”.

- USB memory functions

- Depending on the USB memory device that is connected to the system, the device itself may not be operable and certain functions may not be available. If the device is inoperable or a function is unavailable due to a malfunction (as opposed to a system specification), disconnecting the device and reconnecting it may resolve the problem.
- If the USB memory device still does not begin operation after being disconnected and reconnected, format the device.

- Error messages for USB memory

Message	Cause/Correction procedures
“Connection error.”	This indicates a problem with the USB memory device or its connection.
“There are no files available for playback.”	This indicates that no MP3/WMA/AAC files are included on the USB memory device.

- USB memory

- Compatible devices

USB memory devices that can be used for MP3, WMA and AAC (audio mode) or MP4, WMV and AVI (video mode) playback.

- Compatible device formats

The following device format can be used:

- USB communication format: USB2.0 FS (480 Mbps)
 - File system format: FAT16/32 (Windows)
 - Correspondence class: Mass storage class
- MP3, WMA and AAC files written to a device with any format other than those listed above may not play correctly, and their file names and folder names may not be displayed correctly.

Items related to standards and limitations are as follows:

- Maximum directory hierarchy: 8 levels
- Maximum number of folders in a device: 3000 (including the root)
- Maximum number of files in a device: 9999
- Maximum number of files per folder: 255

- MP3, WMA and AAC files

MP3 (MPEG Audio LAYER 3) is a standard audio compression format.

Files can be compressed to approximately 1/10 of their original size using MP3 compression.

WMA (Windows Media Audio) is a Microsoft audio compression format. This format compresses audio data to a size smaller than that of the MP3 format.

AAC is short for Advanced Audio Coding and refers to an audio compression technology standard used with MPEG2 and MPEG4.

MP3, WMA and AAC file and media/formats compatibility are limited.

- MP3 file compatibility

- Compatible standards
 - MP3 (MPEG1 AUDIO LAYERIII, MPEG2 AUDIO LAYERIII)
- Compatible sampling frequencies
 - MPEG1 AUDIO LAYERIII: 32, 44.1, 48 (kHz)
 - MPEG2 AUDIO LAYERIII: 16, 22.05, 24 (kHz)
- Compatible bit rates (compatible with VBR)
 - MPEG1 AUDIO LAYERIII: 32-320 (kbps)
 - MPEG2 AUDIO LAYERIII: 8-160 (kbps)
- Compatible channel modes: stereo, joint stereo, dual channel and monaural

- WMA file compatibility

- Compatible standards
 - WMA Ver. 7, 8, 9 (only compatible with Windows Media Audio Standard)
- Compatible sampling frequencies
 - 32, 44.1, 48 (kHz)
- Compatible bit rates (only compatible with 2-channel playback)
 - ver. 7, 8: CBR 48-192 (kbps)
 - ver. 9: CBR 48-320 (kbps)

- AAC file compatibility

- Compatible standards
 - MPEG4/AAC-LC
- Compatible sampling frequencies
 - 11.025/12/16/22.05/24/32/44.1/48 (kHz)
- Compatible bit rates
 - 16-320 (kbps)
- Compatible channel modes: 1ch and 2ch

- File names

The only files that can be recognized as MP3/WMA/AAC and played are those with the extension .mp3, .wma or .m4a.
- ID3, WMA and AAC tags

ID3 tags can be added to MP3 files, making it possible to record the track title, artist name, etc.

The system is compatible with ID3 Ver. 1.0, 1.1, and Ver. 2.2, 2.3 ID3 tags. (The number of characters is based on ID3 Ver. 1.0 and 1.1.)

WMA tags can be added to WMA files, making it possible to record the track title and artist name in the same way as with ID3 tags.

AAC tags can be added to AAC files, making it possible to record the track title and artist name in the same way as with ID3 tags.
- MP3, WMA and AAC playback
 - When a device containing MP3, WMA or AAC files is connected, all files in the USB memory device are checked. Once the file check is finished, the first MP3, WMA or AAC file is played. To make the file check finish more quickly, we recommend that you do not include any files other than MP3, WMA or AAC files or create any unnecessary folders.
 - When a USB memory device is connected and the audio source is changed to USB memory mode, the USB memory device will start playing the first file in the first folder. If the same device is removed and reconnected (and the contents have not been changed), the USB memory device will resume play from the same point in which it was last used.
- Extensions

If the file extensions .mp3, .wma and .m4a are used for files other than MP3, WMA and AAC files, they will be skipped (not played).
- Playback
 - To play MP3 files with steady sound quality, we recommend a fixed bit rate of at least 128 kbps and a sampling frequency of 44.1 kHz.
 - There is a wide variety of freeware and other encoding software for MP3, WMA and AAC files on the market, and depending on the status of the encoding and the file format, poor sound quality or noise at the start of playback may result. In some cases, playback may not be possible at all.
 - Microsoft, Windows, and Windows Media are the registered trademarks of Microsoft Corporation in the U.S.A. and other countries.

 NOTICE

■ If the console box lid cannot be fully closed

Depending on the size and shape of the USB memory device that is connected to the system, the auxiliary box lid may not close fully. In this case, do not forcibly close the lid as this may damage the USB memory device or the terminals, etc.

■ To prevent damage to the USB memory device or its terminals

- Do not leave the USB memory device in the vehicle. The temperature inside the vehicle may become high, resulting in damage to the USB memory device.
- Do not push down on or apply unnecessary pressure to the USB memory device while it is connected.
- Do not insert foreign objects into the port. ◆

امداد خودرو فارما

تلفن شبانه روزی: ۰۲۱-۸۸۸۶۲۰۸۵

FarmaSOS.com

Using the AUX port

To use the AUX port, connect a portable player, press the “MEDIA” button or select “AUX” or “A/V” on the “Source” screen.

Connecting a portable player

→P. 299

Top screen

Pressing the “MEDIA” button displays the top screen from any screen of the selected source.

- Menu screen

→P. 312

- Operating portable players connected to the audio system
Volume can be adjusted using the vehicle's audio controls. All other adjustments must be made on the portable player itself.
- When using a portable player connected to the power outlet
Noise may occur during playback. Use the power source of the portable player.
- To use the A/V function
To operate the video functions such as A/V, a 4-pole AUX cable is necessary. However, depending on the cable specifications, the video function may not work properly. For more information consult any authorized Lexus dealer or repairer, or another duly qualified and equipped professional.

NOTICE

- If the console box lid cannot be fully closed
Depending on the size and shape of the portable player that is connected to the system, the auxiliary box lid may not close fully. In this case, do not forcibly close the lid as this may damage the portable audio player or the terminals, etc.

Steps for using Bluetooth® devices

The following can be performed using Bluetooth® wireless communication:

- A portable audio player can be operated and listened to via the Display Audio system
- Hands-free phone calls can be made via a cellular phone

In order to use wireless communication, register and connect a Bluetooth® device by performing the following procedures.

Device registration/connection flow

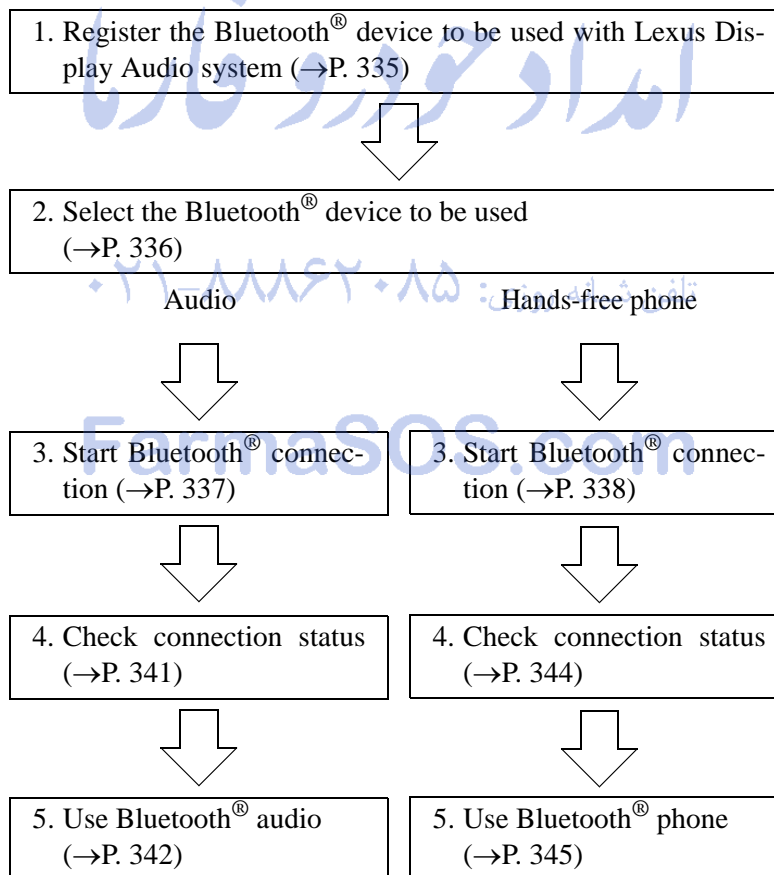

“Bluetooth* Setup” screen

Go to “Bluetooth* setup”:  → “Setup” → “Bluetooth*”

*: Bluetooth is a registered trademark of Bluetooth SIG, Inc.

- When displaying “Bluetooth setup” screen from the “Bluetooth* audio” screen
 - 1 Display the “Bluetooth* audio” screen. (→P. 306)
 - 2 Move the controller to the left and select “Connect”.
 - When displaying “Bluetooth* setup” screen from the phone top screen
 - 1 Display the phone top screen. (→P. 343)
 - 2 Move the controller to the left and select “Connect telephone”.
- *: Bluetooth is a registered trademark of Bluetooth SIG, Inc.

امداد خودرو فارما

تلفن شبانه روزی: ۰۲۱-۸۸۸۶۲۰۸۵

FarmaSOS.com

Registering a Bluetooth® device

Bluetooth® compatible phones (HFP) and portable audio players (AVP) can be registered simultaneously. You can register up to 5 Bluetooth® devices.

How to register a Bluetooth® device

- 1 Turn the Bluetooth® connection setting of your device set to on.
- 2 Go to “Bluetooth* setup”:  → “Setup” → “Bluetooth*”
- 3 Move the controller to the left and then select “Add device”

- 4 When this screen is displayed, search for the device name displayed on this screen on your Bluetooth® device.

For operation of the Bluetooth® device, see the manual that comes with your Bluetooth® device.

- 5 Register the Bluetooth® device using your Bluetooth® device.

A PIN code are not required for SSP (Secure Simple Pairing) compatible Bluetooth® devices. Depending on the device, you may need to select Yes to register, or No to cancel on the device.

If an error message is displayed, follow the guidance on the screen to try again.

*: Bluetooth is a registered trademark of Bluetooth SIG, Inc.



Removing a Bluetooth® device

- 1 Go to “Bluetooth* setup”:  → “Setup” → “Bluetooth*”
- 2 Move the controller to the left and then select “Remove device”.
- 3 Select the device to remove.

*: Bluetooth is a registered trademark of Bluetooth SIG, Inc.

Selecting a Bluetooth® device

If multiple Bluetooth® devices are registered, follow the procedure below to select the Bluetooth® device to be used. You may only use one device at a time.

How to select a Bluetooth® device

- 1 Go to “Bluetooth* setup”:  → “Setup” → “Bluetooth*”
- 2 Select the device to connect.
- 3 Select “Connect all”, “Connect as a telephone” or “Connect as audio player”.

If the desired Bluetooth® device is not displayed, register the device.
(→P. 335)

*: Bluetooth is a registered trademark of Bluetooth SIG, Inc.

امداد خودرو پارما
تلفن شبانه روزی: ۰۲۱-۸۸۸۶۲۰۸۵

FarmaSOS.com

Connecting a Bluetooth® audio player

There are 2 portable audio player connection settings available: connecting from the vehicle and connecting from the portable player.

Connecting method is set to “Vehicle”

When the portable audio player is in standby for a connection, it will be automatically connected whenever the engine switch is in either ACCESSORY or IGNITION ON mode.

Connecting method is set to “Device”

Operate the portable player and connect it to the Bluetooth® audio system.

- 1 Go to “Bluetooth* setup”:  → “Setup” → “Bluetooth*”
- 2 Select the device to connect.
- 3 Select “Connect all” or “Connect as audio player”.

If the desired Bluetooth® device is not displayed, register the device. (→P. 335)

*: Bluetooth is a registered trademark of Bluetooth SIG, Inc.

FarmaSOS.com

Connecting a Bluetooth® phone

There are two connecting methods available: automatic and manual.

Auto connection

When you register a phone, auto connection will be activated. Always set it to this mode and leave the Bluetooth® phone in a place where a connection can be established.

When the engine switch is turned to ACCESSORY or IGNITION ON mode, the system will search for a nearby cellular phone you have registered.

Next, the system automatically connects with the most recent phone that was connected. The connected result is displayed.

Manual connection

When auto connection has failed or “Bluetooth* power” is turned off, you must connect the Bluetooth® device manually.

- 1 Go to “Bluetooth* setup”:  → “Setup” → “Bluetooth*”
- 2 Select the device to connect.
- 3 Select “Connect all”, “Connect as a telephone” or “Connect as audio player”.

If the desired Bluetooth® device is not displayed, register the device.

(→P. 335)

*: Bluetooth is a registered trademark of Bluetooth SIG, Inc.

■ Reconnecting a Bluetooth® phone

If the system cannot connect due to poor signal strength with the engine switch in ACCESSORY or IGNITION ON mode, the system will automatically attempt to reconnect.

If the phone is turned off, the system will not attempt to reconnect. In this case, the connection must be made manually, or the phone must be reselected.

■ Connecting a phone while Bluetooth® audio is playing

- Bluetooth® audio will stop temporarily.
- It may take time to connect.

Displaying a Bluetooth® device details

You can confirm and change the registered device details.

Bluetooth® device registration status

- 1 Go to “Bluetooth* setup”:  → “Setup” → “Bluetooth*”
- 2 Select the desired device and then select “Device Info”.
 - ① Change the name of the device
 - ② Change the connection method
 “Vehicle”: Connect the audio system to the portable audio player.
 “Device”: Connect the portable audio player to the audio system
 - ③ Device address
 - ④ Compatibility profile of the device

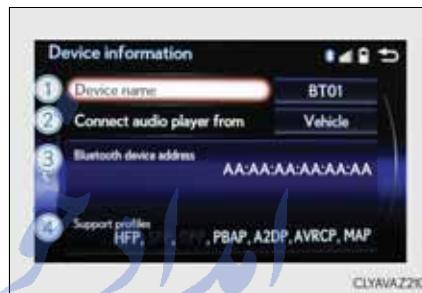

*: Bluetooth is a registered trademark of Bluetooth SIG, Inc.

- Restoring the default settings
 Move the controller to the left and select “Defaults” on the “Device information” screen.

FarmaSOS.com

Detailed Bluetooth® settings

You can confirm and change the detailed Bluetooth® settings.

How to check and change detailed Bluetooth® settings

- 1 Go to “Bluetooth* setup”:  → “Setup” → “Bluetooth*”
- 2 Move the controller to the left and then select “System settings”.

- 1 Select to set the Bluetooth® function on/off.
- 2 Change the name of the device.
- 3 Change the PIN-code.

You can change the PIN-code that is used to register your Bluetooth® devices in the system.

- 4 Device address
- 5 Select to set the display of the telephone status on/off

You can set the system to show the status confirmation display when connecting a telephone.

- 6 Select to set the display of the audio player status on/off

You can set the system to show the status confirmation display when connecting an audio player.

- 7 Compatibility profile of the system

*: Bluetooth is a registered trademark of Bluetooth SIG, Inc.



■ Restoring the default settings

Move the controller to the left and select “Defaults” on the “System settings” screen.

Listening to Bluetooth® Audio

The Bluetooth® audio system enables the user to enjoy music played on a portable player from the vehicle speakers via wireless communication.

When a Bluetooth® device cannot be connected, check the connection status on the “Bluetooth* audio” screen. If the device is not connected, either register or reconnect the device. (→P. 336, 337)

*: Bluetooth is a registered trademark of Bluetooth SIG, Inc.





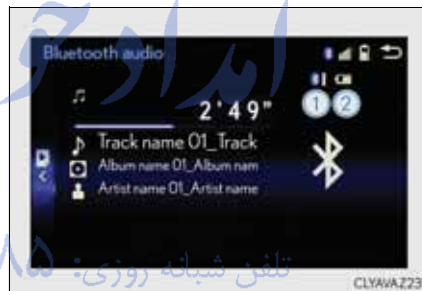

Status display

You can check indicators, such as, signal strength and battery charge on the screen.

- ① Connection status
- ② Battery charge

Depending on the type of portable audio player used, some titles may not be displayed.



Indicators	Conditions
Connection status	Good ←————→ Not connected   
Battery charge	Full ←————→ Empty   

Bluetooth® audio top screen

Pressing the “MEDIA” button displays the Bluetooth® audio top screen from any screen of the selected source.

- Menu screen

→P. 312

- Selecting a song

Press the “<” or “>” button or turn the “TUNE/SCROLL” knob to select the desired song number.

To fast-forward or rewind, press and hold the “<” or “>” button.

- Selecting a play mode

- 1 Move the controller to the right and then select “Browse”.
 - 2 Select the desired play mode, and then select a song to begin using the selected play mode.
- Displaying the now playing list
Move the controller to the right and then select “Now playing list”.

تلفن شبانه روزی: ۰۲۱-۸۸۸۶۲۰۸۵

FarmaSOS.com

Using a Bluetooth® Phone

The hands-free system is a function that allows you to use your cellular phone without touching it.

This system supports Bluetooth®. Bluetooth® is a wireless data system that allows the cellular phone to wirelessly connect to the hands-free system and make/receive calls.

Before making a phone call, check the connection status, battery charge, call area and signal strength. (→P. 344)

If a Bluetooth® device cannot be connected, check the connection status. If the device is not connected, either register or reconnect it. (→P. 336, 338)

Phone top screen

To display the screen shown below, press the  switch on the steering wheel or select “Telephone” on the “MENU” screen.

- ① Phone name
- ② Bluetooth® connection status (→P. 344)
- ③ Display the call history screen (→P. 347)
- ④ Display the favorites screen (→P. 347)
- ⑤ Display the contacts screen (→P. 345)
- ⑥ Display the dial pad screen (→P. 345)
- ⑦ Display the message inbox screen (→P. 351)

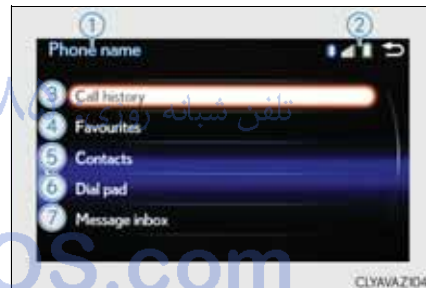

◆ Telephone switch (→P. 354)

◆ Microphone

The vehicle's built-in microphone is used when talking on the phone.

The person you are speaking to can be heard from the front speakers.



To use the hands-free system, you must register your Bluetooth® phone in the system. (→P. 335)

Status display

You can check indicators such as signal strength and battery charge on any screen.

- ① Connection status
- ② Signal strength
- ③ Battery charge

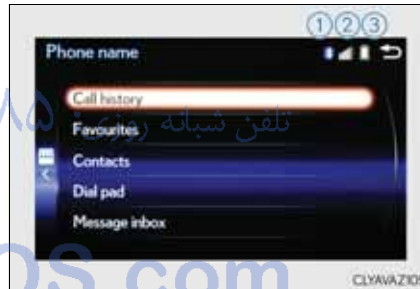



Indicators	Conditions	
Connection status	Good 	← → Poor
Battery charge	Full 	← → Empty
Signal strength	Excellent 	← → Poor

Making a call



Once a Bluetooth® phone is registered, you can make a call using the following procedure:

Dialing

- 1 Go to “Dial pad”:  → “Telephone” → “Dial pad”
- 2 Input a phone number. (→P. 296)
- 3 Press the  switch on the steering wheel or select .

Dialing from the phonebook

You can dial a number from the phonebook data imported from your cellular phone. The system has one phonebook for each registered telephone. Up to 2500 contacts may be stored in each phonebook. (→P. 346)

- 1 Go to “Contacts”:  → “Telephone” → “Contacts”
- 2 Choose the desired contact to call from the list.
- 3 Choose the number and then press the  switch on the steering wheel or select the number.

تلفن شبانه روزی: ۰۲۱-۸۸۶۲۰۸۵

FarmaSOS.com

When the phonebook is empty

You can transfer the phone numbers in a Bluetooth® phone to the system. Operation methods differ between PBAP (Phone Book Access Profile) compatible and PBAP incompatible Bluetooth® phones. If the cellular phone does not support either PBAP or OPP (Object Push Profile) service, you cannot transfer contacts.

- 1 Press the  switch on the steering wheel.

If the phonebook is empty, a message will be displayed.

- ▶ For a PBAP compatible Bluetooth® phone and “Automatic transfer” is off

- 2 To transfer new contacts from a cellular phone, select “Always” and then enable “Automatic transfer”. (→P. 357)
Select “Once” if you want to transfer new contacts from a cellular phone.

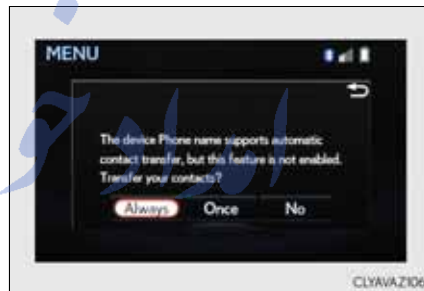

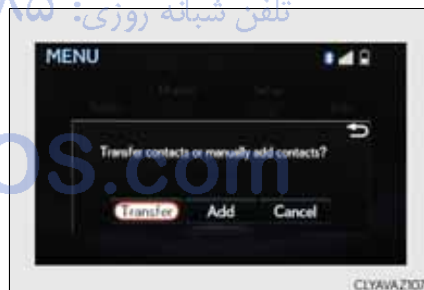

- ▶ For a PBAP incompatible and OPP compatible Bluetooth® phone

- 2 Select “Transfer” and operate your cellular phone to transfer new contacts from a cellular phone.
Select “Add” if you want to add a new contact manually.





Dialing from favorites

You can make a call using numbers registered in the favorites.

- 1 Go to “Favourites”:  → “Telephone” → “Favourites”
- 2 Choose the desired contact to call from the list.
- 3 Choose the number and then press the  switch on the steering wheel or press the controller.

Dialing from history

You can make a call using the call history.

- 1 Go to “Call history”:  → “Telephone” → “Call history”
- 2 Select the desired entry from the list.
- 3 Press the  switch on the steering wheel or select .



■ Call history list

- If you make a call to or receive a call from a number registered in the phone-book, the name is displayed in the call history.
- If you make multiple calls to the same number, only the last call made is displayed in the call history.

■ International calls

Depending on the mobile phone in use, you may not be able to make international calls.

■ Calling by using the latest call history entry

- 1 Press the  switch on the steering wheel to display the phone top screen.
- 2 Press the  switch on the steering wheel to display the “Call history” screen.
- 3 Press the  switch on the steering wheel to select the latest call history entry.

Receiving a call



When a call is received, the following screen is displayed together with a sound.

To answer the phone

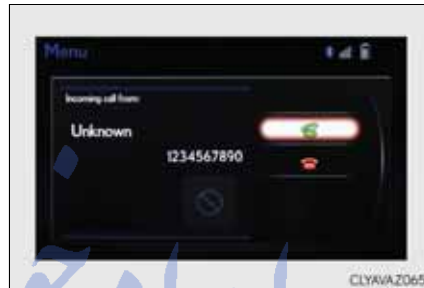
Press the  switch on the steering wheel or select .



To refuse a call

Press the  switch on the steering wheel or select .

■ International calls

Depending on the cellular phone in use, received international calls may not be displayed correctly. تلفن شبانه روزی - ۰۲۱-۸۵۲۰۸۵۲۰

FarmaSOS.com

Speaking on the phone

The following screen is displayed when speaking on the phone.

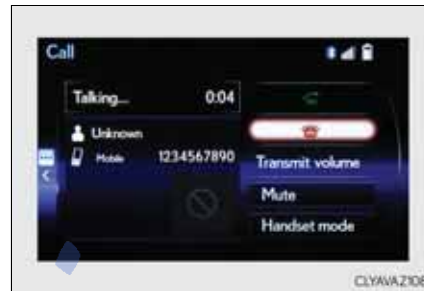

To adjust the call volume

Select “Transmit volume”. To restore default volume, move the controller to the left on the “Transmit volume” screen and then select “Default”.

To adjust in call volume

Move the controller to the left and then select “In-call volume”. You can also adjust the volume using the steering switches or volume knob.

To prevent the other party from hearing your voice

Select “Mute”.

Inputting tones

When using phone services such as an answering service or a bank, you can store phone numbers and code numbers in the contacts using “p” or “w” symbols (eg. 056133 w 0123p#1).

- ▶ Contact including a phone number only

- 1 Move the controller to the left and then select “0-9”.
- 2 Input the number.

- ▶ Phone number containing a “p” symbol

When the “p” symbol is dialed in an outgoing call, there will be a pause for 2 seconds before the following digits are dialed automatically.



► Phone number containing a “w” symbol

When the “w” symbol is dialed in an outgoing call, you need to go to the “Release tones” screen to dial the following digits. Move the controller to the left and then select “Release tones”.

To transfer a call

Select “Handset mode” to change from a hands-free call to a cellular phone call or vice versa.

To hang up

Press the  switch on the steering wheel or select .

Call waiting

When a call is interrupted by a third party while talking, an incoming call message will be displayed.



To talk with the other party:

Press the  switch on the steering wheel or select .

To refuse the call:

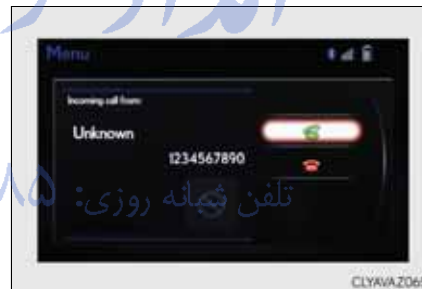
Press the  switch on the steering wheel or select .



Every time you press the  switch on the steering wheel or select  during call waiting, you will be switched to the other party.

■ Transferring calls

- It is not possible to transfer from hands-free to the cellular phone while driving.
- If you transfer from the cellular phone to hands-free, the hands-free screen will be displayed, and you can operate the system using the screen.
- Transfer method and operation may vary according to the cellular phone used.
- For operation of the cellular phone in use, see the phone's manual.

■ Call waiting operation

Call waiting operation may differ depending on your phone company and cellular phone.

Using a Bluetooth® phone messages

Once a MAP-profile compatible Bluetooth® phone is registered, you can check the E-mail/SMS/MMS and reply to a message using the following procedures:

Checking messages

- 1 Go to “Message inbox”:  → “Telephone” → “Message inbox”
- 2 Select a message.

Moving the controller to the left while on the “Message inbox” screen displays the setting screen. (→P. 360)

Move the controller to the right while on the “Message inbox” screen and then select an account to display a message list for the selected account.

Message screen

Selecting “Next” or “Previous” displays the next or previous message. If a message is too long, select “Read more” to display the full text.

■ Option menu

Move the controller to the left while on the message screen.

- 1 Select a prepared message and send a return message.
- 2 Call a sender.
If more than one phone number is registered for a sender, a phone number selection screen will be displayed.
- 3 Call a phone number written in a message.

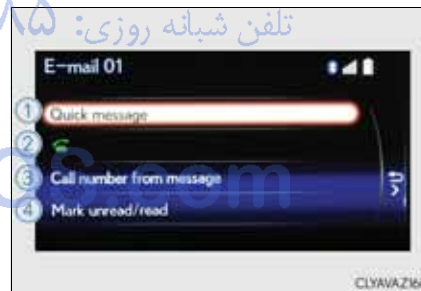

- 4 Select “Mark unread” to mark mail that has been read as unread. Select “Mark read” to mark mail that has not been read as read.

Replying to a message

- 1 Move the controller to the left while on the message screen.
 - 2 Select “Quick message” to display the “Quick message” screen.
 - 3 Select the desired message and then select “Send”.
- Editing a quick message
- 1 Move the controller to the left while on the message screen.
 - 2 Select “Quick message” and then the desired message. Move the controller to the left while the desired message is displayed.
 - 3 Select “Edit”.
- To return to the default message after editing, select “Default”.

امداد خودرو فارما

تلفن شبانه روزی: ۰۲۱-۸۸۸۶۲۰۸۵

FarmaSOS.com

Receiving a message popup function

This function is available when the “E-mail notification popup” or “SMS/MMS notification popup” are set to on. (→P. 360)

- ▶ “Incoming E-mail display” or “Incoming SMS/MMS display” are set to “Drop-Down”

When E-mail/SMS/MMS are received, the incoming message is displayed on the upper side of the screen with a sound.

- ▶ “Incoming E-mail display” or “Incoming SMS/MMS display” are set to “Full Screen”

When E-mail/SMS/MMS are received, the incoming message screen is displayed with a sound and it can be operated on the screen.

- ① Check the message.
- ② Refuse to check the message.
- ③ Call to receive the message sender’s phone number.

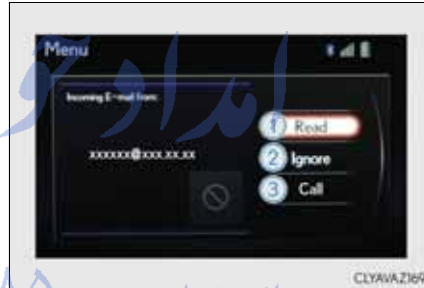

تلفن شبانه روزی: ۰۲۱-۸۸۶۲۰۸۵

FarmaSOS.com

Using the steering wheel switches

The steering wheel switches can be used to operate a connected cellular phone.

Operating a telephone using the steering wheel switches

① Volume switch

During an incoming call: Adjusts the ring tone volume

During speaking on the phone: Adjusts in call volume.

The voice guidance volume cannot be adjusted using this button.

② Off hook switch

- Start call
- Receiving
- Phone top screen display

③ On hook switch

- End call
- Refuse call

④ Talk switch

Press: Turns the voice command system on

Press and hold: Turns the voice command system off

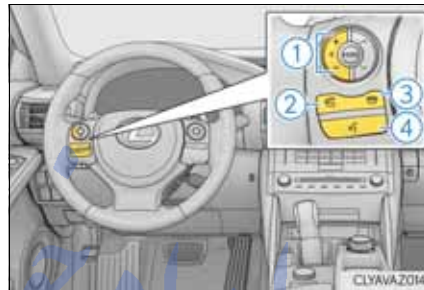

تلفن شبانه روزی: ۰۸۵-۸۸۶۲-۸۱
FarmaSOS.com

Bluetooth® phone settings

You can adjust the hands-free system to your desired settings.

“Telephone settings” screen

Go to “Telephone settings”:  → “Setup” → “Telephone”

- ① Register and connect a Bluetooth® device. (→P. 334)
- ② Adjust the call volume and message readout volume. (→P. 355)
- ③ Change the contact/call history settings. (→P. 357)
- ④ Change the messaging settings. (→P. 360)
- ⑤ Change the phone display settings. (→P. 356)

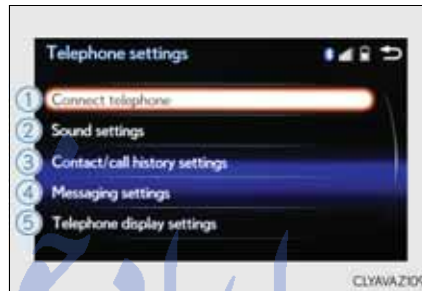

Sound settings

Go to “Sound settings”:  → “Setup” → “Telephone” → “Sound settings”

- ① Change the ring tone type
- ② Adjust the ring tone volume
- ③ Change incoming SMS/MMS tone type
- ④ Adjust the incoming SMS/MMS tone volume
- ⑤ Change the incoming email tone type
- ⑥ Adjust the incoming email tone volume
- ⑦ Adjust in call tone volume



Phone display settings

Go to “Telephone display settings”:  → “Setup” → “Telephone” → “Telephone display settings”

- ① Change the incoming call display
- ② Set the phonebook/history transfer status notification display on/off

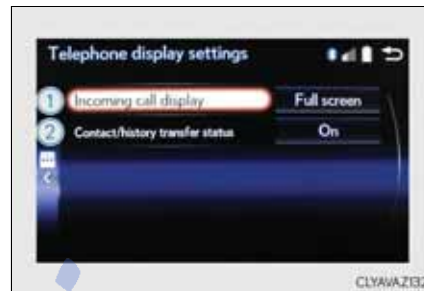

- To return to the default volume settings
Move the controller to the left and then select “Defaults”.

تلفن شبانه روزی: ۰۲۱-۸۸۸۶۲۰۸۵

FarmaSOS.com

Contact settings

Individual phonebooks can be registered for a maximum of 5 phones in total. The data for 2500 contacts (up to 4 numbers per contact) can be registered in each phonebook.

“Contact/call history settings” screen

Go to “Contact/call history settings”:  → “Setup” → “Telephone” → “Contact/call history settings”

- ① Select to set the automatic phonebook download on/off

With this setting on, phonebook data will be automatically transferred.

Depending on the cellular phone, call history will be also transferred.

- ② Update phonebook
- ③ Change the sort contacts mode
- ④ Add a favorite (→P. 358)
- ⑤ Delete a favorite (→P. 359)
- ⑥ Select to set the display of contact images on/off
- ⑦ Delete call history.
- ⑧ Add a new contact (PBAP incompatible Bluetooth phones, or compatible phones with “Automatic transfer” off)

Input the name, phone number and phone number type to add a new contact.

- ⑨ Edit a contact (PBAP incompatible Bluetooth phones, or compatible phones with “Automatic transfer” off)
Select the desired contact to edit.
- ⑩ Delete contacts (→P. 359) (PBAP incompatible Bluetooth phones, or compatible phones with “Automatic transfer” off)
- ⑪ Edit a voice tag (→P. 371)



- Return to the default settings
Move the controller to the left and select “Defaults”.

Transferring a phone number

You can transfer the phone numbers in your Bluetooth® phone to display audio system. Operation methods differ between PBAP compatible and PBAP incompatible Bluetooth® phones. If your cellular phone does not support either PBAP or OPP services, you cannot transfer contacts.

Go to “Transfer contacts”:  → “Setup” → “Telephone” → “Contact/call history settings” → “Update contacts from telephone”

- ▶ For PBAP compatible Bluetooth® phones when “Automatic transfer” is set to on

Start the update automatically.

- ▶ For PBAP compatible Bluetooth® phones when “Automatic transfer” is set to off and PBAP incompatible Bluetooth® phones

- ① Select to transfer the contact from the connected cellular phone and replace the current one.
- ② Select to transfer the desired contact data from the connected cellular phone to add to the current one.

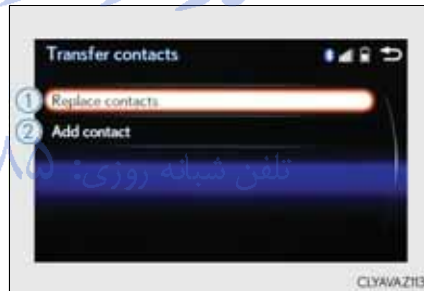

Registering favorites

You can register the desired contact from the phonebook. Up to 15 contacts per phone can be registered.

- 1 Go to “Add favourite”:  → “Setup” → “Telephone” → “Contact/call history settings” → “Add favourite”
- 2 Choose the contact to register.

Removing favorites

- 1 Go to “Remove favourite”:  → “Setup” → “Telephone” → “Contact/call history settings” → “Remove favourite”
- 2 Select the desired contacts.
You can select all contacts by selecting “Select all”
- 3 Move the controller to the left and select “Remove”.

Deleting the contacts data

- 1 Go to “Delete contact”:  → “Setup” → “Telephone” → “Contact/call history settings” → “Delete contacts”
- 2 Select the desired contacts.
You can select all contacts by selecting “Select all”.
- 3 Move the controller to the left and select “Delete”.

■ Phonebook data

Phonebook data is managed separately for every registered phone. When another phone is connected, you cannot read the registered data.

■ When transferring contacts

Transfer contacts while the engine is running.

If the cellular phone is OPP or PBAP compatible, you may need to input “1234” on the cellular phone for OBEX certification.

■ When you have selected “Replace contacts” or “Add contact” to transfer contacts

If the cellular phone does not support OPP service, you cannot use these functions. You can transfer the phonebook data only by operating your phone.

■ Transferring contacts while Bluetooth® audio is playing

Bluetooth® audio will disconnect. It will reconnect automatically when data transfer finishes. It may not reconnect depending on the phone which is connected.

Messaging setting

Go to “Messaging settings”:  → “Setup” → “Telephone” → “Messaging settings”

- ① Select to set the message forwarding from cellular phones on/off
- ② Select to set the new SMS/MMS notification display on/off
- ③ Select to set the new email notification display on/off
- ④ Select to set the add vehicle signature function on/off
- ⑤ Select to set the cellular phone’s message read and unread status update function on/off.
- ⑥ Change the incoming SMS/MMS display.
- ⑦ Change the incoming email display.
- ⑧ Change the account name to “Service name” (names from the connected device) or “Fixed name” (pre-defined names).



■ Restoring the default settings

Move the controller to the left then select “Defaults” on the “Messaging settings” screen.

Bluetooth®

- When using the Bluetooth® audio system
 - In the following situations, the system may not function.
 - If the portable audio player is turned off
 - If the portable audio player is not connected
 - If the portable audio player's battery is low
 - There may be a delay if a cellular phone connection is made during Bluetooth® audio play.
 - Depending on the type of portable audio player that is connected to the system, operation may differ slightly and certain functions may not be available.
- When using the hands-free system
 - The audio system is muted when making a call.
 - If both parties speak at the same time, it may be difficult to hear.
 - If the received call volume is overly loud, an echo may be heard.
If the Bluetooth® phone is too close to the system, quality of the sound may deteriorate and connection status may deteriorate.
 - In the following situations, it may be difficult to hear the other party:
 - When driving on unpaved roads
 - When driving at high speeds
 - If a window is open
 - If the air conditioning is blowing directly on the microphone
 - If there is interference from the network of the cellular phone
- Conditions under which the system will not operate
 - If using a cellular phone that does not support Bluetooth®
 - If the cellular phone is turned off
 - If you are outside of cellular phone service coverage
 - If the cellular phone is not connected
 - If the cellular phone's battery is low
 - When outgoing calls are controlled, due to heavy traffic on telephone lines, etc.
 - When the cellular phone itself cannot be used
 - When transferring phonebook data from the cellular phone

■ Bluetooth® antenna

The antenna is built into the display.

If the portable audio player is behind the seat or in the glove box or console box, or is touching or covered by metal objects, the connection status may deteriorate.

If the cellular phone is behind the seat or in the console box, or touching or covered by metal objects, the connection status may deteriorate.

■ Battery charge/signal status

- This display may not correspond exactly with the portable audio player or cellular phone itself.

- This system does not have a charging function.

- The portable audio player or cellular phone battery will be depleted quickly when the device is connected to Bluetooth®.

■ When using the Bluetooth® audio and hands-free system at the same time

The following problems may occur.

- The Bluetooth® audio connection may be interrupted.

- Noise may be heard during Bluetooth® audio playback.

■ About the contact in this system

The following data is stored for every registered cellular phone. When another phone is connecting, you cannot read the registered data.

- Contact data

- Call history

- Favorite

When removing a Bluetooth® phone from the system, the above-mentioned data is also deleted.

■ About Bluetooth®

Bluetooth® is a registered trademark of Bluetooth SIG, Inc.

The Bluetooth® word mark and logos are owned by the Bluetooth SIG, Inc. and any use of such marks by FUJITSU TEN LIMITED is under license. Other trademarks and trade names are those of their respective owners.



■ Compatible models

The Bluetooth® audio system supports portable audio players with the following specifications

- Bluetooth® specifications:
Ver. 2.0, or higher (Recommended: Ver. 3.0+EDR or higher)
- Profiles:
 - A2DP (Advanced Audio Distribution Profile) Ver. 1.0, or higher
(Recommended: Ver. 1.2 or higher)
This is a profile to transmit stereo audio or high quality sound to the audio system.
 - AVRCP (Audio/Video Remote Control Profile) Ver. 1.0 or higher
(Recommended: Ver. 1.4 or higher)
This is a profile to allow remote control the A/V equipment.

However, please note that some functions may be limited depending on the type of portable audio player connected.

The hands-free system supports cellular phones with the following specifications.

- Bluetooth® specification:
Ver. 2.0 or higher (Recommended: Ver. 3.0+EDR or higher)
- Profiles:
 - HFP (Hands Free Profile) Ver. 1.0 or higher (Recommended: Ver. 1.6 or higher)
This is a profile to allow hands-free phone calls using a cellular phone or head set. It has outgoing and incoming call functions.
 - OPP (Object Push Profile) Ver. 1.1 or higher (Recommended: Ver. 1.1)
This is a profile to transfer phonebook data. When a Bluetooth® compatible cellular phone has both PBAP and OPP, OPP cannot be used.
 - PBAP (Phone Book Access Profile) Ver. 1.0 or higher (Recommended: Ver. 1.1)
This is a profile to transfer phonebook data.
 - MAP (Message Access Profile) Ver. 1.0 or higher
This is a profile to using phone message.

If the cellular phone does not support HFP, you cannot register it with the hands-free system. OPP, PBAP or MAP services must be selected individually.

■ Reconnecting the portable audio player

If the portable audio player is disconnected due to poor reception when the engine switch is in ACCESSORY or IGNITION ON mode, the system automatically reconnects the portable audio player.

If you have switched off the portable audio player yourself, follow the instructions below to reconnect:

- Select the portable audio player again
- Enter the portable audio player

■ When you sell your car

Be sure to delete your personal data. (→P. 303)

■ Certification



The latest "DECLARATION of CONFORMITY"(DoC) is available at the following:
DoC address: FUJITSU TEN LIMITED
2-28, Goshō-dori 1-chome, Hyogo-ku, Kobe, 652-8510, Japan

С настоящето, FUJITSU TEN LIMITED, декларира, че FT0042A е в съответствие със съществените изисквания и другите приложими разпоредби на Директива 1999/5/EC.
FUJITSU TEN LIMITED tímto prohlašuje, že tento FT0042A je ve shodě se základními požadavky a dalšími příslušnými ustanoveními směrnice 1999/5/ES.
Ovim FUJITSU TEN LIMITED, izjavljuje da je FT0042A u skladu s bitnim zahtjevima drugim relevantnim odredbama Direktive 1999/5/EC i Pravilnika o RITT opremi (NN 25/2012).
Undertegnede FUJITSU TEN LIMITED erklærer herved, at følgende udstyr FT0042A overholder de væsentlige krav og øvrige relevante krav i direktiv 1999/5/EF.
Hiermit erklärt FUJITSU TEN LIMITED, dass sich das Gerät FT0042A in Übereinstimmung mit den grundlegenden Anforderungen und den übrigen einschlägigen Bestimmungen der Richtlinie 1999/5/EG befindet.
Käesolevaga kinnitab FUJITSU TEN LIMITED seadme FT0042A vastavust direktiivi 1999/5/EÜ põhinõuetele ja nimetatud direktiivist tulenevatele teistele asjakohastele sätetele.
Hereby, FUJITSU TEN LIMITED, declares that this FT0042A is in compliance with the essential requirements and other relevant provisions of Directive 1999/5/EC.
Por medio de la presente FUJITSU TEN LIMITED declara que el FT0042A cumple con los requisitos esenciales y cualesquiera otras disposiciones aplicables o exigibles de la Directiva 1999/5/CE.
ΜΕ ΤΗΝ ΠΑΡΟΥΣΑ FUJITSU TEN LIMITED ΔΗΛΩΝΕΙ ΟΤΙ FT0042Α ΣΥΜΜΟΡΦΩΝΕΤΑΙ ΠΡΟΣ ΤΙΣ ΟΥΣΙΩΔΕΙΣ ΑΠΑΙΤΗΣΕΙΣ ΚΑΙ ΤΙΣ ΛΟΙΠΕΣ ΣΧΕΤΙΚΕΣ ΔΙΑΤΑΞΕΙΣ ΤΗΣ ΟΔΗΓΙΑΣ 1999/5/ΕΚ.
Par la présente FUJITSU TEN LIMITED déclare que l'appareil FT0042A est conforme aux exigences essentielles et aux autres dispositions pertinentes de la directive 1999/5/CE.
Con la presente FUJITSU TEN LIMITED dichiara che questo FT0042A è conforme ai requisiti essenziali ed alle altre disposizioni pertinenti stabilite dalla direttiva 1999/5/CE.
Ar šo FUJITSU TEN LIMITED deklarē, ka FT0042A atbilst Direktīvas 1999/5/EK būtiskajām prasībām un citiem ar to saistītajiem noteikumiem.
Šiuo FUJITSU TEN LIMITED deklaruoja, kad šis FT0042A atitinka esminius reikalavimus ir kitas 1999/5/EB Direktyvos nuostatas.
Hierbij verklaart FUJITSU TEN LIMITED dat het toestel FT0042A in overeenstemming is met de essentiële eisen en de andere relevante bepalingen van richtlijn 1999/5/EG.
Hawnhekk, FUJITSU TEN LIMITED, jiddikjara li dan FT0042A jikkonforma mal-htigijiet essenzjali u ma provvedimenti oħrajn relevanti li hemm fid-Direttiva 1999/5/EC.
Alulírott, FUJITSU TEN LIMITED nyilatkozom, hogy a FT0042A megfelel a vonatkozó alapvető követelményeknek és az 1999/5/EC irányelv egyéb előírásainak.
Niniejszym FUJITSU TEN LIMITED oświadcza, że FT0042A jest zgodny z zasadniczymi wymogami oraz pozostałymi stosownymi postanowieniami Dyrektywy 1999/5/EC.
FUJITSU TEN LIMITED declara que este FT0042A está conforme com os requisitos essenciais e outras disposições da Directiva 1999/5/CE.

Prin prezenta, FUJITSU TEN LIMITED, declară că aparatul FT0042A este în conformitate cu cerințele esențiale și cu alte prevederi pertinente ale Directivei 1999/5/CE.
FUJITSU TEN LIMITED izjavlja, da je ta FT0042A v skladu z bistvenimi zahtevami in ostalimi relevantnimi določili direktive 1999/5/ES.
FUJITSU TEN LIMITED týmto vyhlasuje, že FT0042A splňa základné požiadavky a všetky príslušné ustanovenia Smernice 1999/5/ES.
FUJITSU TEN LIMITED vakuuttaa täten että FT0042A tyypinen laite on direktiivin 1999/5/EY oleellisten vaatimusten ja sitä koskevien direktiivin muiden ehtojen mukainen.
Härmed intygar FUJITSU TEN LIMITED att denna FT0042A står i överensstämmelse med de väsentliga egenskapskrav och övriga relevanta bestämmelser som framgår av direktiv 1999/5/EG.
Hér með lýsir FUJITSU TEN LIMITED yfir því að FT0042A er í samræmi við grunnkröfur og aðrar kröfur, sem gerðar eru í tilskipun 1999/5/EC.
FUJITSU TEN LIMITED erklærer herved at utstyret FT0042A er i samsvar med de grunnleggende krav og øvrige relevante krav i direktiv 1999/5/EF.
Ovim , FUJITSU TEN LIMITED, izjavljuje da ovaj FT0042A je uskladen sa bitnim zahtjevima i drugim relevantnim odredbama Direktive 1999/5/EC.

 CAUTION

■ While driving

Do not operate the portable audio player, cellular phone or connect a device to the Bluetooth® system.

■ Caution regarding interference with electronic devices

- Your audio unit is fitted with Bluetooth® antennas. People with implanted pacemakers or cardiac defibrillators should maintain a reasonable distance between themselves and the Bluetooth® antennas. The radio waves may affect the operation of such devices.
- Before using Bluetooth® devices, users of any electrical medical device other than implanted pacemakers and implanted cardiac defibrillators should consult the manufacturer of the device for information about its operation under the influence of radio waves. Radio waves could have unexpected effects on the operation of such medical devices.

 NOTICE

■ When leaving the vehicle

Do not leave your portable audio player or cellular phone in the vehicle. The inside of the vehicle may become hot, causing damage to the portable audio player or cellular phone.

“Information” screen

Display “Information” screen

Go to “Information”:  → “Info”

- ① Display the “MirrorLink*” screen. (→P. 367)
- ② Display the “USB photo” screen. (→P. 370)

*: MirrorLink™ is a registered trademark of Car Connectivity Consortium, Inc.



امداد خودرو فارما

تلفن شبانه روزی: ۰۲۱-۸۸۸۶۲۰۸۵

FarmaSOS.com

MirrorLink™

The MirrorLink™ function enables to operate a smartphone contents via Lexus Display Audio system.

Depending on differences between models or software version etc, some models might be incompatible with this system.

Connect a smartphone to USB port using a USB cable.

Connecting a smartphone

→P. 299

Using MirrorLink™ function

- 1 Go to “MirrorLink*”:  → “Info” → “MirrorLink*”
- 2 Select the desired application on the application list screen.
 - MirrorLink™ screen

Follow the specific operation procedures for the smartphone application.

- ① Displays the application screen and operation pointer.

The pointer is controlled by operating the controller.

When the controller is not operated for a few seconds, the pointer will disappear.

- ② Return application list screen

If you select the other application, the new application screen will displayed.

- ③ Displays software buttons that function as the buttons on the smartphone.

- ④ Change the other audio source (Radio, Disc etc.).

- To change control area from the ②, ③ and ④ areas to the ① area, move the controller to the left.

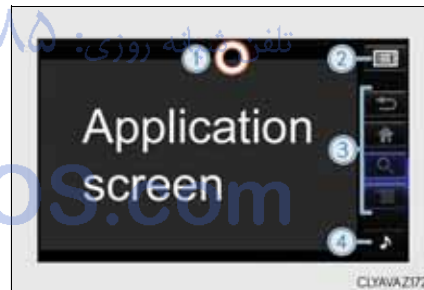

- To change control areas from the ① area to the ②, ③ and ④ area, move the pointer to the right-most position then move the controller to the right or press  button.

*: MirrorLink™ is a registered trademark of Car Connectivity Consortium, Inc.

امداد خودرو فارما

تلفن شبانه روزی: ۰۲۱-۸۸۸۶۲۰۸۵

FarmaSOS.com

Menu screen

To display the left menu screen, turn the controller to the left while the MirrorLink™ screen is being displayed.

- ① Select a device
- ② Change the screen size
- ③ Adjust the display settings.



■ Selecting a MirrorLink™ device

If more than one MirrorLink™ device is available, to select the desired device.

- ① Select “MirrorLink* device select” on the left menu screen.
- ② Select “MirrorLink*1” or “MirrorLink*2”.

*: MirrorLink™ is a registered trademark of Car Connectivity Consortium, Inc.

■ Operational conditions

- This function cannot be used while USB video or photo is in use.
- This function is not available if the smartphone does not support Car Connectivity Consortium™.

■ About MirrorLink™

MirrorLink™ is a registered trademark of Car Connectivity Consortium, Inc.

FarmaSOS.com

USB photo

Connecting a USB memory device enables you to enjoy photo on the Lexus Display Audio display.

Go to “USB photo”:  → “Info” → “USB1 photo” or “USB2 photo”

Connecting a USB memory device

→P. 299

Menu screen

Move the controller to the left to display the menu screen.

- ① Change the full screen mode.
- ② Select to set the slide show display on/off.
Start the slide show at a selected folder.
- ③ Change the play speed.
- ④ Change the play mode.

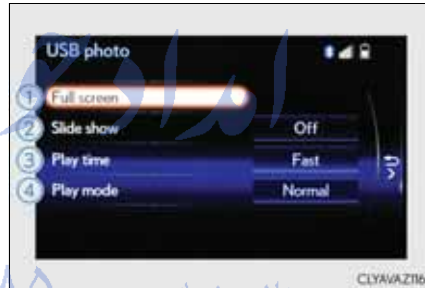

Selecting a folder and a file

- 1 Move the controller to the right and select “Browse”.
- 2 Select the desired folder, and then select a desired file to begin using the selected folder.

- USB memory functions
→P. 328
- USB memory
 - Compatible devices
USB memory device that can be used for JPEG display.
 - Compatible device formats
The following device format can be used:
 - USB communication format: USB2.0 FS (480 Mbps)
 - File system format: FAT16/32 (Windows)
 - Correspondence class: Mass storage class
 - JPEG file compatibility
 - Compatible image size: Maximum 10MB
 - Compatible pixel size: Maximum 10,000,000 pixels

**NOTICE**

- If the console box lid cannot be fully closed
→P. 331
- To prevent damage to the USB memory device or its terminals
→P. 331

تلفن شبانه روزی: ۰۲۱-۸۸۶۲۰۸۵

FarmaSOS.com

Speech command system

Using the speech command system enables you to make a call to contacts that have a voice tag.

Editing a voice tag

You can register desired contacts to enable the speech command system. Up to 50 contacts per phone can be registered.

- 1 Go to “Voice tags”:  → “Setup” → “Telephone” → “Contact/call history settings” → “Voice tag” → “New” or “Edit”
 - 2 Select the desired contact.
 - 3 Move the controller to the left and then select “REC”.
 - 4 Say the registered voice.
 - To play the registered voice, select “Play”.
- Deleting a voice tag
- 1 Display the “Voice tags” screen.
 - 2 Select “Delete” and then the desired contact.
 - 3 Move the controller to the left and then select “Delete”.

Using the speech command system

- 1 Press the talk switch.
 - To cancel the speech command system, press and hold the talk switch.
- 2 After a beep sounds, say the desired contact name.
 - When the icon is displayed, you can speak a command.
- 3 If more than 1 contact name is displayed, select the desired contact name.

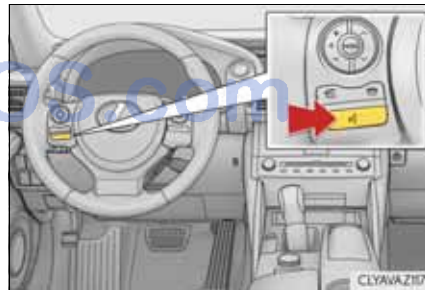

If more than 1 phone number is displayed, select the desired phone number.

When  switch on the steering wheel is pressed, the system calls the first phone number entry of the first contact.

- Microphone
→P. 344
- Speech commands may not be recognized if:
 - Spoken too quickly
 - Spoken at a low or high volume
 - Passengers are talking while speech commands are spoken

امداد خودرو فارما

تلفن شبانه روزی: ۰۲۱-۸۸۸۶۲۰۸۵

FarmaSOS.com

Interior features

6

- | | |
|---|--|
| <p>6-1. Using the air conditioning system</p> <p>Automatic air conditioning system 374</p> <p>Heated steering wheel/ seat heaters/ seat ventilators 385</p> <p>6-2. Using the interior lights</p> <p>Interior lights list..... 387</p> <ul style="list-style-type: none"> • Interior lights 388 • Personal lights..... 388 <p>6-3. Using the storage features</p> <p>List of storage features..... 389</p> <ul style="list-style-type: none"> • Glove box 390 • Console box 390 • Cup holders/ Bottle holders..... 391 <p>Trunk features 393</p> | <p>6-4. Using the other interior features</p> <p>Other interior features..... 396</p> <ul style="list-style-type: none"> • Sun visors 396 • Vanity mirrors..... 396 • Clock 396 • Power outlet..... 397 • Armrest..... 398 • Rear sunshade..... 398 • Assist grips 400 • Coat hooks..... 400 |
|---|--|

Automatic air conditioning system

Air outlets and fan speed are automatically adjusted according to the temperature setting.

Vehicles with a Lexus Display Audio system: Press the “MENU” button on the Lexus Display Audio controller, then select “Climate” to display the air conditioning operation screen.

For details on the Lexus Display Audio controller, refer to “Lexus Display Audio controller” on P. 294.

Vehicles with a navigation system: Press the “MENU” button on the Remote Touch, then select “Climate” to display the air conditioning control screen.

For details on the Remote Touch, refer to the “Navigation System Owner’s Manual”.

The illustrations below are for left-hand drive vehicles.

The button positions and shapes will differ for right-hand drive vehicles.

Also, the display and button positions will differ depending on the type of the system.

تلفن شبانه روزی: ۰۲۱-۸۸۶۲۰۸۵

FarmaSOS.com

Air conditioning controls

- ▶ With “DUAL” mode

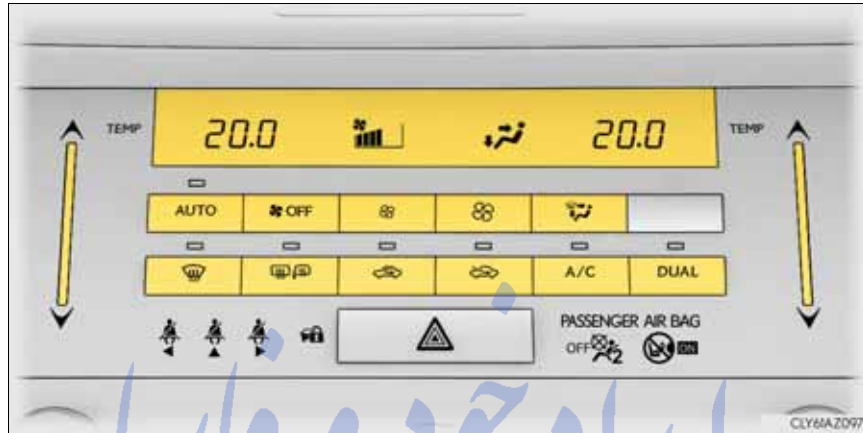

- ▶ Without “DUAL” mode

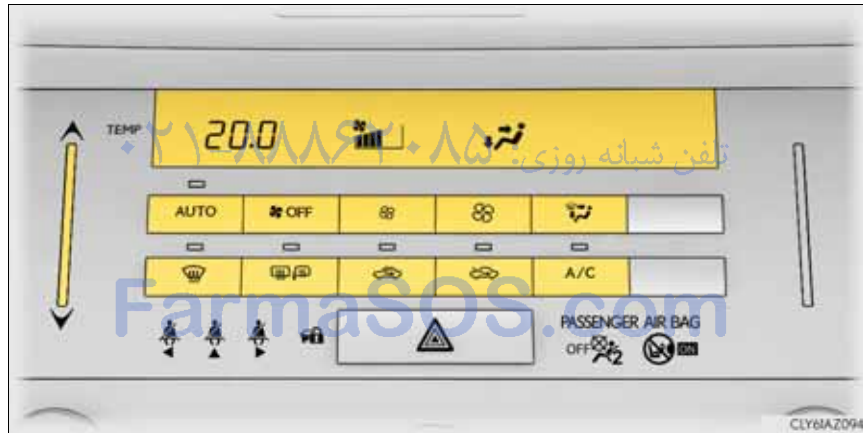

6

Interior features

■ Adjusting the temperature setting

To adjust the temperature setting, touch and slide your finger up or down on the sensor.

The temperature setting can also be adjusted by touching on the sensor.

When the temperature setting is changed, a buzzer sounds.

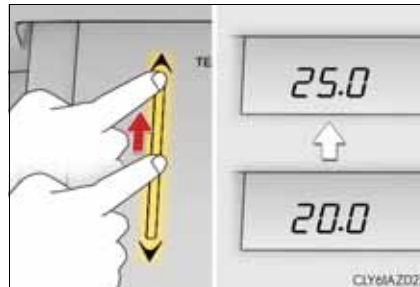

■ Fan speed setting

Press  to increase the fan speed.

Press  to decrease the fan speed.

■ Change the airflow mode

To change the airflow, press .

The air outlets used are switched each time the button is pressed.

■ Other functions

- Switching between outside air and recirculated air modes (→P. 380)
- Defogging the windshield (→P. 380)
- Defogging the rear window and outside rear view mirrors (→P. 380)

FarmaSOS.com

Air conditioning control screen

► With a Lexus Display Audio

(With “DUAL” mode)

(Without “DUAL” mode)



- ① Adjust the left-hand side temperature setting
 - ② Adjust the fan speed setting
 - ③ Select to set auto mode on/off, fan off, blower customization (→P. 381) and displaying the option control screen (→P. 379).
 - ④ Select the air flow mode
 - ⑤ Adjust the right-hand side temperature setting
 - ⑥ Adjust the temperature setting
- 1** Move the Lexus Display Audio controller left/right to select the desired item (① to ⑥).
 - 2** When ①, ②, ⑤ or ⑥ is selected:
Move the controller forward/backward or turn it left/right for adjusting.
When ③ or ④ is selected:
Move the controller forward/backward or turn it left/right to select a screen button, then press the controller.

▶ With a navigation system

(With “DUAL” mode)



(Without “DUAL” mode)



- ① Adjust the left-hand side temperature setting
- ② Adjust the fan speed setting
- ③ Changing the fan speed setting during the automatic mode operation (→P. 381)
- ④ Select the air flow mode
- ⑤ Adjust the right-hand side temperature setting
- ⑥ Display the option control screen (→P. 379)
- ⑦ Turn the fan off
- ⑧ Select to set auto mode on/off
- ⑨ Adjust the temperature setting

To adjust or select settings, move the Remote Touch knob to select the screen button, and then press the Remote Touch knob to enter the selected function.



■ Option control screen

The functions can be switched on and off.

- ① Cooling and dehumidification function
- ② Adjusting the temperature for driver and passenger seats separately (“DUAL” mode) (if equipped) (→P. 379)
- ③ Removing pollen from the air (Pollen removal mode) (→P. 380)



Using automatic mode

- 1 Press , or select “AUTO” on the air conditioning control screen.
- 2 Adjust the temperature setting.
- 3 To stop the operation, press  or select “OFF” on the air conditioning control screen.

■ If the system is operated manually in automatic mode

If the fan speed setting or air flow modes are operated, the automatic mode indicator goes off. However, automatic mode for functions other than that operated are maintained.

■ Adjusting the temperature for driver and passenger seats separately (“DUAL” mode) (if equipped)

To turn on the “DUAL” mode, perform any of the following procedures:

- Press .
- Select “DUAL” on the option control screen.
- Adjust the passenger’s side temperature setting.

The indicator comes on when the “DUAL” mode is on.

While in “DUAL” mode, the temperature of the rear air outlets is set at the right-hand side temperature setting.

Other functions

■ Switching between outside air and recirculated air modes

Press  to change to recirculated air mode.

Press  to change to outside air mode.

The indicator above the selected button comes on.

■ Pollen removal mode

Pollen is removed from the air and the air flows to the upper part of the body.

Select  on the option control screen.

When the pollen removal mode is on,  is displayed on the air conditioning control screen.

In order to prevent the windshield from fogging up when the outside air is cold, the dehumidification function may operate.

The pollens are filtered out even if the pollen removal mode is turned off.

■ Defogging the windshield

Defoggers are used to defog the windshield and front side windows.

Press .

Set the outside/recirculated air mode button to outside air mode if the recirculated air mode is used. (It may switch automatically.)

To defog the windshield and the side windows early, turn the air flow and temperature up.

To return to the previous mode, press  again when the windshield is defogged.

■ Defogging the rear window and outside rear view mirrors

Defoggers are used to defog the rear window, and to remove raindrops, dew and frost from the outside rear view mirrors.

Press .

The defoggers will automatically turn off after a period of time.

- Windshield wiper de-icer (if equipped)

This feature is used to prevent ice from building up on the windshield and wiper blades.

Turns on/off.

The indicator comes on when the windshield wiper de-icer is on.

The windshield de-icer will automatically turn off after a period of time.



- Blower customization

Fan speed setting during the automatic mode operation can be customized.

To change the fan speed setting mode, select  on the air conditioning control screen.

Each time  is selected, the fan speed setting mode changes as follows.

“MEDIUM”→“SOFT”→“FAST”→“MEDIUM”

تلفن شبانه روزی: ۰۲۱-۸۸۸۶۲۰۸۵

FarmaSOS.com

Air outlets

■ Location of air outlets

The air outlets and air volume changes according to the selected airflow mode.

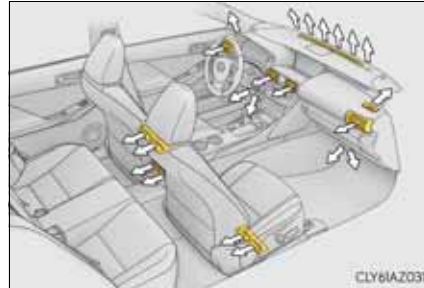

■ Adjusting the position of and opening and closing the air outlets

► Front

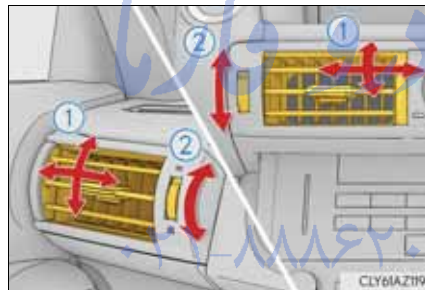

► Rear

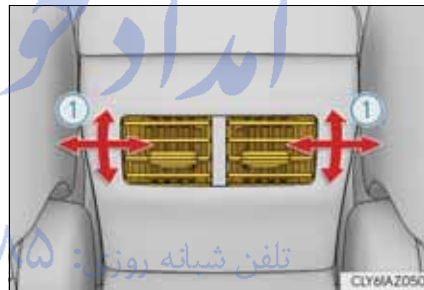

① Direct air flow to the left or right, up or down

To close the vent, move the knob to the most outside position. (rear outlets only)

② Turn the knob to open or close the vent

- Registering air conditioning settings to electronic keys (vehicles with driving position memory)
 - Unlocking the vehicle using an electronic key and turning the engine switch to IGNITION ON mode will recall that key's registered air conditioning settings.
 - When the engine switch is turned off, the current air conditioning settings will automatically be registered to the electronic key that was used to unlock the vehicle.
 - The system may not operate correctly if more than one electronic key is in the vicinity or if the smart entry & start system is used to unlock a passenger door.
 - The doors that can recall the air conditioning setting when unlocked using the smart entry & start system can be changed.* For details, contact any authorized Lexus dealer or repairer, or another duly qualified and equipped professional.
- *: The doors that can recall the driving position memory are changed at the same time.
- Using automatic mode

Fan speed is adjusted automatically according to the temperature setting and the ambient conditions.

Therefore, the fan may stop for a while until warm or cool air is ready to flow immediately after  is pressed or "AUTO" is selected.
- Fogging up of the windows

The windows will easily fog up when the humidity in the vehicle is high. Turning  ("A/C") on will dehumidify the air from the outlets and defog the windshield effectively.

 - If you turn  ("A/C") off, the windows may fog up more easily.
 - The windows may fog up if the recirculated air mode is used.
- Outside/recirculated air mode
 - When driving on dusty roads such as tunnels or in heavy traffic, set the outside/recirculated air mode button to the recirculated air mode. This is effective in preventing outside air from entering the vehicle interior. During cooling operation, setting the recirculated air mode will also cool the vehicle interior effectively.
 - Outside/recirculated air mode may automatically switch depending on the temperature setting or the inside temperature.
- Operation of the air conditioning system in Eco drive mode

In Eco drive mode, the air conditioning system is controlled as follows to prioritize fuel efficiency:

 - Engine speed and compressor operation controlled to restrict heating/cooling capacity
 - Fan speed restricted when automatic mode is selected

To improve air conditioning performance, perform the following operations:

 - Adjust the fan speed
 - Turn off Eco drive mode
- When the outside temperature falls to nearly 0°C (32°F)

The dehumidification function may not operate even when  is pressed or “A/C” is selected.

امداد خودرو فارما

تلفن شبانه روزی: ۰۲۱-۸۸۸۶۲۰۸۵

FarmaSOS.com

- Air conditioning odors
 - During use, various odors from inside and outside the vehicle may enter into and accumulate in the air conditioning system. This may then cause odor to be emitted from the vents.
 - To reduce potential odors from occurring:
 - It is recommended that the air conditioning system be set to outside air mode prior to turning the vehicle off.
 - The start timing of the blower may be delayed for a short period of time immediately after the air conditioning system is started in automatic mode.
- Air conditioning filter
 - P. 439
- Customization
 - Settings (e.g. A/C Auto switch operation) can be changed.
(Customizable features →P. 556)

⚠ CAUTION

- To prevent the windshield from fogging up
 - Do not use  during cool air operation in extremely humid weather. The difference between the temperature of the outside air and that of the windshield can cause the outer surface of the windshield to fog up, blocking your vision.
 - Do not place anything on the instrument panel which may cover the air outlets. Otherwise, air flow may be obstructed, preventing the windshield defoggers from defogging.

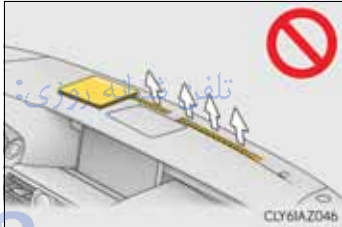

- To prevent burns
 - Do not touch the rear view mirror surfaces when the outside rear view mirror defoggers are on.
 - Do not touch the glass at lower part of the windshield or to the side of the front pillars when the windshield wiper de-icer is on.

⚠ NOTICE

- To prevent battery discharge
 - Do not leave the air conditioning system on longer than necessary when the engine is off.

Heated steering wheel*/seat heaters*/seat ventilators*

Heated steering wheel and seat heaters heat the side grips of the steering wheel and seats, respectively. Seat ventilators maintain good airflow by blowing air from the seats.

⚠ CAUTION

- Care should be taken to prevent injury if anyone in the following categories comes in contact with the steering wheel and seats when the heater is on:
 - Babies, small children, the elderly, the sick and the physically challenged
 - Persons with sensitive skin
 - Persons who are fatigued
 - Persons who have taken alcohol or drugs that induce sleep (sleeping drugs, cold remedies, etc.)
- Observe the following precautions to prevent minor burns or overheating,
 - Do not cover the seat with a blanket or cushion when using the seat heater.
 - Do not use seat heater more than necessary.

⚠ NOTICE

- Do not put heavy objects that have an uneven surface on the seat and do not stick sharp objects (needles, nails, etc.) into the seat.
- To prevent battery discharge, do not use the functions when the engine is off.

Heated steering wheel

Turn the heated steering wheel on/off

The indicator light comes on when the heated steering wheel is operating.



*: If equipped

- The heated steering wheel can be used when the engine switch is in IGNITION ON mode.
- The heated steering wheel will automatically turn off after about 30 minutes.

Seat heaters

Each time the switch is pressed, the intensity of the seat heater changes and the level indicator lights (amber) light as follows:

Hi (3 segments lit) → Mid (2 segments lit) → Lo (1 segment lit) → Off

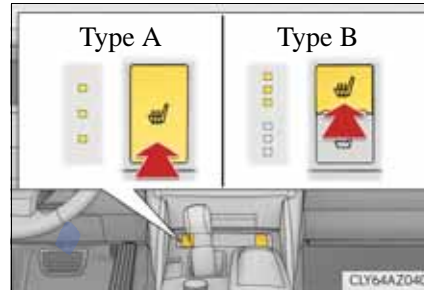

- The seat heaters can be used when the engine switch is in IGNITION ON mode.
- Seat heater timer control: The seat heater automatically switches from Hi→Mid→Lo. The switching timing differs depending on the temperature inside the cabin etc. when the seat heater was operated.
- The seat heater timer control can be turned on and off by pressing the seat heater switches for the driver side and front passenger side at the same time until a buzzer sounds. The buzzer will beep once when the seat heater timer control is turned on and twice when it is turned off.

Seat ventilators

Each time the switch is pressed, the intensity of the seat ventilator changes and the level indicator lights (green) light as follows:

Hi (3 segments lit) → Mid (2 segments lit) → Lo (1 segment lit) → Off



The seat ventilators can be used when the engine switch is in IGNITION ON mode.

Interior lights list

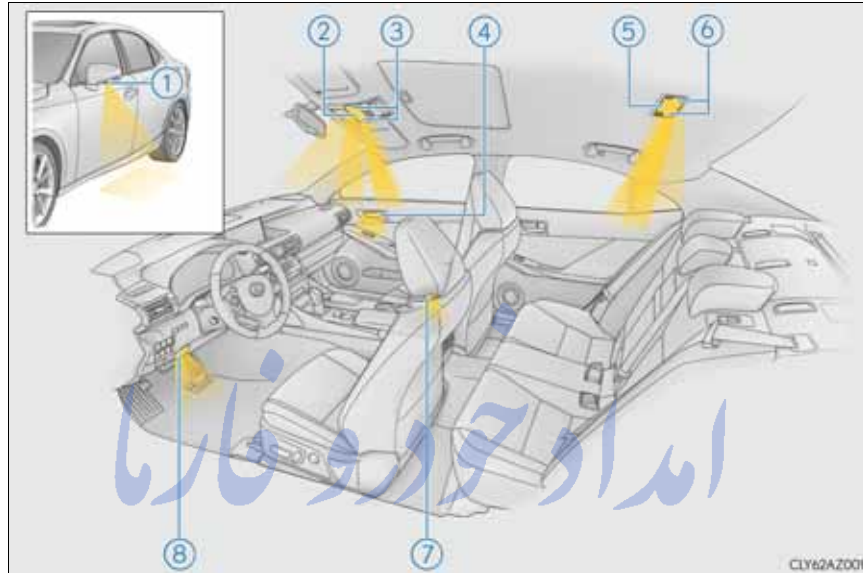

- | | |
|-----------------------------------|----------------------------------|
| ① Outer foot lights | ⑤ Rear interior light (→P. 388) |
| ② Front interior light (→P. 388) | ⑥ Rear personal lights (→P. 388) |
| ③ Front personal lights (→P. 388) | ⑦ Door courtesy lights |
| ④ Inside door handle lights | ⑧ Footwell lights |

6

Interior features

FarmaSOS.com

Interior lights

- ① Turns the light on/off
- ② Turns the door position on/off



Personal lights

Turns the light on/off

► Front

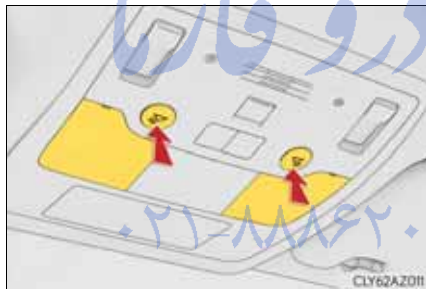

► Rear



- Illuminated entry system: The lights automatically turn on/off according to engine switch mode, the presence of the electronic key, whether the doors are locked/unlocked, and whether the doors are opened/closed.
- If the interior lights remain on when the door is not fully closed and the interior light main switch is in the door position, the lights will go off automatically after 20 minutes.
- Setting (e.g. the time elapsed before lights turn off) can be changed.
(Customizable features: →P. 549)

⚠ NOTICE

To prevent battery discharge, do not leave the lights on longer than necessary when the engine is off.

List of storage features

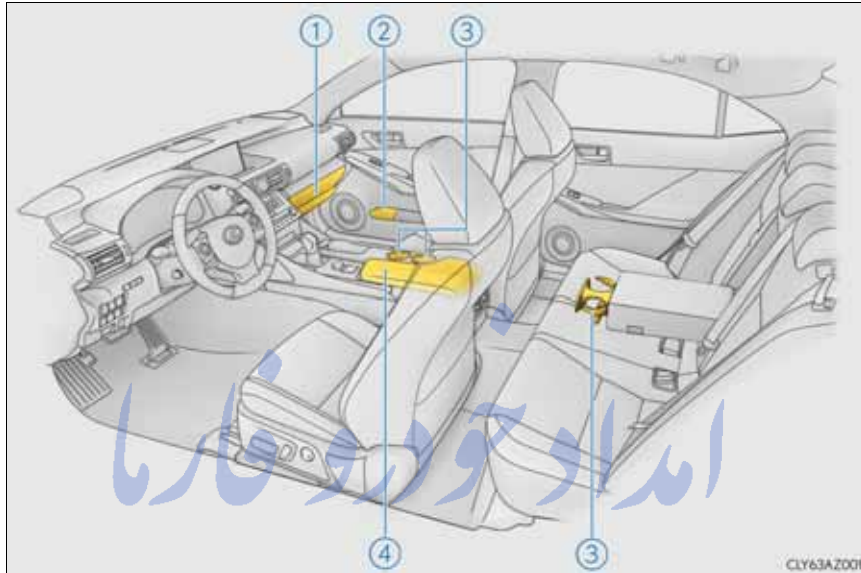

- ① Glove box (→P. 390)
- ② Bottle holders (→P. 391)
- ③ Cup holders (if equipped) (→P. 391)
- ④ Console box (→P. 390)

⚠ CAUTION

- Do not leave glasses, lighters or spray cans in the storage spaces, as this may cause the following when cabin temperature becomes high:
 - Glasses may be deformed by heat or cracked if they come into contact with other stored items.
 - Lighters or spray cans may explode. If they come into contact with other stored items, the lighter may catch fire or the spray can may release gas, causing a fire hazard.
- When driving or when the storage compartments are not in use, keep the lids closed.
In the event of sudden braking or sudden swerving, an accident may occur due to an occupant being struck by an open lid or the items stored inside.

Glove box

- ① Open (press the button)
- ② Unlock with the mechanical key
- ③ Lock with the mechanical key

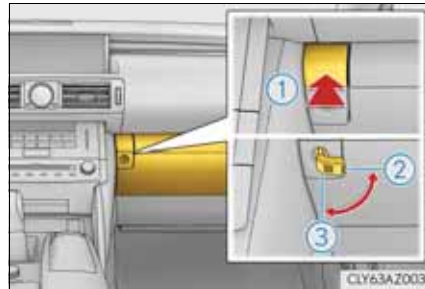

- The glove box light turns on when the engine switch is in ACCESSORY or IGNITION ON mode.
- The trunk opener main switch is located in the glove box. (→P. 126)
- The insert inside the glove box can be removed.

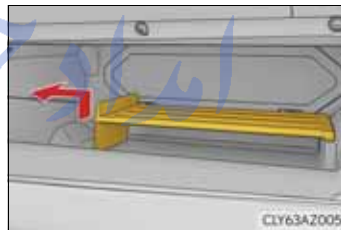
**Console box**

Push the knob.

Lift by hand to fully open the console box.



Cup holders/Bottle holders

■ Cup holders

▶ Front



▶ Rear (if equipped)

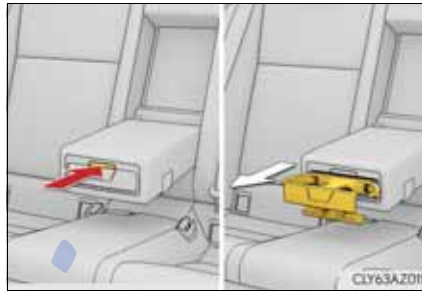

To open, pull down the armrest and press the button and release the rear cup holder on the armrest.

■ Bottle holders



- When storing a bottle, close the cap.
- The bottle may not be stored depending on its size or shape.
- The rubber mats at the bottom of the front cup holders can be removed.

 CAUTION

- Do not place anything other than cups or aluminum cans in the cup holders and bottle in the bottle holders. Other items may be thrown out of the holders in the event of an accident or sudden braking, causing injury.
- To prevent burns, cover hot drinks when placed in the cup holders.

 NOTICE

To prevent damage to the rear cup holder, stow the cup holder before stowing the armrest.

امداد خودرو فارما

تلفن شبانه روزی: ۰۲۱-۸۸۸۶۲۰۸۵

FarmaSOS.com

Trunk features

Cargo hooks

Raise the hooks when needed.

The cargo hooks are provided for securing loose items.



⚠ CAUTION

To avoid injury, always return the cargo hooks to their stowed positions when not in use.

First-aid kit storage belt

- ① Loosen the belt
- ② Tighten the belt

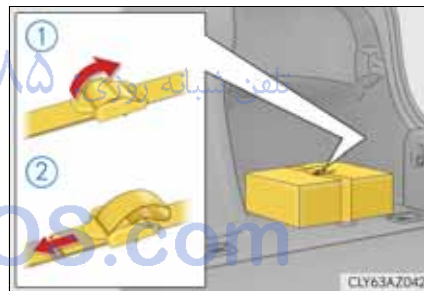

6

Interior features

Luggage mat

- 1 Hold the hook and lift up the luggage mat.

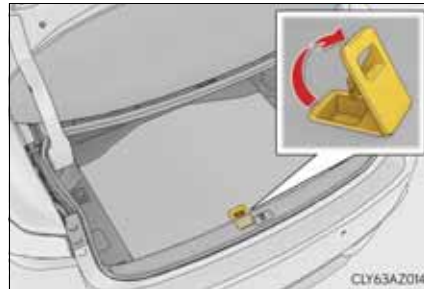

- 2 Secure the luggage mat using the hook.

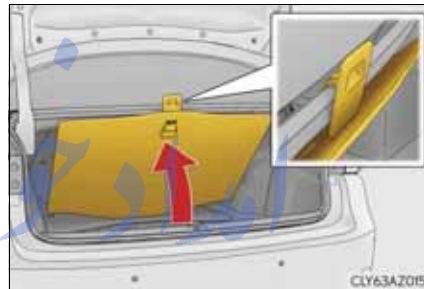
 **NOTICE**

When closing the trunk, do not leave the luggage mat lever hooked on the edge of the trunk. The luggage mat may get damaged.

FarmaSOS.com

Luggage under tray (vehicles without a spare tire)

Lift up the luggage mat and secure it by using the hook.

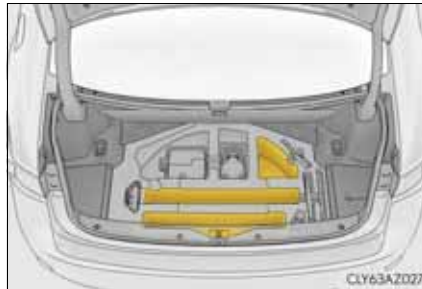
**Warning reflector storage belt**

- ① Loosen the belt
- ② Tighten the belt

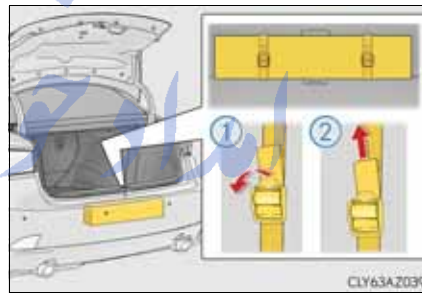

To prevent damage to the warning reflector storage belt when it is not in use, fold the belt (as shown in ①) and secure it with the clip (②).



Other interior features

Sun visors

- ① To set the visor in the forward position, flip it down.
- ② To set the visor in the side position, flip down, unhook, and swing it to the side.

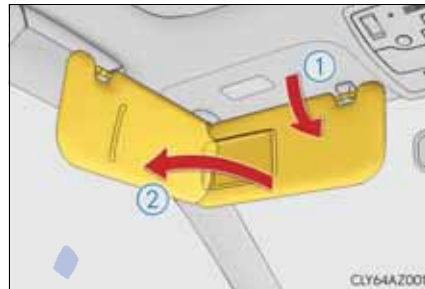

Vanity mirrors

Slide the cover to open.

The light turns on when the cover is opened.



Clock

The clock can be adjusted.

- ① Pressing and holding will move the clock hands backward.
- ② Pressing and holding will move the clock hands forward.



Power outlet

The power outlet can be used for 12 V accessories that run on less than 10 A.

Open the lid.



- The power outlet can be used when the engine switch is in ACCESSORY or IGNITION ON mode.
- To fully close the console box with the cable routed to outside the console box, insert the cable into the holder.

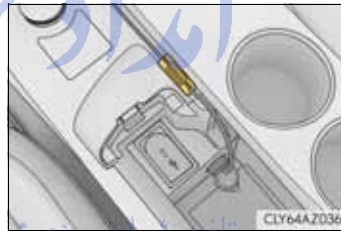

⚠ NOTICE

- To avoid the damaging the power outlet, close the power outlet lid when the power outlet is not in use. Foreign objects or liquids that enter the power outlet may cause a short circuit.
- To prevent blown fuse, do not use an accessory that uses more than 12 V 10 A.
- To prevent battery discharge, do not use the power outlet longer than necessary when the engine is off.

Armrest (if equipped)

Fold down the armrest for use.

**⚠ NOTICE**

To prevent damage to the armrest, do not apply too much load on the armrest.

Rear sunshade (if equipped)

The rear sunshade can be raised and lowered.

Raise/lower

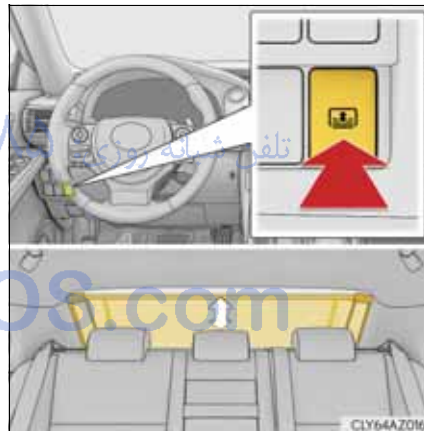

- The rear sunshade can be used when the engine switch is in IGNITION ON mode.
- The rear sunshade can be operated for approximately 1 minute even after the engine switch is turned to ACCESSORY mode or turned off.
- Reverse operation feature: To ensure adequate rear visibility, the rear sunshade automatically lowers when the shift lever is shifted to R.

However, the rear sunshade is raised again if any of the following occurs:

- The button is pressed again.*
- The shift lever is shifted into P.
- The shift lever is shifted out of R, and the vehicle reaches a speed of 15 km/h (9 mph).

If the engine is off when the rear sunshade has been lowered due to the reverse operation feature, it will not be raised even when the engine is turned on again and the vehicle reaches a speed of 15 km/h (9 mph). To raise the sunshade again, press the button.

*: Occasionally, the reverse function may not be carried out after the switch has been pressed. Repeat the above operation to operate the function.

CAUTION

When the rear sunshade is being operated, do not place fingers or other objects in the fastener section or in the opening. They may get caught, causing injury.

NOTICE

- To prevent battery discharge, do not operate the rear sunshade when the engine is off.
- Observe the following precautions to ensure normal operation of the rear sunshade.
 - Do not place excessive load on the motor or other components of the rear sunshade.
 - Do not place objects where they may hinder opening and closing operations.
 - Do not attach items to the rear sunshade.
 - Keep the opening clean and clear of obstructions.
 - Do not operate the rear sunshade continuously for long periods of time.

Assist grips

An assist grip installed on the ceiling can be used to support your body while sitting on the seat.



CAUTION

Do not use the assist grip when getting in or out of the vehicle or rising from your seat.

NOTICE

To prevent damage to the assist grip, do not put a heavy load on the assist grip.

Coat hooks

The coat hooks are provided with the rear assist grips.



CAUTION

Do not hang coat hangers or other hard or sharp objects on the hook. If the SRS curtain shield airbags deploy, these items may become projectiles, causing death or serious injury.

Maintenance and care

7

7-1. Maintenance and care	
Cleaning and protecting the vehicle exterior	402
Cleaning and protecting the vehicle interior	406
7-2. Maintenance	
Maintenance requirements	409
7-3. Do-it-yourself maintenance	
Do-it-yourself service precautions	411
Hood	413
Positioning a floor jack	414
Engine compartment	415
Tires	425
Tire inflation pressure	435
Wheels	437
Air conditioning filter	439
Electronic key battery	441
Checking and replacing fuses	444
Light bulbs	448

Cleaning and protecting the vehicle exterior

Perform the following to protect the vehicle and maintain it in prime condition:

- Working from top to bottom, liberally apply water to the vehicle body, wheel wells and underside of the vehicle to remove any dirt and dust.
- Wash the vehicle body using a sponge or soft cloth, such as a chamois.
- For hard-to-remove marks, use car wash soap and rinse thoroughly with water.
- Wipe away any water.
- Wax the vehicle when the waterproof coating deteriorates.

If water does not bead on a clean surface, apply wax when the vehicle body is cool.

- Automatic car washes
 - Fold the mirrors before washing the vehicle. Start washing from the front of the vehicle. Make sure to extend the mirrors before driving.
 - Brushes used in automatic car washes may scratch the vehicle surface and harm your vehicle's paint.
- High pressure car washes
 - Do not allow the nozzles of the car wash to come within close proximity of the windows.
 - Before using the car wash, check that the fuel filler door on your vehicle is closed properly.
- When using a car wash (vehicles with entry function)

If the door handle becomes wet while the electronic key is within the effective range, the door may lock and unlock repeatedly. In that case, follow the following correction procedures to wash the vehicle:

 - Place the key in a position 2 m (6 ft.) or more separate from the vehicle while the vehicle is being washed. (Take care to ensure that the key is not stolen.)
 - Set the electronic key to battery-saving mode to disable the smart entry & start system. (→P. 131)

- Aluminum wheels
 - Remove any dirt immediately by using a neutral detergent. Do not use hard brushes or abrasive cleaners. Do not use strong or harsh chemical cleaners. Use the same mild detergent and wax as used on the paint.
 - Do not use detergent on the wheels when they are hot, for example after driving a long distance in hot weather.
 - Wash detergent from the wheels immediately after use.
- Bumpers

Do not scrub with abrasive cleaners.
- Front side windows water-repellent coating
 - The following precautions can extend the effectiveness of the water-repellent coating.
 - Remove any dirt, etc. from the front side windows regularly.
 - Do not allow dirt and dust to accumulate on the windows for a long period. Clean the windows with a soft, damp cloth as soon as possible.
 - Do not use wax or glass cleaners that contain abrasives when cleaning the windows.
 - Do not use any metallic objects to remove condensation build up.
 - When the water-repellent performance has become insufficient, the coating can be repaired. Contact any authorized Lexus dealer or repairer, or another duly qualified and equipped professional.

تلفن شبانه روزی: ۰۲۱-۸۸۶۲۰۸۵

FarmaSOS.com

⚠ CAUTION

■ When washing the vehicle

Do not apply water to the inside of the engine compartment. Doing so may cause the electrical components etc. to catch fire.

■ When cleaning the windshield (vehicles with rain-sensing windshield wipers)

Set the wipers to the intermittent windshield wipers. (→P. 216)

If AUTO mode is selected, the wipers may operate unexpectedly in the following situations, and may result in hands being caught or other serious injuries and cause damage to the wiper blades.

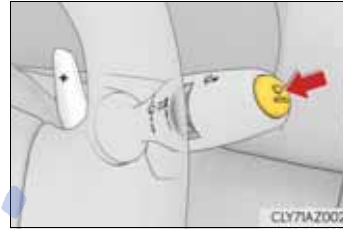

- When the upper part of the windshield where the raindrop sensor is located is touched by hand
- When a wet rag or similar is held close to the raindrop sensor
- If something bumps against the windshield
- If you directly touch the raindrop sensor body or if something bumps into the raindrop sensor

■ Precautions regarding the exhaust pipes

Exhaust gases cause the exhaust pipes to become quite hot.

When washing the vehicle, be careful not to touch the pipes until they have cooled sufficiently, as touching hot exhaust pipes can cause burns.

■ Precaution regarding the rear bumper with Blind Spot Monitor (if equipped)

If the paint of the rear bumper is chipped or scratched, the system may malfunction. If this occurs, consult any authorized Lexus dealer or repairer, or another duly qualified and equipped professional.



NOTICE

- To prevent paint deterioration and corrosion on the body and components (aluminum wheels etc.)
 - Wash the vehicle immediately in the following cases:
 - After driving near the sea coast
 - After driving on salted roads
 - If coal tar or tree sap is present on the paint surface
 - If dead insects, insect droppings or bird droppings are present on the paint surface
 - After driving in an area contaminated with soot, oily smoke, mine dust, iron powder or chemical substances
 - If the vehicle becomes heavily soiled with dust or mud
 - If liquids such as benzene and gasoline are spilled on the paint surface
 - If the paint is chipped or scratched, have it repaired immediately.
 - To prevent the wheels from corroding, remove any dirt and store in a place with low humidity when storing the wheels.
- Cleaning the exterior lights
 - Wash carefully. Do not use organic substances or scrub with a hard brush. This may damage the surfaces of the lights.
 - Do not apply wax to the surfaces of the lights. Wax may cause damage to the lenses.
- When using an automatic car wash (vehicles with rain-sensing windshield wipers)
Set the wipers to the intermittent windshield wipers. (→P. 216)
If AUTO mode is selected, the wipers may operate and the wiper blades may be damaged.

FarmaSOS.com

7

Maintenance and care

Cleaning and protecting the vehicle interior

The following procedures will help protect your vehicle's interior and keep it in top condition:

Protecting the vehicle interior

Remove dirt and dust using a vacuum cleaner. Wipe dirty surfaces with a cloth dampened with lukewarm water.

Cleaning the leather areas

- Remove dirt and dust using a vacuum cleaner.
- Wipe off any excess dirt and dust with a soft cloth dampened with diluted detergent.
Use a diluted water solution of approximately 5% neutral wool detergent.
- Wring out any excess water from the cloth and thoroughly wipe off all remaining traces of detergent.
- Wipe the surface with a dry, soft cloth to remove any remaining moisture. Allow the leather to dry in a shaded and ventilated area.

Cleaning the synthetic leather areas

- Remove loose dirt using a vacuum cleaner.
- Apply a mild soap solution to the synthetic leather using a sponge or soft cloth.
- Allow the solution to soak in for a few minutes. Remove the dirt and wipe off the solution with a clean, damp cloth.

■ Caring for leather areas

Lexus recommends cleaning the interior of the vehicle at least twice a year to maintain the quality of the vehicle's interior.

■ Shampooing the carpets

There are several commercial foaming-type cleaners available. Use a sponge or brush to apply the foam. Rub in overlapping circles. Do not use water. Wipe dirty surfaces and let them dry. Excellent results are obtained by keeping the carpet as dry as possible.

■ Seat belts

Clean with mild soap and lukewarm water using a cloth or sponge. Also check the belts periodically for excessive wear, fraying or cuts.

■ When cleaning the carpeted portions of the glove box, console box, etc.

If a strong adhesive tape is used, there is a possibility that the surface of the carpet could be damaged.

 CAUTION

■ Water in the vehicle

- Do not splash or spill liquid in the vehicle.

Doing so may cause electrical components etc. to malfunction or catch fire.

- Do not get any of the SRS components or wiring in the vehicle interior wet. (→P. 42)

An electrical malfunction may cause the airbags to deploy or not function properly, resulting in death or serious injury.

■ Cleaning the interior (especially instrument panel)

Do not use polish wax or polish cleaner. The instrument panel may reflect off the windshield, obstructing the driver's view and leading to an accident, resulting in death or serious injury.

**NOTICE****■ Cleaning detergents**

- Do not use the following types of detergent, as they may discolor the vehicle interior or cause streaks or damage to painted surfaces:
 - Non-seat portions: Organic substances such as benzene or gasoline, alkaline or acidic solutions, dye, and bleach
 - Seats: Alkaline or acidic solutions, such as thinner, benzene, and alcohol
- Do not use polish wax or polish cleaner. The instrument panel's or other interior part's painted surface may be damaged.

■ Preventing damage to leather surfaces

Observe the following precautions to avoid damage to and deterioration of leather surfaces:

- Remove any dust or dirt from leather surfaces immediately.
- Do not expose the vehicle to direct sunlight for extended periods of time. Park the vehicle in the shade, especially during summer.
- Do not place items made of vinyl, plastic, or containing wax on the upholstery, as they may stick to the leather surface if the vehicle interior heats up significantly.

■ Water on the floor

Do not wash the vehicle floor with water.

Vehicle systems such as the audio system may be damaged if water comes into contact with electrical components such as the audio system above or under the floor of the vehicle. Water may also cause the body to rust.

■ When cleaning the inside of the windshield (vehicles with LDA [Lane Departure Alert])

Be careful not to touch the camera sensor (→P. 242).

If the camera is accidentally scratched or hit, LDA may not operate properly or may cause a malfunction.

■ Cleaning the inside of the rear window

- Do not use glass cleaner to clean the rear window, as this may cause damage to the rear window defogger heater wires or antenna. Use a cloth dampened with lukewarm water to gently wipe the window clean. Wipe the window in strokes running parallel to the heater wires or antenna.
- Be careful not to scratch or damage the heater wires or antenna.

Maintenance requirements

To ensure safe and economical driving, day-to-day care and regular maintenance are essential. Lexus recommends the following maintenance:

Scheduled maintenance

Scheduled maintenance should be performed at specified intervals according to the maintenance schedule.

For details about maintenance items and schedules, refer to the “Lexus Service Booklet” or “Lexus Warranty Booklet”.

Do-it-yourself maintenance

What about do-it-yourself maintenance?

Many of the maintenance items are easy to do yourself if you have a little mechanical ability and a few basic automotive tools.

Note, however, that some maintenance tasks require special tools and skills. These are best performed by qualified technicians. Even if you're an experienced do-it-yourself mechanic, we recommend that repairs and maintenance be conducted by any authorized Lexus dealer or repairer, or another duly qualified and equipped professional. Any authorized Lexus dealer or repairer will keep a record of maintenance, which could be useful should you ever require Warranty Service. Should you choose to select a qualified and equipped professional other than an authorized Lexus repairer to service or maintain your vehicle, we recommend that you request that a record of maintenance be kept.

FarmaSOS.com

■ Where to go for maintenance service?

In order to maintain your vehicle in the best possible condition, Lexus recommends that maintenance service operations as well as other inspections and repairs be carried out by authorized Lexus dealers or repairers or other duly qualified and equipped professionals. For repairs and services covered by your warranty, please visit an authorized Lexus dealer or repairer, who will use genuine Lexus parts in repairing any difficulties you may encounter. There can also be advantages in utilizing authorized Lexus dealers or repairers for non-warranty repairs and services, as members of the Lexus network will be able to expertly assist you with any difficulties you may encounter.

Your Lexus dealer or repairer, or another duly qualified and equipped professional will perform all of the scheduled maintenance on your vehicle reliably and economically due to their experience with Lexus vehicles.

■ Does your vehicle need repairs?

Be on the alert for changes in performance and sounds, and visual tip-offs that indicate service is needed. Some important clues are:

- Engine missing, stumbling or pinging
- Appreciable loss of power
- Strange engine noises
- A fluid leak under the vehicle (However, water dripping from the air conditioning system after use is normal.)
- Change in exhaust sound (This may indicate a dangerous carbon monoxide leak. Drive with the windows open and have the exhaust system checked immediately.)
- Flat-looking tires, excessive tire squeal when cornering, uneven tire wear
- Vehicle pulls to one side when driven straight on a level road
- Strange noises related to suspension movement
- Loss of brake effectiveness, spongy feeling brake pedal, pedal almost touches the floor, vehicle pulls to one side when braking
- Engine coolant temperature continually higher than normal (→P. 95)

If you notice any of these clues, take your vehicle to any authorized Lexus dealer or repairer, or another duly qualified and equipped professional as soon as possible. Your vehicle may need adjustment or repair.

 CAUTION

■ If your vehicle is not properly maintained

Improper maintenance could result in serious damage to the vehicle and possible death or serious injury.

■ Handling of the battery

Battery posts, terminals and related accessories contain lead and lead compounds which are known to cause brain damage. Wash your hands after handling. (→P. 420)

Do-it-yourself service precautions

If you perform maintenance by yourself, be sure to follow the correct procedure as given in these sections.

Items	Parts and tools
Battery condition (→P. 420)	<ul style="list-style-type: none"> • Warm water • Baking soda • Grease • Conventional wrench (for terminal clamp bolts) • Distilled water
Engine coolant level (→P. 419)	<ul style="list-style-type: none"> • “Toyota Super Long Life Coolant” or a similar high quality ethylene glycol-based non-silicate, non-amine, non-nitrite and non-borate coolant with long-life hybrid organic acid technology “Toyota Super Long Life Coolant” is pre-mixed with 50% coolant and 50% deionized water. • Funnel (used only for adding coolant)
Engine oil level (→P. 416)	<ul style="list-style-type: none"> • “Toyota Genuine Motor Oil” or equivalent • Rag or paper towel • Funnel (used only for adding engine oil)
Fuses (→P. 444)	<ul style="list-style-type: none"> • Fuse with same amperage rating as original
Light bulbs (→P. 448)	<ul style="list-style-type: none"> • Bulb with same number and wattage rating as original • Phillips-head screw- • Flathead screwdriver driver • Wrench
Radiator and condenser (→P. 420)	
Tire inflation pressure (→P. 435)	<ul style="list-style-type: none"> • Tire pressure gauge • Compressed air source
Washer fluid (→P. 424)	<ul style="list-style-type: none"> • Water or washer fluid containing antifreeze (for winter use) • Funnel (used only for adding water or washer fluid)

 CAUTION

The engine compartment contains many mechanisms and fluids that may move suddenly, become hot, or become electrically energized. To avoid death or serious injury, observe the following precautions.

- When working on the engine compartment
 - Keep hands, clothing and tools away from the moving fan and engine drive belt.
 - Be careful not to touch the engine, radiator, exhaust manifold, etc. right after driving as they may be hot. Oil and other fluids may also be hot.
 - Do not leave anything that may burn easily, such as paper and rags, in the engine compartment.
 - Do not smoke, cause sparks or expose an open flame to fuel or the battery. Fuel and battery fumes are flammable.
 - Be extremely cautious when working on the battery. It contains poisonous and corrosive sulfuric acid.
 - Take care because brake fluid can harm your hands or eyes and damage painted surfaces. If fluid gets on your hands or in your eyes, flush the affected area with clean water immediately.
If you still experience discomfort, consult a doctor.
- When working near the electric cooling fans or radiator grille

Be sure the engine switch is off.
With the engine switch in IGNITION ON mode, the electric cooling fans may automatically start to run if the air conditioning is on and/or the coolant temperature is high. (→P. 420)
- Safety glasses

Wear safety glasses to prevent flying or falling material, fluid spray, etc. from getting in your eyes.

 NOTICE

- If you remove the air cleaner filter

Driving with the air cleaner filter removed may cause excessive engine wear due to dirt in the air.
- If the fluid level is low or high

It is normal for the brake fluid level to go down slightly as the brake pads wear or when the fluid level in the accumulator is high.
If the reservoir needs frequent refilling, it may indicate a serious problem.

Hood

Release the lock from the inside of the vehicle to open the hood.

- 1 Pull the hood lock release lever.
The hood will pop up slightly.

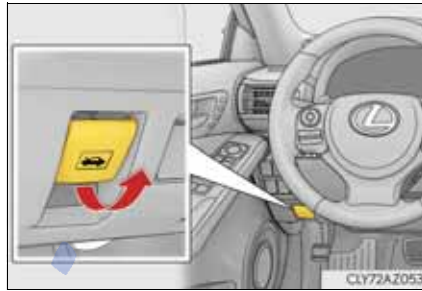

- 2 Pull up the auxiliary catch lever and lift the hood.

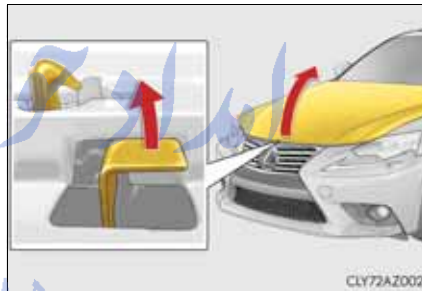

⚠ CAUTION

■ Pre-driving check

Check that the hood is fully closed and locked.
If the hood is not locked properly, it may open while the vehicle is in motion and cause an accident, which may result in death or serious injury.

Positioning a floor jack

When using a floor jack, follow the instructions in the manual provided with the jack and perform the operation safely.

When raising your vehicle with a floor jack, position the jack correctly. Improper placement may damage your vehicle or cause injury.

◆ Front

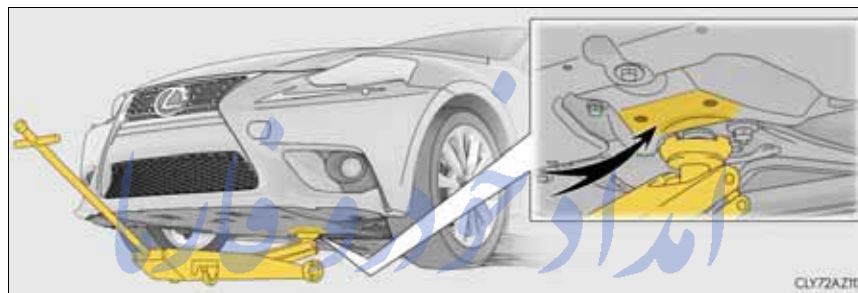

◆ Rear

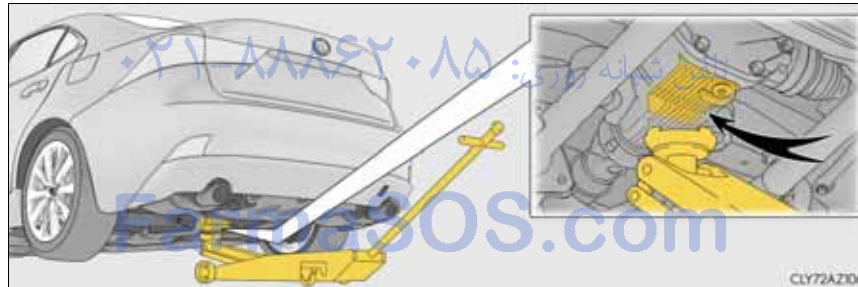

Engine compartment

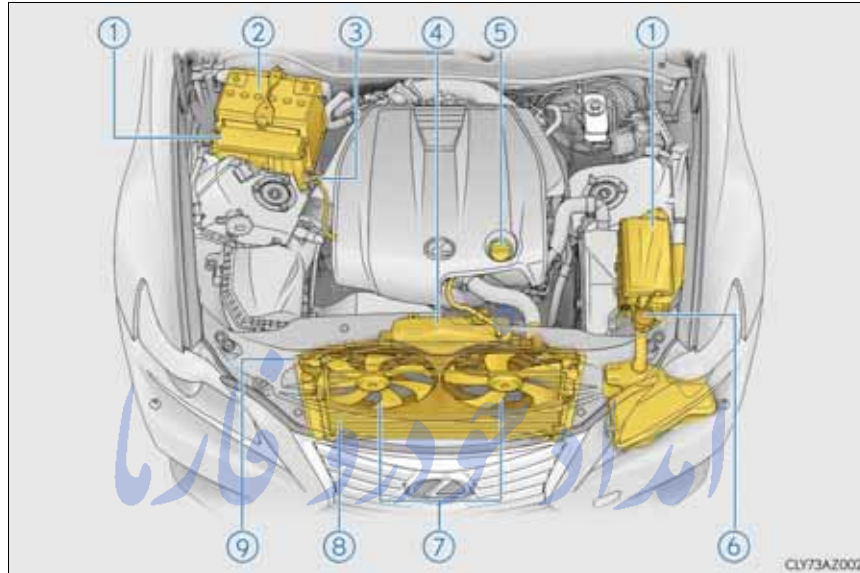

- | | | | |
|-----------------------------|-----------|-------------------------|-----------|
| ① Fuse boxes | (→P. 444) | ⑥ Washer fluid tank | (→P. 424) |
| ② Battery | (→P. 420) | ⑦ Electric cooling fans | |
| ③ Engine oil level dipstick | (→P. 416) | ⑧ Condenser | (→P. 420) |
| ④ Engine coolant reservoir | (→P. 419) | ⑨ Radiator | (→P. 420) |
| ⑤ Engine oil filler cap | (→P. 417) | | |

For right-hand drive vehicles:

The battery and the fuse box in front of the battery are located on the opposite side of the engine compartment.

Engine oil

With the engine at operating temperature and turned off, check the oil level on the dipstick.

■ Checking the engine oil

- 1 Park the vehicle on level ground. After warming up the engine and turning off the engine, wait more than 5 minutes for the oil to drain back into the bottom of the engine.
- 2 Holding a rag under the end, pull the dipstick out.

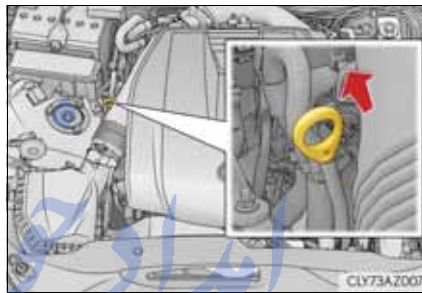

- 3 Wipe the dipstick clean.
- 4 Reinsert the dipstick fully.
- 5 Holding a rag under the end, pull the dipstick out and check the oil level.

- 1 Low
- 2 Normal
- 3 Excessive

The shape of the dipstick may differ depending on the type of vehicle or engine.

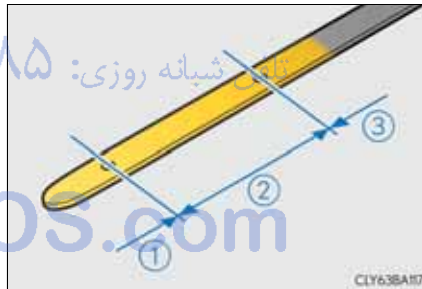

- 6 Wipe the dipstick and reinsert it fully.

■ Adding engine oil

If the oil level is below or near the low level mark, add engine oil of the same type as that already in the engine.



Make sure to check the oil type and prepare the items needed before adding oil.

Engine oil selection	→P. 539
Oil quantity (Low → Full)	1.5 L (1.6 qt., 1.3 Imp. qt.)
Items	Clean funnel

- 1 Remove the oil filler cap by turning it counterclockwise.
- 2 Add engine oil slowly, checking the dipstick.
- 3 Install the oil filler cap by turning it clockwise.

■ Engine oil consumption

A certain amount of engine oil will be consumed while driving. In the following situations, oil consumption may increase, and engine oil may need to be refilled in between oil maintenance intervals.

- When the engine is new, for example directly after purchasing the vehicle or after replacing the engine
- If low quality oil or oil of an inappropriate viscosity is used
- When driving at high engine speeds or with a heavy load, when towing, or when driving while accelerating or decelerating frequently
- When leaving the engine idling for a long time, or when driving frequently through heavy traffic

 CAUTION

■ Used engine oil

- Used engine oil contains potentially harmful contaminants which may cause skin disorders such as inflammation and skin cancer, so care should be taken to avoid prolonged and repeated contact. To remove used engine oil from your skin, wash thoroughly with soap and water.
- Dispose of used oil and filters only in a safe and acceptable manner. Do not dispose of used oil and filters in household trash, in sewers or onto the ground.
Call any authorized Lexus dealer or repairer, or another duly qualified and equipped professional, service station or auto parts store for information concerning recycling or disposal.
- Do not leave used engine oil within the reach of children.

 NOTICE

- To prevent serious engine damage
Check the oil level on a regular basis.
- When replacing the engine oil
 - Be careful not to spill engine oil on the vehicle components.
 - Avoid overfilling, or the engine could be damaged.
 - Check the oil level on the dipstick every time you refill the vehicle.
 - Be sure the engine oil filler cap is properly tightened.

FarmaSOS.com

Engine coolant

The coolant level is satisfactory if it is between the “FULL” and “LOW” lines on the reservoir when the engine is cold.

- ① Reservoir cap
- ② “FULL” line
- ③ “LOW” line

If the level is on or below the “LOW” line, add coolant up to the “FULL” line. (→P. 530)

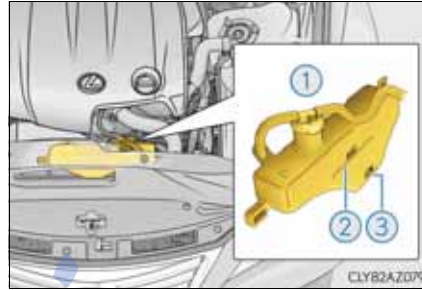

■ Coolant selection

Only use “Toyota Super Long Life Coolant” or a similar high quality ethylene glycol based non-silicate, non-amine, non-nitrite, and non-borate coolant with long-life hybrid organic acid technology.

“Toyota Super Long Life Coolant” is a mixture of 50% coolant and 50% deionized water. (Minimum temperature: -35°C [-31°F])

For more details about coolant, contact any authorized Lexus dealer or repairer, or another duly qualified and equipped professional.

■ If the coolant level drops within a short time of replenishing

Visually check the radiator, hoses, engine coolant reservoir cap, drain cock and water pump.

If you cannot find a leak, have any authorized Lexus dealer or repairer, or another duly qualified and equipped professional, test the cap and check for leaks in the cooling system.



CAUTION

■ When the engine is hot

Do not remove the engine coolant reservoir cap or radiator cap. (→P. 530)

The cooling system may be under pressure and may spray hot coolant if the cap is removed, causing serious injuries, such as burns.

 NOTICE

- When adding coolant

Coolant is neither plain water nor straight antifreeze. The correct mixture of water and antifreeze must be used to provide proper lubrication, corrosion protection and cooling. Be sure to read the antifreeze or coolant label.

- If you spill coolant

Be sure to wash it off with water to prevent it from damaging parts or paint.

Radiator and condenser

Check the radiator and condenser and clear away any foreign objects. If either of the above parts is extremely dirty or you are not sure of their condition, have your vehicle inspected by any authorized Lexus dealer or repairer, or another duly qualified and equipped professional.

 CAUTION

- When the engine is hot







Do not touch the radiator or condenser as they may be hot and cause serious injuries, such as burns.

Battery

Check the battery as follows.

- Caution symbols

The meaning of each caution symbol on the top of the battery are as follows:

	No smoking, no naked flames, no sparks		Battery acid
	Shield eyes		Note operating instructions
	Keep away from children		Explosive gas

■ Battery exterior

Make sure that the battery terminals are not corroded and that there are no loose connections, cracks, or loose clamps.

- ① Terminals
- ② Hold-down clamp



■ Checking battery fluid

Check that the level is between the “UPPER LEVEL” and “LOWER LEVEL” lines.

- ① “UPPER LEVEL” line
- ② “LOWER LEVEL” line

If the fluid level is at or below the “LOWER LEVEL” line, add distilled water.

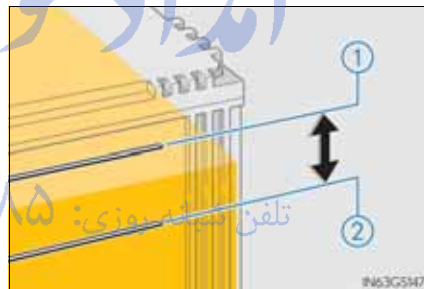

■ Adding distilled water

- 1 Remove the vent plug.
- 2 Add distilled water.

If the “UPPER LEVEL” line cannot be seen, check the fluid level by looking directly at the cell.

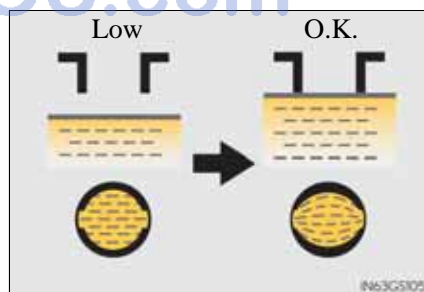

- 3 Put the vent plug back on and close it securely.

■ Before recharging

When recharging, the battery produces hydrogen gas which is flammable and explosive. Therefore, observe the following before recharging:

- If recharging with the battery installed on the vehicle, be sure to disconnect the ground cable.
- Make sure the power switch on the charger is off when connecting and disconnecting the charger cables to the battery.

■ After recharging/reconnecting the battery

The engine may not start. Follow the procedure below to initialize the system.

1 Shift the shift lever to P.

2 Open and close any of the doors.

3 Restart the engine.

- Unlocking the doors using the smart entry & start system may not be possible immediately after reconnecting the battery. If this happens, use the wireless remote control or the mechanical key to lock/unlock the doors.
- Start the engine with the engine switch in ACCESSORY mode. The engine may not start with the engine switch turned off. However, the engine will operate normally from the second attempt.
- The engine switch mode is recorded by the vehicle. If the battery is disconnected and reconnected, the vehicle will return the engine switch mode to the status it was in before the battery was disconnected. Make sure to turn off the engine before disconnecting the battery. Take extra care when connecting the battery if the engine switch mode prior to the battery being disconnected is unknown.

If the engine will not start even after multiple attempts at all the methods contact any authorized Lexus dealer or repairer, or another duly qualified and equipped professional.

FarmaSOS.com

 CAUTION

■ Chemicals in the battery

Batteries contain poisonous and corrosive sulfuric acid and may produce hydrogen gas which is flammable and explosive. To reduce the risk of death or serious injury, take the following precautions while working on or near the battery:

- Do not cause sparks by touching the battery terminals with tools.
- Do not smoke or light a match near the battery.
- Avoid contact with eyes, skin and clothes.
- Never inhale or swallow electrolyte.
- Wear protective safety glasses when working near the battery.
- Keep children away from the battery.

■ Where to safely charge the battery

Always charge the battery in an open area. Do not charge the battery in a garage or closed room where there is insufficient ventilation.

■ Emergency measures regarding electrolyte

- If electrolyte gets in your eyes
Flush your eyes with clean water for at least 15 minutes and get immediate medical attention. If possible, continue to apply water with a sponge or cloth while traveling to the nearest medical facility.
- If electrolyte gets on your skin
Wash the affected area thoroughly. If you feel pain or burning, get medical attention immediately.
- If electrolyte gets on your clothes
It can soak through clothing on to your skin. Immediately take off the clothing and follow the procedure above if necessary.
- If you accidentally swallow electrolyte
Drink a large quantity of water or milk. Get emergency medical attention immediately.

 NOTICE

■ When recharging the battery

Never recharge the battery while the engine is running. Also, be sure all accessories are turned off.

■ When adding distilled water

Avoid overfilling. Water spilled during battery recharging may cause corrosion.

Washer fluid

If any washer does not work or the warning message appears on the multi-information display, the washer tank may be empty. Add washer fluid.



⚠ CAUTION

■ When adding washer fluid

Do not add washer fluid when the engine is hot or running as washer fluid contains alcohol and may catch fire if spilled on the engine etc.

⚠ NOTICE

■ Do not use any fluid other than washer fluid

Do not use soapy water or engine antifreeze instead of washer fluid. Doing so may cause streaking on the vehicle's painted surfaces.

■ Diluting washer fluid

Dilute washer fluid with water as necessary.

Refer to the freezing temperatures listed on the label of the washer fluid bottle.

FarmaSOS.com

Tires

Replace or rotate tires in accordance with maintenance schedules and treadwear.

Checking tires

- ① New tread
- ② Treadwear indicator
- ③ Worn tread

The location of treadwear indicators is shown by the “TWI” or “Δ” marks, etc., molded on the sidewall of each tire.

Check spare tire condition and pressure if not rotated.



Tire rotation

Rotate the tires in the order shown.

- ▶ Vehicles with front and rear tires of the same size
- ▶ Vehicles with front and rear tires of differing sizes

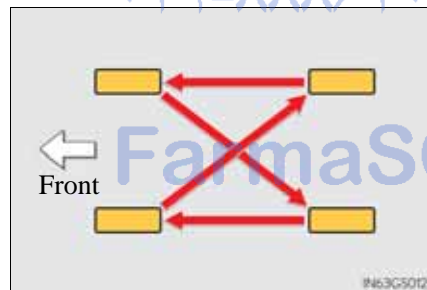

To equalize tire wear and help extend tire life, Lexus recommends that tire rotation is carried out approximately every 10000 km (6000 miles).

Do not fail to initialize the tire pressure warning system after tire rotation. (vehicle with the tire pressure warning system)

Tire pressure warning system (if equipped)

Your vehicle is equipped with a tire pressure warning system that uses tire pressure warning valves and transmitters to detect low tire inflation pressure before serious problems arise.

If the tire pressure drops below a predetermined level, the driver is warned by a warning light. (→P. 477)

◆ Installing tire pressure warning valves and transmitters

When replacing tires or wheels, tire pressure warning valves and transmitters must also be installed.

When new tire pressure warning valves and transmitters are installed, new ID codes must be registered in the tire pressure warning computer and the tire pressure warning system must be initialized. Have tire pressure warning valve and transmitter ID codes registered by any authorized Lexus dealer or repairer, or another duly qualified and equipped professional. (→P. 427)

◆ Initializing the tire pressure warning system

■ The tire pressure warning system must be initialized in the following circumstances:

- When rotating the tires.
- When the tire inflation pressure is changed such as when changing traveling speed or load weight.
- When changing the tire size.

When the tire pressure warning system is initialized, the current tire inflation pressure is set as the benchmark pressure.

■ How to initialize the tire pressure warning system

- 1 Park the vehicle in a safe place and turn the engine switch off.
Initialization cannot be performed while the vehicle is moving.
- 2 Adjust the tire inflation pressure to the specified cold tire inflation pressure level. (→P. 544)
Make sure to adjust the tire pressure to the specified cold tire inflation pressure level. The tire pressure warning system will operate based on this pressure level.
- 3 Turn the engine switch to IGNITION ON mode.
- 4 Press and hold the tire pressure warning reset switch until the tire pressure warning light blinks slowly 3 times.



- 5 Wait for a few minutes with the engine switch in IGNITION ON mode and then turn the engine switch off.

◆ Registering ID codes

The tire pressure warning valve and transmitter is equipped with a unique ID code. When replacing a tire pressure warning valve and transmitter, it is necessary to register the ID code. Have the ID code registered by any authorized Lexus dealer or repairer, or another duly qualified and equipped professional.

■ When to replace your vehicle's tires

Tires should be replaced if:

- You have tire damage such as cuts, splits, cracks deep enough to expose the fabric, and bulges indicating internal damage
- A tire goes flat repeatedly or cannot be properly repaired due to the size or location of a cut or other damage

If you are not sure, consult any authorized Lexus dealer or repairer, or another duly qualified and equipped professional.

■ Replacing tires and wheels (vehicles with the tire pressure warning system)

If the ID code of the tire pressure warning valve and transmitter is not registered, the tire pressure warning system will not work properly. After driving for about 10 minutes, the tire pressure warning light blinks for 1 minute and stays on to indicate a system malfunction.

■ Tire life

Any tire over 6 years old must be checked by a qualified technician even if it has seldom or never been used or damage is not obvious.

■ Routine tire inflation pressure checks

The tire pressure warning system does not replace routine tire inflation pressure checks. Make sure to check tire inflation pressure as part of your routine of daily vehicle checks.

■ Low profile tires (except 16-inch tires)

Generally, low profile tires will wear more rapidly and tire grip performance will be reduced on snowy and/or icy roads when compared to standard tires. Be sure to use snow tires or tire chains* on snowy and/or icy roads and drive carefully at a speed appropriate for road and weather conditions.

*: Tire chains cannot be mounted on the 18-inch tires. Snow tires should be used instead.

■ If the tread on snow tires wears down below 4 mm (0.16 in.)

The effectiveness of the tires as snow tires is lost.

- Situations in which the tire pressure warning system may not operate properly (vehicles with the tire pressure warning system)
 - In the following cases, the tire pressure warning system may not operate properly.
 - If non-genuine Lexus wheels are used.
 - A tire has been replaced with a tire that is not an OE (Original Equipment) tire.
 - A tire has been replaced with a tire that is not of the specified size.
 - Tire chains etc. are equipped.
 - Lock nuts are equipped.
 - An auxiliary-supported run-flat tire is equipped.
 - If a window tint that affects the radio wave signals is installed.
 - If there is a lot of snow or ice on the vehicle, particularly around the wheels or wheel housings.
 - If the tire inflation pressure is extremely higher than the specified level.
 - If tires not equipped with tire pressure warning valves and transmitters are used.
 - If the ID code on the tire pressure warning valves and transmitters is not registered in the tire pressure warning computer.
 - Performance may be affected in the following situations.
 - Near a TV tower, electric power plant, gas station, radio station, large display, airport or other facility that generates strong radio waves or electrical noise
 - When carrying a portable radio, cellular phone, cordless phone or other wireless communication device
 - When the vehicle is parked, the time taken for the warning to start or go off could be extended.
 - When tire inflation pressure declines rapidly for example when a tire has burst, the warning may not function.
- The initialization operation (vehicles with the tire pressure warning system)
 - Make sure to carry out initialization after adjusting the tire inflation pressure. Also, make sure the tires are cold before carrying out initialization or tire inflation pressure adjustment.
 - If you have accidentally turned the engine switch off during initialization, it is not necessary to press the reset switch again as initialization will restart automatically when the engine switch has been turned to IGNITION ON mode for the next time.
 - If you accidentally press the reset switch when initialization is not necessary, adjust the tire inflation pressure to the specified level when the tires are cold, and conduct initialization again.
- Warning performance of the tire pressure warning system (if equipped)

The warning of the tire pressure warning system will change in accordance with the conditions under which it was initialized. For this reason, the system may give a warning even if the tire pressure does not reach a low enough level, or if the pressure is higher than the pressure that was adjusted to when the system was initialized.

- When initialization of the tire pressure warning system has failed (vehicles with the tire pressure warning system)

Initialization can be completed in a few minutes. However, in the following cases, the settings have not been recorded and the system will not operate properly. If repeated attempts to record tire inflation pressure settings are unsuccessful, have the vehicle inspected by any authorized Lexus dealer or repairer, or another duly qualified and equipped professional.

- When operating the tire pressure warning reset switch, the tire pressure warning light does not blink 3 times.
- After carrying out the initialization procedure, the tire pressure warning light blinks for 1 minute then stays on after driving for 20 minutes.

امداد خودرو فارما

تلفن شبانه روزی: ۰۲۱-۸۸۸۶۲۰۸۵

FarmaSOS.com

■ Certification for tire pressure warning system (vehicles with the tire pressure warning system)

Hereby, PACIFIC INDUSTRIAL CO.,LTD. , declares that this PMV-C210 is in compliance with the essential requirements and other relevant provisions of Directive 1999/5/EC.

Ovim PACIFIC INDUSTRIAL CO.,LTD., izjavljuje da je PMV-C210 u skladu s bitnim zahtjevima drugim relevantnim odredbama Direktive 1999/5/EC i Pravilnika o RiTT opremi (NN 25/2012).

 The latest "DECLARATION of CONFORMITY" (DoC) is available at the following address:
<http://is-serv.isd.denso.co.jp:81/en/products/oem/index.html>

Hereby, DENSO CORPORATION declares that this 23AAF is in compliance with the essential requirements and other relevant provisions of Directive 1999/5/EC.
DENSO CORPORATION vakuuttaa täten että 23AAF tyyppinen laite on direktiivin 1999/5/EY oleellisten vaatimusten ja sitä koskevien direktiivin muiden ehtojen mukainen.
Hierbij verklaart DENSO CORPORATION dat het toestel 23AAF in overeenstemming is met de essentiële eisen en de andere relevante bepalingen van richtlijn 1999/5/EG.
Par la présente DENSO CORPORATION déclare que l'appareil 23AAF est conforme aux exigences essentielles et aux autres dispositions pertinentes de la directive 1999/5/CE.
Härmed intygar DENSO CORPORATION att denna 23AAF står i överensstämmelse med de väsentliga egenskapskrav och övriga relevanta bestämmelser som framgår av direktiv 1999/5/EG.
Undertegnede DENSO CORPORATION erklærer herved, at følgende udstyr 23AAF overholder de væsentlige krav og øvrige relevante krav i direktiv 1999/5/EF.
Hiermit erkläre DENSO CORPORATION, dass sich das Gerät 23AAF in Übereinstimmung mit den grundlegenden Anforderungen und den übrigen einschlägigen Bestimmungen der Richtlinie 1999/5/EG befindet.
ΜΕ ΤΗΝ ΠΑΡΟΥΣΑ DENSO CORPORATION ΔΗΛΩΝΕΙ ΟΤΙ 23AAF ΣΥΜΜΟΡΦΩΝΕΤΑΙ ΠΡΟΣ ΤΙΣ ΟΥΣΙΩΔΕΙΣ ΑΠΑΙΤΗΣΕΙΣ ΚΑΙ ΤΙΣ ΛΟΙΠΕΣ ΣΧΕΤΙΚΕΣ ΔΙΑΤΑΞΕΙΣ ΤΗΣ ΟΔΗΓΙΑΣ 1999/5/ΕΚ.
Con la presente DENSO CORPORATION dichiara che questo 23AAF è conforme ai requisiti essenziali ed alle altre disposizioni pertinenti stabilite dalla direttiva 1999/5/CE.
Por medio de la presente DENSO CORPORATION declara que el 23AAF cumple con los requisitos esenciales y cualesquiera otras disposiciones aplicables o exigibles de la Directiva 1999/5/CE.
DENSO CORPORATION declara que este 23AAF está conforme com os requisitos essenciais e outras disposições da Directiva 1999/5/CE.
Hawnhekk, DENSO CORPORATION, jiddikjara li dan 23AAF jikkonforma mal-htigijiet essenzjali u ma provvedimenti oħrajn relevanti li hemm fid-Direttiva 1999/5/EC.
Käesolevaga kinnitab DENSO CORPORATION seadme 23AAF vastavust direktiivi 1999/5/EÜ põhinõuetele ja nimetatud direktiivist tulenevatele teistele asjakohastele sätetele.

Alulírott, DENSO CORPORATION nyilatkozom, hogy a 23AAF megfelel a vonatkozó alapvető követelményeknek és az 1999/5/EC irányelv egyéb előírásainak.
DENSO CORPORATION tímto vyhlasuje, že 23AAF splňa základné požiadavky a všetky príslušné ustanovenia Smernice 1999/5/ES.
DENSO CORPORATION tímto prohlašuje, že tento 23AAF je ve shodě se základními požadavky a dalšími příslušnými ustanoveními směrnice 1999/5/ES.
DENSO CORPORATION izjavlja, da je ta 23AAF v skladu z bistvenimi zahtevami in ostalimi relevantnimi določili direktive 1999/5/ES.
Šiuo DENSO CORPORATION deklaruoja, kad šis 23AAF atitinka esminius reikalavimus ir kitas 1999/5/EB Direktyvos nuostatas.
Ar šo DENSO CORPORATION deklarē, ka 23AAF atbilst Direktīvas 1999/5/EK būtiskajām prasībām un citiem ar to saistītajiem noteikumiem.
Niniejszym DENSO CORPORATION oświadcza, że 23AAF jest zgodny z zasadniczymi wymogami oraz pozostałymi stosownymi postanowieniami Dyrektywy 1999/5/EC.
Hér með lýsir DENSO CORPORATION yfir því að 23AAF er í samræmi við grunnkröfur og aðrar kröfur, sem gerðar eru í tilskipun 1999/5/EC.
DENSO CORPORATION erklærer herved at utstyret 23AAF er i samsvar med de grunnleggende krav og øvrige relevante krav i direktiv 1999/5/EF.
С настоящето, DENSO CORPORATION, декларира, че 23AAF е в съответствие със съществените изисквания и другите приложими разпоредби на Директива 1999/5/EC.
Prin prezenta, DENSO CORPORATION, declară că aparatul 23AAF este în conformitate cu cerințele esențiale și cu alte prevederi pertinente ale Directivei 1999/5/CE.
Ovim, DENSO CORPORATION, izjavljuje da ovaj 23AAF je usklađen sa bitnim zahtjevima i drugim relevantnim odredbama Direktive 1999/5/EC.
Ovim DENSO CORPORATION, izjavljuje da je 23AAF u skladu s bitnim zahtjevima i drugim relevantnim odredbama Direktive 1999/5/EC i Pravilnika o RiTT opremi (NN 25/2012).

FarmaSOS.com

 CAUTION

■ When inspecting or replacing tires

Observe the following precautions to prevent accidents.

Failure to do so may cause damage to parts of the drivetrain as well as dangerous handling characteristics, which may lead to an accident resulting in death or serious injury.

- Do not mix tires of different makes, models or tread patterns.
Also, do not mix tires of remarkably different treadwear.
- Do not use tire sizes other than those recommended by Lexus.
- Do not mix differently constructed tires (radial, bias-belted or bias-ply tires).
- Do not mix summer, all season and snow tires.
- Do not use tires that have been used on another vehicle.
Do not use tires if you do not know how they were used previously.
- Vehicles with a compact spare tire: Do not tow if your vehicle has a compact spare tire installed.
- Vehicles with an emergency tire puncture repair kit: Do not tow anything if a tire that has been repaired using the emergency tire puncture repair kit is installed. The load on the tire may cause unexpected damage to the tire.

■ When initializing the tire pressure warning system (vehicles with the tire pressure warning system)

Do not operate the tire pressure warning reset switch without first adjusting the tire inflation pressure to the specified level. Otherwise, the tire pressure warning light may not come on even if the tire inflation pressure is low, or it may come on when the tire inflation pressure is actually normal.

FarmaSOS.com

7

Maintenance and care

**NOTICE**

- Repairing or replacing tires, wheels, tire pressure warning valves, transmitters and tire valve caps (vehicles with the tire pressure warning system)
 - When removing or fitting the wheels, tires or the tire pressure warning valves and transmitters, contact any authorized Lexus dealer or repairer, or another duly qualified and equipped professional as the tire pressure warning valves and transmitters may be damaged if not handled correctly.
 - Make sure to install the tire valve caps. If the tire valve caps are not installed, water could enter the tire pressure warning valves and the tire pressure warning valves could be bound.
 - When replacing tire valve caps, do not use tire valve caps other than those specified. The cap may become stuck.
- To avoid damage to the tire pressure warning valves and transmitters (vehicles with the tire pressure warning system)

When a tire is repaired with liquid sealants, the tire pressure warning valve and transmitter may not operate properly. If a liquid sealant is used, contact any authorized Lexus dealer or repairer, or another duly qualified and equipped professional or other qualified service shop as soon as possible. Make sure to replace the tire pressure warning valve and transmitter when replacing the tire. (→P. 426)
- Driving on rough roads

Take particular care when driving on roads with loose surfaces or potholes. These conditions may cause losses in tire inflation pressure, reducing the cushioning ability of the tires. In addition, driving on rough roads may cause damage to the tires themselves, as well as the vehicle's wheels and body.
- Low profile tires (except 16-inch tires)

Low profile tires may cause greater damage than usual to the tire wheel when sustaining impact from the road surface. Therefore, pay attention to the following:

 - Be sure to use proper tire inflation pressure. If tires are under-inflated, they may be damaged more severely.
 - Avoid potholes, uneven pavement, curbs and other road hazards. Failure to do so may lead to severe tire and wheel damage.
- If tire inflation pressure of each tire becomes low while driving

Do not continue driving, or your tires and/or wheels may be ruined.

Tire inflation pressure

Make sure to maintain proper tire inflation pressure. Tire inflation pressure should be checked at least once per month. However, Lexus recommends that tire inflation pressure be checked once every two weeks. (→P. 544)

■ Effects of incorrect tire inflation pressure

Driving with incorrect tire inflation pressure may result in the following:

- Reduced fuel efficiency
- Reduced driving comfort and tire life
- Reduced safety
- Damage to the drivetrain

If a tire needs frequent inflating, have it checked by any authorized Lexus dealer or repairer, or another duly qualified and equipped professional.

■ Instructions for checking tire inflation pressure

When checking tire inflation pressure, observe the following:

- Check only when the tires are cold.
If your vehicle has been parked for at least 3 hours or has not been driven for more than 1.5 km or 1 mile, you will get an accurate cold tire inflation pressure reading.
- Always use a tire pressure gauge.
The appearance of the tire can be misleading. In addition, tire inflation pressure that is even just a few pounds off can affect ride quality and handling.
- Do not reduce tire inflation pressure after driving. It is normal for tire inflation pressure to be higher after driving.
- Never exceed the vehicle capacity weight.
Passengers and luggage weight should be placed so that the vehicle is balanced.

 CAUTION

- Proper inflation is critical to save tire performance
Keep your tires properly inflated. Otherwise, the following conditions may occur and result in an accident causing death or serious injury:
 - Excessive wear
 - Uneven wear
 - Poor handling
 - Possibility of blowouts resulting from overheated tires
 - Poor sealing of the tire bead
 - Wheel deformation and/or tire separation
 - A greater possibility of tire damage from road hazards

 NOTICE

- When inspecting and adjusting tire inflation pressure
Be sure to put the tire valve caps back on.
Without the valve caps, dirt or moisture could get into the valve and cause air leakage, which could result in an accident. If the caps are lost, replace them as soon as possible.

تلفن شبانه روزی: ۰۲۱-۸۸۶۲۰۸۵

FarmaSOS.com

Wheels

If a wheel is bent, cracked or heavily corroded, it should be replaced. Otherwise, the tire may separate from the wheel or cause a loss of handling control.

Wheel selection

When replacing wheels, care should be taken to ensure that they are equivalent to those removed in load capacity, diameter, rim width and inset*.

Replacement wheels are available at any authorized Lexus dealer or repairer, or another duly qualified and equipped professional.

*: Conventionally referred to as “off-set”.

Lexus does not recommend using the following:

- Wheels of different sizes or types
- Used wheels
- Bent wheels that have been straightened

Aluminum wheel precautions

- Use only Lexus wheel nuts and wrenches designed for use with your aluminum wheels.
- When rotating, repairing or changing your tires, check that the wheel nuts are still tight after driving 1600 km (1000 miles).
- Be careful not to damage the aluminum wheels when using tire chains.
- Use only Lexus genuine balance weights or equivalent and a plastic or rubber hammer when balancing your wheels.

- When replacing wheels (vehicles with the tire pressure warning system)

The wheels of your vehicle are equipped with tire pressure warning valves and transmitters that allow the tire pressure warning system to provide advance warning in the event of a loss in tire inflation pressure. Whenever wheels are replaced, tire pressure warning valves and transmitters must be installed. (→P. 426)

 CAUTION

- When replacing wheels
 - Do not use wheels that are a different size from those recommended in the Owner's Manual, as this may result in a loss of handling control.
 - Never use an inner tube in a leaking wheel which is designed for a tubeless tire. Doing so may result in an accident, causing death or serious injury.

 NOTICE

- Replacing tire pressure warning valves and transmitters (vehicles with the tire pressure warning system)
 - Because tire repair or replacement may affect the tire pressure warning valves and transmitters, make sure to have tires serviced by any authorized Lexus dealer or repairer, or another duly qualified and equipped professional or other qualified service shop. In addition, make sure to purchase your tire pressure warning valves and transmitters at any authorized Lexus dealer or repairer, or another duly qualified and equipped professional.
 - Ensure that only genuine Lexus wheels are used on your vehicle. Tire pressure warning valves and transmitters may not work properly with non-genuine wheels.

تلفن شبانه روزی: ۰۲۱-۸۸۶۲۰۸۵

FarmaSOS.com

Air conditioning filter

The air conditioning filter must be changed regularly to maintain air conditioning efficiency.

Removal method

- 1 Turn the engine switch off.
- 2 Open the glove box. Lift up the side with the stay, disconnect the stay tabs and remove the partition by pulling horizontally.
- 3 Press the tabs and remove the filter cover.
- 4 Press the tabs and remove the filter case.

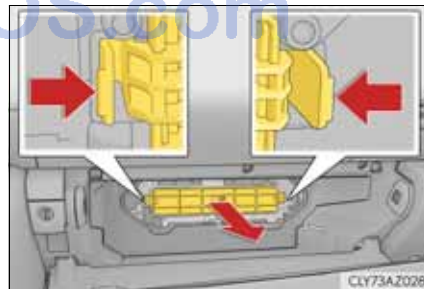
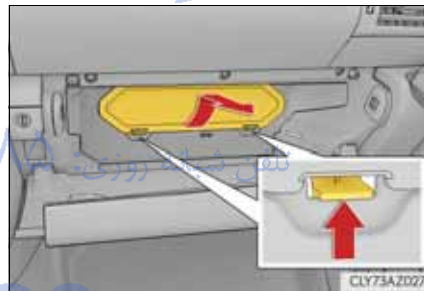
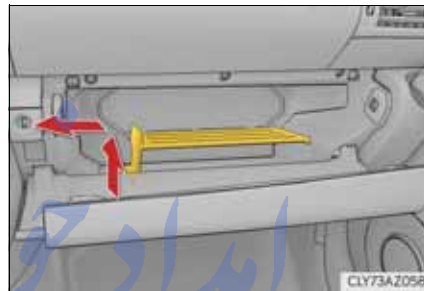

- 5 Remove the air conditioning filter from the filter case and replace it with a new one.

The “↑UP” marks shown on the filter and the filter case should be pointing up.

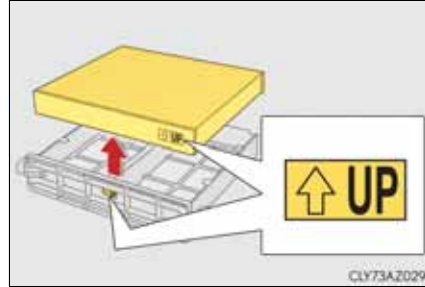

■ Checking interval

Inspect and replace the air conditioning filter according to the maintenance schedule. In dusty areas or areas with heavy traffic flow, early replacement may be required. (For scheduled maintenance information, please refer to the “Lexus Service Booklet” or “Lexus Warranty Booklet”.)

■ If air flow from the vents decreases dramatically

The filter may be clogged. Check the filter and replace if necessary.

⚠ NOTICE

■ When using the air conditioning system

Make sure that a filter is always installed.

Using the air conditioning system without a filter may cause damage to the system.

FarmaSOS.com

Electronic key battery

Replace the battery with a new one if it is depleted.

You will need the following items:

- Flathead screwdriver
- Small flathead screwdriver
- Lithium battery CR2032

Replacing the battery

- 1 Take out the mechanical key.



- 2 Remove the cover.
To prevent damage to the key, wrap the tip of the screwdriver with tape.

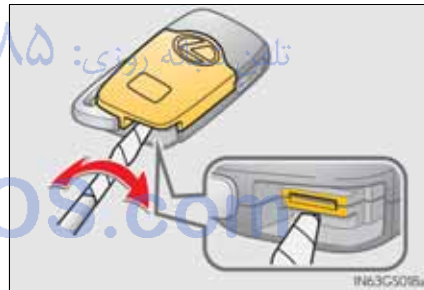

- 3 Remove the battery cover.
To prevent damage to the key, wrap the tip of the screwdriver with tape.



- 4 Remove the depleted battery.
Insert a new battery with the “+” terminal facing up.



- Use a CR2032 lithium battery
 - Batteries can be purchased at any authorized Lexus dealer or repairer, or another duly qualified and equipped professional, local electrical appliance shops or camera stores.
 - Replace only with the same or equivalent type recommended by the manufacturer.
 - Dispose of used batteries according to local laws.
- When the card key battery needs to be replaced (if equipped)
The battery for the card key is available only at Lexus dealers. Your Lexus dealer can replace the battery for you.
- If the electronic key battery is depleted
The following symptoms may occur:
 - The smart entry & start system and wireless remote control will not function properly.
 - The operational range will be reduced.
- Certification for the key battery
 - Replace only with the same or equivalent type recommended by the manufacturer.
 - Dispose of used batteries according to local laws.

 CAUTION

■ Removed battery and other parts

These parts are small and if swallowed by a child, they can cause choking. Keep away from children. Failure to do so could result in death or serious injury.

■ Lithium battery precautions

RISK OF EXPLOSION IF BATTERY IS REPLACED BY AN INCORRECT TYPE.
DISPOSE OF USED BATTERIES ACCORDING TO THE INSTRUCTIONS

 NOTICE

■ For normal operation after replacing the battery

Observe the following precautions to prevent accidents:

- Always work with dry hands.
Moisture may cause the battery to rust.
- Do not touch or move any other component inside the remote control.
- Do not bend either of the battery terminals.

تلفن شبانه روزی: ۰۲۱-۸۸۶۲۰۸۵

FarmaSOS.com

Checking and replacing fuses

If any of the electrical components do not operate, a fuse may have blown. If this happens, check and replace the fuses as necessary.

- 1 Turn the engine switch off.
- 2 Open the fuse box cover.
 - ▶ Engine compartment: type A fuse box (left-hand drive vehicles)
Push the tab in and lift the lid off.

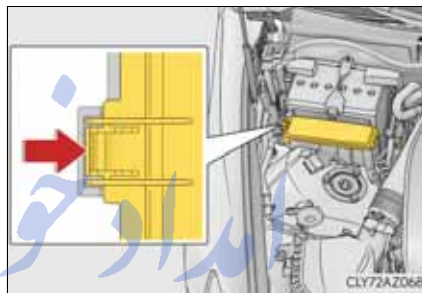

- ▶ Engine compartment: type A fuse box (right-hand drive vehicles)
Push the tab in and lift the lid off.

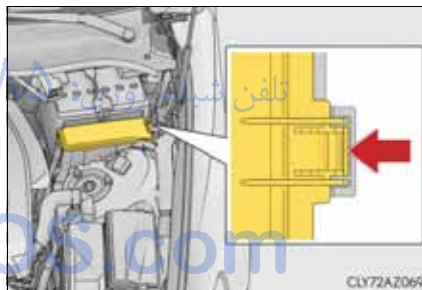

- ▶ Engine compartment: type B fuse box
Push the tab in and lift the lid off.

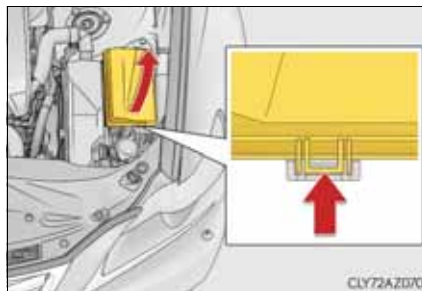

- ▶ Left side instrument panel (left-hand drive vehicles)

Remove the lid.

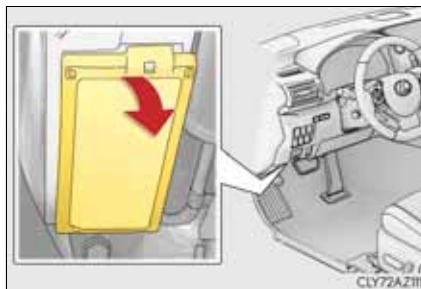

- ▶ Left side instrument panel (right-hand drive vehicles)

Remove the lid.

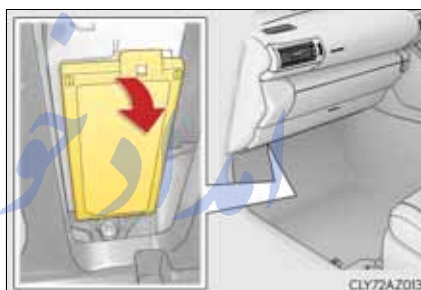

- 3 Remove the fuse with the pullout tool.

Only type A fuses can be removed using the pullout tool.

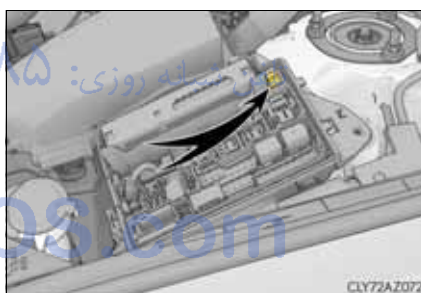

4 Check if the fuse is blown.

- ① Normal fuse
- ② Blown fuse

Type A and B:

Replace the blown fuse with a new fuse of an appropriate amperage rating. The amperage rating can be found on the fuse box lid.

Type C and D:

Contact any authorized Lexus dealer or repairer, or another duly qualified and equipped professional.

► Type A

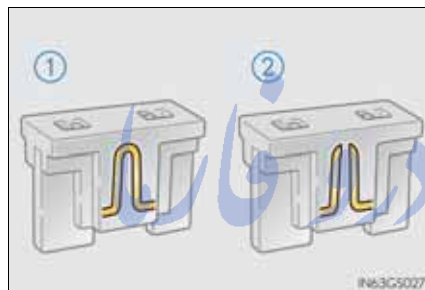

► Type B

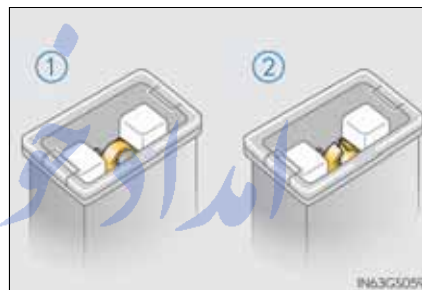

► Type C



► Type D



- After a fuse is replaced
 - If the lights do not turn on even after the fuse has been replaced, a bulb may need replacement. (→P. 448)
 - If the replaced fuse blows again, have the vehicle inspected by any authorized Lexus dealer or repairer, or another duly qualified and equipped professional.
- If there is an overload in a circuit

The fuses are designed to blow, protecting the wiring harness from damage.
- When replacing light bulbs

Lexus recommends that you use genuine Lexus products designed for this vehicle. Because certain bulbs are connected to circuits designed to prevent overload, non-genuine parts or parts not designed for this vehicle may be unusable.

 CAUTION

- To prevent system breakdowns and vehicle fire

Observe the following precautions.
Failure to do so may cause damage to the vehicle, and possibly a fire or injury.

 - Never use a fuse of a higher amperage rating than that indicated, or use any other object in place of a fuse.
 - Always use a genuine Lexus fuse or equivalent.
Never replace a fuse with a wire, even as a temporary fix.
 - Do not modify the fuses or fuse boxes.

 NOTICE

- Before replacing fuses

Have the cause of electrical overload determined and repaired by any authorized Lexus dealer or repairer, or another duly qualified and equipped professional as soon as possible.

Light bulbs

You may replace the following bulbs by yourself. The difficulty level of replacement varies depending on the bulb. As there is a danger that components may be damaged, we recommend that replacement is carried out by any authorized Lexus dealer or repairer, or another duly qualified and equipped professional.

Preparing for light bulb replacement

Check the wattage of the light bulb to be replaced.
(→P. 546)

Bulb locations

- Front
- ▶ Vehicles with discharge headlights



- ① Front turn signal light
- ② Halogen front fog light (if equipped)

► Vehicles with LED headlights



- ① Halogen front fog light (if equipped)
- ② Front turn signal light

■ Rear

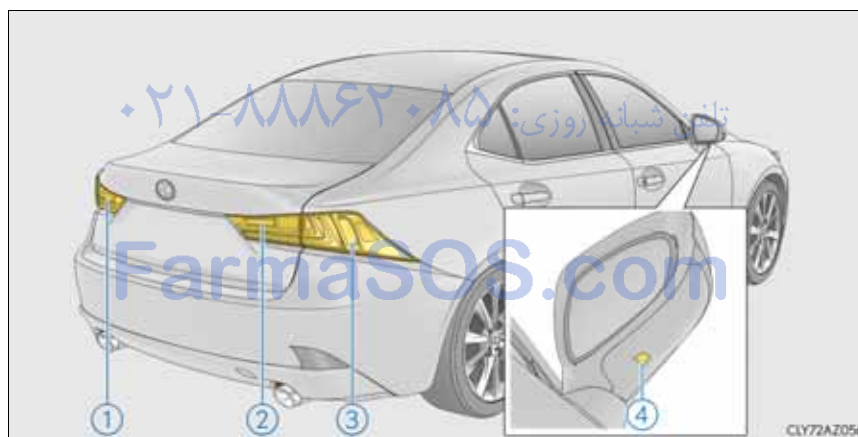

- ① Back-up light (right-hand drive vehicles)
- ② Back-up light (left-hand drive vehicles)
- ③ Rear turn signal light
- ④ Outer foot light

Replacing light bulbs

■ Halogen front fog lights (if equipped)

- 1 Remove the 2 fender liner screws under the front fog light and pull back the fender liner.

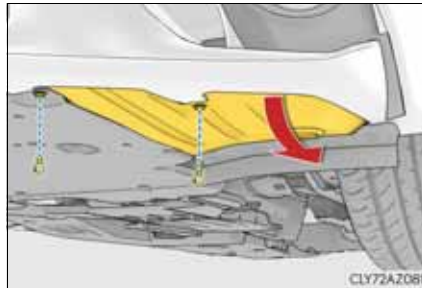

- 2 Unplug the connector while pressing the lock release.

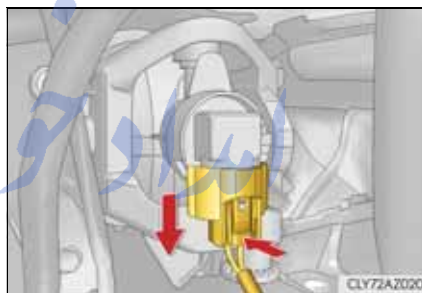

- 3 Turn the bulb base counter-clockwise.



- 4 Set the new light bulb.

- 1 Hold the bulb base at an angle of about 45 degrees as shown in the illustration and insert it so that the 3 tabs on the light bulb are aligned with the mounting.

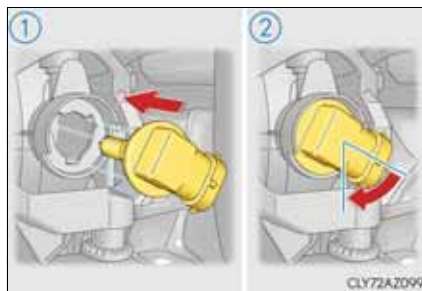

- 2 Turn the light bulb clockwise to install it.

5 Set the connector.

After installing the connector, shake the bulb base gently to check that it is not loose, turn the fog lights on once and visually confirm that no light is leaking through the mounting.

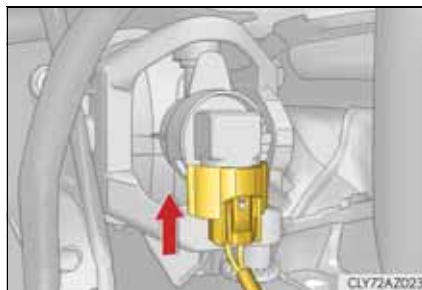
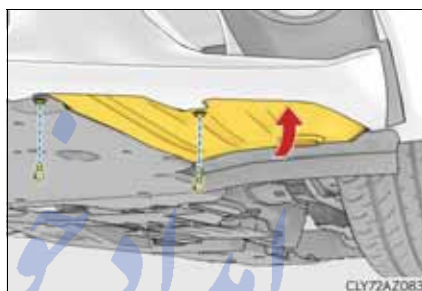
**6** Reinstall the fender liner with the 2 screws.

امداد خودرو فارما

تلفن شبانه روزی: ۰۲۱-۸۸۸۶۲۰۸۵

FarmaSOS.com

■ Front turn signal lights (vehicles with discharge headlights)

- 1** To ensure enough space to perform work, turn the steering wheel to rotate the front wheel away from the bulb to be replaced.

Remove the 2 fender liner clips.

Turn the steering wheel to the left when replacing the right side light bulb, and turn the steering wheel to the right when replacing the left side light bulb.

To take out the lower clip, turn the head of the clip to unlock it, then remove it by pulling.

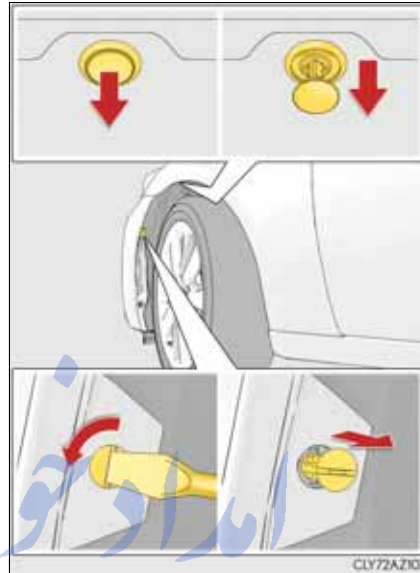

- 2** Unfasten the clamp, and pull back the fender liner.

When unfastening the clamp, wrap the tip of the screwdriver with tape to protect the vehicle from damage.

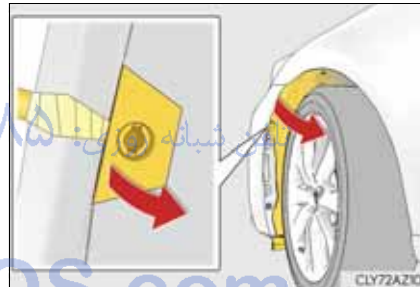

- 3** Turn the bulb base counter-clockwise.

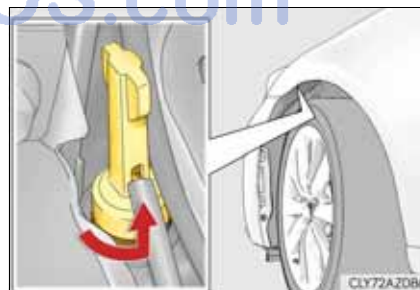

- 4** Remove the light bulb.



- 5** Install a new light bulb then install the bulb base to the light unit by inserting it and turning the bulb base clockwise.

After installing the light bulb, turn on the front turn signal light to visually check that there is no light leaking from the bulb base.

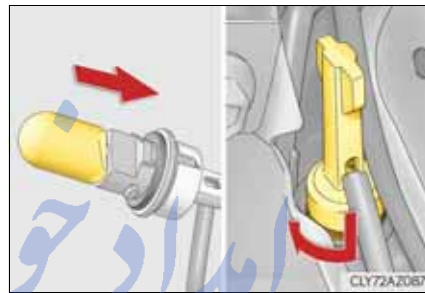

- 6** Reinstall the fender liner, fasten the clamp and install the 2 clips.

Install the lower clip by inserting it with the clip groove held vertically straight.



■ Front turn signal lights (vehicles with LED headlights)

- 1** For the left side only: Pinch the clip to remove the washer fluid filler opening.

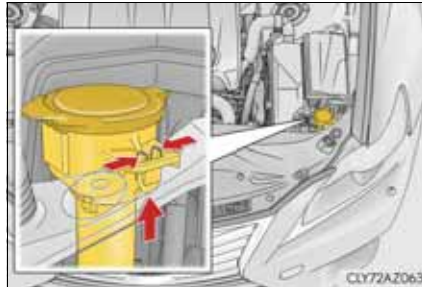

- 2** Turn the bulb base counter-clockwise.

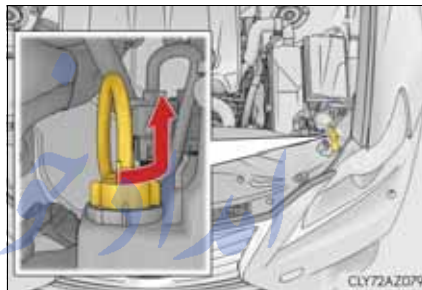

- 3** Remove the light bulb.



- 4** Install a new light bulb then install the bulb base to the light unit by inserting it and turning the bulb base clockwise.

After installing the light bulb, turn on the front turn signal light to visually check that there is no light leaking from the bulb base.

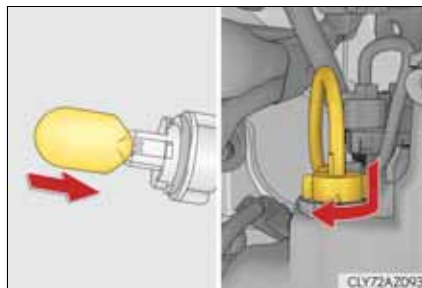

- 5** After replacing the left side bulb, install the washer fluid filler opening to its original position.

■ Rear turn signal lights

- 1** Open the trunk, and remove the 2 covers and 2 screws.

When removing the cover, wrap the tip of the screwdriver with tape to protect the vehicle from damage.

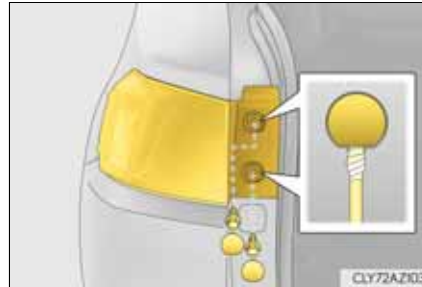

- 2** Push and pull the light unit toward the rear of the vehicle as shown in the illustration to remove it.

Apply protective tape to the peripheral of the light unit installation surface on the vehicle body, such as the rear bumper, to protect the vehicle from damage.

Pushing on the portion A in the illustration toward the rear of the vehicle will make disengagement of the tabs easier.

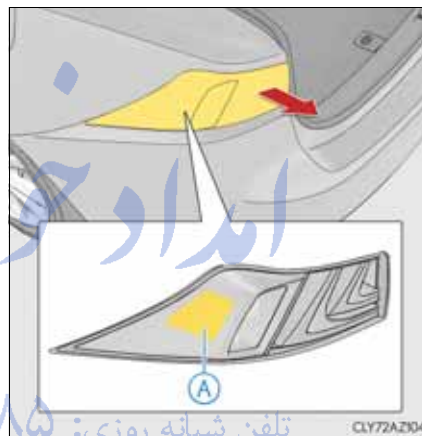

- 3** Turn the bulb base counter-clockwise.



- 4** Remove the light bulb.

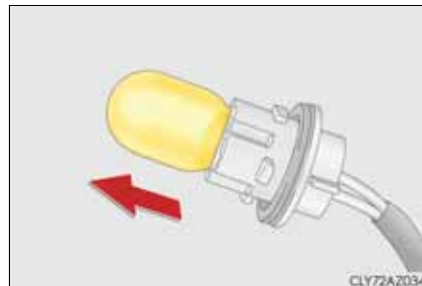

- 5** Install a new light bulb then install the bulb base to the light unit by inserting it and turning the bulb base clockwise.

After installing the light bulb, turn on the rear turn signal light to visually check that there is no light leaking from the bulb base.

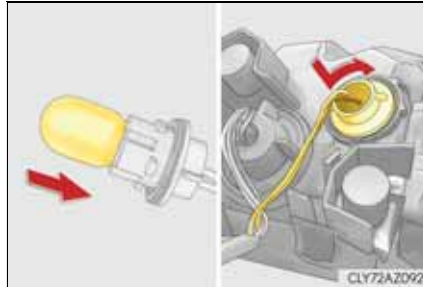

- 6** Align the tabs and push the light unit toward the front of the vehicle to install it.

Remove the protective tape applied to the peripheral of the light unit installation surface on the vehicle body.

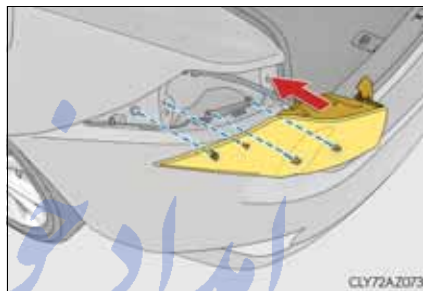

- 7** Install the 2 screws and 2 covers.

تلفن شبانه روزی: ۰۲۱-۸۸۸۶۲۰۸۵

FarmaSOS.com

■ Back-up light

- 1** Open the trunk, remove the 3 clips on the side which the bulb is to be replaced and pull back the trunk lid cover.

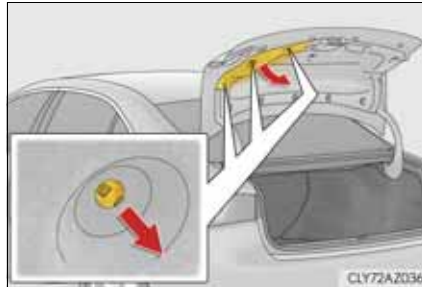

- 2** Turn the bulb base counter-clockwise.

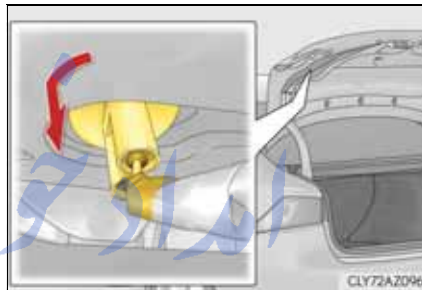

- 3** Remove the light bulb.

Pull out the connector carefully, ensuring that excessive pulling load is not applied to the wire harness.



- 4** Install a new light bulb then install the bulb base to the light unit by inserting it and turning the bulb base clockwise.

After installing the light bulb, turn on the back-up light to visually check that there is no light leaking from the bulb base.

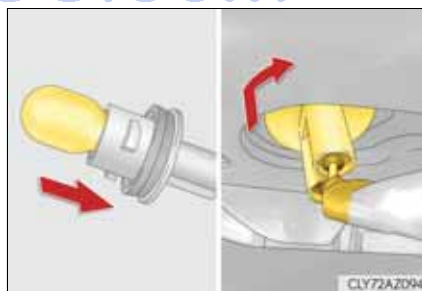

- 5** Reinstall the trunk lid cover with the 3 clips.

To install the clips, simply push them in.

■ Outer foot lights

- 1** Press the upper part of the outside rear view mirror to tilt the mirror face upward, and apply protective tape to the lower part of the mirror cover.

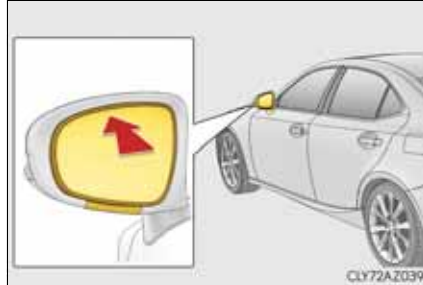

- 2** Insert 2 flathead screwdrivers wrapped in protective tape, and disconnect the tabs behind the mirror.

Pry the mirror out toward you, disconnecting the tabs 2 at a time. Work carefully, ensuring that you do not drop the mirror.

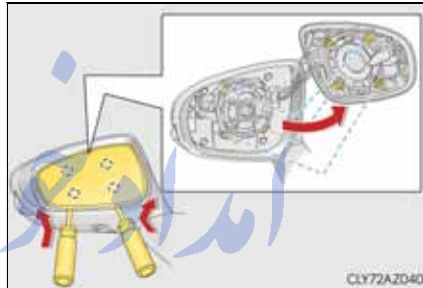

- 3** Disconnect the connectors behind the mirror, and remove the mirror.

When removing the thin connectors, make sure to mark one of the connectors with a piece of tape, to avoid mixing them up when reinstalling.

Work carefully, ensuring that you do not drop the mirror.

When handling the mirror, do not touch the parts applied with grease.

The number of connectors equipped differs by vehicle specification.

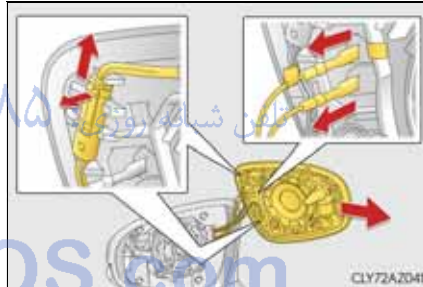

- 4 Remove the 5 screws and take off the mirror's outer cover and the cover behind the mirror.

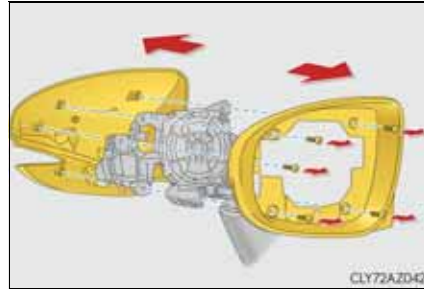

- 5 Turn the bulb base counter-clockwise.

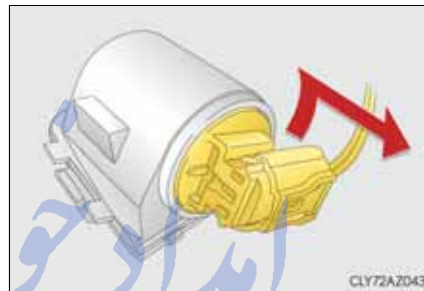

- 6 Remove the light bulb.

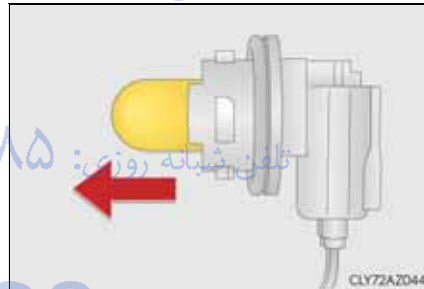

- 7 Install a new light bulb then install the bulb base to the light unit by inserting it and turning the bulb base clockwise.

When inserting the socket, align the marks printed on the light body and the socket.

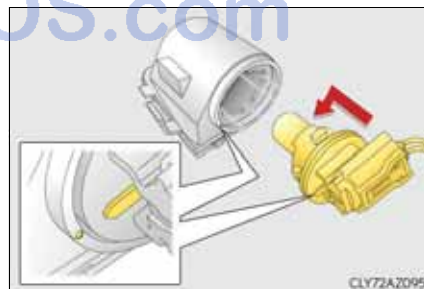

- 8 Install the visor cover on the mirror frame, secure it with a screw, and install the side turn signal light and outer foot light.

Use only the screw position shown in the illustration.

Align the tabs on the side turn signal light unit and the cover and install it.

Interlock the groove of the outer foot light unit with the tabs on the cover and secure it.

After installing the outer foot light unit, turn on the outer foot light to visually check that there is no light leaking from the bulb base.

- 9 Disconnect the tabs, and separate the top and bottom of the outer cover of the mirror.

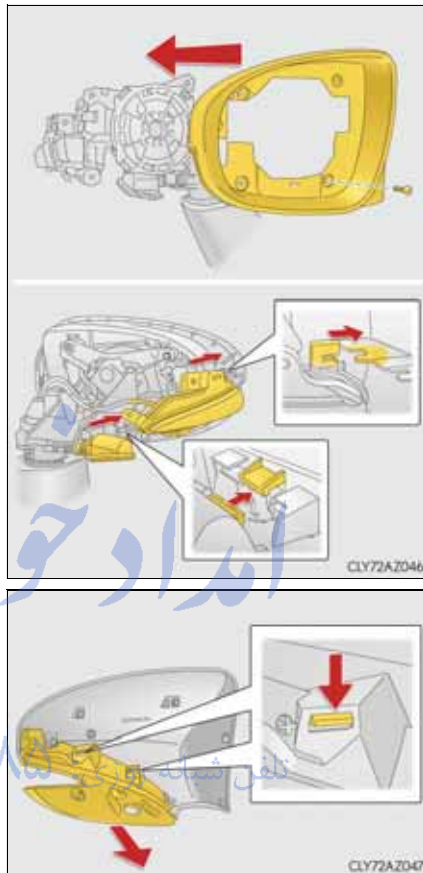

FarmaSOS.com

- 10** Install the outer cover of the mirror by installing the lower side first, then installing the upper side.

When installing the lower side of the cover, insert the side turn signal light pin into the hole in the cover.

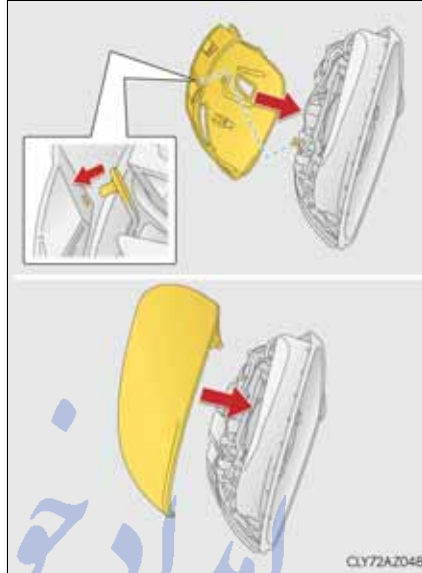

- 11** Secure the cover with screws and reconnect the connectors back together.

Secure the wire harness by reinstalling it to the hooks on the back side of the mirror surface as it was.



- 12** Align the tabs, and secure the mirror by pushing in each diagonally-opposite pair of tabs in order.

Make sure to insert the tabs in order as shown in the illustration, and push them in until a click is heard.

If you do not hear the click, do not force the tabs in. Instead, remove the mirror and check that the tabs are aligned.

After securing the mirror, remove the protective tape applied to the lower part of the mirror cover.

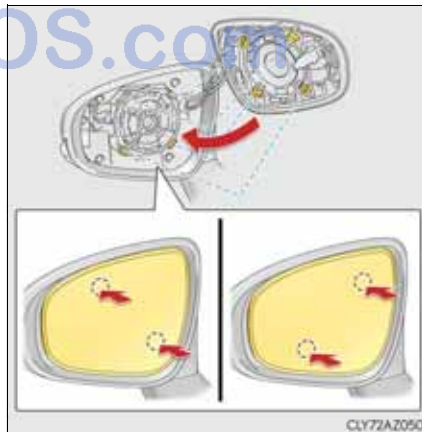

■ Replacing the following bulbs

If any of the lights listed below has burnt out, have it replaced by any authorized Lexus dealer or repairer, or another duly qualified and equipped professional.

- Headlights
- Front position lights and daytime running lights
- LED front fog lights (if equipped)
- Side turn signal lights
- Stop/tail lights
- Tail lights
- Rear fog light
- High mounted stoplight
- License plate lights

■ Discharge headlights (if equipped)

If voltage to the discharge bulbs is insufficient, the bulbs may not come on, or may go out temporarily. The discharge bulbs will come on when normal power is restored.

■ LED Lights

The lights other than the discharge headlights (if equipped), halogen front fog lights (if equipped), front turn signal lights, rear turn signal lights, back-up light and outer foot lights each consist of a number of LEDs. If any of the LEDs burn out, take your vehicle to any authorized Lexus dealer or repairer, or another duly qualified and equipped professional to have the light replaced.

■ Condensation build-up on the inside of the lens

Temporary condensation build-up on the inside of the headlight lens does not indicate a malfunction. Contact any authorized Lexus dealer or repairer, or another duly qualified and equipped professional for more information in the following situations:

- Large drops of water have built up on the inside of the lens.
- Water has built up inside the headlight.

■ When replacing the front turn signal lights (vehicles with LED headlights)

When the washer fluid filler opening is removed with a large amount of washer fluid contained in the washer tank, washer fluid may spill onto the vehicle and cleaning may be required.

■ When replacing light bulbs

→P. 447

 CAUTION

■ Replacing light bulbs

- Turn off the lights. Do not attempt to replace the bulb immediately after turning off the lights.
The bulbs become very hot and may cause burns.
- Do not touch the glass portion of the light bulb with bare hands. When it is unavoidable to hold the glass portion, use and hold with a clean dry cloth to avoid getting moisture and oils on the bulb.
Also, if the bulb is scratched or dropped, it may blow out or crack.
- Fully install light bulbs and any parts used to secure them. Failure to do so may result in heat damage, fire, or water entering the headlight unit. This may damage the headlights or cause condensation to build up on the lens.
- Vehicles with discharge headlights: While the headlights are turned on, and for a short time after they have been turned off, metal components at the rear of the headlight assembly will be extremely hot. To prevent burns, do not touch these metal components until you are certain they have cooled down.

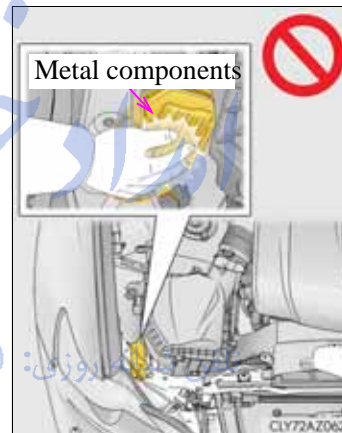

■ Discharge headlights (if equipped)

- Contact any authorized Lexus dealer or repairer, or another duly qualified and equipped professional before replacing the discharge headlights (including light bulbs).
 - Do not touch the discharge headlight's high voltage socket when the headlights are turned on.
An extremely high voltage of 30000 V will be discharged and could result in death or serious injury by electric shock.
 - Do not attempt to take apart or repair the headlight bulbs, connectors, power supply circuits, or related components.
Doing so could result in electric shock and death or serious injury.
- To prevent damage or fire
- Make sure bulbs are fully seated and locked.
 - Check the wattage of the bulb before installing to prevent heat damage.



NOTICE

■ When replacing the outer foot lights

If the front window is stopping you from conducting the replace operation properly, open the window on the side you are working on to allow you enough space to work. Continuing the operation without giving yourself enough space to work could lead you to scratch the vehicle.

امداد خودرو فارما

تلفن شبانه روزی: ۰۲۱-۸۸۸۶۲۰۸۵

FarmaSOS.com

When trouble arises

8

8-1. Essential information	8-2. Steps to take in an emergency
Emergency flashers 466	If your vehicle needs to be towed..... 468
If your vehicle has to be stopped in an emergency 467	If you think something is wrong..... 473
	Fuel pump shut off system 474
	If a warning light turns on or a warning buzzer sounds 475
	If a warning message is displayed..... 481
	If you have a flat tire (vehicles with a spare tire) 495
	If you have a flat tire (vehicles without a spare tire) 506
	If the engine will not start. 520
	If the shift lever cannot be shifted from P 522
	If the electronic key does not operate properly..... 523
	If the vehicle battery is discharged..... 526
	If your vehicle overheats .. 530
	If the vehicle becomes stuck..... 533

Emergency flashers

The emergency flashers are used to warn other drivers when the vehicle has to be stopped in the road due to a breakdown, etc.

Press the switch.

All the turn signals will flash.
To turn them off, press the switch once again.

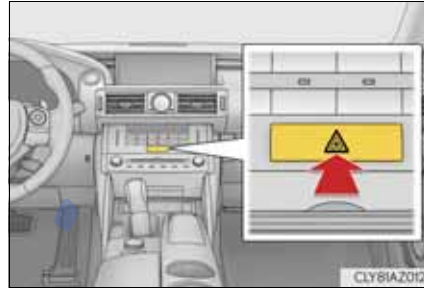

- Emergency flashers
If the emergency flashers are used for a long time while the engine is not operating, the battery may discharge.

تلفن شبانه روزی: ۰۲۱-۸۸۶۲۰۸۵

FarmaSOS.com

If your vehicle has to be stopped in an emergency

Only in an emergency, such as if it becomes impossible to stop the vehicle in the normal way, stop the vehicle using the following procedure:

- 1 Steadily step on the brake pedal with both feet and firmly depress it.
Do not pump the brake pedal repeatedly as this will increase the effort required to slow the vehicle.
- 2 Shift the shift lever to N.
 - ▶ If the shift lever is shifted to N
- 3 After slowing down, stop the vehicle in a safe place by the road.
- 4 Stop the engine.
 - ▶ If the shift lever cannot be shifted to N
- 3 Keep depressing the brake pedal with both feet to reduce vehicle speed as much as possible.
- 4 To stop the engine, press and hold the engine switch for 2 consecutive seconds or more, or press it briefly 3 times or more in succession.

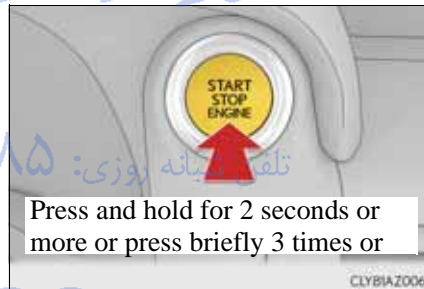

- 5 Stop the vehicle in a safe place by the road.

⚠ CAUTION

- If the engine has to be turned off while driving
Power assist for the brakes and steering wheel will be lost, making the brake pedal harder to depress and the steering wheel heavier to turn. Decelerate as much as possible before turning off the engine.

If your vehicle needs to be towed

If towing is necessary, we recommend having your vehicle towed by any authorized Lexus dealer or repairer, or another duly qualified and equipped professional or a commercial towing service, using a lift-type truck or flat bed truck.

Use a safety chain system for all towing, and abide by all state/provincial and local laws.

Before towing

The following may indicate a problem with your transmission. Contact any authorized Lexus dealer or repairer, or another duly qualified and equipped professional before towing.

- The engine is running but the vehicle will not move.
- The vehicle makes an abnormal sound.

Emergency towing

If a tow truck is not available in an emergency, your vehicle may be temporarily towed using a cable or chain secured to the emergency towing eyelet. This should only be attempted on hard surfaced roads for short distances at low speed.

A driver must be in the vehicle to steer and operate the brakes. The vehicle's wheels, drive train, axles, steering and brakes must be in good condition.



Installing towing eyelet

1 Take out the towing eyelet. (→P. 497, 508)

2 Remove the eyelet cover using a flathead screwdriver.

To protect the bodywork, place a rag between the screwdriver and the vehicle body as shown in the illustration.

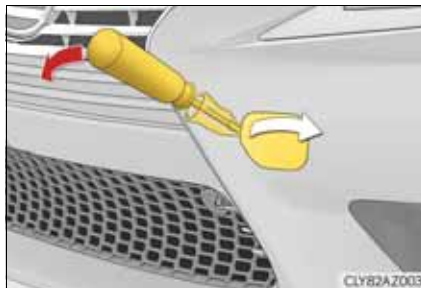

3 Insert the towing eyelet into the hole and tighten partially by hand.

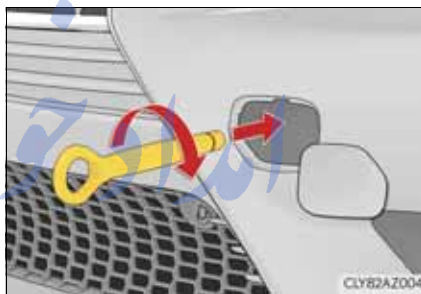

4 Tighten down the towing eyelet securely using a wheel nut wrench.



Towing with a sling-type truck

Do not tow with a sling-type truck to prevent body damage.

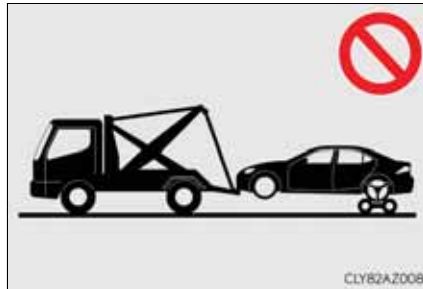

Towing with a wheel-lift type truck

► From the front



Use a towing dolly under the rear wheels.

► From the rear



Turn the engine switch to ACCESSORY mode so that the steering wheel is unlocked.

FarmaSOS.com

Using a flat bed truck

If your Lexus is transported by a flat bed truck, it should be tied down at the locations shown in the illustration.

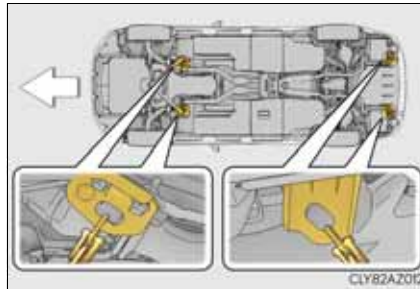

If you use chains or cables to tie down your vehicle, the angles shaded in black must be 45°.

Do not overly tighten the tie downs or the vehicle may be damaged.



■ Before emergency towing

- 1 Release the parking brake.
- 2 Shift the shift lever to N.
- 3 Turn the engine switch to ACCESSORY (engine off) or IGNITION ON (engine running) mode.

FarmaSOS.com

 CAUTION

Observe the following precautions.
Failure to do so may result in death or serious injury.

■ Caution while towing

- Use extreme caution when towing the vehicle.
Avoid sudden starts or erratic driving maneuvers which place excessive stress on the emergency towing eyelets and the cables or chains. Always be cautious of the surroundings and other vehicles while towing.
- If the engine is off, the power assist for the brakes and steering will not function, making steering and braking more difficult.

■ Installing towing eyelets to the vehicle

Make sure that towing eyelets are installed securely.
If not securely installed, towing eyelets may come loose during towing.

 NOTICE

- To prevent causing serious damage to the transmission when towing using a wheel-lift type truck
Never tow this vehicle from the front with the rear wheels on the ground.
- To prevent damage to the vehicle when towing using a wheel-lift type truck
 - Do not tow the vehicle from the rear with the engine switch off. The steering lock mechanism is not strong enough to hold the front wheels straight.
 - When raising the vehicle from the rear, ensure adequate ground clearance for towing at the opposite end of the raised vehicle. Without adequate clearance, the vehicle could be damaged while being towed from the rear.
- To prevent body damage when towing with a sling-type truck
Do not tow with a sling-type truck, either from the front or rear.
- To prevent damage to the vehicle
Do not use the rear tie down hooks when your vehicle is towed.

If you think something is wrong

If you notice any of the following symptoms, your vehicle probably needs adjustment or repair. Contact any authorized Lexus dealer or repairer, or another duly qualified and equipped professional as soon as possible.

Visible symptoms

- Fluid leaks under the vehicle.
(Water dripping from the air conditioning after use is normal.)
- Flat-looking tires or uneven tire wear
- Engine coolant temperature gauge needle continually points higher than normal.

Audible symptoms

- Changes in exhaust sound
- Excessive tire squeal when cornering
- Strange noises related to the suspension system
- Pinging or other noises related to the engine

Operational symptoms

- Engine missing, stumbling or running roughly
- Appreciable loss of power
- Vehicle pulls heavily to one side when braking
- Vehicle pulls heavily to one side when driving on a level road
- Loss of brake effectiveness, spongy feeling, pedal almost touches the floor

Fuel pump shut off system

To minimize the risk of fuel leakage when the engine stalls or when an airbag inflates upon collision, the fuel pump shut off system stops the supply of fuel to the engine.

Follow the procedure below to restart the engine after the system is activated.

- 1 Turn the engine switch to ACCESSORY mode or turn it off.
- 2 Restart the engine.

NOTICE

- Before starting the engine
Inspect the ground under the vehicle.
If you find that fuel has leaked onto the ground, the fuel system has been damaged and is in need of repair. Do not restart the engine.





تلفن شبانه روزی: ۰۲۱-۸۸۶۲۰۸۵





FarmaSOS.com







If a warning light turns on or a warning buzzer sounds

Calmly perform the following actions if any of the warning lights comes on or flashes. If a light comes on or flashes, but then goes off, this does not necessarily indicate a malfunction in the system. However, if this continues to occur, have the vehicle inspected by any authorized Lexus dealer or repairer, or another duly qualified and equipped professional.

Warning light and warning buzzer list

Warning light	Warning light/Details/Actions
	<p>Brake system warning light (warning buzzer)*¹</p> <p>Indicates that:</p> <ul style="list-style-type: none"> • The brake fluid level is low; or • The brake system is malfunctioning <p>→ Immediately stop the vehicle in a safe place and contact any authorized Lexus dealer or repairer, or another duly qualified and equipped professional. Continuing to drive the vehicle may be dangerous.</p>
	<p>Charging system warning light</p> <p>Indicates a malfunction in the vehicle's charging system</p> <p>→ Immediately stop the vehicle in a safe place and contact any authorized Lexus dealer or repairer, or another duly qualified and equipped professional.</p>
	<p>Malfunction indicator lamp</p> <p>Indicates a malfunction in:</p> <ul style="list-style-type: none"> • The electronic engine control system; • The electronic throttle control system; or • The electronic automatic transmission control system <p>→ Have the vehicle inspected by any authorized Lexus dealer or repairer, or another duly qualified and equipped professional immediately.</p>
	<p>SRS warning light</p> <p>Indicates a malfunction in:</p> <ul style="list-style-type: none"> • The SRS airbag system; or • The seat belt pretensioner system <p>→ Have the vehicle inspected by any authorized Lexus dealer or repairer, or another duly qualified and equipped professional immediately.</p>

Warning light	Warning light/Details/Actions
	<p>ABS warning light Indicates a malfunction in:</p> <ul style="list-style-type: none"> • The ABS; or • The brake assist system <p>→ Have the vehicle inspected by any authorized Lexus dealer or repairer, or another duly qualified and equipped professional immediately.</p>
	<p>Electric power steering system warning light Indicates a malfunction in the EPS (Electric Power Steering) system</p> <p>→ Have the vehicle inspected by any authorized Lexus dealer or repairer, or another duly qualified and equipped professional immediately.</p>
 <p>(Flashes) (If equipped)</p>	<p>Pre-crash safety system warning light Indicates a malfunction in the PCS (Pre-Crash Safety system)</p> <p>The warning light will operate as follows, even when the system is not malfunctioning:</p> <ul style="list-style-type: none"> • The light will flash quickly when the system is operating. (→P. 276) • The light will turn on when the pre-crash safety system is disabled. (→P. 277) • The light will turn on when the VSC (Vehicle Stability Control) system is disabled. (→P. 272) • The light will flash when the system cannot temporarily be used. (→P. 489) <p>→ Have the vehicle inspected by any authorized Lexus dealer or repairer, or another duly qualified and equipped professional immediately.</p>
	<p>Slip indicator Indicates a malfunction in:</p> <ul style="list-style-type: none"> • The VSC (Vehicle Stability Control) system; • The TRC (Traction Control) system; or • The hill-start assist control system <p>The light will flash when the VSC or the TRC system is operating.</p> <p>→ Have the vehicle inspected by any authorized Lexus dealer or repairer, or another duly qualified and equipped professional immediately.</p>
	<p>Automatic headlight leveling system warning light Indicates a malfunction in the automatic headlight leveling system</p> <p>→ Have the vehicle inspected by any authorized Lexus dealer or repairer, or another duly qualified and equipped professional immediately.</p>

Warning light	Warning light/Details/Actions
	Open door warning light (warning buzzer)* ² Indicates that a door or the trunk is not fully closed → Check that all the doors and the trunk are closed.
	Low fuel level warning light Indicates that remaining fuel is approximately 10 L (2.6 gal., 2.2 Imp. gal.) or less → Refuel the vehicle.
	Driver's and front passenger's seat belt reminder light (warning buzzer)* ³ Warns the driver and/or front passenger to fasten their seat belts → Fasten the seat belt. If the front passenger's seat is occupied, the front passenger's seat belt also needs to be fastened to make the warning light (warning buzzer) turn off.
	Rear passengers' seat belt reminder lights (warning buzzer)* ³ Warns the rear passengers to fasten their seat belts → Fasten the seat belt.
	Master warning light A buzzer sounds and the warning light comes on and flashes to indicate that the master warning system has detected a malfunction. → P. 481
 (If equipped)	Tire pressure warning light When the light comes on: Low tire inflation pressure such as <ul style="list-style-type: none"> • Natural causes (→P. 478) • Flat tire (→P. 496, 507) → Adjust the tire inflation pressure to the specified level. The light will turn off after a few minutes. In case the light does not turn off even if the tire inflation pressure is adjusted, have the system checked by any authorized Lexus dealer or repairer, or another duly qualified and equipped professional. When the light comes on after blinking for 1 minute: Malfunction in the tire pressure warning system → Have the system checked by any authorized Lexus dealer or repairer, or another duly qualified and equipped professional.

*¹: Parking brake engaged warning buzzer:

→P. 484

*²: Open door warning buzzer:

→P. 483

*3. Seat belt warning buzzer:

The seat belt warning buzzer sounds to alert the driver, front passenger and rear passengers that his or her seat belt is not fastened. The buzzer sounds for 30 seconds after the vehicle reaches a speed of 20 km/h (12 mph). Then, if the seat belt is still unfastened, the buzzer will sound in a different tone for 90 more seconds.

-
- Passenger detection sensor, seat belt reminder and warning buzzer
 - If luggage is placed on a passenger seat, the passenger detection sensor may cause the warning light to flash and the warning buzzer to sound even if a passenger is not sitting in the seat.
 - If a cushion is placed on the seat, the sensor may not detect a passenger, and the warning light may not operate properly.
 - If the malfunction indicator lamp comes on while driving

The malfunction indicator lamp will come on if the fuel tank becomes completely empty. If the fuel tank is empty, refuel the vehicle immediately. The malfunction indicator lamp will go off after several trips.

If the malfunction indicator lamp does not go off, contact any authorized Lexus dealer or repairer, or another duly qualified and equipped professional as soon as possible.
 - Electric power steering system warning light (warning buzzer)

When the battery charge becomes insufficient or the voltage temporarily drops, the electric power steering system warning light may come on and the warning buzzer may sound.
 - When the tire pressure warning light comes on (if equipped)

Carry out the following procedure after the tire temperature has lowered sufficiently.

 - Check the tire inflation pressure and adjust to the appropriate level.
 - If the warning light does not go out even after several minutes, check that the tire inflation pressure is at the specified level and carry out initialization.

The warning light may come on again if the above operations are conducted without first allowing the tire temperature to lower sufficiently.
 - The tire pressure warning light may come on due to natural causes (if equipped)

The tire pressure warning light may come on due to natural causes such as natural air leaks and tire inflation pressure changes caused by temperature. In this case, adjusting the tire inflation pressure will turn off the warning light (after a few minutes).
 - When a tire is replaced with the spare tire (if equipped)

The compact spare tire is not equipped with a tire pressure warning valve and transmitter. If a tire goes flat, the tire pressure warning light will not turn off even though the flat tire has been replaced with the spare tire.
 - Conditions that the tire pressure warning system may not function properly (if equipped)

→P. 429

- If the tire pressure warning light frequently comes on after blinking for 1 minute (if equipped)
If the tire pressure warning light frequently comes on after blinking for 1 minute when the engine switch is turned to IGNITION ON mode, have it checked by any authorized Lexus dealer or repairer, or another duly qualified and equipped professional.
- Warning buzzer
In some cases, the buzzer may not be heard due to being in a noisy location or audio sound.

 CAUTION

- If both the ABS and the brake system warning lights remain on
Stop your vehicle in a safe place immediately and contact any authorized Lexus dealer or repairer, or another duly qualified and equipped professional. The vehicle will become extremely unstable during braking, and the ABS system may fail, which could cause an accident resulting in death or serious injury.
- When the electric power steering system warning light comes on
The steering wheel may become extremely heavy.
If the steering wheel becomes heavier than usual when operating, hold firmly and operate using more force than usual.
- If the tire pressure warning light comes on (if equipped)
Be sure to observe the following precautions. Failure to do so could cause a loss of vehicle control and result in death or serious injury.
 - ▶ Vehicles with a compact spare tire
 - Stop your vehicle in a safe place as soon as possible. Adjust the tire inflation pressure immediately.
 - If the tire pressure warning light comes on even after tire inflation pressure adjustment, it is probable that you have a flat tire. Check the tires. If a tire is flat, change it with the spare tire and have the flat tire repaired by the nearest authorized Lexus dealer or repairer, or another duly qualified and equipped professional.
 - Avoid abrupt maneuvering and braking. If the vehicle tires deteriorate, you could lose control of the steering wheel or the brakes.
 - ▶ Vehicles with an emergency tire puncture repair kit
 - Stop your vehicle in a safe place as soon as possible. Adjust the tire inflation pressure immediately.
 - If the tire pressure warning light comes on even after tire inflation pressure adjustment, it is probable that you have a flat tire. Check the tires. If a tire is flat, repair the flat tire by using emergency tire puncture repair kit.
 - Avoid abrupt maneuvering and braking. If the vehicle tires deteriorate, you could lose control of the steering wheel or the brakes.
- If a blowout or sudden air leakage should occur
The tire pressure warning system may not activate immediately.

 NOTICE

■ Precaution when installing a different tire

When differently constructed tires or tires of different makers, models or tread patterns are installed, the tire pressure warning system may not operate properly.

امداد خودرو فارما

تلفن شبانه روزی: ۰۲۱-۸۸۸۶۲۰۸۵

FarmaSOS.com

If a warning message is displayed

If a warning is shown on the multi-information display, stay calm and perform the following actions:

- ▶ Except F SPORT models
- ▶ F SPORT models (when the main meter is in the center position)



- ▶ F SPORT models (when the main meter is in the right-side position)











① Master warning light



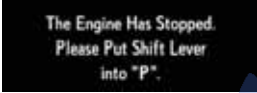







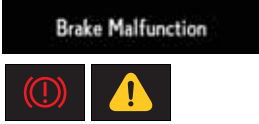

The master warning light also comes on or flashes in order to indicate that a message is currently being displayed on the multi-information display.





② Multi-information display

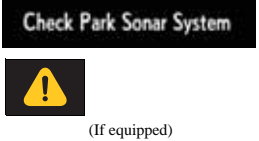











If any of the warning lights come on again after the following actions have been performed, contact any authorized Lexus dealer or repairer, or another duly qualified and equipped professional.







Warning message and warning buzzer list



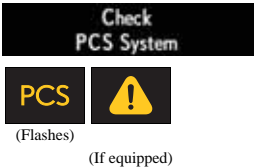





Warning message	Details/Actions
  (If equipped)	Indicates that: <ul style="list-style-type: none"> • There is a high possibility of a frontal collision; or • The pre-crash braking function is operating A buzzer also sounds. → Slow the vehicle by applying the brakes.
  (Flashes)	Indicates that the engine was stopped with the shift lever not in P A buzzer also sounds. → Shift the shift lever to P.
  (Flashes)	Indicates that the engine was stopped while driving A buzzer also sounds. → Stop the vehicle in a safe place such as the shoulder of a road.
 (If equipped)	Indicates that your vehicle is nearing the vehicle ahead (in vehicle-to-vehicle distance mode) A buzzer also sounds. → Slow the vehicle by applying the brakes.
 (If equipped)	Alerts the driver that the vehicle has deviated from the lane (while the LDA [Lane Departure Alert] system is operating) The lane line on the side the vehicle has deviated from flashes in yellow. The warning buzzer sounds continuously. → Check around the vehicle and back to inside of the lane lines.





Warning message	Details/Actions
 <p>Brake Malfunction</p> 	<p>Indicates that:</p> <ul style="list-style-type: none"> The brake fluid level is low; or The brake system is malfunctioning <p>A buzzer also sounds.</p> <p>→ Immediately stop the vehicle in a safe place and contact any authorized Lexus dealer or repairer, or another duly qualified and equipped professional. Continuing to drive the vehicle may be dangerous.</p>
 	<p>Indicates that one or more of the doors is not fully closed</p> <p>The system also indicates which doors are not fully closed.</p> <p>If the vehicle reaches a speed of 5 km/h (3 mph),  flashes and a buzzer sounds to indicate that the door(s) are not yet fully closed.</p> <p>→ Make sure that all the doors are closed.</p>
	<p>Indicates that the hood is not fully closed</p> <p>If the vehicle reaches a speed of 5 km/h (3 mph),  flashes and a buzzer sounds to indicate that the hood is not yet fully closed.</p> <p>→ Close the hood.</p>
 	<p>Indicates that the trunk is not fully closed</p> <p>If the vehicle reaches a speed of 5 km/h (3 mph),  flashes and a buzzer sounds to indicate that the trunk is not yet fully closed.</p> <p>→ Close the trunk.</p>
 <p>(If equipped)</p>	<p>Indicates a malfunction in the Lexus parking assist-sensor</p> <p>The assist-sensors flash.</p> <p>A buzzer also sounds.</p> <p>→ Have the vehicle inspected by any authorized Lexus dealer or repairer, or another duly qualified and equipped professional.</p>
 <p>(If equipped)</p>	<p>Indicates that a Lexus parking assist-sensor is dirty or covered with ice</p> <p>A buzzer also sounds.</p> <p>→ Clean the sensor.</p>



Warning message	Details/Actions
<p>EPS Failure. Steering Wheel Harder to Turn.</p> <p>Voltage Abnormality. Steering Wheel Harder to Turn.</p> <p>Check Power Steering System</p> 	<p>Indicates a malfunction in the EPS (Electric Power Steering) system A buzzer also sounds. → Have the vehicle inspected by any authorized Lexus dealer or repairer, or another duly qualified and equipped professional.</p>
<p>Release Parking Brake</p>  <p>(Flashes)</p>	<p>Indicates that the vehicle is being driven at 5 km/h (3 mph) or more with the parking brake still engaged A buzzer also sounds. → Release the parking brake.</p>
<p>1st Gear not available due to slippery road surface</p> 	<p>Indicates that the shift lever was used to attempt to shift to the first gear position in M mode on a slippery road surface The gear position will not shift from the second gear. A buzzer also sounds. → Drive the vehicle in the second or a higher gear position.</p>
<p>Check SRS Airbag System</p> 	<p>Indicates a malfunction in:</p> <ul style="list-style-type: none"> • The SRS airbag system; or • The seat belt pretensioner system <p>A buzzer also sounds. → Have the vehicle inspected by any authorized Lexus dealer or repairer, or another duly qualified and equipped professional.</p>
<p>Check ABS</p> 	<p>Indicates a malfunction in:</p> <ul style="list-style-type: none"> • The ABS; or • The brake assist system <p>A buzzer also sounds. → Have the vehicle inspected by any authorized Lexus dealer or repairer, or another duly qualified and equipped professional.</p>

Warning message	Details/Actions
 <p>Engine Coolant High Temperature</p> 	<p>Indicates that the engine coolant temperature is too high A buzzer also sounds. → P. 531</p>
 <p>Clean Radar Sensor</p>  <p>(If equipped)</p>	<p>Indicates that the radar sensor is dirty or covered with ice A buzzer also sounds. → Clean the sensor.</p>
 <p>Cruise Control not available</p>  <p>(If equipped)</p>	<p>Indicates that the dynamic radar cruise control system is unable to judge vehicle-to-vehicle distance A buzzer also sounds. → Turn off snow mode. If the windshield wipers are on, turn them off or set them to a mode other than AUTO or high speed wiper operation.</p>
 <p>LDA not available</p>  <p>(If equipped)</p>	<p>Indicates that the LDA (Lane Departure Alert) system is suspended (The camera sensor temperature is higher than the operation temperature range) A buzzer also sounds. → Restart the LDA after driving for a while.</p>
 <p>BSM not available</p>  <p>(If equipped)</p>	<p>Indicates that a Blind Spot Monitor sensor or the surrounding area on the bumper is dirty or covered with ice A buzzer also sounds. → Clean the sensor and its surrounding area on the bumper.</p>
 <p>Check Cruise Control System</p>  <p>(If equipped)</p>	<p>Indicates a malfunction in:</p> <ul style="list-style-type: none"> • The cruise control system; or • The dynamic radar cruise control system <p>Press the “ON/OFF” button once to deactivate the system, and then press the button again to reactivate the system. A buzzer also sounds. → Have the vehicle inspected by any authorized Lexus dealer or repairer, or another duly qualified and equipped professional.</p>

Warning message	Details/Actions
 <p>Check LDA System</p> <p>(If equipped)</p>	<p>Indicates a malfunction in the LDA (Lane Departure Alert) system A buzzer also sounds. → Have the vehicle inspected by any authorized Lexus dealer or repairer, or another duly qualified and equipped professional.</p>
 <p>Check PCS System</p> <p>(Flashes) (If equipped)</p>	<p>Indicates a malfunction in the PCS (Pre-Crash Safety system) A buzzer also sounds. → Have the vehicle inspected by any authorized Lexus dealer or repairer, or another duly qualified and equipped professional.</p>
 <p>Check BSM System</p> <p>(If equipped)</p>	<p>Indicates a malfunction in the BSM (Blind Spot Monitor) system A buzzer also sounds. → Have the vehicle inspected by any authorized Lexus dealer or repairer, or another duly qualified and equipped professional.</p>
 <p>Engine Oil Pressure Low</p>	<p>Indicates abnormal engine oil pressure A buzzer also sounds. → Immediately stop the vehicle in a safe place and contact any authorized Lexus dealer or repairer, or another duly qualified and equipped professional.</p>
 <p>Transmission Fluid High Temperature</p>	<p>Indicates that the automatic transmission fluid temperature is too high A buzzer also sounds. → Immediately stop the vehicle in a safe place and contact any authorized Lexus dealer or repairer, or another duly qualified and equipped professional.</p>
 <p>POP UP HOOD Activated.</p>	<p>Indicates that the Pop Up Hood system has operated A buzzer also sounds. → Have the vehicle inspected by any authorized Lexus dealer or repairer, or another duly qualified and equipped professional.</p>
 <p>POP UP HOOD Failure.</p>	<p>Indicates a malfunction in the Pop Up Hood system A buzzer also sounds. → Have the vehicle inspected by any authorized Lexus dealer or repairer, or another duly qualified and equipped professional.</p>

Warning message	Details/Actions
<p>Engine Stopped, Steering Wheel Harder to Turn.</p>  	<p>Indicates that the engine was stopped while driving A buzzer also sounds. → Operate the steering wheel with more force than usual.</p>
<p>Turn Light Off</p>  <p>(Flashes)</p>	<p>Indicates that the engine switch is turned off or turned to ACCESSORY mode and the driver's door is opened while the lights are turned on A buzzer also sounds. → Turn the lights off.</p>
<p>Moon Roof opened</p>  <p>(Flashes) (If equipped)</p>	<p>Indicates that the moon roof is not fully closed (with the engine switch off, and the driver's door open) A buzzer also sounds. → Close the moon roof.</p>
<p>Window opened</p>  <p>(Flashes)</p>	<p>Indicates that the windows are not fully closed (with the engine switch off, and the driver's door open) A buzzer also sounds. → Close all the windows.</p>
<p>Window / Moon Roof opened</p>  <p>(Flashes) (If equipped)</p>	<p>Indicates that the windows and the moon roof are not fully closed (with the engine switch off, and the driver's door open) A buzzer also sounds. → Close all the windows and the moon roof.</p>
<p>Brake Override System Failure.</p> 	<p>Indicates a malfunction in the brake override system A buzzer also sounds. → Have the vehicle inspected by any authorized Lexus dealer or repairer, or another duly qualified and equipped professional.</p>
<p>Engine Oil Level Low</p> 	<p>Indicates that engine oil level is low A buzzer also sounds. → Check the level of engine oil, and add if necessary.</p>

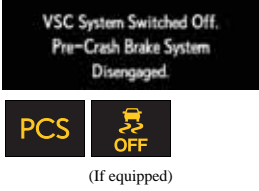
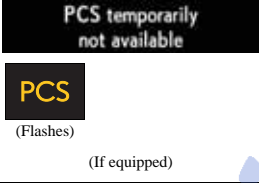
Warning message	Details/Actions
<p>Check Headlight System</p> 	<p>Indicates a malfunction in:</p> <ul style="list-style-type: none"> • The automatic headlight leveling system; or • The Automatic High Beam system (if equipped) • The LED headlight system (if equipped) <p>A buzzer also sounds. → Have the vehicle inspected by any authorized Lexus dealer or repairer, or another duly qualified and equipped professional.</p>
<p>Both Accelerator and Brake Pedals Are Depressed.</p>  <p>(Flashes)</p>	<p>Indicates that the accelerator and brake pedal are being depressed simultaneously → Release the accelerator or brake pedal.</p>
<p>Washer Fluid Low</p>	<p>Indicates that the washer fluid level is low → Add washer fluid.</p>
<p>Fuel Low</p> 	<p>Indicates that remaining fuel is approximately 10 L (2.6 gal., 2.2 Imp. gal.) or less → Refuel the vehicle.</p>
<p>TRC OFF</p>	<p>Indicates that the TRC (Traction Control) system has been deactivated → Turn the TRC on. (→P. 272)</p>
<p>Injector Maintenance required soon</p>  <p>(If equipped)</p>	<p>Indicates that the fuel injectors require maintenance soon → Have any authorized Lexus dealer or repairer, or another duly qualified and equipped professional add injector cleaner to the fuel tank and reset the message as necessary.</p>
<p>Injector Maintenance required</p>  <p>(If equipped)</p>	<p>Indicates that the fuel injectors require maintenance → Have any authorized Lexus dealer or repairer, or another duly qualified and equipped professional add injector cleaner to the fuel tank and reset the message.</p>
<p>Turn on the high beam to activate AHB System</p> <p>(If equipped)</p>	<p>Indicates that the Automatic High Beam switch is pressed while the headlights are in low beam. → Turn the high beam on and press the Automatic High Beam switch again.</p>

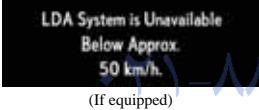
Warning message	Details/Actions
 <p>VSC System Switched Off. Pre-Crash Brake System Disengaged.</p> <p>PCS OFF (If equipped)</p>	<p>Indicates that, since the VSC (Vehicle Stability Control) system was turned off, the pre-crash brake system operation is stopped → Turn the VSC on. (→P. 272)</p>
 <p>PCS temporarily not available</p> <p>PCS (Flashes) (If equipped)</p>	<p>Indicates that the PCS (Pre-Crash Safety system) is not currently functional because the grille cover or the sensor is dirty → Check the grille cover and the sensor and clean them if they are dirty.</p>
 <p>Operation of Electrical Items Restricted.</p>	<p>Indicates that operation of large electricity consuming systems such as the air conditioning system are suspended → Stop using unnecessary electric components to reduce electricity consumption. Wait a while until the electric power supply is restored.</p>
 <p>LDA System is Unavailable Below Approx. 50 km/h. (If equipped)</p>	<p>Indicates that the LDA (Lane Departure Alert) system cannot be used because the vehicle speed is lower than approximately 50 km/h (32 mph) → Drive the vehicle at 50 km/h (32 mph) or higher.</p>

■ Warning messages

The warning message illustrations used are intended as examples, and may differ from the image that is actually displayed on the multi-information display.

■ Warning message in radar cruise mode (if equipped)

In the following situations, the warning message may not be displayed even if vehicle-to-vehicle distance decreases:

- When your vehicle and the vehicle ahead are traveling at the same speed or the vehicle ahead is traveling more quickly than your vehicle
- When the vehicle ahead is traveling at a very low speed
- Immediately after cruise control speed is set
- At the instant the accelerator pedal is depressed

■ The LDA (Lane Departure Alert) lane departure warning function (if equipped)

In the following situations, the warning message will not be displayed even if a lane line is crossed.









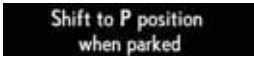

- When the vehicle speed deviates from the operating range of the LDA system functions
- When the lane lines cannot be recognized

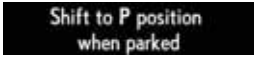









- Conditions that the tire pressure warning system may not function properly (if equipped)
→P. 429
- Warning buzzer
→P. 479







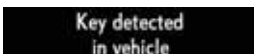

امداد خودرو فارما



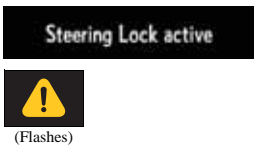

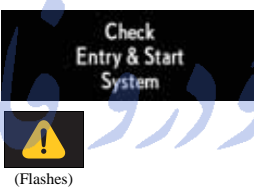

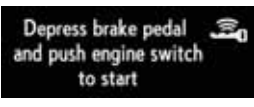
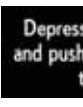

تلفن شبانه روزی: ۰۲۱-۸۸۸۶۲۰۸۵

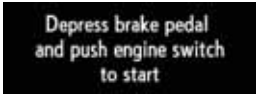
FarmaSOS.com

Interior buzzer	Exterior buzzer	Warning message	Details/Actions
Continuous	—	  (Flashes)	The driver's door was opened when the shift lever was not in P and the engine switch was not turned off. → Shift the shift lever to P.
Continuous	Continuous	  (Displayed alternately)  (Flashes)	The driver's door was opened and closed while the electronic key was not in the vehicle, the shift lever was not in P and the engine switch was not turned off. → Shift the shift lever to P. → Bring the electronic key back into the vehicle.
Once	—	  (Flashes)	The electronic key is not detected when an attempt is made to start the engine. → Start the engine with the electronic key present.
Once	Continuous	  (Displayed alternately)  (Flashes)	An attempt was made to exit the vehicle with the electronic key and lock the doors without first turning the engine switch off when the shift lever was in P. → Turn the engine switch off and lock the doors again.

Interior buzzer	Exterior buzzer	Warning message	Details/Actions
Once	3 times	  (Flashes)	<p>The electronic key was carried outside the vehicle and a door other than the driver's door was opened and closed while the engine switch was in a mode other than off.</p> <p>→ Bring the electronic key back into the vehicle.</p>
		  (Flashes)	<p>The driver's door was opened and closed while the electronic key was not in the vehicle, the shift lever was in P and the engine switch was not turned off.</p> <p>→ Turn the engine switch off.</p> <p>→ Bring the electronic key back into the vehicle.</p>
9 times	—	  (Flashes)	<p>An attempt was made to drive when the electronic key was not inside the vehicle.</p> <p>→ Confirm that the electronic key is inside the vehicle.</p>
—	Continuous	  (Flashes) (Vehicles with the entry function)	<p>An attempt was made to lock the doors using the smart entry & start system while the electronic key was still inside the vehicle.</p> <p>→ Retrieve the electronic key from the vehicle and lock the doors again.</p>
Once	Continuous	  (Flashes)	<p>An attempt was made to lock either front door by opening a door and putting the inside lock button into the lock position, then closing the door by pulling on the outside door handle with the electronic key still inside the vehicle.</p> <p>→ Retrieve the electronic key from the vehicle and lock the doors again.</p>

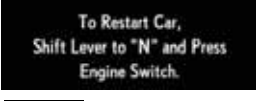
Interior buzzer	Exterior buzzer	Warning message	Details/Actions
Once	—	 <p>Key Battery Low</p> 	<p>The electronic key has a low battery.</p> <p>→ Replace the electronic key battery. (→P. 441)</p>
Once	—	 <p>Steering Lock active</p>  <p>(Flashes)</p>	<p>The steering lock could not be released within 3 seconds of the engine switch being pressed.</p> <p>→ Press the engine switch while depressing the brake pedal and moving the steering wheel left and right.</p>
Once	—	 <p>Check Entry & Start System</p>  <p>(Flashes)</p>	<p>Indicates a malfunction in the smart entry & start system</p> <p>→ Have the vehicle inspected by any authorized Lexus dealer or repairer, or another duly qualified and equipped professional.</p>
Once	—	 <p>Depress brake pedal, touch engine switch with key</p>  <p>(Flashes)</p>	<ul style="list-style-type: none"> • When the doors were unlocked with the mechanical key and then the engine switch was pressed, the electronic key could not be detected in the vehicle. • The electronic key could not be detected in the vehicle even after the engine switch was pressed two consecutive times. <p>→ Touch the electronic key to the engine switch while depressing the brake pedal.</p>
Once	—	 <p>Depress brake pedal and push engine switch to start</p> 	<p>During an engine starting procedure in the event that the electronic key was not functioning properly (→P. 525), the engine switch was touched with the electronic key.</p> <p>→ Press the engine switch within 10 seconds of the buzzer sounding.</p>

Interior buzzer	Exterior buzzer	Warning message	Details/Actions
—	—		<p>Indicates that:</p> <ul style="list-style-type: none"> • With the engine switch off, the doors were unlocked and then the driver's door was opened and closed • The engine switch was turned to ACCESSORY mode without starting the engine • The shift lever was shifted to P or N from another position with the engine switch in IGNITION ON mode. <p>→ Press the engine switch while depressing the brake pedal.</p>
Once	—	  (Flashes)	<p>The engine switch has been turned off with the shift lever in a position other than P or N.</p> <p>→ Shift the shift lever to P.</p>
Once	—	  (Flashes)	<p>After the engine switch has been turned off with the shift lever in a position other than P, the shift lever has been shifted to P.</p> <p>→ Turn the engine switch off.</p>
—	—		<p>Power was turned off due to the automatic power off function.</p> <p>→ Next time when starting the engine, increase the engine speed slightly and maintain that level for approximately 5 minutes to recharge the battery.</p>
Continuous	—	  (Flashes)	<p>Indicates that the engine was stopped in an emergency while driving</p> <p>→ To restart the engine, shift the shift lever to N and turn the engine switch to IGNITION ON mode.*</p>

Interior buzzer	Exterior buzzer	Warning message	Details/Actions
Once	—	 <p>Holding in Engine Switch Will Cause an Emergency Engine Stop. (Flashes)</p>	<p>Indicates that the engine switch has been pressed while driving → Except when emergency stopping of the vehicle is needed, immediately release the engine switch.</p>

*: The engine may not be restarted depending on the vehicle condition.

- Warning messages
→P. 489
- Warning buzzer
→P. 479

امداد خودرو فارما

تلفن شبانه روزی: ۰۲۱-۸۸۸۶۲۰۸۵

FarmaSOS.com

If you have a flat tire (vehicles with a spare tire)

Remove the flat tire and replace it with the spare tire provided.

For details about tires: →P. 425

CAUTION

■ If you have a flat tire

Do not continue driving with a flat tire.

Driving even a short distance with a flat tire can damage the tire and the wheel beyond repair, which could result in an accident.

Before jacking up the vehicle

- Stop the vehicle on a hard, flat surface.
- Set the parking brake.
- Shift the shift lever to P.
- Stop the engine.
- Turn on the emergency flashers. (→P. 466)

تلفن شبانه روزی: ۰۲۱-۸۸۸۶۲۰۸۵

FarmaSOS.com

Location of the spare tire, jack and tools

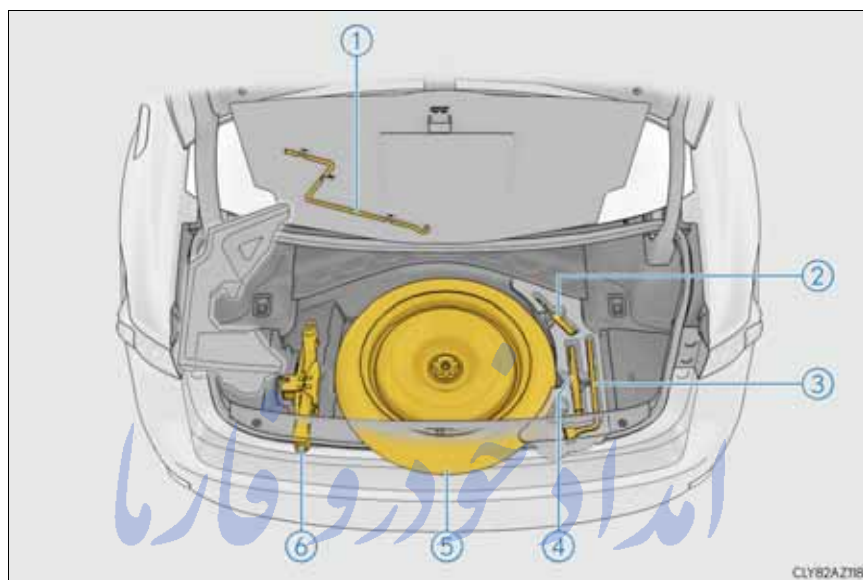

- | | |
|--------------------|-----------------|
| ① Jack handle | ④ Towing eyelet |
| ② Screwdriver | ⑤ Spare tire |
| ③ Wheel nut wrench | ⑥ Jack |

FarmaSOS.com

 CAUTION

■ Using the tire jack

Observe the following precautions.

Improper use of the tire jack may cause the vehicle to suddenly fall off the jack, leading to death or serious injury.

- Do not use the tire jack for any purpose other than replacing tires or installing and removing tire chains.
- Only use the tire jack that comes with this vehicle for replacing a flat tire. Do not use it on other vehicles, and do not use other tire jacks for replacing tires on this vehicle.
- Put the jack properly in its jack point.
- Do not put any part of your body under the vehicle while it is supported by the jack.
- Do not start the engine or drive the vehicle while the vehicle is supported by the jack.
- Do not raise the vehicle while someone is inside.
- When raising the vehicle, do not put an object on or under the jack.
- Do not raise the vehicle to a height greater than that required to replace the tire.
- Use a jack stand if it is necessary to get under the vehicle.
- When lowering the vehicle, make sure that there is no-one near the vehicle. If there are people nearby, warn them vocally before lowering.

تلفن شبانه روزی: ۰۲۱-۸۸۸۶۲۰۸۵

FarmaSOS.com

Taking out the jack and jack handle

- 1 Remove the luggage mat.
- 2 Take out the jack handle from the reverse side of the luggage mat. Remove the spacer.

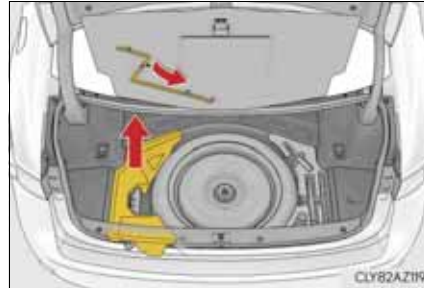

- 3 Take out the jack.
 - 1 For tightening
 - 2 For loosening

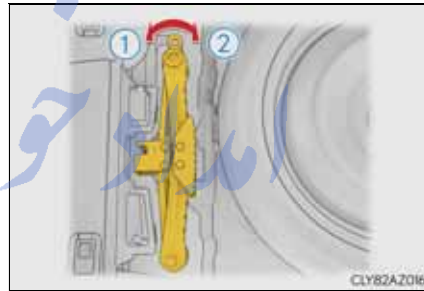

Taking out the spare tire

- 1 Remove the luggage mat.
- 2 Remove the spacer and tool tray.

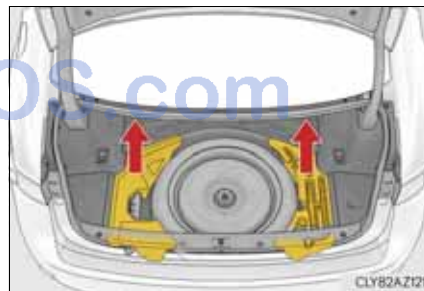

- 3** Loosen the center fastener that secures the spare tire.

If the center fastener cannot be turned by hand, use the wheel nut wrench that is stored in the trunk. (To secure the tire, tighten the center fastener by hand. Do not use the wrench or other tools.)

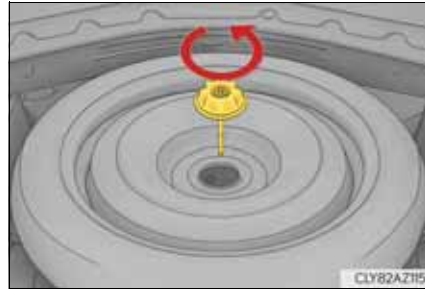

⚠ CAUTION

- When storing the spare tire
Be careful not to catch fingers or other body parts between the spare tire and the body of the vehicle.

Replacing a flat tire

- 1** Check the tires.



Flat tire		Wheel chock positions
Front	Left-hand side	Behind the rear right-hand side tire
	Right-hand side	Behind the rear left-hand side tire
Rear	Left-hand side	In front of the front right-hand side tire
	Right-hand side	In front of the front left-hand side tire

- 2** Slightly loosen the wheel nuts (one turn).

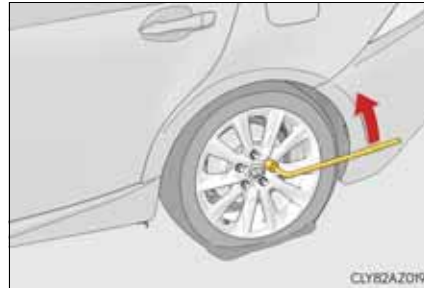

- 3** Turn the tire jack portion "A" by hand until the notch of the jack is in contact with the jack point.

The jack point guides are located under the rocker panel. They indicate the jack point positions.

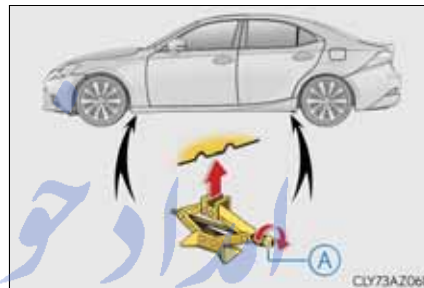

- 4** Raise the vehicle until the tire is slightly raised off the ground.

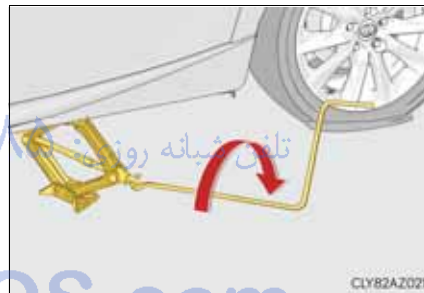

- 5** Remove all the wheel nuts and the tire.

When resting the tire on the ground, place the tire so that the wheel design faces up to avoid scratching the wheel surface.



 CAUTION

■ Replacing a flat tire

- Do not touch the disc wheels or the area around the brakes immediately after the vehicle has been driven.
After the vehicle has been driven the disc wheels and the area around the brakes will be extremely hot. Touching these areas with hands, feet or other body parts while changing a tire, etc. may result in burns.
- Failure to follow these precautions could cause the wheel nuts to loosen and the tire to fall off, resulting in death or serious injury.
 - Never use oil or grease on the wheel bolts or wheel nuts.
Oil and grease may cause the wheel nuts to be excessively tightened, leading to bolt or disc wheel damage. In addition, the oil or grease can cause the wheel nuts to loosen and the wheel may fall off, causing a serious accident. Remove any oil or grease from the wheel bolts or wheel nuts.
 - Have the wheel nuts tightened with a torque wrench to 103 N•m (10.5 kgf•m, 76 ft•lbf) as soon as possible after changing wheels.
 - Do not attach a heavily damaged wheel ornament, as it may fly off the wheel while the vehicle is moving.
 - When installing a tire, only use wheel nuts that have been specifically designed for that wheel.
 - If there are any cracks or deformations in the bolt screws, nut threads or bolt holes of the wheel, have the vehicle inspected by any authorized Lexus dealer or repairer, or another duly qualified and equipped professional.

تلفن شبانه روزی: ۰۲۱-۸۸۶۲۰۸۵

FarmaSOS.com

Installing the spare tire

- 1 Remove any dirt or foreign matter from the wheel contact surface.

If foreign matter is on the wheel contact surface, the wheel nuts may loosen while the vehicle is in motion, causing the tire to come off.

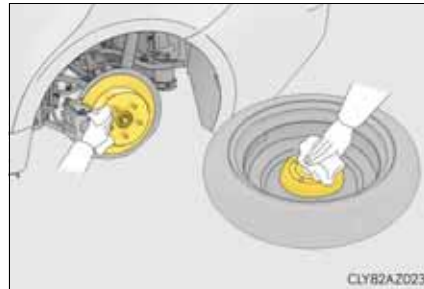

- 2 Install the tire and loosely tighten each wheel nut by hand by approximately the same amount.

When replacing an aluminum wheel with a steel wheel, tighten the wheel nuts until the tapered portion comes into loose contact with the disc wheel seat.

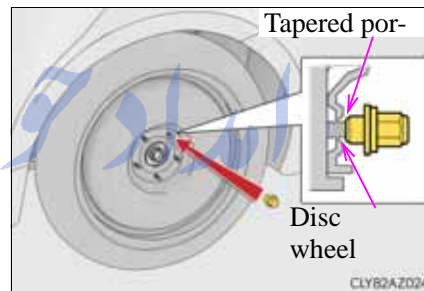

- 3 Lower the vehicle.

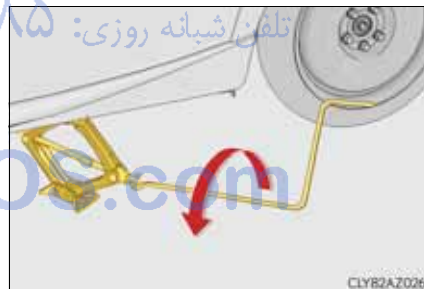

- 4 Firmly tighten each wheel nut two or three times in the order shown in the illustration.

Tightening torque:
103 N•m (10.5 kgf•m, 76 ft•lbf)

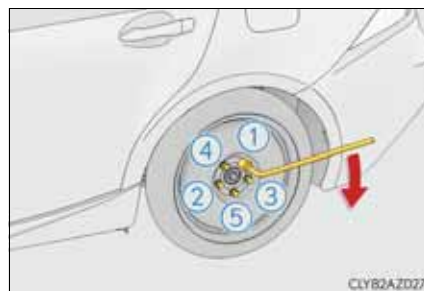

- 5 Stow the flat tire, tire jack and all tools.

- The compact spare tire
 - The compact spare tire is identified by the label “TEMPORARY USE ONLY” on the tire sidewall.
Use the compact spare tire temporarily, and only in an emergency.
 - Make sure to check the tire inflation pressure of the compact spare tire. (→P. 544)
- When using the compact spare tire (vehicles with the tire pressure warning system)

As the compact spare tire is not equipped with a tire pressure warning valve and transmitter, low inflation pressure of the spare tire will not be indicated by the tire pressure warning system. Also, if you replace the compact spare tire after the tire pressure warning light comes on, the light remains on.
- When the compact spare tire is equipped

The vehicle becomes lower when driving with the compact spare tire compared to when driving with standard tires.
- If you have a flat rear tire on a road covered with snow or ice (vehicles with front and rear tires of the same size and compact spare tire only)

Install the compact spare tire on one of the front wheels of the vehicle. Perform the following steps and fit tire chains to the rear tires:

 - 1 Replace a front tire with the compact spare tire.
 - 2 Replace the flat rear tire with the tire removed from the front of the vehicle.
 - 3 Fit tire chains to the rear tires.

تلفن شبانه روزی: ۰۲۱-۸۸۸۶۲۰۸۵

FarmaSOS.com

■ Certification for the jack



Manufacturer's Declaration of Conformity

Manufacturer:

Kawasaki Industrial Co., Ltd.
4618 Mukaijima Shimada, Shizuoka, Japan

The EU Directives covered by this Declaration

2006/42/EC Machinery Directive

The product covered by this declaration

JACK SUB-ASSY,PANTOGRAPH
model
0.8ton , 1.1ton , 1.35ton , 1.5ton

The basis on which conformity is being declared

The product identified above complies with the requirements of
the Machinery Directive
Directive above by meeting following standards

JIS D 8103

The technical documentation required to demonstrate that the product
meets the requirement the Machinery Directive has been compiled by
the signatory below and is available for inspection by the relevant
enforcement authorities.

A sample of the product has been tested by the manufacturer

Technical File No: KSF-201-00-01

The CE mark was first applied in:2010

Done at Shizuoka, Japan

Signature:

Koji Kawasaki
PRESIDENT ,Kawasaki Industrial Co., Ltd.

Date of Issue: 25 December,2009

 CAUTION

- When using the compact spare tire
 - Remember that the compact spare tire provided is specifically designed for use with your vehicle. Do not use your compact spare tire on another vehicle.
 - Do not use more than one compact spare tires simultaneously.
 - Replace the compact spare tire with a standard tire as soon as possible.
 - Avoid sudden acceleration, abrupt steering, sudden braking and shifting operations that cause sudden engine braking.
- When the compact spare tire is attached

The vehicle speed may not be correctly detected, and the following systems may not operate correctly:

• ABS & Brake assist	• LDA (Lane departure alert) (if equipped)
• VSC	• Rear view monitor system (if equipped)
• TRC	• Lexus parking assist monitor (if equipped)
• Cruise control (if equipped)	• Lexus parking assist-sensor (if equipped)
• Dynamic radar cruise control (if equipped)	• Navigation system (if equipped)
• PCS (if equipped)	
• EPS	
- Speed limit when using the compact spare tire

Do not drive at speeds in excess of 80 km/h (50 mph) when a compact spare tire is installed on the vehicle.

The compact spare tire is not designed for driving at high speeds. Failure to observe this precaution may lead to an accident causing death or serious injury.
- After using the tools and jack

Before driving, make sure all the tools and jack are securely in place in their storage location to reduce the possibility of personal injury during a collision or sudden braking.

 NOTICE

- Driving with tire chains and the compact spare tire

Do not fit tire chains to the compact spare tire.

Tire chains may damage the vehicle body and adversely affect driving performance.
- When replacing the tires (vehicles with the tire pressure warning system)

When removing or fitting the wheels, tires or the tire pressure warning valve and transmitter, contact any authorized Lexus dealer or repairer, or another duly qualified and equipped professional as the tire pressure warning valve and transmitter may be damaged if not handled correctly.

If you have a flat tire (vehicles without a spare tire)

Your vehicle is equipped with an emergency tire puncture repair kit. A puncture caused by a nail or screw passing through the tire tread can be repaired temporarily with the emergency tire puncture repair kit.

CAUTION

- If you have a flat tire
Do not continue driving with a flat tire.
Driving even a short distance with a flat tire can damage the tire and the wheel beyond repair, which could result in an accident.

Before repairing the vehicle

- Stop the vehicle in a safe place on a hard, flat surface.
- Set the parking brake.
- Shift the shift lever to P.
- Stop the engine.
- Turn on the emergency flashers. (→P. 466)

تلفن شبانه روزی: ۰۲۱-۸۸۸۶۲۰۸۵

FarmaSOS.com

Location of the emergency tire puncture repair kit, jack and tools

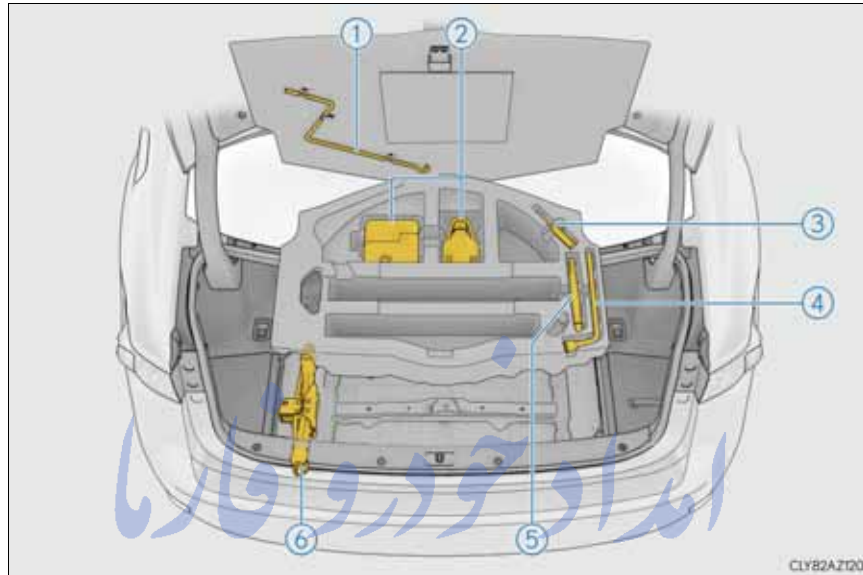

- ① Jack handle
- ② Emergency tire puncture repair kit
- ③ Screwdriver
- ④ Wheel nut wrench
- ⑤ Towing eyelet
- ⑥ Jack*

*: Use of the jack (→P. 500)

FarmaSOS.com

Emergency tire puncture repair kit components

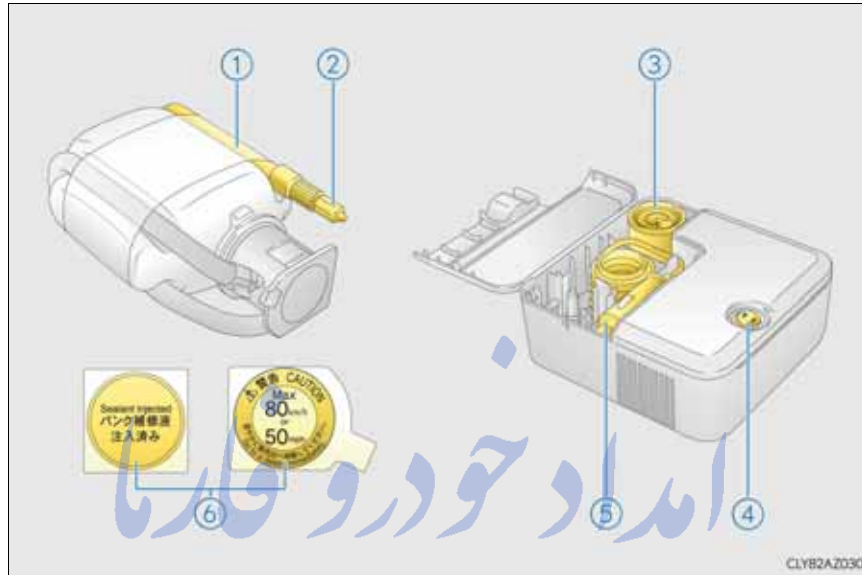

- | | |
|----------------------|---------------------|
| ① Hose | ④ Compressor switch |
| ② Air release cap | ⑤ Power plug |
| ③ Air pressure gauge | ⑥ Stickers |

Taking out the emergency tire puncture repair kit

- 1 Remove the luggage mat. (→P. 394)
- 2 Take out the emergency tire puncture repair kit.

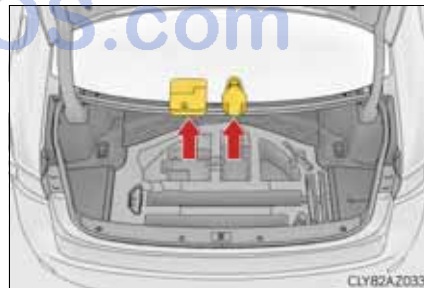

Before performing emergency repair

Check the degree of the tire damage.

A tire should only be repaired with the emergency tire puncture repair kit if the damage is caused by a nail or screw passing through the tire tread.

- Do not remove the nail or screw from the tire. Removing the object may widen the opening and disenable emergency repair with the kit.
- To avoid sealant leakage, move the vehicle until the area of the puncture, if known, is positioned at the top of the tire.



Emergency repair method

- 1 Take out the repair kit from the tool box.
- 2 Remove the valve cap from the valve of the punctured tire.



- 3 Remove the protective film from the bottle and extend the hose. Remove the air release cap from the hose.

Attach the sticker enclosed with the bottle on the specified locations. (See step 9.)

You will use the air release cap again. Therefore keep it in a safe place.

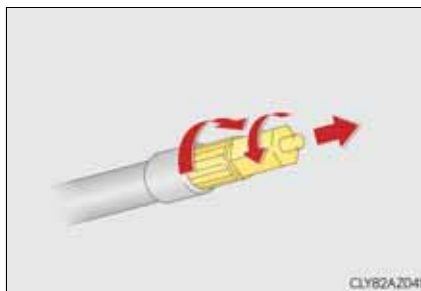

- 4 Connect the hose to the valve.
Screw the end of the hose clockwise as far as possible.



- 5 Make sure that the compressor switch is off.

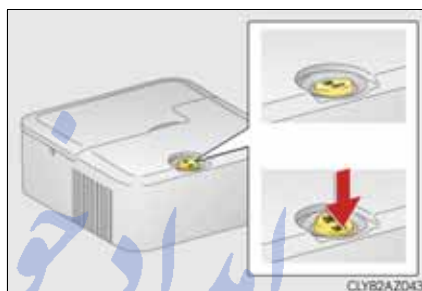

- 6 Remove the power plug from the compressor.

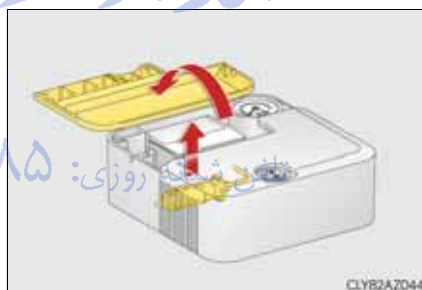

ادراد خودرو فارما

تلفن پشتیبانی روزی: ۰۲۱-۸۸۶۲۰۸۵

FarmaSOS.com

- 7 Connect the power plug to the power outlet socket. (→P. 397)

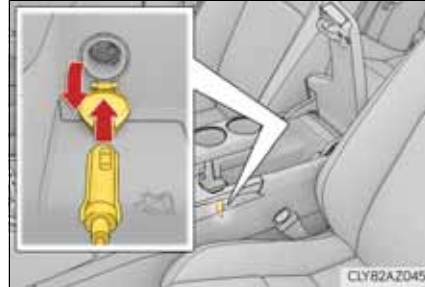

- 8 Remove the sticker.

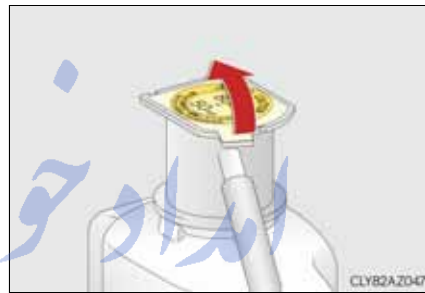

- 9 Attach the 2 stickers as shown.

Remove any dirt and moisture from the wheel before attaching the label. If it is impossible to attach the label, make sure to tell any authorized Lexus dealer or repairer, or another duly qualified and equipped professional when you have them repair and replace the tire that sealant is injected.



- 10** Connect the bottle to the compressor.

As shown in the illustration, insert the bottle vertically into the compressor to connect making sure that the claw on the bottle's neck is hooked onto the cutout of the compressor case.

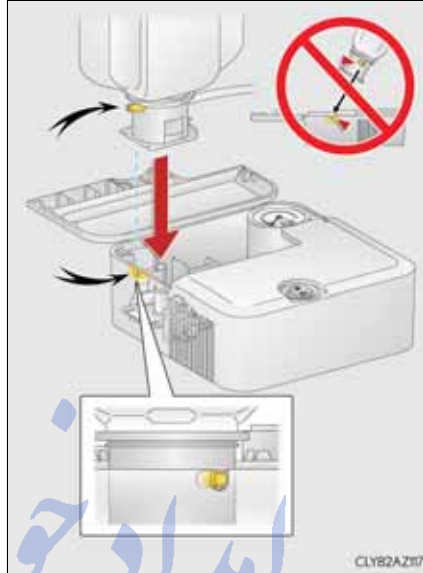

- 11** Check the specified tire inflation pressure.

Tire inflation pressure is specified on the label as shown. (→P. 544)

▶ Left-hand drive vehicles

▶ Right-hand drive vehicles

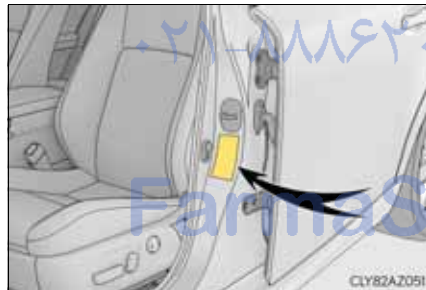

- 12 Start the engine.
- 13 To inject the sealant and inflate the tire, turn the compressor switch on.

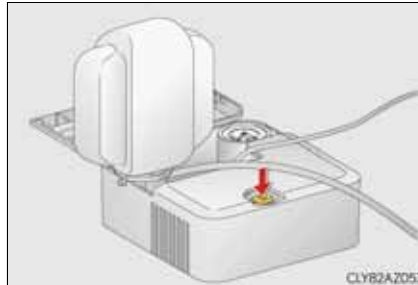

- 14 Inflate the tire until the specified air pressure is reached.
 - ① The sealant will be injected and the pressure will surge and then gradually decrease.
 - ② The air pressure gauge will display the actual tire inflation pressure about 1 minute (5 minutes at low temperature) after the switch is turned on.

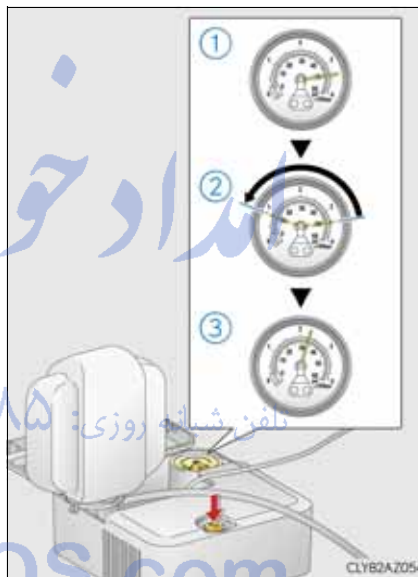

- ③ Inflate the tire until the specified air pressure.
 - Turn the compressor switch off and then check the tire inflation pressure. Being careful not to over inflate, check and repeat the inflation procedure until the specified tire inflation pressure is reached.
 - If the tire inflation pressure is still lower than the specified point after inflation for 35 minutes with the switch on, the tire is too damaged to be repaired. Turn the compressor switch off and contact any authorized Lexus dealer or repairer, or another duly qualified and equipped professional.
 - If the tire inflation pressure exceeds the specified air pressure, let out some air to adjust the tire inflation pressure. (→P. 518, 544)

- 15** With the compressor switch off, disconnect the hose from the valve on the tire and then pull out the power plug from the power outlet socket.

Some sealant may leak when the hose is removed.

- 16** Install the valve cap onto the valve of the emergency repaired tire.

- 17** Attach the air release cap to the end of the hose.

If the air release cap is not attached, the sealant may leak and the vehicle may get dirty.

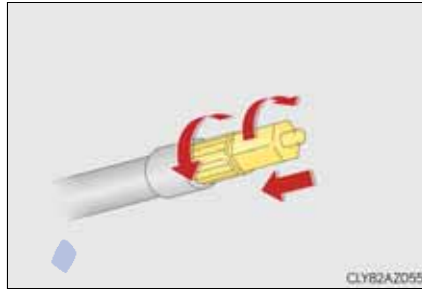

- 18** Temporarily store the bottle in the luggage compartment while it is connected to the compressor.

- 19** To spread the liquid sealant evenly within the tire, immediately drive safely for about 5 km (3 miles) below 80 km/h (50 mph).

- 20** After driving for about 5 km (3 miles), stop your vehicle in a safe place on a hard, flat surface and remove the air release cap from the hose before reconnecting the repair kit.

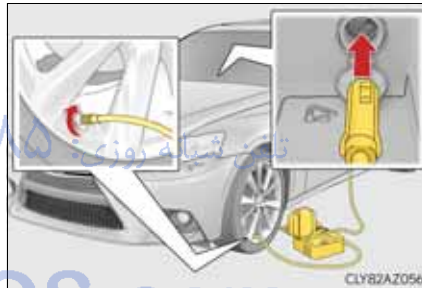

FarmaSOS.com

21 Turn the compressor switch on and wait for an approximately 5 seconds, and then turn it off. Check the tire inflation pressure.



① If the tire inflation pressure is under 130 kPa (1.3 kgf/cm² or bar, 19 psi): The puncture cannot be repaired. Contact any authorized Lexus dealer or repairer, or another duly qualified and equipped professional.

② If the tire inflation pressure is 130 kPa (1.3 kgf/cm² or bar, 19 psi) or higher, but less than the specified air pressure: Proceed to **22**.

③ If the tire inflation pressure is the specified air pressure (→P. 544): Proceed to **23**.

22 Turn the compressor switch on to inflate the tire until the specified air pressure is reached. Drive for about 5 km (3 miles) and then perform **20**.

23 Attach the air release cap to the end of the hose.

If the air release cap is not attached, the sealant may leak and the vehicle may get dirty.



24 Store the bottle in the luggage compartment while it is connected to the compressor.

25 Taking precautions to avoid sudden braking, sudden acceleration and sharp turns, drive carefully at under 80 km/h (50 mph) to the nearest authorized Lexus dealer or repairer, or another duly qualified and equipped professional for tire repair or replacement.

- In the following cases, the tire cannot be repaired with the emergency tire puncture repair kit. Contact any authorized Lexus dealer or repairer, or another duly qualified and equipped professional.
 - When the tire is damaged due to driving without sufficient air pressure
 - When the tire lost air pressure due to a crack or damage in the tire sidewall
 - When the tire is visibly separated from the wheel
 - When the cut or damage to the tread is 4 mm (0.16 in.) long or more
 - When the wheel is damaged
 - When two or more tires have been punctured
 - When there is more than one hole or cut in the damaged tire
- Emergency tire puncture repair kit
 - The sealant has a limited lifespan. The expiry date is marked on the bottle. The sealant should be replaced before the expiry date. Contact any authorized Lexus dealer or repairer, or another duly qualified and equipped professional for replacement.
 - The sealant stored in the emergency tire puncture repair kit can be used only once to temporarily repair a single tire. If the sealant in the bottle and other parts of the kit have been used and need to be purchased, contact any authorized Lexus dealer or repairer, or another duly qualified and equipped professional.
 - The sealant can be used when the outside temperature is from -30°C (-22°F) to 60°C (140°F).
 - The kit is exclusively designed for size and type of tires originally installed on your vehicle. Do not use it for tires that a different size than the original ones, or for any other purposes.
 - If the sealant gets on your clothes, it may stain.
 - If the sealant adheres to a wheel or the surface of the vehicle body, the stain may not be removable if it is not cleaned at once. Immediately wipe away the sealant with a wet cloth.
 - During operation of the kit, a loud operation noise is produced. This does not indicate a malfunction.
- The valve of a tire that has been repaired

After a tire is repaired with the emergency tire puncture repair kit, the valve should be replaced.
- Note for checking the emergency tire puncture repair kit

Check the sealant expiry date occasionally.
The expiry date is shown on the bottle. Do not use sealant whose expiry date has already passed. Otherwise, repairs conducted using the emergency tire puncture repair kit may not be performed properly.

- If the tire is inflated to more than the recommended level

- 1 Disconnect the hose from the valve.
- 2 Install the air release cap to the end of the hose and push the protrusion on the air release cap into the valve to let some air out.

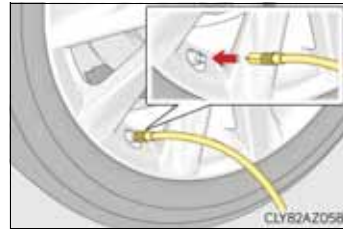

- 3 Disconnect the hose from the valve, remove the air release cap from the hose and then reconnect the hose.
- 4 Turn the compressor switch on and wait for several seconds, then turn it off. Check that the air pressure indicator shows the recommended level. (→P. 544) If the air pressure is lower than the recommended level, turn the compressor switch on again and repeat the inflation procedure until the recommended pressure is reached.

⚠ CAUTION

■ Caution while driving

Observe the following precautions.
Failure to do so may cause an accident.

- The emergency tire puncture repair kit is made exclusively for your vehicle. Do not use it on other vehicles.
- Do not use the emergency tire puncture repair kit for tires that are a different size than the specified ones or for any other purpose. Doing so may cause the tires to not be repaired properly.

■ Precautions for use of the sealant

- Ingesting the sealant is hazardous to your health. If you ingest sealant, consume as much water as possible, then immediately consult a doctor.
- If sealant gets in eyes or adheres to skin, immediately wash it off with water. If discomfort persists, consult a doctor.

 CAUTION

- When fixing the flat tire
 - Stop your vehicle in a safe and flat area.
 - Do not touch the wheels or the area around the brakes immediately after the vehicle has been driven.
After the vehicle has been driven, the wheels and the area around the brakes may be extremely hot. Touching these areas with hands, feet or other body parts may result in burns.
 - Connect the valve and hose securely with the tire installed on the vehicle.
 - If the hose is not properly connected to the valve, air leakage may occur or sealant may be sprayed out.
 - If the hose comes off the valve while inflating the tire, there is a risk that the hose will move abruptly due to air pressure.
 - After inflation of the tire has completed, the sealant may splatter when the hose is disconnected or some air is let out of the tire.
 - Follow the operation procedure to repair the tire. If the procedure is not followed, the sealant may spray out.
 - Keep back from the tire while it is being repaired, as there is a chance of it bursting while the repair operation is being performed. If you notice any cracks or deformation of the tire, turn off the compressor switch and stop the repair operation immediately.
 - The kit may overheat if operated for a long period of time. Do not operate the compressor continuously for more than 10 minutes.
 - Parts of the kit become hot during operation. Be careful handling the kit during and after operation.
 - Do not attach the vehicle speed warning sticker to an area other than the one indicated. If the sticker is attached to an area where an SRS airbag is located, such as the pad of the steering wheel, it may prevent the SRS air bag from operating properly.
- Driving to spread the liquid sealant evenly
 - Drive the vehicle carefully at a low speed. Be especially careful when turning and cornering.
 - If the vehicle does not drive straight or you feel a pull through the steering wheel, stop the vehicle and check the following:
 - Tire condition. The tire may have separated from the wheel.
 - Tire inflation pressure. If tire inflation pressure is 130 kPa (1.3 kgf/cm² or bar, 19 psi) or below, this may indicate severe tire damage.

**NOTICE**

- When performing an emergency repair
 - Perform the emergency repair without removing the nail or screw that has punctured the tread of the tire. If the object that has punctured the tire is removed, repair by the emergency tire puncture repair kit may not be possible.
 - The kit is not waterproof. Make sure that the kit is not exposed to water, such as when it is being used in the rain.
 - Do not put the kit directly onto dusty ground such as sand at the side of the road. If the kit vacuums up dust etc., a malfunction may occur.
 - Use the kit with the top facing upward. The kit cannot work properly if it is laid on its side.
- Handling the emergency tire puncture repair kit
 - The compressor power source should be 12 V DC suitable for vehicle use. Do not connect the compressor to any other source.
 - If gasoline splatters on the kit, the kit may deteriorate. Take care not to allow gasoline to contact it.
 - Store the kit in its assigned place out of reach of children.
 - Do not disassemble or modify the kit. Do not subject parts such as the air pressure indicator to impacts. This may cause a malfunction.
- To avoid damage to the tire pressure warning valves and transmitters

When a tire is repaired with liquid sealants, the tire pressure warning valve and transmitter may not operate properly. If a liquid sealant is used, contact any authorized Lexus dealer or repairer, or another duly qualified and equipped professional as soon as possible. Make sure to replace the tire pressure warning valve and transmitter when replacing the tire. (→P. 426)

FarmaSOS.com

If the engine will not start

If the engine will not start even though correct starting procedures are being followed (→P. 190), consider each of the following points:

The engine will not start even though the starter motor operates normally.

One of the following may be the cause of the problem:

- There may not be sufficient fuel in the vehicle's tank.
Refuel the vehicle.
- The engine may be flooded.
Try to restart the engine again following correct starting procedures.
(→P. 190)
- There may be a malfunction in the engine immobilizer system.
(→P. 77)

The starter motor turns over slowly, the interior lights and headlights are dim, or the horn does not sound or sounds at a low volume.

One of the following may be the cause of the problem:

- The battery terminal connections may be loose or corroded.
- The battery may be discharged. (→P. 527)

The starter motor does not turn over

The engine starting system may be malfunctioning due to an electrical problem such as electronic key battery depletion or a blown fuse. However, an interim measure is available to start the engine. (→P. 522)

The starter motor does not turn over, the interior lights and headlights do not turn on, or the horn does not sound.

One of the following may be the cause of the problem:

- One or both of the battery terminals may be disconnected.
- The battery may be discharged. (→P. 527)
- There may be a malfunction in the steering lock system.

Contact any authorized Lexus dealer or repairer, or another duly qualified and equipped professional if the problem cannot be repaired, or if repair procedures are unknown.

Emergency start function

When the engine does not start, the following steps can be used as an interim measure to start the engine if the engine switch is functioning normally:

- 1 Set the parking brake.
- 2 Shift the shift lever to P.
- 3 Turn the engine switch to ACCESSORY mode.
- 4 Press and hold the engine switch for about 15 seconds while depressing the brake pedal firmly.

Even if the engine can be started using the above steps, the system may be malfunctioning. Have the vehicle inspected by any authorized Lexus dealer or repairer, or another duly qualified and equipped professional.

FarmaSOS.com

If the shift lever cannot be shifted from P

If the shift lever cannot be shifted with your foot on the brake pedal, there may be a problem with the shift lock system (a system to prevent accidental operation of the shift lever). Have the vehicle inspected by any authorized Lexus dealer or repairer, or another duly qualified and equipped professional immediately.

The following steps may be used as an emergency measure to ensure that the shift lever can be shifted:

- 1 Set the parking brake.
- 2 Turn the engine switch to ACCESSORY mode.
- 3 Depress the brake pedal.
- 4 Pry the cover up with a flathead screwdriver or equivalent tool.

To prevent damage to the cover, cover the tip of the screwdriver with a rag.

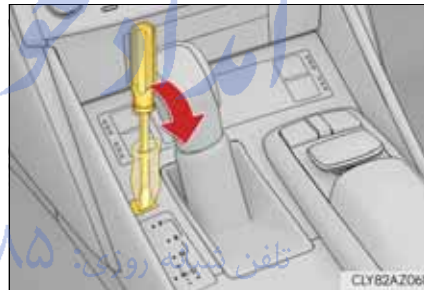

- 5 Press the shift lock override button.

The shift lever can be shifted while the button is pressed.

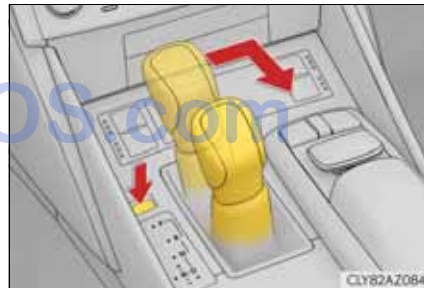

If the electronic key does not operate properly

If communication between the electronic key and vehicle is interrupted (→P. 132) or the electronic key cannot be used because the battery is depleted, the smart entry & start system and wireless remote control cannot be used. In such cases, the doors and trunk can be opened and the engine can be started by following the procedure below.

Locking and unlocking the doors, unlocking the trunk and key linked functions

■ Doors

Use the mechanical key (→P. 113) in order to perform the following operations:

- ① Locks all the doors
- ② Closes the windows and moon roof (turn and hold)*
- ③ Unlocks all the doors
- ④ Opens the windows and moon roof (turn and hold)*

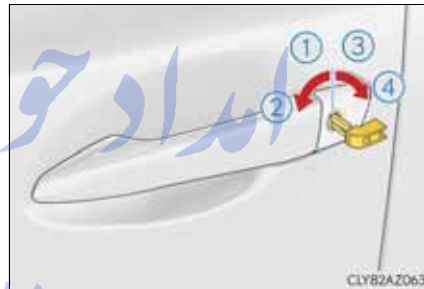

*: This setting must be customized at any authorized Lexus dealer or repairer, or another duly qualified and equipped professional.

■ Trunk

Turn the mechanical key clockwise to open.



Starting the engine

- 1 Ensure that the shift lever is in P and depress the brake pedal.

- 2 Touch the Lexus emblem side of the electronic key to the engine switch.

When the electronic key is detected, a buzzer sounds and the engine switch will turn to IGNITION ON mode.

When the smart entry & start system is deactivated in customization setting, the engine switch will turn to ACCESSORY mode.

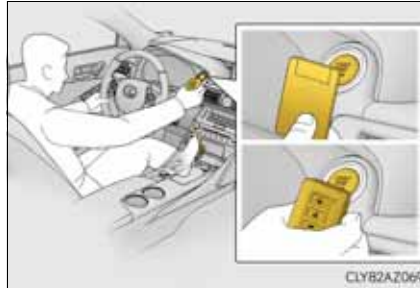

- 3 Firmly depress the brake pedal and check that  is shown on the multi-information display.
- 4 Press the engine switch.

In the event that the engine still cannot be started, contact any authorized Lexus dealer or repairer, or another duly qualified and equipped professional.

تلفن شبانه روزی: ۰۲۱-۸۸۸۶۲۰۸۵

FarmaSOS.com

- Stopping the engine
Shift the shift lever to P and press the engine switch as you normally do when stopping the engine.
- Replacing the key battery
As the above procedure is a temporary measure, it is recommended that the electronic key battery be replaced immediately when the battery is depleted. (→P. 441)
- Alarm (if equipped)
Using the mechanical key to lock the doors will not set the alarm system.
If a door is unlocked using the mechanical key when the alarm system is set, the alarm may be triggered.
- Changing engine switch modes
Release the brake pedal and press the engine switch in step 3 above.
The engine does not start and modes will be changed each time the switch is pressed. (→P. 191)
- When the electronic key does not work properly
 - Make sure that the smart entry & start system has not been deactivated in the customization setting. If it is off, turn the function on.
(Customizable features →P. 549)
 - Check if battery-saving mode is set. If it is set, cancel the function. (→P. 131)

تلفن شبانه روزی: ۰۲۱-۸۸۶۲۰۸۵

FarmaSOS.com

If the vehicle battery is discharged

The following procedures may be used to start the engine if the vehicle's battery is discharged.

You can also call any authorized Lexus dealer or repairer, or another duly qualified and equipped professional.

If you have a set of jumper (or booster) cables and a second vehicle with a 12-volt battery, you can jump start your vehicle by following the steps below.

- 1 Open the hood. (→P. 413)
- 2 Raise the front of the engine cover to detach it from the clips and then pull the cover to detach it from the brackets on the rear bar.

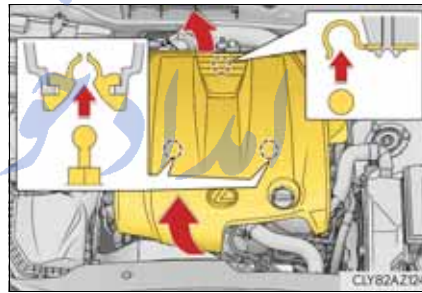

تلفن شبانه روزی: ۰۲۱-۸۸۸۶۲۰۸۵

FarmaSOS.com

3 Connect the jumper cables according to the following procedure:

▶ Left-hand drive vehicles

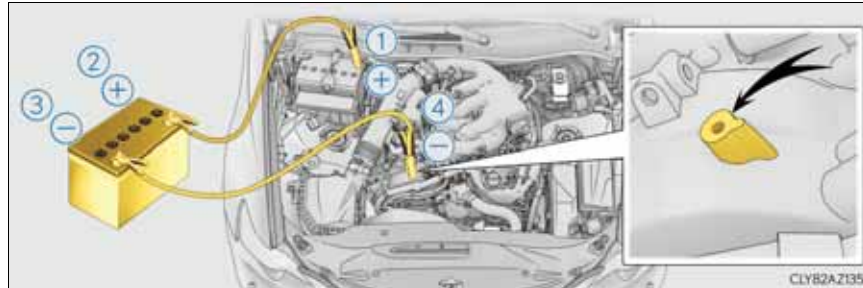

▶ Right-hand drive vehicles

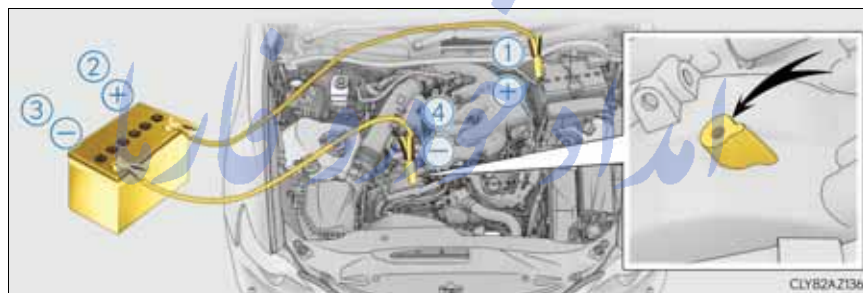

- ① Connect a positive jumper cable clamp to the positive (+) battery terminal on your vehicle.
- ② Connect the clamp on the other end of the positive cable to the positive (+) battery terminal on the second vehicle.
- ③ Connect a negative cable clamp to the negative (-) battery terminal on the second vehicle.
- ④ Connect the clamp at the other end of the negative cable to a solid, stationary, unpainted metallic point away from the battery and any moving parts, as shown in the illustration.

- 4 Start the engine of the second vehicle. Increase the engine speed slightly and maintain at that level for approximately 5 minutes to recharge the battery of your vehicle.
- 5 Open and close any of the doors of your vehicle with the engine switch off.
- 6 Maintain the engine speed of the second vehicle and start the engine of your vehicle by turning the engine switch to IGNITION ON mode.
- 7 Once the vehicle's engine has started, remove the jumper cables in the exact reverse order from which they were connected.

Once the engine starts, have the vehicle inspected at any authorized Lexus dealer or repairer, or another duly qualified and equipped professional as soon as possible.

-
- Starting the engine when the battery is discharged
The engine cannot be started by push-starting.
 - To prevent battery discharge
 - Turn off the headlights and the audio system while the engine is off.
 - Turn off any unnecessary electrical components when the vehicle is running at a low speed for an extended period, such as in heavy traffic.
 - Charging the battery
The electricity stored in the battery will discharge gradually even when the vehicle is not in use, due to natural discharge and the draining effects of certain electrical appliances. If the vehicle is left for a long time, the battery may discharge, and the engine may be unable to start. (The battery recharges automatically during driving.)
 - When recharging or replacing the battery
 - For vehicles with an alarm: Make sure that the key is not inside the vehicle when recharging or replacing the battery. The key may be locked in the vehicle if the alarm is activated. (→P. 85)
 - In some cases, it may not be possible to unlock the doors using the smart entry & start system when the battery is discharged. Use the wireless remote control or the mechanical key to lock or unlock the doors.
 - The engine may not start on the first attempt after the battery has recharged but will start normally after the second attempt. This is not a malfunction.
 - The engine switch mode is memorized by the vehicle. When the battery is reconnected, the system will return to the mode it was in before the battery was discharged. Before disconnecting the battery, turn the engine switch off. If you are unsure what mode the engine switch was in before the battery discharged, be especially careful when reconnecting the battery.

 CAUTION**■ Avoiding battery fires or explosions**

Observe the following precautions to prevent accidentally igniting the flammable gas that may be emitted from the battery:

- Make sure each jumper cable is connected to the correct terminal and that it is not unintentionally in contact with any other than the intended terminal.
- Do not allow the other end of the jumper cable connected to the “+” terminal to come into contact with any other parts or metal surfaces in the area, such as brackets or unpainted metal.
- Do not allow the + and - clamps of the jumper cables to come into contact with each other.
- Do not smoke, use matches, cigarette lighters or allow open flame near the battery.

■ Battery precautions

The battery contains poisonous and corrosive acidic electrolyte, while related parts contain lead and lead compounds. Observe the following precautions when handling the battery:

- When working with the battery, always wear safety glasses and take care not to allow any battery fluids (acid) to come into contact with skin, clothing or the vehicle body.
- Do not lean over the battery.
- In the event that battery fluid comes into contact with the skin or eyes, immediately wash the affected area with water and seek medical attention. Place a wet sponge or cloth over the affected area until medical attention can be received.
- Always wash your hands after handling the battery support, terminals, and other battery-related parts.
- Do not allow children near the battery.

 NOTICE**■ When handling jumper cables**

When connecting the jumper cables, ensure that they do not become entangled in the cooling fans or engine drive belt.

If your vehicle overheats

The following may indicate that your vehicle is overheating.

- The needle of the engine coolant temperature gauge (→P. 95) enters the red zone or a loss of engine power is experienced. (For example, the vehicle speed does not increase.)
- Steam comes out from under the hood.

Correction procedures

- 1 Stop the vehicle in a safe place and turn off the air conditioning system, and then stop the engine.
- 2 If you see steam:
Carefully lift the hood after the steam subsides.
If you do not see steam:
Carefully lift the hood.

- 3 After the engine has cooled down sufficiently, inspect the hoses and radiator core (radiator) for any leaks.

- ① Radiator
- ② Cooling fans

If a large amount of coolant leaks, immediately contact any authorized Lexus dealer or repairer, or another duly qualified and equipped professional.

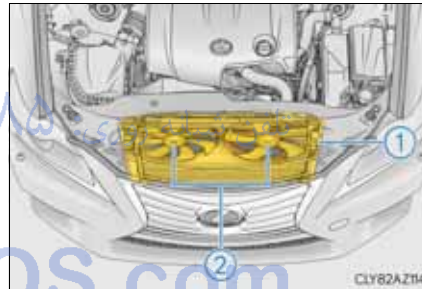

- 4 The coolant level is satisfactory if it is between the “FULL” and “LOW” lines on the reservoir.

- ① Reservoir
- ② “FULL”
- ③ “LOW”

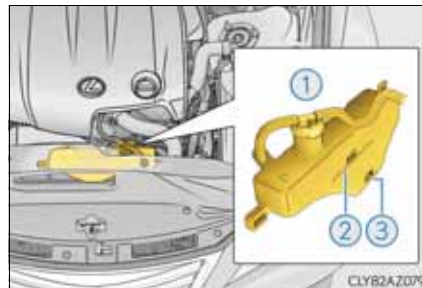

- 5** Add coolant if necessary.
Water can be used in an emergency if coolant is unavailable.

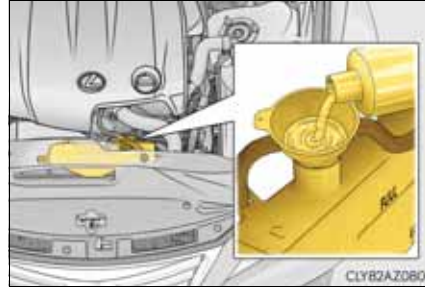

- 6** Start the engine and turn the air conditioning system on to check that the radiator cooling fan operates and to check for coolant leaks from the radiator or hoses.

The fan operates when the air conditioning system is turned on immediately after a cold start. Confirm that the fan is operating by checking the fan sound and air flow. If it is difficult to check these, turn the air conditioning system on and off repeatedly.

(The fan may not operate in freezing temperatures.)

- 7** If the fan is not operating:
Stop the engine immediately and contact any authorized Lexus dealer or repairer, or another duly qualified and equipped professional.

If the fan is operating:

Have the vehicle inspected at the nearest authorized Lexus dealer or repairer, or another duly qualified and equipped professional.

FarmaSOS.com

 CAUTION

■ When inspecting under the hood of your vehicle

Observe the following precautions.

Failure to do so may result in serious injury such as burns.

- If steam is seen coming from under the hood, do not open the hood until the steam has subsided. The engine compartment may be very hot.
- Keep hands and clothing (especially a tie, a scarf or a muffler) away from the fans and belts. Failure to do so may cause the hands or clothing to be caught, resulting in serious injury.
- While the engine and radiator are hot, do not loosen or remove the coolant reservoir cap or radiator cap. (The radiator cap is located under the engine cover.) High temperature steam or coolant could spray out.

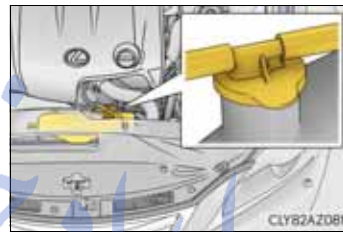

 NOTICE

■ When adding engine coolant

Add coolant slowly after the engine has cooled down sufficiently. Adding cool coolant to a hot engine too quickly can cause damage to the engine.

■ To prevent damage to the cooling system

Observe the following precautions:

- Avoid contaminating the coolant with foreign matter (such as sand or dust etc.).
- When using coolant additives, use genuine Toyota products or equivalent.

If the vehicle becomes stuck

Carry out the following procedures if the tires spin or the vehicle becomes stuck in mud, dirt or snow:

- 1 Stop the engine. Set the parking brake and shift the shift lever to P.
- 2 Remove the mud, snow or sand from around the rear wheels.
- 3 Place wood, stones or some other material under the rear wheels to help provide traction.
- 4 Restart the engine.
- 5 Shift the shift lever to D or R and release the parking brake. Then, while exercising caution, depress the accelerator pedal.

- When it is difficult to free the vehicle

Press  to turn off TRC.



 CAUTION

■ When attempting to free a stuck vehicle

If you choose to push the vehicle back and forth to free it, make sure the surrounding area is clear to avoid striking other vehicles, objects or people. The vehicle may also lunge forward or lunge back suddenly as it becomes free. Use extreme caution.

■ When shifting the shift lever

Be careful not to shift the shift lever with the accelerator pedal depressed. This may lead to unexpected rapid acceleration of the vehicle that may cause an accident resulting in death or serious injury.

 NOTICE

■ To avoid damaging the transmission and other components

- Avoid spinning the rear wheels and depressing the accelerator pedal more than necessary.
- If the vehicle remains stuck even after these procedures are performed, the vehicle may require towing to be freed.

تلفن شبانه روزی: ۰۲۱-۸۸۶۲۰۸۵

FarmaSOS.com

Vehicle specifications

9

- 9-1. Specifications
 - Maintenance data
(fuel, oil level, etc.)..... 536
 - Fuel information 547
- 9-2. Customization
 - Customizable features..... 549
- 9-3. Items to initialize
 - Items to initialize 559

تلفن شبانه روزی: ۰۲۱-۸۸۸۶۲۰۸۵

FarmaSOS.com

Maintenance data (fuel, oil level, etc.)

Dimensions and weights

Overall length		4665 mm (183.7 in.)
Overall width		1810 mm (71.3 in.)
Overall height* ¹		1430 mm (56.3 in.)
Wheelbase		2800 mm (110.2 in.)
Tread* ¹	Front	1535 mm (60.4 in.)
	Rear	1550 mm (61.0 in.) 1540 mm (60.6 in.)* ²
Gross vehicle mass* ³		2090 kg (4608 lb.)
Maximum permissible axle capacity* ³	Front	1090 kg (2403 lb.)
	Rear	1200 kg (2646 lb.)
Drawbar load* ³		75 kg (165 lb.)
Towing capacity* ³	With brake	1500 kg (3307 lb.)
	Without brake	750 kg (1653 lb.)

*¹: Unladen vehicle

*²: Vehicles with 255/35R18 tires

*³: Vehicles with a towing package

FarmasOS.com

Vehicle identification

■ Vehicle identification number

The vehicle identification number (VIN) is the legal identifier for your vehicle. This is the primary identification number for your Lexus. It is used in registering the ownership of your vehicle.

This number is stamped on the top left of the instrument panel and in the engine compartment.

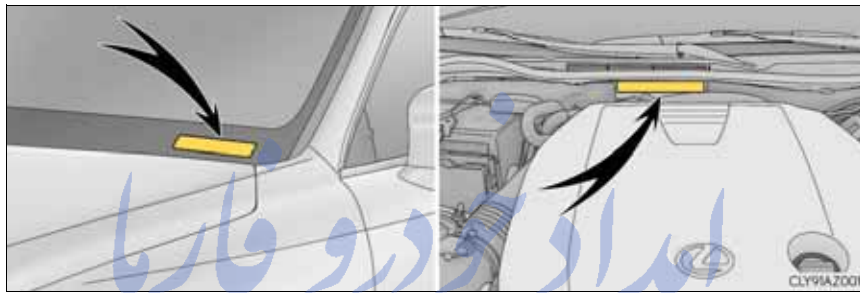

This number is also on the manufacturer's label.



■ Engine number

The engine number is stamped on the engine block as shown.



Engine

Model	4GR-FSE
Type	6-cylinder V type, 4-cycle, gasoline
Bore and stroke	83.0 × 77.0 mm (3.27 × 3.03 in.)
Displacement	2500 cm ³ (152.6 cu. in.)
Valve clearance (engine cold)	Automatic adjustment
Drive belt tension	Automatic adjustment

Fuel

Fuel type	EU area: Unleaded gasoline conforming to European standard EN228 only Except EU area: Unleaded gasoline only
Research Octane Number	95 or higher
Fuel tank capacity (Reference)	66 L (17.4 gal., 14.5 Imp. gal.)

FarmaSOS.com

Lubrication system

■ Oil capacity (Drain and refill [Reference*])

With filter	6.2 L (6.6 qt., 5.5 Imp. qt.)
Without filter	5.9 L (6.2 qt., 5.2 Imp. qt.)

*: The engine oil capacity is a reference quantity to be used when changing the engine oil. Warm up and turn off the engine, wait more than 5 minutes, and check the oil level on the dipstick.

■ Engine oil selection

“Toyota Genuine Motor Oil” is used in your Lexus vehicle. Lexus recommends the use of approved “Toyota Genuine Motor Oil”. Another motor oil of matching quality can also be used.

Oil grade:

0W-20, 5W-20, 5W-30 and 10W-30:

API grade SL “Energy-Conserving”, SM “Energy-Conserving” or SN “Resource-Conserving”; or ILSAC multigrade engine oil

15W-40 and 20W-50:

API grade SL, SM or SN multigrade engine oil

Recommended viscosity (SAE):

SAE 0W-20 is filled into your Lexus vehicle at manufacturing, and the best choice for good fuel economy and good starting in cold weather.

If SAE 0W-20 oil is not available, SAE 5W-30 oil may be used. However, it should be replaced with SAE 0W-20 at the next oil change.

If you use SAE 10W-30 or a higher viscosity engine oil in extremely low temperatures, the engine may become difficult to start, so SAE 0W-20, 5W-20 or 5W-30 engine oil is recommended.

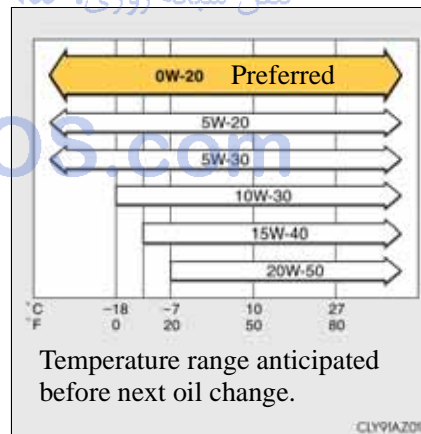

Oil viscosity (0W-20 is explained here as an example):

- The 0W in 0W-20 indicates the characteristic of the oil which allows cold startability. Oils with a lower value before the W allow for easier starting of the engine in cold weather.
- The 20 in 0W-20 indicates the viscosity characteristic of the oil when the oil is at high temperature. An oil with a higher viscosity (one with a higher value) may be better suited if the vehicle is operated at high speeds, or under extreme load conditions.

How to read oil container labels:

Either or both API registered marks are added to some oil containers to help you select the oil you should use.

① API Service Symbol

Top portion: “API SERVICE SN” means the oil quality designation by American Petroleum Institute (API).

Center portion: “SAE 0W-20” means the SAE viscosity grade.

Lower portion: “Resource-Conserving” means that the oil has fuel-saving and environmental protection capabilities.

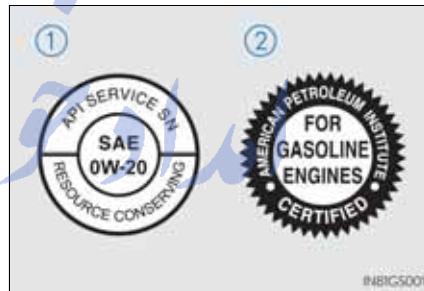

② ILSAC Certification Mark

The International Lubricant Specification Advisory Committee (ILSAC) Certification Mark is displayed on the front of the container.

FarmaSOS.com

Cooling system

Capacity	10.5 L (11.1 qt., 9.2 Imp. qt.)
Coolant type	Use either of the following: <ul style="list-style-type: none"> • “Toyota Super Long Life Coolant” • Similar high-quality ethylene glycol-based non-silicate, non-amine, non-nitrite, and non-borate coolant with long-life hybrid organic acid technology Do not use plain water alone.

Ignition system

■ Spark plug

Make	DENSO FK20HBR11
Gap	1.1 mm (0.043 in.)

 NOTICE

■ Iridium-tipped spark plugs

Use only iridium-tipped spark plugs. Do not adjust the spark plug gap.

تلفن شبانه روزی: ۰۲۱-۸۸۶۲۰۸۵

FarmaSOS.com

Electrical system

Battery	
Specific gravity reading at 20°C (68°F):	1.250 — 1.290 Fully charged 1.160 — 1.200 Half charged 1.060 — 1.100 Discharged
Charging rates	
Quick charge	15 A max.
Slow charge	5 A max.

Automatic transmission

Fluid capacity*	7.5 L (7.9 qt., 6.6 Imp. qt.)
Fluid type	Toyota Genuine ATF WS

*: The fluid capacity is a reference quantity.
If replacement is necessary, contact any authorized Lexus dealer or repairer, or another duly qualified and equipped professional.

NOTICE

- Automatic transmission fluid type
Using transmission fluid other than “Toyota Genuine ATF WS” may cause deterioration in shift quality, locking up of your transmission accompanied by vibration, and ultimately damage the transmission of your vehicle.

FarmaSOS.com

Differential

Oil capacity	1.15 L (1.20 qt., 1.01 Imp. qt.)
Oil type and viscosity	Toyota Genuine Differential gear oil LT 75W-85 GL-5 or equivalent

Your Lexus vehicle is filled with “Toyota Genuine Differential Gear Oil” at the factory.

Use Lexus approved “Toyota Genuine Differential Gear Oil” or an equivalent of matching quality to satisfy the above specification. Please contact any authorized Lexus dealer or repairer, or another duly qualified and equipped professional for further details.

Brakes

Pedal clearance* ¹	107 mm (4.2 in.) Min.
Pedal free play	1.0 — 2.0 mm (0.04 — 0.08 in.)
Parking brake pedal travel* ²	7 - 10 clicks
Fluid type	SAE J1703 or FMVSS No. 116 DOT 3

*¹: Minimum pedal clearance when depressed with a force of 500 N (51.0 kgf, 112.4 lbf) while the engine is running.

*²: Parking brake pedal travel when depressed with a force of 300 N (30.6 kgf, 67.4 lbf)

Steering

Free play	Less than 30 mm (1.2 in.)
-----------	---------------------------

Tires and wheels

► 16-inch tires

Tire size	205/55R16 91W		
Tire inflation pressure (Recommended cold tire inflation pressure)	Vehicle speed	Front wheel kPa (kgf/cm ² or bar, psi)	Rear wheel kPa (kgf/cm ² or bar, psi)
	More than 210 km/h (132 mph)	270 (2.7, 39)* 260 (2.6, 38)	300 (3.0, 44)* 260 (2.6, 38)
	From 160 km/h (100 mph) to 210 km/h (132 mph)	250 (2.5, 36)	270 (2.7, 39)* 250 (2.5, 36)
	160 km/h (100 mph) or less		250 (2.5, 36)
Wheel size	16 × 7J		
Wheel nut torque	103 N•m (10.5 kgf•m, 76 ft•lbf)		

*: 5 passengers

► 17-inch tires

Tire size	225/45R17 91W		
Tire inflation pressure (Recommended cold tire inflation pressure)	Vehicle speed	Front wheel kPa (kgf/cm ² or bar, psi)	Rear wheel kPa (kgf/cm ² or bar, psi)
	More than 210 km/h (132 mph)	270 (2.7, 39)* 260 (2.6, 38)	300 (3.0, 44)* 260 (2.6, 38)
	From 160 km/h (100 mph) to 210 km/h (132 mph)	250 (2.5, 36)	270 (2.7, 39)* 250 (2.5, 36)
	160 km/h (100 mph) or less		250 (2.5, 36)
Wheel size	17 × 7 1/2J		
Wheel nut torque	103 N•m (10.5 kgf•m, 76 ft•lbf)		

*: 5 passengers

► 18-inch tires

Tire size	225/40R18 88Y, 255/35R18 90Y		
Tire inflation pressure (Recommended cold tire inflation pressure)	Vehicle speed	Front wheel kPa (kgf/cm ² or bar, psi)	Rear wheel kPa (kgf/cm ² or bar, psi)
	More than 210 km/h (130 mph)	270 (2.7, 39)* 250 (2.5, 36)	270 (2.7, 39)* 250 (2.5, 36)
	210 km/h (130 mph) or less	250 (2.5, 36)	250 (2.5, 36)
Wheel size	18 × 8J (225/40R18), 18 × 8 1/2J (255/35R18)		
Wheel nut torque	103 N•m (10.5 kgf•m, 76 ft•lbf)		

*: 5 passengers

► Compact spare tire

Tire size	T125/70D17 98M
Tire inflation pressure (Recommended cold tire inflation pressure)	420 kPa (4.2 kgf/cm ² or bar, 60 psi)
Wheel size	17 × 4T
Wheel nut torque	103 N•m (10.5 kgf•m, 76 ft•lbf)

■ When towing a trailer (vehicles with a towing package)

Add 20.0 kPa (0.2 kgf/cm² or bar, 3 psi) to the recommended tire inflation pressure and drive at speeds below 100 km/h (62 mph).

Light bulbs*¹

	Light bulbs	W	Type
Exterior	Discharge headlights* ²	35	A
	Front fog lights (except F SPORT models)* ²	19	B
	Front turn signal lights	21	C
	Rear turn signal lights	21	C
	Back-up lights	16	D
	Outer foot lights	5	D
Interior	Door courtesy lights	5	D
	Vanity lights	8	D
	Interior light	8	D
	Personal lights	8	D
	Footwell lights	3.8	D
	Trunk light	5	D

A: D4S discharge bulbs

B: H16 halogen bulbs

C: Wedge base bulbs (amber)

D: Wedge base bulbs (clear)

*¹: Light bulbs not listed in this table are LED bulbs.

*²: If equipped

Fuel information

EU area:

Your vehicle must use only unleaded gasoline conforming to European standard EN228.

For optimum engine performance, select unleaded gasoline with a Research Octane Number of 95 or higher.

Except EU area:

Your vehicle must use only unleaded gasoline.

For optimum engine performance, select unleaded gasoline with a Research Octane Number of 95 or higher.

■ Fuel tank opening for unleaded gasoline

To help prevent incorrect fueling, your vehicle has a fuel tank opening that only accommodates the special nozzle on unleaded fuel pumps.

■ If your engine knocks

- Consult any authorized Lexus dealer or repairer, or another duly qualified and equipped professional.
- You may occasionally notice light knocking for a short time while accelerating or driving uphill. This is normal and there is no need for concern.

تلفن شبانه روزی: ۰۲۱-۸۸۸۶۲۰۸۵

FarmaSOS.com



NOTICE

■ Notice on fuel quality

- Do not use improper fuels. If improper fuels are used, the engine will be damaged.
- Do not use leaded gasoline.
Leaded gasoline will cause the three-way catalytic converter to lose its effectiveness and the emission control system to function improperly.
- Gasoline engine (EU area): Bioethanol fuel sold under names such as “E50” or “E85” and fuel containing a large amount of ethanol should not be used. The use of these fuels will damage the vehicle’s fuel system. In case of any doubt, ask any authorized Lexus dealer or repairer, or another duly qualified and equipped professional.
- Gasoline engine (except EU area): Bioethanol fuel sold under names such as “E50” or “E85” and fuel containing a large amount of ethanol should not be used. Your vehicle can use gasoline mixed with 10% max ethanol. The use of fuel with more than 10% ethanol content (E10) will damage the vehicle’s fuel system. You must ensure that refueling is carried out only from a source where fuel specification and quality can be guaranteed. In case of any doubt, ask any authorized Lexus dealer or repairer, or another duly qualified and equipped professional.

تلفن شبانه روزی: ۰۲۱-۸۸۸۶۲۰۸۵

FarmaSOS.com

Customizable features

Your vehicle includes a variety of electronic features that can be personalized to your preferences. The settings of these features can be changed by using the meter control switches, the Remote Touch or Lexus Display Audio controller or at any authorized Lexus dealer or repairer, or another duly qualified and equipped professional.

Customizing vehicle features

- Changing by using the Remote Touch or Lexus Display Audio controller
 - ▶ Vehicles with a Remote Touch
 - 1 Press the “MENU” button on the Remote Touch.
 - 2 Select “Setup” on the “Menu” screen and select “Vehicle”.

Various setting can be changed. Refer to the list of settings that can be changed for details.
 - ▶ Vehicles with a Lexus Display Audio controller
 - 1 Press the “MENU” button on the Lexus Display Audio controller.
 - 2 Select “Setup” on the “MENU” screen and select “Vehicle”.

Various setting can be changed. Refer to the list of settings that can be changed for details.
- Changing by using the meter control switches
→P. 101

Customizable features

Some function settings are changed simultaneously with other functions being customized. Contact any authorized Lexus dealer or repairer, or another duly qualified and equipped professional.

- ① Settings that can be changed using the Remote Touch or Lexus Display Audio controller
- ② Settings that can be changed using the meter control switches
- ③ Settings that can be changed by any authorized Lexus dealer or repairer, or another duly qualified and equipped professional

Definition of symbols: O = Available, — = Not available

■ Gauges, meters and multi-information display (→P. 90, 95, 100)

Function*1	Default setting	Customized setting	①	②	③
Language*2	English	French			
		German			
		Spanish	—	O	—
		Italian			
		Russian			
Units*2	km (L/100 km)	km (km/L)	—	O	—
		miles (MPG)			
Eco Driving Indicator Light	ON (Self-lighting)	OFF	—	O	—
■ switch settings*3	Drive information 1	Desired status screen*4	—	O	—
Drive information 1	Current fuel economy	*5	—	O	—
	Average fuel economy (after reset)				
Drive information 2	Distance (range)	*5	—	O	—
	Average speed (after reset)				

Function*1	Default setting	Customized setting	①	②	③
Pop-up display	ON	OFF	—	O	—
Accent color*3	Blue	Red	O	O	—
Needle*6	Blue	Red	—	O	—
		White	—	O	—
Speed indicator*6	OFF	50 to 200 km/h (30 to 125 mph)*7	—	O	—
		50 to 160 km/h (30 to 100 mph)*7	—	O	—
REV indicator*6	5000 r/min	2000 to 6600 r/min	—	O	—
		OFF	—	O	—
REV peak*6	ON	OFF	—	O	—

*1: For details about each function: →P. 102

*2: The default setting varies according to country.

*3: Except F SPORT models

*4: Some status screens cannot be registered (indicated on multi-information display).

*5: 2 of the following items: current fuel consumption, average fuel economy (after reset), average fuel economy (after refuel), average fuel economy (after start), average vehicle speed (after reset), average vehicle speed (after start), distance (driving range), distance (after start), elapsed time (after reset), elapsed time (after start), blank.

*6: F SPORT models

*7: The customized setting varies according to country.

■ Door lock (→P. 118, 125, 524)

Function	Default setting	Customized setting	①	②	③
Unlocking using a mechanical key	All doors unlocked in one step	Driver's door unlocked in one step, all doors unlocked in two steps	—	—	O
Speed-detecting automatic door lock function	On	Off	O	—	O
Shifting gears to position other than P locks all doors	Off	On	O	—	O
Shifting gears to P unlocks all doors	Off	On	O	—	O
Opening driver's door unlocks all doors	On	Off	O	—	O
Locking/unlocking of the trunk when all doors are locked/unlocked	On	Off	—	—	O

■ Smart entry & start system and wireless remote control (→P. 118, 125)

Function	Default setting	Customized setting	①	②	③
Operation signal (Emergency flashers)	On	Off	O	—	O
Time elapsed before automatic door lock function is activated if door is not opened after being unlocked	30 seconds	60 seconds	—	—	O
		120 seconds	—	—	O
Open door warning buzzer	On	Off	—	—	O

■ Smart entry & start system (→P. 118, 125, 130)

Function	Default setting	Customized setting	①	②	③
Smart entry & start system	On	Off	0	—	0
Smart door unlocking*	All the doors	Driver's door	0	—	0
Number of consecutive door lock operations*	As many as desired	2 times	—	—	0

*: If equipped

■ Wireless remote control (→P. 118, 125)

Function	Default setting	Customized setting	①	②	③
Wireless remote control	On	Off	—	—	0
Unlocking operation	All doors unlocked in one step	Driver's door unlocked in one step, all doors unlocked in two steps	0	—	0
Trunk unlocking operation	Press and hold (short)	One short press	—	—	0
		Push twice			
		Press and hold (long)			
		Off			

■ Driving position memory* (→P. 149)

Function	Default setting	Customized setting	①	②	③
Driver's seat movement when exiting the vehicle	Standard	Off	0	—	0
		Partial			
Selecting the door linking driving position memory with door unlock operation	Driver's door	All doors	—	—	0

*: If equipped

■ Outside rear view mirrors (→P. 161)

Function	Default setting	Customized setting	①	②	③
Automatic mirror folding and extending operation*	Linked to the locking/unlocking of the doors	Off			
		Linked to operation of the engine switch	—	—	0

*: If equipped

■ Power windows (→P. 165)

Function	Default setting	Customized setting	①	②	③
Mechanical key linked operation	Off	On	—	—	0
Wireless remote control linked operation	Off	On	—	—	0

■ Moon roof* (→P. 168)

Function	Default setting	Customized setting	①	②	③
Mechanical key linked operation	Off	On	—	—	0
Linked operation of components when mechanical key is used (open only)	Slide only	Tilt only	—	—	0
Wireless remote control linked operation	Off	On	—	—	0
Linked operation of components when wireless remote control is used (open only)	Slide only	Tilt only	—	—	0

*: If equipped

■ Turn signal lever (→P. 201)

Function	Default setting	Customized setting	①	②	③
The number of times the turn signal lights flash automatically when the turn signal lever is moved to the first position during a lane change* ¹	3	5	—	—	O
		7			
		Off* ²			
		Off* ³			

*¹: After flashing the turn signal lights when turning left or right while this function is off and the turn signal lever is moved to the first position in the direction of the flashing light, the turn signal lights can be selected to be flashing or off.

*²: The turn signal lights keep flashing if the turn signal lever is moved to the first position in the direction of flashing light.

*³: The turn signal lights will be off if the turn signal lever is moved to the first position in the direction of flashing light.

■ Automatic light control system (→P. 204)

Function	Default setting	Customized setting	①	②	③
Light sensor sensitivity	Standard	-2 to 2	O	—	O
Time elapsed before headlights automatically turn off	30 seconds	60 seconds	—	—	O
		90 seconds			
		120 seconds			
Welcome light illumination control	On	Off	—	—	O

■ Lexus parking assist-sensor*¹ (→P. 249)

Function	Default setting	Customized setting	①	②	③
Detection distance of the front center sensor	Far	Near	O	—	O
Detection distance of the rear center sensor	Far	Near	O	—	O
Buzzer volume	3	1 to 5	O	—	O
Display setting* ²	All sensors displayed	Display off	O	—	O

*¹: If equipped

*²: When Lexus parking assist-sensor is operating.

■ Automatic air conditioning system (→P. 374)

Function	Default setting	Customized setting	①	②	③
Switching between outside air and recirculated air mode linked to "AUTO" switch operation	On	Off	O	—	O
A/C Auto switch operation	On	Off	O	—	O

FarmaSOS.com

■ Illumination (→P. 387)

Function	Default setting	Customized setting	①	②	③
Time elapsed before the interior lights turn off	15 seconds	Off	0	—	0
		7.5 seconds			
		30 seconds			
Operation after the engine switch is turned off	On	Off	—	—	0
Operation when the doors are unlocked	On	Off	—	—	0
Operation when you approach the vehicle with the electronic key on your person	On	Off	—	—	0
Inside door handle lights	On	Off	—	—	0
Time elapsed before the outer foot lights turn off	15 seconds	Off	0	—	0
		7.5 seconds			
		30 seconds			
Operation of the outer foot lights when you approach the vehicle with the electronic key on your person	On	Off	—	—	0
Operation of the outer foot lights when the doors are unlocked with the power door lock switch	On	Off	—	—	0

- Vehicle customization
 - When the speed-detecting automatic door lock and shift-linked automatic door lock are both on, the door lock operates as follows.
 - When shifting the shift lever to any position other than P, all the doors will be locked.
 - If the vehicle is started with all doors locked, the speed-detecting automatic door lock will not operate.
 - If the vehicle is started with any door unlocked, the speed-detecting automatic door lock will operate.
 - When the smart entry & start system is off, the entry unlock function cannot be customized.
 - When the doors remain closed after unlocking the doors and the timer activated automatic door lock function activates, signals will be generated in accordance with the operation buzzer volume and operational signal (Emergency flashers) function settings.
- When customizing using the Remote Touch or Lexus Display Audio controller

Stop the vehicle in a safe place, apply the parking brake, and shift the shift lever to P. Also, to prevent battery discharge, leave the engine running while customizing the features.

 CAUTION

- During customization

As the engine needs to be running during customization, ensure that the vehicle is parked in a place with adequate ventilation. In a closed area such as a garage, exhaust gases including harmful carbon monoxide (CO) may collect and enter the vehicle. This may lead to death or a serious health hazard.

 NOTICE

- During customization

To prevent battery discharge, ensure that the engine is running while customizing features.

Items to initialize

The following item must be initialized for normal system operation after such cases as the battery being reconnected, or maintenance being performed on the vehicle:

Item	When to initialize	Reference
Tire pressure warning system*	<ul style="list-style-type: none"> • When rotating the tires • When changing the tire inflation pressure by changing traveling speed or load weight, etc. 	P. 427

*: If equipped

امداد خودرو فارما

تلفن شبانه روزی: ۰۲۱-۸۸۸۶۲۰۸۵

FarmaSOS.com

امداد خودرو فارما

تلفن شبانه روزی: ۰۲۱-۸۸۸۶۲۰۸۵

FarmaSOS.com

Index

What to do if... (Troubleshooting).....	562
Alphabetical index.....	566

امداد خودرو فارما

تلفن شبانه روزی: ۰۲۱-۸۸۸۶۲۰۸۵

FarmaSOS.com

For vehicles with a navigation system, refer to the “Navigation System Owner’s Manual” for information regarding the equipment listed below.

- Navigation system
- Audio/video system
- Lexus parking assist-sensor
- Lexus parking assist moni-

What to do if... (Troubleshooting)

If you have a problem, check the following before contacting any authorized Lexus dealer or repairer, or another duly qualified and equipped professional.

The doors cannot be locked, unlocked, opened or closed



You lose your keys

- If you lose your mechanical keys, new genuine mechanical keys can be made by any authorized Lexus dealer or repairer, or another duly qualified and equipped professional. (→P. 114)
- If you lose your electronic keys, the risk of vehicle theft increases significantly. Contact any authorized Lexus dealer or repairer, or another duly qualified and equipped professional immediately. (→P. 117)



The doors cannot be locked or unlocked

- Is the electronic key battery weak or depleted? (→P. 441)
- Is the engine switch in IGNITION ON mode?
When locking the doors, turn the engine switch off. (→P. 191)
- Is the electronic key left inside the vehicle?
When locking the doors, make sure that you have the electronic key on your person.
- The function may not operate properly due to the condition of the radio wave. (→P. 132)



The rear door cannot be opened

- Is the child-protector lock set?
The rear door cannot be opened from inside the vehicle when the lock is set. Open the rear door from outside and then unlock the child-protector lock. (→P. 122)



The trunk lid is closed with the electronic key left inside

- The function to prevent the electronic key from being left inside the trunk will operate and you can open the trunk as usual. Take the key out from the trunk. (→P. 127)

If you think something is wrong



The engine does not start

- Did you press the engine switch while firmly depressing the brake pedal? (→P. 190)
- Is the shift lever in P? (→P. 192)
- Is the electronic key anywhere detectable inside the vehicle? (→P. 130)
- Is the steering wheel unlocked? (→P. 192)
- Is the electronic key battery weak or depleted?
In this case, the engine can be started in a temporary way. (→P. 525)
- Is the battery discharged? (→P. 527) تلفن شبانه روزی: ۰۲۱-۸۵۳۸۳۸۳۸



The shift lever cannot be shifted from P even if you depress the brake pedal

- Is the engine switch in IGNITION ON mode?
If you cannot release the shift lever by depressing the brake pedal with the engine switch in IGNITION ON mode. (→P. 523)



The steering wheel cannot be turned after the engine is stopped

- It is locked automatically to prevent theft of the vehicle. (→P. 192)



The windows do not open or close by operating the power window switches

- Is the window lock switch pressed?
The power window except for the one at the driver's seat cannot be operated if the window lock switch is pressed. (→P. 165)



The engine switch is turned off automatically

- The auto power off function will be operated if the vehicle is left in ACCESSORY or IGNITION ON mode (the engine is not running) for a period of time. (→P. 192)



A warning buzzer sounds during driving

- The seat belt reminder light is flashing
Are the driver and the front passenger wearing the seat belts? (→P. 477)
- The parking brake indicator is on
Is the parking brake released? (→P. 203)

Depending on the situation, other types of warning buzzer may also sound.
(→P. 475, 481)



An alarm is activated and the horn sounds (if equipped)

- Did anyone inside the vehicle open a door or anything move inside the vehicle during setting the alarm?
The sensor detects them and the alarm sounds. (→P. 83)

To stop the alarm, turn the engine switch to IGNITION ON mode or start the engine.



A warning buzzer sounds when leaving the vehicle

- Is the message displayed on the multi-information display?
Check the message on the multi-information display. (→P. 481)



A warning light turns on or a warning message is displayed

- When a warning light turns on or a warning message is displayed, refer to P. 475, 481.

When a problem has occurred



If you have a flat tire

- Vehicles with a spare tire
Stop the vehicle in a safe place and replace the flat tire with the spare tire. (→P. 496)
- Vehicles with an emergency tire puncture repair kit
Stop the vehicle in a safe place and repair the flat tire temporarily with the emergency tire puncture repair kit. (→P. 507)



The vehicle becomes stuck

- Try the procedure for when the vehicle becomes stuck in mud, dirt, or snow. (→P. 534)

Alphabetical index

A

A/C	374	Airbags	41
Air conditioning filter	439	Airbag manual on-off system	52
Automatic air conditioning		Airbag operating conditions ..	47
system	374	Airbag precautions for	
Blower customization	381	your child	43
AAC disc	317	Correct driving posture	34
ABS (Anti-lock Brake System) ..	270	Curtain shield airbag operating	
Function	270	conditions	47
Warning light	476	Curtain shield airbag	
Accent color	102	precautions	45
Air conditioning filter	439	General airbag precautions ...	43
Air conditioning system	374	Locations of airbags	41
Air conditioning filter	439	Modification and disposal of	
Automatic air conditioning		airbags	46
system	374	Side airbag operating	
Blower customization	381	conditions	47
		Side airbag precautions	43
		Side and curtain shield airbags	
		operating conditions	47
		Side and curtain shield airbags	
		precautions	43
		SRS airbags	41
		SRS warning light	475
		Airbag manual on-off system	52
		Alarm	83
		Anchor brackets	68
		Antennas (smart entry &	
		start system)	130

Anti-lock Brake System (ABS).....270	B
Function.....270	Back-up light
Warning light.....476	Replacing light bulb..... 457
Approach warning232	Wattage..... 546
Armrest.....398	Battery 420
Assist grips400	Battery checking..... 420
Audio input.....299	If the vehicle has discharged
Audio system.....292	battery..... 527
Audio CD player317	Preparing and checking
Audio input.....299	before winter 286
AUX port/	Warning light..... 475
USB port299	Blind Spot Monitor (BSM) 285
Bluetooth® audio341	Blower customization..... 381
iPod.....324	Bluetooth®
Optimal use.....307	Audio system 341
Portable music player332	Hands-free system
Radio315	(for cellular phone)..... 343
Steering wheel audio switch.....298	Bottle holders 391
USB memory.....327	Brake
Automatic headlight leveling	Fluid..... 543
system206	Parking brake..... 203
Warning light.....476	Warning light..... 475
Automatic High Beam207	Brake assist 270
Automatic light control system 204	Break-in tips 175
AUX port.....299	Brightness control
Average fuel economy101	Instrument panel light control 98
Average vehicle speed.....101	BSM (Blind Spot Monitor)..... 285

C

- Card key112
- Care402, 406
 - Aluminum wheels.....403
 - Exterior402
 - Interior406
 - Seat belts.....407
- Cargo hooks393
- CD player317
- Chains.....287
- Child restraint system.....59
 - Baby seats, definition60
 - Baby seats, installation69
 - Child seats, definition60
 - Child seats, installation.....69
 - Installing CRS with ISOFIX
 - rigid anchors.....72
 - Installing CRS with seat belts 69
 - Installing CRS with top strap 73
 - Junior seats, definition.....60
 - Junior seats, installation71
- Child safety58
 - Airbag precautions.....43
 - Battery precautions.....423, 530
 - Child restraint system.....59
 - How your child should
 - wear the seat belt.....38
 - Installing child restraints68
 - Moon roof precautions..... 171
 - Power window lock switch.. 165
 - Power window precautions.. 167
 - Rear door child-protectors... 122
 - Removed electronic key
 - battery precautions 443
 - Seat belt precautions 40
 - Seat heater precautions 386
 - Trunk precautions 128
- Child-protectors 122
- Cleaning..... 402, 406
 - Aluminum wheels..... 403
 - Exterior 402
 - Interior 406
 - Seat belts..... 407
- Clock 396
- Coat hooks..... 400
- Condenser 420
- Console box..... 390
- Cooling system 419
 - Engine overheating..... 531
- Cruise control
 - Cruise control 223
 - Dynamic radar cruise control 227
- Cup holders..... 391
- Current fuel consumption..... 101
- Curtain shield airbags 41
- Customizable features 550

D

- DAB (Digital Audio Broadcast) 315
- Daytime running light system ..205
- Defogger
- Front windshield380
 - Outside rear view mirrors380
 - Rear window380
- Differential543
- Digital Audio Broadcast (DAB) 315
- Dimensions536
- Display
- Drive information101
 - Dynamic radar cruise control 227
 - LDA (Lane Departure Alert) 243
 - Multi-information display100
 - Warning message481
- Distance102
- Do-it-yourself maintenance411
- Door courtesy lights
- Location387
 - Wattage546
- Door lock
- Doors118
 - Smart entry & start system ...130
 - Wireless remote control112
- Doors 118
- Automatic door locking and unlocking system 122
 - Door glasses 165
 - Door lock 118
 - Open door warning buzzer .. 119
 - Open door warning light 477
 - Outside rear view mirrors 161
 - Rear door child-protector 122
- Drive information 101
- Drive info 1/Drive info 2 102
- Driver's and front passenger's seat belt reminder light 477
- Driver's seat position memory . 149
- Driving 174
- Break-in tips 175
 - Correct driving posture 34
 - Driving mode select switch . 268
 - Procedures 174
 - Winter drive tips 286
- Dynamic radar cruise control ... 227

E

- E-mail351
- Eco drive mode268
- Eco Driving Indicator105
- Eco Driving Indicator Light102
- Elapsed time101
- Electric Power Steering (EPS) ..270
- Function270
- Warning light476
- Electronic key112
- Battery-saving function131
- If the electronic key does not operate properly524
- Replacing the battery441
- Emergency, in case of
- If the electronic key does not operate properly524
- If the engine will not start....521
- If the shift lever cannot be shifted from P.....523
- If the vehicle battery is discharged527
- If the warning buzzer sounds475
- If the warning light turns on.475
- If the warning message is displayed481
- If you have a flat tire496, 507
- If you think something is wrong473
- If your vehicle becomes stuck534
- If your vehicle has to be stopped in an emergency467
- If your vehicle needs to be towed468
- If your vehicle overheats531
- Emergency brake signal 271
- Emergency flashers 466
- Emergency tire puncture repair kit 507
- Engine..... 538
- Accessory mode..... 191
- Compartment 415
- Engine switch 190
- Hood 413
- How to start the engine 190
- Identification number 537
- If the engine will not start.... 521
- Ignition switch (engine switch) . 190
- Overheating 531
- Engine coolant..... 419
- Capacity 541
- Checking 419
- Preparing and checking before winter 286
- Engine coolant temperature gauge 95
- Engine immobilizer system 77
- Engine oil 416
- Capacity 539
- Checking 416
- Preparing and checking before winter 286
- Engine switch 190
- EPS (Electric Power Steering) . 270
- Function 270
- Warning light..... 476

F

- First-aid kit storage belt393
- Flat tire
 Vehicles with a spare tire496
 Vehicles with emergency
 tire puncture repair kit.....507
- Floor mats.....32
- Fluid
 Automatic transmission542
 Brake543
 Washer.....424
- Fog lights.....211
 Replacing light bulbs...450, 462
 Switch.....211
 Wattage.....546
- Follow me home system.....205
- Footwell light387
 Wattage.....546
- Front fog lights.....211
 Replacing light bulbs...450, 462
 Switch.....211
 Wattage.....546
- Front personal lights.....388
 Wattage.....546
- Front position lights204
 Light switch204
 Replacing light bulbs.....462
- Front seats..... 145
 Adjustment..... 145
 Cleaning..... 406
 Correct driving posture..... 34
 Driving position memory..... 149
 Head restraints 154
 Power easy access system.... 151
 Seat heaters 387
 Seat position memory 149
 Seat ventilators 387
- Front turn signal lights 201
 Replacing light bulbs ... 452, 454
 Turn signal lever..... 201
 Wattage..... 546
- Fuel..... 219
 Capacity 538
 Fuel gauge..... 95
 Fuel pump shut off system... 474
 Information..... 547
 Refueling 219
 Type 219, 538
 Warning light..... 477
- Fuel consumption
 Average fuel economy..... 101
 Current fuel consumption ... 101
- Fuel filler door..... 219
 If the fuel filler door
 cannot be opened..... 221
 Refueling 219
- Fuel gauge 95
- Fuel pump shut off system 474
- Fuses..... 444

G		I	
Gauges.....	95	Identification	
Gear positions.....	200	Engine.....	537
Glove box.....	390	Vehicle.....	537
Glove box light.....	390	Ignition switch (engine switch) 190	
		Illuminated entry system.....	388
H		Indicators.....	92
Hands-free system		Initialization	
(for cellular phone).....	343	Moon roof.....	170
Head restraints.....	154	Multi-information display....	102
Headlight cleaner.....	213	Power windows.....	166
Headlights.....	204	Tire pressure warning	
Automatic High Beam		system.....	426
system.....	207	Inside door handle lights.....	387
Discharge headlights		Inside rear view mirror.....	159
precautions.....	463	Instrument panel light control ...	98
Follow me home system.....	205	Interior lights.....	388
Light switch.....	204	Wattage.....	546
Replacing light bulbs.....	462	Intrusion sensor and tilt sensor... 86	
Wattage.....	546	ISOFIX rigid anchors.....	68
Heaters.....	374	J	
Air conditioning system.....	374	Jack	
Heated steering wheel.....	386	Positioning the jack.....	414
Outside rear view mirrors.....	380	Vehicle-equipped jack .	497, 508
Seat heaters.....	387	Jack handle.....	497, 508
Hill-start assist control.....	270	Jam protection function	
Hood.....	413	Moon roof.....	169
Open.....	413	Power window.....	166
Pop Up Hood.....	54		
Hooks			
Cargo hooks.....	393		
Coat hooks.....	400		
Retaining hooks (floor mat) ...	32		
Horn.....	158		

K

- Keyless entry
 - Smart entry & start
 - system.....118, 125
 - Wireless remote control 118, 125
- Keys.....112
 - Battery-Saving Function.....131
 - Electronic key112
 - Engine switch190
 - If the electronic key does not
 - operate properly524
 - Key number plate112
 - Keyless entry118, 125
 - Mechanical key113
 - Replacing the battery441
 - Warning buzzer119
 - Wireless remote control.....112
- Knee airbags41

L

- Lane Departure Alert (LDA).... 242
- Language
 - (multi-information display).... 102
- LDA (Lane Departure Alert).... 242
- Lever
 - Auxiliary catch lever 413
 - Hood lock release lever 413
 - Shift lever 195
 - Tilt and telescopic steering
 - lock release lever..... 157
 - Turn signal lever..... 201
 - Wiper lever 213
- Lexus Display Audio system.... 292
- Lexus Display Audio controller 294
- Lexus parking assist-sensor..... 249
- License plate lights..... 204
 - Light switch 204
 - Replacing light bulbs 462
- Light bulbs
 - Replacing 450
 - Wattage..... 546

FarmaSOS.com

Lights

Automatic High Beam system.....	207
Fog light switch	211
Follow me home system	205
Headlight switch.....	204
Illuminated entry system	388
Interior lights	388
Interior lights list	387
Personal lights	388
Replacing light bulbs.....	450
Trunk light.....	127
Turn signal lever.....	201
Vanity lights	396
Wattage.....	546
Lock steering column	192
Low profile tire	428
Luggage security system	126
Luggage under tray.....	395

M

Maintenance

Do-it-yourself maintenance .	411
Maintenance data.....	536
Maintenance requirements...	409
Malfunction indicator lamp	475
Master warning light	477

Meter

Changing the display	97
Indicators	92
Instrument panel light control	98
Meters	95
Multi-information display....	100
Warning lights	91

Mirrors

Inside rear view mirror	159
Outside rear view mirror defoggers	380
Outside rear view mirrors	161
Vanity mirrors.....	396

FarmaSOS.com

MirrorLink™367	N
MMS (Multimedia messaging service).....351	Navigation system* 102
Moon roof.....168	Needle..... 102
Door lock linked moon roof operation.....169	O
Jam protection function169	Odometer 95
Operation168	Oil
MP3 disc.....317	Differential oil 543
Multi-information display100	Engine oil..... 539
Audio system-linked.....100	Opener
Drive information101	Hood 413
Dynamic radar cruise control227	Trunk 125
LDA (Lane Departure Alert) 243	Outer foot lights
Navigation system-linked.....100	Location 387
Settings102	Replacing light bulbs 458
Switching the display101	Wattage 546
Warning message.....481	Outside rear view mirrors..... 161
	Adjusting and folding 161
	BSM (Blind Spot Monitor) 285
	Linked mirror function
	when reversing 163
	Mirror position memory 149
	Outside rear view mirror defoggers 380
	Outside temperature 95
	Overheating 531

*: For vehicles with a navigation system, refer to the “Navigation System Owner’s Manual”.

P	R
<ul style="list-style-type: none"> Paddle shift switches197 Parking assist sensors249 Parking brake203 PCS <ul style="list-style-type: none"> (Pre-Crash Safety system)276 Function.....276 PCS OFF switch277 Warning light.....476 Personal lights388 <ul style="list-style-type: none"> Wattage.....546 Pollen removal mode.....380 Pop-up display.....102 Pop Up Hood.....54 Power easy access system151 Power outlet397 Power steering (Electric power steering system)270 <ul style="list-style-type: none"> Warning light.....476 Power windows165 <ul style="list-style-type: none"> Door lock linked window operation.....167 Jam protection function166 Operation165 Window lock switch165 Pre-Crash Safety system (PCS).276 <ul style="list-style-type: none"> Function.....276 PCS OFF switch277 Warning light.....476 	<ul style="list-style-type: none"> Radar cruise control (dynamic radar cruise control) 227 Radiator 420 Radio 315 Rear Crossing Traffic Alert..... 285 Rear fog light..... 211 <ul style="list-style-type: none"> Replacing light bulb..... 462 Switch 211 Rear passengers' seat belt reminder lights 477 Rear seat 147 <ul style="list-style-type: none"> Fold down the seatback 147 Luggage security system 126 Rear personal lights 388 <ul style="list-style-type: none"> Wattage..... 546 Rear sunshade..... 398 <ul style="list-style-type: none"> Operation 398 Reverse operation feature 398 Rear turn signal lights..... 201 <ul style="list-style-type: none"> Replacing light bulbs 455 Turn signal lever..... 201 Wattage..... 546 Rear view mirror <ul style="list-style-type: none"> Inside rear view mirror 159 Outside rear view mirrors 161

Rear view monitor system.....	257	S	
Rear window defogger	380	Seat belt reminder light	477
Refueling	219	Seat belts.....	36
Capacity	538	Adjusting the seat belt	37
Fuel types	538	Child restraint system	
If the fuel filler door cannot		installation	69
be opened	221	Cleaning and maintaining	
Opening the fuel tank cap.....	221	the seat belt.....	407
Remote Touch*		Emergency Locking	
Replacing		Retractor (ELR).....	38
Electronic key battery	441	How to wear your seat belt	36
Fuses	444	How your child should wear	
Light bulbs	448	the seat belt.....	38
Tires.....	496	Pregnant women, proper	
Rev indicator	102	seat belt use	39
Rev peak	102	Reminder light and buzzer...	477
		Seat belt pretensioners	37
		SRS warning light.....	475
		Seat heaters.....	387
		Seat position memory	149
		Seat ventilators	387

*: For vehicles with a navigation system, refer to the “Navigation System Owner’s Manual”.

- | | |
|---|--|
| <ul style="list-style-type: none"> Seats, Front.....145 <ul style="list-style-type: none"> Adjustment145 Adjustment precautions146 Child seats/child restraint <ul style="list-style-type: none"> system installation.....68 Cleaning.....406 Driving position memory149 Head restraints154 Power easy access system151 Properly sitting in the seat34 Seat heaters387 Seat position memory149 Seat ventilators387 Seats, Rear147 <ul style="list-style-type: none"> Fold down the seatback147 Luggage security system126 | <ul style="list-style-type: none"> Sensor <ul style="list-style-type: none"> Automatic headlight system 205 Automatic High Beam system... <ul style="list-style-type: none"> 210 Inside rear view mirror 160 Intrusion sensor and tilt sensor .. <ul style="list-style-type: none"> 86 LDA (Lane Departure Alert) 242 Lexus parking assist-sensor. 249 Radar sensor 235, 277, 289 Rain-sensing windshield <ul style="list-style-type: none"> wipers 217 Service reminder indicators..... 90 Shift lever 195 <ul style="list-style-type: none"> Automatic transmission 195 If the shift lever cannot be <ul style="list-style-type: none"> shifted from P 523 Shift lock system 523 Shift position and gear position.. 95 Side airbags 41 |
|---|--|

FarmaSOS.com

- Side mirrors161
 Adjusting and folding161
 BSM (Blind spot monitor)....285
 Linked mirror function when
 reversing163
 Mirror position memory149
 Side turn signal lights201
 Replacing light bulbs462
 Turn signal lever201
 Slip indicator476
 Smart entry & start system130
 Antenna location130
 Entry functions118, 125
 Starting the engine190
 SMS (Short message service)....351
 Snow mode196
 Snow tires288
 Spare tire496
 Inflation pressure544
 Storage location497
 Spark plug541
 Specifications536
 Speech command system372
 Speedometer 95
 Speed indicator 102
 Sport mode 268
 Steering lock 192
 Column lock release 192
 Steering wheel 157
 Adjustment 157
 Audio switches 298
 Heated steering wheel 386
 Power easy access system 151
 Steering wheel position
 memory 149
 Stop lights
 Emergency brake signal 271
 Replacing light bulbs 462
 Storage feature 389
 Stuck
 If the vehicle becomes stuck 534
 Sun visors 396
 Sun shade
 Rear 398
 Roof 169

- switch settings102
- Switches
 - Audio remote control
 - switches298
 - Automatic High Beam switch
 - 207
 - BSM (Blind spot monitor)
 - switch285
 - Cruise control switch....223, 227
 - Door lock switches121
 - Driving mode select switch ..268
 - Driving position memory
 - switches149
 - Emergency flashers switch ...466
 - Engine switch190
 - Fog light switch211
 - Heated steering wheel switch
 - 386
 - Ignition switch190
 - LDA (Lane Departure
 - Alert) switch243
 - Lexus parking assist-sensor
 - switch249
 - Light switch204
 - Meter control switches101
 - Moon roof switches168
 - Outside rear view mirror
 - switches161
 - Paddle shift switches197
 - PCS OFF switch277
 - Power door lock switch121
 - Power window switches 165
 - Rear sunshade switch..... 398
 - Rear window and outside rear
 - view mirror defoggers
 - switch 380
 - Seat heater switches 387
 - Seat ventilator switches 387
 - Snow mode switch..... 196
 - Talk switch 354
 - Telephone switches..... 354
 - Tilt and telescopic steering
 - control switch 157
 - Tire pressure warning reset
 - switch 427
 - Trunk opener switch 125
 - Trunk opener main switch ... 126
 - Vehicle-to-vehicle distance
 - button..... 230
 - VSC OFF switch..... 272
 - Window lock switch 165
 - Windshield wiper de-icer
 - switch 381
 - Windshield wipers
 - and washer switch 213

T

Tachometer.....	95	Tire pressure warning system...	426
Tail lights	204	Function	426
Light switch.....	204	Initializing.....	426
Replacing light bulbs.....	462	Installing tire pressure warning	
Talk switch	354	valves and transmitters.....	426
Telephone switches	354	Registering ID codes	427
Theft deterrent system		Tire pressure warning reset	
Alarm.....	83	switch	427
Double locking system	82	Warning light.....	477
Engine immobilizer system	77	Tires.....	425
Intrusion sensor and tilt sensor ...	86	Chains	287
Tire inflation pressure	435	Checking.....	425
Maintenance data.....	544	Emergency tire puncture	
Tire inflation pressure display		repair kit	507
function	426	If you have a flat tire....	496, 507
Warning light.....	477	Inflation pressure	544
		Replacing	496
		Rotating tires.....	425
		Size.....	544
		Snow tires	288
		Spare tire.....	496
		Tire pressure warning system	
		426	
		Warning light.....	477

Tools.....	497, 508
Top strap.....	73
Towing	468
Emergency towing.....	468
Towing capacity	536
Towing eyelet	469
Trailer towing	182
Traction Control (TRC).....	270
Trailer towing.....	182
Transmission	195
Automatic transmission	195
Driving mode select switch ..	268
If the shift lever cannot be shifted from P.....	523
M mode.....	198
Paddle shift switches	197
TRC (Traction Control).....	270
Trip meters	95
Trunk	125
Luggage security system	126
Smart entry & start system ...	125
Trunk features.....	393
Trunk grip.....	126
Trunk light.....	127
Trunk opener main switch....	126
Trunk opener switch	125
Wireless remote control.....	126
Trunk light.....	127
Wattage.....	546
Turn signal lights.....	201
Replacing light bulbs	452, 454, 455, 462
Turn signal lever.....	201
Wattage.....	546

U

Units	102
USB device.....	327, 370
Connecting.....	299
USB audio.....	327
USB photo	370
USB video.....	327
USB port.....	299

V

Vanity lights	396
Vanity lights	396
Wattage.....	546
Vanity mirrors	396
VDIM (Vehicle Dynamics Integrated Management)	271
Vehicle identification number ..	537
Vehicle Stability Control تلفن مشاوره (VSC).....	270
Ventilators (seat ventilators)	387
VSC (Vehicle Stability Control).....	270

W

- | | |
|---|---|
| <ul style="list-style-type: none"> Warning buzzers <ul style="list-style-type: none"> Approach warning232 Brake system475 Downshifting200 Driver's and front <ul style="list-style-type: none"> passenger's seat belt <ul style="list-style-type: none"> reminder477 Lexus parking assist-sensor ..249 Open door477 Pre-crash braking.....276 Rear passengers' seat belt <ul style="list-style-type: none"> reminder477 Warning lights91 <ul style="list-style-type: none"> ABS476 Automatic headlight leveling <ul style="list-style-type: none"> system.....476 Brake system475 Charging system475 Driver's and front <ul style="list-style-type: none"> passenger's seat belt <ul style="list-style-type: none"> reminder light477 Electric power steering <ul style="list-style-type: none"> system.....476 Low fuel level.....477 Malfunction indicator lamp ..475 Master warning light477 Open door477 Pre-crash safety system476 Rear passengers' seat belt <ul style="list-style-type: none"> reminder lights477 Slip indicator476 SRS475 Tire pressure477 | <ul style="list-style-type: none"> Warning messages 481 Warning reflector storage belt.. 395 Washer..... 213 <ul style="list-style-type: none"> Checking 424 Preparing and checking <ul style="list-style-type: none"> before winter 286 Switch 213 Washing and waxing 402 Weight 536 Wheels 437 <ul style="list-style-type: none"> Replacing 437 Size 544 Window glasses 165 Window lock switch 165 Windows..... 165 <ul style="list-style-type: none"> Power windows..... 165 Rear window defogger..... 380 Windshield wiper de-icer 381 Windshield wipers..... 213 <ul style="list-style-type: none"> Intermittent windshield wipers <ul style="list-style-type: none"> with interval adjuster 213 Rain-sensing windshield <ul style="list-style-type: none"> wipers 215 Winter driving tips..... 286 Wireless remote control..... 112 <ul style="list-style-type: none"> Battery-Saving Function..... 131 Locking/Unlocking..... 118, 125 Replacing the battery 441 WMA disc 317 |
|---|---|

GAS STATION INFORMATION		
Auxiliary catch lever	Trunk opener	Fuel filler door
P. 413	P. 125	P. 219
Hood lock release lever	Tire inflation pressure	
P. 413	P. 544	
Fuel tank capacity (Reference)	66 L (17.4 gal., 14.5 Imp. gal.)	
Fuel type	EU area: Unleaded gasoline conforming to European standard EN228 only Except EU area: Unleaded gasoline only P. 219, 538	
Cold tire inflation pressure	P. 544	
Engine oil capacity (Drain and refill — reference)	L (qt., Imp. qt.) With filter 6.2 (6.6, 5.5) Without filter 5.9 (6.2, 5.2)	
Engine oil type	“Toyota Genuine Motor Oil” or equivalent Oil grade: 0W-20, 5W-20, 5W-30 and 10W-30: API grade SL “Energy-Conserving”, SM “Energy-Conserving” or SN “Resource-Conserving”; or ILSAC multigrade engine oil 15W-40 and 20W-50: API grade SL, SM or SN multigrade engine oil P. 539	