

Foreword

Welcome to the growing family of new NISSAN owners. This vehicle has been delivered to you with confidence. It has been produced using the latest techniques and strict quality control.

This manual was prepared to help you understand the operation and maintenance of your vehicle so that you may enjoy many kilometers (miles) of driving pleasure. Please read through this manual before operating your vehicle.

A separate Warranty Information & Maintenance Booklet explains details about the warranties covering your vehicle.

Your NISSAN dealer knows your vehicle best. When you require any service or have any questions, we will be glad to assist you with the extensive resources available for you.

IMPORTANT SAFETY INFORMATION

Reminders for safety!

Follow these important driving rules to help ensure a safe and complete trip for you and your passengers!

- **NEVER drive under the influence of alcohol or drugs.**
- **ALWAYS observe posted speed limits and never drive too fast for conditions.**
- **ALWAYS use your seat belts and appropriate child restraint systems. Preteen children should be seated in the rear seat.**
- **ALWAYS provide information about the proper use of vehicle safety features to all occupants of the vehicle.**
- **ALWAYS review this Owner's Manual for important safety information.**

When reading the manual

This manual includes information for all options available on this model. Therefore, you may find some information that does not apply to your vehicle.

All information, specifications and illustrations in this manual are those in effect at the time of printing. NISSAN reserves the right to change specifications or designs without notice and without obligation.

MODIFICATION OF YOUR VEHICLE

This vehicle should not be modified. Modification could affect its performance, safety or durability, and may even violate governmental regulations. In addition, damage or performance problems resulting from modifications may not be covered under NISSAN warranties.

Read first — then drive safely

Before driving your vehicle, read this Owner's Manual carefully. This will ensure familiarity with controls and maintenance requirements, assisting you in the safe operation of your vehicle.

Throughout this manual we have used the symbol  followed by the word **WARNING**. This is used to indicate the presence of a hazard that could cause death or serious personal injury. To avoid or reduce the risk, the procedures must be followed precisely.

The symbol  followed by the word **CAUTION** is also used throughout this manual to indicate the presence of a hazard that could cause minor or moderate personal injury or damages to your vehicle. To avoid or reduce the risk, the procedures must be followed carefully.

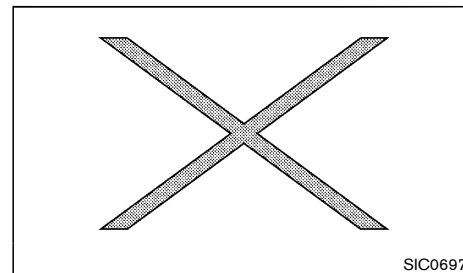

If you see this symbol, it means **“Do not do this”** or **“Do not let this happen”**.



If you see a symbol similar to these in an illustration, it means the arrow points to the front of the vehicle.



Arrows in an illustration that are similar to these indicate movement or action.



Arrows in an illustration that are similar to these call attention to an item in the illustration.



Bluetooth® is a trademark owned by Bluetooth SIG, Inc., and licensed to Visteon Corporation.

Table of Contents

Illustrated table of contents	0
Safety — seats, seat belts and supplemental restraint system	1
Instruments and controls	2
Pre-driving checks and adjustments	3
Heater and air conditioner, and audio system	4
Starting and driving	5
In case of emergency	6
Appearance and care	7
Maintenance and do-it-yourself	8
Technical information	9
Index	10

0 Illustrated table of contents

Seats seat belts and supplemental restraint system (SRS)	0-2	Meters and gauges	0-8
Exterior front	0-3	Engine compartment	0-10
Exterior rear	0-4	HR15DE engine model	0-10
Passenger compartment	0-5	HR12DE engine model	0-11
Instrument panel	0-6	K9K engine model	0-12
Left-Hand Drive (LHD) model	0-6		
Right-Hand Drive (RHD) model	0-7		

SEATS SEAT BELTS AND SUPPLEMENTAL RESTRAINT SYSTEM (SRS)

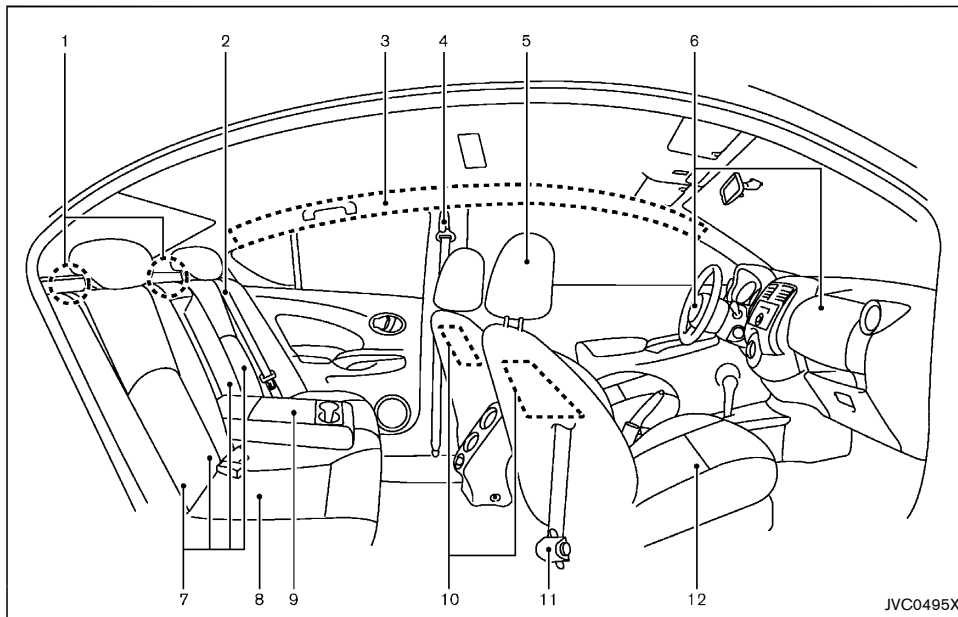

- | | |
|--|---|
| 1. Child restraint anchor points* (for top tether strap child restraint) (Page 1-12) | 8. Rear seats
— Child restraints (P.1-10) |
| 2. Rear seat belts (P.1-6) | 9. Armrest* (P.1-3) |
| 3. Supplemental curtain side-impact air bags* (P.1-18) | 10. Supplemental side-impact air bags* (P.1-18) |
| 4. Front seat belts (P.1-6) | 11. Pre-tensioner seat belt system* (P.1-26) |
| 5. Head restraints (P.1-3) | 12. Front seats (P.1-2) |
| 6. Supplemental front-impact air bags (P.1-23) | *: if equipped |
| 7. ISOFIX child restraint system* (P.1-11) | |

EXTERIOR FRONT

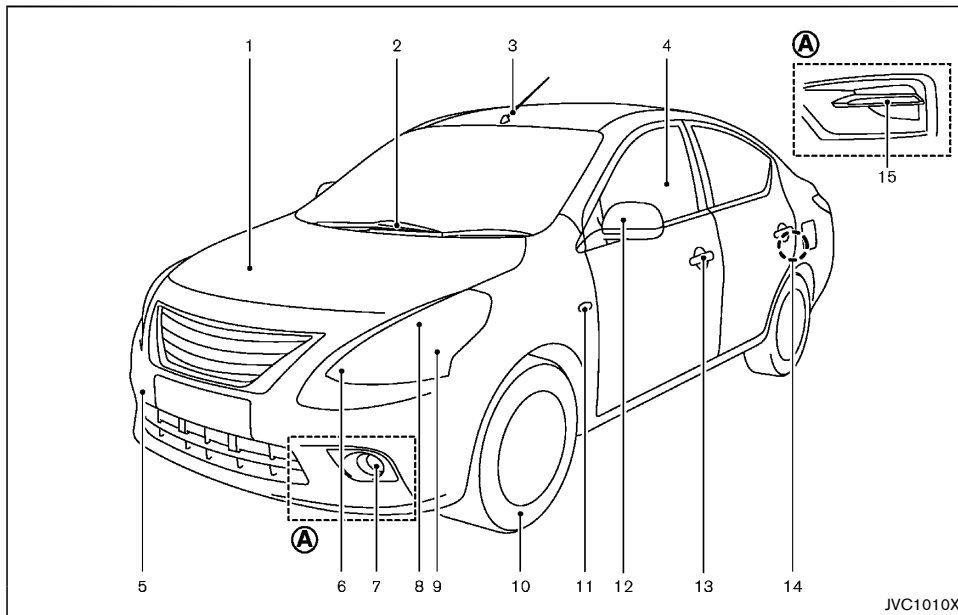

- | | |
|------------------------------------|-----------------------------|
| 1. Engine hood (P.3-18) | — Bulb replacement (P.8-26) |
| 2. Windshield | 7. Fog lights* |
| — Wiper and washer switch (P.2-21) | — Switch operation (P.2-20) |
| — Wiper replacement (P.8-19) | — Bulb replacement (P.8-26) |
| — Washer fluid (P.8-20) | 8. Headlights |
| 3. Antenna (P.4-16) | — Switch operation (P.2-18) |
| 4. Windows (P.2-23) | — Bulb replacement (P.8-26) |
| 5. Recovery hook (P.6-12) | 9. Clearance lights |
| 6. Front turn signal lights | — Switch operation (P.2-18) |
| — Switch operation (P.2-19) | — Bulb replacement (P.8-26) |

- | | |
|---|--|
| 10. Tires | — Tires and wheels (P.8-31, P.9-7) |
| — Flat tire (P.6-2) | |
| 11. Side turn signal lights | — Switch operation (P.2-19) |
| — Bulb replacement (P.8-26) | |
| 12. Outside rearview mirrors (P.3-22) | |
| 13. Doors | — Keys (P.3-2) |
| — Door locks (P.3-4) | — Remote keyless entry system* (P.3-6) |
| — Intelligent Key system* (P.3-8) | — Security system* (P.3-17) |
| 14. Child safety rear door lock (P.3-6) | |
| 15. Daytime running light* (P.2-18) | |
| *: if equipped | |

EXTERIOR REAR

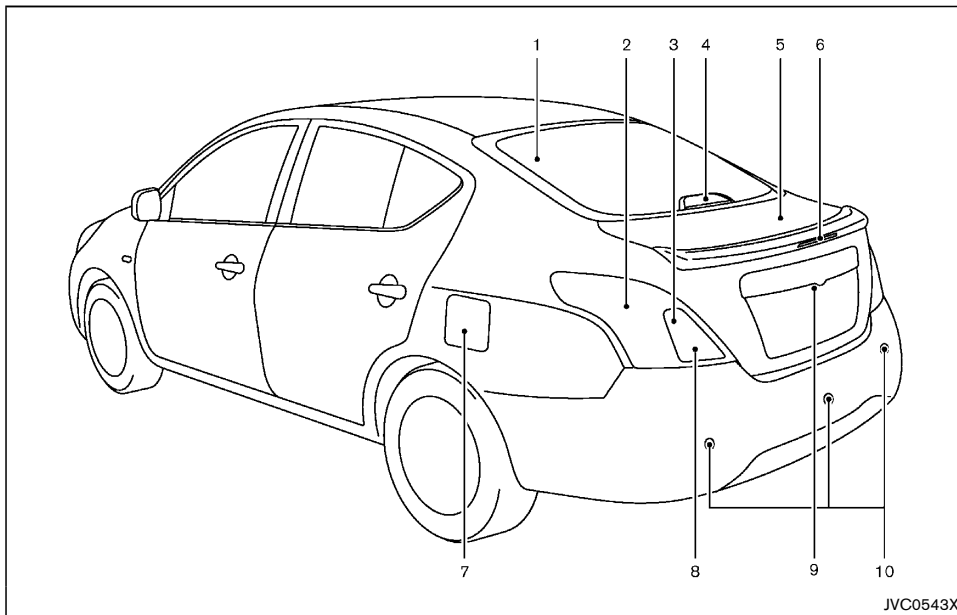

- | | |
|--|---|
| <p>1. Rear window
— Rear window defogger* (P.2-22)</p> <p>2. Stop/tail lights (P.8-27)</p> <p>3. Turn signal lights
— Switch operation (P.2-19)
— Bulb replacement (P.8-27)</p> <p>4. High-mounted stop light (model without rear spoiler) (P.8-27)</p> <p>5. Trunk
— Remote keyless entry system* (P.3-7)</p> | <p>— Trunk request switch (Intelligent Key system*) (P.3-14)</p> <p>— Opening (P.3-19)
— Trunk light* (P.2-29, P.8-27)</p> <p>6. High-mounted stop light (model with rear spoiler) (P.8-27)</p> <p>7. Fuel filler lid
— Fuel filler lid (P.3-20)
— Fuel information (P.9-4)</p> |
|--|---|

8. Reverse light/Rear fog light*
— Switch operation (P.2-20)
— Bulb replacement (P.8-27)
9. License plate light (P.8-27)
10. Sonar (parking sensor) system* (P.5-24)
- *: if equipped

PASSENGER COMPARTMENT

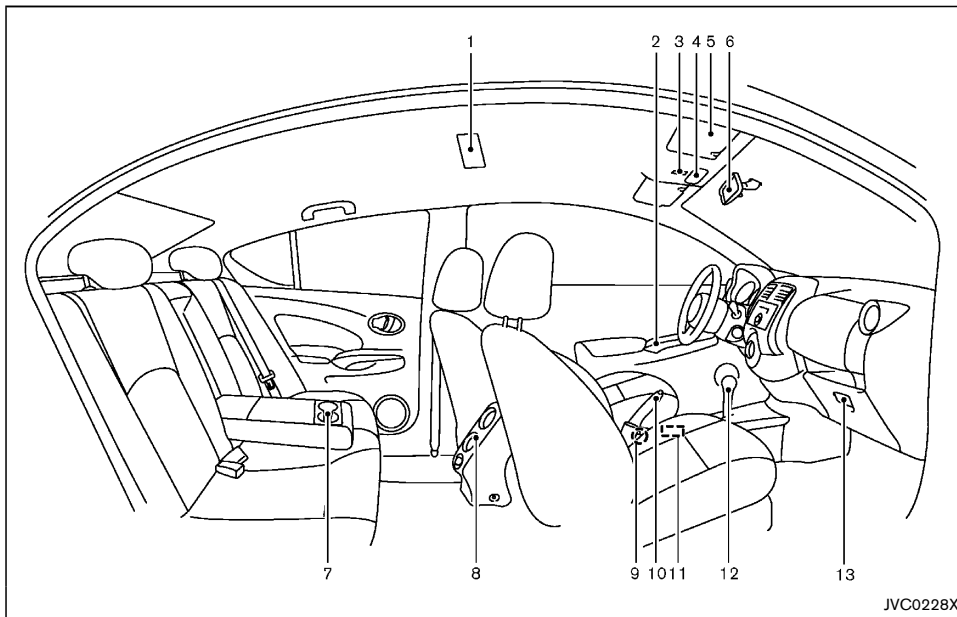

13. Glove box (P.2-27)

*: if equipped

- | | |
|------------------------------------|---|
| 1. Room light (P.2-29, P.8-27) | 8. Rear comfort fan* (P.4-9) |
| 2. Door armrest | 9. Power outlet* (P.2-26) |
| — Power window switch* (P.2-23) | 10. Parking brake (P.3-23, P.8-15) |
| — Power door lock switch* (P.3-5) | 11. Trunk lid release handle* (P.3-20) |
| 3. Microphone* (P.4-27) | 12. Shift lever |
| 4. Map lights* (P.2-29, P.8-27) | — Automatic Transmission (AT) (P.5-10) |
| 5. Sun visor (P.2-28) | — Continuously Variable Transmission (CVT) (P.5-13) |
| 6. Inside rearview mirror (P.3-21) | — Manual Transmission (MT) (P.5-16) |
| 7. Rear cup holder* (P.2-27) | |

INSTRUMENT PANEL

LEFT-HAND DRIVE (LHD) MODEL

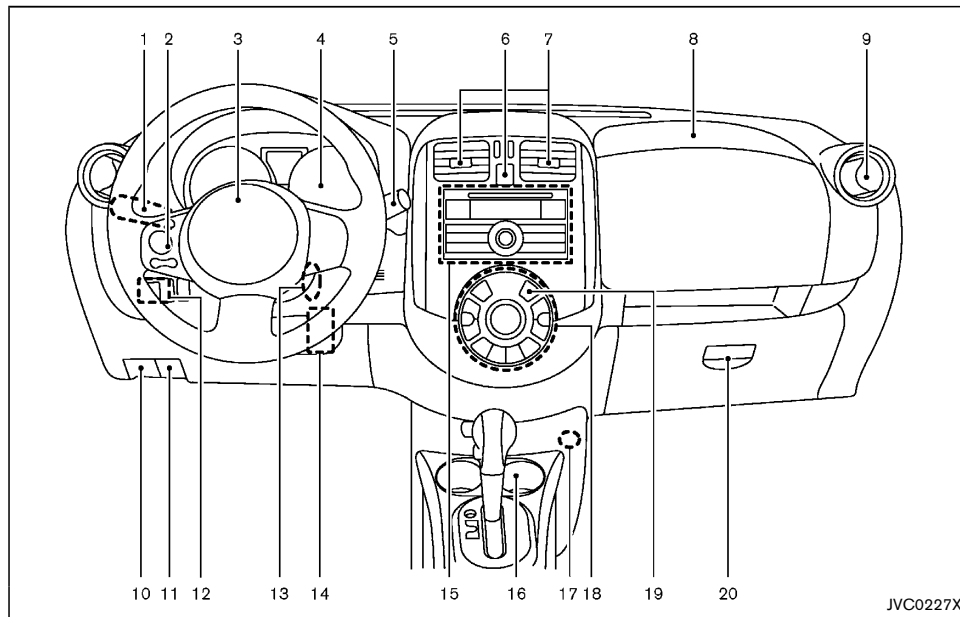

1. Headlight, fog light* and turn signal switch (P.2-18)
2. Steering-wheel-mounted controls* (P.4-26)
3. Driver's front-impact air bag/Horn (P.1-18, P.2-23)
4. Meters and gauges (P.2-4)
5. Wiper and washer switch (P.2-21)
6. Hazard indicator flasher switch (P.6-2)
7. Center ventilator (P.4-2)
8. Passenger's front-impact air bag* (P.1-18)
9. Side ventilator (P.4-2)
10. Fuel filler lid release handle (P.3-20)
11. Hood lock release handle (P.3-18)
12. Outside rearview mirror control switch* (P.3-22)
13. Ignition switch/steering lock (P.5-4)
14. Tilting steering wheel lock lever (P.3-21)
15. Audio system* (P.4-10)
16. Cup holder (P.2-27)
17. Cigarette lighter* (P.2-26)
18. Heater and air conditioner control (P.4-3)
19. Rear window defogger switch (P.2-22)
20. Glove box (P.2-27)

*: if equipped

RIGHT-HAND DRIVE (RHD) MODEL

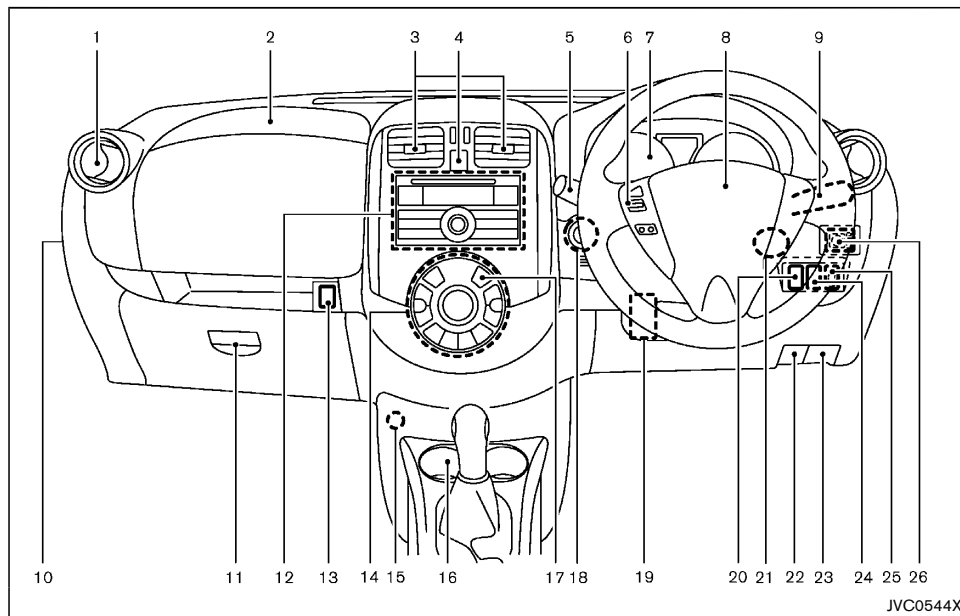

1. Side ventilator (P.4-2)
2. Passenger's front-impact air bag* (P.1-18)
3. Center ventilator (P.4-2)
4. Hazard indicator flasher switch (P.6-2)
5. Wiper and washer switch (P.2-21)
6. Steering-wheel-mounted controls* (P.4-26)
7. Meters and gauges (P.2-4)

8. Driver's front-impact air bag/Horn (P.1-18, P.2-23)
9. Headlight and turn signal switch (P.2-18)
10. Fuse box cover (P.8-25)
11. Glove box (P.2-27)
12. Audio system* (P.4-10)
13. USB/AUX connector* (P.4-24)
14. Heater and air conditioner control (P.4-3)

15. Power outlet* (P.2-26)
 16. Cup holder (P.2-27)
 17. Rear window defogger switch (P.2-22)
 18. Push-button ignition switch (model with Intelligent Key system) (P.5-5)
 19. Tilting steering wheel lock lever (P.3-21)
 20. Vehicle Dynamic Control (VDC) OFF switch* (P.5-22) (except for Australia)
 21. Ignition switch (model without Intelligent Key system)/steering lock (P.5-4)
 22. Hood lock release handle (P.3-18)
 23. Fuel filler lid release handle (P.3-20)
 24. Idling stop OFF switch* (P.5-19) or Vehicle Dynamic Control (VDC) OFF switch (P.5-22) (for Australia)
 25. Headlight aiming control switch* (P.2-19)
 26. Outside rearview mirror control switch* (P.3-22)
- *: if equipped

METERS AND GAUGES

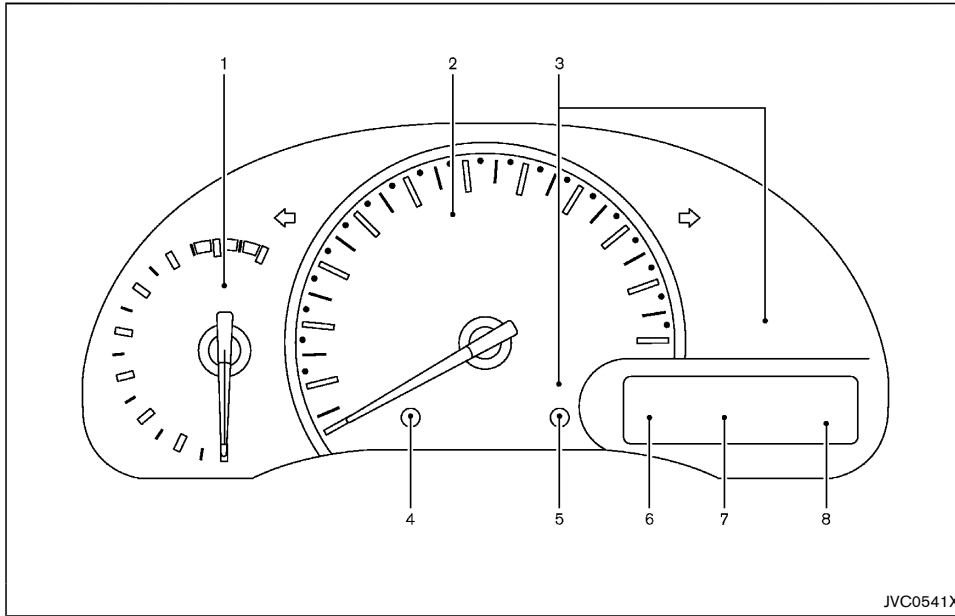

Type A

- | | |
|---|--|
| 1. Tachometer* (P.2-8) | 7. Odometer/Twin trip odometer (P.2-6)/Trip computer (P.2-7) |
| 2. Speedometer (P.2-5) | 8. Fuel gauge (P.2-9) |
| 3. Warning/indicator lights* (P.2-11) | *: if equipped |
| 4. Trip odometer reset switch/Trip computer mode switch (P.2-7) | |
| 5. Clock settings switch (P.2-25) | |
| 6. Automatic Transmission (AT)/Continuously Variable Transmission (CVT) position indicator* (P.2-9) | |

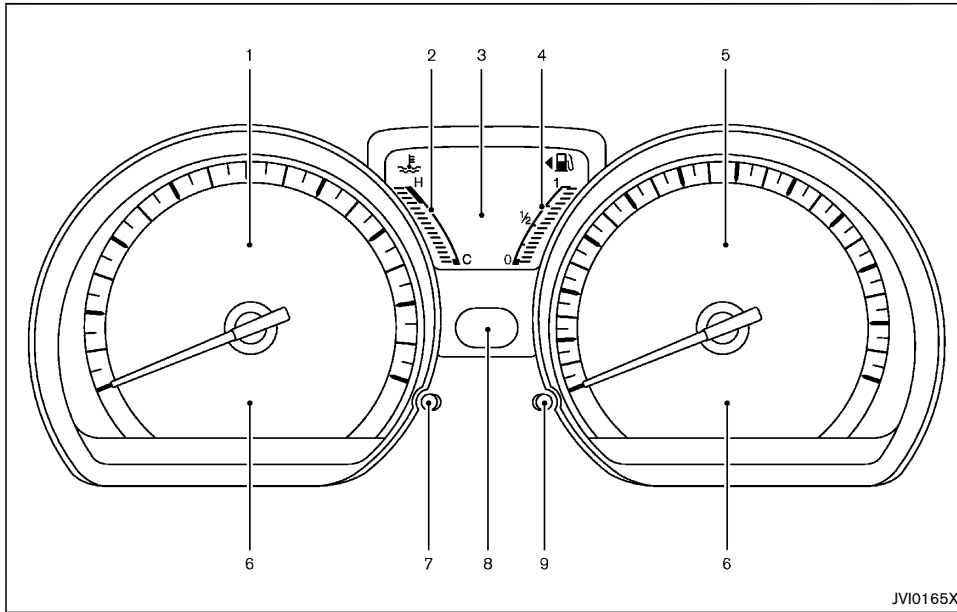

JVI0165X

Type B

- | | |
|--|---|
| <ol style="list-style-type: none"> 1. Tachometer (P.2-8) 2. Engine coolant temperature gauge (P.2-8) 3. Vehicle information display (P.2-5) <ul style="list-style-type: none"> — Odometer/Twin trip odometer (P.2-6) — Trip computer (P.2-7) — Clock (P.2-25) — Outside air temperature* (P.2-7) — Instrument brightness control display (P.2-10) | <ol style="list-style-type: none"> 4. Fuel gauge (P.2-9) 5. Speedometer (P.2-5) 6. Warning/indicator lights (P.2-11) 7. Instrument brightness control knob (P.2-10) 8. Automatic Transmission (AT)/Continuously Variable Transmission (CVT) position indicator* (P.2-9) 9. Trip odometer reset switch/Trip computer mode switch (P.2-6) <p>*: if equipped</p> |
|--|---|

ENGINE COMPARTMENT

HR15DE ENGINE MODEL

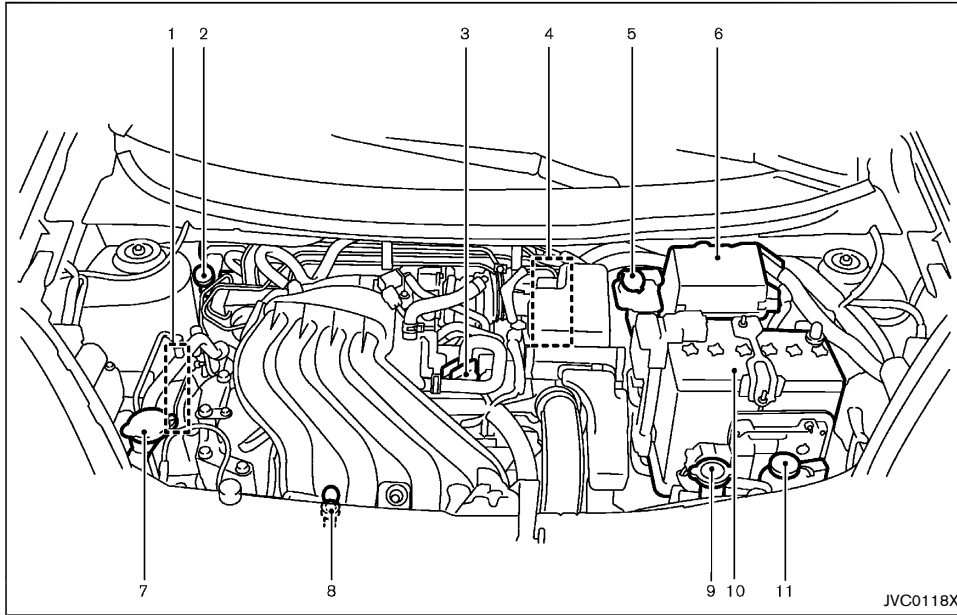

11. Engine coolant reservoir (P.8-9)
*: For Manual Transmission (MT) Model

- | | |
|---|---|
| 1. Engine drive belts (P.8-14) | — Left-Hand Drive (LHD) model |
| 2. Brake and clutch* fluid reservoir (P.8-17, P.8-17)
— Right-Hand Drive (RHD) model | 6. Fuse/fusible link box (P.8-24) |
| 3. Engine oil filler cap (P.8-10) | 7. Window washer fluid reservoir (P.8-20) |
| 4. Air cleaner (P.8-18) | 8. Engine oil dipstick (P.8-10) |
| 5. Brake and clutch* fluid reservoir (P.8-17, P.8-17) | 9. Radiator cap (P.8-8)
— Vehicle overheat (P.6-10) |
| | 10. Battery (P.5-28, P.8-21)
— Jump starting (P.6-8) |

HR12DE ENGINE MODEL

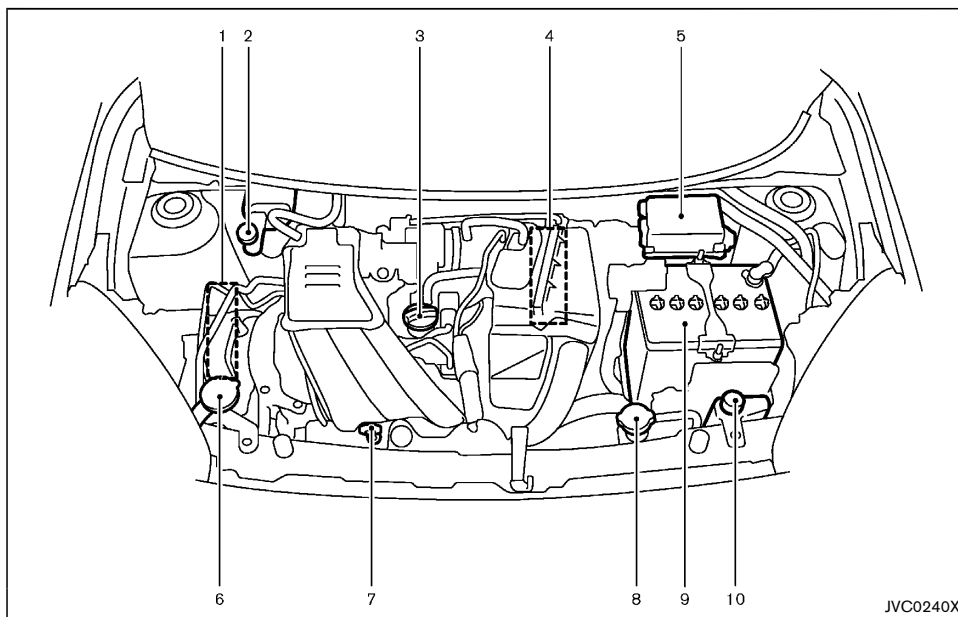

- | | |
|--|--|
| 1. Engine drive belts (P.8-14) | 8. Radiator cap (P.8-8)
— Vehicle overheat (P.6-10) |
| 2. Brake and clutch* fluid reservoir (P.8-17,
P.8-17) | 9. Battery (P.5-28, P.8-21)
— Jump starting (P.6-8) |
| 3. Engine oil filler cap (P.8-10) | 10. Engine coolant reservoir (P.8-9) |
| 4. Air cleaner (P.8-18) | |
| 5. Fuse/fusible link box (P.8-24) | |
| 6. Window washer fluid reservoir (P.8-20) | |
| 7. Engine oil dipstick (P.8-10) | |
- *: For Manual Transmission (MT) Model

K9K ENGINE MODEL

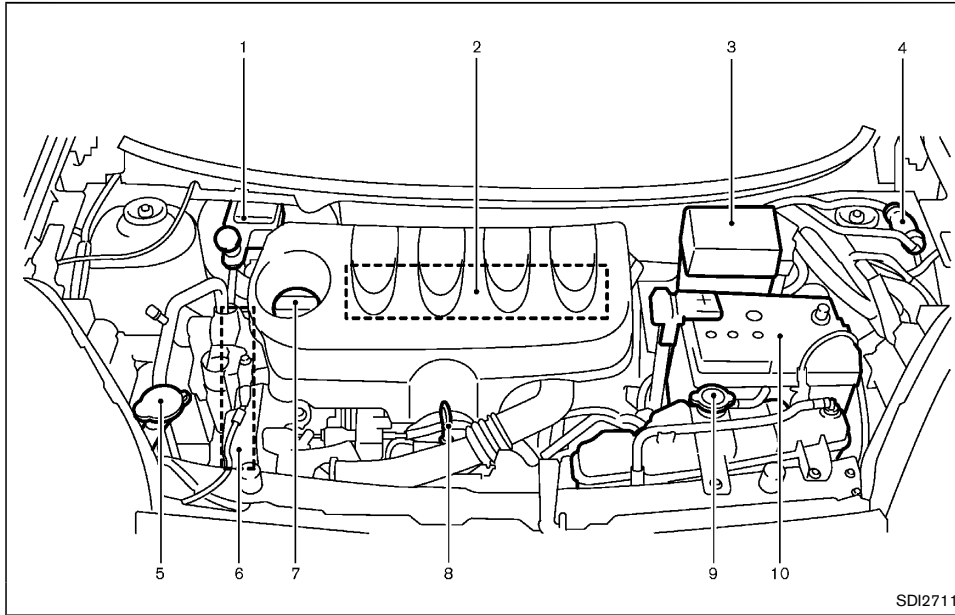

- | | |
|--|--|
| 1. Brake and clutch fluid reservoir (P.8-17, P.8-17) | 9. Engine coolant reservoir (P.8-9)
— Vehicle overheat (P.6-10) |
| 2. Air cleaner (P.8-18) | 10. Battery (P.5-28, P.8-21)
— Jump starting (P.6-8) |
| 3. Fuse/fusible link box (P.8-24) | |
| 4. Priming pump (P.8-13) | |
| 5. Window washer fluid reservoir (P.8-20) | |
| 6. Engine drive belts (P.8-14) | |
| 7. Engine oil filler cap (P.8-10) | |
| 8. Engine oil dipstick (P.8-10) | |

1 Safety — seats, seat belts and supplemental restraint system

Seats	1-2	Two-point type seat belts (if equipped)	1-9
Front seats	1-2	Center mark on seat belts	1-10
Armrest (if equipped)	1-3	Seat belt maintenance	1-10
Head restraints	1-3	Child restraints	1-10
Adjustable head restraint components	1-4	Precautions on child restraint usage	1-10
Non-adjustable head restraint components	1-4	ISOFIX child restraint system (if equipped)	1-11
Remove	1-4	Child restraint anchorage (if equipped)	1-12
Install	1-4	Child restraint installation using ISOFIX (if equipped)	1-12
Adjust	1-4	Installation of child restraint system	1-14
Seat belts	1-6	Supplemental Restraint System (SRS)	1-18
Precautions on seat belt usage	1-6	Precautions on Supplemental Restraint System (SRS)	1-18
Child safety	1-7	Supplemental air bag systems	1-22
Pregnant women	1-8	SRS air bag deployment conditions	1-23
Injured persons	1-8	Pre-tensioner seat belt system (if equipped)	1-26
Three-point type seat belts	1-8	Repair and replacement procedure	1-26

SEATS

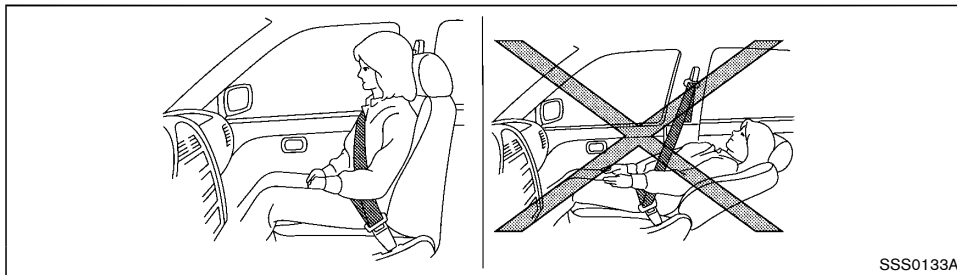

WARNING:

- Do not drive and/or ride in the vehicle with the seatback reclined. This can be dangerous. The shoulder belt will not be properly against the body. In an accident, you and your passengers could be thrown into the shoulder belt and receive neck or other serious injuries. You and your passengers could also slide under the lap belt and receive serious injuries.
- For the most effective protection while the vehicle is in motion, the seatback should be upright. Always sit well back in the seat and adjust the seat belt properly. (See "Seat belts" (P.1-6).)

CAUTION:

When adjusting the seat positions, be sure not to contact any moving parts to avoid possible injuries and/or damages.

FRONT SEATS

WARNING:

Do not adjust the driver's seat while driving so that full attention may be given to vehicle operation.

Manual seat adjustment

WARNING:

After adjusting a seat, gently shake the seat to confirm that the seat is locked securely. If the seat is not locked securely, it may move suddenly and could cause the loss of control of the vehicle.

HEAD RESTRAINTS

WARNING:

Head restraints supplement the other vehicle safety systems. They may provide additional protection against injury in certain rear end collisions. Adjustable head restraints must be adjusted properly, as specified in this section. Check the adjustment after someone else uses the seat. Do not attach anything to the head restraint stalks or remove the head restraint. Do not use the seat if the head restraint has been removed. If the head restraint has been removed, reinstall and properly adjust the head restraint before an occupant uses the seating position. Failure to follow these instructions can reduce the effectiveness of the head restraint. This may increase the risk of serious injury or death in a collision.

- Your vehicle is equipped with a head restraint that may be integrated, adjustable or non-adjustable.
- Adjustable head restraints have multiple notches along the stalk to lock them in a desired adjustment position.
- The non-adjustable head restraints have single locking notch to secure them to the seat frame.
- Proper Adjustment:
 - For the adjustable type, align the head restraint so the center of your ear is approximately level with the center of the head restraint.
 - If your ear position is still higher than the recommended alignment, place the head restraint at the highest position.
- If the head restraint has been removed, ensure that it is reinstalled and locked in place before riding in that designated seating position.

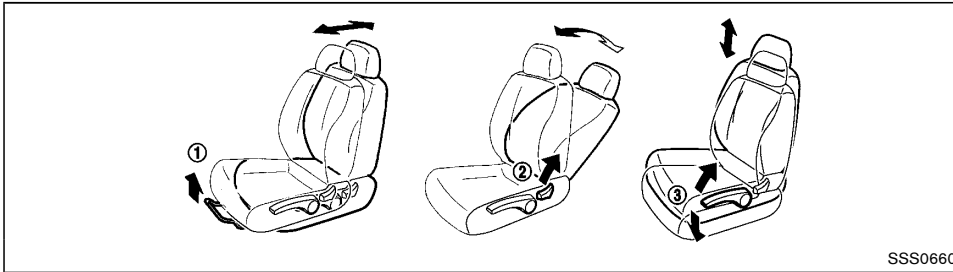

Forward and backward:

1. Pull up the adjusting lever ①.
2. Slide the seat to the desired position.
3. Release the adjusting lever to lock the seat in position.

Reclining:

1. Pull up the adjusting lever ②.
2. Tilt the seatback to the desired position.
3. Release the adjusting lever to lock the seatback in position.

The reclining feature allows the adjustment of the seatback for occupants of different sizes to help obtain the proper seat belt fit. (See "Seat belts" (P.1-6).)

The seatback may be reclined to allow occupants to rest when the vehicle is parked.

Seat lifter (if equipped):

Pull up or push down the adjusting lever ③ to adjust the seat height until the desired position is achieved.

ARMREST (if equipped)

Rear

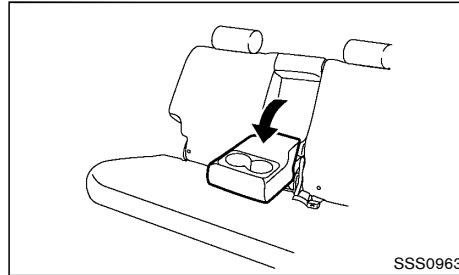

Pull the armrest down until it is horizontal.

ADJUSTABLE HEAD RESTRAINT COMPONENTS

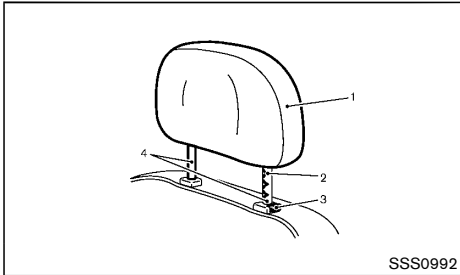

1. Removable head restraint
2. Multiple notches
3. Lock knob
4. Stalks

NON-ADJUSTABLE HEAD RESTRAINT COMPONENTS

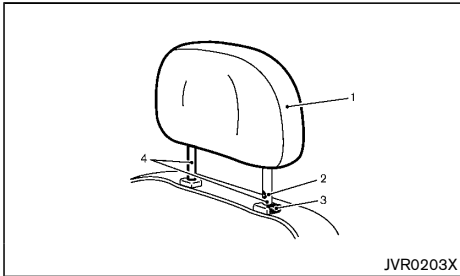

1. Removable head restraint

2. Single notch
3. Lock knob
4. Stalks

REMOVE

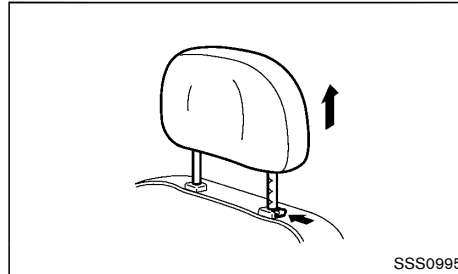

Use the following procedure to remove the adjustable head restraints.

1. Pull the head restraint up to the highest position.
2. Push and hold the lock knob.
3. Remove the head restraint from the seat.
4. Store the head restraint properly in a secure place so it is not loose in the vehicle.
5. Reinstall and properly adjust the head restraint before an occupant uses the seating position.

INSTALL

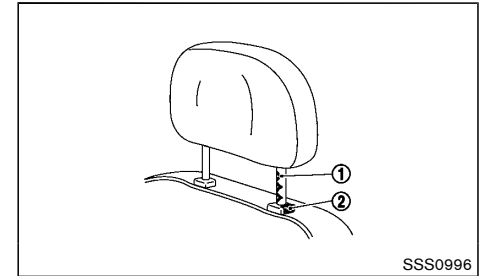

1. Align the head restraint stalks with the holes in the seat. Make sure that the head restraint is facing the correct direction. The stalk with the adjustment notch ① must be installed in the hole with the lock knob ②.
2. Push and hold the lock knob and push the head restraint down.
3. Properly adjust the head restraint before an occupant uses the seating position.

ADJUST

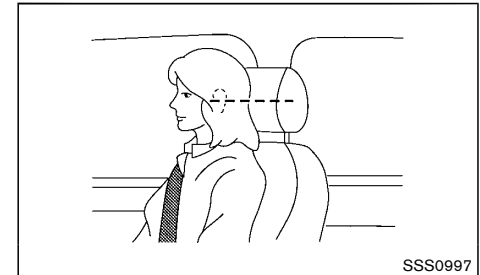

For adjustable head restraint

Adjust the head restraint so the center is level with the center of your ears. If your ear position is still higher than the recommended alignment, place the head restraint at the highest position.

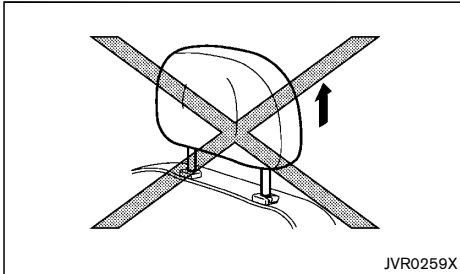

For non-adjustable head restraint

Make sure the head restraint is positioned from the stored position or any non-latch position so the lock knob is engaged in the notch before riding in that designated seating position.

Raise

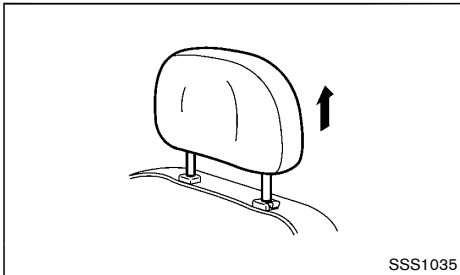

To raise the head restraint, pull it up.

Make sure the head restraint is positioned from the stored position or any non-latch position so the lock knob is engaged in the notch before riding in that designated seating position.

Lower

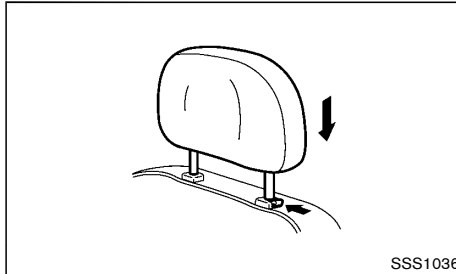

To lower, push and hold the lock knob and push the head restraint down.

Make sure the head restraint is positioned so the lock knob is engaged in the notch before riding in that designated seating position.

SEAT BELTS

PRECAUTIONS ON SEAT BELT USAGE

If you are wearing the seat belt properly adjusted and sitting upright and well back in the seat, chances of being injured or killed in an accident and/or the severity of injury may be greatly reduced. NISSAN strongly encourages you and all of your passengers to buckle up every time you drive, even if your seating position includes the supplemental air bag systems.

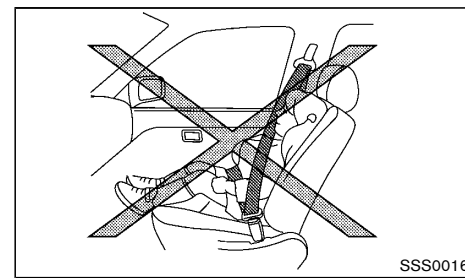
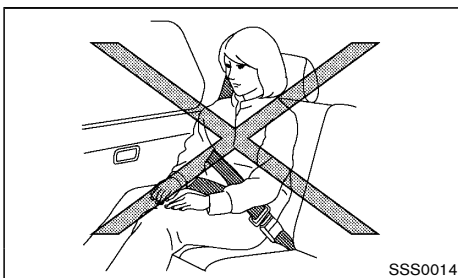
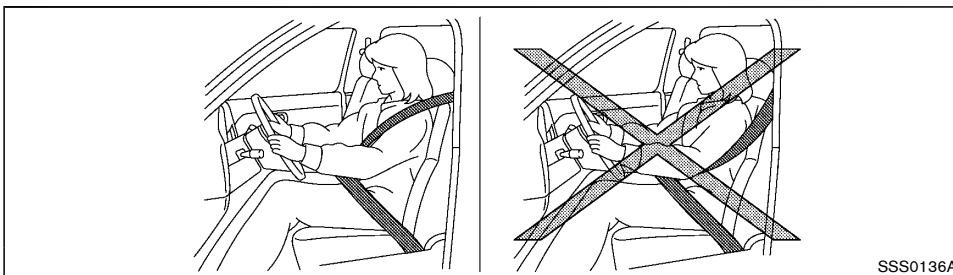
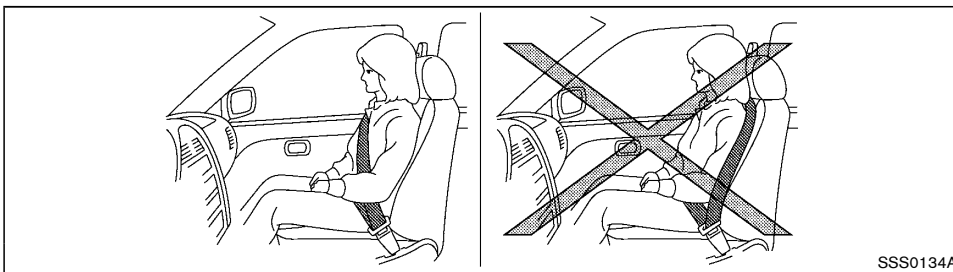



WARNING:

- Seatbelts are designed to bear upon the bony structure of the body, and should be worn low across the front of the pelvis or the pelvis, chest and shoulders, as applicable; wearing the lap section of the belt across the abdominal area must be avoided. Serious injury may occur if a seat belt is not worn properly.
- Position the lap belt as low and snug as possible around the hips, not the waist. A lap belt worn too high could increase the risk of internal injuries in an accident.
- Do not allow more than one person to use the same seat belt. Each belt assembly must only be used by one occupant; it is dangerous to put a belt around a child being carried on the occupant's lap.
- Never carry more people in the vehicle than there are seat belts.
- Never wear seat belts inside out. Belts should not be worn with straps twisted. Doing so may reduce their effectiveness.
- Seatbelts should be adjusted as firmly as possible, consistent with comfort, to provide the protection for which they have been designed. A slack belt will greatly reduce the protection afforded to the wearer.
- Every person who drives or rides in this vehicle should use a seat belt at all times. Children should be properly restrained in the rear seat and, if appropriate, in a child restraint system.

- Do not put the belt behind your back or under your arm. Always route the shoulder belt over your shoulder and across your chest. The belt should be away from your face and neck, but not falling off your shoulder. Serious injury may occur if a seat belt is not worn properly.
- No modifications or additions should be made by the user which will either prevent the seat belt adjusting devices from operating to remove slack, or prevent the seat belt assembly from being adjusted to remove slack.
- Care should be taken to avoid contamination of the webbing with polishes, oils and chemicals, and particularly battery acid. Cleaning may safely be carried out using mild soap and water. The belt should be replaced if webbing becomes frayed, contaminated or damaged.
- All seat belt assemblies including retractors and attaching hardware should be inspected after any collision by a NISSAN dealer. NISSAN recommends that all seat belt assemblies in use during a collision be replaced unless the collision was minor and the belts show no damage and continue to operate properly. Seat belt assemblies not in use during a collision should also be inspected and, when necessary, replaced if either damage or improper operation is noted.
- It is essential to replace the entire assembly after it has been worn in a severe impact even if damage to the assembly is not obvious.

- Once the pre-tensioner seat belt (if equipped) has activated, it cannot be reused. It must be replaced together with the retractor. Contact a NISSAN dealer.
- Removal and installation of the pre-tensioner seat belt system components (if equipped) should be done by a NISSAN dealer.

CHILD SAFETY



WARNING:

- Infants and children need special protection. The vehicle's seat belts may not fit them properly. The shoulder belt may come too close to the face or neck. The lap belt may not fit over their small hipbones. In an accident, an improperly fitted seat belt could cause serious or fatal injury.
- Always use an appropriate child restraint system.

Children need adults to help protect them. They need to be properly restrained. The proper restraint depends on the child's size.

Infants and small children

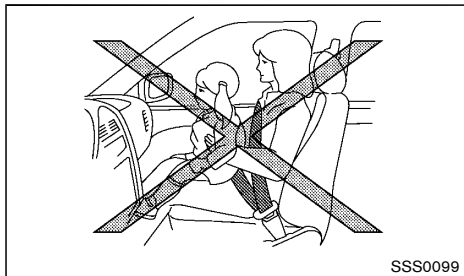

NISSAN recommends that infants and small children be seated in a child restraint system. You should choose a child restraint system that fits your vehicle and the child, and always follow the manufacturer's instructions for installation and use.

Large children

WARNING:

- **Never allow children to stand or kneel on any seats.**
- **Never allow children in the luggage area while the vehicle is moving. A child could be seriously injured in an accident or sudden stop.**

Children who are too large for a child restraint system should be seated and restrained by the seat belts that are provided.

If the child's seating position has a shoulder belt that fits close to the face or neck, the use of a booster seat (commercially available) may help overcome this. The booster seat should raise the child so that the shoulder belt is properly positioned across the top, middle

portion of the shoulder and the lap belt is low on the hips. The booster seat should also fit the vehicle seat. Once the child has grown so that the shoulder belt is no longer on or near the face or neck of the child, use the shoulder belt without the booster seat. In addition, there are many types of child restraint systems available for larger children that should be used for maximum protection.

PREGNANT WOMEN

NISSAN recommends that pregnant women use seat belts. The seat belt should be worn snug, and always position the lap belt as low as possible around the hips, not the waist. Place the shoulder belt over your shoulder and across your chest. Never run the lap/shoulder belt over your abdominal area. Contact your doctor for specific recommendations.

INJURED PERSONS

NISSAN recommends that injured persons use seat belts. Contact your doctor for specific recommendations.

THREE-POINT TYPE SEAT BELTS

Fastening seat belts

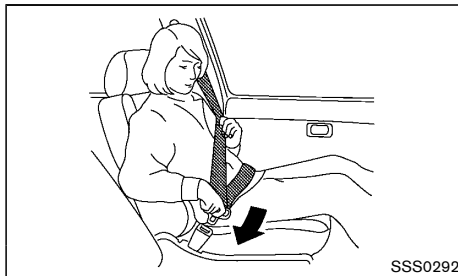

WARNING:

The seatback should not be in a reclined position any more than needed for comfort. Seat belts are most effective when the passenger sits well back and straight up in the seat.

1. Adjust the seat. (See "Seats" (P.1-2).)
2. Slowly pull the seat belt out of the retractor and insert the tongue into the buckle until you hear and feel the latch engage.
 - **The retractor is designed to lock during a sudden stop or on impact. A slow pulling motion permits the belt to move, and allows you some freedom of movement in the seat.**
 - **If the seat belt cannot be pulled from its fully retracted position, firmly pull the belt and release it. Then smoothly pull the belt out of the retractor.**

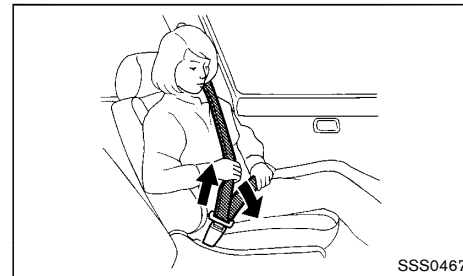

3. Position the lap belt portion low and snug on the hips as shown.
4. Pull the shoulder belt portion toward the retractor to take up extra slack. Be sure the shoulder belt is routed over your shoulder and is snug across your

chest.

Shoulder belt height adjustment (if equipped)

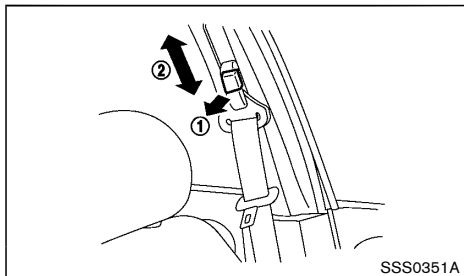

WARNING:

- **The shoulder belt anchor height should be adjusted to the position best for you. Failure to do so may reduce the effectiveness of the entire restraint system and increase the chance or severity of injury in an accident.**
- **The shoulder belt should rest on the middle of the shoulder. It must not rest against the neck.**
- **Be sure that the seat belt is not twisted in any way.**
- **Be sure that the shoulder belt anchor is secured by trying to move the shoulder belt anchor up and down after adjustment.**

The shoulder belt anchor height should be adjusted to the position best for you.

The belt should be away from your face and neck, but not falling off your shoulder.

To adjust, pull the release button ① and move the shoulder belt anchor to the proper position ②, so that

the belt passes over the center of the shoulder.

Release the button to lock the shoulder belt anchor into position.

Unfastening seat belts

Push the button on the buckle. The seat belt automatically retracts.

Checking seat belt operation

Seat belt retractors are designed to lock seat belt movement:

- When the seat belt is pulled quickly from the retractor.
- When the vehicle slows down rapidly.

To increase your confidence in the seat belts, check the operation by grasping the shoulder belt and pulling forward quickly. The retractor should lock and restrict further belt movement. If the retractor does not lock during this check, contact a NISSAN dealer immediately.

TWO-POINT TYPE SEAT BELTS (if equipped)

Fastening seat belts

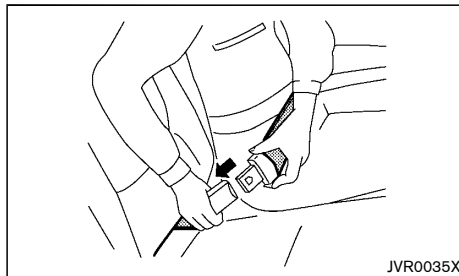

WARNING:

Seat belts are most effective when the passenger sits well back and straight up in the seat.

1. Insert the tongue into the buckle marked CENTER until you hear and feel the latch engage.

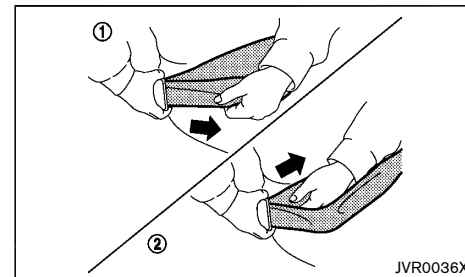

2. Adjust the seat belt length. To shorten, hold the tongue and pull the upper belt as illustrated ①. To lengthen, hold the tongue and pull the under belt as illustrated ②.

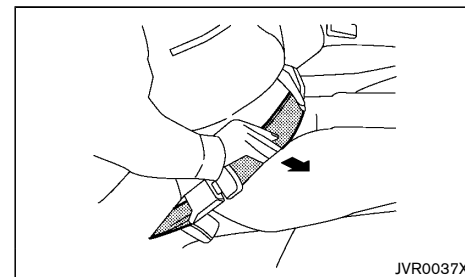

3. Position the lap belt portion low and snug on the hips as shown.

Unfastening seat belts

Push the button on the buckle.

CENTER MARK ON SEAT BELTS

Selecting correct set of seat belts

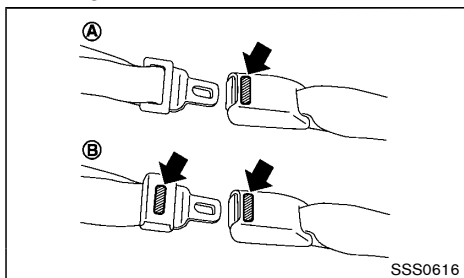

The center seat belt buckle (A) or both the buckle and the tongue (B) are identified by the CENTER mark. The center seat belt tongue can be fastened only into the center seat belt buckle.

SEAT BELT MAINTENANCE

Periodically check that the seat belt and all the metal components, such as buckles, tongues, retractors, flexible wires and anchors, work properly. If loose parts, deterioration, cuts or other damage on the seat belt webbing is found, the entire seat belt assembly should be replaced.

If dirt builds up in the shoulder belt guide of the seat belt anchors, the seat belts may retract slowly. Wipe the shoulder belt guide with a clean, dry cloth.

To clean the seat belt webbing, apply a mild soap solution or any solution recommended for cleaning upholstery or carpet. Then wipe with a cloth and allow the seat belts to dry in the shade. Do not allow the seat

belts to retract until they are completely dry.

CHILD RESTRAINTS

PRECAUTIONS ON CHILD RESTRAINT USAGE

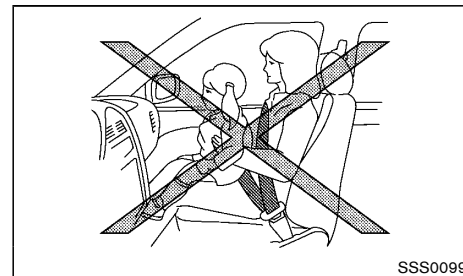

WARNING:

- **Infants and small children should never be carried on your lap. It is not possible for even the strongest adult to resist the forces of a severe accident. The child could be crushed between the adult and parts of the vehicle. Also, it is dangerous to put a seat belt around a child being carried on the occupant's lap.**
- **Infants and children need special protection. The vehicle's seat belts may not fit them properly. The shoulder belt may come too close to the face or neck. The lap belt may not fit over their small hip bones. In an accident, an improperly fitting seat belt could cause serious or fatal injury.**
- **Infants and small children should always be placed in an appropriate child restraint system while riding in the vehicle. Failure to use a child restraint system can result in serious injury or death.**

- Child restraint systems specially designed for infants and small children are available from several manufacturers. When selecting any child restraint systems, place your child in the child restraint system and check the various adjustments to be sure that the child restraint system is compatible with your child. Always follow the manufacturer's instructions for installation and use.
- NISSAN recommends that the child restraint system be installed in the rear seat. According to accident statistics, children are safer when properly restrained in the rear seat rather than in the front seat.
- Follow all of the child restraint system manufacturer's instructions for installation and use. When purchasing a child restraint system, be sure to select one which will fit your child and vehicle. It may not be possible to properly install some types of child restraint systems in your vehicle.
- For a front-facing child restraint system, check to make sure the shoulder belt does not fit close to child's face or neck. If it does, put the shoulder belt behind the child restraint system.
- Never install a rear-facing child restraint system in the front seat. An inflating supplemental front-impact air bag could seriously injure or kill your child. A rear-facing child restraint system must only be used in the rear seat.
- Adjustable seatbacks should be positioned to fit a child restraint system, but as upright as possible.

- If the seat belt in the position where a child restraint system is installed requires a locking clip and if it is not used, injuries could result from a child restraint system tipping over during normal vehicle braking or cornering.
- After attaching a child restraint system, test it before you place the child in it. Tilt it from side to side. Try to tug it forward and check if it is held securely in place. The child restraint system should not move more than 25 mm (1 in). If the restraint is not secure, tighten the belt as necessary, or install the restraint in another seat and test it again.
- Check the child restraint system in your vehicle to be sure that it is compatible with the vehicle's seat belt system.
- If a child restraint system is not anchored properly, the risk of a child being injured in a collision or a sudden stop greatly increases.
- Improper use of a child restraint system can increase the risk or severity of injury for both the child and other occupants in the vehicle.
- Always use an appropriate child restraint system. An improperly installed child restraint system could lead to serious injury or death in an accident.
- When the child restraint system is not in use, keep it secured with a seat belt to prevent it from being thrown around in case of a sudden stop or accident.

NISSAN recommends that infants and small children be seated in a child restraint system. You should choose a child restraint system that fits your vehicle and always follow the manufacturer's instructions for installation and use. In addition, there are many types

of child restraint systems available for larger children that should be used for maximum protection.



CAUTION:

Remember that a child restraint system left in a closed vehicle can become very hot. Check the seating surface and buckles before placing your child in a child restraint system.

ISOFIX CHILD RESTRAINT SYSTEM (if equipped)

Your vehicle is equipped with special anchor points that are used with ISOFIX child restraint systems.

ISOFIX lower anchor point locations

The ISOFIX anchor points are provided to install child restraints in the rear outboard seating positions only. Do not attempt to install a child restraint in the center position using the ISOFIX anchors.

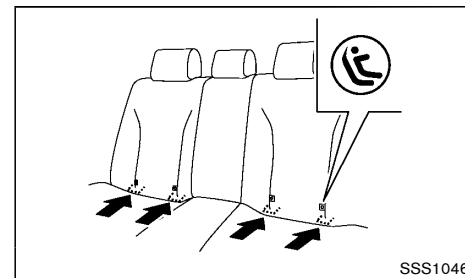

ISOFIX label location

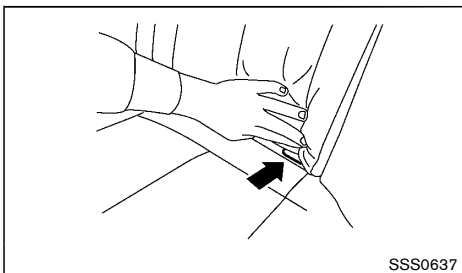

ISOFIX lower anchor location

The ISOFIX anchors are located at the rear of the seat cushion near the seatback. A label is attached to the seatback to help you locate the ISOFIX anchors.

ISOFIX child restraint anchor attachments

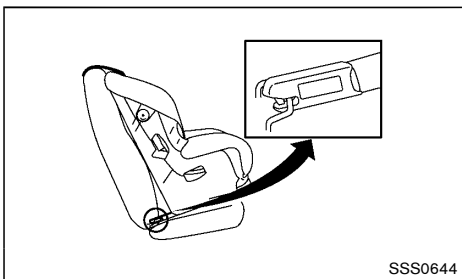

Anchor attachment

ISOFIX child restraints include two rigid attachments that can be connected to two anchors located in the seat. With this system, you do not have to use a vehicle seat belt to secure the child restraint. Check your child restraint for a label stating that it is compatible with the ISOFIX child restraints. This information may also be in the instructions provided by the child restraint manufacturer.

ISOFIX child restraints generally require the use of a top tether strap or other anti-rotation devices such as support legs. When installing ISOFIX child restraints, carefully read and follow the instructions in this manual and those supplied with the child restraints. (See "Child restraint installation using ISOFIX" (P.1-12).)

CHILD RESTRAINT ANCHORAGE (if equipped)

Your vehicle is designed to accommodate a child restraint system on the rear seat. When installing a child restraint system, carefully read and follow the instructions in this manual and those supplied with the child restraint system.



WARNING:

Child restraint anchorages are designed to withstand only those loads imposed by correctly fitted child restraints. Under no circumstances are they to be used for adult seat belts, harnesses or for attaching other items or equipment to the vehicle. Doing so could damage the child restraint anchorages. The child restraint will not be properly installed using the damaged anchorage, and a child could be seriously injured or killed in a collision.

Anchorage location

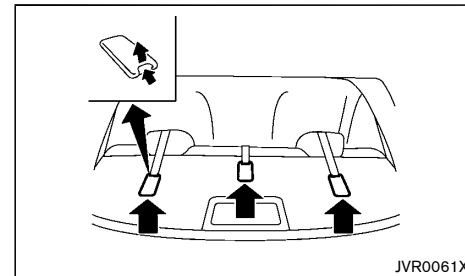

The anchor points are located on the rear parcel shelf for all three seating positions of the rear seat as shown (for Australia).

The anchor points are located on the rear parcel shelf for the right and left outboard seating positions of the rear seat (except for Australia).

CHILD RESTRAINT INSTALLATION USING ISOFIX (if equipped)



WARNING:

- **Attach ISOFIX child restraints only at the specified locations. For the ISOFIX lower anchor locations, see "ISOFIX child restraint system" (P.1-11). If a child restraint is not secured properly, your child could be seriously injured or killed in an accident.**
- **Do not install child restraints that require the use of a top tether strap to seating positions that do not have a top tether anchor.**
- **Do not secure a child restraint in the center rear seating position using the ISOFIX lower anchors. The child restraint will not be**

secured properly.

- **Inspect the lower anchors by inserting your fingers into the lower anchor area and feeling to make sure there are no obstructions over the ISOFIX anchors, such as seat belt webbing or seat cushion material. The child restraint will not be secured properly if the ISOFIX anchors are obstructed.**
- **Child restraint anchorages are designed to withstand only those loads imposed by correctly fitted child restraints. Under no circumstance are they to be used for adult seat belts, harnesses or for attaching other items or equipment to the vehicle.**

Installation on rear outboard seats

Front-facing:

Be sure to follow the manufacturer's instructions for the proper use of your child restraint. Follow these steps to install a front-facing child restraint on the rear outboard seats using ISOFIX:

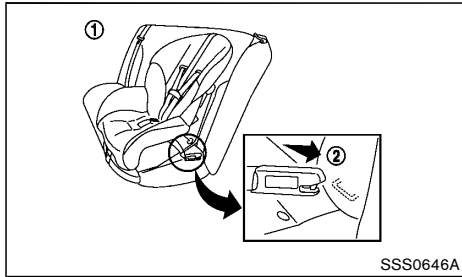

1. Position the child restraint on the seat ① .

2. Secure the child restraint anchor attachments to the ISOFIX lower anchors ② .
3. The back of the child restraint should be secured against the vehicle seat back. If necessary, adjust or remove the head restraint to obtain the correct child restraint fit. (See "Head restraints" (P.1-3).) If the head restraint is removed, store it in a secure place. Be sure to install the head restraint when the child restraint is removed. If the seating position does not have an adjustable head restraint and it is interfering with the proper child restraint fit, try another seating position or a different child restraint.

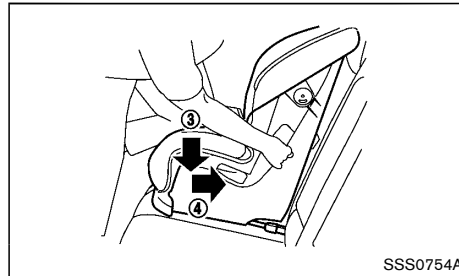

4. Shorten the rigid attachment to have the child restraint firmly tightened; press downward ③ and rearward ④ firmly in the center of the child restraint with your knee to compress the vehicle seat cushion and seatback.
5. If the child restraint is equipped with a top tether strap, route the top tether strap and secure the tether strap to the tether anchor point. (See "Child restraint anchorage" (P.1-12).)
6. If the child restraint is equipped with other anti-rotation devices such as support legs, use them

instead of the top tether strap following the child restraint manufacturer's instructions.

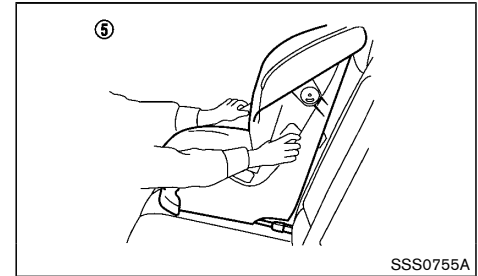

7. Test the child restraint before you place the child in it ⑤ . Push the child restraint from side to side and tug it forward to make sure that it is held securely in place.
8. Check to make sure that the child restraint is properly secured prior to each use. If the child restraint is loose, repeat steps 3 through 7.

Rear-facing:

Be sure to follow the manufacturer's instructions for the proper use of your child restraint. Follow these steps to install a rear-facing child restraint on the rear outboard seats using ISOFIX:

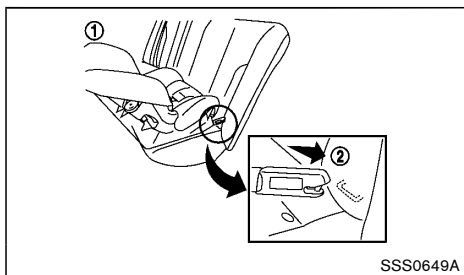

Steps 1 and 2

1. Position the child restraint on the seat ① .
2. Secure the child restraint anchor attachments to the ISOFIX lower anchors ② .

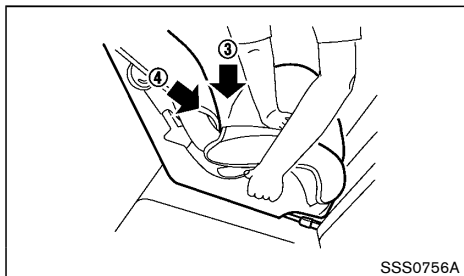

Step 3

3. Shorten the rigid attachment to have the child restraint firmly tightened; press downward ③ and rearward ④ firmly in the center of the child restraint with your hand to compress the vehicle seat cushion and seatback.
4. If the child restraint is equipped with a top tether strap, route the top tether strap and secure the tether strap to the tether anchor point. (See “Child restraint anchorage” (P.1-12).)

5. If the child restraint is equipped with other anti-rotation devices such as support legs, use them instead of the top tether strap following the child restraint manufacturer’s instructions.

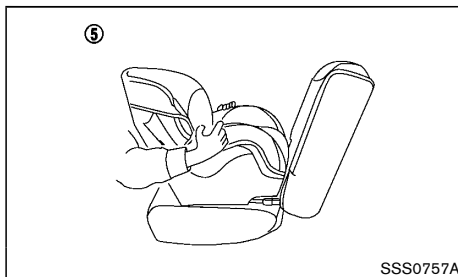

Step 6

6. Test the child restraint before you place the child in it ⑤ . Push the child restraint from side to side and tug it forward to make sure that it is held securely in place.
7. Check to make sure that the child restraint is properly secured prior to each use. If the child restraint is loose, repeat steps 3 through 6.

INSTALLATION OF CHILD RESTRAINT SYSTEM

Installation on rear seats (3-point type seat belt)



WARNING:

The direction of the child restraint system depends on the type of the child restraint system and the size of the child.

Front-facing:

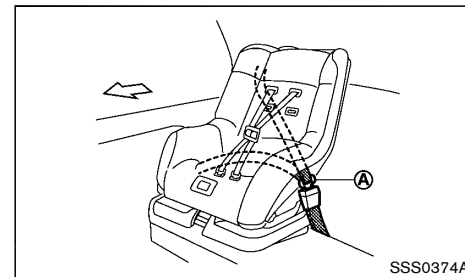

If you must install a front-facing child restraint system on the rear seat, follow these steps:

1. Position the front-facing child restraint system on the rear seat.
Always follow the child restraint system manufacturer’s instructions for installation and use.
2. Route the seat belt tongue through the child restraint system and insert it into the buckle until you hear and feel the latch engage.

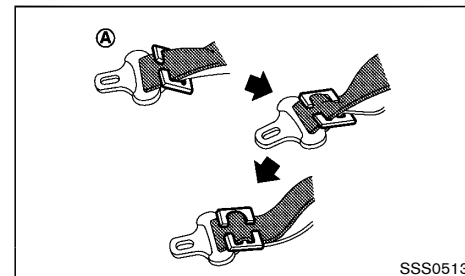

To prevent slack in the lap belt, it is necessary to secure the shoulder belt in place with a locking

clip (A) . Use the locking clip attached to the child restraint system or one which is equivalent in dimension and strength.

Be sure to follow the child restraint system manufacturer's instructions for belt routing.

3. Test the child restraint system before you place the child in it. Tilt it from side to side. Try to tug it forward and check if it is held securely in place.
4. Make sure that the child restraint system is properly secured prior to each use.

Rear-facing:

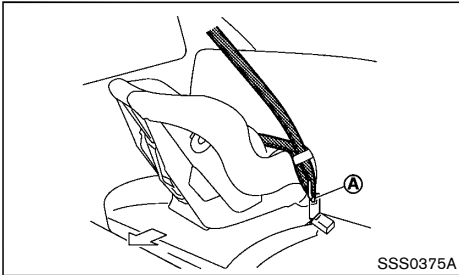

If you must install a rear-facing child restraint system on the rear seat, follow these steps:

1. Position the rear-facing child restraint system on the rear seat.
Always follow the child restraint system manufacturer's instructions for installation and use.
2. Route the seat belt tongue through the child restraint system and insert it into the buckle until you hear and feel the latch engage.

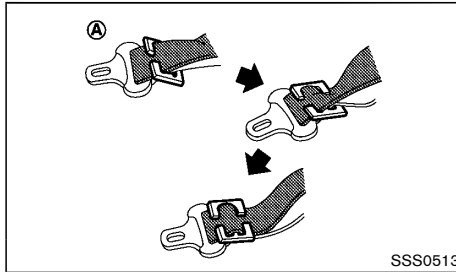

To prevent slack in the lap belt, it is necessary to secure the shoulder belt in place with a locking clip (A) . Use the locking clip attached to the child restraint system or one which is equivalent in dimension and strength.

Be sure to follow the child restraint system manufacturer's instructions for belt routing.

3. Test the child restraint system before you place the child in it. Tilt it from side to side. Try to tug it forward and check if it is held securely in place.
4. Make sure that the child restraint system is properly secured prior to each use.

Installation on rear center seat (2-point type seat belt) (if equipped)



WARNING:

The direction of the child restraint system depends on the type of the child restraint system and the size of the child.

Front-facing:

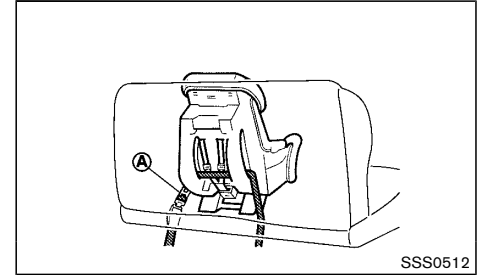

If you must install a front-facing child restraint system on the rear center seat, follow these steps:

1. Position the front-facing child restraint system on the rear center seat.
Always follow the child restraint system manufacturer's instructions for installation and use.
2. Route the seat belt tongue through the child restraint system and insert it into the buckle until you hear and feel the latch engage.

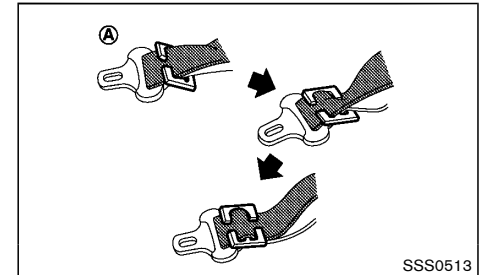

3. To prevent slack in the lap belt, it is necessary to secure the lap belt in place with a locking clip (A) .

Use the locking clip attached to the child restraint system, or one which is equivalent in dimensions and strength.

Be sure to follow the child restraint system manufacturer's instructions for belt routing.

4. Test the child restraint system before you place the child in it. Tilt it from side to side. Try to tug it forward and check if it is held securely in place.
5. Make sure that the child restraint system is properly secured prior to each use.

Rear-facing:

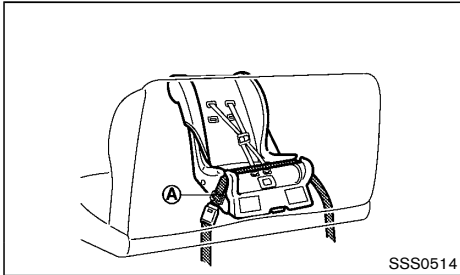

If you must install a rear-facing child restraint system on the rear center seat, follow these steps:

1. Position the rear-facing child restraint system on the rear center seat.
Always follow the child restraint system manufacturer's instructions for installation and use.
2. Route the seat belt tongue through the child restraint system and insert it into the buckle until you hear and feel the latch engage.

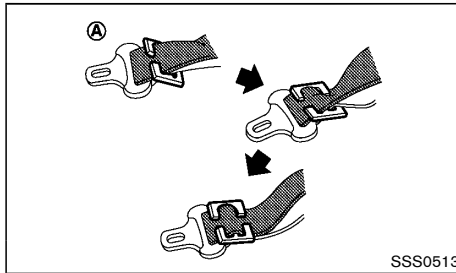

3. To prevent slack in the lap belt, it is necessary to secure the lap belt in place with a locking clip (A). Use the locking clip attached to the child restraint system, or one which is equivalent in dimensions and strength.

Be sure to follow the child restraint system manufacturer's instructions for belt routing.

4. Test the child restraint system before you place the child in it. Tilt it from side to side. Try to tug it forward and check if it is held securely in place.
5. Make sure that the child restraint system is properly secured prior to each use.

Installation on front seat

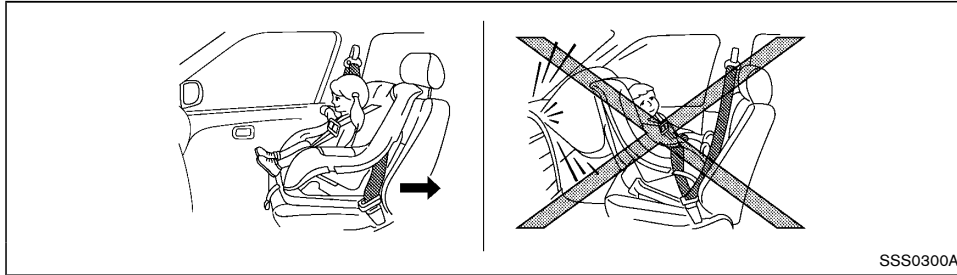

WARNING:

- Never install a rear-facing child restraint on the front passenger's seat when the front passenger's air bag is equipped. Supplemental front-impact air bags inflate with great force. A rear-facing child restraint could be struck by the supplemental front-impact air bags in an accident and could seriously injure or kill your child.
- Never install a child restraint with a top tether strap on the front seat.
- NISSAN recommends that a child restraint system be installed on the rear seat. However, if you must install a front-facing child restraint system on the front passenger's seat, move the passenger's seat to the rearmost position.
- Child restraints for infants must be used in the rear-facing direction and therefore must not be used on the front passenger's seat when the front passenger's air bag is

equipped.

Front-facing:

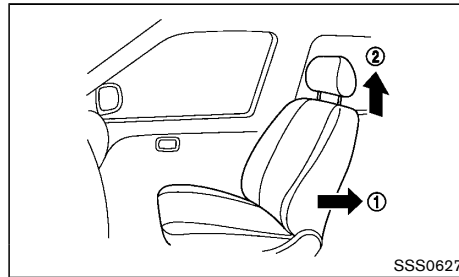

If you must install a front-facing child restraint system on the front seat, follow these steps:

1. Move the seat to the rearmost position ①.
2. Adjust the head restraint to its highest position ②.
3. Position the front-facing child restraint system on the front passenger's seat. It should be placed in the front-facing direction only.

Always follow the child restraint system manufacturer's instructions for installation and use.

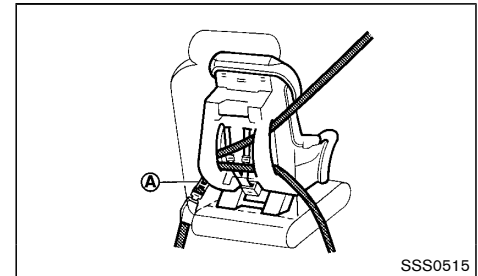

4. Route the seat belt tongue through the child restraint system and insert it into the buckle until you hear and feel the latch engage.

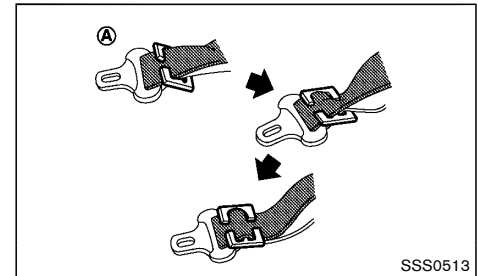

5. To prevent slack in the lap belt, it is necessary to secure the shoulder belt in place with a locking clip (A). Use the locking clip attached to the child restraint system, or one which is equivalent in dimensions and strength.

Be sure to follow the child restraint system manufacturer's instructions for belt routing.

SUPPLEMENTAL RESTRAINT SYSTEM (SRS)

6. Slide the seat forward so that the seat belt fully tightens the child restraint system.
7. Test the child restraint system before you place the child in it. Tilt it from side to side. Try to tug it forward and check if it is held securely in place.
8. Make sure that the child restraint system is properly secured prior to each use.

PRECAUTIONS ON SUPPLEMENTAL RESTRAINT SYSTEM (SRS)

This Supplemental Restraint System (SRS) section contains important information concerning the driver's and passenger's supplemental front-impact air bags.

Supplemental front-impact air bag system

This system can help cushion the impact force to the head and chest area of the driver and/or front passenger (if equipped) in certain frontal collisions. The supplemental front-impact air bag is designed to inflate on the front where the vehicle is impacted.

Supplemental side-impact air bag system (if equipped)

This system can help cushion the impact force to the chest and pelvis areas of the driver and front passenger in certain side-impact collisions. The supplemental side-impact air bag is designed to inflate on the side where the vehicle is impacted.

Supplemental curtain side-impact air bag system (if equipped)

This system can help cushion the impact force to the head of the driver and passengers in front and rear outboard seating positions in certain side-impact collisions. The supplemental curtain side-impact air bag is designed to inflate on the side where the vehicle is impacted.

The SRS is designed to **supplement** the accident protection provided by the driver's seat belt and **is not** designed to **substitute** for it. The SRS can help save lives and reduce serious injuries. However, inflating air bags may cause abrasions or other injuries. Air bags do not provide protection to the lower body. Seat belts should always be correctly worn and the occupants should always be seated a suitable distance away from

the steering wheel. (See "Seat belts" (P.1-6).) The air bags inflate quickly in order to help protect the occupants. The force of the air bags inflating can increase the risk of injury if the occupants are too close to, or are against, the air bag modules during inflation. The air bags will deflate quickly after deployment.

The SRS operates only when the ignition switch is in the "ON" position.

When the ignition switch is in the "ON" position, the SRS air bag warning light illuminates for about 7 seconds and then turns off. This indicates that the SRS is operational. (See "SRS air bag warning light" (P.1-22).)

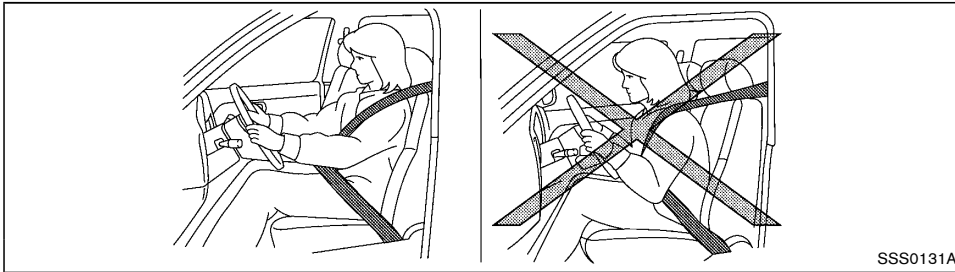

SSS0131A

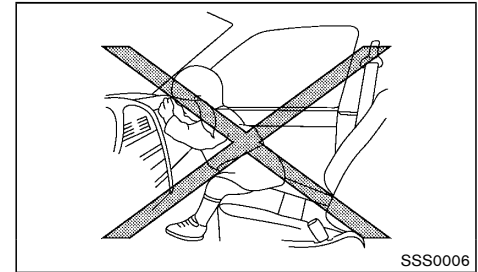

SSS0006

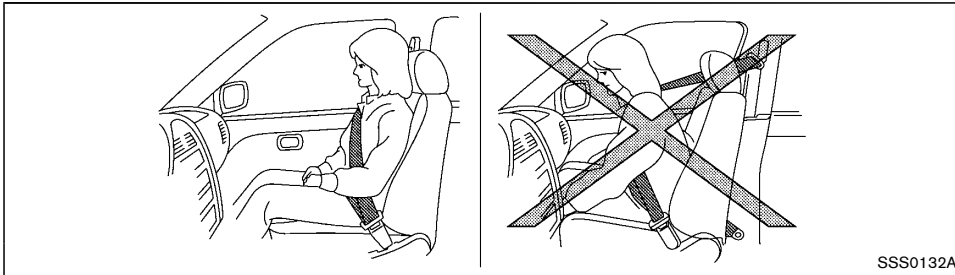

SSS0132A

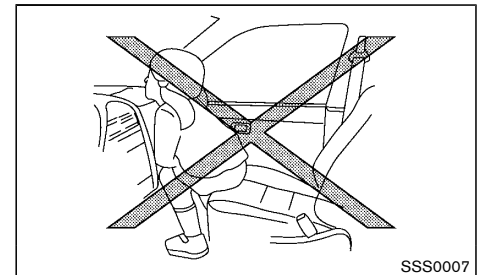

SSS0007



WARNING:

- The supplemental front-impact air bags ordinarily will not inflate in the event of a side impact, rear impact, rollover, or lower severity frontal collision. Always wear the seat belts to help reduce the risk or severity of injury in accidents.
- The seat belts and the supplemental front-impact air bags are most effective when you are sitting well back and upright in the seat. The front-impact air bags inflate with great force. If you are unrestrained, leaning for-

ward, sitting sideways, or out of position in any way, you are at greater risk of injury or death in an accident. You may also receive serious or fatal injuries from the supplemental front-impact air bag if you are up against it when it inflates. Always sit back against the seatback and as far away as practical from the steering wheel. Always use the seat belts.

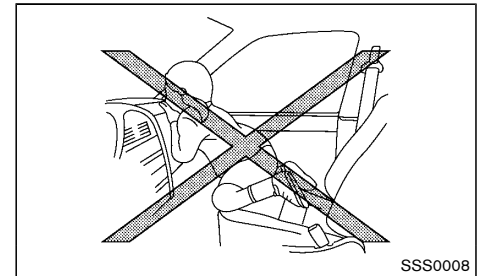

SSS0008

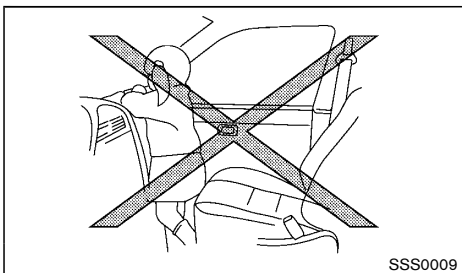

⚠ WARNING:

- Never let children ride unrestrained or extend their hands or face out of the window. Do not attempt to hold them in your lap or arms. Some examples of dangerous riding positions are shown in the illustrations.
- Children may be severely injured or killed when the air bags inflate if they are not properly restrained.
- Never install a rear-facing child restraint system in the front seat. An inflating supplemental front-impact air bag could seriously injure or kill your child. (See “Child restraints” (P.1-10).)

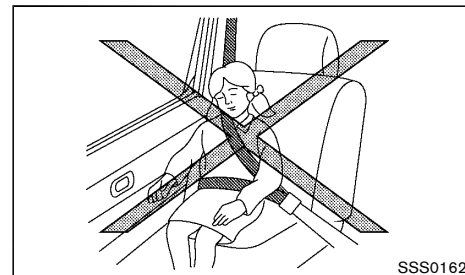
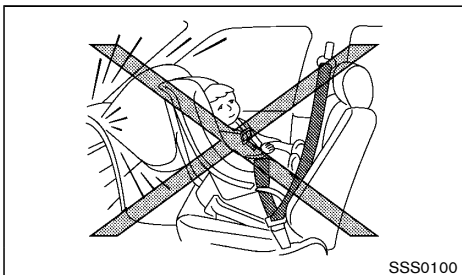
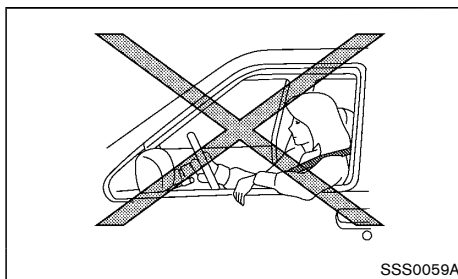
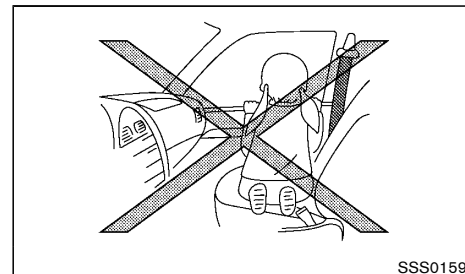
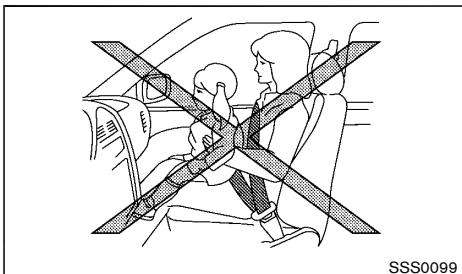
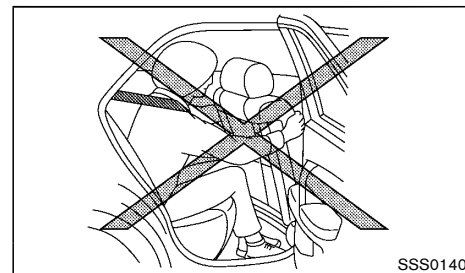

WARNING:

- The supplemental side-impact air bags and supplemental curtain side-impact air bags ordinarily will not inflate in the event of a front impact, rear impact, rollover, or lower severity side collision. Always wear the seat belts to help reduce the risk or severity of injury in accidents.
- The seat belts and the supplemental side-impact air bags and supplemental curtain side-impact air bags are most effective when you are sitting well back and upright in the seat. The supplemental side-impact air bags and supplemental curtain side-impact air bags inflate with great force. If you and your passengers are unrestrained, leaning forward, sitting sideways, or out of position in any way, you and your passengers are at greater risk of injury or death in an accident.
- Do not allow anyone to place their hands, legs, or face near the supplemental side-impact air bags and supplemental curtain side-impact air bags on the sides of the seatback of the front seats or near the side roof rails. Do not allow anyone sitting in the front seats or rear outboard seats to extend their hands out of the windows or lean against the doors. Some examples of dangerous riding positions are shown in the illustrations.
- When sitting in the rear seats, do not hold onto the seatback of the front seats. If the supplemental side-impact air bags and supplemental curtain side-impact air bags inflate, you may be seriously injured. Be especially careful with children, who should

always be properly restrained.

- Do not use seat covers on the front seatbacks. They may interfere with the supplemental side-impact air bag inflations.

Pre-tensioner seat belt system (if equipped)

The pre-tensioner seat belt system may activate with the supplemental air bag system in certain types of collisions.

Working with the seat belt retractor and anchor, it helps tighten the seat belt the instant the vehicle becomes involved in certain types of collisions, helping to restrain front seat occupants. (See "Pre-tensioner seat belt system" (P.1-26).)

Air bag warning label

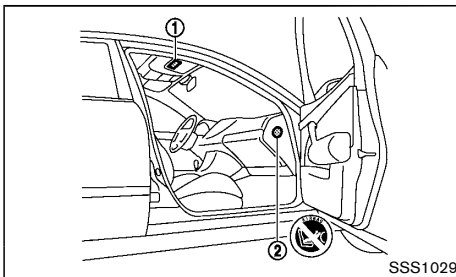

Type A

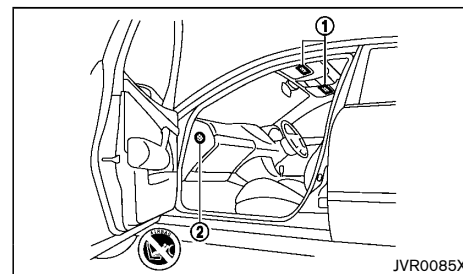

Type B

SRS air bag:

The warning label ① is located on the surface of the driver's and/or passenger's sun visor.

SRS front-impact passenger air bag (if equipped):

The warning label ② (if equipped) is located on the side of the passenger's side instrument panel.

This label warns you not to fit a rear-facing child restraint system on the front passenger seat as such a restraint system used in this position could cause serious injury to the infant in case of air bag deployment during a collision.

In vehicles equipped with a front-impact passenger air bag system, use a rear-facing child restraint system only on the rear seats. "Extreme Hazard! Do not use a rearward facing child restraint on a seat protected by an air bag in front of it!"

When installing a child restraint system in your vehicle, always follow the child restraint system manufacturer's instructions for installation. For additional information, see "Child restraints" (P.1-10).

SRS air bag warning light



The SRS air bag warning light, displaying  in the instrument panel, monitors the circuits for the air bag systems, pre-tensioner seat belt system and all related wiring.

When the ignition switch is in the "ON" position, the SRS air bag warning light illuminates for about 7 seconds and then turns off. This indicates that the SRS air bag systems are operational.

If any of the following conditions occur, the air bag and/or pre-tensioner seat belt systems need servicing:

- The SRS air bag warning light remains on after approximately 7 seconds.
- The SRS air bag warning light flashes intermittently.
- The SRS air bag warning light does not illuminate at all.

Under these conditions, the air bag and/or pre-tensioner seat belt systems may not operate properly. They must be checked and repaired. Contact a NISSAN dealer immediately.

SUPPLEMENTAL AIR BAG SYSTEMS

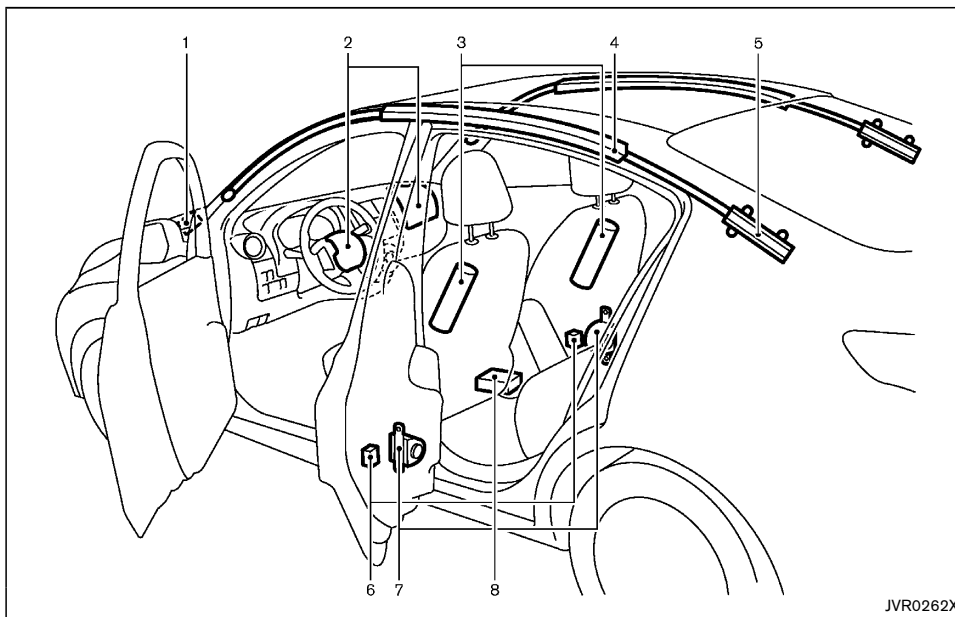

1. Crash zone sensor
2. Supplemental front-impact air bag modules (if equipped for front passenger)
3. Supplemental side air bag modules (if equipped)
4. Supplemental curtain side-impact air bags (if equipped)
5. Supplemental curtain side-impact air bag inflators (if equipped)
6. Satellite sensors (if equipped)
7. Seat belt pre-tensioner retractors (if equipped)
8. Supplemental air bag diagnosis sensor unit



WARNING:

- **Do not place any objects on the steering wheel pad. Do not place any objects between the driver and steering wheel pad. Such objects may become dangerous pro-**

jectiles and cause injury if a supplemental air bag inflates.

- **Immediately after inflation, several supplemental air bag system components will be hot. Do not touch them: you may severely burn yourself.**
- **No unauthorized changes should be made to any components or wiring of the supplemental air bag systems. This is to prevent accidental inflation of the supplemental air bags or damage to the supplemental air bag systems.**
- **Do not make unauthorized changes to your vehicle's electrical system, suspension system or front end structure. This could affect proper operation of the supplemental air bag systems.**
- **Tampering with the supplemental air bag systems may result in serious personal injury. Tampering includes changes to the steering wheel by placing materials over the steering wheel pad and above, and by installing additional trim materials around the supplemental air bag systems.**
- **Work around and on the supplemental air bag systems should be done by a NISSAN dealer. The SRS wiring should not be modified or disconnected. Unauthorized electrical test equipment and probing devices should not be used on the supplemental air bag systems.**
- **The SRS wiring harness connectors are yellow and/or orange for easy identification.**

When the air bags inflate, a fairly loud noise may be heard, followed by the release of smoke. This smoke is not harmful and does not indicate a fire. Care should

be taken not to inhale it, as it may cause irritation and choking. Those with a history of a breathing condition should get fresh air promptly.

Supplemental front-impact air bag system

The driver's supplemental front-impact air bag is located at the center of the steering wheel. The passenger's supplemental front-impact air bag (if equipped) is located at the instrument panel above the glove box.

The supplemental front-impact air bag system is designed to inflate in higher severity frontal collisions, although it may inflate if the forces in another type of collision are similar to those of a higher severity frontal impact. It may not inflate in certain frontal collisions. Vehicle damage (or lack of it) is not always an indication of proper supplemental front-impact air bag system operation.

Supplemental side-impact air bag system (if equipped)

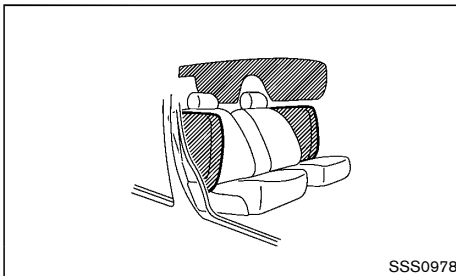

The supplemental side-impact air bag is located at the outside of the front seats' seatbacks.

The supplemental side-impact air bag system is designed to inflate in higher severity side collisions,

although it may inflate if the forces in another type of collision are similar to those of a higher severity side impact. It may not inflate in certain side collisions. Vehicle damage (or lack of it) is not always an indication of proper supplemental side-impact air bag system operation.

Supplemental curtain side-impact air bag system (if equipped)

The supplemental curtain side-impact air bag is located at the roof rails.

The supplemental curtain side-impact air bag system is designed to inflate in higher severity side collisions, although it may inflate if the forces in another type of collision are similar to those of a higher severity side impact. It may not inflate in certain side collisions. Vehicle damage (or lack of it) is not always an indication of proper supplemental curtain side-impact air bag system operation.

SRS AIR BAG DEPLOYMENT CONDITIONS

The SRS air bags activate in the event of a front or side impact in which the vehicle occupants may be severely injured even if they are wearing the seat belts properly.

They may not activate when the crash energy is absorbed and/or distributed by the vehicle body. Vehicle damage (or lack of it) is not always an indication of proper SRS air bag system operation.

When the SRS air bag will deploy

Supplemental front-impact air bags:

The supplemental front-impact air bag system is designed to inflate in higher severity frontal collisions. Some examples are shown in the following illustrations.

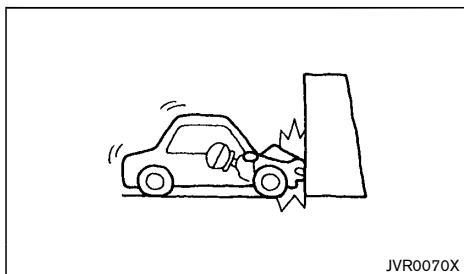

The supplemental front-impact air bag system will deploy in the event of an impact which exceeds a 25 km/h frontal collision with a solid wall that does not move or deform.

The supplemental front-impact air bag system may also deploy when the vehicle receives severe damage to the undercarriage.

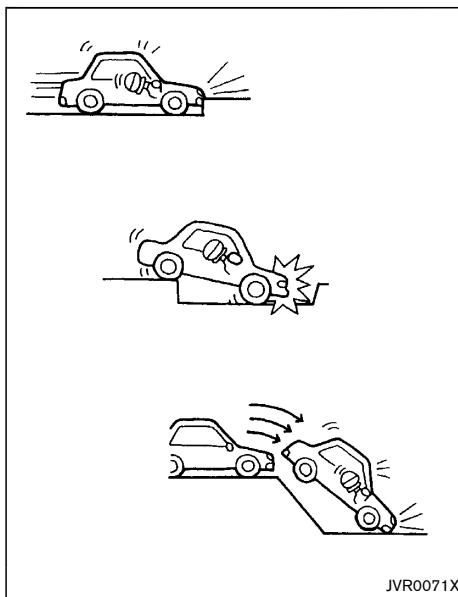

- Hitting a curb, pavement edge or hard surface at high speed
- Falling into a deep hole or ditch
- Landing hard on the ground after jumping

Supplemental side-impact and curtain side-impact air bags (if equipped):

The supplemental side-impact and curtain side-impact air bag systems are designed to inflate in higher severity side collisions. Some examples are shown in the following illustrations.

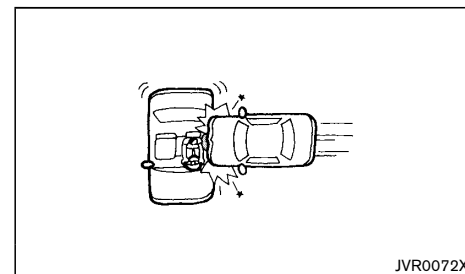

(supplemental side-impact air bag system)

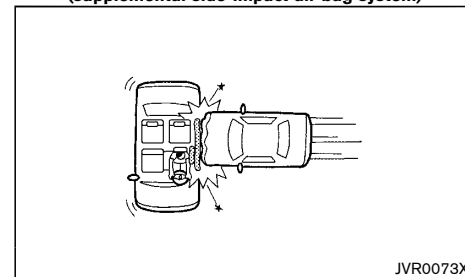

(supplemental curtain side-impact air bag system)

- The supplemental side-impact and curtain side-impact air bags will deploy in the event of a side impact with a normal passenger vehicle that exceeds at a speed of 25 km/h.

When the SRS air bag is unlikely to deploy

The SRS air bags may not deploy in cases where the impact is not forceful enough to inflate the SRS air bags.

For example, if the vehicle strikes an object, such as a parked vehicle or sign pole, which can move or deform on impact, the SRS air bags are unlikely to deploy.

Supplemental front-impact air bags:

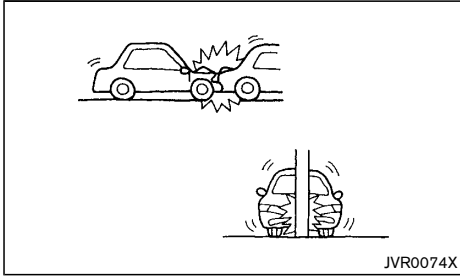

- Striking a vehicle of the same class that is parked
- Crashing into a solid utility pole

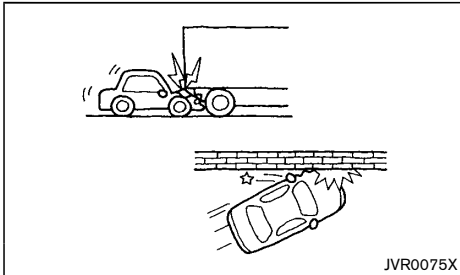

- Running under the tail gate of a truck
- A frontal offset impact to the guard rails

Supplemental side-impact and curtain side-impact air bags (if equipped):

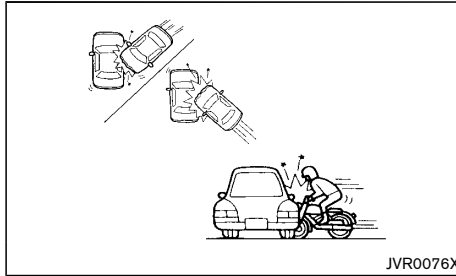

- A collision from the side at an angle
- A side impact with a two-wheeled vehicle

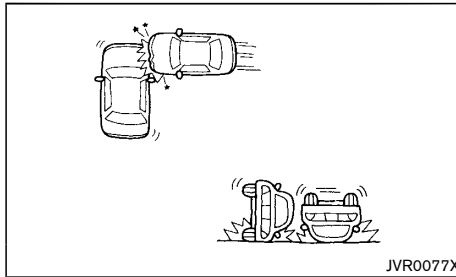

- A collision from the side impacting the vehicle engine room (trunk)
- Vehicle rollover

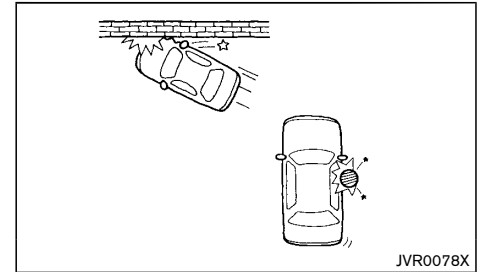

- A frontal offset impact to the guard rails
- A collision with a pole

When the SRS air bag will not deploy

Once the SRS air bag has inflated, the air bag module will not function again if your vehicle collides with another vehicle or an object.

Other examples where the SRS air bag will not deploy are shown in the following illustrations.

Supplemental front-impact air bags:

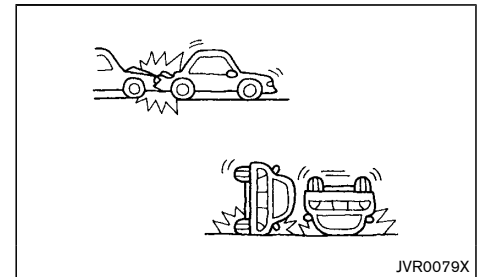

- A collision from the side or rear

- Vehicle rollover

Supplemental side-impact and curtain side-impact air bags (if equipped):

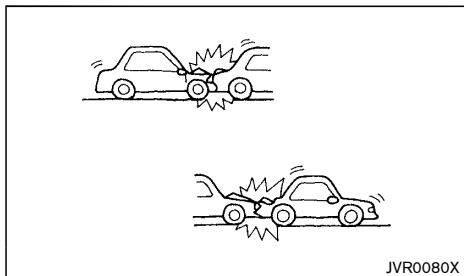

- A frontal collision with a parked or moving vehicle
- A rear collision

PRE-TENSIONER SEAT BELT SYSTEM (if equipped)

WARNING:

- **The pre-tensioner seat belt cannot be reused after activation. It must be replaced together with the retractor and buckle as a unit.**
- **If the vehicle becomes involved in a collision but the pre-tensioner is not activated, be sure to have the pre-tensioner system checked and, if necessary, replaced by a NISSAN dealer.**
- **No unauthorized changes should be made to any components or wiring of the pre-tensioner seat belt system. This is to prevent accidental activation of the pre-tensioner seat belt or damage to the pre-tensioner**

seat belt system.

- **Work around or on the pre-tensioner seat belt system should be done by a NISSAN dealer. The SRS wiring should not be modified or disconnected. Unauthorized electrical test equipment and probing devices should not be used on the pre-tensioner seat belt system.**
- **If you need to dispose of the pre-tensioner seat belt system, or scrap the vehicle, contact a NISSAN dealer. Correct pre-tensioner disposal procedures are set forth in the appropriate NISSAN Service Manual. Incorrect disposal procedures could cause personal injury.**

The pre-tensioner seat belt system may activate with the supplemental air bag system in certain types of collisions.

Working with the seat belt retractor, it helps tighten the seat belt when the vehicle becomes involved in certain types of collisions, helping to restrain front seat occupants.

The pre-tensioner is encased with the front seat belt's retractor and anchor. These seat belts are used the same as conventional seat belts.

When the pre-tensioner seat belt activates, a fairly loud noise may be heard, followed by the release of smoke. This smoke is not harmful and does not indicate a fire. Care should be taken not to inhale it, as it may cause irritation and choking. Those with a history of a breathing condition should get fresh air promptly.

REPAIR AND REPLACEMENT PROCEDURE

WARNING:

- **Once the air bags have been inflated, the air bag modules will not function and must be replaced. The air bag modules must be replaced by a NISSAN dealer. The inflated air bag modules cannot be repaired.**
- **The air bag systems should be inspected by a NISSAN dealer if there is any damage to the front end or side portion of the vehicle.**
- **If you need to dispose of the SRS or scrap the vehicle, contact a NISSAN dealer. Correct disposal procedures are set forth in the appropriate NISSAN Service Manual. Incorrect disposal procedures could cause personal injury.**

The air bags are designed to activate on a one-time-only basis. As a reminder, unless the SRS air bag warning light is damaged, the SRS air bag warning light remains illuminated after inflation has occurred. The repair and replacement of the SRS should be done only by a NISSAN dealer.

When maintenance work is required on the vehicle, information about the air bags and related parts should be pointed out to the person performing the maintenance. The ignition switch should always be in the "LOCK" position when working under the hood or inside the vehicle.

2 Instruments and controls

Instrument panel	2-2	Fog light switch (if equipped)	2-20
Left-Hand Drive (LHD) model	2-2	Front fog lights (if equipped)	2-20
Right-Hand Drive (RHD) model	2-3	Rear fog light (if equipped)	2-20
Meters and gauges	2-4	Wiper and washer switch	2-21
Vehicle information display (for Type B)	2-5	Windshield wiper and washer switch	2-21
Speedometer and odometer	2-5	Defogger switch (if equipped)	2-22
Trip computer	2-7	Horn	2-23
Tachometer (if equipped)	2-8	Windows	2-23
Engine coolant temperature gauge (for Type B)	2-8	Manual windows (if equipped)	2-23
Fuel gauge	2-9	Power windows (if equipped)	2-23
Automatic Transmission (AT)/Continuously Variable Transmission (CVT) position indicator (if equipped)	2-9	Clock	2-25
Instrument brightness control (for Type B)	2-10	Adjusting time	2-25
Warning/indicator lights and audible reminders	2-11	Power outlet (if equipped)	2-26
Checking bulbs	2-12	Cigarette lighter (if equipped)	2-26
Warning lights	2-12	Storages	2-27
Indicator lights	2-15	Glove box	2-27
Audible reminders	2-17	Card holder (if equipped)	2-27
Headlight and turn signal switch	2-18	Cup holders	2-27
Headlight switch	2-18	Soft bottle holder	2-28
Battery saver system (if equipped)	2-18	Sun visors	2-28
Headlight aiming control (if equipped)	2-19	Interior lights	2-29
Turn signal switch	2-19	Map light (if equipped) / Room light	2-29
		Trunk light (if equipped)	2-29

INSTRUMENT PANEL

LEFT-HAND DRIVE (LHD) MODEL

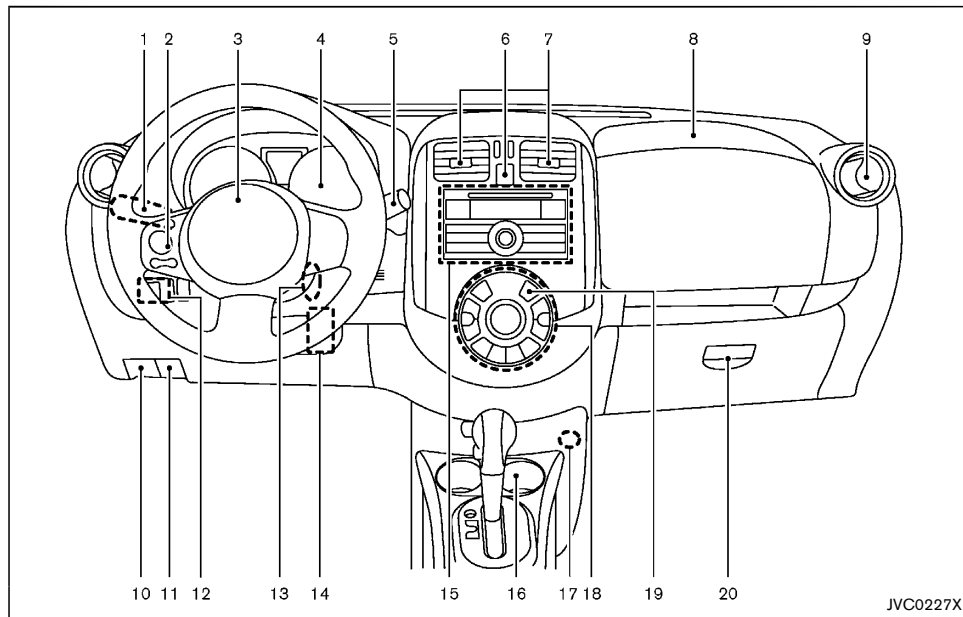

- | | |
|---|---|
| 1. Headlight, fog light* and turn signal switch | 8. Passenger's front-impact air bag* |
| 2. Steering-wheel-mounted controls* | 9. Side ventilator |
| 3. Driver's front-impact air bag/Horn | 10. Fuel filler lid release handle |
| 4. Meters and gauges | 11. Hood lock release handle |
| 5. Wiper and washer switch | 12. Outside rearview mirror control switch* |
| 6. Hazard indicator flasher switch | 13. Ignition switch/steering lock |
| 7. Center ventilator | 14. Tilting steering wheel lock lever |

- 15. Audio system*
 - 16. Cup holder
 - 17. Cigarette lighter*
 - 18. Heater and air conditioner control
 - 19. Rear window defogger switch
 - 20. Glove box
- *: if equipped

RIGHT-HAND DRIVE (RHD) MODEL

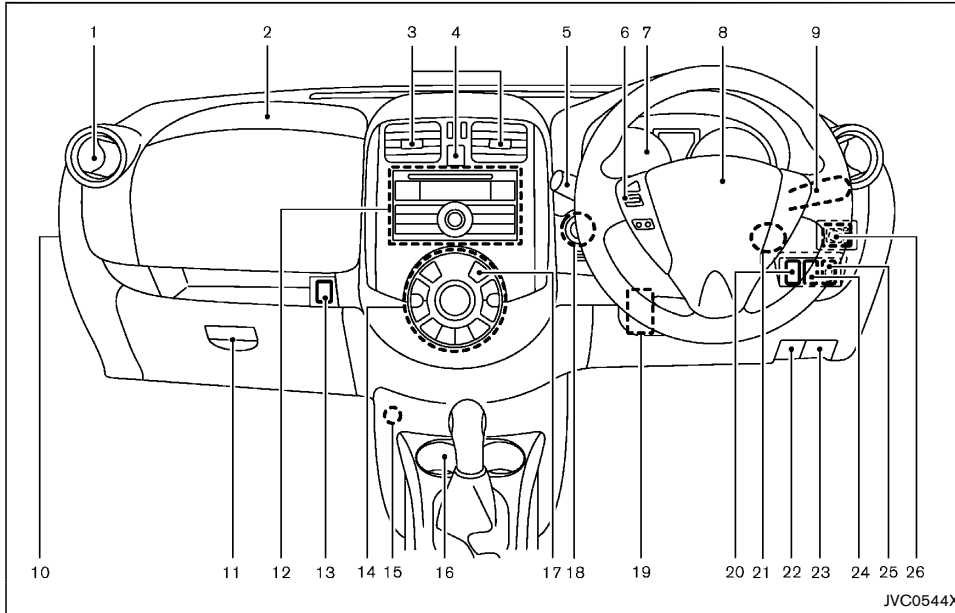

- | | |
|---------------------------------------|--|
| 1. Side ventilator | 9. Headlight and turn signal switch |
| 2. Passenger's front-impact air bag* | 10. Fuse box cover |
| 3. Center ventilator | 11. Glove box |
| 4. Hazard indicator flasher switch | 12. Audio system* |
| 5. Wiper and washer switch | 13. USB/AUX connector* |
| 6. Steering-wheel-mounted controls* | 14. Heater and air conditioner control |
| 7. Meters and gauges | 15. Power outlet* |
| 8. Driver's front-impact air bag/Horn | 16. Cup holder |

17. Rear window defogger switch
 18. Push-button ignition switch (model with Intelligent Key system)
 19. Tilting steering wheel lock lever
 20. Vehicle Dynamic Control (VDC) OFF switch* (except for Australia)
 21. Ignition switch (model without Intelligent Key system)/steering lock
 22. Hood lock release handle
 23. Fuel filler lid release handle
 24. Idling stop OFF switch* or Vehicle Dynamic Control (VDC) OFF switch (for Australia)
 25. Headlight aiming control switch*
 26. Outside rearview mirror control switch*
- *: if equipped

METERS AND GAUGES

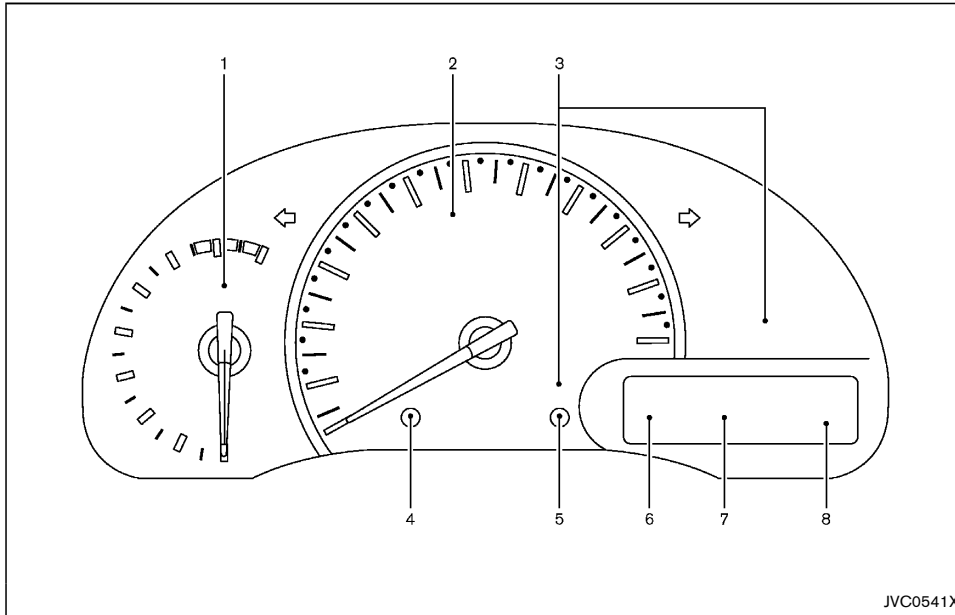

Type A

1. Tachometer*
2. Speedometer
3. Warning/indicator lights
4. Trip odometer reset switch/Trip computer mode switch
5. Clock settings switch
6. Automatic Transmission (AT)/Continuously Variable Transmission (CVT) position indicator*
7. Odometer/Twin trip odometer/Trip computer

8. Fuel gauge

*: if equipped

The needle indicators may move slightly after the ignition switch is placed in the "OFF" or "LOCK" position. This is not a malfunction.

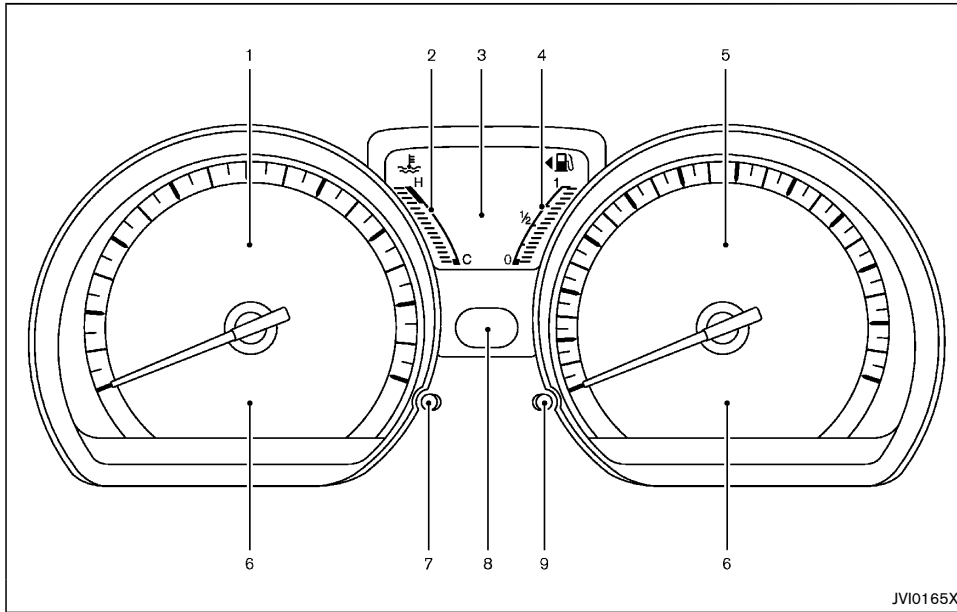

JVI0165X

Type B

1. Tachometer
2. Engine coolant temperature gauge
3. Vehicle information display
 - Odometer/Twin trip odometer
 - Trip computer
 - Clock
 - Outside air temperature*
 - Instrument brightness control display
4. Fuel gauge

5. Speedometer
6. Warning/indicator lights
7. Instrument brightness control knob
8. Automatic Transmission (AT)/Continuously Variable Transmission (CVT) position indicator*
9. Trip odometer reset switch/Trip computer mode switch

*: if equipped

The needle indicators may move slightly after the ignition switch is placed in the "OFF" or

"LOCK" position. This is not a malfunction.

VEHICLE INFORMATION DISPLAY (for Type B)

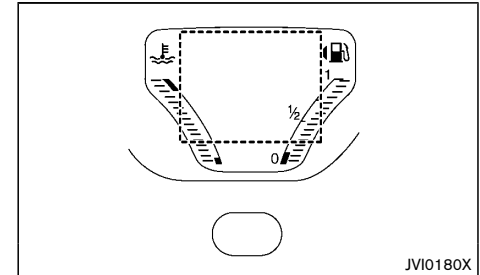

When the ignition switch is placed in the "ON" position, the vehicle information display shows the following information.

- Odometer/twin trip odometer
- Trip computer
- Clock
- Outside air temperature (if equipped)
- Instrument brightness control display

SPEEDOMETER AND ODOMETER

Speedometer

The speedometer indicates the vehicle speed.

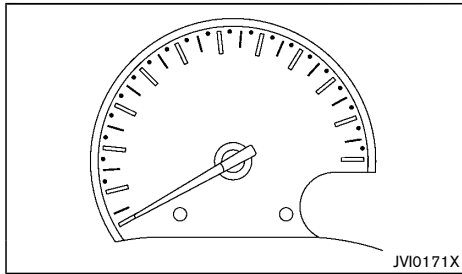

Type A

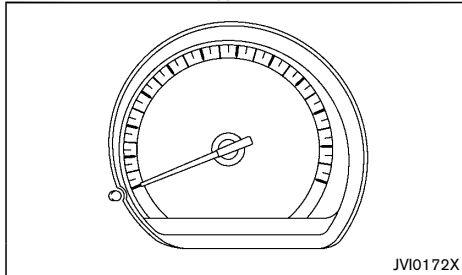

Type B

Odometer/Twin trip odometer

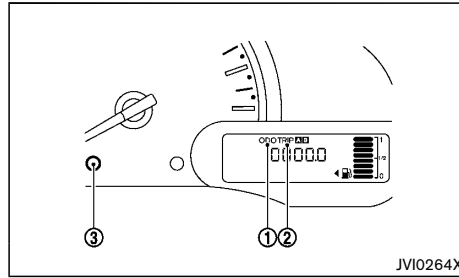

Type A

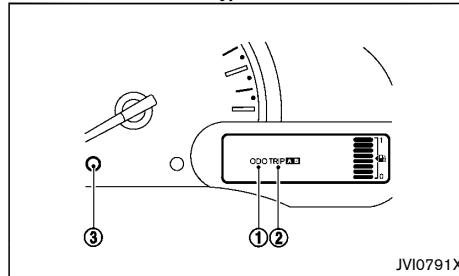

Type B

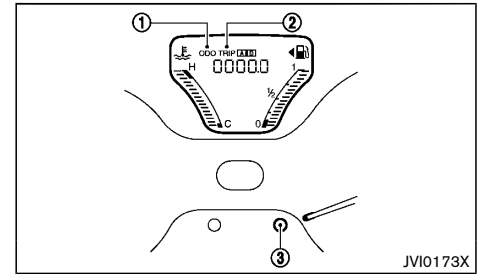

Type C

The odometer/twin trip odometer is displayed when the ignition switch is in the "ON" position.

The odometer ① displays the total distance the vehicle has been driven.

The twin trip odometer ② displays the distance of individual trips.

Changing twin trip odometer display:

Push the reset switch ③ to change the display as follows:

ODO → TRIP A → TRIP B → Trip computer mode → ODO

For trip computer information, see "Trip computer" (P.2-7).

Resetting twin trip odometer:

Push the reset switch ③ for more than 1 second to reset the trip odometer to zero.

TRIP COMPUTER

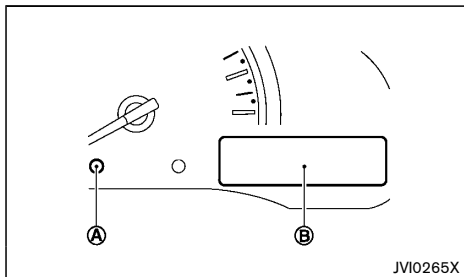

Type A

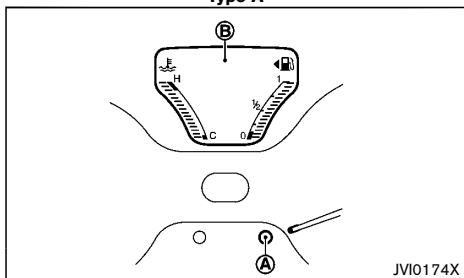

Type B

The switch for the trip computer is located on the meter panel (A).

Trip computer appears on the display (B).

When the ignition switch is placed in the "ON" position, the trip computer can be selected by pushing the trip computer mode switch (A).

Each time the trip computer mode switch (A) is pushed, the display will change as follows:

ODO → (TRIP A → TRIP B) → Current fuel consumption → Average fuel consumption → Distance to empty (dte — km) → Outside air temperature

(if equipped for Type B) → Clock settings mode

Current fuel consumption

The current fuel consumption mode shows the current fuel consumption.

Average fuel consumption (km/L)

The average fuel consumption mode shows the average fuel consumption since the last reset. Resetting is done by pushing the trip computer mode switch (A) for longer than 1 second.

The display is updated every 30 seconds. At about the first 500 m (1/3 miles) after a reset, the display shows "----".

Distance to empty (dte — km)

The distance to empty (dte) mode provides you with an estimation of the distance that can be driven before refueling. The dte is constantly being calculated, based on the amount of fuel in the fuel tank and the actual fuel consumption.

The display is updated every 30 seconds.

The dte mode includes a low range warning feature: when the fuel level is low, the dte mode is automatically selected and the digits blink in order to draw the driver's attention. Push the trip computer mode switch (A) to return to the mode that was selected before the warning occurred.

When the fuel level drops even lower, the dte display will change to "----".

- **If the amount of fuel added is small, the display just before the ignition switch is turned off may continue to be displayed.**
- **When driving uphill or rounding curves, the fuel in the tank shifts, which may momentarily change the display.**

Outside air temperature (if equipped for Type B)

The outside air temperature is displayed in °C.

When the outside air temperature decreases to 3 °C (37 °F) or lower, the outside air temperature display blinks to give a warning.

The display will stop blinking after 1 minute or when the outside air temperature increases to 4 °C (39 °F) or above.

Clock settings mode

For clock adjustment, see "Clock" (P.2-25).

Resetting displays

When the average fuel consumption or TRIP B is displayed, push the trip computer mode switch (A) for longer than 3 seconds. The display of average fuel consumption and trip odometer (TRIP B only) will be reset at the same time.

Maintenance information (if equipped for Type B)

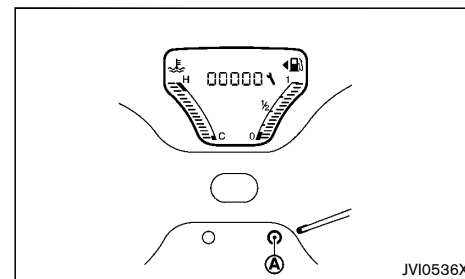



When the ignition switch is placed in the "ON" position, maintenance information (the wrench symbol  and distance to change a maintenance item)

comes on for about 5 seconds and then turns off.

The wrench symbol  appears when the set distance comes for changing an item, such as engine oil.

To set the distance to change an item:

1. Place the ignition switch in the "ON" position.
Push the trip computer mode switch  for 3 seconds while the wrench symbol  and maintenance information are displayed. The symbol and distance display will start flashing and the display shows the current interval.
2. Push the switch  to increase the interval distance.
Each step increases the interval distance by 1,000 km (500 miles). The interval distance can be set up to 30,000 km (18,000 miles) after the display returns to 0 (zero).
3. If no further action is made, the display returns to the previous mode and the new interval is set.

If the interval distance is set to 0, the display will skip the maintenance information when the ignition switch is placed in the "ON" position.

TACHOMETER (if equipped)

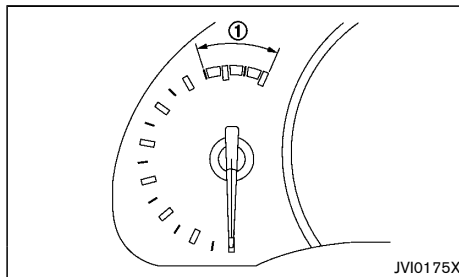

Type A

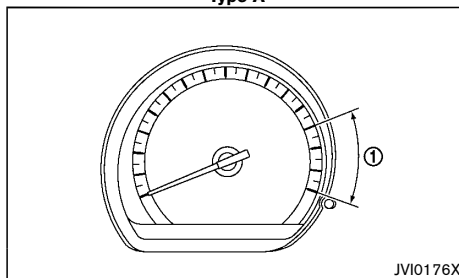



Type B

The tachometer indicates the engine speed in revolutions per minute (rpm).

Do not rev the engine into the red zone .

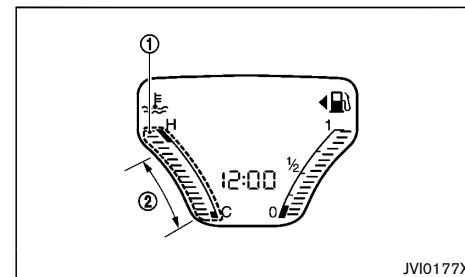
ENGINE COOLANT TEMPERATURE GAUGE (for Type B)



The engine coolant temperature gauge  indicates the engine coolant temperature.

The engine coolant temperature is normal when the gauge is within the zone  shown in the illustration.

The engine coolant temperature will vary with the outside air temperature and driving conditions.



CAUTION:

- If the gauge indicates engine coolant temperature near the hot (H) end of the normal range, reduce vehicle speed to decrease temperature.
- If the gauge is over the normal range, stop the vehicle as soon as safely possible.
- If the engine is overheated, continued operation of the vehicle may seriously damage the engine. (See "If your vehicle overheats" (P.6-10) for immediate action required.)

FUEL GAUGE

The arrow, , indicates that the fuel filler lid is located on the left side of the vehicle.



CAUTION:

Refuel before the gauge reads 0 (empty).

There is a small reserve of fuel in the tank when the fuel gauge reads 0 (empty).

Type A

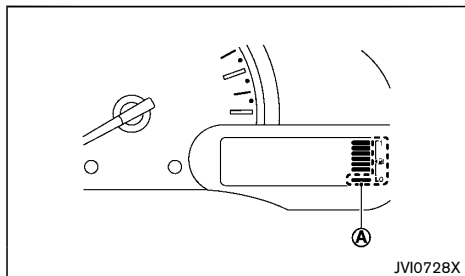

Example

The fuel gauge indicates the approximate fuel level in the tank when the ignition switch is in the "ON" position.

The gauge may move slightly during braking, turning, accelerating, or going up and down hills due to movement of fuel in the tank.

The low fuel warning light (A) blinks when the fuel level in the tank is getting low. Refuel as soon as it is convenient, preferably before the gauge reads 0.

Type B and Type C

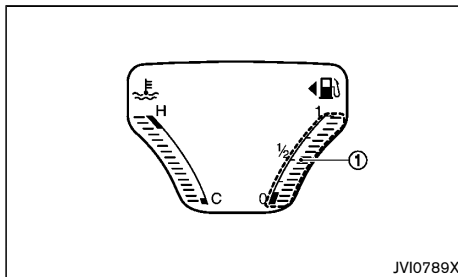

Type B

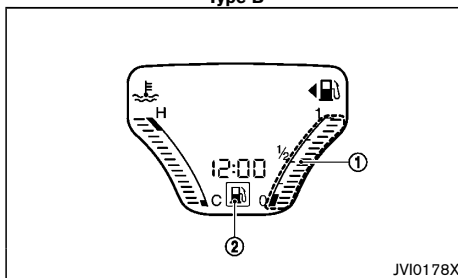

Type C

The fuel gauge (1) indicates the approximate fuel level in the tank when the ignition switch is in the "ON" position.

The gauge may move slightly during braking, turning, accelerating, or going up and down hills due to movement of fuel in the tank.

Type C: The low fuel warning light (2) illuminates when the fuel level in the tank is getting low. Refuel as soon as it is convenient, preferably before the gauge reads 0.

AUTOMATIC TRANSMISSION (AT)/CONTINUOUSLY VARIABLE TRANSMISSION (CVT) POSITION INDICATOR (if equipped)

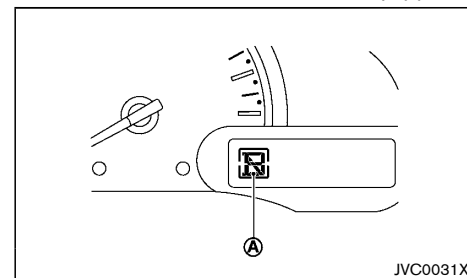

Type A

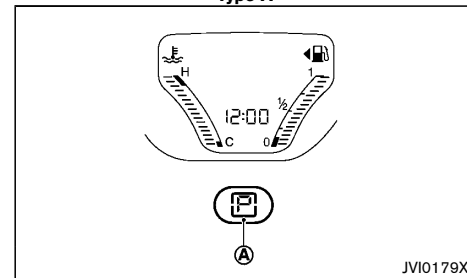

Type B

The Automatic Transmission (AT)/Continuously Variable Transmission (CVT) position indicator (A) indicates the shift lever position when the ignition switch is in the "ON" position.

INSTRUMENT BRIGHTNESS CONTROL (for Type B)

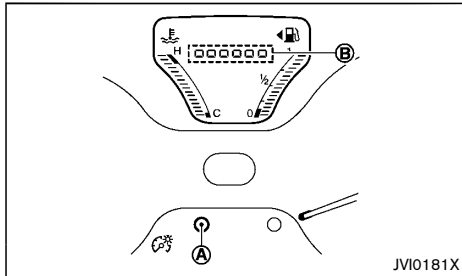





























The instrument brightness control (if equipped) operates when the ignition switch is in the "ON" position.

Push the control knob (A) to decrease the brightness of the meter panel lights. The brightness indicator (B) will be shown briefly in the display when the control knob (A) is pushed.

If the brightness mode reaches the minimum level, the next time the switch is pressed, the brightness will return to the maximum level.





When the brightness level reaches the maximum or minimum, a beep will sound.









WARNING/INDICATOR LIGHTS AND AUDIBLE REMINDERS

	Anti-lock Braking System (ABS) warning light*		Seat belt warning light*		Low temperature indicator light (green)*
	Brake warning light		Speed [120 km/h (75 MPH)] warning light*		Malfunction Indicator Light (MIL)
	Charge warning light		Supplemental Restraint System (SRS) air bag warning light		Overdrive off indicator light*
	Door open warning light		Vehicle Dynamic Control (VDC) warning light*		Rear fog light indicator light*
	Electric power steering warning light		Water-in-fuel-filter warning light (diesel engine model)		Security indicator light*
	Engine oil pressure warning light		Engine start operation indicator light*		Small light indicator light*
	High temperature warning light (red)*		Front fog lights indicator light*		SPORT mode indicator light*
	Intelligent Key system warning light*		Glow plug indicator light (diesel engine model)		Turn signals/hazard indicator lights
	Low fuel warning light*		High beam indicator light		Vehicle Dynamic Control (VDC) off indicator light*
	P position selecting warning light*		Idling Stop System indicator light*		

*: if equipped

CHECKING BULBS

With all doors closed, apply the parking brake, fasten the seat belts and place the ignition switch in the "ON" position without starting the engine. The following lights will illuminate: , , , . **PS**.

If equipped, the following lights will illuminate briefly and then turn off: , , , , .  (red),  (green), , .

If any lights fail to illuminate, it may indicate a burned-out bulb or an open circuit in the electrical system. Have the system checked, and if necessary repaired, by a NISSAN dealer promptly.

WARNING LIGHTS

 Anti-lock Braking System (ABS) warning light (if equipped)

When the ignition switch is in the "ON" position, the Anti-lock Braking System (ABS) warning light illuminates and then turns off. This indicates the ABS is operational.

If the ABS warning light illuminates while the engine is running, or while driving, it may indicate the ABS is not functioning properly. Have the system checked by a NISSAN dealer promptly.

If an ABS malfunction occurs, the anti-lock function is turned off. The brake system then operates normally, but without anti-lock assistance. (See "Anti-lock Braking System (ABS)" (P.5-27).)

 Brake warning light

 **WARNING:**

- **If the brake fluid level is below the minimum mark on the brake fluid reservoir, do not drive the vehicle until the brake system has been checked by a NISSAN dealer.**
- **Even if you judge it to be safe, have your vehicle towed because driving it could be dangerous.**
- **Depressing the foot brake pedal without the engine running and/or with a low brake fluid level could increase the stopping distance and require greater pedal travel distance and effort.**

The brake warning light indicates the parking brake system operation, a low brake fluid level of the brake system and an Anti-lock Braking System (ABS) malfunction.

Parking brake warning indicator:

When the ignition switch is in the "ON" position, and the parking brake is applied, the brake warning light illuminates. When the parking brake is released, the brake warning light turns off.

If the parking brake is not fully released, the brake warning light remains on. Be sure that the brake warning light has turned off before driving. (See "Parking brake" (P.3-23).)

Low brake fluid warning indicator:

If the brake warning light illuminates while the engine is running, or while driving, and the parking brake is released, it may indicate the brake fluid level is low.

When the brake warning light illuminates while driving,

stop the vehicle safely as soon as possible. Stop the engine and check the brake fluid level. If the brake fluid level is below the minimum mark on the reservoir, add brake fluid as necessary. (See "Brake fluid" (P.8-17).)

If the brake fluid level is sufficient, have the brake system checked by a NISSAN dealer promptly.

Anti-lock Braking System (ABS) warning indicator (if equipped):

When the parking brake is released and the brake fluid level is sufficient, if both the brake warning light and the Anti-lock Braking System (ABS) warning light illuminate, it may indicate the ABS is not functioning properly. Have the brake system checked, and if necessary repaired, by a NISSAN dealer promptly. (See "Anti-lock Braking System (ABS) warning light" (P.2-12).)

 Charge warning light

When the ignition switch is in the "ON" position, the charge warning light illuminates. After starting the engine, the charge warning light turns off. This indicates the charging system is operational.

If the charge warning light illuminates while the engine is running, or while driving, it may indicate the charging system is not functioning properly and may need servicing.

When the charge warning light illuminates while driving, stop the vehicle safely as soon as possible. Stop the engine and check the alternator belt. If the alternator belt is loose, broken or missing, the charging system needs repair. (See "Drive belts" (P.8-14).)

If the alternator belt appears to be functioning correctly but the charge warning light remains illuminated, have the charging system checked by a NISSAN dealer promptly.



CAUTION:

Do not continue driving if the alternator belt is loose, broken or missing.



Door open warning light

When the ignition switch is in the “ON” position, the door open warning light illuminates if any of the doors are open or not closed securely.



Electric power steering warning light

When the ignition switch is in the “ON” position, the electric power steering warning light illuminates. After starting the engine, the electric power steering warning light turns off. This indicates the electric power steering system is operational.

If the electric power steering warning light illuminates while the engine is running, it may indicate the electric power steering system is not functioning properly and may need servicing. Have the electric power steering system checked by a NISSAN dealer.

When the electric power steering warning light illuminates with the engine running, the power assist to the steering will cease operation but you will still have control of the vehicle. At this time, greater steering efforts are required to operate the steering wheel, especially in sharp turns and at low speeds.

(See “Electric power steering system” (P.5-25).)



Engine oil pressure warning light

When the ignition switch is in the “ON” position, the engine oil pressure warning light illuminates. After starting the engine, the engine oil pressure warning light turns off. This indicates that the oil pressure sensors in the engine are operational.

If the engine oil pressure warning light illuminates or blinks while the engine is running, it may indicate that the engine oil pressure is low.

Stop the vehicle safely as soon as possible. Stop the engine immediately and call a NISSAN dealer.



CAUTION:

- **Running the engine with the engine oil pressure warning light illuminated could cause serious damage to the engine.**
- **The engine oil pressure warning light is not designed to indicate a low oil level. The oil level should be checked using the dipstick. (See “Engine oil” (P.8-10).)**



High temperature warning light (red) (if equipped)

When the ignition switch is in the “ON” position, the high temperature warning light illuminates and then turns off. This indicates that the high temperature sensor in the engine coolant system is operational.



CAUTION:

- **If the high temperature warning light illuminates while the engine is running, it may indicate the engine temperature is extremely high.**

- **Stop the vehicle safely as soon as possible.**
- **If the vehicle is overheated, continuing vehicle operation may seriously damage the engine. (See “If your vehicle overheats” (P.6-10) for the immediate action required.)**



Intelligent Key system warning light (if equipped)

After the ignition switch is placed in the “ON” position, this light comes on for about 2 seconds and then turns off.

This light illuminates or blinks as follows:

- The light blinks in yellow when the door is closed with the Intelligent Key left outside the vehicle and the ignition switch in the “ACC” or “ON” position. Make sure that the Intelligent Key is inside the vehicle.
- The light blinks in green when the Intelligent Key battery is running out of power. Replace the battery with a new one. See “Intelligent Key battery” (P.8-23).
- The light illuminates in yellow when it warns of a malfunction with the electrical steering lock system or the Intelligent Key system.

If the warning light illuminates in yellow while the engine is stopped, it may be impossible to free the steering lock or to start the engine. If the light comes on while the engine is running, you can drive the vehicle. However in these cases, contact a NISSAN dealer for repair as soon as possible.

 Low fuel warning light (if equipped)

The low fuel warning light illuminates when the fuel level in the tank is getting low. Refuel as soon as it is convenient, preferably before the fuel gauge reaches the empty (0) position. There will be a small reserve of fuel remaining in the tank when the fuel gauge reaches the empty (0) position.

 P position selecting warning light (if equipped)

The warning light blinks in red when the ignition switch is pushed to stop the engine with the shift lever in any position except the “P” (Park) position.

If this warning appears, move the shift lever to the “P” (Park) position or push the ignition switch to the “ON” position.

An inside warning chime will also sound.

(See “Intelligent Key system” (P.3-8).)

 Seat belt warning light (if equipped)

When the ignition switch is in the “ON” position, the seat belt warning light illuminates. The light will continue to illuminate until the driver’s seat belt is fastened.

When the vehicle speed exceeds 15 km/h (10 MPH), the light will blink and the chime will sound unless the driver’s seat belt is securely fastened. The chime will continue to sound for about 90 seconds until the seat belt is fastened.

(See “Seat belts” (P.1-6).)

 Speed [120 km/h (75 MPH)] warning light (if equipped)

This light blinks when the vehicle speed goes over approximately 120 km/h (75 MPH). Be sure to observe the speed limit in the area where you are driving.

 Supplemental Restraint System (SRS) air bag warning light

When the ignition switch is in the “ON” position, the Supplemental Restraint System (SRS) air bag warning light illuminates for about 7 seconds and then turns off. This indicates that the SRS air bag system is operational.

If any of the following conditions occur, the SRS air bag system and pre-tensioner seat belt need servicing. Have the system checked, and if necessary repaired, by a NISSAN dealer promptly.

- The SRS air bag warning light remains illuminated after about 7 seconds.
- The SRS air bag warning light flashes intermittently.
- The SRS air bag warning light does not illuminate at all.

Unless checked and repaired, the SRS air bag system and/or pre-tensioner seat belt may not function properly. (See “Supplemental air bag systems” (P.1-22).)

 Vehicle Dynamic Control (VDC) warning light (if equipped)

When the ignition switch is in the “ON” position, the Vehicle Dynamic Control (VDC) warning light illuminates and then turns off. This indicates the VDC system is operational.

The warning light blinks when the VDC system is operating.

When the warning light blinks while driving, the driving condition is slippery and the vehicle’s traction limit is about to be exceeded.

If the warning light illuminates when the ignition switch is placed in the “ON” position, it may indicate that the VDC system is not functioning properly and may need servicing. Have the system checked, and if necessary repaired, by a NISSAN dealer promptly.

If a malfunction occurs in the system, the VDC system function will be cancelled but the vehicle is still driveable. (See “Vehicle Dynamic Control (VDC) system” (P.5-21).)

 Water-in-fuel-filter warning light (diesel engine model)

If the water-in-fuel-filter warning light illuminates while the engine is running, drain the water from the fuel filter promptly. See “Fuel filter (diesel engine model)” (P.8-13).



CAUTION:

Continuing vehicle operation without properly draining could cause serious damage to the engine.

INDICATOR LIGHTS



Engine start operation indicator light (if equipped)

This light appears when the shift lever is in the “P” (Park) position (Automatic Transmission/Continuously Variable Transmission model) or “N” (Neutral) position (Manual Transmission model). This light means that the engine will start by pushing the ignition switch with the brake pedal (AT/CVT model) or the clutch pedal (MT model) depressed. You can start the engine directly in any position.



Front fog lights indicator light (if equipped)

The front fog lights indicator light illuminates when the front fog lights are on. (See “Fog light switch” (P.2-20).)



Glow plug indicator light (diesel engine model)

When the ignition switch is in the “ON” position, the glow plug indicator light illuminates and turns off after the glow plugs have warmed up. If the glow plugs have already warmed up, the glow plug indicator flashes briefly and then turns off.



High beam indicator light

The high beam indicator light illuminates when the headlight high beam is “ON”. The indicator turns off when the low beam is selected. (See “Headlight and turn signal switch” (P.2-18).)



Idling Stop System indicator light (if equipped for Thailand)

The Idling Stop System indicator light illuminates in the meter when the Idling Stop System is activated.

The Idling Stop System indicator light blinks at a high speed, when the driver’s door or the engine hood is open.

The Idling Stop System indicator light blinks at a low speed, when the Idling Stop System is malfunctioning.

NOTE:

- **When the Idling Stop System indicator light blinks at a high speed (twice approximately every one second):**
 - Be sure to check if the driver’s door is open.
 - Be sure to check if the engine hood is open. When the engine hood is opened the engine will be in the normal stopped state. In this case, restart the engine with the ignition switch.
- **When the Idling Stop System indicator light blinks at a low speed (once approximately every two seconds), have the system checked, and if necessary repaired, by a NISSAN dealer promptly.**



Idling Stop System indicator light (for Hong Kong)

The Idling Stop System indicator light illuminates in the meter when the Idling Stop System is activated or is in the ready state.

The Idling Stop System indicator light blinks at a high speed when the engine hood is open.

The Idling Stop System indicator light blinks at a low speed, when the Idling Stop System is malfunctioning.

NOTE:

- **When the Idling Stop System indicator light blinks at a high speed (twice approximately every one second), be sure to check if the engine hood is open. When the engine hood is opened the engine will be in the normal stopped state. In this case, restart the engine with the ignition switch.**
- **When the Idling Stop System indicator light blinks at a low speed (once approximately every two seconds), have the system checked, and if necessary repaired, by a NISSAN dealer promptly.**
- **Even if the Idling Stop System indicator light illuminates before stopping your vehicle, the Idling Stop System may not activate when you are driving on an uphill or downhill grade, or when the steering wheel is operated, etc.**



Low temperature indicator light (green) (if equipped)

The low temperature indicator light illuminates when the engine coolant temperature is low.

When the ignition switch is in the “ON” position, the low temperature indicator light illuminates and then turns off after the engine coolant has warmed up.

If the low temperature indicator light stays illuminated after the engine has sufficiently warmed up, it may indicate the low temperature sensor in the engine coolant system is not functioning properly and may need servicing. Have the system checked, and if necessary repaired, by a NISSAN dealer promptly.



Malfunction Indicator Light (MIL)



CAUTION:

- **Continuing vehicle operation without proper servicing of the engine control system could lead to poor driveability, reduced fuel economy, and damage to the engine control system, which may affect the vehicle's warranty coverage.**
- **Incorrect setting of the engine control system may lead to non-compliance of local and national emission laws and regulations.**

When the ignition switch is in the "ON" position, the Malfunction Indicator Light (MIL) illuminates. After starting the engine, the MIL turns off. This indicates that the engine control system is operational.

If the MIL illuminates or blinks (if equipped) while the engine is running, it may indicate that the engine control system is not functioning properly and may need servicing. Have the system checked, and if necessary repaired, by a NISSAN dealer promptly.

Malfunction Indicator Light (MIL) on steady:

An engine control system malfunction has been detected. Have the vehicle checked, and if necessary repaired, by a NISSAN dealer promptly. You do not need to have your vehicle towed to the dealer.

Malfunction Indicator Light (MIL) blinking (if equipped):

An engine misfire has been detected which may damage the engine control system. Have the vehicle checked, and if necessary repaired, by a NISSAN dealer promptly.

Precautions:

To reduce or avoid possible damage to the engine control system when the MIL illuminates:

- Avoid driving at speeds above 70 km/h (43 MPH).
- Avoid sudden acceleration or deceleration.
- Avoid going up steep uphill grades.
- Avoid carrying or towing unnecessary loads.



Overdrive off indicator light (if equipped)

The overdrive off indicator light illuminates when the overdrive is turned OFF. (See "Driving with Automatic Transmission (AT)" (P.5-10) for the use of the overdrive off switch.)



Rear fog light indicator light (if equipped)

The rear fog light indicator light illuminates when the rear fog light is on. (See "Fog light switch" (P.2-20).)



Security indicator light (if equipped)

The security indicator light blinks when the ignition switch is in the "LOCK", "OFF" or "ACC" position. This function indicates the NATS (NISSAN Anti-Theft System)* equipped on the vehicle is operational.

(* immobilizer)

If NATS is malfunctioning, this light will remain on while the ignition switch is in the "ON" position. (See "Security system" (P.3-17) for additional information.)



Small light indicator light (if equipped)

The small light indicator light illuminates when the front clearance lights, instrument panel lights, rear combination lights and license plate lights are on. The indicator light turns off when these lights are turned off.



SPORT mode indicator light (if equipped)

The SPORT mode indicator light illuminates when the SPORT mode is turned "ON". (See "Driving with Continuously Variable Transmission (CVT)" (P.5-13) for the use of the SPORT mode switch.)



Turn signals/hazard indicator lights

The turn signals/hazard indicator lights blink when the turn signal switch lever or hazard indicator flasher switch is "ON". (See "Headlight and turn signal switch" (P.2-18) or "Hazard indicator flasher switch" (P.6-2).)



Vehicle Dynamic Control (VDC) off indicator light (if equipped)

The Vehicle Dynamic Control (VDC) off indicator light illuminates when the VDC off switch is pushed to the "OFF" position.

When the VDC off switch is pushed to the "OFF" position, the VDC system is turned off. (See "Vehicle Dynamic Control (VDC) system" (P.5-21).)

AUDIBLE REMINDERS

Brake pad wear warning

The disc brake pads have audible wear warnings. When a brake pad requires replacement, it will make a high pitched scraping sound when the vehicle is in motion. This scraping sound will first occur only when the brake pedal is depressed. After more wear of the brake pad, the sound will always be heard even if the brake pedal is not depressed. Have the brakes checked as soon as possible if the wear warning sound is heard.

Have the system checked, and if necessary repaired, by a NISSAN dealer promptly. (See “Brakes” (P.8-15).)

Key reminder chime

The key reminder chime will sound if any of the following operations are detected:

Model with Intelligent Key system:

- The driver’s door is opened while the ignition switch is in the “ACC” position.

Model without Intelligent Key system:

- The driver’s door is opened while the key is left in the ignition switch and the ignition switch is in the “ACC”, “OFF” or “LOCK” position (Type A).
- The driver’s door is locked with the power door lock switch with the door open while the key is left in the ignition switch and the ignition switch is in the “ACC”, “OFF” or “LOCK” position (Type B).

Be sure that the ignition switch is switched to the “LOCK” position when the door is opened, and carry the Intelligent Key with you when leaving the vehicle.

For the Intelligent Key system, an inside or outside chime will sound under some conditions. When a chime sounds, be sure to check both the vehicle and

the Intelligent Key. (See “Intelligent Key system” (P.3-8).)

Light reminder chime

The light reminder chime will sound if the driver’s door is opened while the headlight switch is in the D or D position and the ignition switch is in the “ACC”, “OFF” or “LOCK” position.

Be sure to turn the light switch to the “OFF” position when you leave the vehicle.

Parking brake reminder chime

The parking brake reminder chime will sound if the vehicle is driven at more than 7 km/h (4 MPH) with the parking brake applied. Stop the vehicle and release the parking brake.

Seat belt warning chime (if equipped)

When the vehicle speed exceeds 15 km/h (10 MPH), the chime will sound unless the driver’s seat belt is securely fastened. The chime will continue to sound for about 90 seconds until the seat belt is fastened.

Idling Stop System reminder buzzer (if equipped for Thailand)

The Idling Stop System reminder buzzer will sound if the driver’s door or the engine hood is opened while the Idling Stop System is activated.

Idling Stop System reminder buzzer (for Hong Kong)

The Idling Stop System reminder buzzer will sound if the engine hood is opened while the Idling Stop System is activated.

Reverse reminder chime (if equipped)

The chime will sound inside the vehicle to remind the driver if the shift lever is in the “R” (Reverse) position while the ignition switch is in the “ON” position. This is not a chime to remind people outside the vehicle.

HEADLIGHT AND TURN SIGNAL SWITCH

HEADLIGHT SWITCH

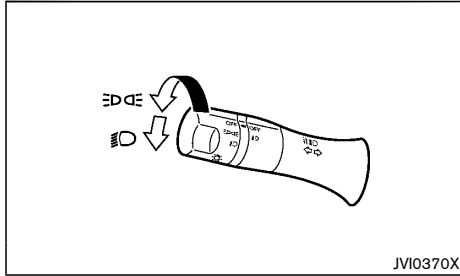

Type A

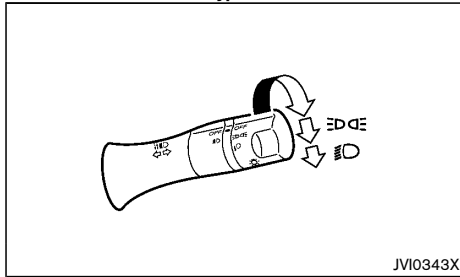

Type B

NISSAN recommends that you consult the local regulations concerning the use of lights.

☰ position

The ☰ position turns on the front clearance lights, instrument panel lights, rear combination lights and other lights.

☷ position

The ☷ position turns on the headlights in addition to the other lights.

Headlight beam

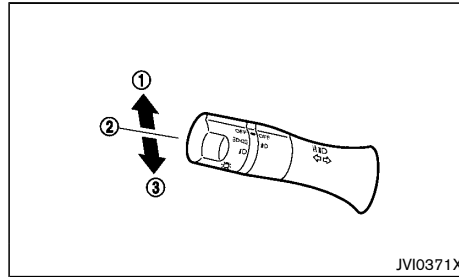

Type A

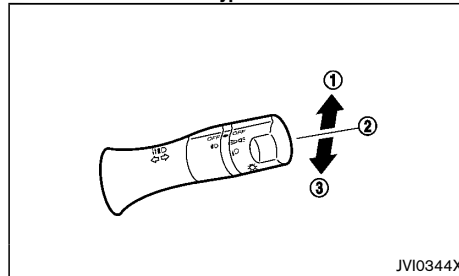

Type B

To turn on the high beam, push the lever towards the front position ①.

To turn off the high beam, return the lever to the neutral position ②.

To flash the headlights, pull the lever towards the rearmost position ③. The headlights can be flashed even when the headlights are not on.

When the lever is pulled towards the rearmost position ③ after the ignition switch is placed in the "OFF" or "LOCK" position, the headlight will turn on and stay on for 30 seconds. The lever can be pulled 4 times for up to 2 minutes (if equipped).

Daytime running light system (if equipped)

The daytime running lights will come on after starting the engine.

When the light switch is turned to the ☰ position, the daytime running lights will turn off.

BATTERY SAVER SYSTEM (if equipped)

The light reminder chime will sound if the driver's door is opened while the following improper operations are found:

- The headlight switch is in either the ☰ or ☷ position, and the ignition switch in the "ACC", "OFF" or "LOCK" position.



Be sure to turn the headlight switch to the "OFF" position when you leave the vehicle.

Type A

When the headlight switch is in the ☰ or ☷ position while the engine is running, the lights will automatically turn off after placing the ignition switch in the "ACC", "OFF" or "LOCK" position and opening the driver's side door.

When the headlight switch remains in either the ☰ or ☷ position after the lights automatically turn off, the lights will turn on when the ignition switch is placed in the "ON" position or the engine is started.

Type B

If the doors are closed and locked with the remote controller, the Intelligent Key or the door request switch (if equipped) while the headlight switch is in either the  or  position, the battery saver function will turn off the lights to prevent the battery from being discharged. The lights will turn on when the doors are being opened.



CAUTION:

Do not leave the lights on when the engine is not running for extended periods of time to prevent the battery from being discharged.

HEADLIGHT AIMING CONTROL (if equipped)

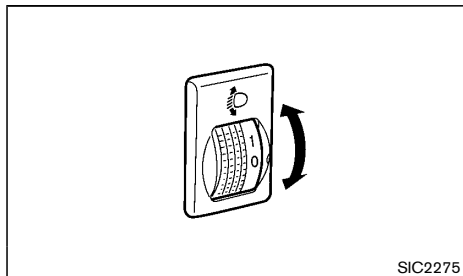

SIC2275

The headlight aiming control operates when the ignition switch is in the "ON" position and the headlight is on to allow the headlight axis to be adjusted according to the driving condition.

When driving with no heavy load/luggage or driving on a flat road, select the normal position "0".

If the number of occupants and load/luggage in the vehicle changes, the headlight axis may become higher

than normal.

If the vehicle is traveling on a hilly road, the headlights may directly shine on the rearview and outside mirrors of a vehicle ahead or the windshield of an oncoming vehicle, which may obscure other drivers' vision.

To adjust to the proper aiming height, turn the switch accordingly. The higher the number designated on the switch, the lower the headlight axis.

For Hong Kong:

Select the switch position by referring to the following samples.

Switch position	Number of front seat occupants	Number of rear seat occupants	Weight of load in luggage compartment
0	1 or 2	No occupants	No load
1	2	3	No load
2	2	3	Approximately 65 kg (143 lb)
3	1	No occupants	Approximately 258 kg (569 lb)

For the Middle East:

Select the switch position by referring to the following samples.

Switch position	Number of front seat occupants	Number of rear seat occupants	Weight of load in luggage compartment
0	1 or 2	No occupants	No load
1	2	3	No load
1	2	3	Approximately 24 kg (53 lb)*1
2	2	3	Approximately 65 kg (143 lb)*2
3	1	No occupants	Approximately 258 kg (569 lb)

*1: For mid grade models

*2: Except for mid grade models

TURN SIGNAL SWITCH

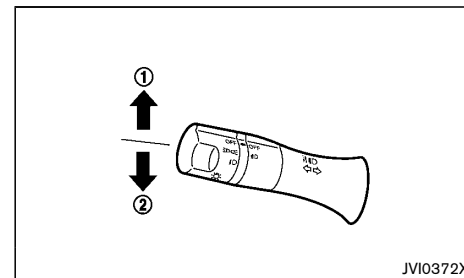

Type A

FOG LIGHT SWITCH (if equipped)

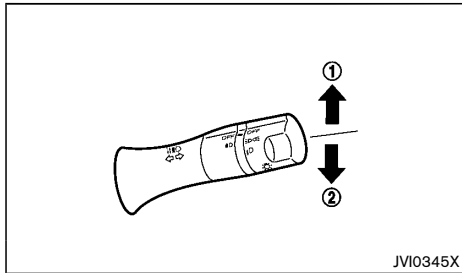

CAUTION:

The turn signal switch will not be cancelled automatically if the steering wheel turning angle does not exceed the preset amount. After the turn or lane change, make sure that the turn signal switch is returned to its original position.

Turn signal

To turn on the turn signals, move the lever up ① or down ② towards the desired direction. When the turn is completed, the turn signal cancels automatically.



Lane change signal

To turn on the lane change signals, move the lever up ① or down ② towards the desired direction.

To cancel the flashing, move the lever to the opposite direction.

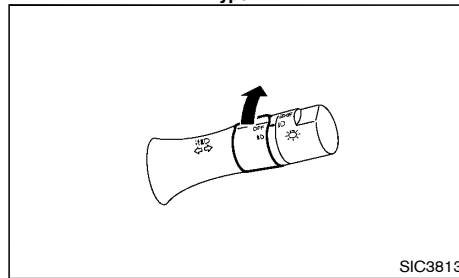
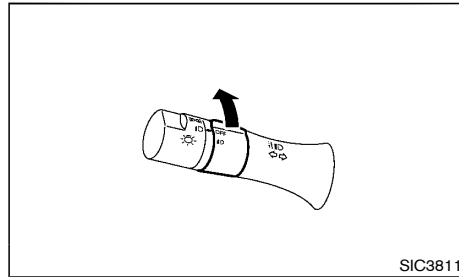
FRONT FOG LIGHTS (if equipped)





To turn on the front fog lights, turn the fog light switch to the  position with the headlight switch in the  or  position.

To turn off the fog lights, turn the fog light switch to the "OFF" position.

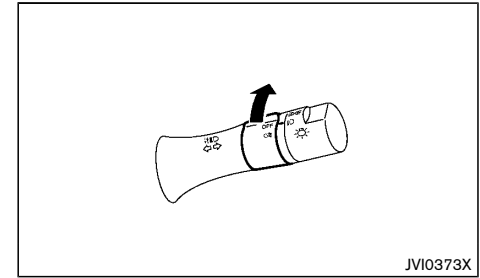
REAR FOG LIGHT (if equipped)



To turn on the rear fog light, turn the fog light switch to the  position with the headlight switch in the  or  position.

To turn off the fog light, turn the fog light switch to the "OFF" position.

The rear fog light should be used only when visibility is seriously reduced. [Generally, to less than 100 m (328 ft)]

WIPER AND WASHER SWITCH

WARNING:

In freezing temperatures, the washer fluid may freeze on the windshield and obscure your vision. Warm the windshield with the defogger before you wash the windshield.

CAUTION:

- Do not operate the washer continuously for longer than 30 seconds.
- Do not operate the washer if the window washer fluid reservoir is empty.
- If the wiper operation is interrupted by snow or ice, the wiper may stop moving to protect its motor. If this occurs, turn the wiper switch to the “OFF” position and remove the snow or ice on and around the wiper arms. In approximately 1 minute, turn the switch on again to operate the wiper.

WINDSHIELD WIPER AND WASHER SWITCH

The windshield wiper and washer operate when the ignition switch is in the “ON” position.

Wiper operation

Type A and Type B:

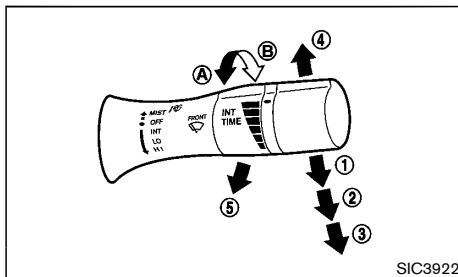

Type A

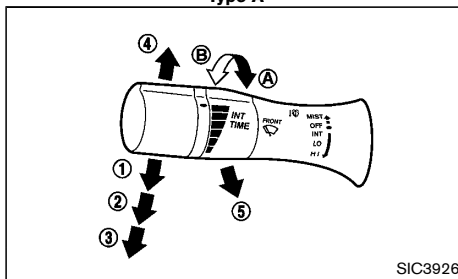

Type B

The lever position “INT” ① operates the wiper intermittently.

- The intermittent operation can be adjusted by turning the adjustment control knob, (longer) A or (shorter) B .
- The intermittent operation speed varies in accordance with the vehicle speed. (For example, when the vehicle speed is high, the intermittent operation speed will be faster.)

The lever position “LO” ② operates the wiper at low

speed.

The lever position “HI” ③ operates the wiper at high speed.

To stop the wiper operation, move the lever up to the “OFF” position.

The lever position “MIST” ④ operates the wiper one sweep. The lever automatically returns to its original position.

Type C and Type D:

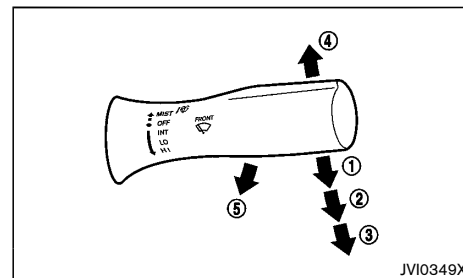

Type C

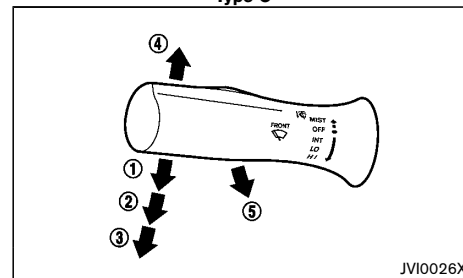

Type D

The lever position “INT” ① operates the wiper intermittently.

DEFOGGER SWITCH (if equipped)

The lever position "LO" ② operates the wiper at low speed.

The lever position "HI" ③ operates the wiper at high speed.

To stop the wiper operation, move the lever up to the "OFF" position.

The lever position "MIST" ④ operates the wiper one sweep. The lever automatically returns to its original position.

Washer operation

To operate the washer, pull the lever toward the back of the vehicle ⑤ until the desired amount of washer fluid is spread on the windshield. The wiper will automatically operate several times.

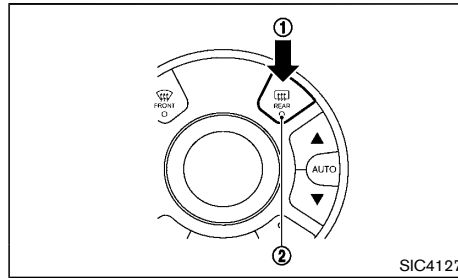

Type A

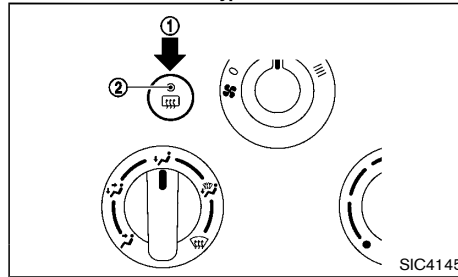

Type B

The rear window defogger switch operates when the ignition switch is in the "ON" position.

The defogger is used to reduce the moisture, fog or frost on the rear window surface to improve the rear view.

When the defogger switch ① is pushed, the indicator light ② illuminates and the defogger operates for approximately 15 minutes. After the preset time has passed, the defogger will turn off automatically.

To turn off the defogger manually, push the defogger switch again.



CAUTION:

- When operating the defogger continuously, be sure to start the engine. Otherwise, it may cause the battery to discharge.
- When cleaning the inner side of the window, be careful not to scratch or damage the electrical conductors on the surface of the window.

HORN

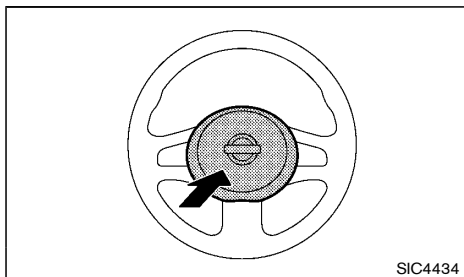

Type A

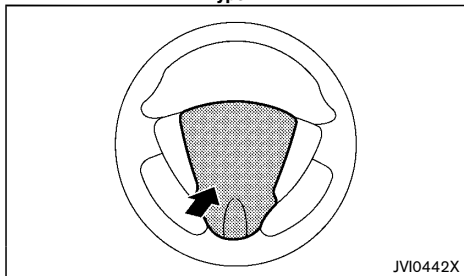

Type B

The horn switch operates regardless of the ignition switch position except when the battery is discharged.

When the horn switch is pushed and held, the horn will sound. Releasing the horn switch will cease the horn sound.

WINDOWS

MANUAL WINDOWS (if equipped)

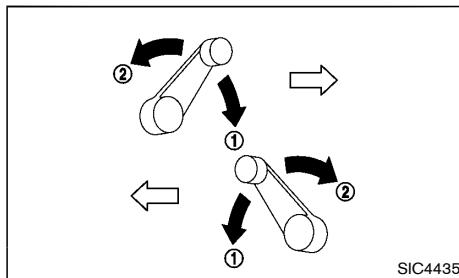

The side windows can be opened ① or closed ② by turning the hand crank on each door.

POWER WINDOWS (if equipped)



WARNING:

- **Make sure that all passengers have their hands, etc. inside the vehicle before operating the power windows.**
- **Never leave children or adults who would normally require the support of others alone in the vehicle. They could unknowingly activate switches or controls and inadvertently become involved in an accident.**

The power windows operate when the ignition switch is in the "ON" position.

To open a window, push down the power window switch.

To close a window, pull up the power window switch.

Driver's window switch

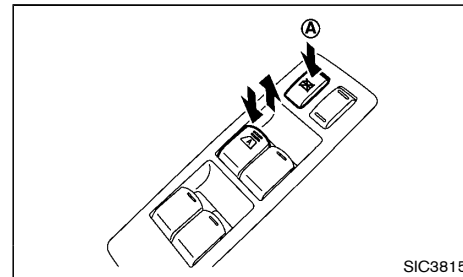

The driver's switch, which is the main switch, can control all windows.

Locking passengers' windows:

When the lock button (A) is pushed in, the passengers' windows cannot be operated.

To cancel the passengers' windows lock, push the lock button (A) again.

Passenger's window switch

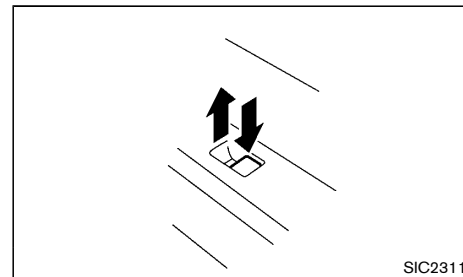

The passenger's switch can control its corresponding window.

When the passenger's windows lock button on the driver's switch is pushed in, the passenger's switch cannot be operated.

Automatic function

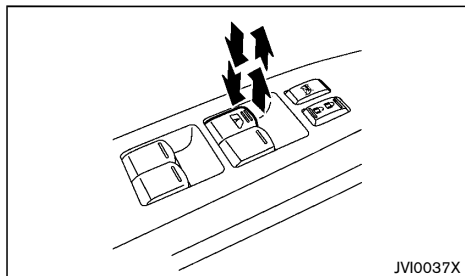

Automatic function is available for the switch that has an **A** mark on its surface.

The automatic function enables a window to fully open or close (if equipped) without holding the switch down or up.

To fully open the window, push the power window switch down to the second detent and release the switch. To fully close (if equipped) the window, pull the power window switch up to the second detent and release the switch. The switch does not have to be held during window operation.

To stop the window open/close operation during the automatic function, push down or pull up the switch in opposite directions.

Auto-reverse function (if equipped):



WARNING:

There is a small distance just before the closed position which cannot be detected. Make sure that all passengers have their hands, etc. inside the vehicle before closing the windows.

The auto-reverse function enables a window to automatically reverse when something is caught in the window as it is closing by the automatic function. When the control unit detects an obstacle, the window will be lowered immediately.

Depending on the environment or driving conditions, the auto-reverse function may activate if an impact or load similar to something being caught in the window occurs.

When power window switch does not operate

Some power window functions (automatic close function, auto-reverse function) will not operate as described after the battery cable is disconnected and the electrical supply is interrupted. Perform the following procedure to initialize the power window functions.

1. Place the ignition switch in the "ON" position.
2. If the driver's window is closed, open it completely by operating the driver's window switch.
3. Pull up and hold the driver's window switch to close the driver's window. Hold the switch for approximately 3 seconds after the window has been fully closed, and then release it.
4. Check if the power window functions operate properly.

If you open or close the power window continuously, it

may cause the power window not to operate properly. Perform the above procedure.

If the power window functions do not operate properly after performing the above procedure, repeat the steps. See a NISSAN dealer, if necessary, for checking the power window system.

CLOCK

If the battery cable is disconnected, the clock will be reset and the correct time will not be indicated. Readjust the time.

For the clock adjustment in the audio unit see "Audio system" (P.4-10).

ADJUSTING TIME

Type A

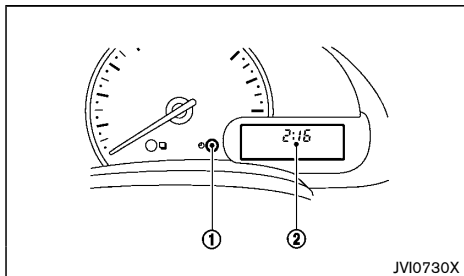

Example

The digital clock ② in the meter displays the time when the ignition switch is in the "ON" position.

To display the clock, push the clock settings switch ①. To adjust the time, perform the following procedure.

1. Push the clock settings switch ① for more than 1.5 seconds or 3 seconds to enter clock adjusting mode.
The hours display will start to flash.
2. Push the clock settings switch ① to adjust the hour.
To advance the time, hold down the switch ①.
3. Wait at least 3 seconds or 5 seconds for the minute display to flash.

4. Push the clock settings switch ① to adjust the minutes.

To advance the time, hold down the switch ①.

Wait at least 3 seconds or 5 seconds for the second display ":" to flash.

5. Push the clock settings switch ① to reset the second counter.

The selected values will be stored if no user input is detected for 60 seconds, or can be reset by using the clock settings switch ①.

Type B

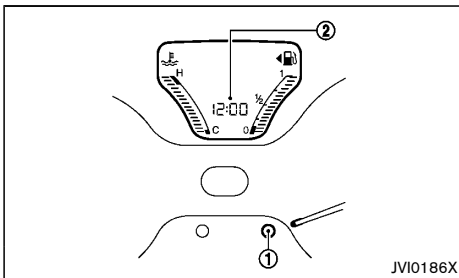

The digital clock ② in the meter displays the time when the ignition switch is in the "ON" position. To adjust the time, perform the following procedure:

1. If the trip computer mode switch ① is pushed while the distance to empty or outside air temperature (if equipped) is displayed, the clock display will blink.
2. Push the clock settings switch ① for more than 1.5 seconds or 3 seconds. The hours display will start to flash.

3. Push the clock settings switch ① to adjust the hour. To advance the time, hold down the switch ①.
4. Wait at least 3 seconds or 5 seconds for the minute display to flash.
5. Push the clock settings switch ① to adjust the minutes. To advance the time, hold down the switch ①. Wait at least 3 seconds or 5 seconds for the second display ":" to flash.
6. Push the clock settings switch ① to reset the second counter.

POWER OUTLET (if equipped)

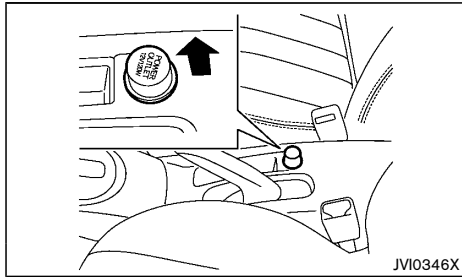

Type A

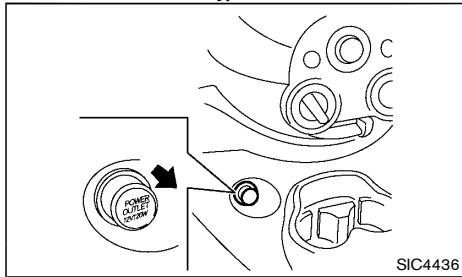

Type B

The power outlet is for powering electrical accessories such as cellular telephone.

CAUTION:

- The outlet and plug may be hot during or immediately after use.
- This power outlet is not designed for use with a cigarette lighter unit.
- Do not use with accessories that exceed a 12 volt, 120W (10A) power draw. Do not use double adapters or more than one electrical accessory.

- Use power outlet with the engine running to avoid discharging the vehicle battery.
- Avoid using power outlet when the air conditioner, headlights or rear window defogger is on.
- Before inserting or disconnecting a plug, be sure to turn off the power switch of electrical accessory being used and the ignition switch.
- Push the plug in as far as it will go. If good contact is not made, the plug may overheat or the internal temperature fuse may open.
- Do not allow water to contact the outlet.
- When not in use, be sure to close the cap.

CIGARETTE LIGHTER (if equipped)

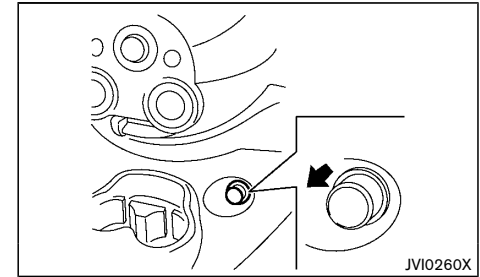

WARNING:

The cigarette lighter should not be used while driving so that full attention may be given to vehicle operation.

CAUTION:

- The cigarette lighter socket is a power source for the cigarette lighter element only. The use of the cigarette lighter socket as a power source for any other accessory is not recommended.
- Do not use any other power outlet for an accessory lighter.

The cigarette lighter operates when the ignition switch is in the "ACC" or "ON" position. To heat the cigarette lighter, push it in until it latches. When the lighter is heated, it will spring out automatically.

Return the cigarette lighter to its original position after use.

STORAGES



WARNING:

- The storages should not be used while driving so full attention may be given to vehicle operation.
- Keep the storage lids closed while driving to help prevent injury in an accident or a sudden stop.

GLOVE BOX

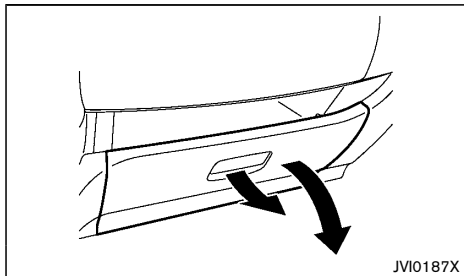

JVI0187X

To open the glove box, pull the handle.

To close, push the lid in until the lock latches.

CARD HOLDER (if equipped)

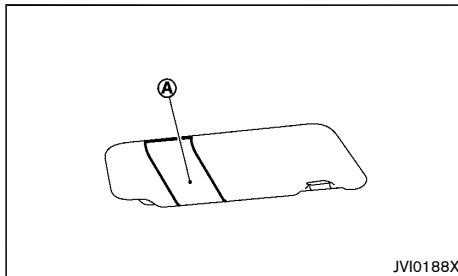

JVI0188X

Slide a card in the card holder (A).

CUP HOLDERS



CAUTION:

Avoid abrupt starting and braking especially when the cup holder is being used to prevent spilling the contents. If the contents are hot, they could scald you or your passengers.

Front

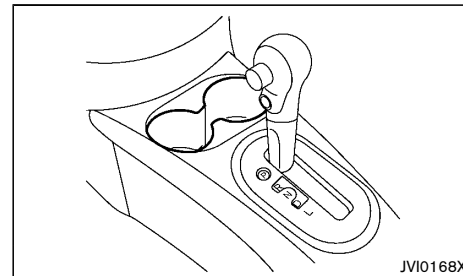

JVI0168X

Front of center console



SIC4409

Rear of center console (Type A)

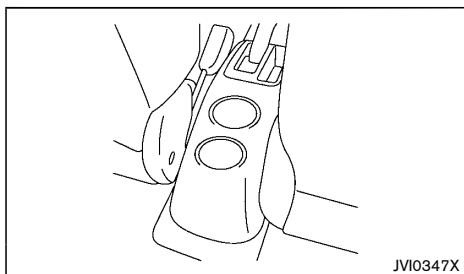

Rear of center console (Type B)

SOFT BOTTLE HOLDER

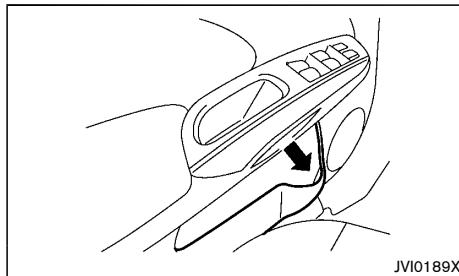

Rear (if equipped)

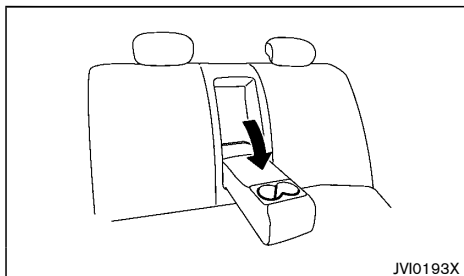

Pull the armrest forward until it is horizontal.



CAUTION:

- Do not use bottle holder for any other objects that could be thrown about in the vehicle and possibly injure people during sudden braking or an accident.
- Do not use bottle holder for open liquid containers.

SUN VISORS

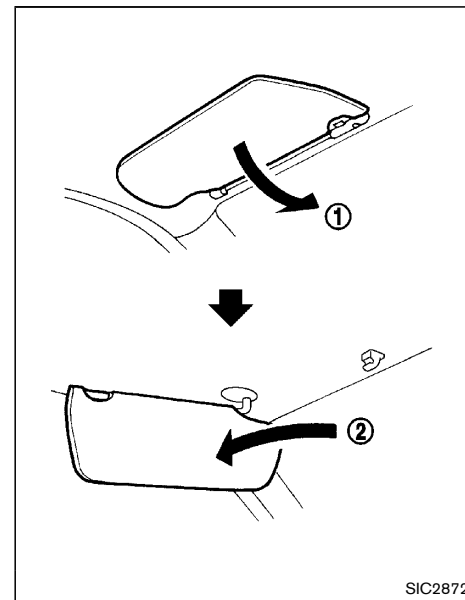

1. To block out glare from the front, swing down the sun visor ①.
2. To block glare from the side, remove the sun visor from the center mount and swing it to the side ②.

INTERIOR LIGHTS



CAUTION:

- **Do not leave the light switch on when the engine is not running for extended periods of time to prevent the battery from being discharged.**
- **Turn off the lights when you leave the vehicle.**

MAP LIGHT (if equipped) / ROOM LIGHT

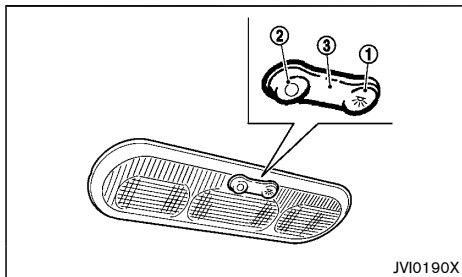

The map light (if equipped) or room light control switch has three positions: ON ①, OFF ② and center ③.

ON position

When the switch is in the ON position ①, the map light (if equipped) or room light will illuminate.

OFF position

When the switch is in the OFF position ②, the map light (if equipped) or room light will not illuminate, regardless of the condition.

Center position

When the switch is in the center position ③, the map light (if equipped) or room light will illuminate under the following conditions:

- ignition switch is placed in the “OFF” position (models with Intelligent Key system)
 - remain on for about 15 seconds.
- the key is removed from the ignition switch (models without Intelligent Key system)
 - remain on for about 15 seconds.
- doors are unlocked by pushing the “UN-LOCK”  button (on the remote controller or Intelligent Key) or the request switch (models with Intelligent Key system), with the ignition switch in the “LOCK” position
 - remain on for about 15 seconds.
- any door is opened and then closed with the ignition switch in the “LOCK” position
 - remain on for about 15 seconds.
- any door is opened with the ignition switch in the “ACC” or “ON” position
 - remain on while the door is opened. When the door is closed, the lights turn off.

Battery saver system

If any door is left open for a period of time with the map light (if equipped) or room light switch placed horizontally or the map light (if equipped) or room light switch in the center position ③, the map light (if equipped) or room light will automatically turn off.

TRUNK LIGHT (if equipped)

The trunk light illuminates when the trunk lid is opened. When the trunk is closed, the light will turn off.

MEMO

3 Pre-driving checks and adjustments

Keys	3-2	Security system (if equipped)	3-17
Key (if equipped)	3-2	Theft warning system (if equipped)	3-17
NISSAN Anti-Theft System (NATS) key (if equipped)	3-3	NISSAN Anti-Theft System (NATS)	3-17
Intelligent Key (if equipped)	3-3	Hood	3-18
Door locks	3-4	Opening hood	3-19
Locking with key	3-4	Closing hood	3-19
Locking with inside lock knob	3-5	Trunk lid	3-19
Locking with power door lock switch (if equipped)	3-5	Opening trunk lid (if equipped)	3-20
Vehicle speed sensing door lock mechanism (if equipped)	3-5	Trunk button on remote controller (if equipped)	3-20
Auto door lock releasing mechanism (if equipped)	3-5	Trunk button on intelligent key (if equipped)	3-20
Impact sensing door lock releasing mechanism (if equipped)	3-6	Trunk open request switch (if equipped)	3-20
Child safety rear door lock	3-6	Key operation (if equipped)	3-20
Remote keyless entry system (if equipped)	3-6	Fuel filler lid	3-20
Using remote keyless entry system	3-7	Opening fuel filler lid	3-20
Intelligent Key system (if equipped)	3-8	Fuel filler cap	3-21
Operating range	3-9	Steering wheel	3-21
Using Intelligent Key system	3-9	Mirrors	3-21
Battery saver system	3-11	Inside rearview mirror	3-21
Warning and audible reminders	3-11	Outside rearview mirrors	3-22
Troubleshooting guide	3-13	Vanity mirror (if equipped)	3-23
Using remote keyless entry system	3-14	Parking brake	3-23
Hazard indicator and outside chime operation	3-16	Lever type	3-23

KEYS

Your vehicle can only be driven with the keys specific to your vehicle. A key number plate is supplied with your key. Record the key number and keep the key number plate in a safe place, except in the vehicle, in case of the need to duplicate the keys.

The key can only be duplicated using an original key or the original key number. The key number is required when you have lost all of the keys and do not have the original key to duplicate from. If the key is lost, or you need extra keys, provide an original key or the key number to a NISSAN dealer.



CAUTION:

Do not leave the keys inside the vehicle when leaving the vehicle.

KEY (if equipped)

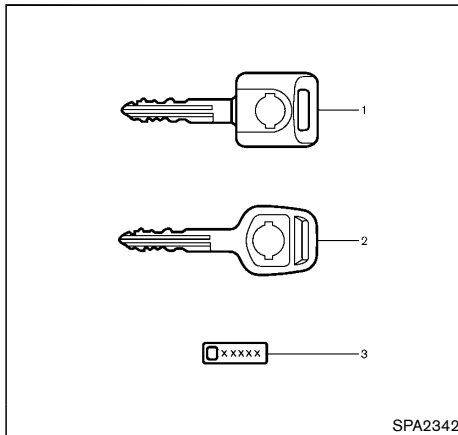

Your vehicle is equipped with the following set of keys:

1. Master key (Molded)
2. Master key (Plate)
3. Key number plate

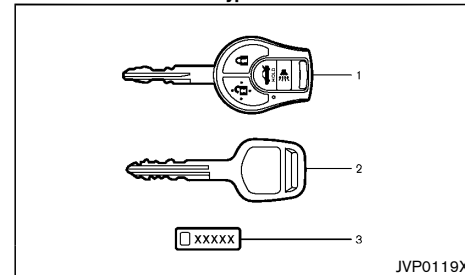
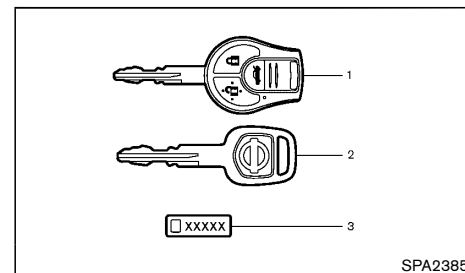

1. Master key
2. Master key (Plate)
3. Key number plate

As many as 5 master keys with remote controller can be registered and used with one vehicle.

NISSAN ANTI-THEFT SYSTEM (NATS*) KEY (if equipped)

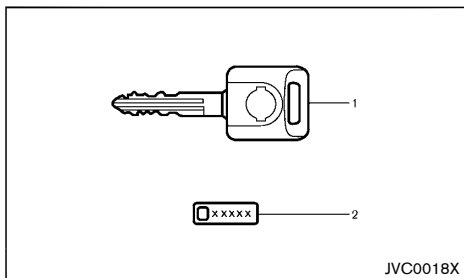

Type A

Your vehicle is equipped with the following set of keys:

- 1 NATS key (Molded) (2)
- 2 Key number plate

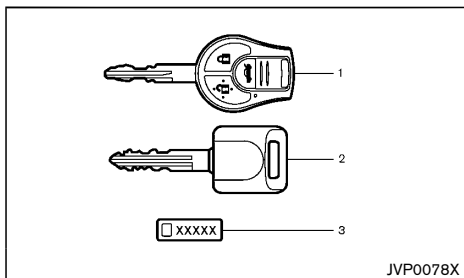

Type B

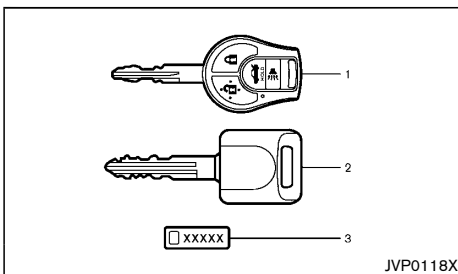

Type C

- 1 NATS key
- 2 NATS key (Molded)
- 3 Key number plate

Your vehicle can only be driven with the NATS keys, which are registered to your vehicle's NATS components. As many as 5 NATS keys can be registered and used with one vehicle. The new keys must be registered by a NISSAN dealer prior to use with the NATS of your vehicle. Since the registration process requires erasing all memory in the NATS components when registering new keys, be sure to take all NATS keys that you have to the NISSAN dealer.



CAUTION:

Do not allow the NATS key, which contains an electrical transponder, to come into contact with water or salt water. This could affect the system function.

*: Immobilizer

INTELLIGENT KEY (if equipped)

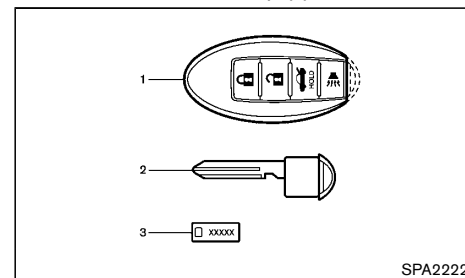

Type A (with panic alarm)

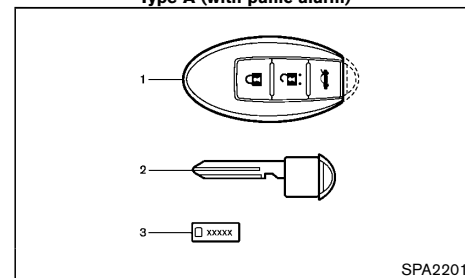

Type B (without panic alarm)

1. Intelligent Key (2)
2. Mechanical key (inside the Intelligent Key) (2)
3. Key number plate

Your vehicle can only be driven with the Intelligent Keys, which are registered to your vehicle's Intelligent Key system components and NISSAN Anti-Theft System (NATS*) components. As many as 4 Intelligent Keys can be registered and used with one vehicle. The new keys must be registered by a NISSAN dealer prior to use with the Intelligent Key system and NATS of your vehicle. Since the registration process requires erasing

all memory in the Intelligent Key components when registering new keys, be sure to take all Intelligent Keys that you have to the NISSAN dealer.

*: Immobilizer

CAUTION:

- Be sure to carry the Intelligent Key with you. Do not leave the vehicle with the Intelligent Key inside.
- Be sure to carry the Intelligent Key with you when driving. The Intelligent Key is a precision device with a built-in transmitter. To avoid damaging it, please note the following.
 - The Intelligent Key is water resistant; however, wetting may damage the Intelligent Key. If the Intelligent Key gets wet, immediately wipe until it is completely dry.
 - Do not bend, drop or strike it against another object.
 - If the outside temperature is below -10°C (14°F), the battery of the Intelligent Key may not function properly.
 - Do not place the Intelligent Key for an extended period in a place where temperatures exceed 60°C (140°F).
 - Do not change or modify the Intelligent Key.
 - Do not use a magnetic key holder.
 - Do not place the Intelligent Key near equipment that produces a magnetic field such as a TV, audio equipment and personal computers or cellular

phones.

- Do not allow the Intelligent Key to come into contact with water or salt water, and do not wash it in a washing machine. This could affect the system function.
- If an Intelligent Key is lost or stolen, NISSAN recommends erasing the ID code of that Intelligent Key. This will prevent the Intelligent Key from unauthorized use to unlock the vehicle. For information regarding the erasing procedure, please contact a NISSAN dealer.

Mechanical key

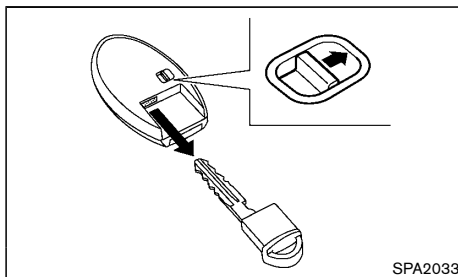

To remove the mechanical key, release the lock knob at the back of the Intelligent Key.

To install the mechanical key, firmly insert it into the Intelligent Key until the lock knob returns to the lock position.

Use the mechanical key to lock or unlock the doors. (See "Door locks" (P.3-4).)

DOOR LOCKS

WARNING:

- Always look before opening any doors, to avoid an accident with oncoming traffic.
- Never leave children or adults who would normally require the support of others alone in the vehicle. They could unknowingly activate switches or controls and inadvertently become involved in a serious accident.

LOCKING WITH KEY

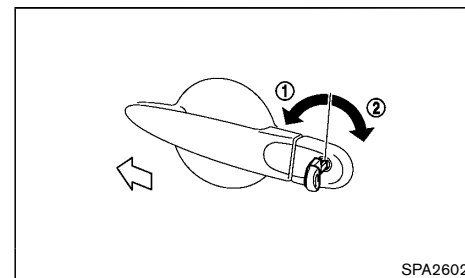

Type A

To lock the driver's door, insert the key in to the door cylinder located on the driver's side door and turn the key to the front of the vehicle (1).

For locking other doors, use the power door lock switch. (See "Locking with power door lock switch" (P.3-5).)

To unlock the driver's door, turn the key to the rear of the vehicle (2).

For unlocking other doors, use the power door lock switch. (See "Locking with power door lock switch" (P.3-5).)

Type B

To lock the driver's door, insert the key to the door key cylinder located on the driver's side door, and turn the key to the front of the vehicle ①.

For locking other doors, use the inside lock knob. (See "Locking with inside lock knob" (P.3-5).)

To unlock the driver's door, turn the key to the rear of the vehicle ②.

For unlocking other doors, use the inside lock knob. (See "Locking with inside lock knob" (P.3-5).)

Type C

To lock the driver's door, insert the key to the door key cylinder located on the driver's side door, and turn the key to the front of the vehicle ①. All doors will lock.

To unlock the driver's door, turn the key to the rear of the vehicle ②. All doors will unlock.

LOCKING WITH INSIDE LOCK KNOB

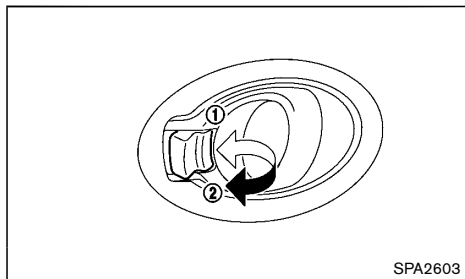

CAUTION:

When locking the doors using the inside lock knob, be sure not to leave the key in the vehicle.

To lock the front doors, push the inside lock knob to the lock position ①, and then close the door while pulling the door handle.

To lock the rear doors, push the inside lock knob to the lock position ① and then close the door.

To unlock, pull the inside lock knob to the unlock position ②.

When the driver's door is locked, pulling the driver's side door handle will unlock the door.

LOCKING WITH POWER DOOR LOCK SWITCH (if equipped)

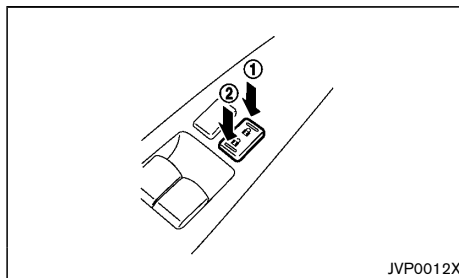

CAUTION:

When locking the doors using the power door lock switch, be sure not to leave the key in the vehicle.

To lock the doors, push the power door lock switch to the lock position ①.

To unlock, push the power door lock switch to the unlock position ②.

VEHICLE SPEED SENSING DOOR LOCK MECHANISM (if equipped)

All doors will be locked automatically when the vehicle speed reaches 10 km/h (6 MPH). Once the lock has been unlocked, while driving, the vehicle speed sensing door lock mechanism will not lock the door again unless one of the following is performed.

- Opening any doors.
- Placing the ignition switch in the "OFF" position.

To activate or deactivate vehicle speed sensing door lock mechanism

To activate or deactivate the door lock mechanism, perform the following procedures.

The function is set to deactivated as the factory default setting.

1. Place the ignition switch in the "ON" position.
2. Within 20 seconds, push and hold the power door lock switch to the "LOCK" position for 5 seconds.
3. The hazard indicator light will flash as follows if the switching operation is successful:

- Twice — activated
- Once — deactivated

AUTO DOOR LOCK RELEASING MECHANISM (if equipped)

All doors will be unlocked automatically when the ignition switch moved from "ON" to "OFF" position (models with Intelligent Key system).

All doors will be unlocked automatically when the key is removed from the ignition switch (models without Intelligent Key system).

To activate or deactivate auto door lock releasing mechanism

To activate or deactivate the auto door lock releasing mechanism, perform the following procedures.

The function is set to deactivated as the factory default setting.

1. Place the ignition switch in the "ON" position.
2. Within 20 seconds, push and hold the power door lock switch to the "UNLOCK" position for 5 seconds.
3. The hazard indicator light will flash as follows if the switching operation is successful:
 - Twice - activated
 - Once - deactivated

IMPACT SENSING DOOR LOCK RELEASING MECHANISM (if equipped)

All doors will be unlocked automatically in the event of frontal or rear impact while the ignition switch is in the "ON" position.

The impact sensing door lock releasing mechanism may not function depending on the force of the impact.

CHILD SAFETY REAR DOOR LOCK

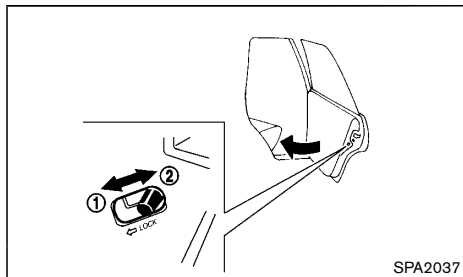

The child safety rear door locks help prevent rear doors from being opened accidentally, especially when small children are in the vehicle.

When the levers are in the lock position ①, the child safety rear door locks engage and the rear doors can only be opened by the outside door handles.

To disengage, move the levers to the unlock position ②.

REMOTE KEYLESS ENTRY SYSTEM (if equipped)

The remote keyless entry system can operate all door locks using the remote controller. The remote controller can operate at a distance of approximately 1 m (3.3 ft) away from the vehicle. The operating distance depends upon the conditions around the vehicle.

As many as 5 remote controllers can be used with one vehicle. For information about the purchase and use of additional remote controllers, contact a NISSAN dealer.

The remote controller will not function under the following conditions:

- When the distance between the remote controller and vehicle is more than approximately 1 m (3.3 ft).
- When the remote controller battery is discharged.
- When the key is in the ignition switch.



CAUTION:

- **When locking the doors using the remote controller, be sure not to leave the key in the vehicle.**
- **Do not allow the remote controller, which contains electrical components, to come into contact with water or salt water. This could affect the system function.**
- **Do not drop the remote controller.**
- **Do not strike the remote controller sharply against another object.**
- **Do not place the remote controller for an extended period in an area where temperatures exceed 60°C (140°F).**
- **When the outside temperature is extremely low, the remote keyless entry system may not function properly.**

If a remote controller is lost or stolen, NISSAN recommends erasing the ID code of that remote controller from the vehicle. This may prevent the unauthorized use of the remote controller to unlock the vehicle. For information regarding the erasing procedure, contact a NISSAN dealer.

For information regarding the replacement of a battery, see "Remote controller battery" (P.8-22).

USING REMOTE KEYLESS ENTRY SYSTEM

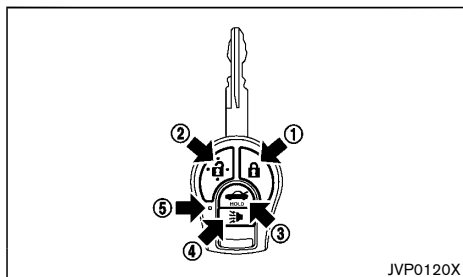

Type A (with panic alarm)

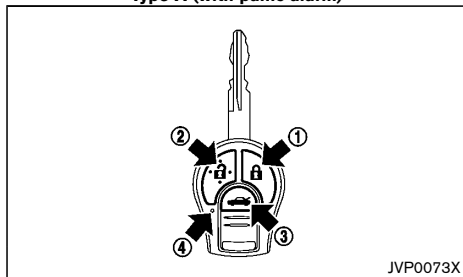

Type B (without panic alarm)

Locking doors

1. Remove the key from the ignition switch.
2. Close all doors.
3. Push the "LOCK"  button ① on the remote controller.
4. All doors will be locked.
5. Operate door handles to confirm that the doors have been securely locked.



CAUTION:

After locking the doors using the remote controller, be sure that the doors have been securely locked by operating the door handles.

Unlocking doors



1. Push the "UNLOCK"  button ② on the remote controller.
2. All doors will be unlocked.

All doors will be locked automatically unless one of the following operations is performed within 30 seconds after pushing the "UNLOCK"  button ② on the remote controller while the doors are locked.

If during this 30-second time period, the "UNLOCK" button on the remote controller is pushed, all doors will be locked automatically after another 30 seconds.

- Opening any doors.
- Inserting the key into the ignition switch.

Opening trunk lid

1. Push and hold the "TRUNK"  /  button ③ on the remote controller for longer than 1 second with the key removed from the ignition switch.
2. The trunk lid opens.

Using panic alarm (if equipped)

If you are near your vehicle and feel threatened, you may activate the alarm to call attention as follows:

1. Push the "PANIC"  button ④ (Type A) on the remote controller for **more than 1 second**.
2. The theft warning alarm will stay on for 25 seconds.
3. The panic alarm stops when:
 - It has run for 25 seconds, or
 - Any of the buttons on the remote controller are pushed. (Note: Panic or trunk button should be pushed for more than 1 second.)

Hazard indicator operation:

When you lock or unlock the doors, the hazard indicator will flash as a confirmation.

- "LOCK": The hazard indicator flashes once.
- "UNLOCK": The hazard indicator flashes twice.

Battery indicator light

The battery indicator light ⑤ (Type A) or ④ (Type B) illuminates when you push any button. If the light does not illuminate, the battery is weak or needs replacement. For information regarding replacement of a battery, see "Remote controller battery" (P.8-22).

INTELLIGENT KEY SYSTEM (if equipped)

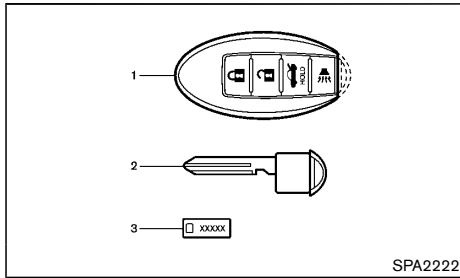

Type A (with panic alarm)

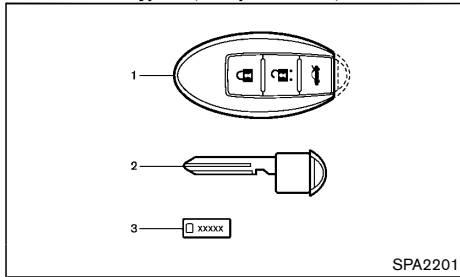

Type B (without panic alarm)

1. Intelligent Key (2)
2. Mechanical key (inside the Intelligent Key) (2)
3. Key number plate



WARNING:

- **Radio waves could adversely affect electric medical equipment. Those who use a pacemaker should contact the electric medical equipment manufacturer for the possible influences before use.**
- **The Intelligent Key transmits radio waves when the buttons are pushed. The radio**

waves may affect aircraft navigation and communication systems. Do not operate the Intelligent Key while on an airplane. Make sure the buttons are not operated unintentionally when the unit is stored during a flight.

The Intelligent Key system can be used to operate all the doors and the trunk with the remote controller function or by pushing the request switch on the vehicle without taking the key out from a pocket or purse. The operating environment and/or conditions may affect the Intelligent Key system operation.

Be sure to read the following before using the Intelligent Key system.



CAUTION:

- **Be sure to carry the Intelligent Key with you when operating the vehicle.**
- **Never leave the Intelligent Key in the vehicle when you leave the vehicle.**
- **When the outside temperature is extremely low, the Intelligent Key system may not function properly.**

The Intelligent Key is always communicating with the vehicle as it receives radio waves. The Intelligent Key system transmits weak radio waves. Environmental conditions may interfere with the operation of the Intelligent Key system under the following operating conditions.

- When operating near a location where strong radio waves are transmitted, such as a TV tower, power station and broadcasting station.
- When in possession of wireless equipment, such as a cellular telephone, transceiver, and CB radio.

- When the Intelligent Key is in contact with or covered by metallic materials.
- When any type of radio wave remote control is used nearby.
- When the Intelligent Key is placed near an electric appliance such as a personal computer.
- When the vehicle is parked near a parking meter.

In such cases, correct the operating conditions before using the Intelligent Key function or use the mechanical key.

Although the life of the battery varies depending on the operating conditions, the battery's life is approximately 2 years. If the battery is discharged, replace it with a new one.

For information regarding replacement of a battery, see "Intelligent Key battery" (P.8-23).

Since the Intelligent Key is continuously receiving radio waves, if the key is left near equipment which transmits strong radio waves, such as signals from a TV and personal computer, the battery life may become shorter.

When the battery is discharged, firmly apply the foot brake and touch the ignition switch with the Intelligent Key. Then push the ignition switch while depressing the brake pedal (CVT model) or the clutch pedal (MT model) within 10 seconds after the chime sound. (See "Push-button ignition switch (model with Intelligent Key system)" (P.5-5).)

Because the steering wheel is locked electrically, unlocking the steering wheel with the ignition switch in the "LOCK" position is impossible when the vehicle battery is completely discharged. Pay special attention that the vehicle battery is not completely discharged.

As many as 4 Intelligent Keys can be used with one vehicle. For information about the purchase and use of additional Intelligent Keys, contact a NISSAN dealer.

CAUTION:

- Do not allow the Intelligent Key, which contains electrical components, to come into contact with water or salt water. This could affect the system function.
- Do not drop the Intelligent Key.
- Do not strike the Intelligent Key sharply against another object.
- Do not change or modify the Intelligent Key.
- Wetting may damage the Intelligent Key. If the Intelligent Key gets wet, immediately wipe until it is completely dry.
- If the outside temperature is below -10°C (14°F), the battery of the Intelligent Key may not function properly.
- Do not place the Intelligent Key for an extended period in an area where temperatures exceed 60°C (140°F).
- Do not attach the Intelligent Key with a key holder that contains a magnet.
- Do not place the Intelligent Key near equipment that produces a magnetic field, such as a TV, audio equipment and personal computers or cellular phones.

If an Intelligent Key is lost or stolen, NISSAN recommends erasing the ID code of that Intelligent Key from the vehicle. This may prevent the unauthorized use of the Intelligent Key to operate the vehicle. For information regarding the erasing procedure, contact a NISSAN dealer.

The Intelligent Key function can be disabled. For information about disabling the Intelligent Key function, contact a NISSAN dealer.

OPERATING RANGE

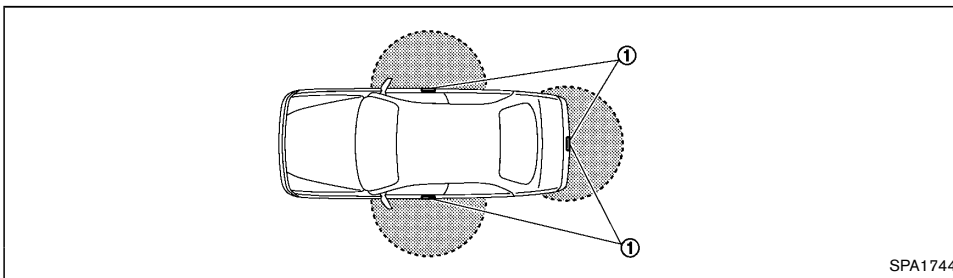

SPA1744

The Intelligent Key functions can only be used when the Intelligent Key is within the specified operating range from the request switch ①.

When the Intelligent Key battery is discharged or strong radio waves are present near the operating location, the Intelligent Key system's operating range becomes narrower, and the Intelligent Key may not function properly.

The operating range is within 80 cm (31.50 in) from each request switch ①.

If the Intelligent Key is too close to the door glass, handle or rear bumper the request switches may not function.

When the Intelligent Key is within the operating range, it is possible for anyone, even someone who does not carry the Intelligent Key, to push the request switch and lock/unlock the doors and the trunk.

USING INTELLIGENT KEY SYSTEM

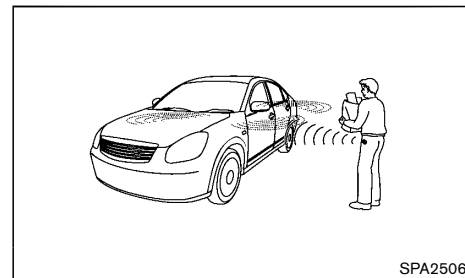

SPA2506

The request switch will not function under the following conditions:

- When the Intelligent Key is left inside the vehicle
- When the Intelligent Key is not within the operational range
- When any door is open or not closed securely
- When the Intelligent Key battery is discharged
- When the ignition switch is in the "ACC" or "ON" position

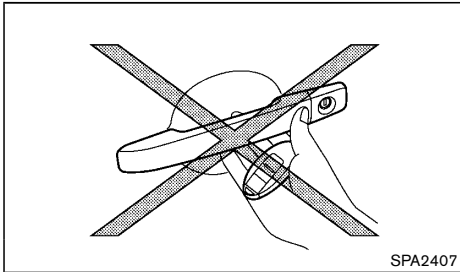

- Do not push the door handle request switch with the Intelligent Key held in your hand as illustrated. The close distance to the door handle will cause the Intelligent Key system to have difficulty recognizing that the Intelligent Key is outside the vehicle.
- After locking the doors using the door handle request switch, make sure that the doors have been securely locked by operating the door handles.
- When locking the doors using the door handle request switch, make sure to have the Intelligent Key in your possession before operating the door handle request switch to prevent the Intelligent Key from being left in the vehicle.
- The door handle request switch is operational only when the Intelligent Key has been detected by the Intelligent Key system.
- To prevent the Intelligent Key from being left inside the vehicle or the trunk, make sure you are carrying the key with you and then lock the doors or the trunk.
- Do not pull the door handle before pushing the door handle request switch. The door will be unlocked but will not open. Release the door

handle once and pull it again to open the door.

Locking doors

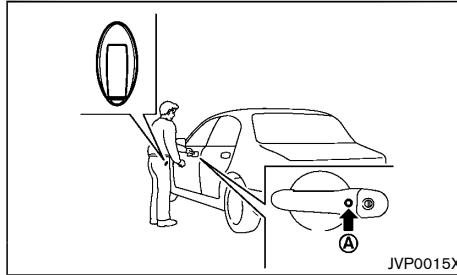

When you carry the Intelligent Key with you, you can lock or unlock all doors by pushing the door handle request switch (driver's or front passenger's) (A) within the range of operation.

When you lock or unlock the doors, the hazard indicator will flash and the outside chime will sound as a confirmation. For details, see "Hazard indicator and outside chime operation" (P.3-16).

1. Push the ignition switch to the "OFF" position.
2. Carry the Intelligent Key with you.
3. Close all doors.
4. Push the door handle request switch (A) (driver's or front passenger's).
5. All doors will be locked.
6. Operate door handles to confirm that the doors have been securely locked.

Lockout protection:

To prevent the Intelligent Key from being accidentally locked in the vehicle, lockout protection is equipped with the Intelligent Key system.

- When the Intelligent Key is left in the vehicle and you try to lock the door using the driver's inside lock knob after getting out of the vehicle, all the doors will unlock automatically and a chime will sound after the door is closed.
- When the Intelligent Key is left in the vehicle while the driver's door is opened and you try to lock the door using the power door lock switch after getting out of the vehicle, all the doors will unlock automatically after the power door lock switch or the driver's inside lock knob is operated.



CAUTION:

The lockout protection may not function under the following conditions:

- When the Intelligent Key is placed on top of the instrument panel.
- When the Intelligent Key is placed on the top of the rear parcel.
- When the Intelligent Key is placed inside of the glove box.
- When the Intelligent Key is placed inside of the door pockets.
- When the Intelligent Key is placed on or under the spare tire area.
- When the Intelligent Key is placed on the outer side of the trunk area.
- When the Intelligent Key is placed inside or near metallic materials.

The lockout protection may function when the

Intelligent Key is outside the vehicle but is too close to the vehicle.

Unlocking doors

1. Carry the Intelligent Key with you.
2. Push the door handle request switch **(A)**.
3. All doors will be unlocked.

If a door handle is pulled while unlocking the doors, that door may not be unlocked. Returning the door handle to its original position will unlock the door. If the door does not unlock, after returning the door handle, push the door handle request switch to unlock the door.

Automatic relock:

All doors will be locked automatically unless one of the following operations is performed within 30 seconds after pushing the request switch while the doors are locked.

- Opening any doors.
- Pushing the ignition switch.

If during the preset time period the "UNLOCK"  button on the Intelligent Key is pushed, all doors will be locked automatically after the next preset time.

Opening trunk lid

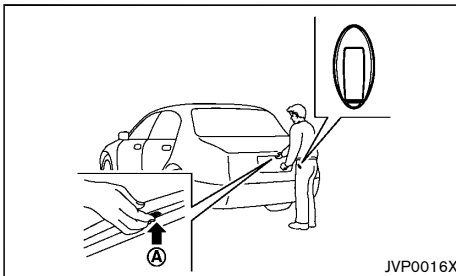

1. Carry the Intelligent Key.
2. Push the trunk open request switch **(A)**.
3. The trunk will be unlatched.
4. The outside chime sounds 4 times.
5. Raise the trunk lid to open the trunk.



CAUTION:

When closing the trunk, make sure to have the Intelligent Key in your possession before closing the trunk to prevent the Intelligent Key from being left in the trunk.

Lockout protection:

To prevent the Intelligent Key from being accidentally locked in the trunk, the Intelligent Key system is equipped with lockout protection.

When the trunk lid is closed with all the doors locked and the Intelligent Key inside the trunk, a chime will sound and the trunk lid will open.



CAUTION:

The lockout protection may not function under the following conditions.

- When the Intelligent Key is placed on or under the spare tire area.
- When the Intelligent Key is placed at the outer side of the trunk area.
- When the Intelligent Key is placed inside or near metallic materials.

BATTERY SAVER SYSTEM

When all the following conditions are met for a period of time, the battery saver system will cut off the power supply to prevent battery discharge.

- The ignition switch is in the "ACC" position
- All doors are closed, and
- The shift lever is in the "P" (Park) position (Automatic Transmission/Continuously Variable Transmission model).

WARNING AND AUDIBLE REMINDERS

The Intelligent Key system is equipped with a function that is designed to minimize improper operations of the Intelligent Key and to help prevent the vehicle from being stolen. A chime or beep sounds inside and outside the vehicle and a warning light illuminates or blinks.

See the troubleshooting guide on the next page and "Warning/indicator lights and audible reminders" (P.2-11).

Intelligent Key system warning light: 

P position selecting warning light:  (Automatic Transmission/Continuously Variable Transmission model)



CAUTION:

When the chime or beep sounds or the warning light illuminates or blinks, be sure to check both the vehicle and the Intelligent Key.

TROUBLESHOOTING GUIDE

Symptom		Possible cause	Action to take
When pushing the ignition switch to stop the engine	The P position selecting warning light in the meter and the inside warning chime sounds continuously (Automatic Transmission/Continuously Variable Transmission model).	The shift lever is not in the "P" (Park) position.	Shift the shift lever to the "P" (Park) position.
When shifting the shift lever to the "P" (Park) position (Automatic Transmission/Continuously Variable Transmission model).	The inside warning chime sounds continuously.	The ignition switch is in the "ACC" or "ON" position.	Push the ignition switch to the "OFF" position.
When opening the driver's door to get out of the vehicle	The inside warning chime sounds continuously.	The ignition switch is in the "ACC" position.	Push the ignition switch to the "OFF" position.
When closing the door after getting out of the vehicle	The Intelligent Key system warning light in the meter blinks in yellow, the outside chime sounds 3 times and the inside warning chime sounds for a few seconds.	The ignition switch is in the "ACC" or "ON" position.	Push the ignition switch to the "OFF" position.
	The P position selecting warning light in the meter illuminates and the outside chime sounds continuously (Automatic Transmission/Continuously Variable Transmission model).	The ignition switch is in the "ACC" or "OFF" position and the shift lever is not in the "P" (Park) position.	Move the shift lever to the "P" (Park) position and push the ignition switch to the "OFF" position.
When closing the door with the inside lock knob turned to the "LOCK" position	The outside chime sounds for a few seconds and all the doors unlock.	The Intelligent Key is inside the vehicle or trunk.	Carry the Intelligent Key with you.
When pushing the request switch or the "LOCK"  button on the Intelligent Key to lock the door	The outside chime sounds for a few seconds and all the doors unlock.	The Intelligent Key is inside the vehicle or trunk.	Carry the Intelligent Key with you.
		The ignition switch is in the "ACC" or "ON" position.	Push the ignition switch to the "OFF" position.
		A door is not closed securely.	Close the door securely.
When closing the trunk lid	The outside chime sounds for approximately 10 seconds and the trunk lid opens.	The Intelligent Key is inside the trunk.	Carry the Intelligent Key with you.
When pushing the door handle request switch to lock the door	The outside chime sounds for a few seconds.	The Intelligent Key is inside the vehicle.	Carry the Intelligent Key with you.
		A door is not closed securely.	Close the door securely.

Symptom	Possible cause	Action to take	
When pushing the ignition switch to start the engine	The Intelligent Key system warning light in the meter blinks in green.	The battery charge is low.	Replace the battery with a new one. (See "Intelligent Key battery" (P.8-23).)
	The Intelligent Key system warning light in the meter blinks in yellow.	The Intelligent Key is not in the vehicle.	Carry the Intelligent Key with you.

USING REMOTE KEYLESS ENTRY SYSTEM

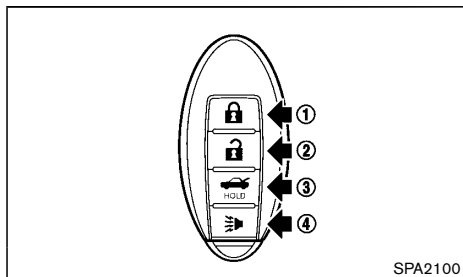

Type A (with panic alarm)

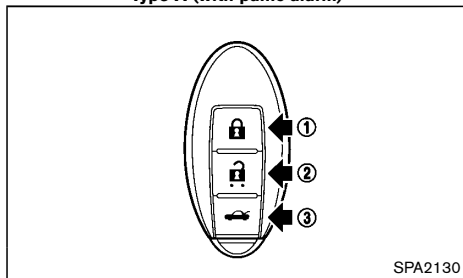

Type B (without panic alarm)

Operating range

The remote keyless entry system allows you to lock/unlock all doors and to unlock the trunk lid. It also provides the panic alarm (if equipped). The operating distance depends upon the conditions around the vehicle. To securely operate the lock and unlock buttons, approach the vehicle to about 1 m (3.3 ft) from the door.

The remote keyless entry system will not function under the following conditions:

- When the Intelligent Key is not within the operational range.
- When the Intelligent Key battery is discharged.

For information regarding the replacement of a battery, see "Intelligent Key battery" (P.8-23).

Locking doors

When you lock or unlock the doors, the hazard indicator will flash and the outside chime will sound as a confirmation.

1. Place the ignition switch in the "OFF" position and carry the Intelligent Key.
2. Close all doors.
3. Push the "LOCK"  button ① on the Intelligent Key.
4. All doors will be locked.
5. Operate the door handles to confirm that the doors have been securely locked.





CAUTION:

After locking the doors using the Intelligent Key, be sure that the doors have been securely locked by operating the door handles.

Unlocking doors



1. Push the "UNLOCK"  button ② on the Intelligent Key.
2. All doors will be unlocked.

Automatic relock :

All doors will be locked automatically unless one of the following operations is performed within 30 seconds after pushing the "UNLOCK"  button on the Intelligent Key while the doors are locked. If during this 30-second time period, the "UNLOCK"  button on the Intelligent Key is pushed, all doors will be locked automatically after another 30 seconds.

- Opening any doors.
- Pushing the ignition switch.

Opening trunk lid

1. Push the "TRUNK"  /  button ③ on the Intelligent Key for more than 1 second.
2. The trunk will be unlatched.
3. Raise the trunk lid to open the trunk.

Using panic alarm (if equipped)

If you are near your vehicle and feel threatened, you may activate the alarm to call attention as follows:



1. Push the "PANIC"  button ④ on the Intelligent Key for **more than 1 second**.
2. The theft warning alarm will stay on for 25 seconds.
3. The panic alarm stops when:
 - It has run for 25 seconds, or
 - Any of the buttons on the Intelligent Key are pushed. (Note: Panic or trunk button should be pushed for more than 1 second.)

HAZARD INDICATOR AND OUTSIDE CHIME OPERATION

When you lock or unlock the doors with the request switch or the remote keyless entry function, the hazard indicator will flash and the outside chime will sound as a confirmation.

The following descriptions show how the hazard indicator and outside chime will activate when locking or unlocking the doors.

Hazard indicator and horn mode

	DOOR LOCK	DOOR UNLOCK	TRUNK UNLOCK
Intelligent Key system (using request switch)	HAZARD - once OUTSIDE CHIME - once	HAZARD - twice OUTSIDE CHIME - twice	HAZARD - none OUTSIDE CHIME - 4 times
Remote keyless entry system (using  or  button)	HAZARD - once HORN - none	HAZARD - twice HORN - none	HAZARD - none HORN - none

SECURITY SYSTEM (if equipped)

Your vehicle is equipped with the following security systems:

- Theft warning system (if equipped)
- NISSAN Anti-Theft System (NATS)*
(* immobilizer)

The security condition will be shown by the security indicator light.

THEFT WARNING SYSTEM (if equipped)

The theft warning system provides visual and audio alarm signals if parts of the vehicle are disturbed.

Security indicator light

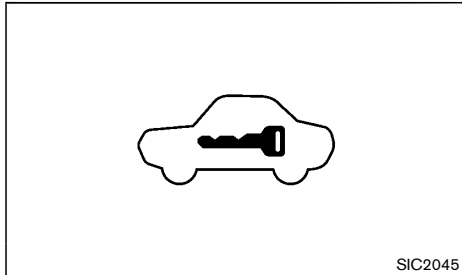

The security indicator light is located in the meter panel.

This light operates whenever the ignition switch is in the "ACC", "OFF" or "LOCK" position. This is normal.

How to activate the system:

1. Close all windows and push the ignition switch to the "OFF" position.

The system can be activated even if the windows are open.

2. Carry the Intelligent Key with you and get out of the vehicle.
3. Make sure the hood and the trunk are closed. Close and lock all doors with the door handle request switch, LOCK button on the Intelligent Key or power door lock switch.
 - If the door is locked using the inside lock knob, the system will not be activated.
4. Confirm that the security indicator light comes on. The security indicator light stays on for approximately 30 seconds. The vehicle security system is now pre-armed. After approximately 30 seconds the vehicle security system automatically shifts into the armed phase. The security light begins to flash once every approximately 3 seconds.

If, during this 30-second pre-arm time period, the door is unlocked with the door handle request switch, the "UNLOCK"  button on the Intelligent Key, the power door lock switch, or the ignition switch is pushed to the "ACC" or "ON" position, the system will not arm.

Even when the driver and/or passengers are in the vehicle, the system will activate with all doors locked and ignition switch in the "LOCK" position. Push the ignition switch to the "ACC" or "ON" position to turn the system off.

Theft warning system operation:

The warning system will give the following alarm:

- The hazard indicator blinks and the horn sounds intermittently for approximately 30 seconds.
- The alarm automatically turns off after approximately 30 seconds. However, the alarm reactivates if the vehicle is tampered with again.

The alarm is activated by:

- Operating the door or the trunk without using the Intelligent Key system.
- Opening the hood.

How to stop alarm:

- The alarm will stop by unlocking a door with the door handle request switch or "UNLOCK"  button on the Intelligent Key.
- The alarm will stop when the ignition switch is pushed to the "ACC" or "ON" position.

If the system does not operate as described above, have it checked by a NISSAN dealer.

NISSAN ANTI-THEFT SYSTEM (NATS)

The NISSAN Anti-Theft System (NATS) will not allow the engine to start without the use of the registered NATS key.

If the engine does not start using the registered NATS key, it may be due to interference caused by:

- Another NATS key.
- Automated toll road device.
- Automated payment device.
- Other devices that transmit similar signals.

Start the engine using the following procedure:

1. Remove any items that may be causing the interference away from the NATS key.
2. Leave the ignition switch in the "ON" position for approximately 5 seconds.
3. Place the ignition switch to the "OFF" or "LOCK" position, and wait approximately 10 seconds.
4. Repeat steps 2 and 3 again.
5. Start the engine.
6. Repeat the steps above until all possible interferences are eliminated.

HOOD

If this procedure allows the engine to start, NISSAN recommends placing the registered NATS key separate from other devices to avoid interference.

Security indicator light

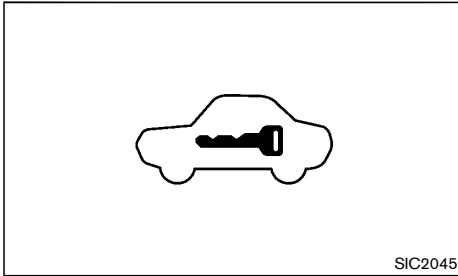

The security indicator light is located on the meter panel. It indicates the status of NATS.

The light operates whenever the ignition switch is in the "LOCK", "OFF" or "ACC" position. The security indicator light indicates that the security systems on the vehicle are operational.

If NATS is malfunctioning, this light will remain on while the ignition switch is in the "ON" position.

If the light remains on and/or the engine does not start, contact a NISSAN dealer for NATS service as soon as possible. Be sure to bring all NATS keys that you have when visiting a NISSAN dealer for service.



WARNING:

- **The hood must be closed and latched securely before driving. Failure to do so could cause the hood to fly open and result in an accident.**
- **Never open the hood if steam or smoke is coming from the engine compartment to avoid injury.**

OPENING HOOD

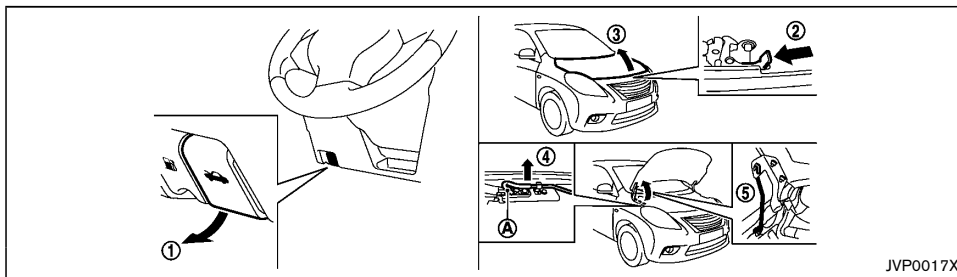

1. Pull the hood lock release handle ① located below the instrument panel until the hood springs up.
2. Locate the lever ② in between the hood and grille and push the lever sideways with your fingertips.
3. Raise the hood ③.
4. Remove the support rod ④ and insert it into the slot ⑤.

Hold the coated parts ① when removing or resetting the support rod. Avoid direct contact with the metal parts, as they may be hot immediately after the engine has been stopped.

CLOSING HOOD

1. While supporting the hood, return the support rod to its original position.
2. Slowly lower the hood to about 20 to 30 cm (8 to 12 in) above the hood lock, then let it drop.
3. Make sure it is securely latched.

TRUNK LID

WARNING:

- The trunk lid must be closed securely before driving. An open trunk lid could allow dangerous exhaust gases to be drawn inside the vehicle.
- Closely supervise children when they are around your vehicle to prevent them from playing and becoming locked in the trunk where they could be seriously injured. Keep the vehicle locked, with the trunk lid closed when not in use, and keep access to vehicle keys away from children.

The trunk lid can be opened by performing one of the following operations.

- Using the trunk lid release handle (if equipped)
- Using the remote controller (if equipped)
- Using the Intelligent Key remote keyless entry function (if equipped)
- Using the Intelligent Key trunk open request switch (if equipped)
- Using the key (if equipped)

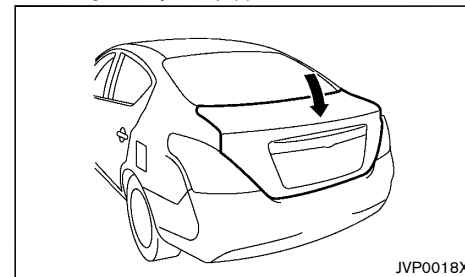

To close the trunk lid, push the trunk lid down until it

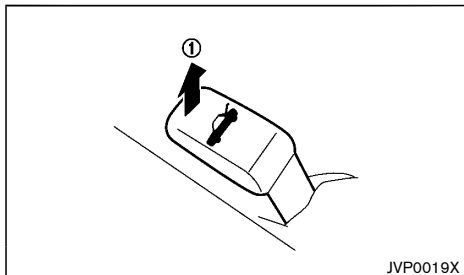

securely locks.

OPENING TRUNK LID (if equipped)





Pull the trunk lid release handle ① located below the driver's seat until the trunk lid springs up.

TRUNK BUTTON ON REMOTE CONTROLLER (if equipped)

To open the trunk lid, push the "TRUNK"  /  button on the remote controller. (See "Remote keyless entry system" (P.3-6).)

TRUNK BUTTON ON INTELLIGENT KEY (if equipped)

To open the trunk lid, push the "TRUNK"  /  button on the Intelligent Key. (See "Intelligent Key system" (P.3-8).)

TRUNK OPEN REQUEST SWITCH (if equipped)

To open the trunk lid, push the trunk open request switch while carrying the Intelligent Key. (See "Intelligent Key system" (P.3-8).)

KEY OPERATION (if equipped)

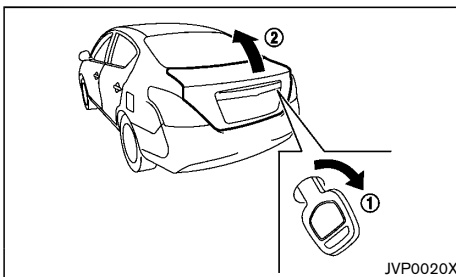

To open the trunk lid, insert the key to the key cylinder and turn the clockwise ①.

The trunk lid will be released ②.

FUEL FILLER LID

WARNING:

- Gasoline is extremely flammable and highly explosive under certain conditions. You could be burned or seriously injured if it is misused or mishandled. Always stop the engine and do not smoke or allow open flames or sparks near the vehicle when refueling.
- Fuel may be under pressure. Turn the cap a half of a turn, and wait for any "hissing" sound to stop to prevent fuel from spraying out and possibly causing personal injury. Then remove the cap.
- Use only an original equipment type fuel filler cap as a replacement. It has a built-in safety valve needed for proper operation of the fuel system and emission control system. An incorrect cap can result in a serious malfunction and possible injury.

OPENING FUEL FILLER LID

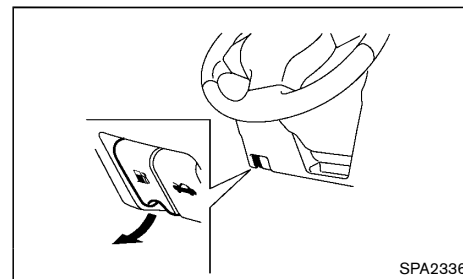

To open the fuel filler lid, pull the fuel filler lid release handle.

FUEL FILLER CAP

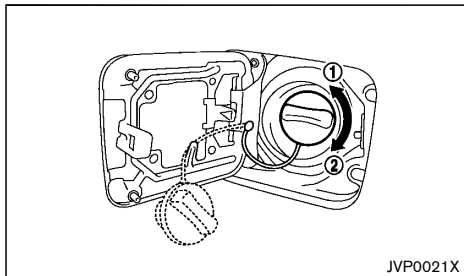

The fuel filler cap is a ratcheting type. Turn the cap counterclockwise ① to remove. Tighten the cap clockwise ② until ratchet clicks, more than twice, after refueling.

CAUTION:

If fuel is spilled on the vehicle body, flush it away with water to avoid paint damage.

STEERING WHEEL

WARNING:

Never adjust the steering wheel while driving so that full attention may be given to vehicle operation.

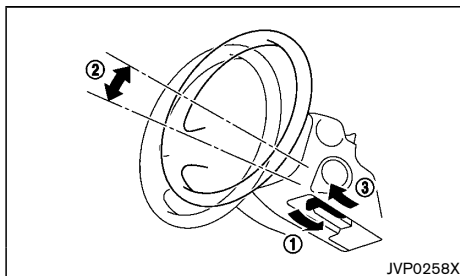

While pushing the lock lever down ①, adjust the steering wheel up or down ② until the desired position is achieved.

Pull the lock lever up ③ firmly to lock the steering wheel in place.

MIRRORS

WARNING:

Adjust the position of all mirrors before driving. Do not adjust the mirror positions while driving so that full attention may be given to vehicle operation.

INSIDE REARVIEW MIRROR

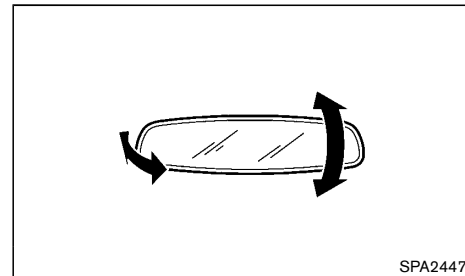

While holding the inside rearview mirror, adjust the mirror angles until the desired position is achieved.

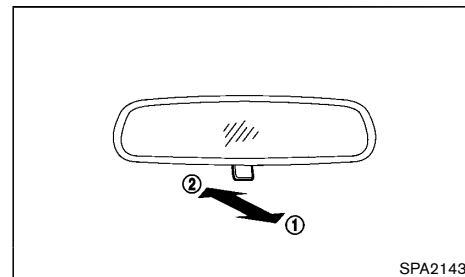

Pull the adjusting lever ① when the glare from the headlights of the vehicle behind you obstructs your vision at night.

Push the adjusting lever ② during the day for the best rearward visibility.

For Hong Kong:

Do not attach any accessories or electrical devices to or around the inside rearview mirror. Otherwise, the Intelligent Key system (if equipped) and remote keyless entry system may not function properly.

OUTSIDE REARVIEW MIRRORS

WARNING:

- **Never touch the outside rearview mirrors while they are in motion. Doing so may pinch your fingers or damage the mirror.**
- **Never drive the vehicle with the outside rearview mirrors folded. This reduces rear view visibility and may lead to an accident.**
- **Objects viewed in the outside mirror are closer than they appear. (if equipped)**
- **The picture dimensions and distance in the outside mirrors are not real.**

Adjusting

Remote control type (if equipped):

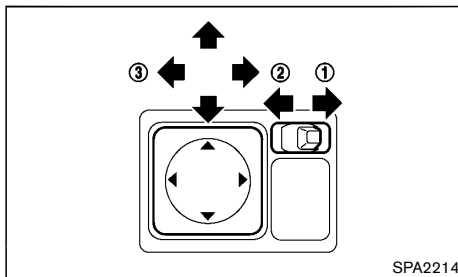

The outside rearview mirror remote control operates when the ignition switch is in the "ACC" or "ON" position.

1. Move the switch to select the right ① or left ② mirror.
2. Adjust each mirror until the desired position is achieved ③.

Lever control type (if equipped):

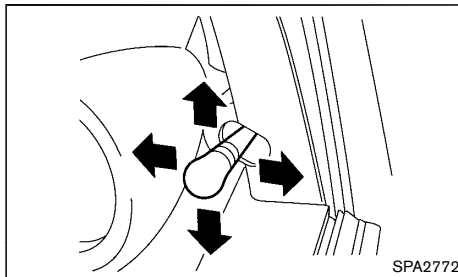

Adjust the mirror angles with the inside lever until the desired position is achieved.

Folding

Remote control type (if equipped):

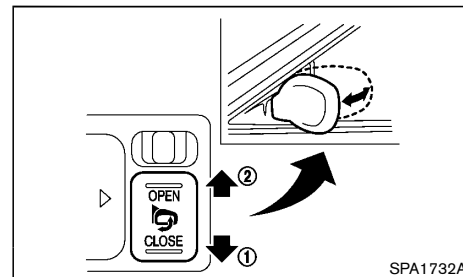

The outside rearview mirror remote control operates when the ignition switch is in the "ACC" or "ON" position.

The outside rearview mirrors automatically fold when the outside rearview mirror folding switch is pushed to the "CLOSE" position ①. To unfold, push to the "OPEN" position ②.

CAUTION:

- **Continuously performing the fold/unfold operation of the outside rearview mirror may cause the switch to stop the operation.**
- **Do not touch the mirrors while they are moving. Your hand may be pinched, and the mirror may malfunction.**
- **Do not drive with the mirrors stored. You will be unable to see behind the vehicle.**
- **If the mirrors were folded or unfolded by hand, there is a chance that the mirror will move forward or backward during driving. If the mirrors were folded or unfolded by hand,**

be sure to adjust them again electrically before driving.

Manual control type (if equipped):

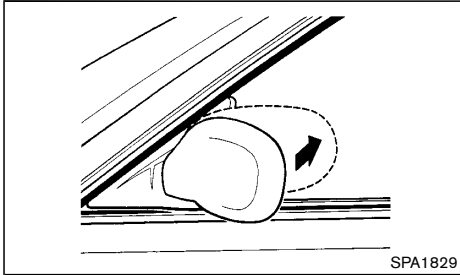

Fold the outside rearview mirror by pushing it toward the rear of the vehicle.

VANITY MIRROR (if equipped)

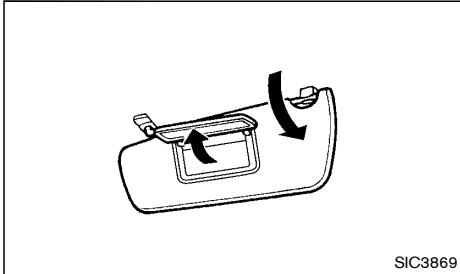

To access the vanity mirror, pull the sun visor down and pull up the mirror cover.

PARKING BRAKE



WARNING:

- Never drive the vehicle with the parking brake applied. The brake will overheat and fail to operate and will lead to an accident.
- Never release the parking brake from outside the vehicle. If the vehicle moves, it will be impossible to push the foot brake pedal and will lead to an accident.
- Never use the shift lever in place of the parking brake. When parking, be sure the parking brake is fully applied.
- Never leave children or adults who would normally require the support of others alone in your vehicle. They could unknowingly release the parking brake and inadvertently become involved in a serious accident.

completely ③.

Before driving, be sure that the brake warning light has turned off.

LEVER TYPE

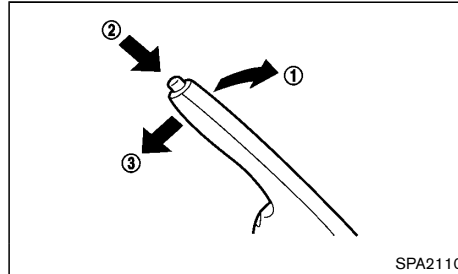

To apply the parking brake, pull the parking brake lever up ①.

To release the parking brake, firmly depress and hold the foot brake pedal. Pull up the parking brake lever slightly, push the button ② and lower the lever

MEMO

4 Heater and air conditioner, and audio system

Safety precautions	4-2	Audio system (if equipped)	4-10
Ventilators	4-2	Audio operation precautions	4-10
Side ventilators	4-2	Antenna	4-16
Center ventilators	4-2	FM-AM radio with Compact Disc (CD) player (Type A)	4-17
Rear ventilators (if equipped)	4-3	FM-AM radio with Compact Disc (CD) player (Type B)	4-21
Heater and air conditioner	4-3	CD/USB memory care and cleaning	4-25
Operating tips (for automatic air conditioner)	4-3	Steering wheel switch for audio control (if equipped)	4-26
Manual air conditioner	4-4	Car phone or CB radio	4-27
Automatic air conditioner	4-7	Bluetooth® Hands-Free Phone System (if equipped)	4-27
Servicing air conditioner	4-8	Regulatory information	4-28
Rear comfort fan (if equipped)	4-9	Using the system	4-29

SAFETY PRECAUTIONS

WARNING:

- Do not adjust the heater and air conditioner controls or audio controls (if equipped) while driving so that full attention may be given to vehicle operation.
- If you noticed any foreign objects entering the system hardware, spilled liquid on the system, or noticed smoke or fumes coming out from the system, or any other unusual operation is observed, stop using the system immediately and contact the nearest NISSAN dealer. Ignoring such conditions may lead to an accident, fire or electric shock.
- Do not disassemble or modify this system. If you do, it may lead to an accident, fire, or electric shock.

CAUTION:

Do not use the system when the engine is not running for extended periods of time to prevent battery discharge.

VENTILATORS

SIDE VENTILATORS

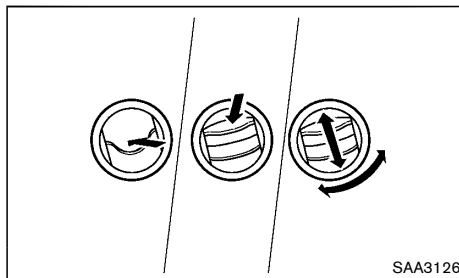

Adjust the air flow direction of the ventilators by opening, closing or rotating.

The side ventilators can be used for the side window defogger.

CENTER VENTILATORS

Square type

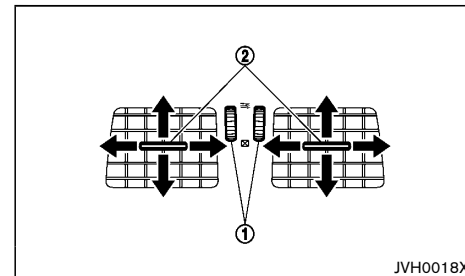

Open/close the ventilators by moving the control ① in either direction (if equipped).

- ☒ : This symbol indicates that the ventilators are closed. Moving the side control in this direction will close the ventilators.
- ≡ : This symbol indicates that the ventilators are open. Moving the side control in this direction will open the ventilators.

Adjust the air flow direction of the ventilators by moving the center knob ② (up/down/left/right) until the preferred position is achieved.

HEATER AND AIR CONDITIONER

Circle type

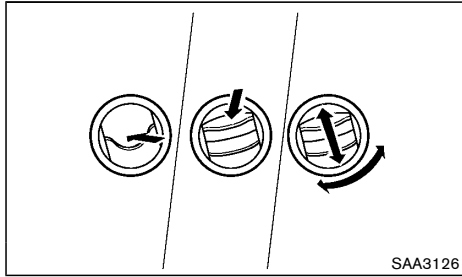

Adjust the air flow direction of the ventilators by opening, closing or rotating.

REAR VENTILATORS (if equipped)

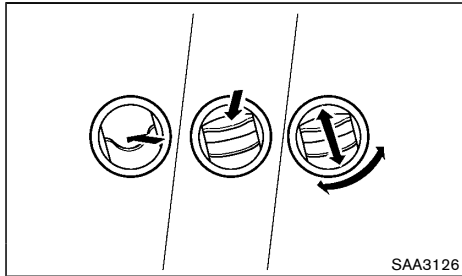

Adjust the air flow direction of the ventilators by opening, closing or rotating.



WARNING:

- The heater and air conditioner operate only when the engine is running.
- Never leave children or adults who would normally require the support of others alone in the vehicle. Pets should not be left alone either. They could unknowingly activate switches or controls and inadvertently become involved in a serious accident and injure themselves. On hot, sunny days, temperatures in a closed vehicle could quickly become high enough to cause severe or possibly fatal injuries to people or animals.
- Do not use the recirculation mode for long periods as it may cause the interior air to become stale and the windows to fog up.
- Do not adjust the heating and air conditioning controls while driving so that full attention may be given to vehicle operation.

The heater and air conditioner operate when the engine is running. The air blower will operate when the ignition switch is in the "ON" position even if the engine is turned off.

For models with Idling Stop System

When the engine is stopped by the Idling Stop System, heating, cooling and dehumidifying functions will be deactivated. To avoid the air conditioning functions from being deactivated, turn off the Idling Stop mode by pressing the Idling Stop OFF switch. For more details, see "Idling Stop System (if equipped for Thailand)" (P.5-18) or "Idling Stop System (for Hong Kong)" (P.5-19) .

NOTE:

- Odors from inside and outside the vehicle can build up in the air conditioner unit. Odor can enter the passenger compartment through the vents.
- When parking, set the heater and air conditioner controls to turn off air recirculation to allow fresh air into the passenger compartment. This should help reduce odors inside the vehicle.

OPERATING TIPS (for automatic air conditioner)

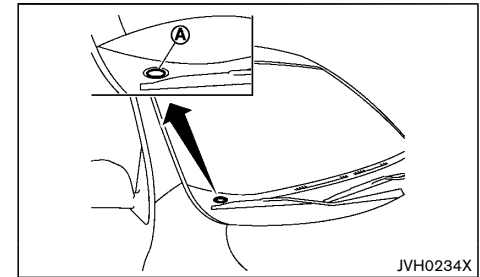

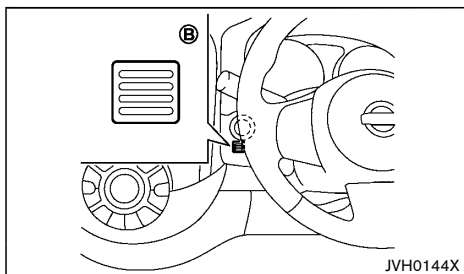

Right-Hand Drive (RHD) model*

When the engine coolant temperature and outside air temperature are low, the air flow from the foot outlets may not operate for a maximum of 150 seconds. However, this is not a malfunction. After the coolant temperature warms up, the air flow from the foot outlets will operate normally.

The sensors (A) and (B), located on the instrument panel, help maintain a constant temperature. Do not put anything on or around the sensors.

*: The illustration is for the Right-Hand Drive (RHD) model. For the Left-Hand Drive (LHD) model, the layout will be the opposite.

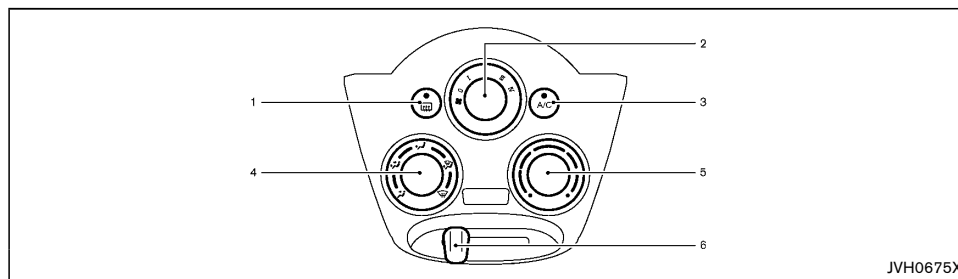

MANUAL AIR CONDITIONER

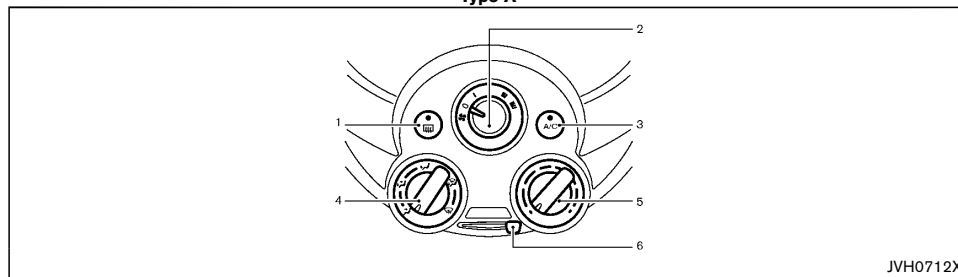

Type A



Type B

1. Rear window defogger switch (if equipped) (See "Defogger switch" (P.2-22).)
2. Fan speed control "  " dial
3. "A/C" (Air Conditioner) button (if equipped)
4. Air flow control dial
5. Temperature control dial
6. Air intake lever (Outside air circulation "  " /Air recirculation "  ")

To turn off the heater and air conditioner, turn the fan speed control "  " dial to the "OFF" (0) position.

NOTE:

For Hong Kong

The idling Stop System will not activate under the following conditions:

- When the air flow control dial knob is in the front defogger position and the fan speed control dial is on
- When rear window defogger switch is turned on

Controls

Outside air circulation:





Move the air intake lever to the “” position. The air flow is drawn from outside the vehicle.

Air recirculation:

Move the air intake lever to the “” position. The air flow is circulated inside the vehicle.

Air flow control:

Turn the air flow control dial to change the air flow mode.

-  — Air flows from the center and side ventilators.
-  — Air flows from the center and side ventilators and foot outlets.
-  — Air flows mainly from the foot outlets.
-  — Air flows from the defogger and foot outlets.
-  — Air flows mainly from the defogger outlets.

Fan speed control:

Turn the fan speed control “” dial clockwise to increase the fan speed.

Turn the fan speed control “” dial counterclockwise to decrease the fan speed.



Temperature control:

Turn the temperature control dial to set the desired temperature. Turn the dial between the middle and the right position to select the hot temperature. Turn the dial between the middle and the left position to select the cool temperature.

Heater operation



Heating:

This mode is used to direct heated air to the foot outlets.

1. Move the air intake lever to the “” position for normal heating.
2. Turn the air flow control dial to the “” position.
3. Turn the fan speed control “” dial to the desired position.
4. Turn the temperature control dial to the desired position between the middle and the hot (right) position.



Ventilation:

This mode directs outside air to the side and center ventilators.

1. Move the air intake lever to the “” position.
2. Turn the air flow control dial to the “” position.
3. Turn the fan speed control “” dial to the desired position.
4. Turn the temperature control dial to the desired position.

Defrosting or defogging:

This mode directs the air to the defogger outlets to defrost/defog the windows.



1. Move the air intake lever to the “” position.
2. Turn the air flow control dial to the “” position.
3. Turn the fan speed control “” dial to the desired position.
4. Turn the temperature control dial to the desired position between the middle and the hot (right) position.

5. Turn the side ventilators to the side windows to defrost or defog for a clear view to the side mirrors.

- To remove frost from the outside surface of the windshield quickly, turn the temperature control dial to the maximum hot position and the fan speed control “” dial to the maximum position.
- If it is difficult to defog the windshield, turn the “A/C” button (if equipped) on.



Bi-level heating:

This mode directs cool air from the side and center vents and warm air from the foot outlets. When the temperature control dial is turned to the maximum hot or cool position, the air between the ventilators and the foot outlets is the same temperature.

1. Move the air intake lever to the “” position.
2. Turn the air flow control dial to the “” position.
3. Turn the fan speed control “” dial to the desired position.
4. Turn the temperature control dial to the desired position.

Heating and defogging:

This mode heats the interior and defogs the windows.





1. Move the air intake lever to the “” position.
2. Turn the air flow control dial to the “” position.
3. Turn the fan speed control “” dial to the desired position.
4. Turn the temperature control dial to the maximum hot (right) position.
5. Turn the side ventilators to the side windows to defrost or defog for a clear view to the side mirrors.

Air conditioner operation (if equipped)

The air conditioner system should be operated for approximately 10 minutes at least once a month. This helps prevent damage to the air conditioner system due to the lack of lubrication.



Cooling:

This mode is used to cool and dehumidify the air.

1. Move the air intake lever to the “” position.
 2. Turn the air flow control dial to the “” position.
 3. Turn the fan speed control “” dial to the desired position.
 4. Push the “A/C” button on. (The “A/C” indicator light will illuminate.)
 5. Turn the temperature control dial to the desired position between the middle and the cool (left) position.
- For quick cooling when the outside temperature is high, move the air intake lever to the “” position. Be sure to move the air intake lever to the “” position for normal cooling.
 - A visible mist may be seen coming from the ventilators in hot, humid conditions as the air is cooled rapidly. This does not indicate a malfunction.

Dehumidified heating:



This mode is used to heat and dehumidify the air.

1. Move the air intake lever to the “” position.
2. Turn the air flow control dial to the “” position.
3. Turn the fan speed control “” dial to the desired position.
4. Push the “A/C” button on. (The “A/C” indicator light will illuminate.)

5. Turn the temperature control dial to the desired position between the middle and the hot (right) position.







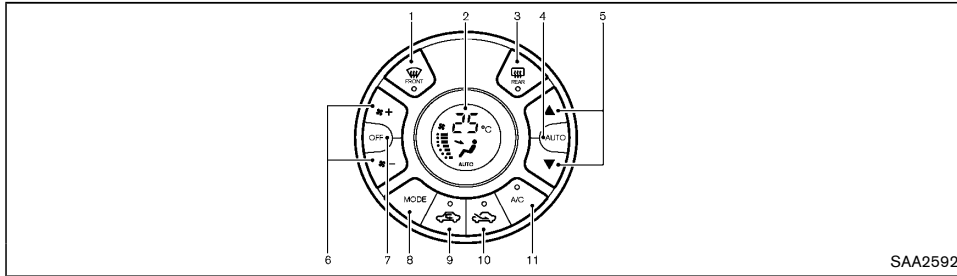

Dehumidified defogging:

This mode is used to defog the windows and dehumidify the air.

1. Move the air intake lever to the “” position.
2. Turn the air flow control dial to the “” position.
3. Turn the fan speed control “” dial to the desired position.
4. Push the “A/C” button on. (The “A/C” indicator light will illuminate.)
5. Turn the temperature control dial to the desired position.
6. Turn the side ventilators to the side windows to defrost or defog for a clear view to the side mirrors.

AUTOMATIC AIR CONDITIONER



1. Front defogger “ ” button
2. Display
3. Rear window defogger “ ” button (See “Defogger switch” (P.2-22).)
4. “AUTO” button
5. Temperature control “ ”/“ ” buttons
6. Fan speed control “ +” and “ -” buttons
7. “OFF” button
8. “MODE” (air flow control) button
9. Air recirculation “ ” button
10. Outside air circulation “ ” button
11. “A/C” (Air Conditioner) button

NOTE:

For Hong Kong





The idling Stop System will not activate when the front defogger button or rear window defogger button is turned on.

Automatic operation (AUTO)

The AUTO mode may be used year-round as the system automatically controls constant temperature, air flow distribution and fan speed after the desired temperature is set manually.

To turn off the heater and air conditioner, push the “OFF” button.



Cooling and dehumidified heating:

1. Push the “AUTO” button. (“AUTO” will appear on the display.)
2. If the “A/C” indicator light does not illuminate, push the “A/C” button. (The “A/C” indicator light will illuminate.)
3. Push the temperature control “ ”/“ ” button to set the desired temperature.
4. If the indicator light on either the outside air circulation “ ” button or the air recirculation “ ” button is illuminated, push and hold the button with the light illuminated to switch to the automatic air intake control mode. (The indicator light will blink twice.)







A visible mist may be seen coming from the ventilators

in hot, humid conditions as the air is cooled rapidly. This does not indicate a malfunction.

Heating (A/C off):

1. Push the “AUTO” button. (“AUTO” will appear on the display.)
 2. If the “A/C” indicator light illuminates, push the “A/C” button. (The “A/C” indicator light will turn off.)
 3. Push the temperature control “ ”/“ ” button to set the desired temperature.
- Do not set the temperature lower than the outside air temperature. Doing so may cause the temperature to not be controlled properly.
 - If the windows fog up, use dehumidified heating instead of the A/C off heating.

Dehumidified defrosting/defogging:

1. Push the front defogger “ ” button. (The “ ” indicator light will illuminate.)
 2. Push the temperature control “ ”/“ ” button to set the desired temperature.
- To remove frost from the outside surface of the windshield quickly, set the temperature to a high temperature and the fan speed to the maximum level.
 - After the windshield is cleared, push the front defogger “ ” button again. (The indicator light will turn off.)
 - When the front defogger “ ” button is pushed, the air conditioner will automatically turn on when the outside air temperature is above -2°C (28°F) to defog the windshield. The air recirculation mode will automatically turn off. The outside air circulation mode “ ” will be selected to improve the defogging performance.

Manual operation

The manual mode can be used to control the heater and air conditioner to your desired settings. (“MANUAL” will appear on the display.)

To turn off the heater and air conditioner, push the “OFF” button.

Fan speed control:

Push the fan speed control “+”/“-” button. Push the “+” button to increase the fan speed. Push the “-” button to decrease the fan speed.

Push the “AUTO” button to change the fan speed to the automatic mode.

Air flow control:

Push the “MODE” button to change the air flow mode.

- Air flows from the center and side ventilators.
- Air flows from the center and side ventilators and foot outlets.
- Air flows mainly from the foot outlets
- Air flows from the defogger outlets and foot outlets.

Temperature control:

Push the temperature control “▲”/“▼” button to set the desired temperature. Push the “▲” button to increase the temperature. Push the “▼” button to decrease the temperature.

Outside air circulation:

Push the outside air circulation “ ” button to draw the air flow from outside the vehicle. (The “ ” indicator light will illuminate.)

Air recirculation:

Push the air recirculation “ ” button to circulate the air flow inside the vehicle. (The “ ” indicator light will illuminate.)

Automatic air intake control:

If the indicator light on either the outside air circulation “ ” button or the air recirculation “ ” button is illuminated, push and hold the button with the light illuminated. (The indicator light will blink twice.) The automatic air intake control mode is set.

SERVICING AIR CONDITIONER



WARNING:

The air conditioner system contains refrigerant under high pressure. To avoid personal injury, any air conditioner service should be done only by an experienced technician with the proper equipment.

The air conditioner system in your vehicle is charged with a refrigerant designed with the environment in mind.

This refrigerant will not harm the earth's ozone layer. However, it may contribute in a small part to global warming.

Special charging equipment and lubricant are required when servicing your vehicle's air conditioner. Using improper refrigerants or lubricants will cause severe damage to the air conditioner system.

See “Air conditioner system refrigerant and lubricant” (P.9-5).

A NISSAN dealer will be able to service your environmentally friendly air conditioner system.

Air conditioner filter (if equipped)

The air conditioner system is equipped with an air conditioner filter which collects pollen. To make sure the air conditioner heats, defogs, and ventilates efficiently, replace the filter according the specified maintenance intervals listed in the separate maintenance booklet. To replace the filter, contact a NISSAN dealer.

The filter should be replaced if the air flow decreases significantly or if windows fog up easily when operating the heater or air conditioner.

REAR COMFORT FAN (if equipped)

warms the rear seats.

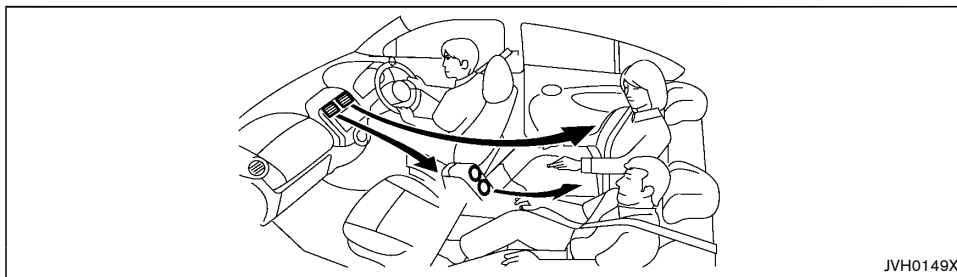

The rear comfort fan improves the comfort level of the rear passengers by sending air-conditioned air from the front seats area to the rear seats.

Using rear comfort fan

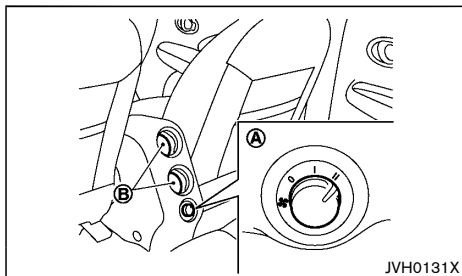

1. Turn on the air conditioner located on the instrument panel. Wait for the front seats area to reach the preferred temperature.
2. Turn on the rear comfort fan.

The fan speed of the rear comfort fan can be adjusted with the control dial (A) located in front

of the rear seats. Turn the dial to set the preferred fan speed.

- 0 : Fan off
- I : Minimum fan speed
- II : Maximum fan speed

3. The air from the front center ventilators is drawn in and blown out of the rear ventilators (B). Adjust the amount and the direction of the air flow by opening, closing or rotating the rear ventilators.

NOTE:

- When using the air conditioner (cooler), by directing the air from the front center ventilators downward toward the Rear Comfort Fan, cooled air from the front center ventilators will flow more effectively to the rear seats, allowing better in-cabin air circulation while providing the rear passengers with the cool feel of the wind.
- The temperature in the front seats needs to be air-conditioned (this may take up to 10 minutes after turning on the air conditioner) before the rear comfort fan effectively cools/

AUDIO SYSTEM (if equipped)

AUDIO OPERATION PRECAUTIONS



WARNING:

Do not adjust the audio system while driving so that full attention may be given to vehicle operation.

The audio system operates when the ignition switch is in the "ACC" or "ON" position.

Radio

- Radio reception is affected by station signal strength, distance from radio transmitter, buildings, bridges, mountains and other external influences. Intermittent changes in reception quality normally are caused by these external influences.
- Using a cellular phone in or near the vehicle may influence radio reception quality.

Compact Disc (CD) player

- During cold weather or rainy days, the player may malfunction due to the humidity. If this occurs, remove the CD from CD player and dehumidify or ventilate the player completely.
- The player may skip while driving on rough roads.
- The CD player sometimes may not function when the passenger compartment temperature is extremely high. Lower the temperature before use.
- Do not expose the CD to direct sunlight.
- CDs that are of poor quality, or are dirty, scratched, covered with fingerprints, or that have pin holes may not work properly.
- The following CDs may not work properly.
 - Copy control compact discs (CCCD)

- Recordable compact discs (CD-R)
- Rewritable compact discs (CD-RW)

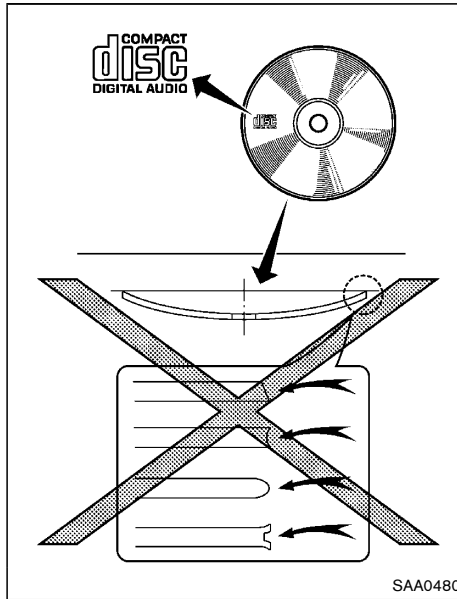

- Do not use the following CDs as they may cause the CD player to malfunction.
 - 8 cm (3.1 in) discs
 - CDs that are not round
 - CDs with a paper label
 - CDs that are warped, scratched or have unusual edges.
- This audio system can only play prerecorded CDs. It has no capabilities to record or burn CDs.

- If the CD cannot be played, one of the following messages will be displayed.

Check disc:

- Confirm that the CD is inserted correctly (the label side is facing up, etc.).
- Confirm that the CD is not bent or warped and it is free of scratches.

CD reading error:

After this message is displayed, the beep sounds and then the CD in the unit will be ejected.

- Confirm that the CD is inserted correctly (the label side is facing up, etc.).
- Confirm that the CD is not bent or warped and it is free of scratches.

Push eject:

This is a malfunction due to the temperature inside the player is too high. Remove the CD by pushing the EJECT button, and after a short time reinsert the CD. The CD can be played when the temperature of the player returns to normal.

Unplayable:

The file is unplayable in this audio system.

USB (Universal Serial Bus) (if equipped)



WARNING:

Do not connect, disconnect or operate the USB device while driving. Doing so can be a distraction. If distracted you could lose control of your vehicle and cause an accident or serious injury.



CAUTION:

- **Do not force the USB device into the USB port. Inserting the USB device tilted or upside-down into the port may damage the**

port. Make sure that the USB device is connected correctly into the USB port.

- **Do not grab the USB port cover (if equipped) when pulling the USB device out of the port. This could damage the port and the cover.**
- **Do not leave the USB cable in a place where it can be pulled unintentionally. Pulling the cable may damage the port.**

The vehicle is not equipped with a USB device. USB devices should be purchased separately as necessary.

This system cannot be used to format USB devices. To format a USB device, use a personal computer.

In some states/area, the USB device for the front seats plays only sound without images for regulatory reasons, even when the vehicle is parked.

This system supports various USB memory devices, USB hard drives and iPod players. Some USB devices may not be supported by this system.

- Partitioned USB devices may not be played correctly.
- Some characters used in other languages (Chinese, Japanese, etc.) are not displayed properly on display. Using English language characters with a USB device is recommended.

General notes for USB use:

Refer to your device manufacturer's owner information regarding the proper use and care of the device.

Compact Disc with MP3 or WMA

Explanation of terms:

- **MP3** — MP3 is short for Moving Pictures Experts Group Audio Layer 3. MP3 is the most well known compressed digital audio file format. This format allows for near "CD quality" sound, but at a fraction of the size of normal audio files. MP3 conversion of an audio track from CD can reduce the file size by approximately 10:1 ratio (Sampling: 44.1 kHz, Bit rate: 128 kbps) with virtually no perceptible loss in quality. MP3 compression removes the redundant and irrelevant parts of a sound signal that the human ear doesn't hear.
- **WMA** — Windows Media Audio (WMA) is a compressed audio format created by Microsoft as an alternative to MP3. The WMA codec offers greater file compression than the MP3 codec, enabling storage of more digital audio tracks in the same amount of space when compared to MP3s at the same level of quality.
- **Bit rate** — Bit rate denotes the number of bits per second used by a digital music files. The size and quality of a compressed digital audio file is determined by the bit rate used when encoding the file.
- **Sampling frequency** — The rate at which the samples of a signal are converted from analog to digital (A/D conversion) per second.
- **Multisession** — Multisession is one of the methods for writing data to media. Writing data once to the media is called a single session, and writing more than once is called a multisession.
- **ID3/WMA Tag** — The ID3/WMA tag is the part of the encoded MP3 or WMA file that contains information about the digital music file such as song title, artist, album title, encoding bit rate, track time duration, etc. ID3 tag information is

displayed on the Album/Artist/Song title line on the display.

* Windows® and Windows Media® are registered trademarks and trademarks in the United States of America and other countries of Microsoft Corporation of the USA.

Playback order:

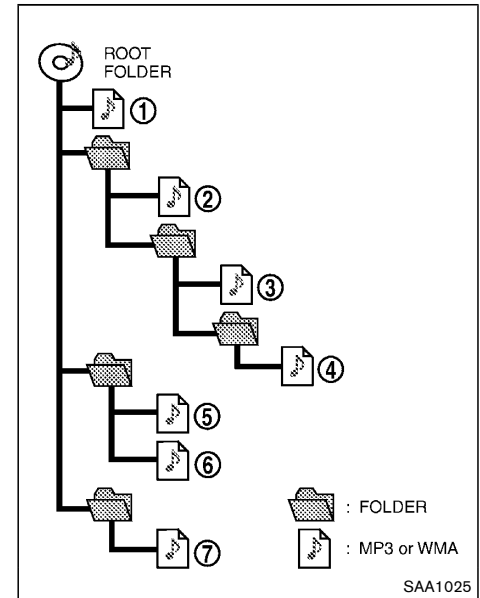

Playback order chart

The music playback order of the CD with MP3 or WMA is as illustrated.

- The names of folders not containing MP3 or WMA files are not shown in the display.
- If there is a file in the top level of the disc, "Root Folder" is displayed.
- The playback order is the order in which the files were written by the writing software. Therefore, the files might not play in the desired order.

Specification chart (model without USB connector):

Supported media		CD, CD-R, CD-RW	
Supported file systems		ISO9660 LEVEL1, ISO9660 LEVEL2, Romeo, Joliet ISO9660 Level 3 (packet writing) is not supported. Files saved using the Live File System component (on a Windows Vista-based computer) are not supported.	
Supported versions*1	MP3	Version	MPEG1, MPEG2, MPEG2.5
		Sampling frequency	8 kHz - 48 kHz
		Bit rate	8kbps - 320 kbps, VBR*4
	WMA*3	Version	WMA7, WMA8, WMA9
		Sampling frequency	32 kHz - 48 kHz
		Bit rate	32 kbps - 192kbps, VBR*4
Tag information (Song title and Artist name)		ID3 tag VER1.0, VER1.1, VER2.2, VER2.3, VER2.4 (MP3 only)	
		WMA tag (WMA only)	
Folder levels		Folder levels: 8, Folders: 255 (including route folder), Files: 512 (Max. 255 files for one folder)	
Displayable character codes*2		01: ASCII, 02: ISO-8859-1, 03: UNICODE (UTF-16 BOM Big Endian), 04: UNICODE (UTF-16 Non-BOM Big Endian), 05: UNICODE (UTF-8), 06: UNICODE (Non-UTF-16 BOM Little Endian)	

*1 Files created with a combination of 48 kHz sampling frequency and 64 kbps bit rate cannot be played.

*2 Available codes depend on what kind of media, versions and information are going to be displayed.

*3 Protected WMA files (DRM) cannot be played.

*4 When VBR files are played, the playback time may not be displayed correctly. WMA7 and WMA8 are not applied to VBR.

Specification chart (model with USB connector):

Supported media		CD, CD-R, CD-RW	
Supported file systems		ISO9660 LEVEL1, ISO9660 LEVEL2, Romeo, Joliet ISO9660 Level 3 (packet writing) is not supported. Files saved using the Live File System component (on a Windows Vista-based computer) are not supported.	
Supported versions*1	MP3	Version	MPEG1, MPEG2, MPEG2.5
		Sampling frequency	8 kHz - 48 kHz
		Bit rate	32 kbps - 320 kbps, VBR*4
	WMA*3	Version	WMA7, WMA8, WMA9
		Sampling frequency	32 kHz - 48 kHz
		Bit rate	48 kbps - 320 kbps, VBR*4
	AAC	Version	MPEG-4 AAC
		Sampling frequency	8 kHz - 48 kHz
		Bit rate	32 kbps - 192 kbps, VBR*4
Tag information (Song title and Artist name)		ID3 tag VER1.0, VER1.1, VER2.2, VER2.3, VER2.4 (MP3 only) WMA tag (WMA only)	
Folder levels		Folder levels: 8, Folders: 255 (including route folder), Files: 512 (Max. 255 files for one folder)	
Displayable character codes*2		01: ASCII, 02: ISO-8859-1, 03: UNICODE (UTF-16 BOM Big Endian), 04: UNICODE (UTF-16 Non-BOM Big Endian), 05: UNICODE (UTF-8), 06: UNICODE (Non-UTF-16 BOM Little Endian)	

*1 Files created with a combination of 48 kHz sampling frequency and 64 kbps bit rate cannot be played.

*2 Available codes depend on what kind of media, versions and information are going to be displayed.

*3 Protected WMA files (DRM) cannot be played.

*4 When VBR files are played, the playback time may not be displayed correctly. WMA7 and WMA8 are not applied to VBR.

Troubleshooting guide:

Symptom	Cause and Countermeasure
Cannot play	Check if the disc was inserted correctly.
	Check if the disc is scratched or dirty.
	Check if there is condensation inside the player, and if there is, wait until the condensation is gone (about 1 hour) before using the player.
	If there is a temperature increase error, the CD player will play correctly after it returns to the normal temperature.
	If there is a mixture of music CD files (CD-DA data), MP3/WMA files on a CD, only the music CD files (CD-DA data) will be played.
	Files with extensions other than ".MP3", ".WMA", ".mp3" or ".wma" cannot be played. In addition, the character codes and number of characters for folder names and file names should be in compliance with the specifications.
	Check if the disc or the file is generated in an irregular format. This may occur depending on the variation or the setting of MP3/WMA writing applications or other text editing applications.
	Check if the finalization process, such as session close and disc close, is done for the disc.
	Check if the disc is protected by copyright.
Poor sound quality	Check if the disc is scratched or dirty.
It takes a relatively long time before the music starts playing.	If there are many folder or file levels on the MP3/WMA disc, or if it is a multisession disc, some time may be required before the music starts playing.
Music cuts off or skips	The writing software and hardware combination might not match, or the writing speed, writing depth, writing width, etc., might not match the specifications. Try using the slowest writing speed.
Skipping with high bit rate files	Skipping may occur with large quantities of data, such as for high bit rate data.
Move immediately to the next song when playing.	When a non-MP3/WMA file has been given an extension of ".MP3", ".WMA", ".mp3", ".wma", or when play is prohibited by copyright protection, there will be approximately 5 seconds of no sound and then the player will skip to the next song.
The songs do not play back in the desired order.	The playback order is the order in which the files were written by the writing software, so the files might not play in the desired order.

ANTENNA

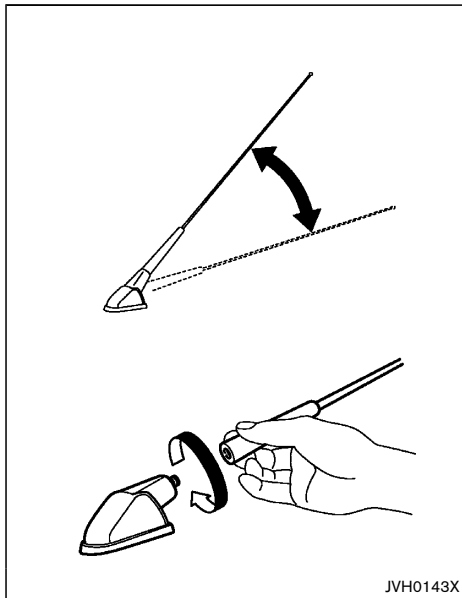

The angle of the antenna can be changed.

Removing antenna

You can remove the antenna if necessary.

Hold the bottom of the antenna and remove by turning counterclockwise.

To install the antenna, turn the antenna clockwise and tighten.



CAUTION:

- Be sure to fold down the antenna before the vehicle enters a garage with a low ceiling.
- Be sure that antenna is removed before the vehicle enters an automatic car wash.

FM-AM RADIO WITH COMPACT DISC (CD) PLAYER (Type A)

17. MENU button

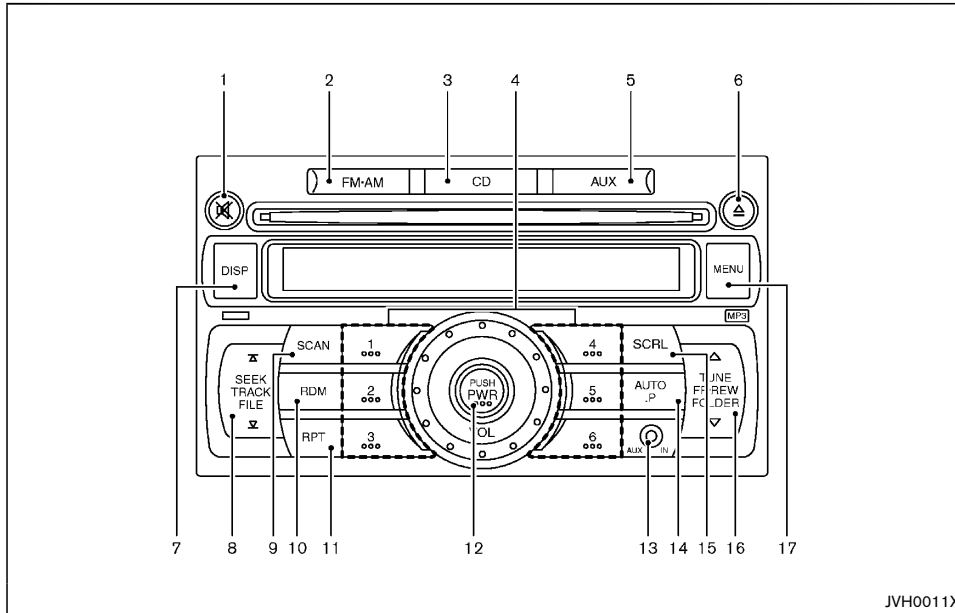

- | | |
|-----------------------------------|--|
| 1. MUTE button | 9. SCAN button |
| 2. FM-AM radio band select button | 10. RDM (Random) button |
| 3. CD button | 11. RPT (Repeat) button |
| 4. Radio memory buttons | 12. Power button/Volume control knob |
| 5. AUX button | 13. AUX IN (auxiliary input) jack |
| 6. CD EJECT button | 14. AUTO.P (Automatic Preset) button |
| 7. DISP button | 15. SCRL (Scroll) button |
| 8. SEEK/TRACK/FILE button | 16. TUNE/FF (Forward)·REW (Rewind)/FOLDER button |

Audio main operation

The audio system operates when the ignition switch is in the "ACC" or "ON" position.

POWER button:

To turn on the audio system, push the Power button.

- The system will turn on in the mode, which was used immediately before the system was turned off.
- If there is no CD loaded, the radio will be turned on.

To turn off the audio system, push the PWR button.

Volume control:

To control the volume, turn the VOLUME control knob.

Turn the knob clockwise to make the sound louder.





Turn the knob counterclockwise to make the sound quieter.

MENU button:

To change the audio settings, push the  button to select the mode while the CD or radio is on.

Push the  button until the desired mode appears on the display.

BASS → TREBLE → FADE → BALANCE → BEEP → CLOCK → BASS

Push the SEEK/TRACK/FILE button ( or ) or TUNE/FF-REW/FOLDER button ( or ) to adjust the audio settings.

BASS : (-) to decrease / (+) to increase





TREBLE : (-) to decrease / (+) to increase

FADE : (F) to adjust fade to the front/ (R) to adjust fade to the rear

BALANCE : (R) to adjust balance to the right/ (L) to adjust balance to the left





Once the audio settings are set to the desired level, push the  button until the radio or CD display appears.

If no action is performed for approximately 5 seconds, the audio settings mode will automatically return to the normal mode.

To turn the beep sound off or on, push the SEEK/TRACK/FILE button  or  or TUNE/FF-REW/FOLDER button  or  until the desired mode is displayed. This turns on or off the beep sound when audio buttons are pushed.





Clock display:

To display the clock on the screen, perform the following operations.

1. Push the  button repeatedly until CLOCK ON or OFF appears on the display while the audio system is on.
2. Push the SEEK/TRACK/FILE button  or  or TUNE/FF-REW/FOLDER button  or  to select CLOCK ON.

Clock adjustment:

To adjust the clock, turn the clock display on and perform the following operations.

1. Push the  button while CLOCK ON is on the display. The hour and minute digits blink.
2. To adjust the hours, push the SEEK/TRACK/FILE button  or .
3. To adjust the minutes, push the TUNE/FF-REW/FOLDER button  or .

If no user input is detected for 10 seconds, or when the "MENU" button is pushed, the clock setting mode will automatically return to the normal mode.

MUTE button:

Press the  button to mute the sound. Press again to restore the sound.

AUX button:

The AUX IN jack is located on the audio unit. The AUX IN audio input jack accepts any standard analog audio input such as from a portable cassette tape, CD player, MP3 player or laptop computer.

Push the AUX button to play a compatible device when it is plugged into the AUX IN jack.

NISSAN strongly recommends using a stereo mini plug cable when connecting your music device to the audio system. Music may not play properly when a monaural cable is used.

WARNING:

Do not allow the cable or an external device connected to the AUX terminal to affect your driving.

NOTE:

- Depending on the external device, please note that the volume may be louder or quieter than that of the external device.
- When the AUX contacts the plug of the connector cable, noise may be heard.
- The connected external device cannot be operated with the main audio system. The volume and sound quality can be adjusted.
- The song title in the external device cannot be displayed on the audio display.

- **For the power source of the external device, use the special battery. The external device cannot be charged with the AUX terminal. Noise may be heard if the CD, radio etc. is operated while charging the battery with the power socket of the vehicle.**

FM-AM radio operation

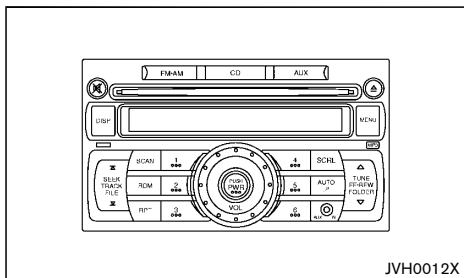

JVH0012X

The audio system operates when the ignition switch is in the "ACC" or "ON" position.

FM•AM button:

When the **FM•AM** button is pushed while the audio system is off, the audio system will turn on and the radio will turn on.

When the **FM•AM** button is pushed while another audio source is playing, the other audio source will turn off and the radio will turn on.

To change the radio bands, push the **FM•AM** button until the desired band is displayed.

AM → FM1 → FM2

The FM stereo indicator, "ST" will display during FM stereo reception. When the stereo broadcast signal is weak, the radio will automatically change from stereo

to monaural reception.

▲ ▼ TUNE/FF-REW/FOLDER button:

When adjusting the broadcasting station frequency manually, push the ▲ or ▼ button until the desired frequency is achieved.

When adjusting the broadcasting station frequency automatically, push the ▲ or ▼ button. When the system detects a broadcasting station, it will stop at the station.

▲ ▼ SEEK button:

When adjusting the broadcasting station frequency automatically, push the ▲ or ▼ button. When the system detects a broadcasting station, it will stop at the station.

SCAN button:

When the **SCAN** button is pushed, the system will seek and stop at the detected broadcasting station for 5 seconds, and then it will start to seek for the next broadcasting station.

Push the **SCAN** button in this 5-second period to stop seeking.

Radio memory button:

The audio system can store up to 12 FM station frequencies (for FM1 and FM2) and 6 AM station frequencies.

To store the station frequency:

1. Tune to the desired broadcasting station frequency by using the ▲ or ▼ button.
2. Push and hold a memory button (1 - 6) until a beep sounds.

3. The switch number and frequency will appear on the display when the memory is stored properly.
4. Perform steps 1 - 3 for all other memory buttons. Push a memory button (1 - 6) to select a memory.

If the battery cable is disconnected or if the audio fuse blows, the radio memory will be erased. In such a case, reset the desired stations.

AUTO.P (Automatic Preset) button:

The audio system can store up to 6 FM station frequencies and 6 AM station frequencies.

To store the station frequency automatically, push and hold the **AUTO.P** button until a beep sounds. The station will be automatically stored in the "AUTO.P" memory. The display indicates "AP-***".

Push the **AUTO.P** button to select a memory.

CD player operation

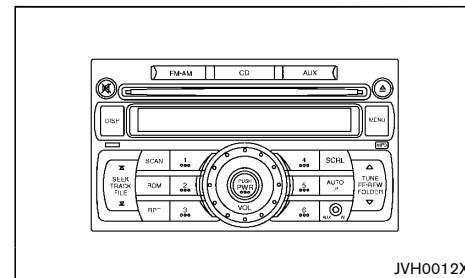

JVH0012X

The audio system operates when the ignition switch is in the "ACC" or "ON" position.

Loading:

Insert a CD into the slot with the label side facing up. The CD will be guided automatically into the slot and will start playing. To stop playing, push the Power button.



CAUTION:

Do not force the compact disc into the slot. This could damage the player.

CD button:

When the **CD** button is pushed while a CD is loaded, the CD will start playing automatically.

DISP button:

When the **DISP** button is pushed while a CD with a title is being played, the display will change as follows:

CD:



CD with MP3 or WMA:



SEEK/TRACK/FILE button:

When the **SEEK/TRACK/FILE** button (located on the left side) is pushed while a CD is being played, the present track will be advanced and move to the next track. Push the **SEEK/TRACK/FILE** button several times to skip forward tracks. The CD will advance the number of times the button is

pushed. When the last track of the CD is forwarded, the first track will be played.

When the **SEEK/TRACK/FILE** button is pushed while a CD is being played, the present track will start over from the beginning of the current track. Push the **SEEK/TRACK/FILE** button several times to skip back tracks. The CD will rewind the number of times the button is pushed. When the first track of the CD is rewound, the last track will be played.



TUNE/FF-REW/FOLDER button:

When the **TUNE/FF-REW/FOLDER** button (located on the right side) is pushed and held while a CD is being played, the CD will be played while forwarding or rewinding. When the button is released, the CD will return to the normal play speed.

When the **TUNE/FF-REW/FOLDER** button is pushed while a CD with MP3 or WMA is being played, the first track in the next or the previous folder will be played.



SCAN button:

When the **SCAN** button is pushed while a CD is being played, the first 10 seconds of all the tracks will be played.

When the **SCAN** button is pushed again, the CD will return to normal play from the track which is playing.



RPT (Repeat) button:

To change the play settings, push the **RPT** button to select the mode.

CD:

RPT DISC → RPT TRACK

CD with MP3 or WMA:

RPT DISC → RPT FOLDER → RPT TRACK

• RPT DISC:

All the tracks of the CD will be played continuously in sequential order. The display indicates no symbol mark. While the **RPT** button is pushed, the display indicates "RPT DISC".

• RPT TRACK:

The selected track of the CD will be played continuously. While the **RPT** button is pushed, the display indicates "RPT TRACK".

• RPT FOLDER:

All the tracks of selected folder will be played continuously in sequential order (CD with MP3 or WMA only). While the **RPT** button is pushed, the display indicates "RPT FOLDER".

RDM (Random) button:

To change the play sequence, push the **RDM** button to select the mode.

CD:

RDM DISC → RPT DISC

CD with MP3 or WMA:

RDM DISC → RDM FOLDER → RPT DISC

• RPT DISC:

All the tracks of the CD will be played continuously in sequential order. The display indicates no symbol mark. While the **RDM** button is pushed, the display indicates "RPT DISC".

• RDM DISC:

All the tracks or folders (CD with MP3 or WMA only) of the CD will be played continuously in random order. While the **RDM** button is pushed, the display indicates "RDM DISC".

- **RDM FOLDER:**

All the tracks of the selected folder will be played continuously in random order (CD with MP3 or WMA only). While the **RDM** button is pushed, the display indicates "RDM FOLDER".

SCRL (Scroll) button:

When the title is displayed but it is a long one, the whole title is not shown in the display. In this case, push the button to scroll the title. When the title is scrolled to the end of it, the display will stop moving and return to the first condition.

CD EJECT button:

To eject a CD, push the CD EJECT  button.

When the  button is pushed twice, the CD will be ejected further, and the CD can be removed with ease.

If a CD is ejected by pushing the  button, and it is not taken out from the loading slot, the CD will automatically be reloaded to the slot to protect the CD.

FM-AM RADIO WITH COMPACT DISC (CD) PLAYER (Type B)

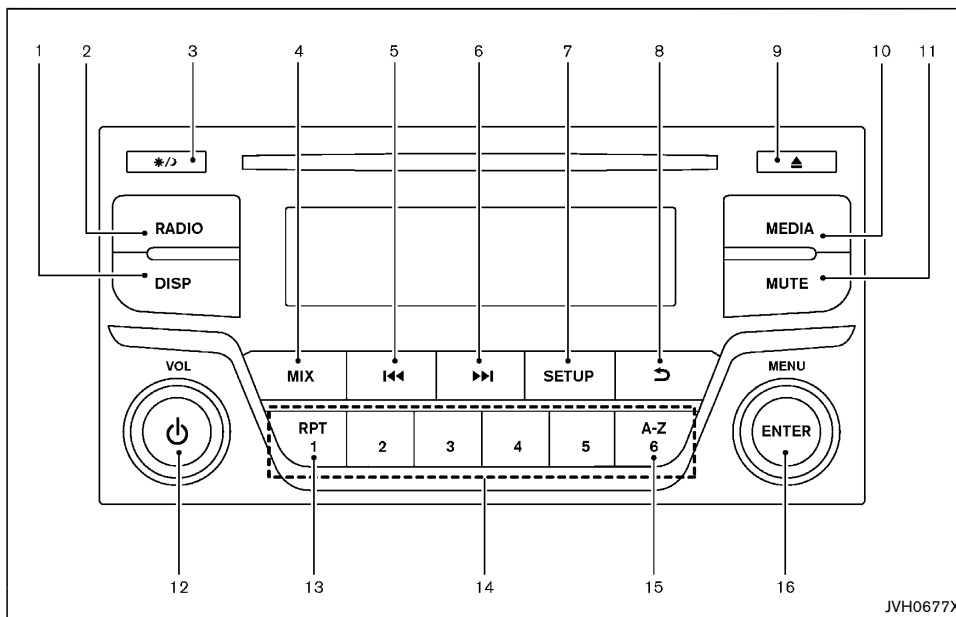

- | | |
|------------------------------------|---------------------------------------|
| 1. DISP (Display) button | 9. CD eject button |
| 2. RADIO button | 10. MEDIA button |
| 3. Day/Night button | 11. MUTE button |
| 4. MIX button | 12. Power button /Volume control knob |
| 5. SEEK button/Rewind button | 13. RPT button |
| 6. SEEK button/Fast forward button | 14. Radio memory buttons |
| 7. SETUP button | 15. A-Z button |
| 8. Back button | 16. ENTER button/MENU knob |

Audio main operation

The audio system operates when the ignition switch is in the "ACC" or "ON" position.



Power button/Volume control knob:

Power ON/OFF:

To turn on the audio system, push the Power button.

- The system will turn on in the mode that was used immediately before the system was turned off.
- If a CD was loaded or a USB, and/or an AUX device was connected when the system was turned off, and if the system was turned on again with the CD ejected or the devices disconnected, the radio will turn on.

To turn off the audio system, push the Power button.

Volume control:

To control the volume, turn the Volume control knob.

Turn the knob clockwise to make the sound louder.

Turn the knob counterclockwise to make the sound quieter.



SETUP button:

To configure Audio, Clock, Radio or Language, perform the following procedure.

1. Push the  button.
2. Turn the MENU knob clockwise or counterclockwise, the display will appear in the following order.
Audio Setting → Clock → Radio Setting → Language → Audio Setting
3. Push the ENTER button to select the item.

Audio adjustments:

Push the  button and then select Audio Setting.

Turn the MENU knob, and the mode will change as follows.

Sound → Aux In → Speed Volume → Bass Boost

Push the ENTER button to select the setting you want to change. Turn the MENU knob to adjust the selected item.

Sound:

Adjust Bass, Treble, Balance and Fade. Turn the MENU knob and then push the ENTER button to select the setting item. Turn the MENU knob to adjust the setting.

- Bass:
Enhances or attenuates the bass response sound.
- Treble:
Enhances or attenuates the treble.
- Balance:
Adjusts the balance of the volume between the left and right speakers.
- Fade:
Adjusts the balance of the volume between the front and rear (if equipped) speakers.

Aux In:

Adjusts the volume output from the auxiliary source.

Speed Volume:



Adjust the volume output from the speakers automatically in relation to the vehicle speed.

Adjusting the setting to 0 (zero) turns off the speed volume feature.

Bass Boost:

Set the bass volume between on or off.

If set in the "ON" position, bass sound is emphasized.

After the desired settings have been set, push either the  button or the  button continuously, and wait for 10 seconds without pushing any other buttons to exit the menu screen.

Clock setting:

Push the  button to enter the setup menu screen and then select Clock.

Turn the MENU knob, and the mode will change as follows.

Set Time → ON/OFF → Format → Set Time

Set Time:

Select "Set Time" and then adjust the clock as follows.

The hour display will start flashing. Turn the MENU knob to adjust the hour and push the ENTER button. The minute display will start flashing. Turn the MENU knob to adjust the minute and push the ENTER button to finish the clock adjustment.

ON/OFF:

Set the clock display between on or off when the audio unit is turned off. If set in the "ON" position, the clock will be displayed when the audio unit is turned off either by pushing the Power button or when the ignition switch is placed in the "OFF" position.

Format:

Switch the clock display between 24-hour mode and 12-hour clock mode.

Language setting:

Push the  button to enter the setup menu screen and then select Language.

Select the appropriate language and push the ENTER button. Upon completion, the screen will automatically adapt the language setting.

Day/Night button:

Push the  button to switch the display brightness between the daytime and nighttime modes.

MUTE button:

Push the  button to mute the audio system. Push the button again to unmute.

MEDIA button:

Push the  button to play a compatible device when it is connected.

Each time the  button is pushed, the audio source will change as follows.

CD → USB/iPod → AUX → CD

A source that is not available will be skipped.

Radio operation

The audio system operates when the ignition switch is in the “ACC” or “ON” position.

RADIO button:

When the  button is pushed while the audio system is off, the audio system will turn on and the radio will turn on.

When the  button is pushed while another audio source is playing, the other audio source will turn off and the radio will turn on.



To change the radio bands, push the  button until the desired band appears.



FM 1 → FM 2 → AM → FM 1

During FM reception, push and hold the  button to update FM list.

Turn the MENU knob to select a station from the FM list.

SEEK buttons:

When adjusting the broadcasting station frequency manually, push the  or  button until the desired frequency is achieved.





When adjusting the broadcasting station frequency automatically, push and hold the  or  button. When the system detects a broadcasting station, it will stop at the station.

(Radio memory) buttons:

During radio reception, pushing the radio memory button for less than 2 seconds will select the stored radio station.

The audio system can store up to 12 FM station frequencies (6 in each of FM 1, FM 2) and 6 AM station frequencies.

To store the station frequency manually:

1. Tune to the desired broadcasting station frequency by using the   buttons.
2. Push and hold a radio memory button -  until a beep sounds. (The radio mutes when the memory button is pushed.)
3. The channel indicator will display and the radio mute disengages, indicating that the memory is stored properly.
4. Perform steps 1 - 3 for all other memory buttons.

If the battery cable is disconnected, or if the audio fuse blows, the radio memory will be erased. In such a case, reset the desired stations.

CD player operation

The audio system operates when the ignition switch is in the “ACC” or “ON” position.

Loading:

Insert a CD into the slot with the label side facing up. The CD will be guided automatically into the slot and will start playing. After loading the CD, the number of tracks and the play time will appear on the display.



CAUTION:

Do not force the CD into the slot. This could damage the player.

NOTE:

- **The CD player accepts normal audio CDs or CDs containing MP3/WMA files.**
- **The audio unit will automatically detect if a CD containing MP3/WMA files is inserted, and [MP3CD] will be indicated.**
- **An error notification message will be displayed when inserting an incompatible disc type (e.g., DVD), or if the player cannot read the CD. Eject the disc and insert another disc.**



MEDIA button:

To change to the CD mode, push the  button with a CD inserted until the CD mode is selected.



List view:

While the track is being played, push either the ENTER button or the  button to display the available track in the list. To select a track from the list, or a track to start listening to, turn the MENU knob and then push the ENTER button.





Quick search:

In the list view mode, a quick search can be performed to find a track from the list. Push the A-Z button, turn the MENU knob to the first alphabetic letter of the song title, and then push the ENTER button. When found, a list of the available songs will be displayed. Select, and push the ENTER button to play the preferred track.



Fast Forward/Rewind buttons:

Push and hold the  or  button to fast forward or rewind through the track. When the button is released, the track will play at normal playing speed.



Track up/down:

By pushing the  or  button once, the track will skip forward to the next track or backward to the beginning of the current track. Push the  or  button more than once to skip through the tracks.

Folder browsing:

If the recorded media contains folders with music files, pushing the  or  button will play the tracks of each folder in sequence.

To select a preferred folder:

1. Push the ENTER button or the  button and a list of tracks in the current folder is displayed.
2. Push the  button.
3. Turn the MENU knob for the preferred folder.
4. Push the ENTER button to access the folder. Push the ENTER button again to start playing the first track or turn the MENU knob, and push the ENTER button to select another track.

If the current selected folder contains sub folders, push the ENTER button, and a new screen with a list of sub folders will be displayed. Turn the MENU knob for the sub folder and then push the ENTER button to select.

Select the root folder item when songs are recorded additionally in the root folder.

To return to the previous folder screen, push the  button.

RPT RPT button:

Push the  button and the current track will be played continuously.

MIX MIX button:

Push the  button and all the tracks will be played in a random order.



DISP DISP button:

While a CD with title information is being played, the title of the played track is displayed.

When the  button is pushed repeatedly while a CD with MP3/WMA/AAC is playing, further information about the track can be displayed along with the track title as follows.

Track time → Artist → Album → Track time

Track details:

Pushing and holding the  button will turn the display into a detailed overview. Push the  button to return to the display for the main display mode.

CD Eject button:

When the  button is pushed while a CD is loaded, the CD will be ejected.

When the  button is pushed twice, the CD will be ejected further, and the CD can be removed with ease.

When the ignition switch is in the "OFF" or "LOCK" position it is possible to eject the CD currently being

played. However the audio unit will not be activated.

If a CD is ejected by pushing the  button, and it is not taken out from the loading slot within 8 seconds, the CD will automatically be reloaded to the slot in order to protect the CD.

USB memory device operation

USB main operation:

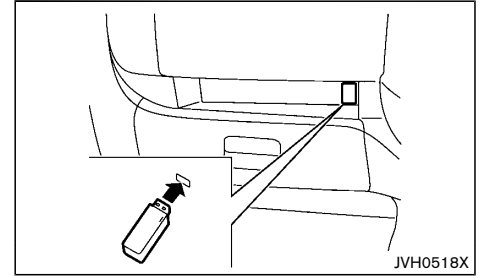

WARNING:

Do not connect, disconnect or operate the USB device while driving. Doing so can be a distraction. If distracted you could lose control of your vehicle and cause an accident or serious injury.

CAUTION:

- **Do not force the USB device into the USB port. Inserting the USB device tilted or upside-down into the port may damage the port. Make sure that the USB device is connected correctly into the USB port.**
- **Do not grab the USB port cover (if equipped) when pulling the USB device out of the port. This could damage the port and the cover.**



- **Do not leave the USB cable in a place where it can be pulled unintentionally. Pulling the cable may damage the port.**

Refer to your device manufacture's owner information regarding the proper use and care of the device.

The USB outlet connector is located above the glove box. Open the lid and connect a USB memory device into the connector. When the audio system operates the system will switch to the USB memory device mode automatically.

If the system has been turned off while the USB memory device was playing, pushing the Power/VOL dial will start the USB memory device.

The following operations are identical to the audio main operation of the Compact Disc (CD) operation. For details, see "CD player operation" (P.4-23).

- List view
- Quick search
-  
- MIX (Random play)
- RPT (Repeat track)
- Folder browsing

MEDIA MEDIA button:

To change to the USB mode, push the **MEDIA** button with a USB connected until the USB mode is selected.

DISP DISP button:

While a track with recorded music information tags (ID3-tags) is being played, the title of the played track is displayed. If the tags are not provided then a notification message is displayed.

When the **DISP** button is pushed continuously, further information about the track can be displayed along with the track title as follows.

Track time → Artist → Album → Track time

Track details:

Pushing and holding the **DISP** button will turn the display into a detailed overview. Push the  button to return to the display for the main display mode.

Auxiliary input jack

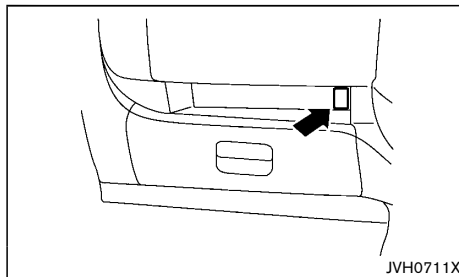

The AUX input jack is located above the glove box. The AUX input jack accepts any standard analog audio input such as from a portable cassette tape/CD player, MP3 player or laptop computer.

Push the **MEDIA** button to play a compatible device when it is plugged into the AUX input jack.

NISSAN strongly recommends using a stereo mini plug cable when connecting your music device to the audio system. Music may not play properly when a monaural cable is used.

CD/USB MEMORY CARE AND CLEANING

CD

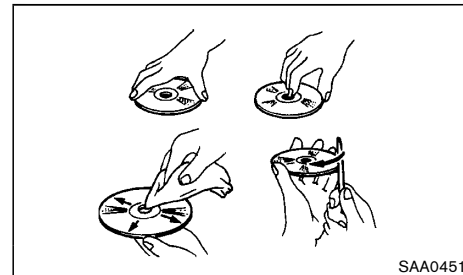

- Handle a disc by its edges. Never touch the surface of the disc. Do not bend the disc.
- Always place the discs in the storage case when they are not being used.
- To clean a disc, wipe the surface from the center to the outer edge using a clean, soft cloth. Do not wipe the disc using a circular motion.

Do not use a conventional record cleaner or alcohol intended for industrial use.

- A new disc may be rough on the inner and outer edges. Remove the rough edges by rubbing the inner and outer edges with the side of a pen or pencil as illustrated.

USB memory device (if equipped)

- Do not touch the terminal portion of the USB memory device.
- Do not place heavy objects on the USB memory device.
- Do not store the USB memory device in highly humid locations.

- Do not expose the USB memory device to direct sunlight.
- Do not spill any liquids on the USB memory device.

Refer to the USB memory device Owner's Manual for the details.

STEERING WHEEL SWITCH FOR AUDIO CONTROL (if equipped)

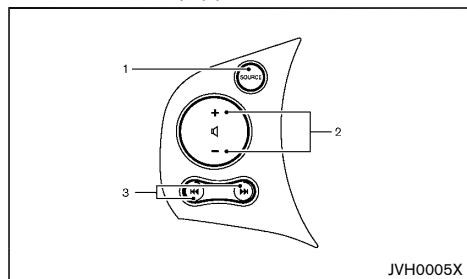

Type A

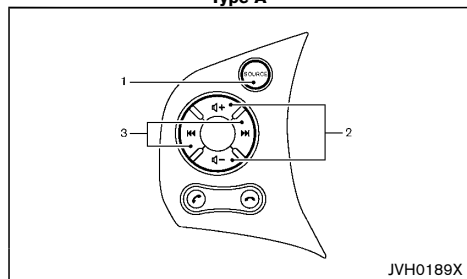

Type B

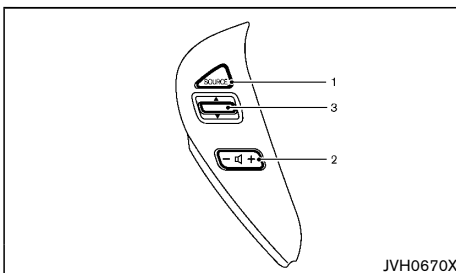

Type C

1. SOURCE select switch
2. VOLUME control switch
3. Tuning switch

The audio system can be operated using the controls on the steering wheel.

SOURCE select switch

Push the SOURCE select switch to change the mode to available audio source.

VOLUME control switch

Push the VOLUME control switch up or down to increase or decrease the volume.

Tuning switch

Memory change (radio):

Push the tuning switch for less than 1.5 seconds to change the next or previous radio preset.

SEEK tuning (radio):

Push the tuning switch for more than 1.5 seconds to seek the next or previous radio station.

APS (Automatic Program Search) FF, APS REW (CD):

Push the tuning switch for less than 1.5 seconds to return to the beginning of the present program or skip to the next program. Push several times to skip back or skip through programs.

USB (if equipped):

- Tilting up/down for less than 1.5 seconds will increase or decrease the track number.
- Tilting up/down for more than 1.5 seconds will increase/decrease the folder number.

CAR PHONE OR CB RADIO

When installing a CB, ham radio or a car phone in your vehicle, be sure to observe the following cautions, otherwise the new equipment may adversely affect the Engine Control System and other electronic parts.

CAUTION:

- Keep the antenna as far away as possible from the Electronic Control Module.
- Keep the antenna wire at least 20 cm (8 in) away from the Engine Control harnesses. Do not route the antenna wire next to any harnesses.
- Adjust the antenna standing wave ratio as recommended by the manufacturer.
- Connect the ground wire from the radio chassis to the body.
- For details, consult a NISSAN dealer.

Bluetooth® HANDS-FREE PHONE SYSTEM (if equipped)

WARNING:

- Use a phone after stopping your vehicle in a safe location. If you have to use a phone while driving, exercise extreme caution at all times so full attention may be given to vehicle operation.
- If you find yourself unable to devote full attention to vehicle operation while talking on the phone, pull off the road to a safe location and stop your vehicle before doing so.

CAUTION:

To avoid draining the vehicle battery, use a phone after starting the engine.

Your vehicle is equipped with Bluetooth® Hands-Free Phone System. If you are an owner of a Bluetooth® enabled cellular phone, you can set up the wireless connection between your cellular phone and the in-vehicle phone module. With Bluetooth® wireless technology, you can make or receive a telephone call with your cellular phone in your pocket.

Once your cellular phone is paired to the in-vehicle phone module, no phone connecting procedure is required. Your phone is automatically connected with the in-vehicle phone module when the ignition switch is placed to the "ON" position with the registered cellular phone turned on and carried in the vehicle.

You can register up to 5 different Bluetooth® cellular phones in the in-vehicle phone module. However, you can talk on only one cellular phone at a time.

When a call is active, the audio system and microphone (located in the ceiling in front of the rear view mirror) are used for the handsfree communica-

tions.

If the audio system is being used at the time, the audio mode will mute and will stay muted until the active call is ended.

Before using the Bluetooth® Hands-Free Phone System, refer to the following notes.

- Wireless LAN (Wi-Fi) and the Bluetooth® functions share the same frequency band (2.4 GHz). Using the Bluetooth® and the wireless LAN functions at the same time may slow down or disconnect the communication and cause undesired noise. It is recommended that you turn off the wireless LAN (Wi-Fi) when using the Bluetooth® functions.
- Set up the wireless connection between a cellular phone and the in-vehicle phone module before using the Bluetooth® Hands-Free Phone System.
- Some Bluetooth® enabled cellular phones may not be recognized by the in-vehicle phone module.
- You will not be able to use a hands-free phone under the following conditions:
 - Your vehicle is outside of the telephone service area.
 - Your vehicle is in an area where it is difficult to receive radio waves; such as in a tunnel, in an underground parking garage, behind a tall building or in a mountainous area.
 - Your cellular phone is locked in order not to be dialed.
- When the radio wave condition is not ideal or ambient sound is too loud, it may be difficult to hear the other person's voice during a call.
- Immediately after the ignition switch is placed to the "ON" position, it may be impossible to receive a call for a short period of time.

- Do not place the cellular phone in an area surrounded by metal or far away from the in-vehicle phone module to prevent tone quality degradation and wireless connection disruption.
- While a cellular phone is connected through the Bluetooth® wireless connection, the battery power of the cellular phone may discharge quicker than usual.
- If the Bluetooth® Hands-Free Phone System seems to be malfunctioning, please contact a NISSAN dealer.
- Some cellular phones or other devices may cause interference or a buzzing noise to come from the audio system speakers. Storing the device in a different location may reduce or eliminate the noise.
- Refer to the cellular phone Owner's Manual regarding the telephone pairing procedure specific to your phone, battery charging, cellular phone antenna, etc.
- The antenna display on the audio display will not coincide with the antenna display of some cellular phones.
- Keep the interior of the vehicle as quiet as possible to hear the caller's voice clearly as well as to minimize its echoes.
- If reception between callers is unclear, adjusting the incoming or outgoing call volume may improve the clarity.
- This wireless hands free car kit is based on Bluetooth® technology,
 - Frequency: 2402 MHz - 2480 MHz
 - Output Power: 4.14 dBm E.I.R.P
 - Modulation: FHSS GFSK 8DPSK, $\pi/4$ DQPSK

- Number of Channel: 79
- This wireless equipment can't be used for any services related to safety because there is the possibility of radio interference.

REGULATORY INFORMATION

Bluetooth® Trademark



Bluetooth® is a trademark owned by Bluetooth SIG, Inc. and licensed to Visteon Corporation.

CE statement



Hereby "Yangfeng Visteon Automotive Electronics Co., Ltd." and "Clarion Corporation" declares that this Bluetooth car kit AV System is in compliance with the essential requirements and other relevant provisions of Directive 1999/5/EC.

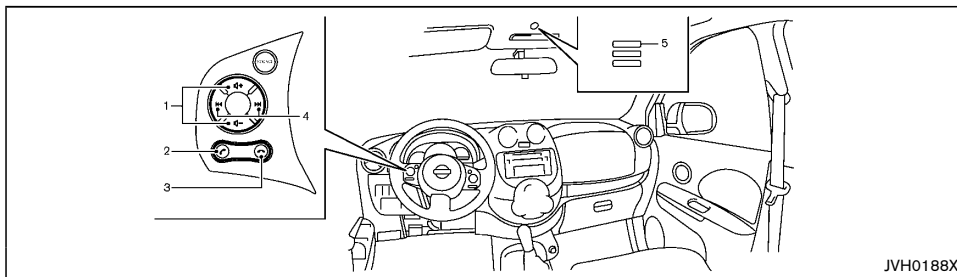

USING THE SYSTEM



Left-Hand Drive (LHD) model



1. Volume control button $-/+$
Increases or decreases the volume from the system.
2. PHONE SEND  button
3. PHONE END  button
4. SEEK  button
5. Microphone



*: The illustration is for the Left-Hand Drive (LHD) model. For the Right-Hand Drive (RHD) model, the layout will be the opposite.

Setup



Choosing a language:

You can interact with the Bluetooth® Hands-Free Phone System using English, Arabic, Mandarin, Russian or Korean. To change the language, perform the following.

1. Push and hold the  button for more than 5 seconds.
2. The system announces: "Press the PHONE END () button to select a different language."

3. Push the  button.
4. The system announces the current language and gives you the option to change the language. Push the SEEK  button to select a different language.

NOTE:

You must push the  button or the  button within 5 seconds to change the language.

5. If you decide not to change the language, do not push either button. After 5 seconds, the VR session will end, and the language will not be changed.

Pairing procedure:

1. Push the PHONE SEND  button. The system asks you to pair a new phone.
2. Initiate pairing from the cellular phone and enter a PIN code for pairing your Bluetooth® cellular phone. Operate it to enter the code "1234".





The code is always "1234" regardless of the number of phones paired. The pairing procedure

of the cellular phone varies according to each cellular phone manufacturer. See the cellular phone Owner's Manual for details.

3. After the prompt "Please say a name for the phone." by the system, say a name for the phone. If the name is too long, it will not be fully registered.
4. The system will inform you that the cellular phone is successfully registered.

Registering an additional phone:







You can register up to 5 different Bluetooth® cellular phones in the in-vehicle phone module. However, you can talk on only one cellular phone at a time.

1. Push the PHONE SEND  button and SEEK  button to select "Connect Phone", and then push the PHONE SEND  button.
2. Push the SEEK  button to select "Add Phone", and then push the PHONE SEND  button.
3. The system asks you to initiate pairing from your Bluetooth® cellular phone and enter a PIN code for pairing the phone. Operate it to enter the code "1234".









The pairing procedure of the cellular phone varies according to each cellular phone manufacturer. See the cellular phone Owner's Manual for details.

4. After the prompt "Please say a name for the phone." by the system, say a name for the phone. If the name is too long, it will not be fully registered.
5. The system will inform you that the cellular phone is successfully registered.

Selecting a registered phone:

1. Push the PHONE SEND  button and SEEK  button to select "Connect Phone", and then push the PHONE SEND  button.
2. Push the SEEK  button to select "Select Phone", and then push the PHONE SEND  button.
3. Push the SEEK  button. Each time the button is operated, the system announces the names of the phones. Select the phone you wish to use.
4. Push the PHONE SEND  button to complete the selection.

Deleting a registered phone:

1. Push the PHONE SEND  button and SEEK  button to select "Connect Phone", and then push the PHONE SEND  button.
2. Push the SEEK  button to select "Delete Phone", and then push the PHONE SEND  button.
3. Push the SEEK  button. Each time the button is operated, the system announces the name of the phones. Select the phone you wish to delete.
4. When the system asks if you want to delete, push the PHONE SEND  button. To cancel the deletion, push the PHONE END  button.
5. The system asks you to confirm the deletion. To delete the desired phone, push the PHONE SEND  button again.

NOTE:

When you delete a phone, the associated phonebook for the phone will also be deleted.

Bluetooth® on/off:

1. Push the PHONE SEND  button until the system announces "Settings menu".
2. Push the SEEK  button to select Bluetooth on or off.
3. To turn on/off the Bluetooth® hands-free phone system, push the PHONE SEND  button.

When Bluetooth® is off, you will not be able to make or receive calls by the hands-free mode. Also, you will not have access to the phonebook.

Phonebook





The phonebook stores up to 40 names for each phone paired with the system.

NOTE:

Each phone has its own separate phonebook. You cannot access Phone A's phonebook if you are currently connected with Phone B.



New entry:

This function is not available while driving.

1. Push the PHONE SEND  button and SEEK  button to select "PHONEBOOK", and then push the PHONE SEND  button.
2. Push the SEEK  button to select "Transfer Entry", and then push the PHONE SEND  button.
3. When the system says "Please transfer the phone number from your handset.", operate your cellular phone to send the phonebook to the system.











The memory sending procedure from the Bluetooth® cellular phone varies according to each

cellular phone manufacturer. See the cellular phone Owner's Manual for more details.

4. When prompted by the system, say the name that you would like to give for the new entry.
Speak in a natural voice without pausing between words.
5. When the system requires you to repeat the name, say the name again.
6. Push the PHONE SEND  button to continue the entry, or push the PHONE END  button to finish the phone mode.







Delete:

This function is not available while driving.







1. Push the PHONE SEND  button and SEEK  button to select "PHONEBOOK", and then push the PHONE SEND  button.
2. Push the SEEK  button to select "Delete Entry", and then push the PHONE SEND  button.
3. Push the SEEK  button and choose the phonebook entry you wish to delete.
4. When the system asks if you want to delete the contact, push the PHONE SEND  button. To cancel the deletion, push the PHONE END  button.
5. The system asks you to confirm the deletion.
6. To delete the desired contact, push the PHONE SEND  button again.
7. Push the PHONE SEND  button to continue the deletion or push the PHONE END  button to finish the phone mode.

Making a call

Phonebook:

1. Push the PHONE SEND  button and SEEK  button to select "CALL", and then push the PHONE SEND  button.
2. Push the SEEK  button to select "List Name", and then push the PHONE SEND  button.
3. Push the SEEK  button, and choose the phonebook entry you wish to call. The system acknowledges the name and begins the call.

Redial:

1. Push the PHONE SEND  button and SEEK  button to select "CALL", and then push the PHONE SEND  button.
2. Push the SEEK  button to select "Redial", and then push the PHONE SEND  button.
3. Push the PHONE SEND  button, and then the system begins the call.

Bluetooth® cellular phone keypad:

You can also make a call by operating the cellular phone that is registered to the in-vehicle phone module to use the hands-free phone system.

Ending a call:

Push the PHONE END  button on the steering wheel or the off button on the cellular phone.

Receiving or rejecting a call

When you hear the ring tone, push the PHONE SEND  button on the steering wheel.

If you do not wish to answer the call when you hear the ring tone, push the PHONE END  button.

Transferring a call

During a call, push the PHONE SEND  button to switch the call from the Bluetooth® Hands-Free Phone System to the cellular phone when privacy is desired.

Push the PHONE SEND  button again to return to the hands-free mode.

Some Bluetooth® cellular phones may not be able to return to the hands-free mode. Refer to the cellular phone Owner's Manual for information about reconnection.

Once the ignition switch is placed in the "OFF" position and then placed back in the "ON" position again, the system will automatically change to the hands-free mode as the default setting.

MEMO

5 Starting and driving

Break-in schedule	5-2	Driving vehicle	5-10
Before starting engine	5-2	Driving with Automatic Transmission (AT)	5-10
Precautions when starting and driving	5-2	Driving with Continuously Variable Transmission (CVT) ...	5-13
Exhaust gas (carbon monoxide)	5-3	Driving with Manual Transmission (MT)	5-16
Three-way catalyst (gasoline engine model)	5-3	Idling Stop System (if equipped for Thailand)	5-18
Care when driving	5-4	Operating Idling Stop System	5-18
Engine cold start period	5-4	Idling Stop OFF switch	5-19
Loading luggage	5-4	Idling Stop System (for Hong Kong)	5-19
Driving in wet conditions	5-4	Operating Idling Stop System	5-20
Driving in winter conditions	5-4	Idling Stop OFF switch	5-20
Ignition switch (model without Intelligent Key system)	5-4	Vehicle Dynamic Control (VDC) system (if equipped)	5-21
Automatic Transmission (AT)/Continuously Variable Transmission (CVT)	5-4	Vehicle Dynamic Control (VDC) OFF switch	5-22
Manual transmission (MT)	5-4	Parking	5-22
Steering lock	5-5	Sonar (parking sensor) system (if equipped)	5-24
Key positions	5-5	Trailer towing	5-25
Push-button ignition switch (model with Intelligent Key system)	5-5	Electric power steering system	5-25
Precautions on push-button ignition switch operation	5-5	Brake system	5-26
Intelligent Key system	5-5	Brake precautions	5-26
Steering lock	5-6	Brake assist (if equipped)	5-26
Ignition switch positions	5-6	Anti-lock Braking System (ABS) (if equipped)	5-27
Intelligent Key battery discharge	5-7	Using system	5-27
Starting engine (model without Intelligent Key system)	5-8	Self-test feature	5-27
Gasoline engine	5-8	Normal operation	5-27
Diesel engine	5-8	Vehicle security	5-28
Starting engine (model with Intelligent Key system)	5-9	Cold weather driving	5-28
Gasoline engine	5-9	Battery	5-28
Diesel engine	5-9	Engine coolant	5-28
		Tire equipment	5-28
		Special winter equipment	5-29
		Parking brake	5-29
		Corrosion protection	5-29

BREAK-IN SCHEDULE

During the first 1,600 km (1,000 miles), follow these recommendations to obtain maximum engine performance and ensure the future reliability and economy of your new vehicle. Failure to follow these recommendations may result in shortened engine life and reduced engine performance.

- Do not drive at a constant speed, either fast or slow, for long periods of time.
- Do not run the engine over 4,000 rpm. (HR12 or HR15 engine)
- Do not run the engine over 2,500 rpm. (K9K engine)
- Do not accelerate at full throttle in any gear.
- Do not start quickly.
- Do not brake hard as much as possible.

BEFORE STARTING ENGINE



WARNING:

The driving characteristics of your vehicle will change remarkably by any additional load and its distribution, as well as by adding optional equipment (trailer coupling, roof racks, etc.). Your driving style and speed must be adjusted according to the circumstances. Especially when carrying heavy loads, your speed must be reduced adequately.

- Make sure the area around the vehicle is clear.
- Visually inspect tires for their appearance and condition. Measure and check the tire pressure for proper inflation.
- Check that all windows and lights are clean.
- Adjust the seat and head restraint positions.
- Adjust the inside and outside rearview mirror positions.
- Fasten your seat belt and ask all passengers to do the same.
- Check that all doors are closed.
- Check the operation of the warning lights when the ignition switch is placed in the "ON" position.
- Maintenance items in the "8. Maintenance and do-it-yourself" section should be checked periodically.

PRECAUTIONS WHEN STARTING AND DRIVING



WARNING:

- **Never leave children or adults who would normally require the support of others alone in your vehicle. Pets should not be left alone either. They could unknowingly activate switches or controls and inadvertently become involved in a serious accident and injure themselves. On hot, sunny days, temperatures in a closed vehicle could quickly become high enough to cause severe or possibly fatal illness to people or animals.**
- **Closely supervise children when they are around your vehicle to prevent them from playing and becoming locked in the trunk where they could be seriously injured. Keep the vehicle locked with the trunk closed when not in use, and prevent children's access to vehicle keys.**

NOTE:

During the first few months after purchasing a new vehicle, if you smell strong odors of Volatile Organic Compounds (VOCs) inside the vehicle, ventilate the passenger compartment thoroughly. Open all the windows before entering or while in the vehicle. In addition, when the temperature in the passenger compartment rises, or when the vehicle is parked in direct sunlight for a period of time, turn off the air recirculation mode of the air conditioner and/or open the windows to allow sufficient fresh air into the passenger compartment.

EXHAUST GAS (carbon monoxide)



WARNING:

- Do not breathe exhaust gas; it contains colorless and odorless carbon monoxide. Carbon monoxide is dangerous. It can cause unconsciousness or death.
- If you suspect that exhaust fumes are entering the vehicle, drive with all windows fully open, and have the vehicle inspected immediately.
- Do not run the engine in closed spaces such as a garage.
- Do not park the vehicle with the engine running for an extended period of time.
- Keep the trunk lid closed while driving, otherwise exhaust gas could be drawn into the passenger compartment. If you must drive with the trunk lid open, follow these precautions:
 - Open all the windows.
 - Turn the air recirculation mode off and set the fan speed control to the highest level to circulate the air.
- If a special body or other equipment is added for recreational or other usage, follow the manufacturer's recommendation to prevent carbon monoxide entry into the vehicle. (Some recreational vehicle appliances such as stoves, refrigerators, heaters, etc. may also generate carbon monoxide.)
- The exhaust system and body should be inspected by a qualified mechanic whenever:

- Your vehicle is raised while being serviced.
- You suspect that exhaust fumes are entering into the passenger compartment.
- You notice a change in the sound of the exhaust system.
- You have had an accident involving damage to the exhaust system, underbody, or rear of the vehicle.

THREE-WAY CATALYST (gasoline engine model)



WARNING:

- The exhaust gas and the exhaust system are very hot. Keep people, animals and flammable materials away from the exhaust system components.
- Do not stop or park the vehicle over flammable materials such as dry grass, wastepaper or rags. They may ignite and cause a fire.

The three-way catalyst is an emission control device installed in the exhaust system. Exhaust gas in the three-way catalyst is burned at high temperatures to help reduce pollutants.



CAUTION:

- Do not use leaded gasoline. (See "Recommended fuel/lubricants and capacities" (P.9-2).) Deposits from leaded gasoline seriously reduce the ability of the three-way catalyst to help reduce exhaust pollutants and/or

damage the three-way catalyst.

- Keep your engine tuned up. Malfunctions in the ignition, fuel injection, or electrical systems may cause overrich fuel to flow into the three-way catalyst, causing it to overheat. Do not keep driving if the engine misfires, or if noticeable loss of performance or other unusual operating conditions are detected. Have the vehicle inspected promptly by a NISSAN dealer.
- Avoid driving with an extremely low fuel level. Running out of fuel could cause the engine to misfire, damaging the three-way catalyst.
- Do not race the engine while warming it up.
- Do not push or tow your vehicle to start the engine.

CARE WHEN DRIVING

Driving your vehicle to fit the circumstances is essential for your safety and comfort. As a driver, you should be the one who knows best how to drive in the given circumstances.

ENGINE COLD START PERIOD

Due to the higher engine speeds, when the engine is cold, extra caution must be exercised when selecting a gear during the engine warm-up period after starting the engine.

LOADING LUGGAGE

Loads and their distribution and the attachment of equipment (coupling devices, roof baggage carriers, etc.) will considerably change the driving characteristics of the vehicle. Your driving style and speed must be adjusted according to the circumstances.

DRIVING IN WET CONDITIONS

- Avoid accelerating or stopping suddenly.
- Avoid sharp turning or lane changing suddenly.
- Avoid following too close to the vehicle in front.

When water covers the road surface with water puddles, small water streams, etc., reduce speed to prevent hydroplaning which can cause skidding and loss of control. Worn tires will increase this risk.

DRIVING IN WINTER CONDITIONS

- Drive cautiously.
- Avoid accelerating or stopping suddenly.
- Avoid sharp turning or lane changing suddenly.
- Avoid sudden steering.
- Avoid following too close to the vehicle in front.

IGNITION SWITCH (model without Intelligent Key system)



WARNING:

Never remove the key or turn the ignition switch to the “LOCK” position while driving. The steering wheel will lock. This may cause the driver to lose control of the vehicle and could result in serious vehicle damage or personal injury.

AUTOMATIC TRANSMISSION (AT)/CONTINUOUSLY VARIABLE TRANSMISSION (CVT)

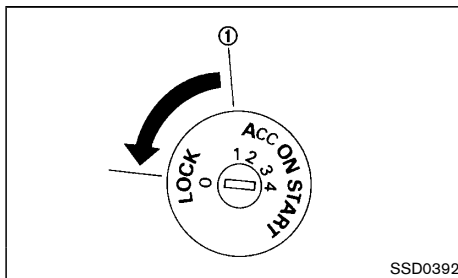

The ignition lock is designed so that the ignition switch cannot be turned to the “LOCK” position until the shift lever is moved to the “P” (Park) position. When moving the ignition switch to the “LOCK” position, to remove the key from the ignition switch, make sure the shift lever is in the “P” (Park) position.

When the ignition switch cannot be turned to the “LOCK” position:

1. Move the shift lever to the “P” (Park) position.
2. Turn the ignition switch slightly in the “ON” direction.

3. Turn the ignition switch to the “LOCK” position.
4. Remove the key, if it is inserted in the ignition switch.

If the ignition switch is turned to the “LOCK” position, the shift lever cannot be moved from the “P” (Park) position. The shift lever can be moved if the ignition switch is in the “ON” position with the foot brake pedal depressed.

The “OFF” position ① is between the “LOCK” and “ACC” positions, although it is not marked on the ignition switch.

MANUAL TRANSMISSION (MT)

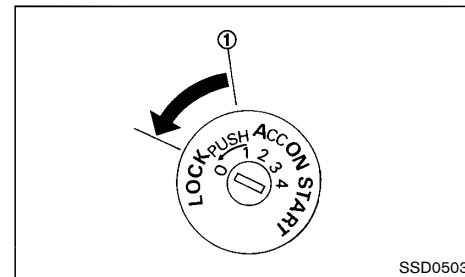

The ignition switch includes a device that prevents accidental removal of the key while driving.

The key can only be removed when the ignition switch is in the “LOCK” position.

To turn the ignition switch to the “LOCK” position from the “ACC” or “ON” position, turn the key to the “OFF” position, push the key in, then turn the key to the “LOCK” position.

The “OFF” position ① is between the “LOCK” and “ACC” positions, although it is not labeled on the ignition switch.

STEERING LOCK

To lock steering wheel

1. Turn the ignition switch to the "LOCK" position.
2. Remove the key.
3. Turn the steering wheel 1/6 of a turn clockwise from the straight up position.

To unlock steering wheel

1. Insert the key into the ignition switch.
2. Gently turn the ignition switch while rotating the steering wheel slightly right and left.

KEY POSITIONS

LOCK (0)

The ignition key can only be removed at this position.

The steering lock can only be locked at this position.

OFF (1)

The engine is turned off with the steering wheel unlocked.

ACC (2)

The electrical accessory power activates without the engine turned on.

ON (3)

The ignition system and the electrical accessory power activate without the engine turned on.

START (4)

The engine starter activates and the engine will start. The ignition switch, when released, will automatically turn to the "ON" position.



CAUTION:

As soon as the engine has started, release the ignition switch immediately.

PUSH-BUTTON IGNITION SWITCH (model with Intelligent Key system)

PRECAUTIONS ON PUSH-BUTTON IGNITION SWITCH OPERATION



WARNING:

Do not operate the push-button ignition switch while driving the vehicle except in an emergency. (The engine will stop when the ignition switch is pushed 3 consecutive times or the ignition switch is pushed and held for more than 2 seconds.) The steering wheel will lock and could cause the driver to lose control of the vehicle. This could result in serious vehicle damage or personal injury.

Before operating the push-button ignition switch, be sure to move the shift lever to the "P" (Park) position (for Automatic Transmission/Continuously Variable Transmission model) or the shift lever to the "N" (Neutral) position (for Manual Transmission model).

INTELLIGENT KEY SYSTEM

The Intelligent Key system can operate the ignition switch without taking the key out from your pocket or bag. The operating environment and/or conditions may affect the Intelligent Key system operation.



CAUTION:

- **Be sure to carry the Intelligent Key with you when operating the vehicle.**
- **Never leave the Intelligent Key inside the vehicle when you leave the vehicle.**
- **If the vehicle battery is discharged, the ignition switch cannot be switched from the "LOCK" position, and if the steering lock is engaged, the steering wheel cannot be moved. Charge the battery as soon as**

possible (See “Jump starting” (P.6-8).)
Operating range

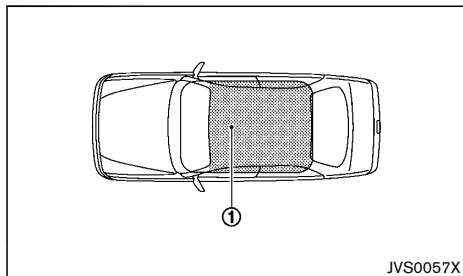

The Intelligent Key can only be used for starting the engine when the Intelligent Key is within the specified operating range ① as illustrated.

When the Intelligent Key battery is almost discharged or strong radio waves are present near the operating location, the Intelligent Key system's operating range becomes narrower and may not function properly.

If the Intelligent Key is within the operating range, it is possible for anyone, even someone who does not carry the Intelligent Key, to push the ignition switch to start the engine.

- The trunk area is not included in the operating range, but the Intelligent Key may function.
- If the Intelligent Key is placed on the instrument panel, rear parcel shelf, inside the glove box, door pocket or the corner of the interior compartment, the Intelligent Key may not function.
- If the Intelligent Key is placed near the door or window outside the vehicle, the Intelligent Key may function.

Automatic Transmission (AT)/Continuously Variable Transmission (CVT) model

The ignition lock is designed so that the ignition switch cannot be switched to the “LOCK” position until the shift lever is moved to the “P” (Park) position. When pushing the ignition switch to the “OFF” position, make sure the shift lever is in the “P” (Park) position.

When the ignition switch cannot be switched to the “LOCK” position:

1. Move the shift lever to the “P” (Park) position.
2. Push the ignition switch to the “OFF” position.
3. Open the door. The ignition switch will change to the “LOCK” position.

If the ignition switch is switched to the “LOCK” position, the shift lever cannot be moved from the “P” (Park) position. The shift lever can be moved if the ignition switch is in the “ON” position with the foot brake depressed.

STEERING LOCK

The ignition switch is equipped with an anti-theft steering lock device.

To lock steering wheel

1. Push the ignition switch to the “OFF” position where the ignition switch position indicator will not illuminate.
2. Open or close the door. The ignition switch turns to the “LOCK” position.
3. Turn the steering wheel 1/6 of a turn to the right or left from the straight up position.

To unlock steering wheel

Push the ignition switch, and the steering wheel will be automatically unlocked.



CAUTION:

- If the battery of the vehicle is discharged, the push-button ignition switch cannot be switched from the “LOCK” position.
- If the ignition switch position does not change from the “LOCK” position, push the ignition switch again while rotating the steering wheel slightly to the right and left.

IGNITION SWITCH POSITIONS

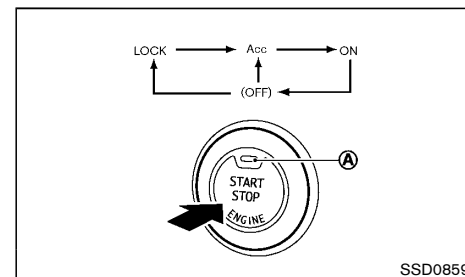

When the ignition switch is pushed without depressing the brake pedal (Automatic Transmission/Continuously Variable Transmission model) or the clutch pedal (Manual Transmission model), the ignition switch position will change as follows:

- Push once to change to “ACC”.
- Push two times to change to “ON”.
- Push three times to change to “OFF”.

- Push four times to return to “ACC”.
- Open or close any door to return to “LOCK” when in the “OFF” position.

The indicator light  on the ignition switch illuminates when the ignition switch is in the “ACC” or “ON” position.

LOCK position

The ignition switch and steering lock can only be locked at this position.

The ignition switch will be unlocked when it is pushed to the “ACC” position while carrying the Intelligent Key.

ACC position

The electrical accessory power activates at this position without the engine turned on.

ON position

The ignition system and the electrical accessory power activate at this position without the engine turned on.

OFF position

The engine is turned off with the steering wheel unlocked.

WARNING:

Never push the ignition switch to the “OFF” position while driving. The steering wheel may lock and cause the driver to lose control of the vehicle, resulting in serious vehicle damage or personal injury.

CAUTION:

Do not leave the vehicle for extended periods of time when the ignition switch is in the “ACC” or “ON” position and the engine is not running.

This can discharge the battery.

NOTE:

When the ignition switch is pushed while the Idling Stop System (if equipped) is activated, the ignition switch will be placed in the “OFF” position.

INTELLIGENT KEY BATTERY DISCHARGE

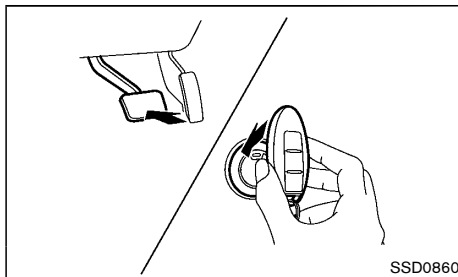

If the battery of the Intelligent Key is discharged, or environmental conditions interfere with the Intelligent Key operation, start the engine according to the following procedure:

1. **Automatic Transmission (AT)/Continuously Variable Transmission (CVT) model:**

Move the shift lever to the “P” (Park) or “N” (Neutral) position.

Manual Transmission (MT) model:

Move the shift lever to the “N” (Neutral) position.

2. Firmly depress the brake pedal (AT/CVT model) or the clutch pedal (MT model).
3. Touch the ignition switch with the Intelligent Key as illustrated. (A chime will sound.)

4. Push the ignition switch while depressing the brake pedal (AT/CVT model) or the clutch pedal (MT model) within 10 seconds after the chime sounds. The engine will start.

After step 3 is performed, when the ignition switch is pushed without depressing the brake pedal (AT/CVT model) or the clutch pedal (MT model), the ignition switch position will change to “ACC”.

NOTE:

- **When the ignition switch is pushed to the “ACC” or “ON” position or the engine is started by the above procedures, the Intelligent Key system warning light may blink in yellow (on the meter) even if the Intelligent Key is inside the vehicle. This is not a malfunction. To stop the warning light from blinking, touch the ignition switch with the Intelligent Key again.**
- **If the Intelligent Key system warning light in the meter is blinking in green, replace the battery as soon as possible. (See “Battery” (P.8-21).)**

STARTING ENGINE (model without Intelligent Key system)

GASOLINE ENGINE

1. Apply the parking brake.
2. Depress the foot brake pedal.
3. **Automatic Transmission (AT)/Continuously Variable Transmission (CVT) model:**

Move the shift lever to the "P" (Park) or "N" (Neutral) position.

The starter is designed to operate only when the shift lever is in the proper position.

Manual Transmission (MT) model:

Move the shift lever to the "N" (Neutral) position, and depress the clutch pedal to the floor while starting the engine.

The starter is designed to not operate unless the clutch pedal is depressed.

4. Crank the engine with your foot off the accelerator pedal by turning the ignition switch to the "START" position.
5. Immediately release the ignition switch when the engine starts. If the engine starts, but fails to run, repeat the above procedures.

If the engine is very hard to start in extremely cold or hot weather, depress the accelerator pedal and hold it to help start the engine.



CAUTION:

- **Do not operate the starter for more than 15 seconds at a time. If the engine does not start, turn the ignition switch off and wait 10 seconds before cranking the engine again. Otherwise, the starter could be damaged.**
- **If it becomes necessary to start the engine with a booster battery and jumper cables,**

the instructions and cautions contained in the "6. In case of emergency" section should be carefully followed.

6. Allow the engine to idle for at least 30 seconds after starting the engine to warm-up. Drive at moderate speeds for a short distance first, especially in cold weather.



CAUTION:

Do not leave the vehicle unattended while the engine is warming up.

DIESEL ENGINE

1. Apply the parking brake.
2. Depress the foot brake pedal.
3. Move the shift lever to the "N" (Neutral) position, and depress the clutch pedal to the floor while starting the engine.
4. Turn the ignition switch to the "ON" position and wait until the glow plug indicator light  turns off.
5. Crank the engine with your foot off the accelerator pedal by turning the ignition switch to the "START" position.
6. Immediately release the ignition switch when the engine starts. If the engine starts, but fails to run, repeat the above procedures.



CAUTION:

- **Do not operate the starter for more than 20 seconds at a time. If the engine does not start, turn the ignition switch off and wait 20 seconds before cranking the engine again. Otherwise, the starter could be damaged.**

- **If it becomes necessary to start the engine with a booster battery and jumper cables, the instructions and cautions contained in the "6. In case of emergency" section should be carefully followed.**

7. Allow the engine to idle for at least 30 seconds after starting the engine to warm-up. Drive at moderate speeds for a short distance first, especially in cold weather.



CAUTION:

Do not leave the vehicle unattended while the engine is warming up.

STARTING ENGINE (model with Intelligent Key system)

GASOLINE ENGINE

1. Apply the parking brake.
2. **Automatic Transmission (AT)/Continuously Variable Transmission (CVT) model:**

Move the shift lever to the “P” (Park) or the “N” (Neutral) position.

The starter is designed to operate only when the shift lever is in the proper position.

Manual Transmission (MT) model:

Move the shift lever to the “N” (Neutral) position.

The starter is designed to not operate unless the clutch pedal is fully depressed.

The Intelligent Key must be carried when operating the ignition switch.

3. Push the ignition switch to the “ON” position. Depress the brake pedal (AT/CVT model) or the clutch pedal (MT model) and push the ignition switch to start the engine.

To start the engine immediately, push and release the ignition switch while depressing the brake pedal or clutch pedal with the ignition switch in any position.

4. Immediately release the ignition switch when the engine starts. If the engine starts, but fails to run, repeat the above procedures.

If the engine is very hard to start in extremely cold or hot weather, depress the accelerator pedal and hold it. Push the ignition switch for up to 15 seconds while holding. Release the accelerator pedal when the engine starts.



CAUTION:

- **As soon as the engine has started, release the ignition switch immediately.**
 - **Do not operate the starter for more than 15 seconds at a time. If the engine does not start, push the ignition switch to the “OFF” position and wait 10 seconds before cranking the engine again. Otherwise, the starter could be damaged.**
 - **If it becomes necessary to start the engine with a booster battery and jumper cables, the instructions and cautions contained in the “6. In case of emergency” section should be carefully followed.**
5. Allow the engine to idle for at least 30 seconds after starting the engine to warm-up. Drive at moderate speeds for a short distance first, especially in cold weather.



CAUTION:

Do not leave the vehicle unattended while the engine is warming up.

6. To stop the engine, move the shift lever to the “P” (Park) position (AT/CVT model) or move the shift lever to the “N” (Neutral) position (MT model), apply the parking brake and push the ignition switch to the “OFF” position.

DIESEL ENGINE

1. Apply the parking brake.
2. Move the shift lever to the “N” (Neutral) position.

The starter is designed to not operate unless the clutch pedal is fully depressed.

The Intelligent Key must be carried when operating the ignition switch.

3. Push the ignition switch to the “ON” position and wait until the glow plug indicator light  turns off. Depress the clutch pedal and push the ignition switch to start the engine.

To start the engine immediately, push and release the ignition switch while depressing the clutch pedal with the ignition switch in any position.

4. Immediately release the ignition switch when the engine starts. If the engine starts, but fails to run, repeat the above procedures.

If the engine is very hard to start in extremely cold or hot weather, depress the accelerator pedal and hold it. Push the ignition switch for up to 15 seconds while holding. Release the accelerator pedal when the engine starts.



CAUTION:

- **As soon as the engine has started, release the ignition switch immediately.**
- **Do not operate the starter for more than 20 seconds at a time. If the engine does not start, push the ignition switch to the “OFF” position and wait 20 seconds before cranking the engine again. Otherwise, the starter could be damaged.**

DRIVING VEHICLE

- If it becomes necessary to start the engine with a booster battery and jumper cables, the instructions and cautions contained in the “6. In case of emergency” section should be carefully followed.
5. Allow the engine to idle for at least 30 seconds after starting the engine to warm-up. Drive at moderate speeds for a short distance first, especially in cold weather.



CAUTION:

Do not leave the vehicle unattended while the engine is warming up.

6. To stop the engine, move the shift lever to the “N” (Neutral) position, apply the parking brake and push the ignition switch to the “OFF” position.

DRIVING WITH AUTOMATIC TRANSMISSION (AT)

The Automatic Transmission (AT) in your vehicle is electronically controlled to produce maximum power and smooth operation.

The recommended operating procedures for this transmission are shown on the following pages. Follow these procedures for maximum vehicle performance and driving enjoyment.



WARNING:

Do not downshift abruptly on slippery roads. This may cause a loss of control.



CAUTION:

- The cold engine idle speed is high, so use caution when shifting the transmission into a forward or reverse position before the engine has warmed up.
- Avoid revving up the engine while the vehicle is stopped. This could cause unexpected vehicle movement.
- Never shift to either the “P” (Park) or “R” (Reverse) position while the vehicle is moving. This could cause serious damage to the transmission.
- Except in an emergency, do not shift to the “N” (Neutral) position while driving. Coasting with the transmission in the “N” (Neutral) position may cause serious damage to the transmission.
- Start the engine in either the “P” (Park) or “N” (Neutral) position. The engine will not start in any other position. If it does, have

your vehicle checked by a NISSAN dealer.

- Shift into the “P” (Park) position and apply the parking brake when at a standstill for longer than a short waiting period.
- Keep the engine at idling speed while shifting from the “N” (Neutral) position to any driving position.
- When stopping the vehicle on an uphill grade, do not hold the vehicle by depressing the accelerator pedal. The foot brake pedal should be depressed in this situation.

Starting vehicle

1. After starting the engine, fully depress the foot brake pedal before shifting the shift lever out of the “P” (Park) position.
2. Keep the foot brake pedal depressed and move the shift lever to a driving position.
3. Release the parking brake, the foot brake pedal, and then gradually start the vehicle in motion.

The AT is designed so the foot brake pedal MUST be depressed before shifting from the “P” (Park) position to any driving position while the ignition switch is in the “ON” position.

The shift lever cannot be moved out of the “P” (Park) position and into any of the other gear positions if the ignition switch is placed in the “LOCK”, “OFF” or “ACC” position or if the key is removed.



CAUTION:

- **DEPRESS THE FOOT BRAKE PEDAL** - Shifting the shift lever to “D”, “R”, “2” or “1” without depressing the foot brake pedal causes the vehicle to move slowly when

the engine is running. Make sure the foot brake pedal is depressed fully and the vehicle is stopped before shifting the shift lever.

- **MAKE SURE OF THE SHIFT LEVER POSITION** - Make sure the shift lever is in the desired position. “D”, “2” and “1” are used to move forward and “R” to back up.
- **WARM UP THE ENGINE** - Due to the higher idle speeds when the engine is cold, extra caution must be exercised when shifting the shift lever into the driving position immediately after starting the engine.

Shifting gear

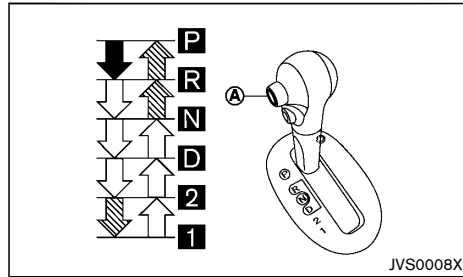

Left-Hand Drive (LHD) model

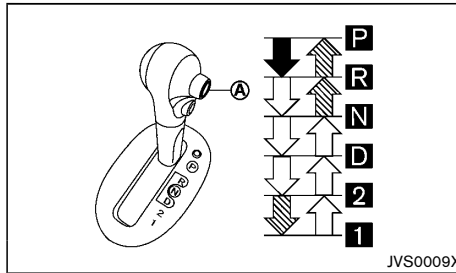

Right-Hand Drive (RHD) model

- ➔: Push the button (A) while depressing the foot brake pedal.
- ➔: Push the button (A) .
- ➔: Just move the shift lever.



WARNING:

- **Apply the parking brake if the shift lever is in any position while the engine is not running. Failure to do so could cause the vehicle to move unexpectedly or roll away and result in serious personal injury or property damage.**
- **If the shift lever cannot be moved from the “P” (Park) position while the engine is running and the foot brake pedal is depressed, the stop lights may not work. Malfunctioning stop lights could cause an accident injuring yourself and others.**

After starting the engine, fully depress the foot brake pedal, push the shift lever button and move the shift lever out of the “P” (Park) position.

If the ignition switch is the “OFF” or “ACC” position for any reason while the shift lever is in any positions other than the “P” (Park) position, the ignition switch cannot

be placed in the “LOCK” position.

If the ignition switch cannot be placed in the “LOCK” position, perform the following steps:

1. Apply the parking brake.
2. Placed the ignition switch in the ON position while depressing the foot brake pedal.
3. Move the shift lever to the “P” (Park) position.
4. Place the ignition switch in the “LOCK” position.

P (Park):

Use this position when the vehicle is parked or when starting the engine. **Make sure that the vehicle is completely stopped and move the shift lever into the “P” (Park) position.** Apply the parking brake. When parking on a hill, first depress the foot brake pedal, apply the parking brake, and then move the shift lever into the “P” (Park) position.

R (Reverse):

Use this position to back up. Make sure that the vehicle is completely stopped before selecting the “R” (Reverse) position.

N (Neutral):

Neither the forward nor reverse gear is engaged. The engine can be started in this position. You may shift to the “N” (Neutral) position and restart a stalled engine while the vehicle is moving.

D (Drive):

Use this position for all normal forward driving.

2 (Second gear):

Use this position for climbing hills or engine braking on downhill grades.

1 (Low gear):

Use this position when climbing steep hills slowly or driving slowly through deep snow, or for maximum engine braking on steep downhill grades.

Do not shift into the gears when the vehicle speed exceeds the following limits, otherwise the engine may over-rev and cause engine damage.

Shift lever position	
1	2
55 km/h (34 MPH)	100 km/h (62 MPH)

Overdrive switch

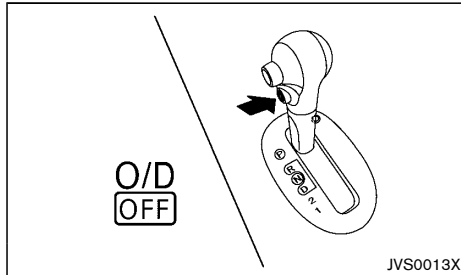

Left-Hand Drive (LHD) model

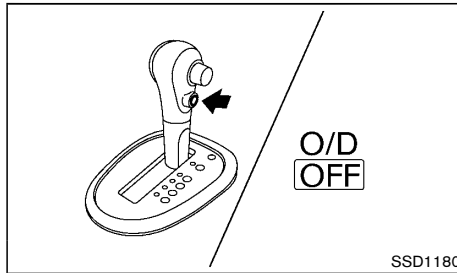

Right-Hand Drive (RHD) model

Each time the engine is started, the overdrive function is automatically reset to "ON".

"ON" position:

With the engine running and the shift lever in the "D" (Drive) position, the transmission upshifts into the overdrive as vehicle speed increases.

Overdrive does not engage until the engine has reached operating temperature.

"OFF" position:

For driving up and down long slopes where engine braking is necessary, push the overdrive switch. The overdrive off indicator light  in the meter panel illuminates.

When cruising at a low speed or climbing a gentle slope, you may feel uncomfortable shift shocks as the transmission shifts into and out of the overdrive repeatedly. In this case, push the overdrive switch to turn the overdrive "OFF".

When driving conditions change, push the overdrive switch to turn the overdrive "ON". The overdrive off indicator light will turn off.

Remember not to drive at high speeds for extended periods of time with the overdrive "OFF". This reduces

fuel economy.

Accelerator downshift - in D (Drive) position -

For passing or climbing hills, depress the accelerator pedal to the floor. This shifts the transmission down into a lower gear, depending on the vehicle speed.

Shift lock release

If the battery is discharged, the shift lever may not be moved from the "P" (Park) position even with the foot brake pedal depressed.

To move the shift lever, release the shift lock. The shift lever can be moved to the "N" (Neutral) position. However, the steering wheel will be locked unless the ignition switch is placed in the "ON" position. This allows the vehicle to be moved if the battery is discharged.

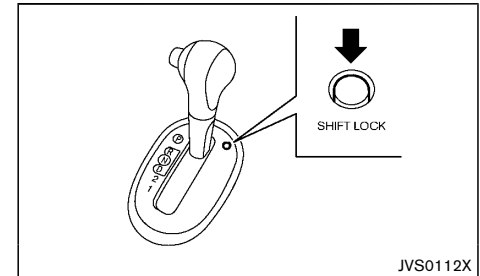

Left-Hand Drive (LHD) mode

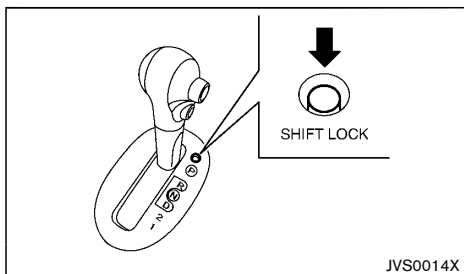

Right-Hand Drive (RHD) model

To release the shift lock, perform the following procedure

1. Models with Intelligent KEY system: Place the ignition switch in the "OFF" or "LOCK" position.
Models without Intelligent KEY system: Place the ignition switch in the "LOCK" position and remove the key if it is inserted.
2. Apply the parking brake.
3. Depress the shift lock release button.
4. Push and hold the shift lever button and move the shift lever to the "N" (Neutral) position while holding down the shift lock release.
5. Place the ignition switch in the "ON" position to release the steering wheel lock.

The vehicle may be moved, by pushing, to the desired location.

If the shift lever cannot be moved out of the "P" (Park) position, have a NISSAN dealer check the AT system as soon as possible.

Fail-safe

When the fail-safe operation occurs, the AT will be locked in third gear.

If the vehicle is driven under extreme conditions, such as excessive wheel spinning and subsequent hard braking, the fail-safe system may be activated. This will occur even if all electrical circuits are functioning properly. In this case, place the ignition switch in the "OFF" position and wait for 3 seconds. Then turn the ignition switch back to the "ON" position. The vehicle should return to its normal operating condition. If it does not return to its normal operating condition, have a NISSAN dealer check the transmission and repair it if necessary.

DRIVING WITH CONTINUOUSLY VARIABLE TRANSMISSION (CVT)

The Continuously Variable Transmission (CVT) in your vehicle is electronically controlled to produce maximum power and smooth operation.

The recommended operating procedures for this transmission are shown on the following pages. Follow these procedures for maximum vehicle performance and driving enjoyment.



WARNING:

Do not downshift abruptly on slippery roads. This may cause a loss of control.



CAUTION:

- **The cold engine idle speed is high, so use caution when shifting the transmission into a forward or reverse position before the engine has warmed up.**

- **Avoid revving up the engine while the vehicle is stopped. This could cause unexpected vehicle movement.**
- **Never shift to either the "P" (Park) or "R" (Reverse) position while the vehicle is moving. This could cause serious damage to the transmission.**
- **Except in an emergency, do not shift to the "N" (Neutral) position while driving. Coasting with the transmission in the "N" (Neutral) position may cause serious damage to the transmission.**
- **Start the engine in either the "P" (Park) or "N" (Neutral) position. The engine will not start in any other position. If it does, have your vehicle checked by a NISSAN dealer.**
- **Shift into the "P" (Park) position and apply the parking brake when at a standstill for longer than a short waiting period.**
- **Keep the engine at idling speed while shifting from the "N" (Neutral) position to any driving position.**
- **When stopping the vehicle on an uphill grade, do not hold the vehicle by depressing the accelerator pedal. The foot brake pedal should be depressed in this situation.**

Starting vehicle

1. After starting the engine, fully depress the foot brake pedal before moving the shift lever out of the "P" (Park) position.
2. Keep the foot brake pedal depressed and move the shift lever to a driving position.
3. Release the parking brake, the foot brake pedal, and then gradually start the vehicle in motion.

The CVT is designed so the foot brake pedal **MUST** be depressed before shifting from the "P" (Park) position to any driving position while the ignition switch is in the "ON" position.

The shift lever cannot be moved out of the "P" (Park) position and into any of the other positions if the ignition switch is placed in the "LOCK", "OFF" or "ACC" position or if the key is removed.

CAUTION:

- **DEPRESS THE FOOT BRAKE PEDAL** - Shifting the shift lever to "D", "R" or "L" without depressing the foot brake pedal causes the vehicle to move slowly when the engine is running. Make sure the foot brake pedal is depressed fully and the vehicle is stopped before shifting the shift lever.
- **MAKE SURE OF THE SHIFT LEVER POSITION** - Make sure the shift lever is in the desired position. "D" and "L" are used to move forward and "R" to back up.
- **WARM UP THE ENGINE** - Due to the higher idle speeds when the engine is cold, extra caution must be exercised when shifting the shift lever into the driving position immediately after starting the engine.

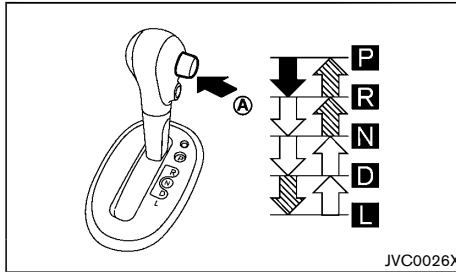

- ➔: Push the button (A) while depressing the foot brake pedal.
- ▨: Push the button (A) .
- ➔: Just move the shift lever.

Shifting

WARNING:

- **Apply the parking brake if the shift lever is in any position while the engine is not running. Failure to do so could cause the vehicle to move unexpectedly or roll away and result in serious personal injury or property damage.**
- **If the shift lever cannot be moved from the "P" (Park) position while the engine is running and the foot brake pedal is depressed, the stop lights may not work. Malfunctioning stop lights could cause an accident injuring yourself and others.**

After starting the engine, fully depress the foot brake pedal, push the shift lever button and move the shift lever out of the "P" (Park) position.

If the ignition switch is placed in the "OFF" or "ACC" position for any reason while the shift lever is in any

positions other than the "P" (Park) position, the ignition switch cannot be placed in the "LOCK" position.

If the ignition switch cannot be placed in the "LOCK" position, perform the following steps:

1. Apply the parking brake.
2. Place the ignition switch in the "ON" position while depressing the foot brake pedal.
3. Move the shift lever to the "P" (Park) position.
4. **Models with Intelligent Key system:**

Place the ignition switch in the "OFF" position.

Models without Intelligent Key system:

Place the ignition switch in the "LOCK" position.

P (Park):

Use this position when the vehicle is parked or when starting the engine. **Make sure that the vehicle is completely stopped and move the shift lever into the "P" (Park) position.** Apply the parking brake. When parking on a hill, first depress the foot brake pedal, apply the parking brake, and then move the shift lever into the "P" (Park) position.

R (Reverse):

Use this position to back up. Make sure that the vehicle is completely stopped before selecting the "R" (Reverse) position.

N (Neutral):

Neither the forward nor reverse gear is engaged. The engine can be started in this position. You may shift to the "N" (Neutral) position and restart a stalled engine while the vehicle is moving.

D (Drive):

Use this position for all normal forward driving.

L (Low):

Use this position when climbing steep hills slowly or driving slowly through deep snow, sand or mud, or for maximum engine braking on steep downhill grades.

SPORT mode switch

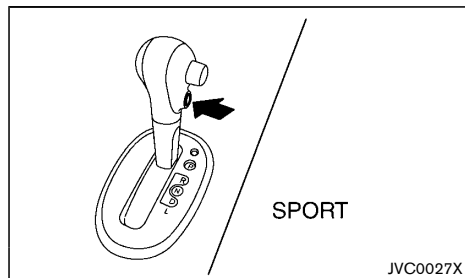

To select the SPORT mode, push the SPORT mode switch with the shift lever in the "D" (Drive) position. The SPORT mode indicator light **SPORT** in the meter panel illuminates. To turn off the SPORT mode, push the SPORT mode switch again. The SPORT mode indicator light will turn off. When the shift lever is shifted to any position other than "D", the SPORT mode will be automatically turned off.

"OFF" position:

For normal driving and fuel economy, use the "OFF" position.

"ON" position:

For driving up or down long slopes where engine braking is necessary, or for powerful acceleration, use the "ON" position. The transmission will automatically select a different gear ratio, allowing the engine to provide high output.

When driving conditions change, push the switch to turn the SPORT mode off.

Remember not to drive at high speeds for extended periods of time with the SPORT mode in the "ON" position. This reduces fuel economy.

Accelerator downshift - in D (Drive) position -

For passing or climbing hills, depress the accelerator pedal to the floor. This shifts the transmission down into a lower gear, depending on the vehicle speed.

Shift lock release

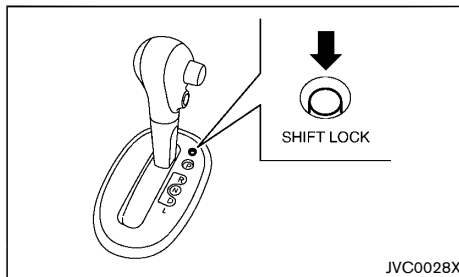

If the battery charge is low or discharged, the shift lever may not be moved from the "P" (Park) position even with the brake pedal depressed and the shift lever button pushed.

To move the shift lever, perform the following procedure:

1. Model with Intelligent Key system:

Place the ignition switch in the "OFF" or "LOCK" position.

Model without Intelligent Key system:

Place the ignition switch in the "LOCK" position, and remove the key if it is inserted.

1. Apply the parking brake.
2. Depress the shift lock release button.
3. Push the shift lever button and move the shift lever to the "N" (Neutral) position while holding down the shift lock release.

Place the ignition switch in the "ON" position to unlock the steering wheel. The vehicle may be moved to the desired location.

Replace the removed shift lock release cover after the operation.

For model with Intelligent Key system: If the battery is discharged completely, the steering wheel cannot be unlocked. Do not move the vehicle with the steering wheel locked.

If the shift lever cannot be moved out of the "P" (Park) position, have a NISSAN dealer check the CVT system as soon as possible.



WARNING:

If the shift lever cannot be moved from the "P" (Park) position while the engine is running and the brake pedal is depressed, the stop lights may not work. Malfunctioning stop lights could cause an accident injuring yourself and others.

High fluid temperature protection mode

This transmission has a high fluid temperature protection mode. If the fluid temperature becomes too high (for example, when climbing steep grades in high temperature with heavy loads), engine power and, under some conditions, vehicle speed will be decreased automatically to reduce the chance of transmission damage. Vehicle speed can be controlled with the accelerator pedal, but engine and vehicle speed may be limited.

Fail-safe

When the fail-safe operation occurs, the CVT will not be shifted to the selected driving position.

If the vehicle is driven under extreme conditions, such as excessive wheel spinning and subsequent hard braking, the fail-safe system may be activated. This will occur even if all electrical circuits are functioning properly. In this case, place the ignition switch in the "OFF" position and wait for 10 seconds. Then turn the ignition switch back to the "ON" position. The vehicle should return to its normal operating condition. If it does not return to its normal operating condition, have a NISSAN dealer check the transmission and repair it if necessary.



WARNING:

When the fail-safe operation occurs, vehicle speed may be gradually reduced. The reduced speed may be lower than other traffic, which could increase the chance of a collision. Be especially careful when driving. If necessary, pull to the side of the road at a safe place and allow the transmission to return to normal operation, or have it repaired if necessary.

DRIVING WITH MANUAL TRANSMISSION (MT)



WARNING:

- **Do not downshift abruptly on slippery roads. This may cause a loss of vehicle control.**
- **Do not over-rev the engine when shifting to a lower gear. This may cause a loss of vehicle control or engine damage.**



CAUTION:

- **Do not rest your foot on the clutch pedal while driving. This may damage the clutch system.**
- **Fully depress the clutch pedal before shifting to help prevent transmission damage.**
- **Stop the vehicle completely before shifting into the "R" (Reverse) position.**
- **When the vehicle is stopped for a period of time, for example waiting at stoplights, shift to the "N" (Neutral) position and release the clutch pedal with the foot brake pedal depressed.**
- **Do not shift to the "N" (Neutral) position while driving. Doing so may result in an accident due to loss of engine braking.**

Starting vehicle

1. After starting the engine, depress the clutch pedal to the floor and move the shift lever to the "1" (1st) or "R" (Reverse) position.
2. Slowly depress the accelerator pedal, releasing the clutch pedal and parking brake at the same time.

Shifting gear

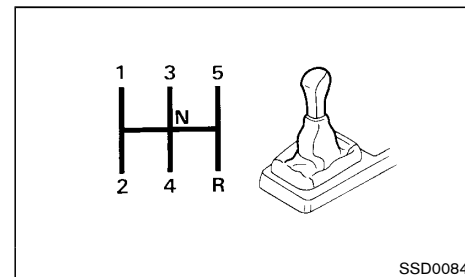

To change gears, or when upshifting or downshifting, fully depress the clutch pedal, shift into the appropriate gear, then slowly and smoothly release the clutch pedal.

To ensure smooth gear changes, fully depress the clutch pedal before operating the shift lever. If the clutch pedal is not fully depressed before the transmission is shifted, a gear noise may be heard. Transmission damage could occur.

Start the vehicle in the "1" (1st) position and shift to the "2" (2nd), "3" (3rd), "4" (4th) and "5" (5th) gear in sequence according to the vehicle speed.

You cannot shift directly from the "5" (5th) position into the "R" (Reverse) position. First shift into the "N" (Neutral) position, then shift into the "R" (Reverse)

position.

If it is difficult to move the shift lever into the “R” (Reverse) or “1” (1st) position, shift to the “N” (Neutral) position, and then release the clutch pedal once. Fully depress the clutch pedal again and shift into “R” or “1”.

Suggested maximum speed in each gear

Downshift to a lower gear if the engine is not running smoothly, or if you need to accelerate.

Do not exceed the maximum suggested speed (shown below) in any gear. For level road driving, use the highest gear suggested for that speed. Always observe posted speed limits, and drive according to the road conditions which will ensure safe operation. Do not over-rev the engine when shifting to a lower gear as it may cause engine damage or loss of vehicle control.

HR12DE engine model:

	km/h (MPH)
1st	45 (28)
2nd	82 (51)
3rd	120 (75)
4th	163 (101)
5th	— (—)

HR15DE engine model, 185/70 R14 tire:

	km/h (MPH)
1st	46 (29)
2nd	84 (52)
3rd	124 (77)
4th	167 (104)
5th	— (—)

HR15DE engine model, 185/65 R15 tire:

	km/h (MPH)
1st	46 (29)
2nd	83 (52)
3rd	122 (76)
4th	166 (103)
5th	— (—)

HR15DE engine model, 175/70 R14 tire (except for Thailand, Indonesia, Singapore, Brunei, Mauritius, Lebanon and Jordan):

	km/h (MPH)
1st	43 (27)
2nd	79 (49)
3rd	116 (72)
4th	157 (98)
5th	— (—)

HR15DE engine model, 175/70 R14 tire (for Thailand, Indonesia, Singapore, Brunei and Mauritius):

	km/h (MPH)
1st	45 (28)
2nd	82(51)
3rd	120 (75)
4th	163 (101)
5th	— (—)

HR15DE engine model, 175/70 R14 tire (for Lebanon and Jordan):

	km/h (MPH)
1st	41 (25)
2nd	74 (46)
3rd	109 (68)
4th	147 (91)
5th	— (—)

K9K engine model, 185/70 R14 tire:

	km/h (MPH)
1st	37 (23)
2nd	66 (41)
3rd	103 (64)
4th	140 (87)
5th	— (—)

K9K engine model, 185/65 R15 tire:

	km/h (MPH)
1st	36 (22)
2nd	66 (41)
3rd	102 (63)
4th	139 (86)
5th	— (—)

IDLING STOP SYSTEM (if equipped for Thailand)

The Idling Stop System activates to prevent unnecessary fuel consumption, exhaust emissions and noise.

- When you stop the vehicle, the engine is turned off automatically.
- When you start the vehicle again, the engine is turned on automatically.



CAUTION:

When the vehicle is moved (at approximately 2 km/h or more) while the engine is stopped by the system, such as on a downhill grade, the engine restarts automatically. To avoid an accident, be sure to depress the brake pedal.

NOTE:

The Idling Stop System will not activate under the following conditions:

- when the engine is kept idling without any driving after the engine is turned on.
- when the engine coolant temperature is low.
- when the battery capacity is low.
- when the battery temperature is low or extremely high.
- when the vehicle is moved.
- when a negative pressure booster decreases.
- when the engine hood is opened with the engine running.
- when the engine is turned on with the engine hood open.
- when the steering wheel is operated.
- when the Idling Stop System indicator blinks at a low speed.
- when the accelerator pedal is depressed.

- when the shift lever is in the “R” (Reverse) position.
- when the Idling Stop OFF switch is turned on.
- when the electric power steering warning light, the Anti-lock Braking System (ABS) warning light (if equipped) illuminate.
- when the brake pedal is not depressed.
- when stopping the vehicle on sloping roads.
- when the power consumption is large.

NOTE:

It may take some time until the Idling Stop System activates under the following conditions:

- when the battery is discharged.
- when the outside temperature is low.
- when the battery is replaced or the battery terminal is disconnected for extended periods and then reconnected.

NOTE:

The engine will restart without releasing the brake pedal while the Idling Stop System is activated under the following conditions:

- when the Idling Stop OFF switch is pushed.
- when the accelerator pedal is depressed.
- when the steering wheel is operated.
- when the battery capacity is low.
- when the power consumption is large.
- when the brake pedal is released on sloping roads and the vehicle is moved.
- when the shift lever is placed in the “L” (Low), “D” (Drive) or “R” (Reverse) position from the “N” or “P” position.
- when the negative pressure of the brake system is not sufficiently applied by depressing the brake

pedal several times.

Use this system while waiting at stoplight, etc. When the vehicle is stopped for long periods of time, turn off the engine.

When the engine hood is opened with the Idling Stop System on, the engine will be in the normal stopped state with the buzzer sounding. In this case, restart the engine with the ignition switch.

When the driver's door is opened with the Idling Stop System on, the Idling Stop System continues to be activated although the buzzer sounds and the Idling Stop System indicator light blinks.

When the engine is stopped by the Idling Stop System, heating, cooling and dehumidifying functions will be deactivated. To avoid the air conditioning functions from being deactivated, turn off the Idling Stop mode by pressing the Idling Stop OFF switch.

OPERATING IDLING STOP SYSTEM

NOTE:

- **The engine stops automatically when the brake pedal is depressed with the shift lever in the “D” (Drive) position.**
- **When the brake pedal is released, the engine restarts automatically.**
- **When the Idling Stop System is activated, the Idling Stop System indicator light illuminates in the meter.**
- **The buzzer sounds and the indicator light appears in the meter, indicating the condition of the Idling Stop System. For more details, see “Idling Stop System indicator light (if equipped for Thailand)” (P.2-15) or “Idling Stop System reminder buzzer (if equipped for Thailand)” (P.2-17).**

IDLING STOP OFF SWITCH

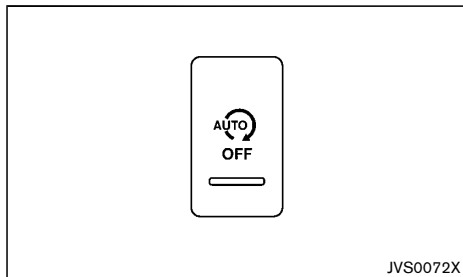

The system can be temporarily deactivated by pressing the Idling Stop System OFF switch. Pressing the switch a second time or restarting the engine by using the ignition switch will reactivate the Idling Stop System.

- When the Idling Stop System is deactivated while the engine is running, the engine is prevented from automatically stopping.
- When the Idling Stop System is deactivated after the engine has been automatically stopped by the Idling Stop System, the engine will immediately restart if suitable conditions are present. The engine will then be prevented from automatically stopping during the same journey.
- Whenever the Idling Stop System is deactivated the indicator light on the Idling Stop System OFF switch illuminates. In this condition the Idling Stop System cannot prevent unnecessary fuel consumption, exhaust emissions, or noise during your journey.

IDLING STOP SYSTEM (for Hong Kong)

The Idling Stop System activates to prevent unnecessary fuel consumption, exhaust emissions and noise.

- When you stop the vehicle, the engine is turned off automatically.
- When you start the vehicle again, the engine is turned on automatically.



CAUTION:

When the vehicle is moved (at approximately 2 km/h or more) while the engine is stopped by the system, such as on a downhill grade, the engine restarts automatically. To avoid an accident, be sure to depress the brake pedal.

NOTE:

The Idling Stop System will not activate under the following conditions:

- when the engine is kept idling without any driving after the engine is turned on.
- when the engine coolant temperature is low.
- when the battery capacity is low.
- when the battery temperature is low or extremely high.
- when the vehicle is moved.
- when a negative pressure booster decreases.
- when the engine hood is opened with the engine running.
- when the engine is turned on with the engine hood open.
- when the driver's seat belt is not fastened.
- when the driver's door is open.
- when the steering wheel is operated.
- when the Idling Stop System indicator blinks at a low speed.

- when the accelerator pedal is depressed.
- when the shift lever is in the "R" (Reverse) position.
- when the fan speed control dial is in any position other than "OFF" (0) while the air flow control dial is in the front defogger position (manual air conditioner).
- when the front defogger switch is on (automatic air conditioner).
- when the rear defogger switch is on.
- when the Idling Stop OFF switch is turned on.
- when the electric power steering warning light, the Anti-lock Braking System (ABS) warning light or the Vehicle Dynamic Control (VDC) warning light (if equipped) illuminate.
- when the brake pedal is not fully depressed.
- when stopping the vehicle on sloping roads.
- when the power consumption is large.
- when the vehicle is traveling at altitudes higher than 2,000 m (6,562 ft).

NOTE:

It may take some time until the Idling Stop System activates under the following conditions:

- when the battery is discharged.
- when the outside temperature is low.
- when the battery is replaced or the battery terminal is disconnected for extended periods and then reconnected.

NOTE:

The engine will not restart even if the brake pedal is released while the Idling Stop System is activated under the following condition:

- when the shift lever is in the “P” (Parking) position.

NOTE:

The engine will restart without releasing the brake pedal while the Idling Stop System is activated under the following conditions:

- when the Idling Stop OFF switch is pushed.
- when the accelerator pedal is depressed.
- when the steering wheel is operated.
- when the battery capacity is low.
- when the power consumption is large.
- when the brake pedal is released on sloping roads and the vehicle is moved.
- when the force to the brake pedal is reduced while the shift lever is in the “D” (Drive) or “N” (Neutral) position.
- when the shift lever is placed in the “L” (Low), “D” (Drive) or “R” (Reverse) position from the “N” or “P” position.
- when the negative pressure of the brake system is not sufficiently applied by depressing the brake pedal several times.
- when the fan speed control dial is in any position other than “OFF” (0) while the air flow control dial is in the front defogger position (manual air conditioner).
- when the front defogger switch is set to “ON” (automatic air conditioner).
- when the rear defogger switch is set to “ON”.
- when the driver’s seat belt is released or the driver’s door is open.

Use this system while waiting at stoplight, etc. When the vehicle is stopped for long periods of time, turn off the engine.

When the engine hood is opened with the Idling Stop

System on, the engine will be in the normal stopped state with the buzzer sounding. In this case, restart the engine with the ignition switch.

When the engine is stopped by the Idling Stop System, heating, cooling and dehumidifying functions will be deactivated. To avoid the air conditioning functions from being deactivated, turn off the Idling Stop mode by pressing the Idling Stop OFF switch.

OPERATING IDLING STOP SYSTEM

The Idling Stop System indicator light illuminates in the meter while driving if any of the Idling Stop System conditions are met.

- When the brake pedal is depressed to stop the vehicle with the shift lever in the “D” (Drive) position, the engine will stop automatically.
- When you release your foot from the brake pedal, the engine will start automatically.

NOTE:

The Idling Stop System indicator light and a buzzer will inform you of the Idling Stop System status. For more details, see “Idling Stop System indicator light (for Hong Kong)” (P.2-15) or “Idling Stop System reminder buzzer (for Hong Kong)” (P.2-17).

IDLING STOP OFF SWITCH

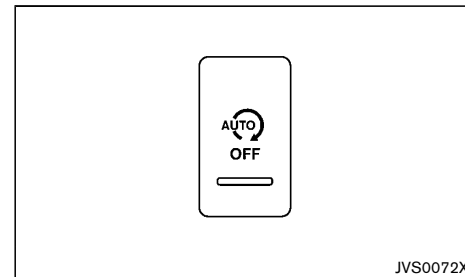





The system can be temporarily deactivated by pressing the Idling Stop System OFF switch. Pressing the switch a second time or restarting the engine by using the ignition switch will reactivate the Idling Stop System.

- When the Idling Stop System is deactivated while the engine is running, the engine is prevented from automatically stopping.
- When the Idling Stop System is deactivated after the engine has been automatically stopped by the Idling Stop System, the engine will immediately restart if suitable conditions are present. The engine will then be prevented from automatically stopping during the same journey.
- Whenever the Idling Stop System is deactivated the indicator light on the Idling Stop System OFF switch illuminates. In this condition the Idling Stop System cannot prevent unnecessary fuel consumption, exhaust emissions, or noise during your journey.

VEHICLE DYNAMIC CONTROL (VDC) SYSTEM (if equipped)



WARNING:

- The Vehicle Dynamic Control (VDC) system is designed to help the driver maintain stability but does not prevent accidents due to abrupt steering operation at high speeds or by careless or dangerous driving techniques. Reduce vehicle speed and be especially careful when driving and cornering on slippery surfaces and always drive carefully.
- Do not modify the vehicle's suspension. If suspension parts such as shock absorbers, struts, springs, stabilizer bars, bushings and wheels are not NISSAN recommended for your vehicle or are extremely deteriorated, the VDC system may not operate properly. This could adversely affect vehicle handling performance, and the VDC warning light  may illuminate.
- If brake related parts such as brake pads, rotors and calipers are not NISSAN recommended or are extremely deteriorated, the VDC system may not operate properly and the VDC warning light  may illuminate.
- If engine control related parts are not NISSAN recommended or are extremely deteriorated, the VDC warning light  may illuminate.
- When driving on extremely inclined surfaces such as higher banked corners, the VDC system may not operate properly and the VDC warning light  may illuminate. Do not drive on these types of roads.
- When driving on an unstable surface such as a turntable, ferry, elevator or ramp, the VDC

warning light  may illuminate. This is not a malfunction. Restart the engine after driving onto a stable surface.

- If wheels or tires other than the NISSAN recommended ones are used, the VDC system may not operate properly and the VDC warning light  may illuminate.
- The VDC system is not a substitute for winter tires or tire chains on a snow covered road.

The Vehicle Dynamic Control (VDC) system uses various sensors to monitor driver inputs and vehicle motion. Under certain driving conditions, the VDC system helps to perform the following functions.

- Controls brake pressure to reduce wheel slip on one slipping drive wheel so power is transferred to a non slipping drive wheel on the same axle.
- Controls brake pressure and engine output to reduce drive wheel slip based on vehicle speed (traction control function).
- Controls brake pressure at individual wheels and engine output to help the driver maintain control of the vehicle in the following conditions:
 - understeer (vehicle tends to not follow the steered path despite increased steering input)
 - oversteer (vehicle tends to spin due to certain road or driving conditions).



The VDC system can help the driver to maintain control of the vehicle, but it cannot prevent loss of vehicle control in all driving situations.

When the VDC system operates, the VDC warning light  in the instrument panel flashes so note the following:

- The road may be slippery or the system may determine some action is required to help the vehicle on the steered path.

- You may feel a pulsation in the brake pedal and hear a noise or vibration from under the hood. This is normal and indicates that the VDC system is working properly.
- Adjust your speed and driving to the road conditions.

If a malfunction occurs in the system, the VDC warning light  illuminates in the instrument panel. The VDC system automatically turns off.

The VDC OFF switch is used to turn off the VDC system. The VDC off indicator light  illuminates to indicate the VDC system is off. When the VDC OFF switch is used to turn off the system, the VDC system still operates to prevent one drive wheel from slipping by transferring power to a non slipping drive wheel. The VDC warning light  flashes if this occurs. All other VDC functions are off and the VDC warning light  will not flash. The VDC system is automatically reset to on when the ignition switch is placed in the "OFF" position then back to the "ON" position.

See "Vehicle Dynamic Control (VDC) warning light" (P.2-14) and "Vehicle Dynamic Control (VDC) off indicator light" (P.2-16)

The computer has a built-in diagnostic feature that tests the system each time you start the engine and move the vehicle forward or in reverse at a slow speed. When the self-test occurs, you may hear a "clunk" noise and/or feel a pulsation in the brake pedal. This is normal and is not an indication of a malfunction.

VEHICLE DYNAMIC CONTROL (VDC) OFF SWITCH

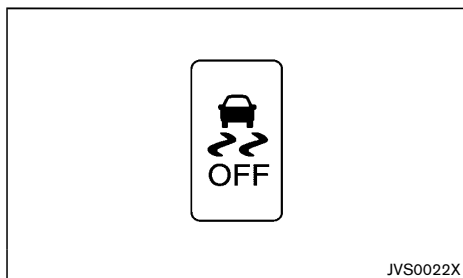

The vehicle should be driven with the Vehicle Dynamic Control (VDC) system ON for most driving conditions.

When the vehicle is stuck in mud or snow, the VDC system reduces the engine output to reduce wheel spin. The engine speed will be reduced even if the accelerator is depressed to the floor. If maximum engine power is needed to free a stuck vehicle, turn the VDC system off.

To turn off the VDC system, push the VDC OFF switch. The  indicator light will illuminate.

Push the VDC OFF switch again or restart the engine to turn ON the system.

PARKING



WARNING:

- **Do not stop or park the vehicle over flammable materials such as dry grass, waste paper or rags. They may ignite and cause a fire.**
- **Safe parking procedures require that both the parking brake be applied and the shift lever placed in the “P” (Park) position (Automatic Transmission/Continuously Variable Transmission model) or the shift lever placed in an appropriate gear (Manual Transmission model). Failure to do so could cause the vehicle to move unexpectedly or roll away and result in an accident.**
- **When parking the vehicle, make sure the shift lever is moved to the “P” (Park) position. The shift lever cannot be moved out of the “P” (Park) position without depressing the foot brake pedal (Automatic Transmission/Continuously Variable Transmission model).**
- **Never leave the engine running while the vehicle is unattended.**
- **Never leave children or adults who would normally require the support of others alone in the vehicle. Pets should not be left alone either. They could unknowingly activate switches or controls and inadvertently become involved in a serious accident and injure themselves. On hot, sunny days, temperatures in a closed vehicle could quickly become high enough to cause severe or possibly fatal illness to people and animals.**

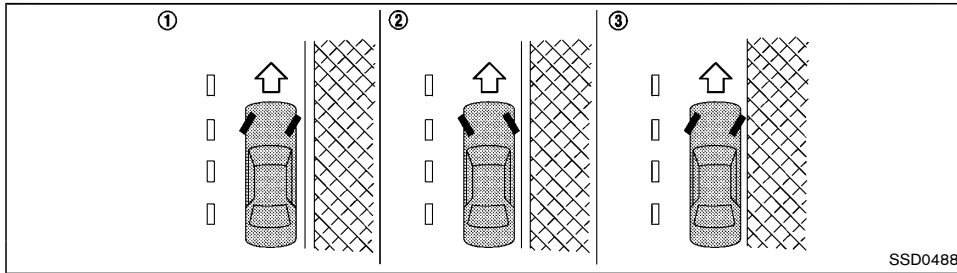

Left-Hand Drive (LHD) model

SSD0488

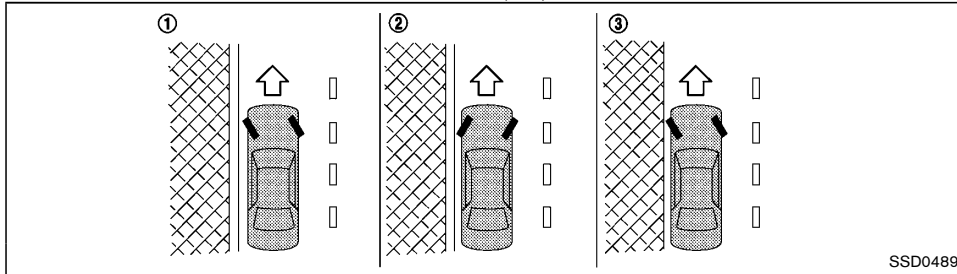

Right-Hand Drive (RHD) model

SSD0489

1. Firmly apply the parking brake.
2. Automatic Transmission (AT)/Continuously Variable Transmission (CVT) model: Move the shift lever to the "P" (Park) position.
Manual Transmission (MT) model: Move the shift lever to the "R" (Reverse) position. When parking on an uphill grade, move the shift lever to the "1" (1st) position.
3. To help prevent the vehicle from moving into traffic when parked on an incline, it is a good practice to turn the wheels as illustrated.

HEADED DOWNHILL WITH CURB ①

Turn the wheels into the curb and move the vehicle forward until the curb side wheel gently touches the curb. Then apply the parking brake.

HEADED UPHILL WITH CURB ②

Turn the wheels away from the curb and allow the vehicle to move back until the curb side wheel gently touches the curb. Then apply the parking brake.

HEADED UPHILL OR DOWNHILL, WITHOUT CURB ③

Turn the wheels toward the side of the road so the

vehicle will move away from the center of the road if the vehicle moves. Then apply the parking brake.

4. Model with Intelligent Key system:

Place the ignition switch in the "OFF" position.

Model without Intelligent Key system:

Place the ignition switch in the "LOCK" position and remove the key.

NOTE:

For model with Idling Stop System:

Use the Idling Stop System when the vehicle is stopped for a period of time, for example waiting at stoplights.

Stop the engine with the ignition switch when parking, etc. for an extended period of time.

SONAR (parking sensor) SYSTEM (if equipped)

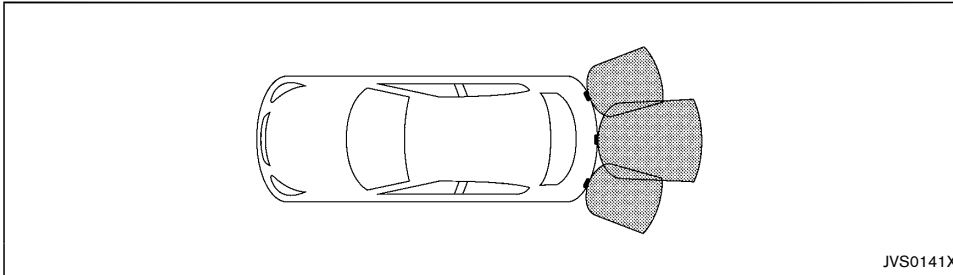

WARNING:

- The sonar (parking sensor) system is a convenience but it is not a substitute for proper parking. Always look around and check that it is safe to do so before parking. Always move slowly.
- Read and understand the limitations of the sonar (parking sensor) system as contained in this section. Inclement weather may affect the function of the sonar (parking sensor) system; this may include reduced performance or a false activation.
- This system is not designed to prevent contact with small or moving objects.
- The system is designed as an aid to the driver in detecting large stationary objects to help avoid damaging the vehicle. The system will not detect small objects below the bumper, and may not detect objects close to the bumper or on the ground.
- If your vehicle sustains damage to the bumper fascia, leaving it misaligned or bent, the sensing zone may be altered causing

inaccurate measurement of obstacles or false alarms.

CAUTION:

Keep the interior of the vehicle as quiet as possible to hear the tone clearly.

When the ignition switch is in the "ON" position, the sonar (parking sensor) system is operational.

The sonar (parking sensor) system sounds a tone to warn the driver of obstacles near the bumper. The system detects rear obstacles when the shift lever is in the "R" (Reverse) position. The system may not detect objects at speeds above 10 km/h (6 MPH) and may not detect certain angular or moving objects.

The sonar (parking sensor) system detects obstacles up to 1 m (3.3 ft) from the bumper with a decreased coverage area at the outer corners of the bumper, (refer to the illustration for approximate zone coverage areas). As you move closer to the obstacle, the rate of the tone increases. When the obstacle is less than 30 cm (11.8 in) away, the tone will sound continuously.

Keep the sonar sensors (located on the bumper fascia) free from snow, ice and large accumulations of dirt (do

not clean the sensors with sharp objects). If the sensors are covered, it will affect the accuracy of the sonar (parking sensor) system.

If the sonar (parking sensor) system malfunctions, the beep sounds for 3 seconds when the shift lever is moved to the "R" (Reverse) position. Have the system checked by a NISSAN dealer.

TRAILER TOWING

Your vehicle was designed to be used to carry passengers and luggage. NISSAN does not recommend trailer towing, because it places additional loads on your vehicle's engine, drivetrain, steering, braking, and other systems.



CAUTION:

Vehicle damage resulting from towing a trailer is not covered by the warranty.

ELECTRIC POWER STEERING SYSTEM



WARNING:

- **If the engine is not running or is turned off while driving, the power assist for the steering will not work. The steering will be harder to operate.**
- **When the electric power steering warning light illuminates with the engine running, the power assist for the steering will cease operation. You will still have control of the vehicle but the steering will be harder to operate.**

The electric power steering system is designed to provide power assist while driving to operate the steering wheel with light force.

When the steering wheel is operated repeatedly or continuously while parking or driving at a very low speed, the power assist for the steering wheel will be reduced. This is to prevent overheating of the electric power steering system and protect it from getting damaged. While the power assist is reduced, steering wheel operation will become heavy. When the temperature of the electric power steering system goes down, the power assist level will return to normal. Avoid repeating such steering wheel operations that could cause the electric power steering system to overheat.

You may hear a fricative sound when the steering wheel is operated quickly. However, this is not a malfunction.

If the electric power steering warning light **PS** illuminates while the engine is running, it may indicate the electric power steering system is not functioning properly and may need servicing. Have the electric power steering system checked by a NISSAN dealer (See "Electric power steering warning light" (P.2-13).)

When the electric power steering warning light illuminates with the engine running, the power assist for the steering will cease operation. You will still have control of the vehicle. However, greater steering effort is needed, especially in sharp turns and at low speeds.

BRAKE SYSTEM

The brake system has two separate hydraulic circuits. If one circuit malfunctions, you will still have braking ability at two wheels.

BRAKE PRECAUTIONS

Vacuum assisted brakes

The brake booster aids braking by using engine vacuum. If the engine stops, you can stop the vehicle by depressing the foot brake pedal. However, greater foot pressure on the foot brake pedal will be required to stop the vehicle. The stopping distance will be longer.

If the engine is not running or is turned off while driving, the power assisted brakes will not function. Braking will be harder.



WARNING:

Do not coast with the engine stopped.

For model with Brake Assist: When the brake pedal is depressed slowly and firmly, you may hear a clicking noise and feel a slight pulsation. This is normal and indicates that the Brake Assist System is operating.

Using brakes

Avoid resting your foot on the foot brake pedal while driving. This will overheat the brakes, wear out the brake linings/pads faster, and increase fuel consumption.

To help reduce brake wear and to prevent the brakes from overheating, reduce speed and downshift to a lower gear before going down a slope or long grade. Overheated brakes may reduce braking performance and could result in loss of vehicle control.

While driving on a slippery surface, be careful when braking, accelerating or downshifting. Abrupt braking

or acceleration could cause the wheels to skid and result in an accident.

Wet brakes

When the vehicle is washed or driven through water, the brakes may get wet. As a result, your braking distance will be longer and the vehicle may pull to one side during braking.

To dry the brakes, drive the vehicle at a safe speed while lightly depressing the foot brake pedal to heat up the brakes. Do this until the brakes return to normal. Avoid driving the vehicle at high speeds until the brakes function correctly.

Driving uphill

When starting on a steep grade, it is sometimes difficult to operate both the brake and clutch (for Manual Transmission mode). Apply the parking brake to hold the vehicle. Do not slip the clutch. When ready to start, slowly release the parking brake while depressing the accelerator pedal and releasing the clutch pedal.

Driving downhill

The engine braking action is effective for controlling the vehicle while descending hills. For Manual Transmission (MT) model, the shift lever should be placed in the lower speed position prior to descending. For Automatic Transmission (AT) model, the "1" or "2" position should be selected. For Continuously Variable Transmission (CVT) model, the "L" position should be selected.

BRAKE ASSIST (if equipped)

When the force applied to the brake pedal exceeds a certain level, the Brake Assist is activated, generating greater braking force than a conventional brake booster even with light pedal force.



WARNING:

The Brake Assist is only an aid to assist braking operation and is not a collision warning or avoidance device. It is the driver's responsibility to stay alert, drive safely and be in control of the vehicle at all times.

ANTI-LOCK BRAKING SYSTEM (ABS) (if equipped)



WARNING:

- **The Anti-lock Braking System (ABS) is a sophisticated device, but it cannot prevent accidents resulting from careless or dangerous driving techniques. It can help maintain vehicle control during braking on slippery surfaces. Remember that stopping distances on slippery surfaces will be longer than on normal surfaces even with ABS. Stopping distances may also be longer on rough, gravel or snow covered roads, or if you are using tire chains. Always maintain a safe distance from the vehicle in front of you. Ultimately, the driver is responsible for safety.**
- **Tire type and condition may also affect braking effectiveness.**
 - **When replacing tires, install the specified size of tires on all four wheels.**
 - **When installing a spare tire, make sure that it is the proper size and type as specified on the tire placard. (See “Tire placard” (P.9-9).)**
 - **For detailed information, see “Tires and wheels” (P.8-31).**

The Anti-lock Braking System (ABS) controls the brakes so the wheels do not lock during hard braking or when braking on slippery surfaces. The system detects the rotation speed at each wheel and varies the brake fluid pressure to prevent each wheel from locking and sliding. By preventing each wheel from locking, the system helps the driver maintain steering control and helps to minimize swerving and spinning on slippery surfaces.

USING SYSTEM

Depress the brake pedal and hold it down. Depress the brake pedal with firm steady pressure, but do not pump the brakes. The ABS will operate to prevent the wheels from locking up. Steer the vehicle to avoid obstacles.



WARNING:

Do not pump the brake pedal. Doing so may result in increased stopping distances.

SELF-TEST FEATURE

The ABS includes electronic sensors, electric pumps, hydraulic solenoids and a computer. The computer has a built-in diagnostic feature that tests the system each time you start the engine and move the vehicle at a low speed in forward or reverse. When the self-test occurs, you may hear a “clunk” noise and/or feel a pulsation in the brake pedal. This is normal and does not indicate a malfunction. If the computer senses a malfunction, it switches the ABS off and illuminates the ABS warning light on the instrument panel. The brake system then operates normally, but without anti-lock assistance.

If the ABS warning light illuminates during the self-test or while driving, have the vehicle checked by a NISSAN dealer.

NORMAL OPERATION

The ABS operates at speeds above 5 to 10 km/h (3 to 6 MPH). The speed varies according to road conditions.

When the ABS senses that one or more wheels are close to locking up, the actuator rapidly applies and releases hydraulic pressure. This action is similar to pumping the brakes very quickly. You may feel a pulsation in the brake pedal and hear a noise from under the hood or feel a vibration from the actuator when it is operating. This is normal and indicates that the ABS is operating properly. However, the pulsation may indicate that road conditions are hazardous and extra care is required while driving.

VEHICLE SECURITY

When leaving your vehicle unoccupied:

- Always take the key with you - even when leaving the vehicle in your own garage.
- Close all windows completely and lock all doors.
- Always park your vehicle where it can be seen. Park in a well lit area during the night.
- If the security system is equipped, use it - even for a short period.
- Never leave children or pets in the vehicle unattended.
- Never leave valuables inside the vehicle. Always take valuables with you.
- Never leave the vehicle documents in the vehicle.
- Never leave articles on a roof rack. Remove them from the rack and keep and lock them in a safe place such as inside the trunk.
- Never leave the spare key in the vehicle.

COLD WEATHER DRIVING



WARNING:

- **Whatever the condition, drive with caution. Accelerate and decelerate with great care. If accelerating or decelerating too fast, the drive wheels will lose even more traction.**
- **Allow more stopping distance in cold weather driving. Braking should be started sooner than on dry pavement.**
- **Keep at a greater distance from the vehicle in front of you on slippery roads.**
- **Wet ice (0°C, 32°F and freezing rain), very cold snow and ice can be slick and very difficult to drive on. The vehicle will have a lot less traction or grip under these conditions. Try to avoid driving on wet ice until the road is salted or sanded.**
- **Watch for slippery spots (glaring ice). These may appear on an otherwise clear road in shaded areas. If a patch of ice is seen ahead, brake before reaching it. Try not to brake while actually on the ice, and avoid any sudden steering maneuvers.**
- **Do not use cruise control on slippery roads.**
- **Snow can trap dangerous exhaust gas under your vehicle. Keep snow clear of the exhaust pipe and from around your vehicle.**

BATTERY

If the battery is not fully charged during extremely cold weather conditions, the battery fluid may freeze and damage the battery. To maintain maximum efficiency, the battery should be checked regularly. For details, see "Battery" (P.8-21).

ENGINE COOLANT

If the vehicle is to be left outside without anti-freeze, drain the cooling system, including the engine block. Refill before operating the vehicle. For details, see "Changing engine coolant" (P.8-9).

TIRE EQUIPMENT

1. If you have snow tires installed on the front/rear wheels of your vehicle, they should be of the same size, loading range, construction and type (bias, bias-belted or radial) as the rear/front tires.
2. If the vehicle is to be operated in severe winter conditions, snow tires should be installed on all four wheels.
3. For additional traction on icy roads, studded tires may be used. However, some countries, provinces and states prohibit their use. Check local, state and provincial laws before installing studded tires.
Skid and traction capabilities of studded snow tires, on wet or dry surfaces, may be poorer than that of non-studded snow tires.
4. Snow chains may be used if desired. Make sure they are the proper size for the tires on your vehicle and are installed according to the chain manufacturer's instructions. (See "Tire chains" (P.8-32).)

SPECIAL WINTER EQUIPMENT

It is recommended that the following items be carried in the vehicle during the winter:

- A scraper and stiff-bristled brush to remove ice and snow from the windows.
- A sturdy, flat board to be placed under the jack to give it firm support.
- A shovel to dig the vehicle out of snowdrifts.

PARKING BRAKE

When parking in the area where the outside temperature is below 0°C (32°F), do not apply the parking brake to prevent it from freezing. For safe parking:

- Place the shift lever in the “P” (Park) position (Automatic Transmission (AT)/Continuously Variable Transmission (CVT) model).
- Place the shift lever in the “1” (1st) or “R” (Reverse) position (Manual Transmission (MT) model).
- Securely block the wheels.

CORROSION PROTECTION

Chemicals used for road surface deicing are extremely corrosive and will accelerate corrosion and the deterioration of underbody components such as the exhaust system, fuel and brake lines, brake cables, floor pan and fenders.

In the winter, the underbody must be cleaned periodically. For additional information, see “Corrosion protection” (P.7-5).

For additional protection against rust and corrosion, which may be required in some areas, consult a NISSAN dealer.

MEMO

6 In case of emergency

Hazard indicator flasher switch	6-2	Jump starting	6-8
Flat tire	6-2	Push starting	6-10
Stopping vehicle	6-2	If your vehicle overheats	6-10
Preparing tools	6-2	Towing your vehicle	6-11
Changing flat tire (for model with spare tire)	6-3	Towing precautions	6-11
Repairing flat tire (for model with emergency tire puncture repair kit)	6-5	Towing recommended by NISSAN	6-11



HAZARD INDICATOR FLASHER SWITCH

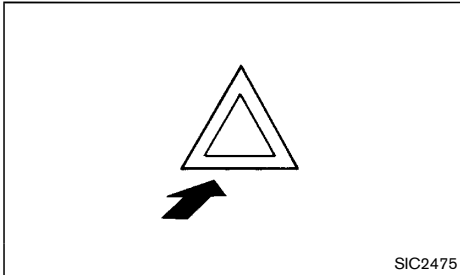

The hazard indicator flasher switch operates with the ignition switch in any position except when the battery is discharged.

The hazard indicator flasher is used to warn other drivers when you have to stop or park under emergency conditions.

When the hazard indicator flasher switch is pushed, all turn signal lights will flash. To turn off the hazard indicator flasher, push the hazard indicator flasher switch again.

FLAT TIRE

If you have a flat tire, follow the instructions as follows.

STOPPING VEHICLE



WARNING:

- **Be sure to apply the parking brake firmly.**
- **Be sure to move the shift lever to the "R" (Reverse) position (Manual Transmission (MT) model).**
- **Be sure to move the shift lever to the "P" (Park) position (Automatic Transmission (AT)/Continuously Variable Transmission (CVT) model).**
- **Never change tires when the vehicle is on a slope, ice or slippery area. This is hazardous.**
- **Never change tires when the oncoming traffic is close to your vehicle. Call for professional road assistance.**

1. Safely move the vehicle off the road away from traffic.
2. Turn on the hazard indicator flasher lights.
3. Park on a level surface.
4. Apply the parking brake.
5. Automatic Transmission (AT)/Continuously Variable Transmission (CVT) model: Move the shift lever to the "P" (Park) position.
Manual Transmission (MT) model: Move the shift lever to the "R" (Reverse) position.
6. Turn off the engine.
7. Open the hood and set up the warning triangle (if equipped):
 - To warn other traffic.

- To signal professional road assistance personnel that you need assistance.

8. Have all passengers get out from the vehicle and stand in a safe place, away from other traffic and clear of the vehicle.

PREPARING TOOLS

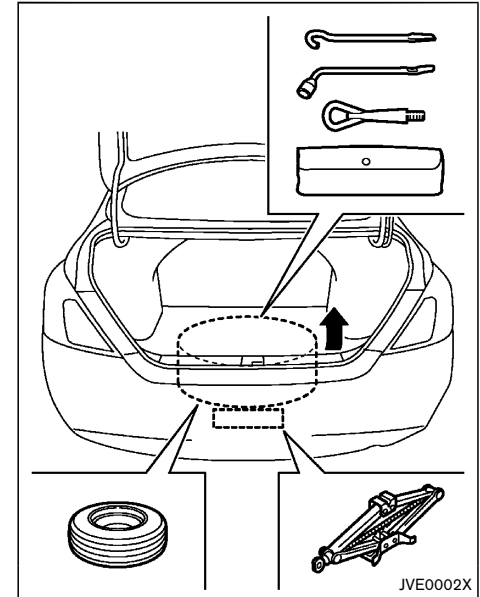

Your vehicle is equipped with either a spare tire or an emergency tire puncture repair kit. Carefully read the instructions provided in the appropriate section.

- For model with spare tire: See “Changing flat tire (for model with spare tire)” (P.6-3).
- For model with emergency tire puncture repair kit: See “Repairing flat tire (for model with emergency tire puncture repair kit)” (P.6-5).

CHANGING FLAT TIRE (for model with spare tire)

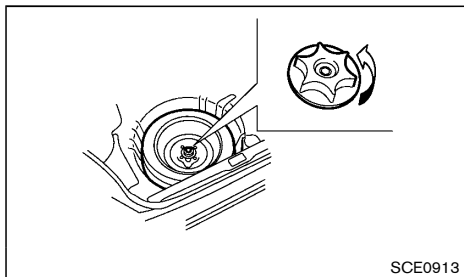

Remove the jack, necessary tools and the spare tire from the storage area.

Blocking wheels

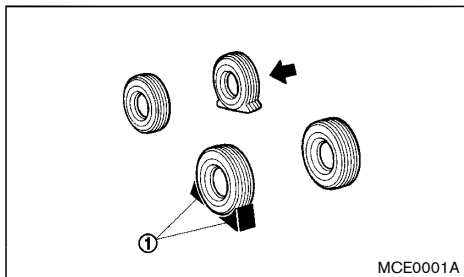

WARNING:

Be sure to block the appropriate wheel to prevent the vehicle from moving, which may cause personal injury.

Place suitable blocks ① at both the front and back of the wheel diagonally opposite the flat tire ← to prevent the vehicle from moving when it is jacked up.

Removing wheel cover (if equipped)

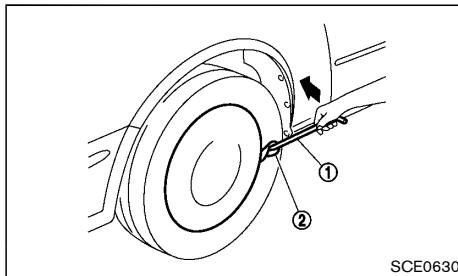

Type A

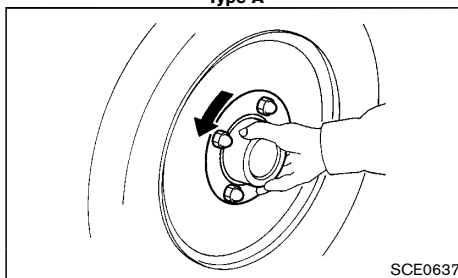

Type B

Type A:

WARNING:

Never use your hands to remove the wheel cover. This may cause personal injury.

To remove the wheel cover, use the jack rod ① as illustrated.

Apply cloth ② between the wheel and jack rod to prevent damaging the wheel and wheel cover.

Type B:

Remove the center wheel cap as illustrated.

Jacking up vehicle

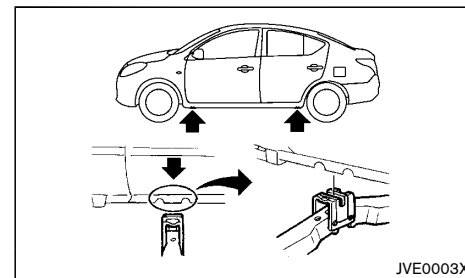

jack-up points

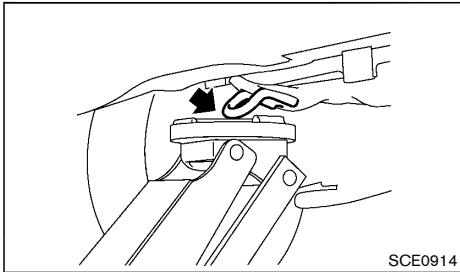

Floor jack-up point

For the rear, never jack up the vehicle at a location other than the floor jack-up point that is specified.

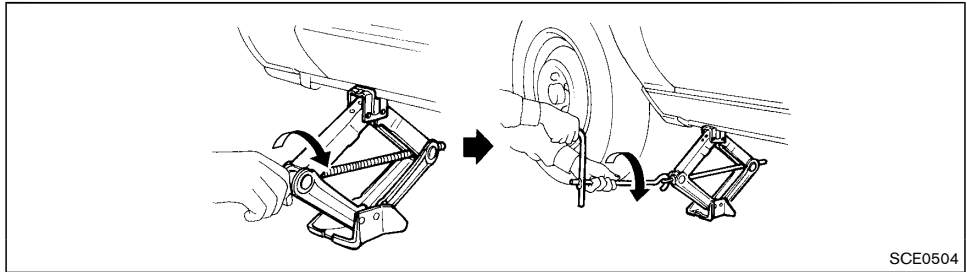

WARNING:

- **Be sure to read and follow the instructions in this section.**
- **DO NOT GET UNDER A VEHICLE THAT IS SUPPORTED BY A JACK.**
- **Never use a jack which was not provided with your vehicle.**
- **The jack, which is provided with your vehicle, is designed only to lift your vehicle during a tire change. Do not use the jack provided with your vehicle on other vehicles.**
- **Never jack up the vehicle at a location other than the jack-up point that is specified.**
- **Never lift the vehicle more than necessary.**
- **Never use blocks on or under the jack.**
- **Never start or run the engine while the vehicle is on the jack. The vehicle may move suddenly, and this may cause an accident.**
- **Never allow passengers to remain in the vehicle while the tire is off the ground.**

- **Be sure to read the caution label attached to the jack body before using.**
- **When jacking up the vehicle, be sure to apply the parking brake.**

1. Place the jack directly under the jack-up point as illustrated so that the top of the jack contacts the vehicle at the jack-up point.

The jack should be placed on firm level ground.

2. Align the jack head between the two notches located at the jack-up point of either the front or the rear section.
3. Fit the groove of the jack head between the notches as shown.
4. Loosen each wheel nut, counterclockwise, one or two turns with the wheel nut wrench.

Do not remove the wheel nuts until the tire is off the ground.

5. Carefully raise the vehicle until the clearance between the tire and ground is achieved.
6. To lift the vehicle, securely hold the jack lever and rod with both hands and turn the jack lever.

Removing tire

1. Remove the wheel nuts.
2. Remove the damaged tire.



CAUTION:

The tire is heavy. Be sure that your feet are clear from the tire and use gloves as necessary to avoid injury.

Installing spare tire

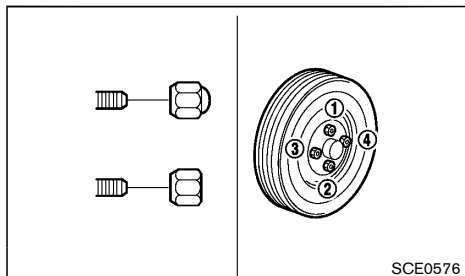

WARNING:

- Never use wheel nuts which are not provided with your vehicle. Incorrect wheel nuts or improperly tightened wheel nuts may cause the wheel to become loose or come off. This could cause an accident.
- Never use oil or grease on the wheel studs or nuts. This may cause the wheel nuts to become loose.
- The temporary-use spare tire is designed for emergency use only. (for India)

1. Clean any mud or dirt from the surface between the wheel and hub.
2. Carefully put the spare tire on and tighten the wheel nuts with your fingers. Check that all the wheel nuts contact the wheel surface horizontally.
3. Tighten the wheel nuts alternately and evenly, more than 2 times in the sequence illustrated (① - ④), with the wheel nut wrench, until they are tight.
4. Lower the vehicle slowly until the tire touches the ground.
5. Tighten the wheel nuts securely, with the wheel nut wrench, in the sequence illustrated.
6. Lower the vehicle completely.

Tighten the wheel nuts to the specified torque with a torque wrench as soon as possible.

**Wheel nut tightening torque:
108 N·m (11 kg·m, 80 ft·lb)**

The wheel nuts must be kept tightened to specification at all times. It is recommended that the wheel nuts be tightened to specification at each lubrication interval.



WARNING:

Retighten the wheel nuts when the vehicle has been driven for 1,000 km (600 miles). (also in cases of a flat tire, etc.)

Stowing damaged tire and tools



WARNING:

- **Be sure that the tire, jack and tools used are properly stored after use. Such items can become dangerous projectiles in an accident or sudden stop.**
1. Securely store the jack and tools used in the storage area.
 2. Replace the floor cover.
 3. Close the trunk lid.

REPAIRING FLAT TIRE (for model with emergency tire puncture repair kit)

The emergency tire puncture repair kit is supplied with the vehicle instead of a spare tire. This repair kit must be used for temporarily fixing a minor tire puncture. After using the repair kit, see a NISSAN dealer as soon as possible for tire inspection and repair/replacement.



CAUTION:

- **NISSAN recommends using only Genuine NISSAN Emergency Tire Sealant provided with your vehicle. Other tire sealants may damage the valve stem seal which can cause the tire to lose air pressure.**
- **Do not use the emergency tire puncture repair kit provided with your vehicle on other vehicles.**
- **Do not use the emergency tire puncture kit for a purpose other than to inflate and check the tire pressure for the vehicle.**
- **Use the emergency tire puncture kit only on DC12V.**

- Keep water and dust off the emergency tire puncture kit.
- Do not disassemble or modify the emergency tire puncture kit.
- Do not galvanize the emergency tire puncture kit.
- Do not use the emergency tire puncture repair kit under the following conditions. Contact a NISSAN dealer or professional road assistance.

— when the sealant has passed its expiration date (shown on the label attached to the bottle)

— when the cut or the puncture is approximately 6 mm (0.25 in) or longer

— when the side of the tire is damaged

— when the vehicle has been driven with a considerable loss of air from the tire

— when the tire is completely displaced inside or outside the rim

— when the tire rim is damaged

— when two or more tires are flat

Getting emergency tire puncture repair kit

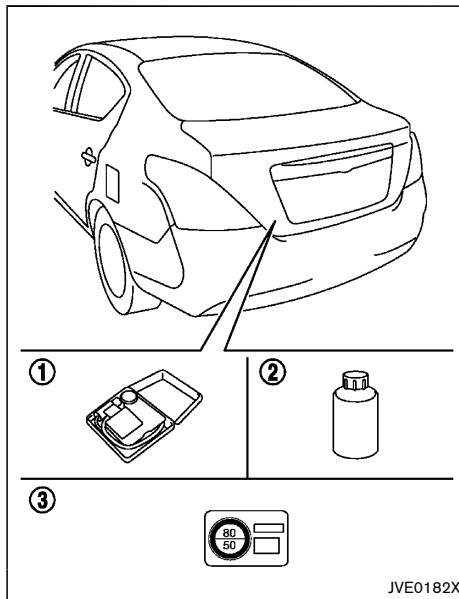

Take out the emergency tire puncture repair kit from the storage area under the trunk. The repair kit consists of the following items:

- ① Air compressor*
- ② Tire sealant bottle
- ③ Speed restriction sticker

*: The compressor shape may differ depending on the models.

Before using emergency tire puncture repair kit

- If any foreign object (for example, a screw or nail) is embedded in the tire, do not remove it.
- Check the expiration date of the sealant (shown on the label attached to the bottle). Never use a sealant whose expiration date has passed.

Repairing tire



WARNING:

Observe the following precautions when using the emergency tire puncture kit.

- Swallowing the compound is dangerous. Immediately drink as much water as possible and seek prompt medical assistance.
- Rinse well with lots of water if the compound comes into contact with skin or eyes. If irritation persists, seek prompt medical attention.
- Keep the repair compound out of the reach of children.

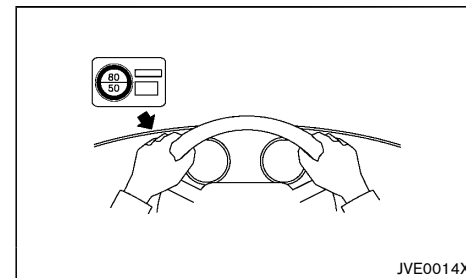

1. Take out the speed restriction sticker from the air compressor*, then put it in a location where the driver can see it while driving.

*: The compressor shape may differ depending on the models.

CAUTION:

Do not put the speed restriction sticker on the steering wheel pad, the speedometer or the warning light locations.

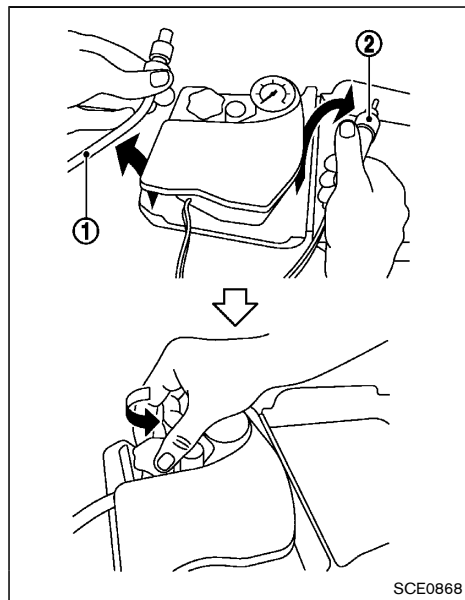

2. Take the hose ① and the power plug ② out of the air compressor. Remove the cap of the bottle holder from the air compressor.

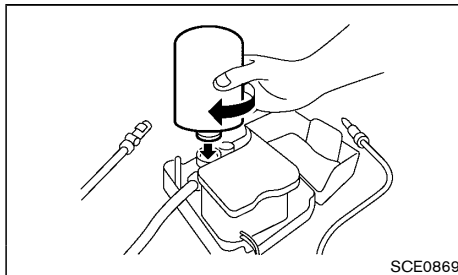

3. Remove the cap of the tire sealant bottle, and screw the bottle clockwise onto the bottle holder. (Leave the bottle seal intact. Screwing the bottle onto the bottle holder will pierce the seal of the bottle.)
4. Remove the cap of the tire valve on the flat tire.

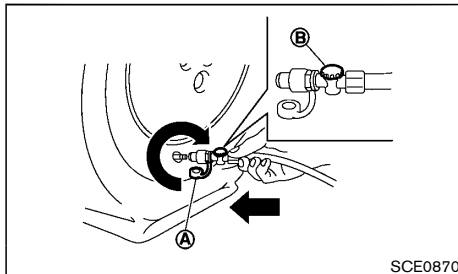

5. Remove the protective cap (A) of the hose and screw the hose securely onto the tire valve. Make sure that the pressure release valve (B) is securely tightened. Make sure that the air com-

pressor switch is in the OFF (O) position, and then insert its power plug into the power outlet in the vehicle.

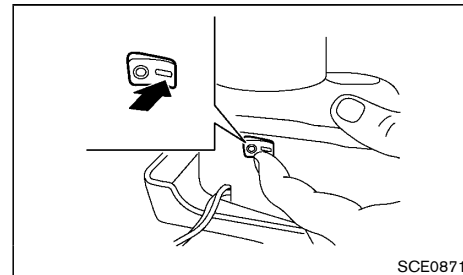

6. Push the ignition switch to the "ACC" position. Then turn the compressor switch to the ON (-) position and inflate the tire up to the pressure that is specified on the tire placard affixed to the driver's side center pillar if possible, or to the minimum of 180 kPa (26 psi). Turn the air compressor off briefly in order to check the tire pressure with the pressure gauge. If the tire is inflated to higher than the specified pressure, adjust the tire pressure by releasing air with the pressure release valve. The cold tire pressures are shown on the tire placard affixed to the driver's side center pillar.

CAUTION:

- An incomplete connection between the hose and tire valve causes air leakage or sealant scatter.
- Do not stand directly beside the damaged tire while it is being inflated because of the risk of the rupture. If there are any cracks or bumps, turn the compressor off immedi-

JUMP STARTING

ately.

- There is a possibility that the pressure reaches 600 kPa while the tire is being inflated, but it is normal condition. Usually the pressure will drop in about 30 seconds.
 - Do not operate the compressor for more than 10 minutes. If the tire pressure does not increase to 180 kPa (26 psi) within 10 minutes, the tire may be seriously damaged and the tire cannot be repaired with this tire repair kit. Contact a NISSAN dealer.
7. When the tire pressure is reaching the specified pressure or is at the minimum of 180 kPa (26 psi), turn the air compressor off. Remove the power plug from the power outlet and quickly remove the hose from the tire valve. Attach the protective cap and valve cap.



CAUTION:

Leave the tire sealant bottle on the bottle holder in order to prevent sealant from spilling out.

8. Immediately drive the vehicle for 10 minutes or 3 km (2 miles) at a speed of 80 km/h (50 MPH) or less.
9. After driving, make sure that the air compressor switch is in the OFF position, then screw the hose securely onto the tire valve. Check the tire pressure with the pressure gauge. The temporary repair is completed if the tire pressure does not drop. Make sure the pressure is adjusted to the pressure that is specified on the tire placard before driving.
10. If the tire pressure drops, repeat the steps from 5. If the pressure drops again or under 130 kPa (19

psi), the tire cannot be repaired with this tire repair kit. Contact a NISSAN dealer.



CAUTION:

Do not reuse the tire sealant bottle or the hose.
For a new tire sealant bottle and hose, see a NISSAN dealer.

After repairing tire

See a NISSAN dealer for tire repair/replacement as soon as possible.



WARNING:

- Incorrect jump starting can lead to a battery explosion. The battery explosion may result in severe injury or death. It may also result in damage to the vehicle. Be sure to follow the instructions in this section.
- Explosive hydrogen gas is always present in the vicinity of the battery. Keep all sparks and flames away from the battery.
- Always wear suitable eye protection and remove rings, bracelets, and any other jewelry whenever working on or near a battery.
- Never lean over the battery while jump starting.
- Never allow battery fluid to come into contact with eyes, skin, clothes or the vehicle's painted surfaces. Battery fluid is a corrosive sulfuric acid which can cause severe burns. If the fluid comes into contact with anything, immediately flush the contacted area with plenty of water.
- Keep the battery out of the reach of children.
- The booster battery must be rated at 12 volts. Use of an incorrectly rated battery will damage your vehicle.
- Never attempt to jump start a frozen battery. It could explode and cause serious injury.

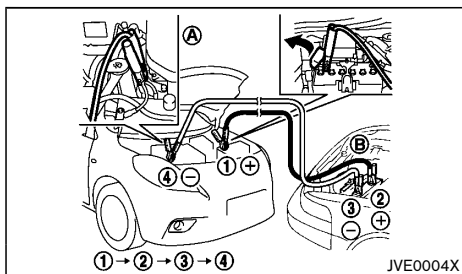

Gasoline engine model

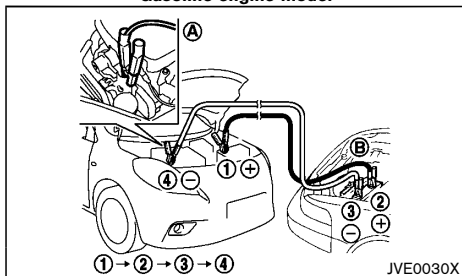

Diesel engine model

1. If the booster battery is in another vehicle (B), position the two vehicles (A) and (B) to bring the batteries into close proximity to each other.



CAUTION:

If the battery of vehicle (A) equipped with the Intelligent Key system is discharged, the ignition switch cannot be moved from the "LOCK" position and, if the steering lock is engaged, the steering wheel cannot be moved. Connect the jumper cables to the booster vehicle (B) before turning the ignition switch and disengaging the steering lock.

2. Apply the parking brake.
3. Automatic Transmission (AT)/Continuously Variable Transmission (CVT) model: Move the shift lever to the "P" (Park) position.
Manual Transmission (MT) model: Move the shift lever to the "N" (Neutral) position.
4. Switch off all unnecessary electrical systems (headlights, heater, air conditioner, etc.).
5. Place the ignition switch in the "LOCK" position.
6. Remove the vent caps, if equipped, on the battery.
7. Cover the battery with a firmly wrung out moist cloth to reduce the hazard of an explosion.
8. Connect the jumper cables in the sequence as illustrated (1, 2, 3, 4).



CAUTION:

- Always connect positive ⊕ to positive ⊕ and negative ⊖ to body ground, NOT to the battery's negative ⊖.
 - Be sure that the jumper cables do not touch moving parts in the engine compartment.
 - Be sure that the jumper cable's clamps do not contact any other metal.
9. Start the engine of the booster vehicle (B) and let it run for a few minutes.
 10. Depress the accelerator pedal of the booster vehicle (B) at about 2,000 rpm.
 11. Start the engine of the jumped vehicle (A) in the normal manner.



CAUTION:

- Never keep the starter motor engaged for more than 10 seconds. If the engine does not start right away, place the ignition switch in the "OFF" position and wait at least 10 seconds before trying again.
 - If the starter motor does not start by pushing the ignition switch, push the ignition switch to the OFF position before trying again.
12. After the engine is started, carefully disconnect the jumper cables in the opposite sequence from that illustrated ((4), (3), (2), (1)).
 13. Remove and dispose of the cloth as it may be contaminated with corrosive acid.
 14. Replace the vent caps, if removed.

NOTE:

- For model with Idling Stop System, use the special battery that is enhanced in regard to the charge-discharge capacity and life performance. Avoid using a non-special battery for the Idling Stop system, as this may cause early deterioration of the battery or a malfunction of the Idling Stop system. For the battery, it is recommended to use Genuine NISSAN parts. For more information, contact a NISSAN dealer.
- For model with Idling Stop System, it may take some time until the Idling Stop System activates when the battery is replaced or the battery terminal is disconnected for extended periods and then reconnected.

PUSH STARTING

Do not attempt to start the engine by pushing the vehicle.



CAUTION:

- **Automatic Transmission (AT)/Continuously Variable Transmission (CVT)/Manual Transmission (MT) model cannot be started by pushing. Attempting to do so may cause damage to the transmission.**
- **Three-way catalyst equipped model should not be started by pushing. Attempting to do so may cause damage to the three-way catalyst.**
- **Never try to start the engine by towing. When the engine starts, the forward surge could cause the vehicle to collide with the towing vehicle.**

IF YOUR VEHICLE OVERHEATS



WARNING:

- **Never continue driving if your vehicle overheats. Doing so could cause a vehicle fire.**
- **Never open the hood if steam is coming out.**
- **Never remove the radiator or coolant reservoir cap while the engine is hot. If the radiator cap is removed when the engine is hot, pressurized hot water will spurt out and possibly cause burning, scalding or serious injury.**
- **If steam or coolant is coming from the engine, stand clear of the vehicle to prevent getting burned.**
- **Be careful not to allow your hands, hair, jewelry or clothing to come into contact with, or to get caught in the cooling fan or drive belts. The engine cooling fan will start at any time.**

If your vehicle is overheating (indicated by the high temperature indicator), or if you feel a lack of engine power, detect unusual noise, etc., take the following steps:

1. Safely move the vehicle off the road away from traffic.
2. Turn on the hazard indicator flasher lights.
3. Apply the parking brake.
4. Automatic Transmission (AT)/Continuously Variable Transmission (CVT) model: Move the shift lever to the "P" (Park) position.

Manual Transmission (MT) model: Move the shift lever to the "N" (Neutral) position.

DO NOT STOP THE ENGINE.

5. Open all windows.
6. Turn off the air conditioner. Set the temperature control to maximum hot and fan control to maximum speed.
7. Get out from the vehicle.
8. Visually inspect and listen for steam or coolant escaping from the radiator before opening the hood. Wait until no steam or coolant can be seen before proceeding.
9. Open the engine hood.
10. Visually inspect if the cooling fan is running.
11. Visually inspect the radiator and radiator hoses for leakage.
If the cooling fan is not running or the coolant is leaking, stop the engine.
12. After the engine cools down, check the coolant level in the reservoir with the engine running. **Do not open the radiator cap (if equipped).**
13. Add coolant to the reservoir if necessary.

Have your vehicle inspected/repaired at a NISSAN dealer.

TOWING YOUR VEHICLE

When towing your vehicle, local regulations for towing must be followed. Incorrect towing equipment could damage your vehicle. To assure proper towing and to prevent accidental damage to your vehicle, NISSAN recommends that you have professional road assistance personnel tow your vehicle. It is advisable to have the professional road assistant carefully read the following precautions.

TOWING PRECAUTIONS

- Be sure that the transmission, steering system and powertrain are in working condition before towing. If any units are damaged, the vehicle must be towed using a dolly or flatbed tow truck.
- NISSAN recommends that your vehicle be towed with the driving (front) wheels off the ground.

TOWING RECOMMENDED BY NISSAN

Towing Two-Wheel Drive (2WD) model

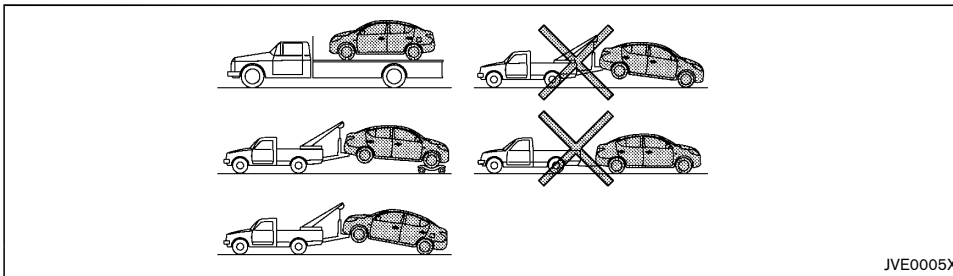

NISSAN recommends that towing dollies be used under the front wheels when towing your vehicle or the vehicle be placed on a flatbed tow truck as illustrated.

Front wheels on the ground:



CAUTION:

Never tow Automatic Transmission (AT)/Continuously Variable Transmission (CVT) model with the front wheels on the ground. Doing so will cause serious and expensive damage to the drivetrain.

Manual Transmission (MT) model:

1. Place the ignition switch in the "OFF" position.
2. Secure the steering wheel in a straight ahead position with rope or a similar device.
3. Move the shift lever to the "N" (Neutral) position.
4. Release the parking brake.
5. Attach safety chains whenever towing.

Rear wheels on the ground:

1. Place the ignition switch to the "OFF" position.
2. Secure the steering wheel in a straight-ahead position with rope or a similar device.
3. Move the shift lever to the "N" (Neutral) position.
4. Release the parking brake.
5. Attach safety chains whenever towing.

All four wheels on the ground:

NISSAN recommends that the vehicle be placed on a flatbed tow truck as illustrated.



CAUTION:

Never tow Automatic Transmission (AT)/Continuously Variable Transmission (CVT) model with all four wheels on the ground. Doing so will cause serious and expensive damage to the transmission.

Manual Transmission (MT) model:

1. Place the ignition switch in the "OFF" position.
2. Move the shift lever to the "N" (Neutral) position.
3. Release the parking brake.

Freeing trapped vehicle

WARNING:

- **Never allow anyone to stand near the towing line during the pulling operation.**
- **Never spin the tires at high speed. This could cause them to explode and result in serious injury. Parts of the vehicle could also over-heat and be damaged.**
- **Except for Indonesia: Do not pull the vehicle using the rear hook. The rear hook is not designed to pull the vehicle out in the event that the vehicle becomes trapped.**

In the event that your vehicle's tires become trapped in sand, snow, or mud, and the vehicle is unable to free itself without being pulled, use the recovery hooks.

- Use the recovery hooks only. Do not attach the pulling device to any other part of the vehicle body. Otherwise, the vehicle body may be damaged.
- Use the recovery hooks to free a vehicle only. Never tow a vehicle using only the recovery hooks.
- The recovery hooks are under tremendous stress when used to free a trapped vehicle. Always pull the pulling device straight out from the vehicle. Never pull on the recovery hooks at an angle.

Front:

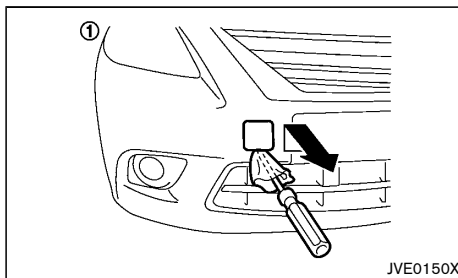

Front

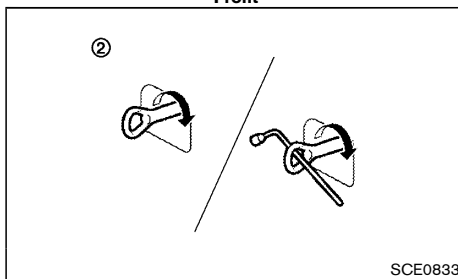

Front

- ① Remove the hook cover from the bumper with a suitable tool.
- ② Securely install the recovery hook as illustrated. (The hook is stored with the jacking tools.)

Make sure that the recovery hook is properly secured in its storage area after use.

Rear (except for Indonesia):

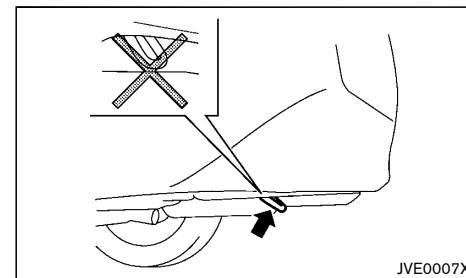

Rear

Do not use the hook to tow the vehicle.

7 Appearance and care

Cleaning exterior	7-2	Cleaning interior	7-3
Washing	7-2	Air fresheners	7-4
Removing spots	7-2	Floor mats	7-4
Waxing	7-2	Glass	7-4
Glass	7-2	Seat belts	7-4
Underbody	7-3	Corrosion protection	7-5
Wheels	7-3	Most common factors contributing to vehicle corrosion	7-5
Aluminum alloy wheels	7-3	Environmental factors influence rate of corrosion	7-5
Chrome parts	7-3	To protect your vehicle from corrosion	7-5



CLEANING EXTERIOR

In order to maintain the appearance of your vehicle, it is important to take proper care of it.

Whenever possible, park your vehicle inside a garage or in a covered area to minimize the chances of damaging the paint surface of your vehicle.

When it is necessary to park outside, park in a shady area or protect the vehicle with a body cover. **Be careful not to scratch the paint surface when putting on or removing the body cover.**

WASHING

In the following instances, wash your vehicle as soon as possible to protect the paint surface:

- After a rainfall, which may cause the paint surface damage from acid rain.
 - After driving on coastal roads, which may cause rusting from the sea breeze.
 - When contaminants such as soot, bird droppings, tree sap, metal particles or bugs get on the paint surface.
 - When dust or mud builds up on the paint surface.
1. Wash the vehicle surface with a wet sponge and plenty of water.
 2. Clean the vehicle surface gently and thoroughly using a mild soap, a special vehicle soap or a general purpose dishwashing liquid mixed with clean, lukewarm (never hot) water.



CAUTION:

- **Do not wash the vehicle with strong household soap, strong chemical detergents, gasoline or solvents.**
- **Do not wash the vehicle in direct sunlight or while the vehicle body is hot, as the paint surface may become water-spotted.**

- **Avoid using tight-napped or rough cloths, such as washing mitts. Care must be taken when removing caked-on dirt or other foreign substances so the paint surface is not scratched or damaged.**
3. Rinse the vehicle thoroughly with plenty of clean water.
 4. Use a dampened chamois to dry the paint surface and avoid leaving water spots.

When washing the vehicle, take care of the following:

- Inside flanges, joints and folds on the doors, hatches and hood are particularly vulnerable to the effects of road salt. Therefore, these areas must be cleaned regularly.
- Be sure that the drain holes in the lower edge of the doors are not clogged.
- Spray water to the underbody and in the wheel wells to loosen the dirt and/or wash away road salt.

REMOVING SPOTS

Remove tar and oil spots, industrial dust, insects, and tree sap as quickly as possible from the paint surface to avoid lasting damage or staining. Special cleaning products are available at a NISSAN dealer or any automotive accessory store.

WAXING

Regular waxing protects the paint surface and helps maintain a new vehicle appearance.

After waxing, polishing is recommended to remove built-up residue and to avoid a weathered appearance.

A NISSAN dealer can assist you in choosing the appropriate waxing products.



CAUTION:

- **Wash your vehicle thoroughly and completely before applying wax to the paint surface.**
- **Always follow the manufacturer's instructions supplied with the wax.**
- **Do not use a wax containing any abrasives, cutting compounds or cleaners that may damage the vehicle finish.**

Machine compounding or aggressive polishing on a base coat/clear coat paint finish may dull the finish or leave swirl marks.

GLASS

Use glass cleaner to remove smoke and dust film from the glass surfaces. It is normal for glass to become coated with a film after the vehicle is parked in the hot sun. Glass cleaner and a soft cloth will easily remove this film.

UNDERBODY

In areas where road salt is used in the winter, it is necessary to clean the vehicle's underbody regularly in order to prevent dirt and salt from building up and causing the acceleration of corrosion on the underbody and suspension.

Before the winter and again in the spring, the underseal must be checked and, if necessary, re-treated.

WHEELS

- Wash the wheels when washing the vehicle to maintain their appearance.
- Clean the inner side of the wheels when the wheel is changed or the underside of the vehicle is washed.
- Do not use abrasive cleaners when washing the wheels.
- Inspect wheel rims regularly for dents or corrosion. This may cause loss of pressure or damage the tire bead.
- NISSAN recommends that the road wheels be waxed to protect against road salt in areas where it is used during winter.

ALUMINUM ALLOY WHEELS

Wash the wheels regularly with a sponge dampened in a mild solution, especially during winter in areas where road salt is used.

The salt residue from road salt could discolor the wheels if it is not washed off regularly.



CAUTION:

Follow the directions below to avoid staining or discoloring the wheels:

- **Do not use a cleaner that uses strong acid or alkali contents to clean the wheels.**
- **Do not apply wheel cleaners to the wheels when they are hot. The wheel temperature should be the same as ambient temperature.**
- **Rinse the wheel to completely remove the cleaner within 15 minutes after the cleaner is applied.**

CHROME PARTS

Clean all chrome parts regularly with a nonabrasive chrome polish to maintain the finish.

CLEANING INTERIOR

Occasionally remove loose dust from the interior trim, plastic parts and seats using a vacuum cleaner or soft bristled brush. Wipe the vinyl and leather surfaces with a clean, soft cloth dampened in mild soap solution, then wipe clean with a dry, soft cloth.

Regular care and cleaning is required in order to maintain the appearance of the leather.

Before using any fabric protector, read the manufacturer's recommendations. Some fabric protectors contain chemicals that may stain or bleach the seat material.

Use a soft cloth dampened only with water to clean the meter and gauge lens covers.



CAUTION:

- **Never use benzine, thinner or any similar material.**
- **Small dirt particles can be abrasive and damaging to leather surfaces and should be removed promptly. Do not use saddle soap, car waxes, polishes, oils, cleaning fluids, solvents, detergents or ammonia-based cleaners as they may damage the leather natural finish.**
- **Never use fabric protectors unless recommended by the manufacturer.**
- **Do not use glass or plastic cleaner on meter or gauge lens covers. It may damage the lens covers.**

AIR FRESHENERS

Most air fresheners use a solvent that could affect the vehicle interior. If you use an air freshener, take the following precautions:

- Hanging-type air fresheners can cause permanent discoloration when they contact vehicle interior surfaces. Place the air freshener in a location that allows it to hang free and not contact an interior surface.
- Liquid-type air fresheners typically clip on the vents. These products can cause immediate damage and discoloration when spilled on interior surfaces.

Carefully read and follow the manufacturer's instructions before using air fresheners.

FLOOR MATS

The use of genuine NISSAN floor mats (if equipped) can extend the life of your vehicle carpet and make it easier to clean the interior. Regardless of what mats are used, be sure they are fitted for your vehicle and are properly positioned in the glass well to prevent interference with pedal operation. Mats should be maintained with regular cleaning and replaced if they become excessively worn.

Floor mat positioning aid (driver's side)

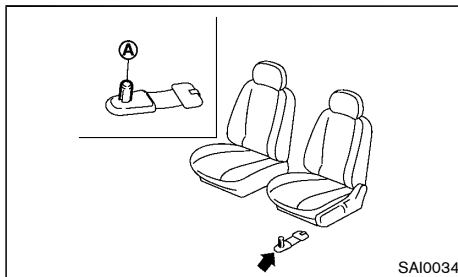

This vehicle includes a front floor mat bracket (A) to act as a floor mat positioning aid. NISSAN floor mats have been specially designed for your vehicle model. The driver's floor mat has a grommet hole incorporated in it.

Position the mat by placing the floor mat bracket hook through the floor mat grommet hole while centering the mat in the foot area.

Periodically check that the mats are properly positioned.

GLASS

Use glass cleaner to remove smoke and dust film from the glass surfaces. It is normal for glass to become coated with a film after the vehicle is parked in the hot sun. Glass cleaner and a soft cloth will easily remove this film.



CAUTION:

When cleaning the inside of the windows, do not use sharp-edged tools, abrasive cleaners or chlorine-based disinfectant cleaners. They could damage the electrical conductors, such as rear

window defogger elements.

SEAT BELTS



WARNING:

- **Do not allow wet seat belts to roll up in the retractor.**
- **Never use bleach, dye or chemical solvents to clean the seat belts, since these materials may severely weaken the seat belt webbing.**

The seat belts can be cleaned by wiping them with a sponge dampened in a mild soap solution.

Allow the belts to dry completely in the shade before using them. (See "Seat belts" (P.1-6).)

CORROSION PROTECTION

MOST COMMON FACTORS CONTRIBUTING TO VEHICLE CORROSION

- The accumulation of moisture-retaining dirt and debris in body panel sections, cavities, and other areas.
- Damage to the paint surface and other protective coatings caused by gravel and stone chips or minor traffic accidents.

ENVIRONMENTAL FACTORS INFLUENCE RATE OF CORROSION

Moisture

The accumulation of sand, dirt and water on the inside floor of the vehicle can accelerate corrosion. Wet floor carpet/floor mats will not dry completely inside the vehicle. They should be removed and completely dried to avoid floor panel corrosion.

Relative humidity

Corrosion will be accelerated in areas of high relative humidity.

Temperature

High temperatures accelerate the rate of corrosion to those parts which are not well ventilated.

Corrosion will also be accelerated in areas where the temperatures stay above freezing.

Air pollution

Industrial pollution, the presence of salt in the air in coastal areas, or heavy road salt use accelerates the corrosion process. Road salt also accelerates the disintegration of paint surfaces.

TO PROTECT YOUR VEHICLE FROM CORROSION

- Wash and wax your vehicle often to keep the vehicle clean.
- Always check for minor damage to the paint surface and if any exists, repair it as soon as possible.
- Keep the drain holes in the lower edge of the doors open to avoid water accumulation.
- Check the vehicle underbody for accumulation of sand, dirt or salt. If present, wash with water as soon as possible.



CAUTION:

- **Never remove dirt, sand or other debris from the passenger compartment by washing it out with a hose. Remove dirt with a vacuum cleaner or broom.**
- **Never allow water or other liquids to come in contact with electronic components inside the vehicle as this may damage them.**

Chemicals used for road surface deicing are extremely corrosive. They accelerate corrosion and deterioration of underbody components such as the exhaust system, fuel and brake lines, brake cables, floor pan and fenders.

In the winter, the underbody must be cleaned periodically.

For additional protection against rust and corrosion, which may be required in some areas, consult a NISSAN dealer.

MEMO

8 Maintenance and do-it-yourself

Maintenance requirements	8-3	Brakes	8-15
Scheduled maintenance	8-3	Checking parking brake	8-15
General maintenance	8-3	Checking foot brake pedal	8-16
Where to go for service	8-3	Brake booster	8-16
General maintenance	8-3	Brake fluid	8-17
Explanation of general maintenance items	8-3	Clutch fluid (if equipped)	8-17
Maintenance precautions	8-5	Automatic Transmission Fluid (ATF) (if equipped)	8-18
Engine compartment check locations	8-6	Continuously Variable Transmission (CVT) fluid (if equipped)	8-18
HR15DE engine model	8-6	Air cleaner filter	8-18
HR12DE engine model	8-7	HR12DE and HR15DE engine model	8-18
K9K engine model	8-8	K9K engine model	8-19
Engine cooling system	8-8	Wiper blades	8-19
Checking engine coolant level	8-9	Windshield wiper blades	8-19
Changing engine coolant	8-9	Window washer fluid	8-20
Engine oil	8-10	Battery	8-21
Checking engine oil level	8-10	Vehicle battery	8-21
Changing engine oil and oil filter	8-10	Remote controller battery	8-22
Protect environment	8-13	Intelligent Key battery	8-23
Fuel filter (diesel engine model)	8-13	Variable voltage control system (if equipped)	8-24
Draining water	8-13	Fuses	8-24
Bleeding fuel system	8-13	Engine compartment	8-24
Drive belts	8-14	Passenger compartment	8-25
HR12DE and HR15DE engine model	8-14	Lights	8-26
K9K engine model	8-14	Headlights	8-26
Spark plugs (gasoline engine model)	8-15	Exterior lights	8-27
Iridium-tipped spark plugs (if equipped)	8-15	Interior lights	8-27
Platinum-tipped spark plugs (if equipped)	8-15	Light locations	8-28

Tires and wheels	8-31
Tire inflation pressure	8-31
Types of tires	8-31
Tire chains	8-32
Tire rotation	8-32

Tire wear and damage	8-32
Tire age	8-32
Changing tires and wheels	8-32
Wheel balance	8-33
Spare tire	8-33

MAINTENANCE REQUIREMENTS

Some day-to-day and regular maintenance is essential to maintain your vehicle's good mechanical condition, as well as its emission and engine performance.

It is the owner's responsibility to make sure that the specified maintenance, as well as general maintenance, is performed.

As the vehicle owner, you are the only one who can ensure that your vehicle receives the proper maintenance care.

SCHEDULED MAINTENANCE

For your convenience, the required scheduled maintenance items are described and listed in a separate Warranty Information and Maintenance booklet. You must refer to that booklet to ensure that necessary maintenance is performed on your vehicle at regular intervals.

GENERAL MAINTENANCE

General maintenance includes those items which should be checked during normal day-to-day operation of the vehicle. They are essential if your vehicle is to continue to operate properly. It is your responsibility to perform these procedures regularly as prescribed.

Performing general maintenance checks requires minimal mechanical skill and a few general automotive tools.

These checks or inspections can be done by yourself, a qualified technician, or if you prefer, your NISSAN dealer.

WHERE TO GO FOR SERVICE

If maintenance service is required or your vehicle appears to malfunction, have the systems checked and tuned by an authorized NISSAN dealer.

GENERAL MAINTENANCE

During normal day-to-day operation of the vehicle, general maintenance should be performed regularly as prescribed in this section. If you detect any unusual sounds, vibrations or smells, be sure to check for the cause or have a NISSAN dealer do it promptly. In addition, you should notify a NISSAN dealer if you think that repairs are required.

When performing any checks or maintenance work, closely observe "Maintenance precautions" (P.8-5).

EXPLANATION OF GENERAL MAINTENANCE ITEMS

Additional information on the following items with "*" is found later in this section.

Outside vehicle

The maintenance items listed here should be performed from time to time, unless otherwise specified.

Doors and hood:

Check that all doors and the hood operate smoothly as well as the back door, trunk lid and hatch. Also make sure that all latches lock securely. Lubricate if necessary. Make sure that the secondary latch keeps the hood from opening when the primary latch is released. When driving in areas using road salt or other corrosive materials, check lubrication frequently.

Lights*:

Clean the headlights on a regular basis. Make sure that the headlights, stop lights, tail lights, turn signal lights, and other lights are all operating properly and installed securely. Also check the aim of the headlights.

Tires*:

Check the pressure with a gauge often and always prior to long distance trips. Adjust the pressure in all tires, including the spare, to the pressure specified. Check carefully for damage, cuts or excessive wear.

Tire rotation*:

In the case that Two-Wheel Drive (2WD) and front and rear tires are same size; Tires should be rotated every 10,000 km (6,000 miles). Tires marked with directional indicators can only be rotated between front and rear. Make sure that the directional indicators point in the direction of wheel rotation after the tire rotation is completed.

In the case that Four-Wheel Drive (4WD) and front and rear tires are same size; Tires should be rotated every 5,000 km (3,000 miles). Tires marked with directional indicators can only be rotated between front and rear. Make sure that the directional indicators point in the direction of wheel rotation after the tire rotation is completed.

In the case that front tires are different size from rear tires; Tires cannot be rotated.

However, the timing for tire rotation may vary according to your driving habits and the road surface conditions.

Tire Pressure Monitoring System (TPMS) transmitter components (if equipped):

Replace the TPMS transmitter grommet seal, valve core and cap when the tires are replaced due to wear or age.

Wheel alignment and balance:

If the vehicle should pull to either side while driving on a straight and level road, or if you detect uneven or abnormal tire wear, there may be a need for wheel alignment. If the steering wheel or seat vibrates at normal highway speeds, wheel balancing may be

needed.

Windshield:

Clean the windshield on a regular basis. Check the windshield at least every six months for cracks or other damage. Repair as necessary.

Wiper blades*:

Check for cracks or wear if not functioning correctly.

Inside vehicle

The maintenance items listed here should be checked on a regular basis, such as when performing periodic maintenance, cleaning the vehicle, etc.

Accelerator pedal:

Check the pedal for smooth operation and make sure that the pedal does not catch or require uneven effort. Keep the floor mats away from the pedal.

Brake pedal*:

Check the pedal for smooth operation and make sure that it is the proper distance from the floor mat when depressed fully. Check the brake booster function. Be sure to keep the floor mats away from the pedal.

Parking brake*:

Check the parking brake operation regularly. Check that the lever (if equipped) or the pedal (if equipped) has the proper travel. Also make sure that the vehicle is held securely on a fairly steep hill when only the parking brake is applied.

Seat belts:

Check that all parts of the seat belt system (for example, buckles, anchors, adjusters and retractors) operate properly and smoothly, and are installed securely. Check the belt webbing for cuts, fraying, wear or damage.

Steering wheel:

Check for changes in the steering condition, such as excessive play, hard steering or strange noises.

Warning lights and chimes:

Make sure that all warning lights and chimes are operating properly.

Windshield defogger:

Check that the air comes out of the defogger outlets properly and in good quantity when operating the heater or air conditioner.

Windshield wiper and washer*:

Check that the wipers and washer operate properly and that the wipers do not streak.

Under hood and vehicle

The maintenance items listed here should be checked periodically (for example, each time you check the engine oil or refuel).

Battery*:

Except for maintenance free battery, check the fluid level in each cell. It should be between the "UPPER" and "LOWER" lines. Vehicles operated in high temperatures or under severe conditions require frequent checks of the battery fluid level.

Brake (and clutch) fluid level(s)*:

For Manual Transmission (MT) model; make sure that the brake and clutch fluid levels are between the "MAX" and "MIN" lines on the reservoirs.

Except for Manual Transmission (MT) model; make sure that the brake fluid level is between the "MAX" and "MIN" lines on the reservoir.

Coolant level*:

Check the coolant level when the coolant is cold. Make sure that the coolant level is between the “MAX” and “MIN” lines on the reservoir.

Engine drive belt(s)*:

Make sure that drive belt(s) is/are not frayed, worn, cracked or oily.

Engine oil level*:

Check the level after parking the vehicle (on a level ground) and turning off the engine.

Fluid leaks:

Check under the vehicle for fuel, oil, water or other fluid leaks after the vehicle has been parked for a while. Water dripping from the air conditioner after use is normal. If you should notice any leaks or if fuel fumes are evident, check for cause and have it corrected immediately.

Window washer fluid*:

Check that there is adequate fluid in the reservoir.

MAINTENANCE PRECAUTIONS

When performing any inspection or maintenance work on your vehicle, always take care to prevent serious accidental injury to yourself or damage to the vehicle. The following are general precautions which should be closely observed.



WARNING:

- **Park the vehicle on a level surface, apply the parking brake securely and block the wheels to prevent the vehicle from moving. Move the shift lever to the “P” (Park) position (Automatic Transmission model/Continuously Variable Transmission model) or the**

“N” (Neutral) position (Manual Transmission model).

- **Be sure the ignition switch is in the “OFF” or “LOCK” position when performing any parts replacement or repairs.**
- **Do not work under the hood while the engine is hot. Always turn off the engine and wait until it cools down.**
- **If you must work with the engine running, keep your hands, clothing, hair and tools away from moving fans, belts and any other moving parts.**
- **It is advisable to secure or remove any loose clothing and any jewelry, such as rings, watches, etc. before working on your vehicle.**
- **If you must run the engine in an enclosed space such as a garage, be sure there is proper ventilation for exhaust gases to escape.**
- **Never get under the vehicle while it is supported by a jack.**
- **Keep smoking materials, flame and sparks away from fuel and the battery.**
- **Never connect or disconnect either the battery or any transistorized component connector while the ignition switch is in the “ON” position.**
- **On gasoline engine models with the Multiport Fuel Injection (MFI) system, the fuel filter and fuel lines should be serviced by a NISSAN dealer because the fuel lines are under high pressure even when the engine is turned off.**

- **Your vehicle is equipped with an automatic engine cooling fan. It may come on at any time without warning, even if the ignition switch is in the “OFF” position and the engine is not running. To avoid injury, always disconnect the negative battery cable before working near the fan.**
- **Always wear eye protection whenever you work on your vehicle.**
- **Never leave the engine or the transmission related component harness connector disconnected while the ignition switch is in the “ON” position.**
- **Avoid direct contact with used engine oil and coolant. Improperly disposed engine oil, engine coolant, and/or other vehicle fluids can hurt the environment. Always conform to local regulations for disposal of vehicle fluids.**

This “8. Maintenance and do-it-yourself” section provides instructions regarding only those items which are relatively easy for an owner to perform.

You should be aware that incomplete or improper servicing may result in operating difficulties or excessive emissions, and could affect your warranty coverage. **If in doubt about any servicing, have it done by a NISSAN dealer.**

ENGINE COMPARTMENT CHECK LOCATIONS

HR15DE ENGINE MODEL

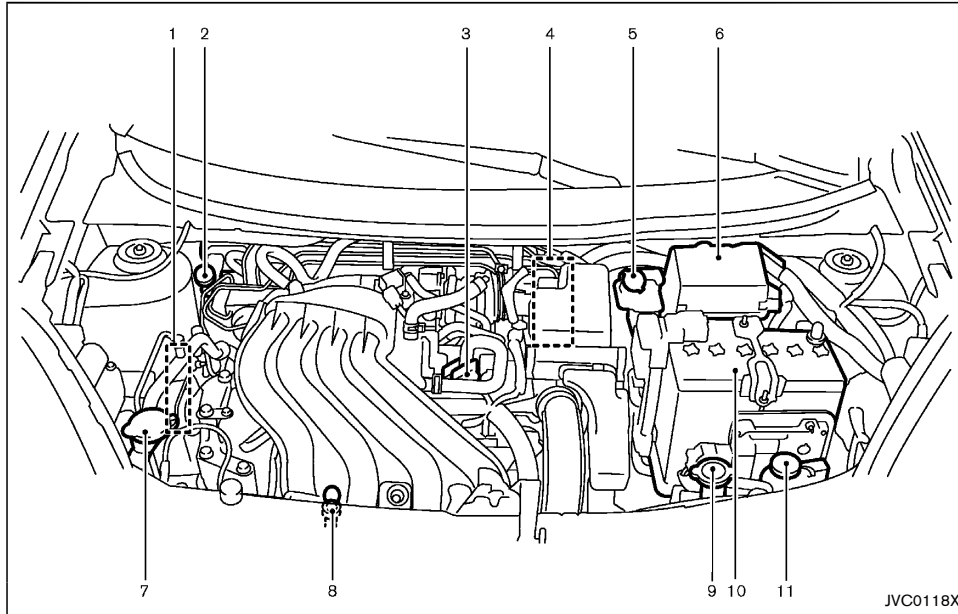

- | | |
|--|----------------------------------|
| 1. Engine drive belts | 6. Fuse/fusible link box |
| 2. Brake and clutch* fluid reservoir
— Right-Hand Drive (RHD) model | 7. Window washer fluid reservoir |
| 3. Engine oil filler cap | 8. Engine oil dipstick |
| 4. Air cleaner | 9. Radiator cap |
| 5. Brake and clutch* fluid reservoir
— Left-Hand Drive (LHD) model | 10. Battery |
| | 11. Engine coolant reservoir |
- *: For Manual Transmission (MT) Model

HR12DE ENGINE MODEL

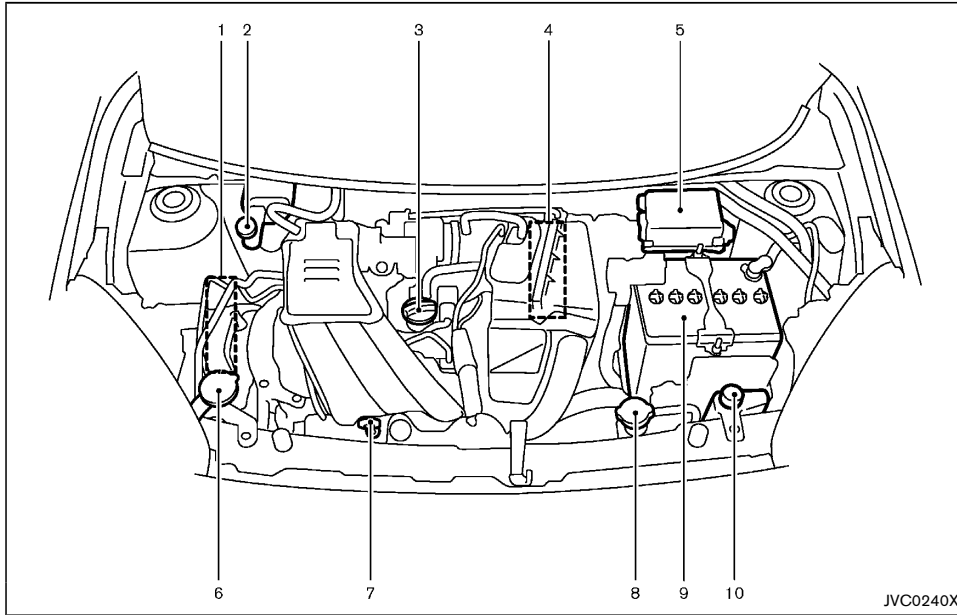

- | | |
|--------------------------------------|---------------------------------------|
| 1. Engine drive belts | 9. Battery |
| 2. Brake and clutch* fluid reservoir | 10. Engine coolant reservoir |
| 3. Engine oil filler cap | *: For Manual Transmission (MT) Model |
| 4. Air cleaner | |
| 5. Fuse/fusible link box | |
| 6. Window washer fluid reservoir | |
| 7. Engine oil dipstick | |
| 8. Radiator cap | |

ENGINE COOLING SYSTEM

K9K ENGINE MODEL

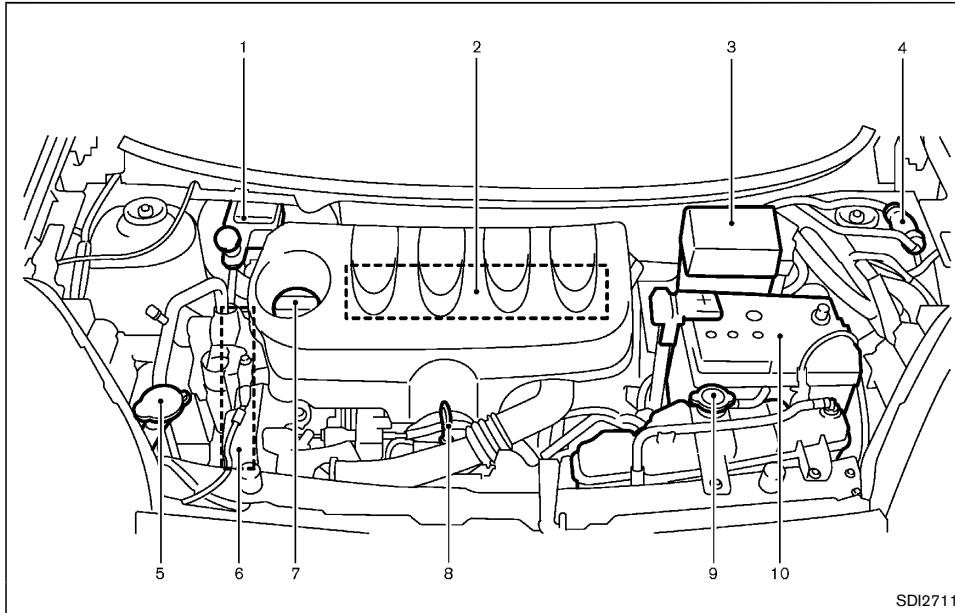

- | | |
|-------------------------------------|-----------------------------|
| 1. Brake and clutch fluid reservoir | 9. Engine coolant reservoir |
| 2. Air cleaner | 10. Battery |
| 3. Fuse/fusible link box | |
| 4. Priming pump | |
| 5. Window washer fluid reservoir | |
| 6. Engine drive belts | |
| 7. Engine oil filler cap | |
| 8. Engine oil dipstick | |



WARNING:

- **Never remove the radiator or coolant reservoir cap when the engine is hot. Serious burns could be caused by high-pressure fluid escaping from the radiator. Wait until the engine and radiator cool down.**
- **Engine coolant is poisonous and should be stored carefully in marked containers out of the reach of children.**

The engine cooling system is filled at the factory with a high-quality, year-round, anti-freeze coolant solution. The anti-freeze solution contains rust and corrosion inhibitors, therefore additional cooling system additives are not necessary.



CAUTION:

- **Never use any cooling system additives such as radiator sealer. Additives may clog the cooling system and cause damage to the engine, transmission and/or cooling system.**
- **When adding or replacing coolant, be sure to use only Genuine NISSAN Engine Coolant or equivalent in its quality with the proper mixture ratio. Examples of the mixture ratio of coolant and water are shown in the following table:**

Outside temperature down to		Composition	
°C	°F	Engine coolant (concentrated)	Demineralized or distilled water
-15	5	30%	70%
-35	-30	50%	50%

The use of other types of coolant solutions may damage the engine cooling system.

For HR12DE or HR15DE engine model: The radiator is equipped with a pressure cap. To prevent engine damage, use only a Genuine NISSAN radiator cap or its equivalent when replacement is required.

CHECKING ENGINE COOLANT LEVEL

HR12DE and HR15DE engine model

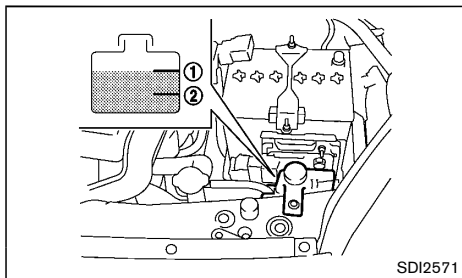

Check the coolant level in the reservoir when the engine is cold. If the coolant level is below the MIN level (2), add coolant up to the MAX level (1). If the reservoir is empty, check the coolant level in the radiator **when the engine is cold**. If there is insufficient coolant in the radiator, fill the radiator with coolant up to the filler opening and also add it to the

reservoir up to the MAX level (1).

If the cooling system frequently requires coolant, have it checked by a NISSAN dealer.

K9K engine model

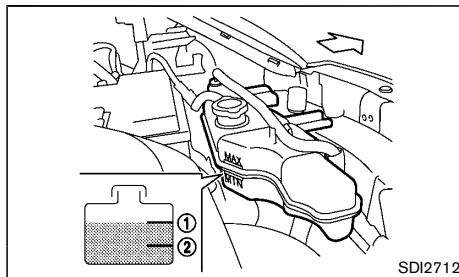

Check the coolant level in the reservoir when the engine is cold. If the coolant level is below the MIN level (2), add coolant up to the MAX level (1).

If the cooling system frequently requires coolant, have it checked by a NISSAN dealer.

CHANGING ENGINE COOLANT

Contact a NISSAN dealer if replacement is required.

Major engine cooling system repair should be performed by a NISSAN dealer. The service procedures can be found in the appropriate NISSAN Service Manual.

Improper servicing can result in reduced heater performance and engine overheating.



WARNING:

- **To avoid being scalded, never change the coolant when the engine is hot.**

- **Never remove the radiator cap when the engine is hot. Serious burns could be caused by high pressure fluid escaping from the radiator.**

- **Avoid direct skin contact with used coolant. If skin contact is made, wash thoroughly with soap or hand cleaner as soon as possible.**

- **Keep coolant out of reach of children and pets.**

Engine coolant must be disposed of properly. Check your local regulations.

ENGINE OIL

CHECKING ENGINE OIL LEVEL

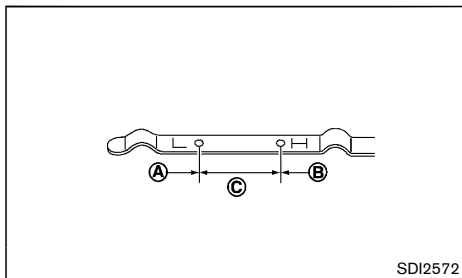

HR12DE and HR15DE engine model

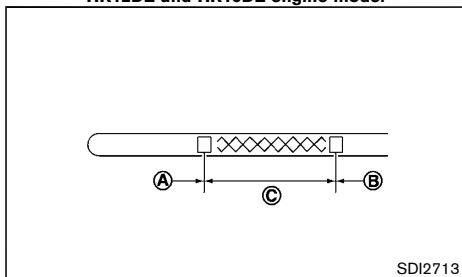

K9K engine model

1. Park the vehicle on a level surface and apply the parking brake.
2. Start the engine and warm it up until the engine temperature reaches the normal operating temperature (approximately 5 minutes).
3. Stop the engine.
4. Wait at least 10 minutes for the engine oil to drain back to the oil pan.
5. Remove the dipstick and wipe it clean.

6. Reinsert the dipstick all the way.
7. Remove the dipstick and check the oil level. It should be within the range (C) .
8. If the oil level is below (A) , remove the oil filler cap and pour the recommended oil into the opening. Do not overfill (B) .
9. Recheck the oil level with the dipstick.

When filling the engine oil, do not remove the dipstick.

It is normal to add some oil between oil maintenance intervals or during the break-in period, depending on the severity of operating conditions.



CAUTION:

The oil level should be checked regularly. Operating your vehicle with an insufficient amount of oil can damage the engine, and such damage is not covered by warranty.

CHANGING ENGINE OIL AND OIL FILTER



WARNING:

- **Used oil must be disposed of properly. Never pour or dump oil into the ground, canals, rivers, etc. It should be disposed of at proper waste facilities. NISSAN recommends having your oil changed by a NISSAN dealer.**
- **Be careful not to burn yourself, as the engine oil may be hot.**
- **Prolonged and repeated contact with used engine oil may cause skin cancer.**
- **Avoid direct skin contact with used oil. If contacted, wash thoroughly with soap or**

hand cleaner and plenty of water as soon as possible.

- **Store used engine oil in marked containers out of the reach of children.**



CAUTION:

Waste oil must be disposed of properly. Check your local regulations.

Engine oil replacement (gasoline engine model)

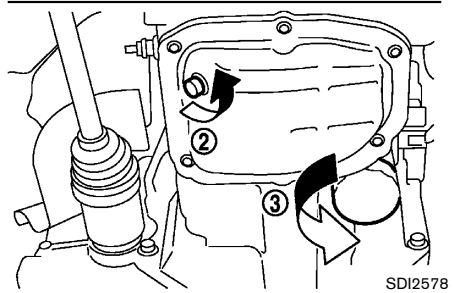
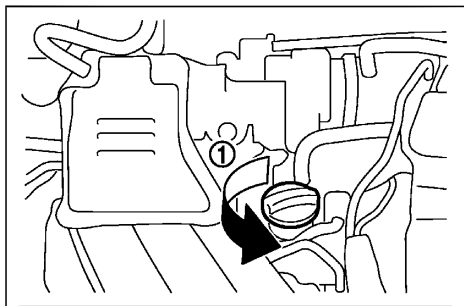

HR12DE engine model

SDI2578

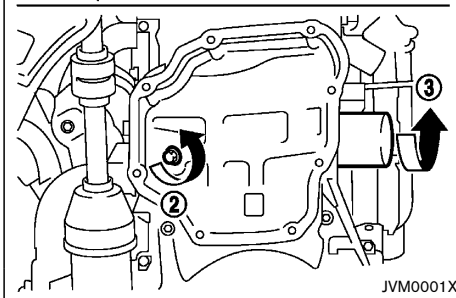
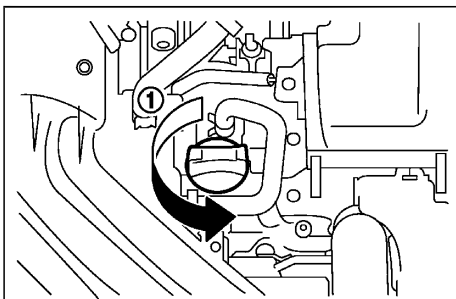

HR15DE engine model

JVM0001X

- ① Oil filler cap
- ② Oil drain plug
- ③ Oil filter

1. Park the vehicle on a level surface and apply the parking brake.
2. Start the engine and warm it up until the engine temperature reaches the normal operating temperature (approximately 5 minutes).
3. Stop the engine.

4. Wait at least 10 minutes for the engine oil to drain back to the oil pan.
5. Place a large drain pan under the drain plug.
6. Remove the drain plug with a wrench.
7. Remove the oil filler cap and completely drain the oil.

If the oil filter is to be changed, remove and replace it at this time. (See "Engine oil filter replacement (gasoline engine model)" (P.8-12).)

8. Clean and reinstall the drain plug and new washer. Securely tighten the drain plug with a wrench. Do not use excessive force.

Drain plug tightening torque:

29 to 39 N·m

(3.0 to 4.0 kg-m, 21 to 29 ft-lb)

9. Refill the recommended engine oil and quantity. (See "Recommended fuel/lubricants and capacities" (P.9-2).)

When filling the engine oil, do not remove the dipstick.

10. Securely install the oil filler cap.
11. Start the engine.
12. Check the drain plug for any sign of leakage.
13. Check the engine oil level according to the proper procedure. (See "Checking engine oil level" (P.8-10).)

Engine oil filter replacement (gasoline engine model)

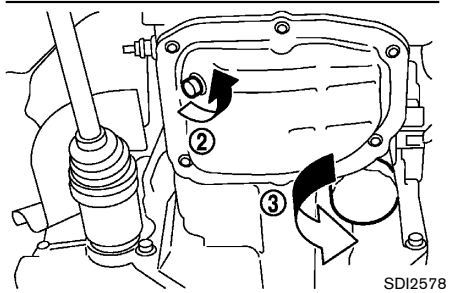
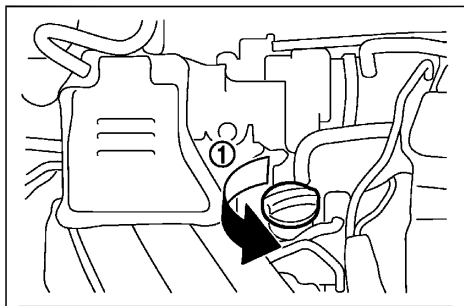

HR12DE engine model

SDI2578

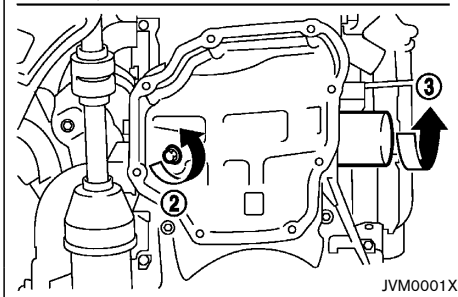
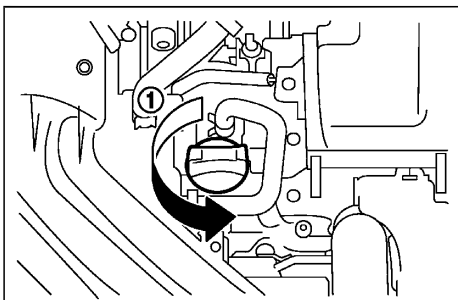

HR15DE engine model

JVM0001X

- ① Oil filler cap
- ② Oil drain plug
- ③ Oil filter

1. Park the vehicle on a level surface and apply the parking brake.
2. Turn the engine off.
3. Drain the engine oil according to the proper procedure. (See "Engine oil replacement (gasoline engine model)" (P.8-11).)

4. Loosen the oil filter with an oil filter wrench.
Depending on the engine model, a special cap type wrench may be required. See a NISSAN dealer for more information.
5. Remove the oil filter by turning it by hand.
6. Wipe the engine oil filter mounting surface with a clean cloth.
Be sure to remove any old gasket remaining on the mounting surface.
7. Apply the new engine oil to the gasket of the new oil filter.
8. Screw in the oil filter until a slight resistance is felt, and then tighten an additional 2/3 of turn to secure the oil filter.

**Oil filter tightening torque:
15 to 20 N·m (11 to 15 ft·lb)**

9. Refill the engine oil. (See "Engine oil replacement (gasoline engine model)" (P.8-11).)
10. Start the engine and check for leakage around the oil filter. Correct as required.
11. Turn the engine off and wait several minutes.
12. Check the engine oil level according to the proper procedure. (See "Checking engine oil level" (P.8-10).)

Engine oil and filter replacement (K9K engine model)

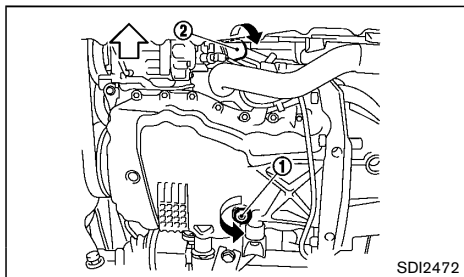

- ① Oil drain plug
- ② Oil filter

1. Place a large drain pan under the drain plug.
2. Remove the drain plug with a wrench.
3. Remove the oil filler cap and completely drain the oil.

If the oil filter is to be changed, remove and replace it at this time.



CAUTION:

Waste oil must be disposed of properly. Check your local regulations.

4. Loosen the oil filter with an oil filter wrench.
5. Remove the oil filter by turning it by hand.
6. Wipe the entire oil filter mounting surface with a clean cloth.

Be sure to remove any old gasket remaining on the mounting surface.

7. Apply new engine oil to the gasket on the new oil filter.
8. Screw in the oil filter until a slight resistance is felt, and then tighten an additional 3/4 of a turn to secure the filter.

Oil filter tightening torque:

16 to 20 N·m (1.6 to 2.0 kg·m, 12 to 15 ft·lb)

9. Clean and reinstall the drain plug and new washer. Securely tighten the drain plug with a wrench. Do not use excessive force.

Drain plug tightening torque:

16 to 24 N·m (1.6 to 2.4 kg·m, 12 to 18 ft·lb)

10. Refill the recommended engine oil and quantity. (See "Recommended fuel/lubricants and capacities" (P.9-2).)
11. Securely install the oil filler cap.
12. Start the engine.
13. Check the drain plug and the oil filter for any sign of leakage.
14. Dispose of the used oil in the proper manner. Check your local regulations.
15. Check the engine oil level according to the proper procedure. (See "Checking engine oil level" (P.8-10).)

PROTECT ENVIRONMENT

It is illegal to pollute drains, watercourses and soil. Use authorized waste collection facilities, including civil amenity sites and garages providing facilities for disposal of used oil and used oil filters. If in doubt, contact your local authority for advice on disposal.

The regulations concerning the pollution of the environment will vary from country to country.

FUEL FILTER (diesel engine model)

DRAINING WATER

Drain water in the fuel filter according to the maintenance log shown in a separate maintenance booklet.

If the water-in-fuel-filter warning light  illuminates while the engine is running, there might be water in the fuel filter.

The fuel filter can be accessed after removing the fuse box and the battery from the vehicle. Therefore, NISSAN recommends that you contact a NISSAN dealer for servicing.

BLEEDING FUEL SYSTEM

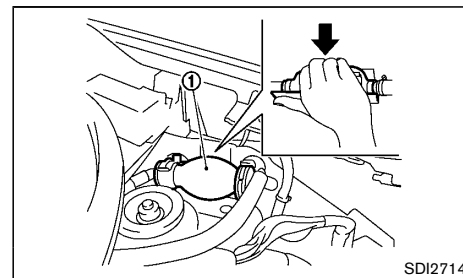

Bleed air out of the fuel system after refilling an empty fuel tank by the following action:

1. Squeeze the priming pump ① located in the engine compartment several times until there is a sudden resistance felt in the pressure, then stop.
2. Crank the engine until it starts. Do not crank the engine for more than 30 seconds.
3. If the engine does not start, stop cranking and repeat step 1 above.

DRIVE BELTS

4. If the engine does not operate smoothly after it has started, race it two or three times.

HR12DE AND HR15DE ENGINE MODEL

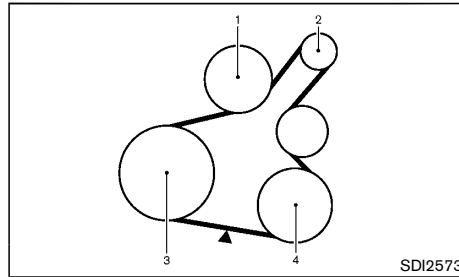

1. Water pump
 2. Alternator
 3. Crankshaft pulley
 4. Air conditioner compressor
- ▼: Tension checking point

Be sure the ignition switch is in the "OFF" position.

Visually inspect each belt for signs of unusual wear, cuts, fraying or looseness. Check regularly for condition and tension. If the belt is in poor condition or loose, have it replaced or adjusted by a NISSAN dealer.

K9K ENGINE MODEL

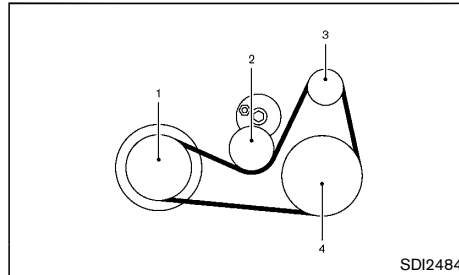

1. Crankshaft pulley
2. Drive belt auto-tensioner
3. Alternator
4. Air conditioner compressor

Be sure the ignition switch is in the "OFF" position.

Visually inspect each belt for signs of unusual wear, cuts, fraying or looseness. Check regularly for condition and tension. If the belt is in poor condition or loose, have it replaced or adjusted by a NISSAN dealer.

SPARK PLUGS (gasoline engine model)

WARNING:

Be sure the engine and ignition switch are off and that the parking brake is applied.

Replace the spark plugs according to the maintenance log shown in a separate maintenance booklet.

If replacement is required, contact a NISSAN dealer.

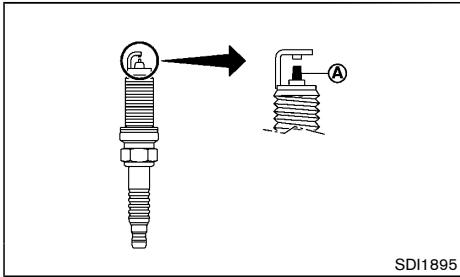

IRIDIUM-TIPPED SPARK PLUGS (if equipped)

It is not necessary to replace the iridium-tipped  spark plugs as frequently as the conventional type of spark plugs. These spark plugs are designed to last much longer than the conventional type of spark plug.

CAUTION:

- **Do not reuse the iridium-tipped spark plugs by cleaning or re-gapping.**
- **Always replace with the recommended iridium-tipped spark plugs.**

PLATINUM-TIPPED SPARK PLUGS (if equipped)

It is not necessary to replace the platinum-tipped  spark plugs as frequently as the conventional type of spark plugs. These spark plugs are designed to last much longer than the conventional type of spark plugs.

CAUTION:

- **Do not reuse the platinum-tipped spark plugs by cleaning or re-gapping.**
- **Always replace with the recommended platinum-tipped spark plugs.**

BRAKES

CHECKING PARKING BRAKE

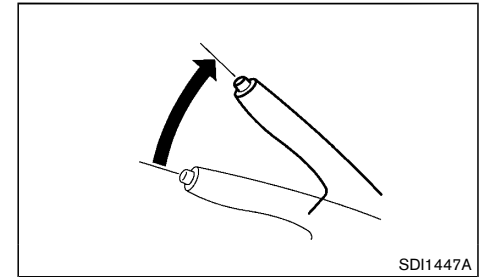

From the released position, pull the parking brake lever up slowly and firmly. If the number of clicks is out of the range listed, see a NISSAN dealer.

For Thailand, Indonesia, Singapore, Australia and Hong Kong:

11 to 12 clicks

Pulling force 196 N (20 kg, 44 lb)

Except for Thailand, Indonesia, Singapore, Australia and Hong Kong:

8 to 9 clicks

Pulling force 196 N (20 kg, 44 lb)

CHECKING FOOT BRAKE PEDAL

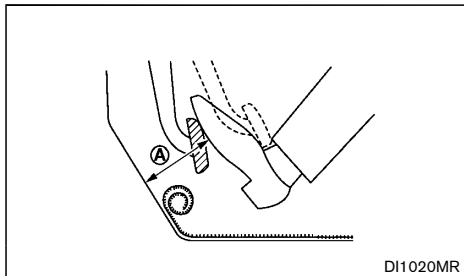

WARNING:

See a NISSAN dealer for a brake system check if the foot brake pedal height does not return to normal.

With the engine running, check the distance (A) between the upper surface of the pedal and the metal floor. If it is out the range listed, see a NISSAN dealer.

(A) : Depressing force
490 N (50 kg, 110 lb)
80 mm (3.15 in) or more

Self-adjusting brakes

Your vehicle is equipped with self-adjusting brakes. The brakes are adjusted by the foot brake pedal operation.

Brake pad wear indicator

The disc brake pads on your vehicle have audible wear indicators. When a brake pad requires replacement, it will make a high pitched scraping or screeching sound when the vehicle is in motion. The noise will be heard whether or not the foot brake pedal is depressed. Have the brakes checked as soon as possible if the wear indicator sound is heard.

Under some driving or climate conditions, occasional brake squeaks, squeals or other noises may be heard. Occasional brake noise during light to moderate stops is normal and does not affect the function or performance of the brake system.

Proper brake inspection intervals should be followed. For additional information, see a separate maintenance booklet.

BRAKE BOOSTER

Check the brake booster function as follows:

1. With the engine off, depress and release the foot brake pedal several times. When the foot brake pedal movement (distance of travel) remains the same from one pedal application to the next, continue on to the next step.
2. While depressing the foot brake pedal, start the engine. The pedal height should drop a little.
3. With the foot brake pedal depressed, stop the engine. Keep the pedal depressed for about 30 seconds. The pedal height should not change.
4. Run the engine for 1 minute without depressing the foot brake pedal, then turn it off. Depress the foot brake pedal several times. The pedal travel distance will decrease gradually with each depression as the vacuum is released from the booster.

If the brakes do not operate properly, have the brakes

checked by a NISSAN dealer.

BRAKE FLUID

WARNING:

- Use only new fluid from a sealed container. Old, inferior, or contaminated fluid may damage the brake system. The use of improper fluids can damage the brake system and affect the vehicle's stopping ability.
- Clean the filler cap before removing.
- Brake fluid is poisonous and should be stored carefully in marked containers out of the reach of children.

CAUTION:

Do not spill the fluid on painted surfaces. This will damage the paint. If fluid is spilled, wash it off with plenty of water immediately.

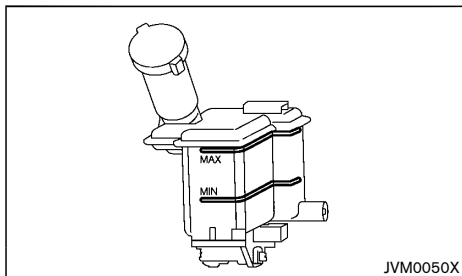

Check the fluid level in the reservoir. If the brake fluid is below the MIN line, the brake warning light will illuminate. Add brake fluid up to the MAX line. (See "Recommended fuel/lubricants and capacities" (P.9-2) for recommended types of brake fluid.)

If the brake fluid must be added frequently, the brake

system should be thoroughly checked by a NISSAN dealer.

CLUTCH FLUID (if equipped)

WARNING:

- Use only new fluid from a sealed container. Old, inferior, or contaminated fluid may damage the clutch system.
- Clean the filler cap before removing.
- Clutch fluid is poisonous and should be stored carefully in marked containers out of the reach of children.

CAUTION:

Do not spill the clutch fluid on painted surfaces. This will damage the paint. If clutch fluid is spilled, wash it off with plenty of water immediately.

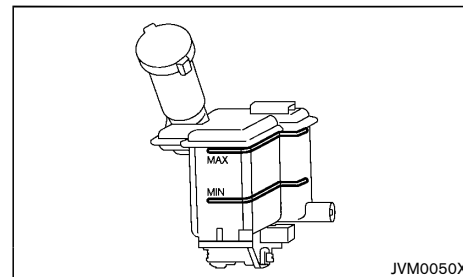

Check the fluid level in the reservoir. If the fluid is below the MIN line, add fluid up to the MAX line. (See "Recommended fuel/lubricants and capacities" (P.9-2) for the recommended types of fluid.)

If the fluid must be added frequently, the clutch system should be thoroughly checked by a NISSAN dealer.

AUTOMATIC TRANSMISSION FLUID (ATF) (if equipped)

Contact a NISSAN dealer if checking or replacement is required.

CAUTION:

- Use only Genuine NISSAN Matic S ATF. Do not mix with other fluids.
- Using automatic transmission fluid other than Genuine NISSAN Matic S ATF will cause deterioration in driveability and transmission durability, and may damage the transmission, which is not covered by the warranty.

CONTINUOUSLY VARIABLE TRANSMISSION (CVT) FLUID (if equipped)

Contact a NISSAN dealer if checking or replacement is required.

CAUTION:

- Use only the specified transmission fluid. Do not mix with other fluids. (See “Recommended fuel/lubricants and capacities” (P.9-2).)
- Using transmission fluid other than the specified ones will cause deterioration in driveability and transmission durability, and may damage the transmission, which is not covered by the warranty.

AIR CLEANER FILTER

WARNING:

Operating the engine with the air cleaner filter off can cause you or others to be burned. The air cleaner filter not only cleans the intake air, it also stops flame if the engine backfires. If the air cleaner filter is not installed and the engine backfires, you could be burned. Never drive with the air cleaner filter off. Be cautious working on the engine when the air cleaner filter is off.

HR12DE AND HR15DE ENGINE MODEL

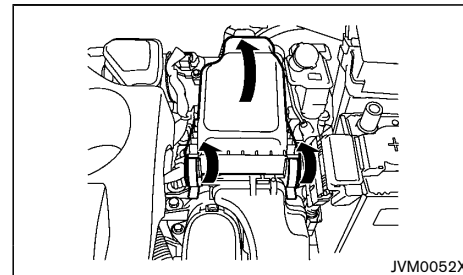

To remove the filter, release the lock pins and pull the unit upward.

The viscous paper type filter element should not be cleaned and reused.

The dry paper type filter element may be cleaned and reused.

Replace the air cleaner filter according to the maintenance log shown in a separate maintenance booklet.

WIPER BLADES

K9K ENGINE MODEL

Contact a NISSAN dealer if maintenance or replacement is required.

Replace the air cleaner filter according to the maintenance log shown in a separate maintenance booklet.

WINDSHIELD WIPER BLADES

Cleaning

If the windshield does not become clear after using the windshield washer or if the wiper blades chatter when operating the windshield wipers, wax or other materials may be on the windshield and/or wiper blades.

Clean the outside of the windshield surface with a washer solution or mild detergent. Your windshield is clean if beads do not form when rinsing with water.

Clean the blade by wiping it with a cloth soaked in a washer solution or a mild detergent. Rinse the blade with water. If your windshield is still not clear after cleaning the blades and using the wipers, replace the blades.

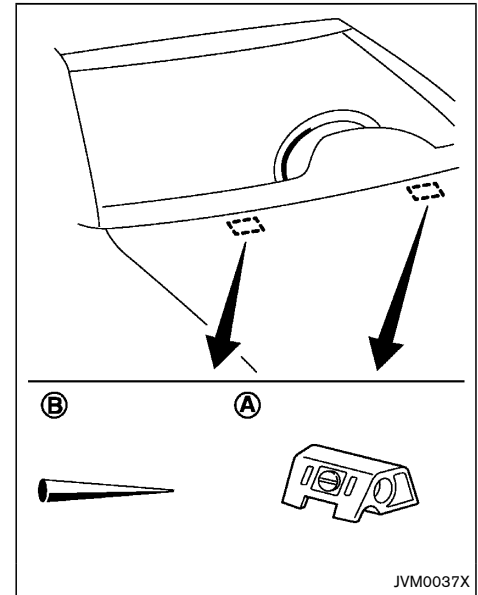

Be careful not to clog the washer nozzle (A). This may cause improper windshield washer operation. If the nozzle is clogged, remove any objects with a needle or small pin (B). Be careful not to damage the nozzle.

Replacing

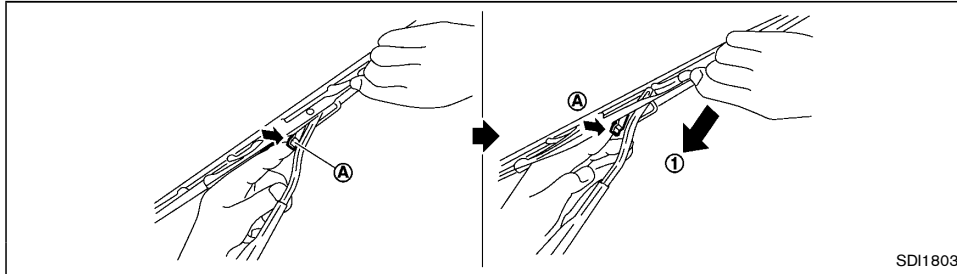

1. Lift the wiper arm away from the windshield.
2. Push and hold the release tab (A), and then move the wiper blade down the wiper arm to remove (1).
3. Remove the wiper blade.
4. Insert the new wiper blade onto the wiper arm until it clicks into place.



CAUTION:

- After wiper blade replacement, return the wiper arm to its original position. Otherwise the wiper arm or the engine hood may be scratched and may cause damage.
- Worn windshield wiper blades can damage the windshield and impair driver vision.

WINDOW WASHER FLUID

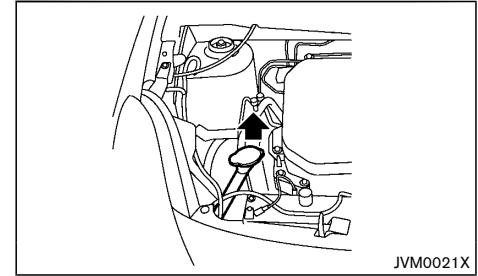

WARNING:







Anti-freeze is poisonous and should be stored carefully in marked containers out of the reach of children.

Check the fluid level in the window washer reservoir. If the fluid level is low, add window washer fluid.

Add a washer solvent to the water for better cleaning. In the winter season, add a windshield washer anti-freeze. Follow the manufacturer's instructions for the mixture ratio.

BATTERY

VEHICLE BATTERY

Caution symbols for battery			⚠ WARNING
①		No smoking, No exposed flames, No sparks	Never smoke around battery. Never expose battery to open flames or electrical sparks.
②		Shield eyes	Handle the battery cautiously. Always wear eye protection glasses to protect against explosion or battery acid.
③		Keep away from children	Never allow children to handle battery. Keep the battery out of the reach of children.
④		Battery acid	Do not allow battery fluid to contact your skin, eyes, fabrics, or painted surfaces. After handling the battery or battery cap, immediately wash your hands thoroughly. If the battery fluid gets into your eyes, or onto your skin or clothing, flush with water immediately for at least 15 minutes and seek medical attention. Battery fluid is acid. If the battery fluid gets into your eyes or onto your skin, it could cause loss of your eyesight or burns.
⑤		Note operating instructions	Before handling the battery, read this instruction carefully to ensure correct and safe handling.
⑥		Explosive gas	Hydrogen gas, generated by battery fluid, is explosive.

SDI1573



WARNING:

Do not operate the vehicle if the fluid in the battery is low. Low battery fluid can cause a higher load on the battery which can generate heat, reduce battery life, and in some cases lead to an explosion.

Checking battery fluid level

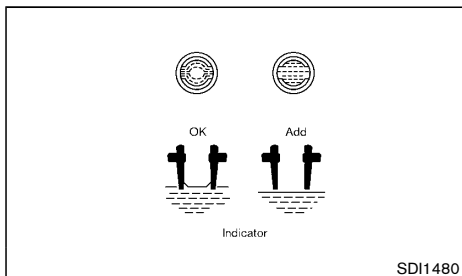
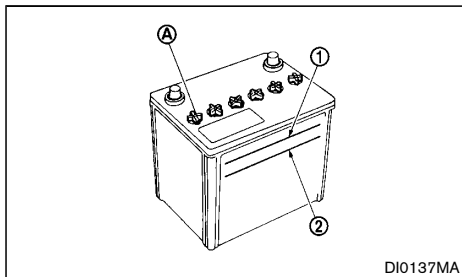

Check the fluid level in each cell. The battery fluid level should be between the UPPER LEVEL ① and LOWER LEVEL ② lines.

If it is necessary to add fluid, add only demineralized/distilled water to bring the level to the indicator in each filler opening. Do not overfill.

1. Remove the cell plugs (A), if equipped.
2. Add demineralized/distilled water up to the UPPER LEVEL ① line.
3. Replace and tighten the cell plugs.

- Vehicles operated in high temperatures or under severe conditions require frequent checks of the battery fluid level.
- Keep the battery surface clean and dry. Clean the battery with a solution of baking soda and water.
- Make certain the terminal connections are clean and securely tightened.
- If the vehicle is not to be used for more than 30 days, disconnect the negative (-) battery terminal cable to prevent battery discharge.

For model with Idling Stop System, see "Jump starting" (P.6-8)

Jump starting

If jump starting is necessary, see "Jump starting" (P.6-8). If the engine does not start by jump starting or the battery does not charge, the battery may have to be replaced. Contact a NISSAN dealer for replacing the battery.

REMOTE CONTROLLER BATTERY

Battery replacement



CAUTION:

- **Be careful not to allow children to swallow the battery and removed parts.**
- **An improperly disposed battery can harm the environment. Always confirm local regulations for battery disposal.**
- **When changing batteries, do not let dust or oil get on the components.**
- **There is danger of explosion if lithium battery is incorrectly replaced. Replace only with the same or equivalent type.**

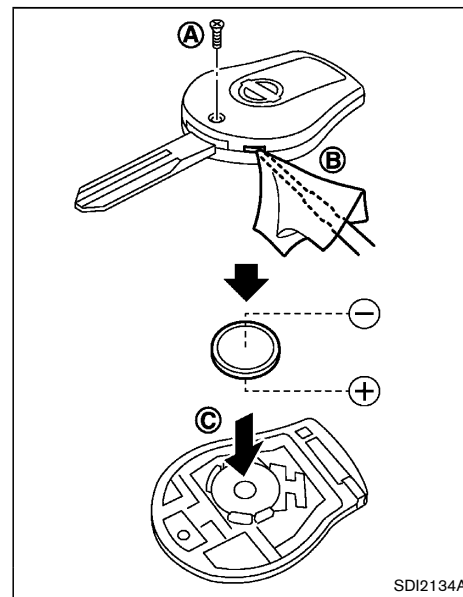

To replace the battery:

1. Remove the screw (A).
2. Insert a small screwdriver into the slit of the corner (B) and twist it to separate the upper part from the lower part. Use a cloth to protect the casing.
3. Replace the battery with a new one.

Recommended battery: CR1620 or equivalent

- Do not touch the internal circuit and electric terminals as doing so could cause a malfunction.

- Make sure that the + side faces the bottom of the case (C).

4. Close the lid and install the screw securely.
5. Operate the buttons to check its operation.

See a NISSAN dealer if you need assistance for replacement.

INTELLIGENT KEY BATTERY

Battery replacement

CAUTION:

- **Be careful not to allow children to swallow the battery and removed parts.**
- **An improperly disposed battery can harm the environment. Always confirm local regulations for battery disposal.**
- **When changing batteries, do not let dust or oil get on the components.**
- **There is danger of explosion if lithium battery is incorrectly replaced. Replace only with the same or equivalent type.**

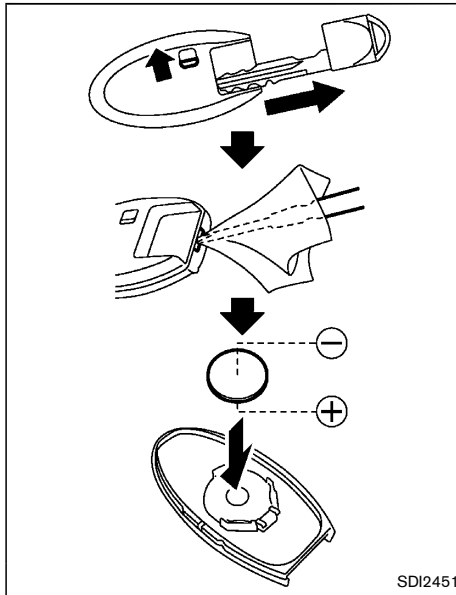

To replace the battery:

1. Release the lock knob at the back of the Intelligent Key and remove the mechanical key.
2. Insert a small screwdriver into the slit of the corner and twist it to separate the upper part from the lower part. Use a cloth to protect the casing.
3. Replace the battery with a new one.
 - Recommended battery: CR2025 or equivalent
 - Do not touch the internal circuit and electric terminals as doing so could cause a malfunction.

- Make sure that the ⊕ side faces the bottom of the case.

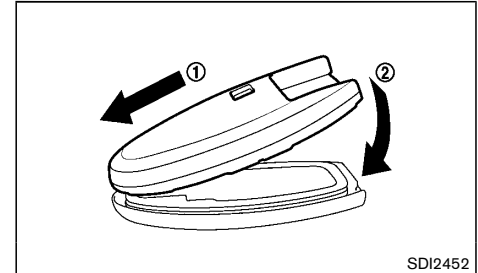

4. Align the tips of the upper and lower parts (1), and then push them together until it is securely closed (2).
 5. Operate the buttons to check its operation.
- See a NISSAN dealer if you need assistance for replacement.

VARIABLE VOLTAGE CONTROL SYSTEM (if equipped)



CAUTION:

- Do not ground accessories directly to the battery terminal. Doing so will bypass the variable voltage control system and the vehicle battery may not charge completely.
- Use electrical accessories with the engine running to avoid discharging the vehicle battery.

Your vehicle is equipped with a variable voltage control system. This system measures the amount of electrical discharge from the battery and controls voltage generated by the alternator.

FUSES

ENGINE COMPARTMENT

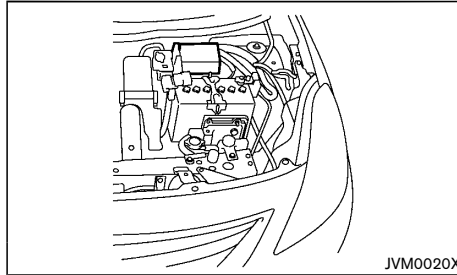

For checking and/or replacing, see a NISSAN dealer.

Fusible links

If any electrical equipment does not operate and the fuses are in good condition, check the fusible links. If any of these fusible links are melted, replace only with genuine NISSAN parts.

PASSENGER COMPARTMENT

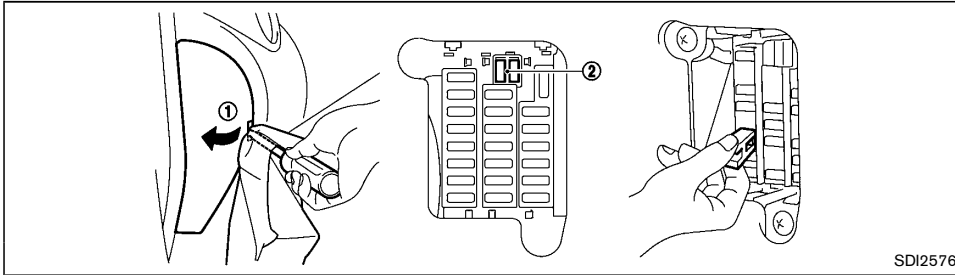

SDI2576

For all models

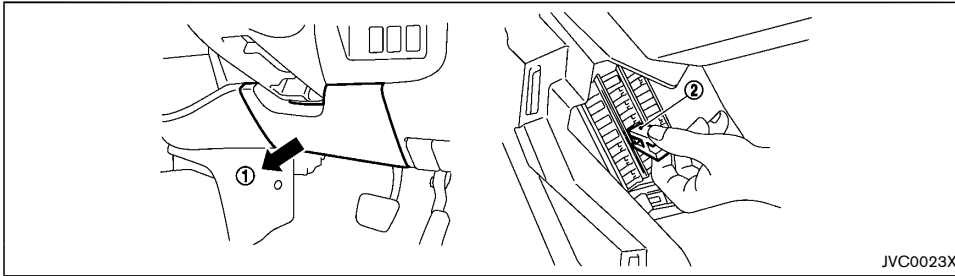

JVC0023X

For Idling Stop System (if equipped)



CAUTION:

Never use a fuse of a higher or lower amperage rating than that specified on the fuse box cover. This could damage the electrical system or cause a fire.

If any electrical equipment does not operate, check for an open fuse.

1. Be sure the ignition switch is in the "OFF" position.
2. Be sure the headlight switch is in the "OFF" position.
3. Remove the fuse box cover ① with a suitable tool.
4. Locate the fuse that needs to be replaced.
5. Remove the fuse using the fuse puller ② .

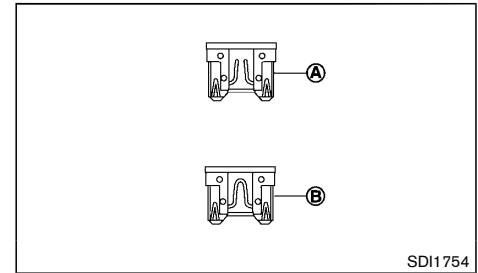

SDI1754

6. If the fuse is open ① , replace it with a new fuse ② .

If the new fuse also opens, after installing, have the electrical system checked, and if necessary repaired, by a NISSAN dealer.

Extended storage fuse switch (if equipped)

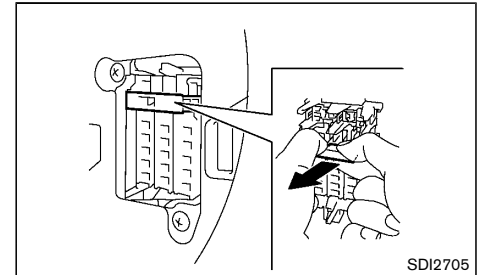

SDI2705

If any electrical equipment does not operate, remove the extended storage fuse switch and check for an open fuse.

NOTE:

If the extended storage fuse switch malfunctions, or if the fuse is open, it is not necessary to replace the switch. In this case, remove the extended storage fuse switch and replace it with a new fuse of the same rating.

How to remove the extended storage fuse switch:

1. To remove the extended storage fuse switch, be sure the ignition switch is in the "OFF" or "LOCK" position.
2. Be sure the headlight switch is in the "OFF" position.
3. Remove the fuse box cover.
4. Pinch the storage fuse switch and pull it in the direction illustrated.

LIGHTS

HEADLIGHTS

Replacing halogen headlight bulb

The halogen headlight is a semi-sealed beam type which uses replaceable headlight (halogen) bulbs. They can be replaced from inside the engine compartment without removing the headlight assembly.



CAUTION:

- High-pressure halogen gas is sealed inside the bulb. The bulb may break if the glass envelope is scratched or the bulb is dropped.

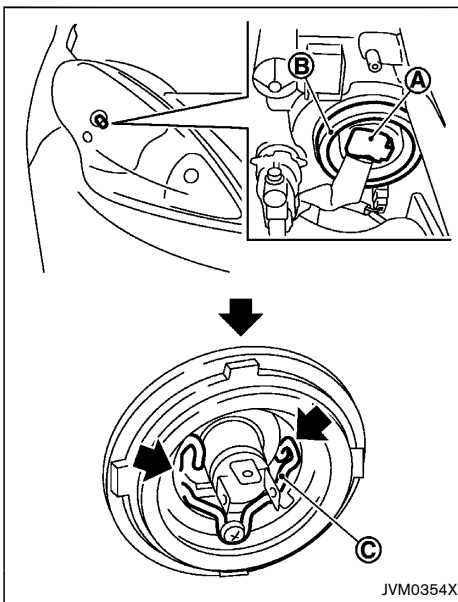

1. Disconnect the battery negative cable.
2. Disconnect the electrical connector (A) from the rear end of the bulb.
3. Pull off the rubber cap (B).
4. Push and turn the retaining pin (C) to loosen it.
5. Remove the headlight bulb. Do not shake or rotate the bulb when removing it.
6. Install the new bulb in the reverse order of removal.



CAUTION:

- When handling the bulb, do not touch the glass envelope.
- Use the same number and wattage as originally installed:

High beam bulb: 60W (H4)

Low beam bulb: 55W (H4)

- Do not leave the bulb out of the headlight reflector for a long period of time as dust, moisture and smoke may enter the headlight body and affect the performance of the headlight.

Aiming adjustment is not necessary if only the bulbs are replaced. When aiming adjustment is necessary, contact a NISSAN dealer.

Fog may temporarily form inside the lens of the exterior lights in the rain or in a car wash. A temperature difference between the inside and the outside of the lens causes the fog. This is not a malfunction. If large drops of water collect inside the lens, contact a NISSAN dealer.

EXTERIOR LIGHTS

Item	Wattage (W)
Front turn signal light	21
Front clearance light	5
Front fog light (if equipped)	55
Daytime running light (if equipped)	LED*1
Side turn signal light	5
Rear combination lights	
Turn signal light	21
Stop/Tail light	21/5
Reverse light	21
Rear fog light (if equipped)	21
High-mounted stop light	LED*2 16*3
License plate light	5

*1: See a NISSAN dealer for replacement.

*2: For model with rear spoiler. See a NISSAN dealer for replacement.

*3: For model without rear spoiler.

INTERIOR LIGHTS

Item	Wattage (W)
Map light (if equipped)	5
Room light	5
Trunk light (if equipped)	3.4

LIGHT LOCATIONS

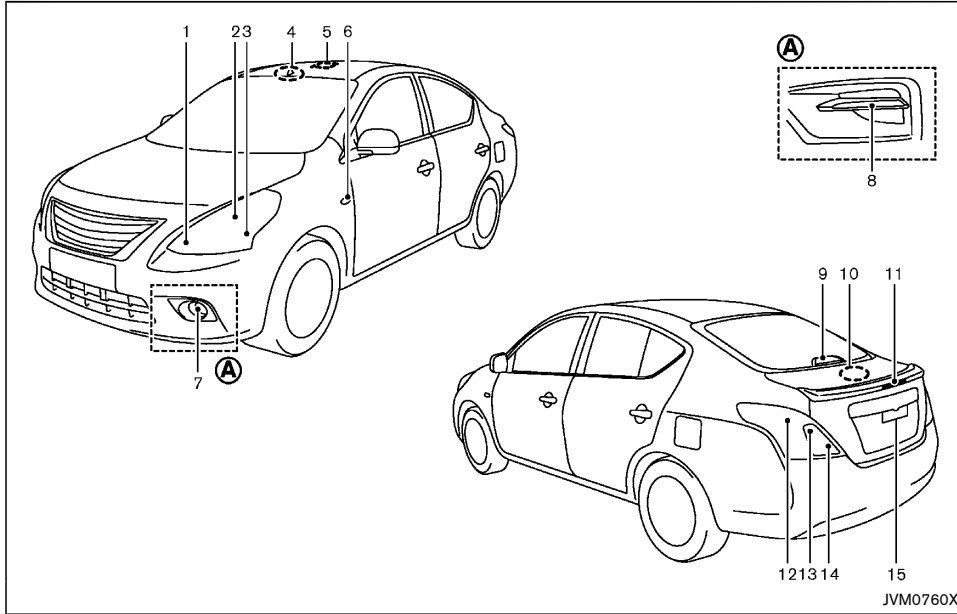

- | | |
|--|---|
| 1. Front turn signal light | 9. High-mounted stop light*1 |
| 2. Headlight | 10. Trunk light (if equipped) |
| 3. Clearance light | 11. High-mounted stop light*2 |
| 4. Map light (if equipped) | 12. Stop/tail light |
| 5. Room light | 13. Rear turn signal light |
| 6. Side turn signal light | 14. Reverse light or Rear fog light (if equipped, right side)*3 |
| 7. Front fog light (if equipped) | 15. License plate light |
| 8. Daytime running light (if equipped) | |

*1: For model without rear spoiler

*2: For model with rear spoiler

*3: For model with rear fog light

Replacement procedures

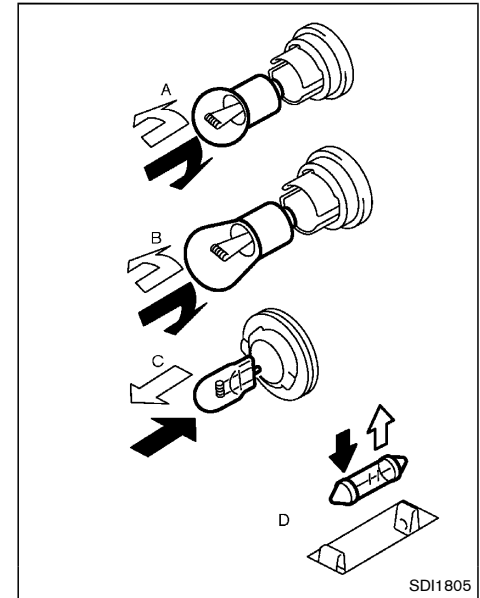

⇨: REMOVE
⇩: INSTALL

All other lights are either type A, B, C or D. When replacing a bulb, first remove the lens and/or cover.

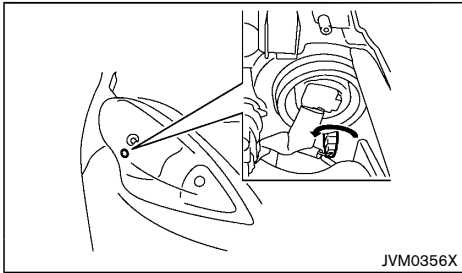

Clearance light

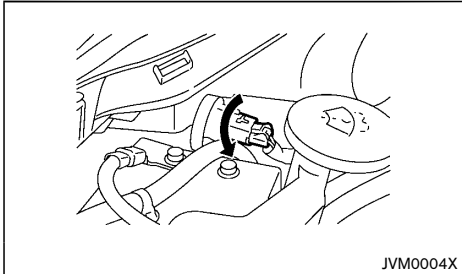

Front turn signal light

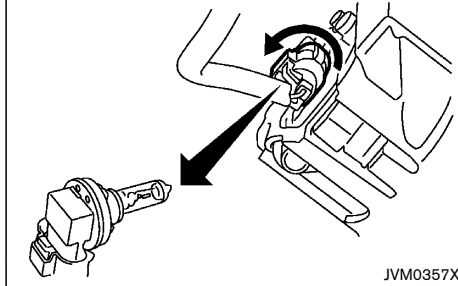
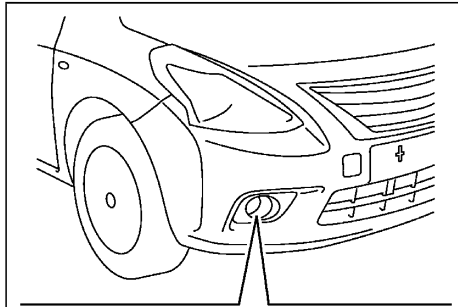

Front fog light (if equipped)

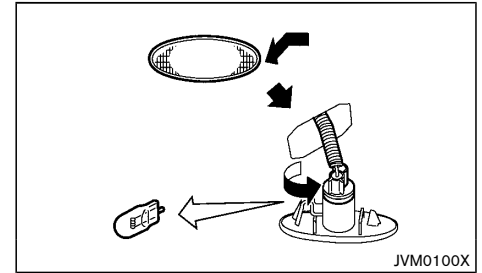

Side turn signal light

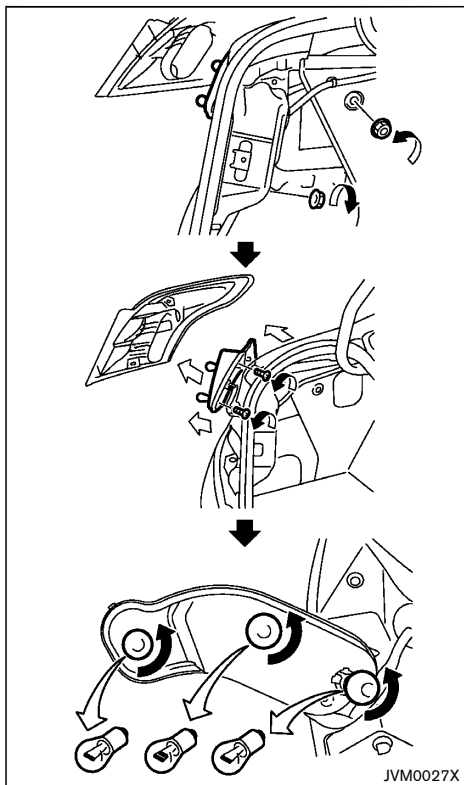

Rear combination light

JVM0027X

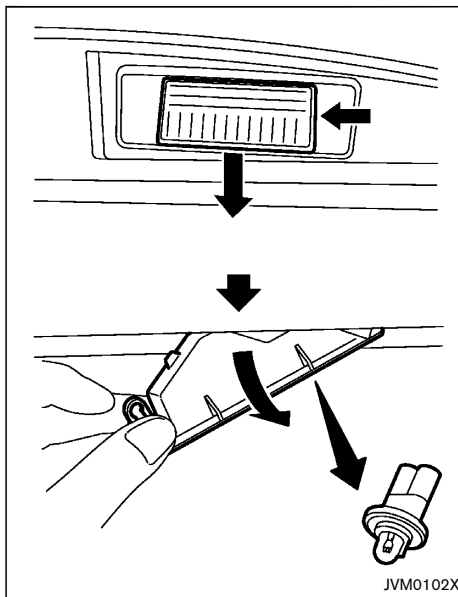

License plate light

JVM0102X

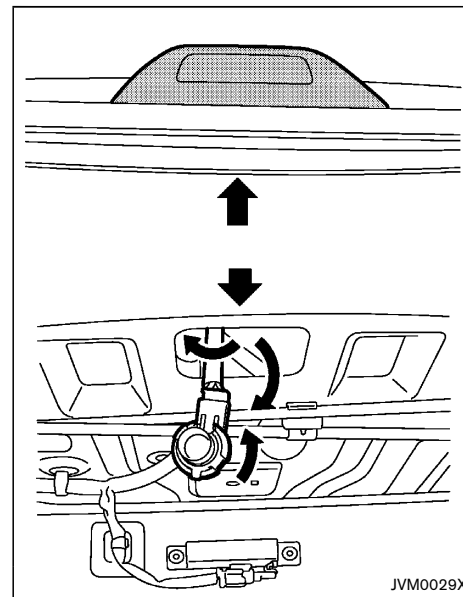

High-mounted stop light (model without rear spoiler)

To replace the high-mounted stop light bulb:

1. Open the trunk lid.
2. Remove the bulb socket and then replace the bulb.
3. Install in the reverse order of removal.

JVM0029X

TIRES AND WHEELS

If you have a flat tire, see “Flat tire” (P.6-2).

TIRE INFLATION PRESSURE

Periodically check the pressure of the tires, including the spare. An incorrect tire pressure may adversely affect tire life and vehicle handling. The tire pressure should be checked when tires are COLD. Tires are considered COLD after the vehicle has been parked for 3 or more hours, or driven less than 1.6 km (1 mile). COLD tire pressures are shown on the tire placard. (See “Vehicle identification” (P.9-8) for the location of the tire placard.)

Insufficient pressure can lead to an overheating of the tire and subsequent internal damage. At high speeds, this could result in tread separation and even bursting of the tire.

TYPES OF TIRES

CAUTION:

When changing or replacing tires, be sure all four tires are of the same type (that is, summer, all season or snow) and construction. A NISSAN dealer may be able to help you with information about tire type, size, speed rating and availability.

Replacement tires may have a lower speed rating than the factory equipped tires, and they may not match the potential maximum vehicle speed. Never exceed the maximum speed rating of the tire.

All season tires

NISSAN specifies all season tires on some models to provide good performance all year, including snowy and icy road conditions. All season tires are identified by ALL SEASON and/or M&S on the tire sidewall. Snow tires have better snow traction than all season tires and may be more appropriate in some areas.

Summer tires

NISSAN specifies summer tires on some models to provide superior performance on dry roads. Summer tire performance is substantially reduced in snow and ice. Summer tires do not have the tire traction rating M&S on the tire sidewall.

If you plan to operate your vehicle in snowy or icy conditions, NISSAN recommends the use of snow or all season tires on all four wheels.

Snow tires

If snow tires are needed, it is necessary to select tires equivalent in size and load rating to the original equipment tires. If you do not, it can adversely affect the safety and handling of your vehicle.

Generally, snow tires have lower speed ratings than factory equipped tires and may not match the potential maximum vehicle speed. Never exceed the maximum speed rating of the tire. If you install snow tires, they must be the same size, brand, construction and tread pattern on all four wheels.

For additional traction on icy roads, studded tires may be used. However, some states and provinces prohibit their use. Check local, state and provincial laws before installing studded tires. Skid and traction capabilities of studded snow tires on wet or dry surfaces may be poorer than that of non-studded snow tires.

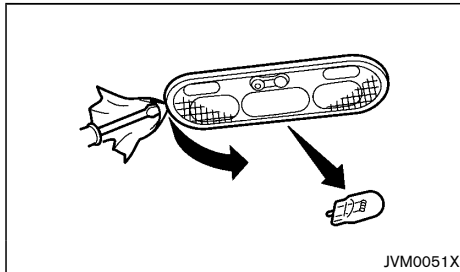

Map light (if equipped) and Room light

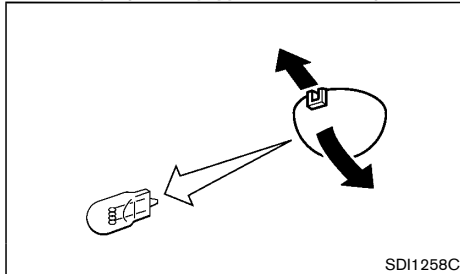

Trunk light (if equipped)

TIRE CHAINS

Use of tire chains may be prohibited according to location. Check the local laws before installing tire chains. When installing tire chains, make sure that they are of proper size for the tires on your vehicle and are installed according to the chain manufacturer's instructions.

Use chain tensioners when recommended by the tire chain manufacturer to ensure a tight fit. Loose end links of the tire chains must be secured or removed to prevent the possibility of whipping action damage to the fenders or underbody. If possible, avoid fully loading your vehicle when using tire chains. In addition, drive at a reduced speed. Otherwise, your vehicle may be damaged and/or vehicle handling and performance may be adversely affected.

Tire chains must be installed only on the front wheels and not on the rear wheels. Never install tire chains on a temporary-use spare tire (if equipped). Do not use the chains on dry roads.

TIRE ROTATION

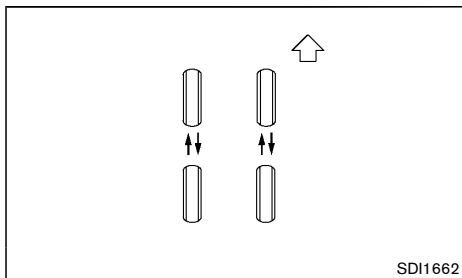

NISSAN recommends that tires be rotated every 10,000 km (6,000 miles). However, the timing for tire rotation may vary according to your driving habits and

the road surface conditions. (See "Flat tire" (P.6-2) for the tire replacement.)



WARNING:

- **After rotating the tires, adjust the tire pressure.**
- **Retighten the wheel nuts when the vehicle has been driven for 1,000 km (600 miles) (also in cases of a flat tire, etc.).**
- **Do not include the temporary-use spare tire (if equipped) in tire rotation.**
- **Incorrect tire selection, fitting, care or maintenance can affect vehicle safety with risk of accident and injury. If in doubt, consult a NISSAN dealer or the tire manufacturer.**

TIRE WEAR AND DAMAGE

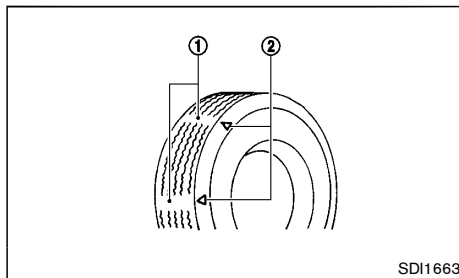

- ① Wear indicator
- ② Wear indicator location mark

Tires should be periodically inspected for wear, cracking, bulging or objects caught in the tread. If excessive wear, cracks, bulging or deep cuts are found, the tire should be replaced immediately.

The original tires have a built-in tread wear indicator.

When the wear indicator is visible, the tire should be replaced.

Improper service of a spare tire may result in serious personal injury. If it is necessary to repair the spare tire, contact a NISSAN dealer.

TIRE AGE

Never use a tire over six years old, regardless of whether it has been used or not.

Tires degrade with age as well as with the vehicle usage. Have your tires checked and balanced often by a repair shop or, if you prefer, a NISSAN dealer.

CHANGING TIRES AND WHEELS



WARNING:

Do not install a deformed wheel or tire even if it has been repaired. Such wheels or tires could have structural damage and could fail without warning.

When replacing a tire, use the same size, speed rating and load carrying capacity as originally equipped. (See "Tires and wheels" (P.9-7) for recommended types and sizes of tires and wheels.) The use of tires other than those recommended or the mixed use of tires of different brands, construction (bias, bias-belted, or radial), or tread patterns can adversely affect the ride, braking, handling, ground clearance, body-to-tire clearance, snow chain clearance, speedometer calibration, headlight aim and bumper height. Some of these effects may lead to accidents and could result in serious personal injury.

If the wheels are changed for any reason, always replace with wheels which have the same offset dimension. Wheels of a different offset could cause early tire wear, possibly degraded vehicle handling

characteristics and/or interference with the brake discs/drums. Such interference can lead to decreased braking efficiency and/or early brake pad/shoe wear.

WHEEL BALANCE

Unbalanced wheels may affect vehicle handling and tire life. Even with regular use, wheels can get out of balance. Therefore, they should be balanced as required.

SPARE TIRE

Conventional spare tire (if equipped)

A standard tire (the same size as the road wheels) is supplied with your vehicle.

Temporary-use spare tire (if equipped)

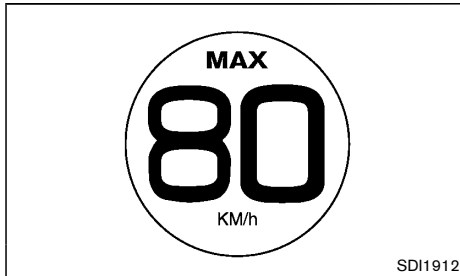

Spare tire label (if equipped)

Observe the following precautions if the spare tire must be used, otherwise your vehicle could be damaged or involved in an accident.



CAUTION:

- **The spare tire should be used only for emergency. It should be replaced by the standard tire at the first opportunity.**

- **Drive carefully while the spare tire is installed.**
- **Avoid sharp turns and abrupt braking while driving.**
- **Periodically check the spare tire inflation pressure, and always keep it at 420 kPa (4.2 bar, 60 psi). (T125/70D15 95M tire)**
- **Do not drive your vehicle at speeds faster than 80 km/h (50 MPH).**
- **Do not use tire chains on a spare tire. Tire chains will not fit properly on the spare tire and may cause damage to the vehicle.**
- **When driving on roads covered with snow or ice, the spare tire should be used on the rear wheel and the original tire used on the front wheels (drive wheels). Use tire chains only on the front two original tires.**
- **Tire tread of the spare tire will wear at a faster rate than the original tire. Replace the spare tire as soon as the tread wear indicators appear. (T125/70D15 95M tire)**
- **Because the spare tire is smaller than the original tire, ground clearance is reduced. To avoid damage to the vehicle do not drive over obstacles. Also do not drive the vehicle through an automatic car wash since it may get caught.**
- **Do not use the spare tire on other vehicles.**
- **Do not use more than one spare tire at the same time.**

Emergency tire puncture repair kit (if equipped)

See "Repairing flat tire (for model with emergency tire puncture repair kit)" (P.6-5) for more details.

MEMO

9 Technical information

Recommended fuel/lubricants and capacities	9-2	Certification label (if equipped)	9-9
Fuel information	9-4	Tire placard	9-9
Recommended SAE viscosity number	9-4	Air conditioner specification label	9-9
Air conditioner system refrigerant and lubricant	9-5	Uniform tire Quality Grading (if equipped)	9-9
Engine	9-6	Treadwear	9-9
Tires and wheels	9-7	Traction AA, A, B and C	9-9
Dimensions	9-7	Temperature A, B and C	9-10
When travelling or registering in another country	9-8	Radio approval number and information	9-10
Vehicle identification	9-8	For Thailand	9-10
Vehicle identification plate	9-8	For Singapore	9-10
Built date plate (for Australia and New Zealand)	9-8	For Indonesia	9-10
Vehicle identification number (chassis number)	9-8	For Nigeria	9-11
Vehicle identification number (VIN) plate	9-8	For Oman	9-11
Engine serial number	9-8	For the United Arab Emirates	9-11

RECOMMENDED FUEL/ LUBRICANTS AND CAPACITIES

The following are approximate capacities. The actual refill quantities may be slightly different. When refilling, follow the procedures instructed in the “8. Maintenance and do-it-yourself” section to determine the proper refill capacity.

			Approximate Capacity		Recommended Fuel/Lubricants
			Metric Measure	Imperial Measure	
Fuel			41 L	9 gal	See “Fuel information” (P.9-4).
Engine oil	HR12DE HR15DE	including oil filter	3.0 L	2-5/8 qt	<p>The approximate capacities listed are for refilling during an engine oil change. For additional information, see “Changing engine oil and oil filter” (P.8-10).</p> <ul style="list-style-type: none"> • Genuine NISSAN engine oil • API grade: SL, SM or SN • ILSAC grade: GF-3, GF-4 or GF-5 <p>For additional information, see “Recommended SAE viscosity number” (P.9-4).</p> <ul style="list-style-type: none"> • Genuine NISSAN engine oil • ACEA B1/B5 <p>For additional information, see “Recommended SAE viscosity number” (P.9-4).</p> <ul style="list-style-type: none"> • Genuine NISSAN Engine Coolant or equivalent in its quality • Use Genuine NISSAN Engine Coolant or equivalent in its quality, in order to avoid possible aluminum corrosion within the engine cooling system caused by the use of non-genuine engine coolant. • Note that any repairs for the incidents within the engine cooling system while using non-genuine engine coolant may not be covered by the warranty even if such incidents occurred during the warranty period.
		excluding oil filter	2.8 L	2-1/2 qt	
	K9K	including oil filter	4.4 L	3-7/8 qt	
		excluding oil filter	4.2 L	3-3/4 qt	
Cooling system (including reservoir tank capacity 0.7 L)	HR12DE	MT model	5.7 L	5 qt	<ul style="list-style-type: none"> • Using automatic transmission fluid other than Genuine NISSAN Matic S ATF will cause deterioration in driveability and automatic transmission durability, and may damage the automatic transmission, which is not covered by the warranty.
		CVT model	5.8 L	5-1/8 qt	
	HR15DE	MT model	5.6 L	4-7/8 qt	
		AT model	6.0 L	5-1/4 qt	
	K9K	CVT model	6.4 L	5-5/8 qt	
			7.6 L	6-3/4 qt	
Automatic Transmission (AT) fluid			—	—	<ul style="list-style-type: none"> • Genuine NISSAN Matic S ATF • Using automatic transmission fluid other than Genuine NISSAN Matic S ATF will cause deterioration in driveability and automatic transmission durability, and may damage the automatic transmission, which is not covered by the warranty.
Continuously Variable Transmission (CVT) fluid			—	—	<p>Except for Hong Kong, India and Thailand</p> <ul style="list-style-type: none"> • Genuine NISSAN CVT Fluid NS-2 • Use only Genuine NISSAN CVT Fluid NS-2. Using transmission fluid other than Genuine NISSAN CVT Fluid NS-2 will damage the CVT, which is not covered by the warranty. <p>For Hong Kong, India and Thailand</p> <ul style="list-style-type: none"> • Genuine NISSAN CVT Fluid NS-3 • Use only Genuine NISSAN CVT Fluid NS-3. Using transmission fluid other than Genuine NISSAN CVT Fluid NS-3 will damage the CVT, which is not covered by the warranty.

		Approximate Capacity		Recommended Fuel/Lubricants
		Metric Measure	Imperial Measure	
Manual Transmission (MT) gear oil	HR12DE HR15DE	—	—	<ul style="list-style-type: none"> Genuine NISSAN Manual Transmission Fluid (MTF) HQ Multi 75W-85, or equivalent If Genuine NISSAN Manual Transmission Fluid (MTF) HQ Multi is not available, API GL-4, Viscosity SAE 75W-85 may be used as a temporary replacement. However, use Genuine NISSAN Manual Transmission Fluid (MTF) HQ Multi as soon as it is available.
	K9K	—	—	<ul style="list-style-type: none"> Genuine NISSAN Manual Transmission Fluid (MTF) Chevron Texaco ETL8997B 75W-80, or equivalent If Genuine NISSAN Manual Transmission Fluid (MTF) Chevron Texaco ETL8997B is not available, API GL-4, Viscosity SAE 75W-80 may be used as a temporary replacement. However, use Genuine NISSAN Manual Transmission Fluid (MTF) Chevron Texaco ETL8997B as soon as it is available.
Brake and clutch fluid	For Thailand, Indonesia, Singapore, Hong Kong and Australia		Refill to the proper fluid level according to the instructions in the "8. Maintenance and do-it-yourself" section.	<ul style="list-style-type: none"> Genuine NISSAN Brake Fluid or equivalent DOT 3
	Except for Thailand, Indonesia, Singapore, Hong Kong and Australia	Brake fluid		<ul style="list-style-type: none"> Genuine NISSAN Brake Fluid or equivalent DOT 3 or DOT 4 Never mix different types of fluids (DOT 3 and DOT 4).
		Clutch fluid		<ul style="list-style-type: none"> Genuine NISSAN DOT 4 Brake Fluid or equivalent
Multi-purpose grease		—	—	<ul style="list-style-type: none"> NLGI No. 2 (Lithium soap base)
Air conditioner system refrigerant		—	—	<ul style="list-style-type: none"> HFC-134a (R-134a)
Air conditioner system lubricants		—	—	<ul style="list-style-type: none"> NISSAN A/C System Oil Type R or equivalent

FUEL INFORMATION

Gasoline engine (model with three-way catalyst)



CAUTION:

Do not use leaded gasoline. Using leaded gasoline will damage the three-way catalyst.

Except for Iraq and Thailand:

Use UNLEADED REGULAR gasoline with an octane rating of at least 91 (RON).

For Iraq:

Use UNLEADED PREMIUM gasoline with an octane rating of at least 91 (RON).

For Thailand:

Use UNLEADED REGULAR gasoline or gasohol (up to E20*) with an octane rating of at least 91 (RON).

*: Gasohol is alcohol blended gasoline. For example, "E20" is a mixture of approximately 20% fuel ethanol and 80% unleaded gasoline.

Diesel engine

Diesel fuel of at least 50 octane.

* If two types of diesel fuel are available, use summer or winter fuel properly according to the following temperature conditions.

- Above -7°C (20°F) ... Summer type diesel fuel.
- Below -7°C (20°F) ... Winter type diesel fuel.



CAUTION:

- **Do not use home heating oil, gasoline or other alternate fuels in your diesel engine. The use of those or adding those to diesel fuel can cause engine damage.**

- **Do not use summer fuel at temperatures below -7°C (20°F). The cold temperatures will cause wax to form in the fuel. As a result, it may prevent the engine from running smoothly.**

RECOMMENDED SAE VISCOSITY NUMBER

Gasoline engine oil

Except for Thailand:

10W-30 is preferable.

If 10W-30 is not available, select the viscosity, from the chart below, that is suitable for the outside temperature range.

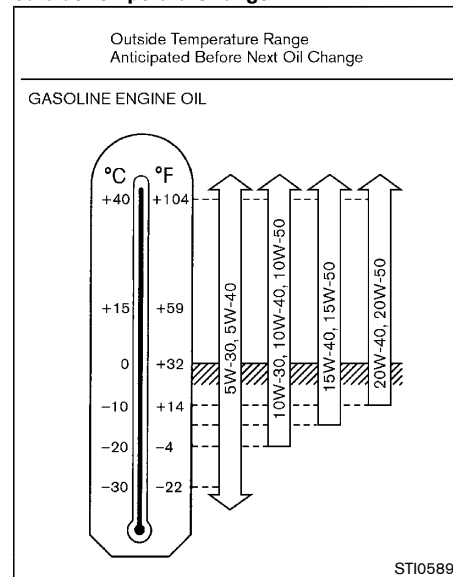

For Thailand:

0W-20 is preferable.

If 0W-20 is not available, select the viscosity, from the chart below, that is suitable for the outside temperature range.

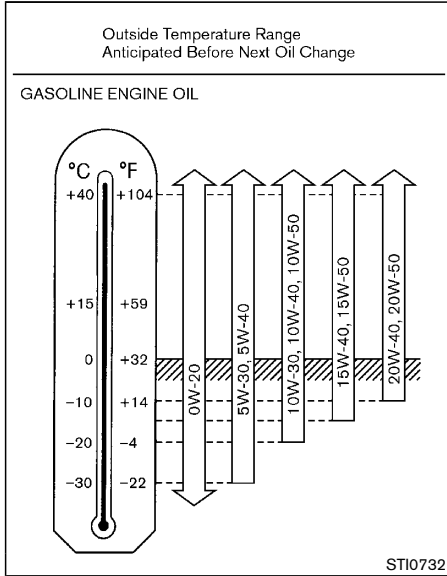

Diesel engine oil

5W-30 is preferable.

If 5W-30 is not available, select the viscosity, from the chart below, that is suitable for the outside temperature range.

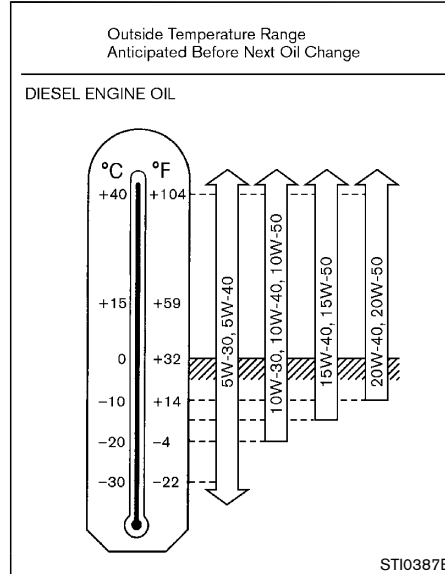

AIR CONDITIONER SYSTEM REFRIGERANT AND LUBRICANT

The air conditioner system of your vehicle must be charged with the refrigerant HFC-134a (R134a) and the lubricant NISSAN A/C System Oil Type R or equivalents. Use of any other refrigerants or lubricants will cause severe damage, and you may need to replace your vehicle's entire air conditioner system.

The release of refrigerants into the atmosphere is prohibited in many countries and regions. The refrigerant HFC-134a (R-134a) in your vehicle will not harm the Earth's ozone layer. However, it may contribute in a small part to the global warming effect. NISSAN recommends that the refrigerant be appropriately recovered and recycled. Contact a NISSAN dealer when servicing the air conditioner system.

ENGINE

Engine Model		HR12DE	HR15DE	K9K
Type		Gasoline, 4-cycle, DOHC	Gasoline, 4-cycle, DOHC	Diesel, 4-cycle
Cylinder arrangement		3-cylinder, in-line	4-cylinder, in-line	4-cylinder, in-line
Bore × Stroke	mm (in)	78.0 × 83.6 (3.071 × 3.291)	78.0 × 78.4 (3.071 × 3.087)	76.0 × 80.5 (2.992 × 3.169)
Displacement	cm ³ (cu in)	1,198 (73.10)	1,498 (91.41)	1,461 (89.15)
Idle speed at the "N" (Neutral) position	rpm	MT: 750±50 CVT: 750±50	MT: 650±50 AT: 700±50 CVT: 700±50	MT: 800±50
Ignition timing (B.T.D.C.)		MT: 12°±2 CVT: 9°±2	MT: 5°±2 AT: 5°±2 CVT: 7°±2	-
Spark plugs	Standard	FXE20HR11*1 DILKAR6A11*2	REA12WMB4*3 LZKAR6AP-11*4	REA12MC4*5 -
	Spark plug gap	mm (in)	1.1 (0.043)	1.1 (0.043)*3*4 1.0 to 1.1 (0.039 to 0.043)*5
Camshaft operation		Timing chain	Timing chain	Timing belt
Maximum vehicle speed (for Gulf standard models)*6				
	km/h (MPH)	-	AT: 170 km/h (106 MPH) MT: 183 km/h (114 MPH)	-

*1: Except for Hong Kong

*2: For Hong Kong

*3: For MT model and AT model, except for Iraq

*4: For CVT model

*5: For Iraq

*6: Gulf Standard requires automobile manufacturers to indicate the maximum vehicle speed for applicable models. The maximum vehicle speed, listed above, is the measured speed under certain testing conditions. The actual value may differ according to the vehicle usage and road and environmental conditions. NISSAN recommends you to ALWAYS observe posted speed limits and never drive too fast for conditions.

TIRES AND WHEELS

	Standard*1	Spare*2
Tire size	175/70 R14 84H 175/70 R14 84T 185/70 R14 88S 185/65 R15 88H 185/65 R15 88T	T125/70 D15 95M 175/70 R14 84H 175/70 R14 84T 185/70 R14 88S 185/65 R15 88H

		Size	Offset mm (in)
Road wheel	Steel	14 × 5-1/2J	40 (1.57)
		15 × 5-1/2J	40 (1.57)
		15 × 5-1/2JJ	40 (1.57)
	Aluminum alloy wheel	15 × 5-1/2J	40 (1.57)
Spare	Steel	14 × 5-1/2J	40 (1.57)
		15 × 5-1/2J	40 (1.57)
		15 × 5-1/2JJ	40 (1.57)
		15 × 4T	40 (1.57)

*1: See the tire placard on your vehicle for the recommended cold tire pressure.

*2: The tire puncture repair kit is supplied except for model with spare tire.

DIMENSIONS

	Unit: mm (in)
Overall length	4,455 (175.4) 4,512 (177.6)*1
Overall width	1,695 (66.7)
Overall height	1,510 (59.4)*2 1,515 (59.6)
Front tread	1,480 (58.3)
Rear tread	1,485 (58.5)
Wheelbase	2,590 (102.0)*3 2,600 (102.4)

*1: Sportech version, for Thailand

*2: Model with 175/70 R14 tire except for Thailand, Singapore, Indonesia and Hong Kong

*3: For the Middle East

WHEN TRAVELLING OR REGISTERING IN ANOTHER COUNTRY

When planning to travel in another country or region, find out whether the fuel required for your vehicle is available in that country or region. Using a low octane rated fuel may cause engine damage. Therefore, be sure that the required fuel is available wherever you go. For additional information regarding recommended fuel, see "Fuel information" (P.9-4).

When transferring the registration of your vehicle to another country, state, province or district, contact the appropriate authorities to find out that the vehicle complies with the local legal requirements. In some cases, a vehicle cannot meet the legal requirements, and it may be necessary to modify the vehicle to meet local laws and regulations. In addition, there may be possibilities that a vehicle cannot be adapted in certain areas.

The laws and regulations for motor vehicle emission control and safety standards vary according to the country, state, province or district; therefore, the vehicle specification may differ.

When any vehicles are to be taken into another country, state, province or district, its modification, transportation, registration, and any other expenses which may result, are the responsibility of the user. NISSAN is not responsible for any inconveniences that may result.

VEHICLE IDENTIFICATION

It is prohibited to cover, paint, weld, cut, drill, alter or remove Vehicle Identification Number (VIN).

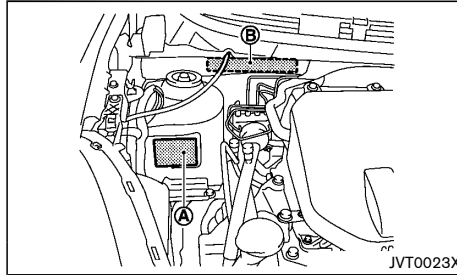

VEHICLE IDENTIFICATION PLATE

The plate is affixed as shown (A) .

BUILT DATE PLATE (for Australia and New Zealand)

Built date is stamped on the vehicle identification plate.

The built date means the calendar month and the year in which the body shell and power train subassemblies are conjoined and the vehicle is driven or moved from the production line.

VEHICLE IDENTIFICATION NUMBER (chassis number)

The number is stamped as shown (B) .

VEHICLE IDENTIFICATION NUMBER (VIN) PLATE

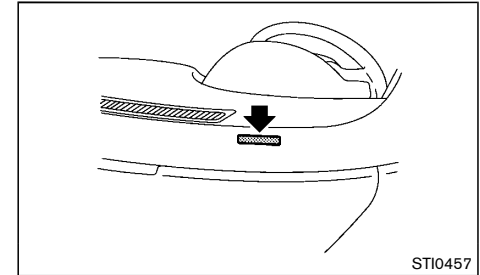

The plate is affixed as shown.

ENGINE SERIAL NUMBER

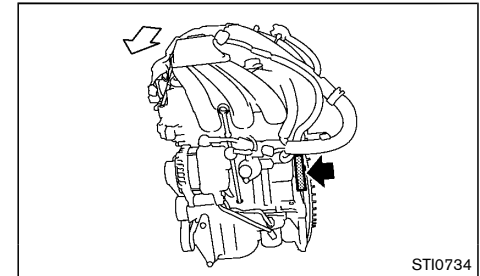

HR12DE engine

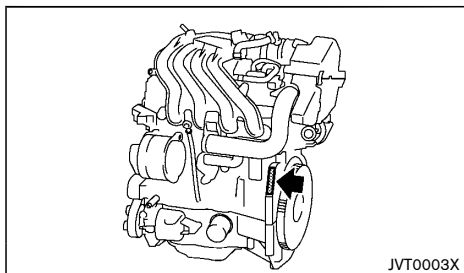

HR15DE engine

JVT0003X

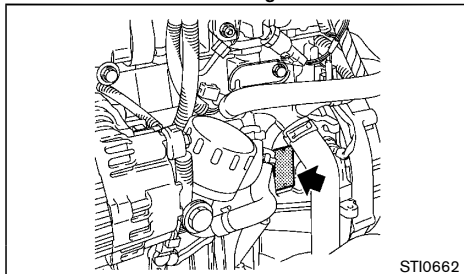

K9K engine

STI0662

CERTIFICATION LABEL (if equipped)

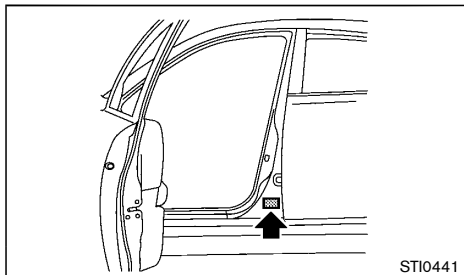

STI0441

TIRE PLACARD

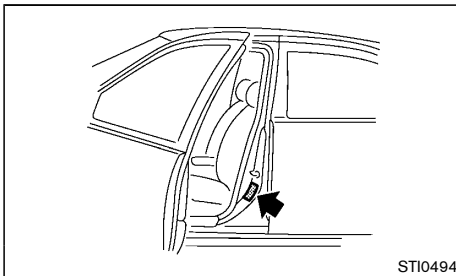

STI0494

The cold tire pressures are shown on the tire placard affixed to the driver's side center pillar.

AIR CONDITIONER SPECIFICATION LABEL

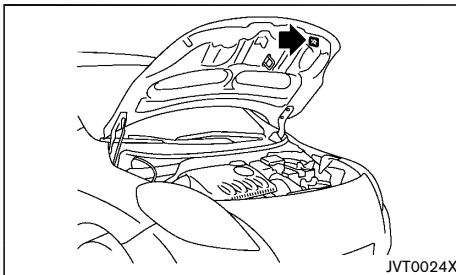

JVT0024X

UNIFORM TIRE QUALITY GRADING (if equipped)

Quality Grades: All passenger car tires must conform to local safety requirements in addition to these grades.

Quality grades can be found where applicable on the tire sidewall between tread shoulder and maximum section width. For example:

Treadwear 200 Traction AA Temperature A

TREADWEAR

The treadwear grade is a comparative rating based on the wear rate of the tire when tested under controlled conditions on a specified government test course. For example, a tire graded 150 would wear one and one-half (1 1/2) times as well on the government course as a tire graded 100. The relative performance of tires depends upon the actual conditions of their use, however, and may depart significantly from the norm due to variations in driving habits, service practices and differences in road characteristics and climate.

TRACTION AA, A, B AND C

The traction grades, from highest to lowest, are AA, A, B, and C. Those grades represent the tire's ability to stop on wet pavement as measured under controlled conditions on specified government test surfaces of asphalt and concrete. A tire marked C may have poor traction performance.



WARNING:

The traction grade assigned to this tire is based on straight-ahead braking traction tests, and does not include acceleration, cornering, hydroplaning, or peak traction characteristics.

RADIO APPROVAL NUMBER AND INFORMATION

TEMPERATURE A, B AND C

The temperature grades are A (the highest), B, and C, representing the tire's resistance to the generation of heat and its ability to dissipate heat when tested under controlled conditions on a specified indoor laboratory test wheel. Sustained high temperature can cause the material of the tire to degenerate and reduce tire life, and excessive temperature can lead to sudden tire failure. The grade C corresponds to a level of performance which all passenger car tires must meet under the local regulations. Grades B and A represent higher levels of performance on the laboratory test wheel than the minimum required by law.



WARNING:

The temperature grade for this tire is established for a tire that is properly inflated and not overloaded. Excessive speed, under-inflation, or excessive loading, either separately or in combination, can cause heat build-up and possible tire failure.

FOR THAILAND

This telecommunication equipment conforms to NTC technical requirement.

- Remote keyless entry system (if equipped)
- Intelligent Key system (if equipped)
- NISSAN Anti-Theft System (NATS) (if equipped)

FOR SINGAPORE

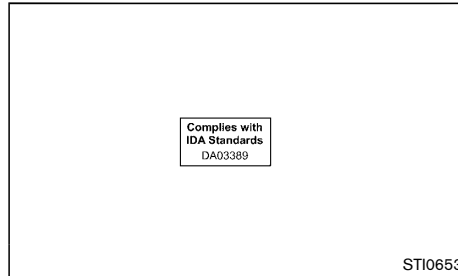

- NISSAN vehicle immobilizer system (if equipped)
- Remote control keyless system (if equipped)
- Intelligent Key system (if equipped)

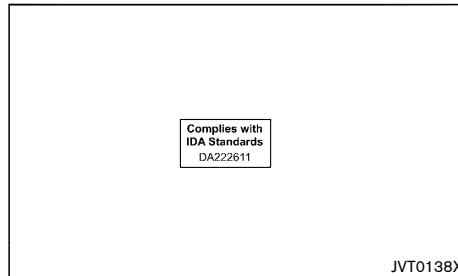

- Body Control Module (BCM)

FOR INDONESIA

Intelligent Key system (if equipped)

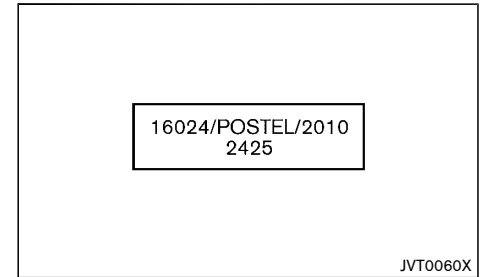

Remote keyless entry system (if equipped)

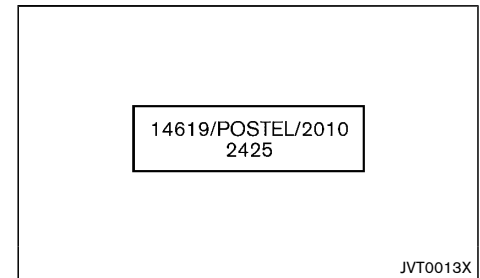

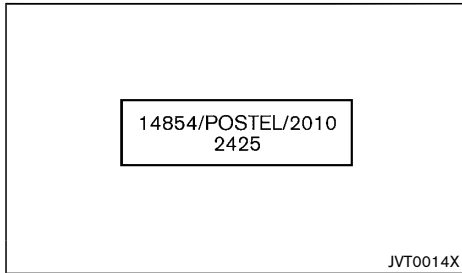

NISSAN Anti-Theft System (NATS) immobilizer (if equipped)

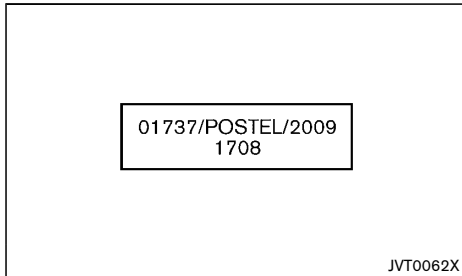
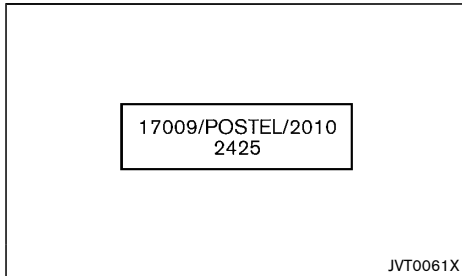

Body Control Module (BCM)

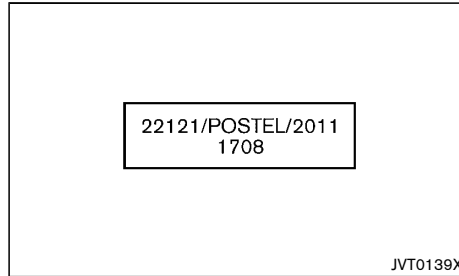

FOR NIGERIA



- Remote control keyless system (if equipped)
- NISSAN vehicle immobilizer system (if equipped)

FOR OMAN

Intelligent Key system (if equipped)

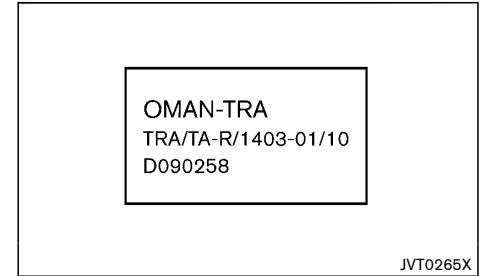

- Body Control Module

FOR THE UNITED ARAB EMIRATES

Intelligent Key system (if equipped)

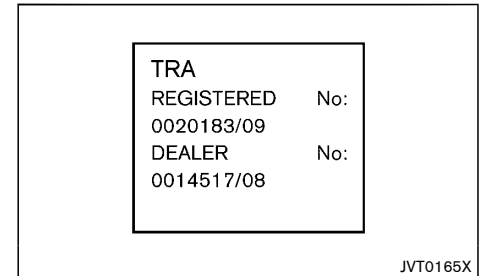

- Intelligent Key

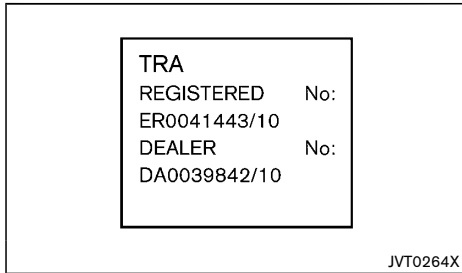

- Body Control Module

NISSAN Anti-Theft System (NATS) immobilizer and Intelligent Key system (if equipped)

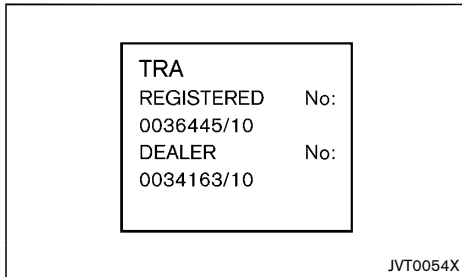

10 Index

A

Adjusting time.....	2-25
After repairing tire	6-8
Air bag system	
Side (See supplemental side-impact air bag system)	1-23
Supplemental curtain side-impact air bag system	1-18
Supplemental front-impact air bag system	1-18, 1-23
Supplemental side-impact air bag system	1-18
Air bag warning label	1-21
Air cleaner filter	8-18
Air conditioner	4-3
Air conditioner specification label	9-9
Air conditioner system refrigerant and lubricant	9-5
Automatic air conditioner	4-7
Heater and air conditioner, and audio system	4-1
Manual air conditioner	4-4
Servicing air conditioner	4-8
Air conditioner filter	4-8
Aluminum alloy wheels	7-3
Antenna	4-16
Anti-lock Braking System (ABS)	5-27
Anti-lock braking system (ABS) warning light	2-12
Appearance care	
Exterior appearance care	7-2
Interior appearance care	7-3
Audible reminders	2-17
Audio operation precautions	4-10
Audio system	4-10
Steering wheel audio controls	4-26
Automatic	
Automatic transmission fluid (ATF)	8-18
Automatic Transmission	5-4
Automatic Transmission position indicator.....	2-9

Auxiliary input jack	4-25
----------------------------	------

B

Battery	8-4, 8-21
Intelligent Key	8-23
Intelligent Key battery discharge	5-7
Remote controller battery	8-22
Variable voltage control system	8-24
Vehicle battery	8-21
Battery replacement	
Intelligent Key	8-23
Battery saver system	2-18, 2-29
Before starting engine	5-2
Before using emergency tire puncture repair kit ...	6-6
Belts (See drive belts)	8-14
Bleeding fuel system	8-13
Blocking wheels	6-3
Bluetooth® Hands-Free Phone System	4-27
Brake	
Brake booster	8-16
Brake fluid	8-17
Brake precautions	5-26
Brake system	5-26
Brakes	8-15
Checking foot brake pedal	8-16
Checking parking brake	8-15
Parking brake	3-23
Parking brake operation	5-29
Warning light	2-12
Brake assist	5-26
Brake precautions	5-26
Brakes	8-15
Break-in schedule.....	5-2
Bulb replacement	8-3, 8-26

C

Car phone or CB radio	4-27
Card holder	2-27

Care when driving	5-4
Catalytic converter, Three way catalyst	5-3
CD player operation	4-23
Center mark on seat belts	1-10
Center Ventilators.....	4-2
Changing	
Changing engine coolant	8-9
Changing engine oil and oil filter	8-10
Changing tires and wheels	8-32
Changing flat tire	6-3
Checking	
Checking bulbs	2-12
Checking engine coolant level	8-9
Checking engine oil level	8-10
Checking foot brake pedal	8-16
Checking parking brake	8-15
Child restraint anchorage	1-12
Child restraint installation using ISOFIX	1-12
Child restraints	1-10
Child safety	1-7
Child safety rear door lock	3-6
Chimes, Audible reminders.....	2-17
Chrome parts.....	7-3
Cigarette lighter	2-26
Circuit breaker, Fusible link	8-24
Cleaning exterior and interior	7-2, 7-3
Clock	2-25
Closing hood	3-19
Clutch fluid	8-17
Cold weather driving	5-28
Continuously Variable Transmission	5-4
Continuously Variable Transmission (CVT) fluid	8-18
Continuously Variable Transmission position indicator	2-9
Controls	
Steering wheel audio controls	4-26
Coolant	
Changing engine coolant	8-9
Checking engine coolant level	8-9

High temperature warning light	2-13
Corrosion protection	7-5
Cup holders	2-27

D

Defogger switch	2-22
Dimensions	9-7
Door locks	3-4
Door open warning light	2-13
Draining water	8-13
Drive belts	8-14
Driving	
Care when driving	5-4
Cold weather driving	5-28
Driving in wet conditions	5-4
Driving in winter conditions	5-4
Driving with Automatic Transmission (AT)	5-10
Driving with Continuously Variable Transmission (CVT)	5-13
Driving with Manual Transmission (MT)	5-16
Precautions when starting and driving	5-2
Driving vehicle	5-10

E

Electric power steering system	5-25
Electric power steering warning light	2-13
Emergency tire puncture repair kit	6-5, 8-33
Engine	
Before starting engine	5-2
Break-in schedule	5-2
Changing engine coolant	8-9
Changing engine oil and oil filter	8-10
Checking engine coolant level	8-9
Checking engine oil level	8-10
Engine compartment check locations	8-6
Engine cooling system	8-8
Engine oil	8-10
Engine serial number	9-8
Engine specifications	9-6

High temperature warning light	2-13
If your vehicle overheats	6-10
Spark plugs	8-15
Engine cold start period	5-4
Engine coolant temperature gauge	2-8
Engine start operation indicator light	2-15
Exhaust gas (carbon monoxide)	5-3
Explanation of general maintenance items	8-3
Extended storage fuse switch	8-25
Exterior lights	8-27

F

Fail-safe	5-13
Flat tire	6-2
Floor mats	7-4
Fluid	
Automatic transmission fluid (ATF)	8-18
Brake fluid	8-17
Clutch fluid	8-17
Continuously Variable Transmission (CVT) fluid	8-18
Engine coolant	8-8
Engine oil	8-10
Window washer fluid	8-5, 8-20
Fog light switch	2-20
Front fog lights	2-20
Front seats	1-2
Fuel	
Fuel filler cap	3-21
Fuel filler lid	3-20
Fuel gauge	2-9
Fuel information	9-4
Fuel octane rating	9-4
Opening fuel filler lid	3-20
Recommended fuel/lubricants and capacities	9-2
Fuel filler cap	3-21
Fuel filler lid	3-20
Fuses	8-24
Fusible links	8-24

G

Gauge	2-4
Fuel gauge	2-9
Odometer	2-5
Speedometer	2-5
Tachometer	2-8
General maintenance	8-3
Getting emergency tire puncture repair kit	6-6
Glove box	2-27

H

Hands-Free Phone System, Bluetooth®	4-27
Hazard indicator and outside chime	3-16
Hazard indicator flasher switch	6-2
Head restraints	1-3
Headlight	
Headlight and turn signal switch	2-18
Headlights	
Bulb replacement	8-26
Headlight aiming control	2-19
Headlight switch	2-18
Heater and air conditioner	4-3
High temperature warning light	2-13
Hood release	3-18
Horn	2-23

I

Idling Stop OFF switch	5-19, 5-20
Idling Stop System	5-18, 5-19
Ignition switch	
Key positions	5-5
Ignition switch (model without Intelligent Key system)	5-4
Ignition switch positions	5-6
Impact sensing door lock releasing mechanism ...	3-6
Indicator lights	2-15
Injured persons	1-8

Inside rearview mirror	3-21
Installing spare tire	6-5
Instrument brightness control.....	2-10
Instrument panel	2-2
Intelligent Key	3-3
Intelligent Key battery	8-23
Intelligent Key battery discharge	5-7
Intelligent Key system.....	3-8, 5-5
Intelligent Key system warning light	2-13
Interior lights	2-29, 8-27
ISOFIX child restraint system.....	1-11

J

Jacking up vehicle	6-3
Jump starting	6-8

K

Key.....	3-2
Ignition switch (model without Intelligent Key system)	5-4
Ignition switch positions	5-6
Intelligent Key battery	8-23
Intelligent Key battery discharge	5-7
Intelligent Key system.....	3-8, 5-5
Keys	3-2
Locking with key	3-4
Mechanical key.....	3-4
NISSAN Anti-Theft System (NATS*) key.....	3-3
Push-button ignition switch (model with Intelligent Key system)	5-5
Remote keyless entry system.....	3-6
Using Intelligent Key system.....	3-9
Using remote keyless entry system	3-7, 3-14
Key positions	5-5

L

Labels	
Air conditioner specification label	9-9

Engine serial number	9-8
Vehicle identification number (VIN)	9-8
Light	
Bulb replacement	8-3, 8-26
Exterior lights	8-27
Fog light switch	2-20
Front fog lights.....	2-20
Headlight aiming control.....	2-19
Headlight and turn signal switch.....	2-18
Headlight switch	2-18
Headlights	8-26
Indicator lights	2-15
Interior lights	2-29, 8-27
Light locations	8-28
Rear fog light.....	2-20
Replacement.....	8-3, 8-26
Room light	2-29
Warning lights	2-12

Lock

Anti-lock Braking System (ABS)	5-27
Child safety rear door lock	3-6
Door locks	3-4
Locking with inside lock knob.....	3-5
Locking with key	3-4
Locking with power door lock switch	3-5
Steering lock.....	5-5, 5-6
Vehicle speed sensing door lock mechanism	3-5

M

Maintenance	
Battery	8-4, 8-21
Explanation of general maintenance items.....	8-3
General maintenance	8-3
Maintenance precautions	8-5
Maintenance requirements	8-3
Scheduled maintenance	8-3
Seat belt maintenance	1-10
Malfunction indicator light (MIL)	2-16
Manual air conditioner	4-4
Manual transmission	5-4

Map light.....	2-29
Mechanical key.....	3-4
Meters and gauges.....	2-4
Mirror	
Inside rearview mirror	3-21
Mirrors	3-21
Outside rearview mirrors	3-22

N

New vehicle break-in	5-2
NISSAN Anti-Theft System (NATS)	3-17
NISSAN Anti-Theft System (NATS*) key.....	3-3

O

Odometer	2-5
Oil	
Changing engine oil and oil filter	8-10
Checking engine oil level	8-10
Engine oil	8-10
Opening fuel filler lid	3-20
Opening hood	3-19
Outside rearview mirrors	3-22
Overdrive switch.....	5-12
Overheat, If your vehicle overheats	6-10

P

Panic alarm	3-7, 3-15
Parking	
Parking brake.....	3-23
Parking, Parking brake operation	5-29
Passenger compartment	8-25
Phone	
Bluetooth® Hands-Free Phone System.....	4-27
Car phone or CB radio	4-27
Power	
Electric power steering system	5-25
Locking with power door lock switch	3-5
Power outlet.....	2-26

Power windows.....	2-23
Precautions	
Audio operation.....	4-10
Brake precautions.....	5-26
Maintenance.....	8-5
Precautions on child restraint usage.....	1-10
Precautions on push-button ignition switch operation.....	5-5
Precautions on Supplemental Restraint System (SRS).....	1-18
Precautions when starting and driving.....	5-2
Safety precautions.....	4-2
Seat belt usage.....	1-6
Towing precautions.....	6-11
Precautions on push-button ignition switch operation.....	5-5
Pregnant women.....	1-8
Preparing tools and spare tire.....	6-2
Pre-tensioner seat belt system.....	1-21, 1-26
Push starting.....	6-10
Push-button ignition switch (model with Intelligent Key system).....	5-5

R

Radio.....	4-10
Car phone or CB radio.....	4-27
Radio operation.....	4-23
Steering wheel audio controls.....	4-26
Radio FM-AM radio with Compact Disc (CD) player.....	4-17, 4-21
Rear comfort fan.....	4-9
Rear fog light.....	2-20
Rear Ventilators.....	4-3
Recommended fuel/lubricants and capacities.....	9-2
Recommended SAE viscosity number.....	9-4
Remote controller battery.....	8-22
Remote keyless entry system.....	3-6
Removing spots.....	7-2
Repair and replacement procedure.....	1-26
Repairing tire.....	6-6
Reverse reminder chime.....	2-17

Room light.....	2-29
-----------------	------

S

Safety	
Child safety.....	1-7
Child safety rear door lock.....	3-6
Safety precautions.....	4-2
Scheduled maintenance.....	8-3
Seat	
Center mark on seat belts.....	1-10
Front seats.....	1-2
Precautions on seat belt usage.....	1-6
Seat belt.....	7-4
Seat belts.....	1-6
Seats.....	1-2
Three-point type seat belts.....	1-8
Seat belt.....	1-8
Center mark on seat belts.....	1-10
Precautions on seat belt usage.....	1-6
Seat belt warning light.....	2-14
Seat belt(s)	
Child safety.....	1-7
Injured persons.....	1-8
Pregnant women.....	1-8
Pre-tensioner seat belt system.....	1-21, 1-26
Seat belt maintenance.....	1-10
Shoulder belt height adjustment.....	1-9
Seat belts	
Cleaning.....	7-4
Security system.....	3-17
Servicing air conditioner.....	4-8
Shift lever	
Shift lock release.....	5-15
Shift lock release.....	5-12
Transmission.....	5-15
Shoulder belt height adjustment.....	1-9
Side ventilators.....	4-2
Side-impact air bag system.....	1-23
Soft bottle holder.....	2-28
Sonar (parking sensor) system.....	5-24
Spare tire.....	8-33

Spark plugs.....	8-15
Speed [120 km/h (75 MPH)] warning light.....	2-14
Speedometer.....	2-5
SRS air bag warning light.....	1-22
Starting	
Before starting engine.....	5-2
Jump starting.....	6-8
Precautions when starting and driving.....	5-2
Push starting.....	6-10
Starting engine (model with Intelligent Key system).....	5-9
Starting engine (model without Intelligent Key system).....	5-8
Starting vehicle.....	5-10
Steering	
Electric power steering system.....	5-25
Steering lock.....	5-5, 5-6
Steering wheel.....	3-21
Steering wheel switch for audio controls.....	4-26
Stopping vehicle.....	6-2
Storages.....	2-27
Stowing damaged tire and tools.....	6-5
Sun visors.....	2-28
Supplemental air bag systems.....	1-22
Supplemental curtain side-impact air bag system.....	1-18
Supplemental front-impact air bag system.....	1-18, 1-23
Supplemental Restraint System (SRS).....	1-18
Supplemental side-impact air bag system.....	1-18, 1-23
Switch	
Audio control steering wheel switch.....	4-26
Defogger switch.....	2-22
Fog light switch.....	2-20
Front fog lights.....	2-20
Hazard indicator flasher switch.....	6-2
Headlight aiming control.....	2-19
Headlight and turn signal switch.....	2-18
Headlight switch.....	2-18
Ignition switch.....	5-4
Power door lock switch.....	3-5

Rear fog light	2-20
Turn signal switch	2-19
Wiper and washer switch	2-21

T

Tachometer	2-8
Theft warning system	3-17
Three-point type seat belts	1-8
Three-way catalyst	5-3
Tire	
Changing tires and wheels	8-32
Installing spare tire	6-5
Preparing tools and spare tire	6-2
Spare tire	8-33
Stowing damaged tire and tools	6-5
Tire age	8-32
Tire equipment	5-28
Tire inflation pressure	8-31
Tire placard	9-9
Tire wear and damage	8-32
Tires and wheels	8-31, 9-7
Tires	6-5
Flat tire	6-2
Tire chains	8-32
Tire rotation	8-4, 8-32
Types of tires	8-31
Uniform tire quality grading	9-9
Towing	
Towing precautions	6-11
Towing recommended by NISSAN	6-11
Towing your vehicle	6-11
Trailer towing	5-25
Trailer towing	5-25
Transmission	
Automatic Transmission (AT)	5-4
Automatic transmission fluid (ATF)	8-18
Continuously Variable Transmission (CVT)	5-4
Continuously Variable Transmission (CVT) fluid	8-18
Driving with Automatic Transmission (AT)	5-10

Driving with Continuously Variable Transmission (CVT)	5-13
Driving with Manual Transmission (MT)	5-16
Manual transmission (MT)	5-4
Transmission shift lever lock release	5-15
Trip computer	2-7
Troubleshooting guide	3-13
Trunk lid	3-19
Trunk light	2-29
Turn signal switch	2-19
Types of tires	8-31

U

Underbody cleaning	7-3
Uniform tire quality grading	9-9
USB memory device operation	4-24
Using Intelligent Key system	3-9
Using remote keyless entry system	3-7, 3-14

V

Variable voltage control system	8-24
Vehicle	
Dimensions	9-7
Identification number (VIN)	9-8
Speed sensing door lock mechanism	3-5
Vehicle battery	8-21
Vehicle Dynamic Control (VDC) OFF switch	5-22
Vehicle Dynamic Control (VDC) system	5-21
Vehicle dynamic control (VDC) warning light	2-14
Vehicle information display	2-5
Vehicle security	5-28
Ventilators	4-2

W

Warning	
Lights	2-12
Warning and audible reminders	3-11
Warning lights	2-12

Warning/indicator lights and audible reminders	2-11
Warning light	
Speed [120 km/h (75 MPH)] warning light	2-14
Washer switch	
Windshield wiper and washer switch	2-21
Washing	7-2
Waxing	7-2
Wheels and tires, Care of wheels	7-3
When travelling or registering in another country	9-8
Where to go for service	8-3
Window washer fluid	8-5, 8-20
Window(s)	
Cleaning	7-2, 7-4
Manual windows	2-23
Power windows	2-23
Windows	2-23
Windshield wiper and washer switch	2-21
Wiper	
Windshield wiper and washer switch	2-21
Wiper and washer switch	2-21
Wiper blades	8-19

GAS STATION INFORMATION

FUEL INFORMATION

Gasoline engine (model with three-way catalyzt)



CAUTION:

Do not use leaded gasoline. Using leaded gasoline will damage the three-way catalyzt.

Except for Iraq and Thailand:

Use UNLEADED REGULAR gasoline with an octane rating of at least 91 (RON).

For Iraq:

Use UNLEADED PREMIUM gasoline with an octane rating of at least 91 (RON).

For Thailand:

Use UNLEADED REGULAR gasoline or gasohol (up to E20*) with an octane rating of at least 91 (RON).

*: Gasohol is alcohol blended gasoline. For example, "E20" is a mixture of approximately 20% fuel ethanol and 80% unleaded gasoline.

Diesel engine

Diesel fuel of at least 50 octane.

* If two types of diesel fuel are available, use summer or winter fuel properly according to the following temperature conditions.

- Above -7°C (20°F) ... Summer type diesel fuel.
- Below -7°C (20°F) ... Winter type diesel fuel.



CAUTION:

- **Do not use home heating oil, gasoline or other alternate fuels in your diesel engine. The use of those or adding those to diesel fuel can cause engine damage.**
- **Do not use summer fuel at temperatures below -7°C (20°F). The cold temperatures will cause wax to form in the fuel. As a result, it may prevent the engine from running smoothly.**

RECOMMENDED ENGINE OIL

See "Recommended fuel/lubricants and capacities" (P.9-2).

Gasoline engine

- Genuine NISSAN engine oil
- API grade SL, SM or SN
- ILSAC grade GF-3, GF-4 or GF-5

Diesel engine

- Genuine NISSAN engine oil
- ACEA B1/B5

TIRE COLD PRESSURE

See the tire placard affixed to the driver's side center pillar.

QUICK REFERENCE

- In case of emergency ... (P.6-1)
(Flat tire, engine will not start, overheating, towing)
- How to start the engine ... (P.5-1)
- How to read the meters and gauges ... (P.2-1)
- Maintenance and do-it-yourself ... (P.8-1)
- Technical information ... (P.9-1)