



FarmaSOS.com

Mercedes-Benz

SLK

Operator's Manual

## Symbols

Trademarks:

- Bluetooth® is a registered trademark of Bluetooth SIG Inc.
- ESP® is a registered trademark of Daimler.
- HomeLink® is a registered trademark of Prince, a Johnson Controls Company.
- iPod® and iTunes® are registered trademarks of Apple Inc., registered in the U.S.A. and other countries.
- Logic 7® is a registered trademark of Harman International Industries, Incorporated.
- Microsoft® is a registered trademark of Microsoft Corporation in the U.S.A. and other countries.
- SIRIUS and related marks are trademarks of SIRIUS XM Radio Inc.
- Windows media® is a registered trademark of Microsoft Corporation in the U.S.A. and other countries.

The following symbols are found in this Operator's Manual:

### **Warning!**

Warning notices draw your attention to hazards that may endanger your health or life, or the health or life of others.

 Highlights hazards that may result in damage to your vehicle.

 Helpful hints or further information you may find useful.

▶ This symbol points to instructions for you to follow.

▶ A number of these symbols appearing in succession indicates a multiple-step procedure.

▷ page This symbol tells you where to look for further information on a topic.

▷▷ This continuation symbol marks a warning or procedure which is continued on the next page.

Display Text in displays, such as the control system, are printed in the type shown here.

امداد خودرو فارما

تلفن شبانه روزی: ۰۲۱-۸۸۶۲۰۸۵

FarmaSOS.com

Our company and staff congratulate you on the purchase of your new Mercedes-Benz.

Your selection of our product is a demonstration of your trust in our company name. Furthermore, it exemplifies your desire to own an automobile that will be as easy as possible to operate and will provide years of service.

Your Mercedes-Benz represents the efforts of many skilled engineers and craftsmen. To help assure your driving pleasure, and also the safety of you and your passengers, we ask you to make a small investment of time:

- Please read this manual carefully, then return it to your vehicle where it will be handy for your reference.
- Please follow the recommendations contained in this manual. They are designed to acquaint you with the operation of your Mercedes-Benz.
- Please pay attention to the warnings and cautions contained in this manual. They are designed to help improve the safety of the vehicle operator and occupants.

We extend our best wishes for many miles of safe, pleasurable driving.

Mercedes-Benz USA, LLC

A Daimler Company

FarmaSOS.com

# امداد خودرو فارما

تلفن شبانه روزی: ۰۲۱-۸۸۸۶۲۰۸۵

**FarmaSOS.com**

<b>Index</b> .....	<b>4</b>	<b>At a glance</b> .....	<b>23</b>
<b>Introduction</b> .....	<b>18</b>	<b>Safety and security</b> .....	<b>31</b>
		<b>Controls in detail</b> .....	<b>55</b>
		<b>Operation</b> .....	<b>189</b>
		<b>Practical hints</b> .....	<b>233</b>
		<b>Technical data</b> .....	<b>291</b>

امداد خودرو فارما

تلفن شبانه روزی: ۰۲۱-۸۸۸۶۲۰۸۵

FarmaSOS.com

## 1, 2, 3 ...

911 Emergency calls ..... 152

## A

**ABS (Antilock Brake System)** ..... 48

Indicator lamp ..... 257

Messages in the multifunction  
display ..... 237**Accessory weight** ..... 217**Accidents** ..... 82

Air bags ..... 33

Emergency calls (Tele Aid) ..... 179

Emergency calls (Telephone) ..... 152

**Active Bi-Xenon headlamps**

see Headlamps

**Additives**

Engine oil ..... 303

Gasoline ..... 304

**Address change** ..... 19**Advanced Tire Pressure****Monitoring System (Advanced****TPMS)** ..... 201Messages in the multifunction  
display ..... 241, 255**Air bags** ..... 33

Emergency call upon deployment .. 179

Front, driver and passenger ..... 35

Head-thorax ..... 36

Knee bags ..... 36

Messages in the multifunction  
display ..... 239

OCS (Occupant Classification

System) ..... 37

Passenger front air bag off  
indicator lamp ..... 29, 37, 263

Safety guidelines ..... 34

**Air conditioning refrigerant and****lubricant** ..... 303**Air distribution** ..... 168**Air pressure**

see Tire inflation pressure

**Air pressure (tires)** ..... 217**Air pump (electric)** ..... 280**Air recirculation mode** ..... 169**AIRSCARF neck-level heating** ..... 65**Air vents** ..... 166**Air volume** ..... 168**Alarm system**

see Anti-theft systems

**Alignment bolt (vehicle tool kit)** ..... 279**Alternator**

Messages in the multifunction

display ..... 249

**Alternator (Technical data)**

see Vehicle specification

**AMG menu** ..... 97**Anticorrosion/antifreeze** ..... 305**Antilock Brake System**

see ABS

**Anti-theft systems** ..... 51

Anti-theft alarm system ..... 51

Immobilizer ..... 51

Tow-away alarm ..... 52

**Aquaplaning**

see Hydroplaning

**Armrest**

Storage compartment ..... 175

**Ashtray** ..... 177**Aspect ratio (tires)** ..... 217**Audio/DVD menu** ..... 100**Audio system** ..... 112

Adjusting volume ..... 117

Audio and telephone operation ..... 112

Audio AUX mode ..... 145

Bluetooth® settings ..... 120

CD mode ..... 131

Components ..... 112

iPod® (media interface) ..... 139

Media interface ..... 139

MP3 mode ..... 131

Operating safety ..... 112

Radio operation ..... 121

Satellite radio ..... 125

Switching on and off ..... 117

System settings ..... 119

Telephone ..... 146

USB devices (media interface) ..... 139

**Auto-dimming rear view mirrors** ..... 69**Automatic central locking** ..... 59, 108**Automatic climate control**

see Climate control system

**Automatic headlamp mode** ..... 71**Automatic interior lighting control** .... 75

<b>Automatic locking when driving</b> .....	108
<b>Automatic shift program</b> .....	88
<b>Automatic transmission</b> .....	85
Automatic shift program .....	88
Gear range indicator .....	88
Gear ranges .....	88
Gear selector lever .....	86
Kickdown .....	87
Kickdown (manual shift program) ....	92
Manual shift program .....	90
One-touch gearshifting .....	89
Program mode indicator .....	89
Program mode selector switch (automatic shift program) .....	88
Program mode selector switch (manual shift program) .....	90
Shifting procedure .....	86
Steering wheel gearshift control .....	89
Transmission position indicator .....	87
Transmission positions .....	87
<b>AUX socket</b> .....	145
<b>Axle oils</b> .....	301

## B

<b>Back button</b> .....	116
<b>Backrest</b> see Seats	
<b>Backup lamps</b> Messages in the multifunction display .....	252
<b>Bar (air pressure unit)</b> .....	217
<b>BAS (Brake Assist System)</b> .....	49
<b>Batteries, SmartKey</b> Checking condition .....	57
Replacing .....	266
<b>Battery, Vehicle</b> .....	282
Charging .....	283
Jump starting .....	283
Messages in the multifunction display .....	249
<b>Bead (tire)</b> .....	217
<b>Beverage holders</b> see Cup holders	
<b>Bluetooth® settings</b> .....	120
<b>Brake Assist System</b> see BAS	

<b>Brake fluid</b> Checking level .....	197
Messages in the multifunction display .....	244
<b>Brake lamps</b> Cleaning lenses .....	229
<b>Brake pads</b> Messages in the multifunction display .....	243
<b>Brakes</b> .....	222
High-performance brake system ....	223
Parking brake .....	83
Warning lamp .....	257
<b>Break-in period</b> .....	190
<b>Bulbs</b> see Replacing bulbs	

## C

<b>CAC (Customer Assistance Center)</b> ...	21
<b>California retail buyers and lessees, important notice for</b> .....	19
<b>Calls (phone)</b> .....	110, 146
<b>Can holders</b> see Cup holders	
<b>Capacities and recommended fuel/lubricants</b> .....	300
<b>Carpets, cleaning</b> .....	231
<b>CD player</b> .....	131
<b>Central locking</b> Automatic .....	59, 108
Locking/unlocking from inside .....	59
SmartKey .....	56
<b>Central locking/unlocking switch</b> .....	59
<b>Certification label</b> .....	292
<b>Children in the vehicle</b> Air bags .....	33
Indicator lamp, passenger front air bag off .....	37
Infant and child restraint systems ....	45
OCS (Occupant Classification System) .....	37
Safety notes .....	45
<b>Child safety</b> see Children in the vehicle	
<b>Chrome-plated exhaust tip, cleaning</b> .....	232
<b>Cigarette lighter</b> .....	177

## 6 Index

<b>Clear button</b> .....	116	<b>Coolant</b>	
<b>Climate control</b>		Anticorrosion/antifreeze .....	305
see Climate control system		Capacities .....	301
<b>Climate control system</b> .....	162	Checking level .....	196
Air conditioning .....	165	Messages in the multifunction display .....	247
Air conditioning refrigerant .....	303	<b>Corner-illuminating front fog lamps</b> .....	75
Air distribution .....	168	<b>Cruise control</b> .....	159
Air recirculation mode .....	169	Activating .....	160
Air vents .....	166	Canceling .....	160
Air volume .....	168	Changing the set speed .....	161
Automatic mode .....	166	Last stored speed .....	161
Deactivating system .....	165	Lever .....	160
Front defroster .....	168	Messages in the multifunction display .....	241
Maximum cooling MAX COOL .....	169	Resume function .....	161
Residual heat and ventilation .....	169	Setting current speed .....	160
Temperature .....	166	<b>Cup holders</b> .....	176
<b>Clock</b> .....	26, 93, 105	<b>Curb weight</b> .....	217
<b>Cockpit</b> .....	25	<b>Customer Assistance Center (CAC)</b> ...	21
<b>Cold tire inflation pressure</b> .....	217	<b>Customer Relations Department</b> .....	21
<b>Collapsible tire (spare wheel)</b> .....	300		
<b>Collapsible wheel chock</b> .....	234		
<b>COMAND system</b>			
see separate COMAND system operating instructions			
<b>Combination switch</b> .....	73		
<b>Control system</b> .....	93		
Multifunction display .....	95		
Multifunction steering wheel .....	94		
Resetting to factory settings .....	102		
<b>Control system menus</b> .....	96		
AMG .....	97		
Audio/DVD .....	100		
Navigation .....	101		
Settings .....	102		
Standard display .....	96		
Telephone .....	110		
Trip computer .....	109		
Vehicle status message memory ...	101		
<b>Control system submenus</b>			
Convenience .....	108		
Instrument cluster .....	103		
Lighting .....	105		
Time/Date .....	105		
Vehicle .....	108		
<b>Convenience submenu</b>			
Easy-entry/exit feature .....	108		
		<b>D</b>	
		<b>Dashboard</b> .....	تلفن شبانه ۰۲۱ ۸۸۸۶۲۰۸۸
		see Instrument cluster	
		<b>Data recording</b> .....	21
		<b>Date, Setting</b> .....	105
		<b>Daytime running lamp mode</b> .....	72
		Switching on or off .....	106
		<b>Deep water</b>	
		see Standing water	
		<b>Defogging (windshield)</b> .....	169
		<b>Defroster</b>	
		Front (Climate control system) .....	168
		Rear window .....	170
		<b>Delayed shut-off</b>	
		Exterior lamps .....	107
		Interior lighting .....	107
		<b>Department of Transportation</b>	
		see DOT	
		<b>Difficulties</b>	
		While driving .....	82
		With starting .....	80
		<b>Digital speedometer</b> .....	97
		<b>Dimensions (vehicle)</b>	
		see Vehicle specification	



**Direction of rotation (tires)** ..... 209

**Displays**

- Digital speedometer ..... 97
- Maintenance service indicator ..... 225
- Messages in the multifunction display ..... 236
- Multifunction display ..... 95
- Outside temperature ..... 97, 104
- Symbol messages ..... 243
- Text messages ..... 237
- Trip computer ..... 109
- Vehicle status message memory ... 101
- Vehicle system settings ..... 102

**Door control panel** ..... 30

**Doors**

- Locking/unlocking (SmartKey) ..... 56
- Messages in the multifunction display ..... 245
- Opening from inside ..... 58
- Remote door unlock (Tele Aid) ..... 182
- Unlocking (Mechanical key) ..... 264

**DOT (Department of Transportation)** ..... 217

**Drinking and driving** ..... 221

**Driving**

- Abroad ..... 224
- Hydroplaning ..... 224
- Instructions ..... 80, 221
- In winter ..... 220
- Problems ..... 82
- Safety systems ..... 47
- Systems ..... 159
- Through standing water ..... 224

**Driving and parking**

- Safety notes ..... 79

**Driving off** ..... 81, 224

**Driving safety systems** ..... 47

- ABS ..... 48
- BAS ..... 49
- ESP® ..... 49
- ETS ..... 50

**Driving systems**

- Cruise control ..... 159

**Driving tips, automatic transmission** ..... 87

**E**

**Easy-entry/exit feature** ..... 67, 108

**Electrical system**

- Improper work on or modifications ..... 20
- Power outlet ..... 177

**Electrical system (Technical data)**  
see Vehicle specification

**Electronic Stability Program**  
see ESP®

**Emergency, in case of**

- First aid kit ..... 234
- Flat tire ..... 273
- Hazard warning flasher ..... 74
- Roadside Assistance ..... 19, 180
- Towing the vehicle ..... 285

**Emergency calls**

- Tele Aid ..... 179
- Telephone ..... 152

**Emergency operations**

- Remote door unlock (Tele Aid) ..... 182
- Retractable hardtop ..... 266
- Trunk lid, emergency release ..... 60

**Emergency Tensioning Device**  
see ETD تلفن شبانه

**Emission control** ..... 225

- Information label ..... 293
- System warranties ..... 18

**Engine**

- Break-in recommendations ..... 190
- Cleaning ..... 228
- Compartment ..... 192
- Malfunction indicator lamp ..... 26, 262
- Messages in the multifunction display ..... 247
- Number ..... 293
- Starting ..... 80
- Turning off ..... 84

**Engine (Technical data)**  
see Vehicle specification

**Engine coolant**  
see Coolant

**Engine oil**

- Adding ..... 195
- Additives ..... 303
- Checking level ..... 193

Consumption .....	193	<b>Front air bags</b>	
Messages in the multifunction display .....	250	see Air bags	
Oil dipstick .....	193	<b>Front lamps</b>	
Recommended engine oils and oil filter .....	302	see Headlamps	
<b>ESP® (Electronic Stability Program)</b> .....	49	<b>Front seat head restraints</b>	
ETS .....	50	see Head restraints	
Messages in the multifunction display .....	237	<b>Fuel</b> .....	190
Warning lamp .....	260	Additives .....	304
<b>ETD (Emergency Tensioning Device)</b> .....	43	Capacity, fuel tank .....	301
Safety guidelines .....	34	Drive sensibly-safe fuel .....	221
<b>ETS (Electronic Traction System)</b> .....	50	Fuel consumption statistics .....	109
<b>Express operation</b>		Fuel filler flap and cap .....	191
Power windows .....	78	Fuel tank reserve warning lamp .....	26, 261
<b>Exterior lamp switch</b> .....	71	Premium unleaded gasoline .....	303
<b>Exterior rear view mirrors</b> .....	68	Refueling .....	190
Parking position .....	69	Requirements .....	303
<b>Exterior view of vehicle</b> .....	24	<b>Fuel filler flap</b> .....	191
		<b>Fuels, coolants, lubricants etc.</b> .....	300
		<b>Fuel tank</b>	
		Capacity .....	301
		Fuel filler flap and cap .....	191
		Refueling .....	190
		<b>Fuses</b> .....	288
<b>F</b>		<b>G</b>	
<b>Fastening the seat belts</b> .....	42	<b>Garage door opener</b> .....	30, 183
<b>First aid kit</b> .....	234	<b>Gasoline</b>	
<b>Flat tire</b> .....	273	see Fuel	
Lowering the vehicle .....	281	<b>GAWR (Gross Axle Weight Rating)</b> ...	218
Mounting the spare wheel .....	277	<b>Gear range</b> .....	88
Preparing the vehicle .....	273	Indicator .....	88
Spare wheel .....	273, 300	Limiting .....	89
TIREFIT (tire repair kit) .....	273	Shifting into optimal .....	90
<b>Floormats</b> .....	187	<b>Gear selector lever</b> .....	86
<b>Fluids</b>		Cleaning .....	231
Automatic transmission fluid .....	301	Gearshift pattern .....	86
Brake fluid .....	301	Lock .....	80, 86
Capacities .....	300	Shifting procedure .....	86
Engine coolant .....	301	Transmission position indicator .....	87
Engine oil .....	301	Transmission positions .....	87
Hydraulic fluid .....	302	<b>Gearshift lever</b> .....	84
Manual transmission oil .....	301	Gearshift pattern .....	84
Power steering fluid .....	301	<b>Generator</b>	
Washer and headlamp cleaning system .....	302	see Alternator	
<b>Fog lamps</b> .....	73	<b>Global locking/unlocking</b>	
Messages in the multifunction display .....	252, 254	see Key, SmartKey	

<b>Glove box</b> .....	174
<b>Gross Axle Weight Rating</b> see GAWR	
<b>Gross Vehicle Weight</b> see GVW	
<b>Gross Vehicle Weight Rating</b> see GVWR	
<b>GVW (Gross Vehicle Weight)</b> .....	218
<b>GVWR (Gross Vehicle Weight Rating)</b> .....	218

## H

<b>Halogen headlamps</b> see Headlamps	
<b>Hard plastic trim items, cleaning</b> ....	231
<b>Hazard warning flasher</b> .....	74
<b>Headlamp cleaning system</b> .....	74
<b>Headlamps</b>	
Active Bi-Xenon headlamps .....	71
Automatic headlamp mode .....	71
Bi-Xenon .....	71, 269
Cleaning lenses .....	229
Cleaning system .....	74
Daytime running lamp mode .....	72
Delayed shut-off .....	107
Halogen .....	269
High-beam flasher .....	74
High-beam headlamps .....	74
Low-beam headlamps .....	71
Replacing bulbs .....	267
Switch .....	71
<b>Headliner, cleaning and care of</b> .....	231
<b>Head restraints</b> .....	62
Adjustment .....	62
<b>Head-thorax air bags</b> .....	36
<b>Heated steering wheel</b> .....	67
<b>Height adjustment</b>	
Seats .....	62
<b>High-beam flasher</b> .....	74
<b>High-beam headlamps</b> .....	74, 269
Indicator lamp .....	26
<b>High-performance brake system</b> ....	223
<b>Hood</b> .....	192
Messages in the multifunction display .....	245
<b>Horn</b> .....	25
<b>Hydroplaning</b> .....	224

## I

<b>Identification labels</b> .....	292
<b>Identification number, vehicle (VIN)</b> .....	293
<b>Ignition</b> .....	61, 80
<b>Immobilizer</b> .....	51
<b>Infant and child restraint systems</b> see Children in the vehicle	
<b>Inflation pressure</b> see Tires, Inflation pressure	
<b>Inside door handle</b> .....	30, 58
<b>Instrument cluster</b> .....	26, 92
Illumination .....	93
Lamps .....	256
Multifunction display .....	95
<b>Instrument lighting</b> see Instrument cluster, Illumination	
<b>Instrument panel</b> see Instrument cluster	
<b>Instruments and controls</b> see Cockpit	
<b>Interfere with radio reception</b> .....	141
<b>Interior lighting</b> .....	75
Delayed shut-off .....	107
Emergency lighting .....	76
Reading lamps .....	75
<b>Interior rear view mirror</b> .....	68
Auto-dimming rear view mirrors .....	69
<b>Interior storage spaces</b> see Storage compartments	
<b>Intermittent wiping</b> .....	76
Rain sensor .....	76
<b>iPod® (media interface)</b> .....	139

## J

<b>Jack</b> .....	235
<b>Jump starting</b> .....	283

## K

<b>Key, Mechanical</b>	
Loss of .....	58
Replacing .....	58

- Unlocking/locking manually ..... 264
  - Valet locking ..... 61
  - Key, SmartKey**
    - Battery check lamp ..... 57
    - Checking batteries ..... 57
    - Factory setting ..... 57
    - Global locking (SmartKey) ..... 57
    - Global unlocking (SmartKey) ..... 57
    - Locking/unlocking ..... 56
    - Loss of ..... 58
    - Messages in the multifunction display ..... 246
    - Remote control ..... 56
    - Replacing ..... 58
    - Replacing batteries ..... 266
    - Restoring to factory setting ..... 57
    - Selective setting ..... 57
    - Starter switch positions ..... 61
  - Kickdown** ..... 87
  - Kickdown (manual shift program)** ..... 92
  - Kilopascal (air pressure unit)** ..... 218
  - Knee bags** ..... 36
- L**
- Labels**
    - Certification ..... 292
    - Emission control information ..... 293
    - Tire and Loading Information placard ..... 205
    - Tire inflation pressure ..... 200
  - Lamps, exterior**
    - Exterior lamp switch ..... 71
    - Front ..... 269
    - Messages in the multifunction display ..... 252
    - Switching on/off ..... 71
  - Lamps, indicator and warning**
    - ABS ..... 26, 257
    - Brakes ..... 27, 257
    - Engine malfunction ..... 26, 262
    - ESP® ..... 26, 260
    - Fog lamps ..... 73
    - Fuel tank reserve ..... 26, 261
    - High-beam headlamps ..... 26, 74
    - Instrument cluster ..... 26, 256
    - Low tire pressure/TPMS malfunction telltale ..... 26, 262
    - Passenger front air bag off ..... 29, 37, 263
    - Seat belt telltale ..... 26, 42, 259
    - SRS ..... 26, 32, 260
    - Turn signals ..... 26
  - Language, selecting** ..... 104
  - License plate lamps**
    - Messages in the multifunction display ..... 253
    - Replacing bulbs ..... 269
  - Light alloy wheels, cleaning** ..... 230
  - Lighter**
    - see Cigarette lighter
  - Lighting** ..... 70
    - Daytime running lamp mode ..... 72
    - Exterior ..... 71
    - Interior ..... 75
  - Limp-home mode** ..... 92
  - Load index (tires)** ..... 213, 218
  - Locator lighting** ..... 106
  - Locking the vehicle**
    - Manually ..... 265
    - SmartKey ..... 56
  - Loss of**
    - Key ..... 58
    - Service and Warranty Information booklet ..... 292
  - Low-beam headlamps** ..... 71
    - Exterior lamp switch ..... 71
    - Switching on ..... 71
  - Lubricants** ..... 300
  - Luggage cover** ..... 173
  - Lumbar support** ..... 64
- M**
- Maintenance** ..... 19
  - Maintenance System**
    - Service indicator display ..... 226
    - Service indicator message ..... 225
    - Service term exceeded ..... 226
  - Manual headlamp mode (Low-beam headlamps)** ..... 71
  - Manual shift program** ..... 90
  - Manual transmission** ..... 84
    - Gearshift lever ..... 84

<b>Maximum engine speed</b>			
see Vehicle specification			
<b>Maximum loaded vehicle weight</b> .....	218		
<b>Maximum load rating (tires)</b> .....	218		
<b>Maximum permissible tire inflation pressure</b> .....	218		
<b>Mechanical key</b>			
see Key, Mechanical			
<b>Media interface</b> .....	139		
<b>Memory function</b> .....	70		
<b>Menus</b>			
see Control system menus			
<b>Mirrors</b> .....	68		
Auto-dimming rear view mirrors .....	69		
Exterior rear view mirror parking position .....	69		
Exterior rear view mirrors .....	68		
Interior rear view mirror .....	68		
Memory function .....	70		
Vanity mirror .....	176		
<b>MON (Motor Octane Number)</b> .....	303		
<b>Motor Octane Number</b>			
see MON			
<b>MP3 mode</b> .....	131		
<b>Multifunction display</b> .....	95		
Symbol messages .....	243		
Text messages .....	237		
Vehicle status messages .....	236		
<b>Multifunction display messages</b>			
ABS .....	237		
Advanced TPMS .....	241, 255		
Air bags .....	239		
Alternator .....	249		
Battery .....	249		
Brake fluid .....	244		
Brake pads .....	243		
Check engine .....	247		
Coolant .....	247		
Cruise control .....	241		
Doors .....	245		
Engine oil .....	250		
Engine service .....	247		
ESP® .....	237		
Fog lamps .....	252, 254		
Gas cap .....	251		
High-beam lamps .....	253		
Hood .....	245		
License plate lamps .....	253		
Light sensor .....	253		
Low-beam lamps .....	253		
Parking brake .....	244		
Parking lamps .....	253		
Passenger front air bag .....	239		
Reserve fuel .....	251		
Retractable hardtop .....	246		
Reverse lamp .....	252		
Side marker lamps .....	252		
SmartKey .....	246		
SRS .....	245		
Tail lamps .....	254		
Tele Aid .....	245		
Tire inflation pressure .....	241, 255		
Tire pressure monitor .....	241		
Tires .....	241, 255		
Trunk .....	245		
Turn signals .....	255		
Washer fluid .....	247		
<b>Multifunction steering wheel</b>			
Adjustment .....	66		
Buttons .....	94		
Cleaning .....	231		
Easy-entry/exit feature .....	67, 108		
Gearshift control .....	89		
Heating .....	67		
Memory function .....	70		
Overview .....	27		
<b>N</b>			
<b>Navigation menu</b> .....	101		
<b>Navigation system</b>			
see Separate operating instructions			
<b>Nets, parcel</b> .....	174		
<b>Night security illumination</b> .....	107		
<b>Normal occupant weight</b> .....	218		
<b>Number, vehicle identification (VIN)</b> .....	293		
<b>O</b>			
<b>Occupant Classification System</b>			
see OCS (Occupant Classification System)			
<b>Occupant distribution</b> .....	218		

<b>Occupant safety</b>	
Air bags .....	33
Children and air bags .....	33
Children in the vehicle .....	45
Fastening the seat belts .....	42
Infant and child restraint systems ....	45
Introduction .....	32
OCS (Occupant Classification System) .....	37
Passenger front air bag off indicator lamp .....	37, 263
Seat belts .....	34, 40
<b>OCS (Occupant Classification System)</b> .....	37
Self-test .....	39
<b>Odometer</b> .....	95
<b>Oil, oil level</b>	
see Engine oil	
<b>On-board computer</b>	
see Control system	
<b>One-touch gearshifting</b> .....	89
<b>Operating safety</b> .....	20
<b>Ornamental moldings, cleaning</b> .....	229
<b>Outside temperature</b>	
see Displays	
<b>Overhead control panel</b> .....	30
<b>P</b>	
<b>Paintwork, cleaning</b> .....	228
<b>Paintwork code</b> .....	293
<b>Panic alarm</b> .....	47
<b>Parcel nets</b> .....	174
<b>Parking</b> .....	83
<b>Parking and standing lamp</b>	
Replacing bulbs .....	269
<b>Parking brake</b> .....	83
Messages in the multifunction display .....	244
<b>Parking position</b>	
Exterior rear view mirrors .....	69
Transmission position .....	87
<b>Parts service</b> .....	292
<b>PASS AIR BAG OFF indicator lamp</b>	
see Passenger front air bag off indicator lamp	
<b>Passenger front air bag</b> .....	35
Messages in the multifunction display .....	239
<b>Passenger front air bag off indicator lamp</b> .....	29, 37, 263
<b>Passenger safety</b>	
see Occupant safety	
<b>Pedals</b> .....	221
<b>Phone</b>	
see Telephone	
<b>Plastic parts, cleaning</b> .....	230
<b>Power assistance</b> .....	222
<b>Power outlet</b> .....	177
<b>Power seats</b>	
see Seats	
<b>Power washer</b> .....	228
<b>Power windows</b> .....	78
Cleaning .....	229
Door windows .....	78
Operation .....	78
Rear side windows .....	79
Synchronizing .....	79
<b>Practical hints</b> .....	234
<b>Problems</b>	
While driving .....	82
With vehicle .....	21
With wipers .....	77
<b>Product information</b> .....	18
<b>Production options weight</b> .....	218
<b>Program mode selector switch</b>	
Automatic shift program .....	88
Manual shift program .....	90
<b>Proximity key</b>	
see Key, SmartKey	
<b>PSI (air pressure unit)</b> .....	218
<b>R</b>	
<b>RACETIMER</b> .....	98
<b>Radio</b> .....	121
Satellite radio .....	125
Selecting stations .....	100
<b>Radio transmitters</b> .....	224
<b>Rain sensor</b>	
see Intermittent wiping	
<b>Rear axle oil</b> .....	301
<b>Rear fog lamp</b>	
see Fog lamps	

<b>Rear lamps</b>		<b>Satellite radio</b> .....	125
see Tail lamps		<b>Seat belt force limiter</b> .....	43
<b>Rear window defroster</b> .....	170	<b>Seat belts</b> .....	40
<b>Recommended tire inflation</b>		Children in the vehicle .....	45
<b>pressure</b> .....	198, 218	Cleaning .....	231
<b>Refrigerant, air conditioning</b> .....	303	Fastening .....	42
<b>Refueling</b> .....	190	Proper use of .....	41
<b>Regular checks</b> .....	191	Safety guidelines .....	34
<b>Reminder, Seat belt</b>		Safety notes .....	40
see Seat belts, Telltale		Telltale .....	26, 259
<b>Remote control</b>		<b>Seat heating</b> .....	65
see Key, SmartKey		<b>Seating capacity</b> .....	206
<b>Remote door unlock (Tele Aid)</b> .....	182	<b>Seats</b> .....	62
<b>Replacing</b>		Adjustment .....	62
Key .....	58	Easy-entry/exit feature .....	67
<b>Replacing bulbs</b> .....	267	Heating .....	65
<b>Reporting safety defects</b> .....	21	Memory function .....	70
<b>Research Octane Number</b>		<b>Selective setting</b>	
see RON		see Key, SmartKey	
<b>Reserve fuel</b>		<b>Selector lever</b>	
Messages in the multifunction		see Gear selector lever	
display .....	251	<b>Self-test</b>	
Warning lamp .....	26, 261	OCS (Occupant Classification	
<b>Reset button</b> .....	27, 92	System) .....	39
<b>Restraint systems</b>		Tele Aid .....	178
see Occupant safety		<b>Service</b>	
<b>Retractable hardtop</b> .....	170	see Maintenance	
Locking .....	172	<b>Service, parts</b> .....	292
Luggage cover .....	173	<b>Service and warranty information</b> .....	18
Messages in the multifunction		<b>Service intervals</b>	
display .....	246	see Maintenance System, Service	
Operating manually .....	266	indicator message	
Wind screen .....	173	<b>Service life (tires)</b> .....	210
<b>Rims</b> .....	218, 297	<b>Settings</b>	
<b>Roadside Assistance</b> .....	19, 180	Factory setting (SmartKey) .....	57
<b>RON (Research Octane Number)</b> .....	303	Memory function .....	70
<b>Roof</b>		Menu .....	102
see Retractable hardtop		Selective setting (SmartKey) .....	57
<b>Rubber parts, cleaning</b> .....	230	<b>Shelf behind roll bars</b> .....	175
		<b>Side marker lamps</b>	
		Cleaning lenses .....	229
		Messages in the multifunction	
		display .....	252
		<b>Sidewall (tires)</b> .....	219
		<b>Side windows</b>	
		see Power windows	
<b>S</b>			
<b>Safety</b>			
Driving safety systems .....	47		
Occupant safety .....	32		
Reporting defects .....	21		
<b>Safety belts</b>			
see Seat belts			

- SmartKey**  
see Key, SmartKey
- Snow chains** ..... 220
- Snow tires**  
see Winter tires
- Spare wheel** ..... 297  
Mounting ..... 277  
Storage location ..... 235
- Speed settings**  
Cruise control ..... 160  
Resume function ..... 161
- SRS (Supplemental Restraint System)**  
Indicator lamp ..... 26, 32, 260  
Messages in the multifunction  
display ..... 245
- Standing water, driving through** ..... 224
- Starter switch positions**  
SmartKey ..... 61
- Starting difficulties (engine)** ..... 80
- Starting the engine** ..... 80
- Steering column**  
see Multifunction steering wheel,  
Adjustment
- Steering wheel**  
see Multifunction steering wheel
- Steering wheel gearshift control** ..... 89
- Stolen Vehicle Recovery Services** ... 183
- Storage compartments** ..... 174
- Storing tires** ..... 210
- Sun visors** ..... 176
- T**
- Tachometer** ..... 93  
Overspeed range ..... 93
- Tail lamps**  
Cleaning lenses ..... 229  
Messages in the multifunction  
display ..... 254
- Tar stains** ..... 228
- Technical data**  
Air conditioning refrigerant ..... 303  
Brake fluid ..... 303  
Capacities fuels, coolants,  
lubricants etc. .... 300  
Coolant ..... 304  
Engine oil additives ..... 303  
Engine oils ..... 302  
Fuel requirements ..... 303  
Gasoline additives ..... 304  
Identification labels ..... 292  
Premium unleaded gasoline ..... 303  
Rims and tires ..... 297  
Spare wheel ..... 300  
Vehicle specification SLK 300 ..... 294  
Vehicle specification SLK 350 ..... 295  
Vehicle specification SLK 55 AMG . 296  
Washer and headlamp cleaning  
system ..... 302, 306
- Technical data (dimensions)**  
see Vehicle specification
- Technical data (electrical system)**  
see Vehicle specification
- Technical data (engine)**  
see Vehicle specification
- Technical data (weights)**  
see Vehicle specification
- Tele Aid** ..... 178  
Emergency calls ..... 179  
Information button ..... 181  
Initiating an emergency call  
manually ..... 180  
Messages in the multifunction  
display ..... 245  
Remote door unlock ..... 182  
Roadside Assistance button ..... 180  
Search & Send ..... 182  
SOS button ..... 180  
Stolen Vehicle Recovery Services .. 183  
System self-test ..... 178
- Telephone** ..... 27, 146  
Answering/ending a call ..... 110  
Call lists ..... 156  
Emergency calls "911" ..... 152  
Hands-free microphone ..... 30  
Making calls ..... 156  
Menu ..... 110  
Operation ..... 110  
Phone book ..... 111, 153  
Redialing ..... 111
- Temperature**  
Interior temperature ..... 166  
Outside ..... 97, 104
- Tightening torque**  
Wheels ..... 281
- Time setting** ..... 105



- TIN (Tire Identification Number)** ..... 219
- Tire and Loading Information placard** ..... 205
- Tire and loading terminology** ..... 217
- TIREFIT** ..... 273
- Tire Identification Number**  
see TIN
- Tire inflation pressure**  
Checking ..... 201  
Important notes on ..... 199  
Label on the inside of fuel filler flap ..... 200  
Placard on driver's door B-pillar ..... 205
- Tire labeling** ..... 212
- Tire load rating** ..... 218
- Tire ply composition and material used** ..... 219
- Tire repair kit**  
see TIREFIT
- Tires** ..... 197, 297  
Advanced Tire Pressure Monitoring System (Advanced TPMS) ..... 201  
Air pressure ..... 198  
Care and maintenance ..... 209  
Cleaning ..... 210  
Direction of rotation, spinning ..... 209  
Important notes on tire inflation pressure ..... 199  
Inflation pressure ..... 200, 201  
Information placard ..... 205  
Inspection ..... 209  
Labeling ..... 212  
Load index ..... 213, 218  
Load rating ..... 218  
Messages in the multifunction display ..... 241, 255  
Ply composition and material used ..... 219  
Problems under-/overinflation ..... 200  
Retreads ..... 197  
Rims and tires (technical data) ..... 297  
Rotation ..... 212  
Service life ..... 210  
Sizes ..... 297  
Snow chains ..... 220  
Speed rating ..... 214, 219  
Storing ..... 210  
Temperature ..... 199, 211  
Terminology ..... 217  
TIREFIT (tire repair kit) ..... 273  
Tire Identification Number ..... 219  
TPMS low tire pressure/  
malfunction telltale ..... 26, 262  
Traction ..... 211, 219  
Tread ..... 219  
Tread depth ..... 210, 219  
Treadwear ..... 211  
Treadwear indicators ..... 210, 219  
Vehicle maximum load on ..... 219  
Wear pattern ..... 212  
Winter tires ..... 219, 297
- Tire speed rating** ..... 214, 219
- Total load limit** ..... 219
- Tow-away alarm** ..... 52
- Towing**  
Towing eye bolt ..... 286  
Vehicle ..... 285
- Towing eye bolt** ..... 286
- Traction** ..... 211, 219
- Transmission**  
see Automatic transmission or Manual transmission
- Transmission fluid level** ..... 195
- Transmission gear selector lever**  
see Gear selector lever
- Transmission positions** ..... 87
- Traveling abroad** ..... 224
- Tread (tires)** ..... 219
- Tread depth (tires)** ..... 210, 219
- Treadwear** ..... 211
- Treadwear indicators (tires)** .... 210, 219
- Trip computer menu** ..... 109
- Trip odometer, resetting** ..... 93
- Trunk**  
Closing ..... 60  
Messages in the multifunction display ..... 245  
Opening ..... 60  
Trunk lid emergency release ..... 60  
Unlocking manually ..... 265  
Valet locking ..... 61
- Turning off the engine** ..... 84
- Turn signals** ..... 73  
Cleaning lenses ..... 229

Indicator lamps .....	26	<b>Vehicle status message memory</b> ....	101
Messages in the multifunction display .....	255	<b>Vehicle tool kit</b> .....	234
<b>U</b>		<b>Vehicle washing</b>	see Vehicle care
<b>Uniform Tire Quality Grading Standards</b> .....	210, 219	<b>Vehicle weights</b>	see Vehicle specification
<b>Units</b>		<b>W</b>	
Selecting speedometer display mode .....	104	<b>Warning sounds</b>	
<b>Unleaded gasoline, premium</b> .....	303	Driver's or passenger's seat belt .....	42
<b>Unlocking the vehicle</b>		Parking brake .....	244
Manually .....	264	Seat belt telltale .....	259
SmartKey .....	56	<b>Warranty coverage</b> .....	292
<b>Upholstery, cleaning</b> .....	231	<b>Washer and headlamp cleaning system</b> .....	306
<b>USB devices (media interface)</b> .....	139	<b>Washer fluid</b>	
<b>Useful features</b> .....	176	Messages in the multifunction display .....	247
<b>V</b>		Mixing ratio .....	306
<b>Valet locking</b> .....	61	Refilling .....	196
<b>Vehicle</b>		<b>Washing the vehicle</b> .....	227
Battery .....	282	<b>Wear pattern (tires)</b> .....	212
Care .....	227	<b>Weights (vehicle)</b>	see Vehicle specification
Control system .....	93	<b>Wheel</b> <small>تلفن شبانه روزی</small> .....	273
Identification Number (VIN) .....	292	Changing .....	278
Locking/unlocking .....	56	Removing .....	273
Lowering (wheel change) .....	281	Spare .....	281
Modifications and alterations, .....	20	Tightening torque .....	297
Operating safety .....	285	<b>Wheels, sizes</b> .....	197
Towing .....	264	<b>Wheels, Tires and</b> .....	
Unlocking/locking manually .....		<b>Windows</b>	see Power windows
<b>Vehicle dimensions</b>		<b>Windows, cleaning</b> .....	229
see Vehicle specification		<b>Wind screen</b> .....	173
<b>Vehicle Identification Number (VIN)</b> .....	292	<b>Windshield</b>	
<b>Vehicle jack</b>		Cleaning wiper blades .....	229
see Jack		Defogging .....	169
<b>Vehicle lighting</b> .....	70	Washer fluid .....	306
<b>Vehicle loading</b>		Wipers .....	76
Load limit .....	206	<b>Windshield wipers</b>	
Terminology .....	217	Replacing wiper blades .....	271
<b>Vehicle maximum load on the tire</b> ...	219	<b>Winter driving</b>	
<b>Vehicle specification</b>		Instructions .....	220
SLK 300 .....	294	Snow chains .....	220
SLK 350 .....	295	Tires .....	219
SLK 55 AMG .....	296	<b>Winter tires</b> .....	219, 297

Wood trims, cleaning ..... 232

امداد خودرو فارما

تلفن شبانه روزی: ۰۲۱-۸۸۸۶۲۰۸۵

FarmaSOS.com

### Product Information

Please observe the following in your own best interest:

We recommend using Genuine Mercedes-Benz Parts as well as conversion parts and accessories explicitly approved by us for your vehicle model.

We have tested these parts to determine their reliability, safety and special suitability for Mercedes-Benz vehicles.

We are unable to make an assessment for other products and therefore cannot be held responsible for them, even if in individual cases an official approval or authorization by governmental or other agencies should exist. Use of such parts and accessories could adversely affect the safety, performance or reliability of your vehicle. Please do not use them.

Genuine Mercedes-Benz Parts and pre-approved conversion parts and accessories are available at any authorized Mercedes-Benz Center. In addition, you will receive comprehensive information on permissible technical modifications and expert installations.

### Operator's Manual

#### Notes

This Operator's Manual contains a great deal of useful information. We urge you to read it carefully and familiarize yourself with the vehicle before driving.

For your own safety and longer service life of the vehicle, we urge you to follow the instructions and warnings contained in this Operator's Manual. Ignoring them could result in damage to the vehicle or personal injury to you or others. Vehicle damage caused by failure to follow instructions is not covered by the Mercedes-Benz Limited Warranty.

We continuously strive to improve our product and ask for your understanding that we reserve the right to make changes in design and equipment. Therefore, information, illustrations, and descriptions in this Operator's Manual might differ from your vehicle.

### Vehicle equipment

Your vehicle may have some or all of the equipment described in this manual. Therefore, you may find explanations for optional equipment not installed in your vehicle. If you have any questions about operating particular equipment, any authorized Mercedes-Benz Center will be glad to demonstrate the proper procedures.

Optional equipment is also described in this manual, including operating instructions wherever necessary. Since they are special-order items, the descriptions and illustrations herein may vary slightly from the actual equipment of your vehicle.

If there are any equipment details that are not shown or described in this Operator's Manual, any authorized Mercedes-Benz Center will be glad to inform you of correct care and operating procedures. The Operator's Manual and Maintenance Booklet are important documents and should be kept with the vehicle.

### Service and warranty information

The Service and Warranty Information booklet contains detailed information about the warranties covering your Mercedes-Benz, including:

- New Vehicle Limited Warranty
- Emission System Warranty
- Emission Performance Warranty
- California, Connecticut, Maine, Massachusetts, New York, Pennsylvania,

Rhode Island, and Vermont Emission Control System Warranty

- State Warranty Enforcement Laws (Lemon Laws)

Mercedes-Benz USA, LLC  
Customer Assistance Center  
One Mercedes Drive  
Montvale, NJ 07645-0350

### Important notice for California retail buyers and lessees of Mercedes-Benz automobiles

Under California law you may be entitled to a replacement of your vehicle or a refund of the purchase price or lease price, if after a reasonable number of repair attempts Mercedes-Benz USA, LLC and/or its authorized repair or service facilities fail to fix one or more substantial defects or malfunctions in the vehicle that are covered by its express warranty. During the period of 18 months from original delivery of the vehicle or the accumulation of 18 000 miles (approximately 29 000 km) on the odometer of the vehicle, whichever occurs first, a reasonable number of repair attempts is presumed for a retail buyer or lessee if one or more of the following occurs:

- (1) the same substantial defect or malfunction results in a condition that is likely to cause death or serious bodily injury if the vehicle is driven, that defect or malfunction has been subject to repair two or more times, and you have directly notified Mercedes-Benz USA, LLC in writing of the need for its repair,
- (2) the same substantial defect or malfunction of a less serious nature than category (1) has been subject to repair four or more times and you have directly notified us in writing of the need for its repair, or
- (3) the vehicle is out of service by reason of repair of the same or different substantial defects or malfunctions for a cumulative total of more than 30 calendar days.

Written notification should not be sent to a dealer, it should be addressed to

### Maintenance

The Maintenance Booklet describes all the necessary maintenance work which should be performed at regular intervals.

Always have the Maintenance Booklet with you when you take the vehicle to an authorized Mercedes-Benz Center for service. The service advisor will record each service in the booklet for you.

### Roadside Assistance

The Mercedes-Benz Roadside Assistance Program provides factory-trained technical help in the event of a breakdown. Calls to the toll-free Roadside Assistance number

**1-800-FOR-MERCEdes (1-800-367-6372)**  
**(in the USA) 1-800-387-0100 (in Canada)**

will be answered by Mercedes-Benz Customer Assistance Representatives 24 hours a day, 365 days a year.

For additional information refer to the Mercedes-Benz Roadside Assistance Program brochure (in the USA) or the Roadside Assistance section of the Service and Warranty Information Booklet (in Canada) in your vehicle literature portfolio.

### Change of address or ownership

If you change your address, be sure to send in the "Change of Address Notice" found in the Service and Warranty Information Booklet, or simply call the Mercedes-Benz Customer Assistance Center (in the USA) at 1-800-FOR-MERCEdes (1-800-367-6372), or Customer Service (in Canada) at 1-800-387-0100. This will assist us in

contacting you in a timely manner should the need arise.

If you sell your Mercedes, please leave all literature with the vehicle to make it available to the next operator.

If you bought this vehicle used, be sure to send in the “Notice of Purchase of Used Car” found in the Service and Warranty Information Booklet, or call the Mercedes-Benz Customer Assistance Center (in the USA) at 1-800-FOR-MERcedes, or Customer Service (in Canada) at 1-800-387-0100.

### Operating your vehicle outside the USA or Canada

If you plan to operate your vehicle in foreign countries, please be aware that:

- Service facilities or replacement parts may not be readily available.
- Unleaded gasoline for vehicles with catalytic converters may not be available; the use of leaded fuels will damage the catalyts.
- Gasoline may have a considerably lower octane rating, and improper fuel can cause engine damage.

Certain Mercedes-Benz models are available for delivery in Europe under our European Delivery Program. For details, consult an authorized Mercedes-Benz Center or write to:

#### In the USA:

Mercedes-Benz USA, LLC  
European Delivery Department  
One Mercedes Drive  
Montvale, NJ 07645-0350

#### In Canada:

Mercedes-Benz Canada, Inc.  
European Delivery Department  
98 Vanderhoof Avenue  
Toronto, Ontario M4G 4C9

## Operating safety

### Warning!

Work improperly carried out on electronic components and associated software could cause them to cease functioning. Because the vehicle’s electronic components are interconnected, any modifications made may produce an undesired effect on other systems. Electronic malfunctions could seriously impair the operating safety of your vehicle.

Contact an authorized Mercedes-Benz Center for repairs or modifications to electronic components.

Other improper work or modifications on the vehicle could also have a negative impact on the operating safety of the vehicle.

Some safety systems only function while the engine is running. You should therefore never turn off the engine while driving.

### Warning!

Heavy blows against the vehicle underbody or tires/wheels may cause serious damage and impair the operating safety of your vehicle. Such blows can be caused, for example, by running over an obstacle, road debris or a pothole. If you feel a sudden significant vibration or ride disturbance, or you suspect that damage to your vehicle as occurred:

- turn on your hazard warning flashers
- slow down carefully
- drive with caution to an area which is a safe distance from the road

Inspect the vehicle underbody and tires/wheels for possible damage. If the vehicle appears unsafe, have it towed to the nearest authorized Mercedes-Benz Center or other qualified maintenance or repair facility for further inspection or repairs.

### Proper use of the vehicle

Proper use of the vehicle requires that you are familiar with the following information and rules:

- the safety precautions in this manual
- the “Technical data” section in this manual
- traffic rules and regulations
- motor vehicle laws and safety standards

#### **Warning!**

Various warning labels are attached to your vehicle. These warning labels are intended to make you and others aware of various risks. Do not remove any of these warning labels unless explicitly instructed to do so by information on the label itself. Removing warning labels may cause you and others to be unaware of certain risks which may result in an accident and/or personal injury.

### Problems with your vehicle

If you should experience a problem with your vehicle, particularly one that you believe may affect its safe operation, we urge you to contact an authorized Mercedes-Benz Center immediately to have the problem diagnosed and corrected if required. If the matter is not handled to your satisfaction, please discuss the problem with the Mercedes-Benz Center management or, if necessary, contact us at one of the following addresses:

#### **In the USA:**

Customer Assistance Center  
Mercedes-Benz USA, LLC  
One Mercedes Drive  
Montvale, NJ 07645-0350

#### **In Canada:**

Customer Relations Department  
Mercedes-Benz Canada, Inc.  
98 Vanderhoof Avenue  
Toronto, Ontario M4G 4C9

### Reporting safety defects

For the USA only:

The following text is published as required of manufacturers under Title 49, Code of U.S. Federal Regulations, Part 575 pursuant to the “National Traffic and Motor Vehicle Safety Act of 1966”.

#### **Reporting safety defects**

If you believe that your vehicle has a defect which could cause a crash or could cause injury or death, you should immediately inform the National Highway Traffic Safety Administration (NHTSA) in addition to notifying Mercedes-Benz USA, LLC.

If NHTSA receives similar complaints, it may open an investigation, and if it finds that a safety defect exists in a group of vehicles, it may order a recall and remedy campaign. However, NHTSA cannot become involved in individual problems between you, your dealer, or Mercedes-Benz USA, LLC.

To contact NHTSA, you may call the Vehicle Safety Hotline toll-free at 1-888-327-4236 (TTY: 1-800-424-9153); go to [www.safercar.gov](http://www.safercar.gov); or write to:

Administrator, NHTSA Headquarters,  
1200 New Jersey Avenue, SE, West Building,  
Washington, DC 20590.

You can also obtain other information about motor vehicle safety from [www.safercar.gov](http://www.safercar.gov).

### Vehicle data recording

#### **Information regarding electronic recording devices**

(Including notice pursuant to California Code § 9951)

Please note that your vehicle is equipped with devices that can record vehicle systems data and, if equipped with the Tele Aid system, may transmit some data in certain accidents.

This information helps, for example, to diagnose vehicle systems after a collision and to continuously improve vehicle safety. Daimler may access the information and share it with others

- for safety research or vehicle diagnosis purposes
- with the consent of the vehicle owner or lessee
- in response to an official request by law enforcement or other government agency
- for use in dispute resolution involving Daimler, its affiliates or sales/service organization and/or
- as otherwise required or permitted by law

Please check the Tele Aid subscription service agreement for details regarding the information that may be recorded or transmitted via that system.

تلفن شبانه روزی: ۰۲۱-۸۸۸۶۲۰۸۵

FarmaSOS.com



Exterior view .....	24
Cockpit .....	25
Instrument cluster .....	26
Multifunction steering wheel .....	27
Center console .....	28
Overhead control panel .....	30
Door control panel .....	30

امداد خودرو فارما

تلفن شبانه روزی: ۰۲۱-۸۸۸۶۲۰۸۵

FarmaSOS.com



Exterior view

At a glance

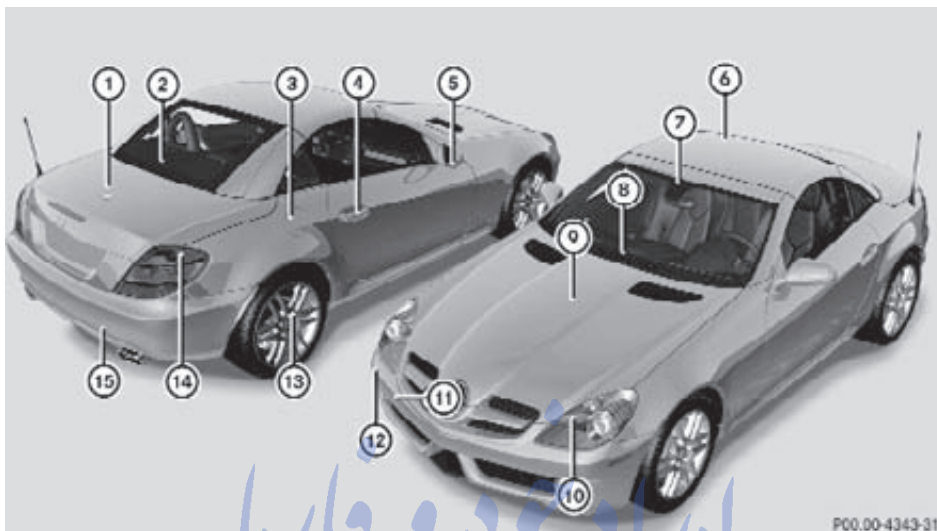

**i** This Operator's Manual describes all features, standard or optional, potentially available for your vehicle at the time of purchase. Please be aware that your vehicle might not be equipped with all features described in this manual.

	Function	Page	Function	Page	
①	Trunk:		Cleaning	229	
	Locking and unlocking	56	⑧ Wipers	76	
	Opening and closing	59	Wiper blades, replacing	271	
	Valet locking	61	Wiper blades, cleaning	229	
②	Rear window defroster	170	⑨	Hood	192
③	Fuel filler flap	190	⑩	Front lamps	267
④	Doors:		⑪	Front towing eye	286
	Locking and unlocking	56, 264	⑫	Headlamp cleaning system	74
⑤	Exterior rear view mirrors	68	⑬	Tires and wheels	197
⑥	Retractable hardtop	170	Rims and tires	297	
⑦	Windshield:		⑭	Rear lamps	267
	Wiping with washer fluid	77	⑮	Rear towing eye	286

Cockpit

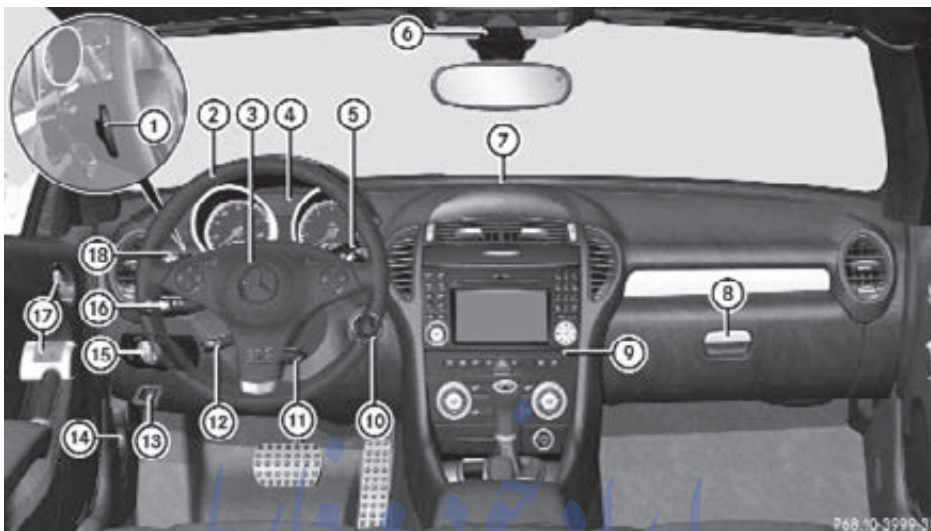

At a glance

Function	Page	Function	Page
① Steering wheel gearshift control (automatic transmission)	89	⑪ Steering wheel adjustment, manual	66
② Multifunction steering wheel	27, 94	⑫ Steering wheel adjustment, electrical Heated steering wheel	66 67
③ Horn		⑬ On-board diagnostics (OBD) socket	
④ Instrument cluster	26, 92	⑭ Hood lock release	192
⑤ Lever for Voice Control System, see separate operating instructions		⑮ Exterior lamp switch	71
⑥ Overhead control panel	30	⑯ Combination switch: Turn signals Wipers High beam	73 76 74
⑦ Sun sensor (automatic climate control)		⑰ Door control panel	30
⑧ Glove box	174	⑱ Cruise control lever	159
⑨ Center console	28		
⑩ Starter switch	61		

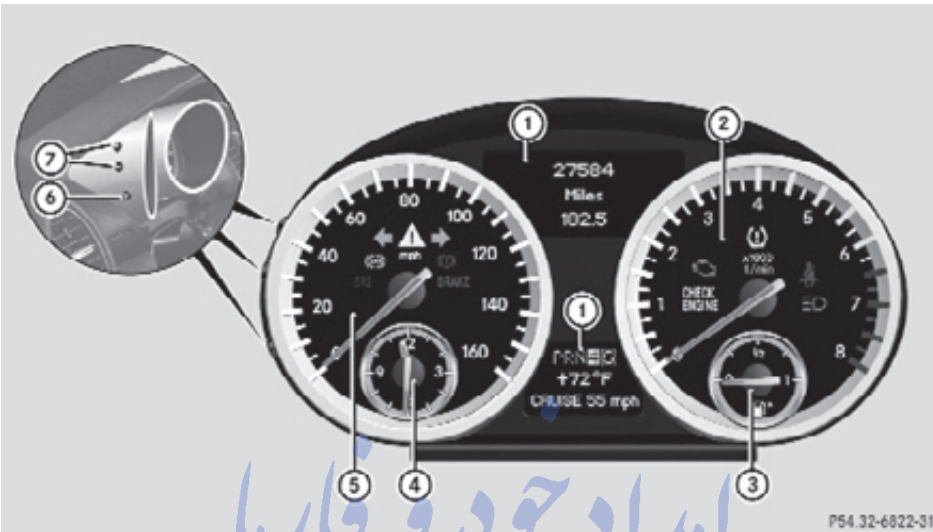

Instrument cluster

At a glance



P54 32-6822-31







	Function	Page		Function	Page	
①	Multifunction display with:		③	Seat belt telltale	42, 259	
	Trip odometer	109		High-beam headlamp indicator lamp	73	
	Main odometer	95			⑤	Fuel gauge with:
	Gear range indicator (automatic transmission)	88		Fuel tank reserve warning lamp (the arrow indicates that the fuel filler flap is on the right-hand side)		261
	Program mode indicator (automatic transmission)	88		④		Clock
Outside temperature indicator or digital speedometer (depending on selected setting in the control system)	97, 104	②	⑤	Speedometer with:		
Set speed for cruise control	159			Supplemental Restraint System (SRS) indicator lamp	32, 260	
②	Tachometer with:				Antilock Brake System (ABS) indicator lamp	257
	Engine malfunction indicator lamp, USA only			262	Left turn signal indicator lamp	
	Engine malfunction indicator lamp, Canada only	262	Electronic Stability Program (ESP <sup>®</sup> ) warning lamp	260		
	Combination low tire pressure/TPMS malfunction telltale, USA only	201, 262				

	Function	Page
	 Right turn signal indicator lamp	
	 Brake warning lamp, Canada only	258
	 Brake warning lamp, USA only	258
⑥	Reset button for: Trip odometer	93
	Settings	102
⑦	Knobs for instrument cluster illumination	93

Multifunction steering wheel







At a glance

	Function	Page
①	Multifunction display	95
②	Press button  : to answer a call	110
	to dial <sup>1</sup>	110
	to redial <sup>1</sup>	110
	Press button  : to end a call	110
	to reject an incoming call	110
	Press button  or  : to select submenus in the Settings menu	103
	to set values	
	to operate the RACETIMER <sup>2</sup>	98
	to set the volume	
③	Press button  or  : to select next/previous menu.	93

<sup>1</sup> Function only available in telephone menu.

<sup>2</sup> AMG vehicles only.

Function	Page
Press button  or  briefly: to move within a menu to select previous or next track, scene or stored station within <b>Audio/DVD</b> menu	100
to switch to the phone book and select a name or number within <b>Telephone</b> menu	110
Press and hold button  or  : to select previous or next track with quick search or to select previous or next station in station list or wave band within <b>Audio/DVD</b> menu	100
to start the quick search in the phone book within <b>Telephone</b> menu	110

## Center console

### Upper part



	Function	Page
①	Cup holder	176
②	Audio system or COMAND system (see separate operating instructions)	112
③	AIRSCARF switch, passenger side	65
④	Seat heating switch, passenger side	65
⑤	Central unlocking switch	59
⑥	Hazard warning flasher switch	74
⑦	Central locking switch Alarm system indicator lamp	59 51
⑧	Electronic Stability Program (ESP®) switch	49

	Function	Page
⑨	Seat heating switch, driver's side	65
⑩	AIRSCARF switch, driver's side	65
⑪	Passenger front air bag off indicator lamp	37, 263
⑫	Climate control system Rear window defroster switch	162 170
⑬	Cigarette lighter	177
⑭	Ashtray	177

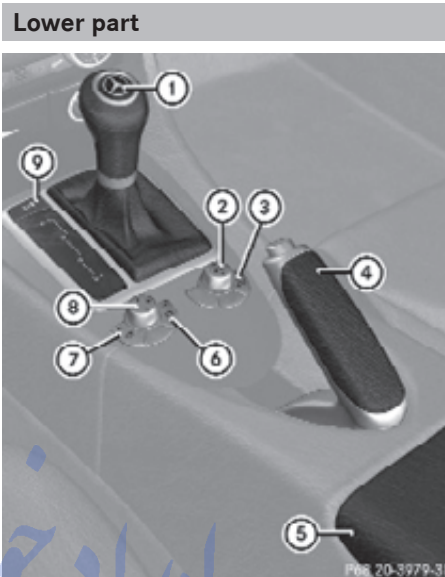

	Function	Page
①	Gearshift lever (manual transmission)	84
	Gear selector lever (automatic transmission)	85
②	Retractable hardtop switch	170
③	Tow-away alarm switch	52
④	Parking brake lever	83
⑤	Storage compartment	175
⑥	Passenger-side exterior rear view mirror button	68
⑦	Driver's side exterior rear view mirror button	68
⑧	Exterior rear view mirror adjustment button	68
⑨	Program mode selector switch (automatic transmission)	88

اراد خودرو فارما

تلفن: ۰۲۱-۸۸۶۲۰۸۵

FarmaSOS.com

At a glance

Overhead control panel



	Function	Page
①	Interior lighting switch	75
②	Automatic interior lighting	75
③	Right reading lamp switch	75
④	SOS button (Tele Aid system)	180
⑤	Garage door opener	183
⑥	Sensor for auto-dimming rear view mirrors	69
⑦	Interior rear view mirror	68
⑧	Hands-free microphone for Tele Aid (emergency call system) and telephone	178
⑨	Left reading lamp switch	75

Door control panel

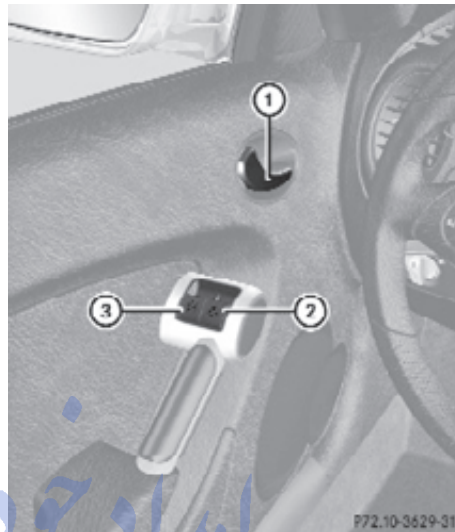

	Function	Page
①	Inside door handle	58
②	Power window switch, passenger-side window	78
③	Power window switch, driver's side window	78



Vehicle equipment .....	32
Occupant safety .....	32
Panic alarm .....	47
Driving safety systems .....	47
Anti-theft systems .....	51

امداد خودرو فارما

تلفن شبانه روزی: ۰۲۱-۸۸۸۶۲۰۸۵

FarmaSOS.com



## Vehicle equipment

- i** This Operator's Manual describes all features, standard or optional, potentially available for your vehicle at the time of purchase. Please be aware that your vehicle might not be equipped with all features described in this manual.

## Occupant safety

### Introduction

In this section you will learn the most important facts about the restraint system components of the vehicle.

The restraint systems are:

- Seat belts
- Child restraints

Additional protection potential is provided by:

- Supplemental Restraint System (SRS) with
  - Air bags
  - Air bag control unit (with crash sensors)
  - Emergency Tensioning Device (ETD) for seat belts
  - Seat belt force limiter
- Air bag system components with
  - Passenger front air bag off indicator lamp
  - Passenger seat with Occupant Classification System (OCS)

Although the systems are independent, their protective functions work in conjunction with each other.

### **Warning!**

Modifications to or work improperly conducted on restraint system components or their wiring, as well as tampering with interconnected electronic systems, can lead to the restraint systems no longer functioning as intended.

Air bags or Emergency Tensioning Devices (ETDs), for example, could deploy inadvertently or fail to deploy in accidents although the deceleration threshold for air bag deployment is exceeded. Therefore, never modify the restraint systems. Do not tamper with electronic components or their software.

- i** See "Children in the vehicle" (▷ page 45) for information on
- infants and children traveling with you in the vehicle
  - restraint systems for infants and children

### SRS indicator lamp

The SRS system conducts a self-test when the ignition is switched on and in regular intervals while the engine is running. This facilitates detection of system malfunctions.

The SRS indicator lamp **SRS** in the instrument cluster comes on when the ignition is switched on. It goes out no later than a few seconds after the engine has been started.

The SRS components are in operational readiness when the SRS indicator lamp **SRS** is not lit while the engine is running.

### **Warning!**

The SRS self-check has detected a malfunction when the SRS indicator lamp **SRS**

- does not come on at all
- fails to go out after approximately 4 seconds after the engine was started
- comes on after the engine was started or while driving

For your safety, we strongly recommend that you contact an authorized Mercedes-Benz Center immediately to have the system checked. Otherwise the SRS may not be activated when needed in an accident, which

could result in serious or fatal injury. The SRS might also deploy unexpectedly and unnecessarily which could also result in injury as well.

In addition, improper work on the SRS creates a risk of rendering the SRS inoperative or causing unintended air bag deployment. Work on the SRS must therefore only be performed by qualified technicians. Contact an authorized Mercedes-Benz Center.

If it is necessary to modify an air bag system to accommodate a person with disabilities, contact an authorized Mercedes-Benz Center. USA only: Call our Customer Assistance Center at 1-800-FOR-MERCEdes (1-800-367-6372) for details.

## Air bags

### **Warning!**

Air bags are designed to reduce the potential of injury and fatality in certain

- frontal impacts (front air bags and knee bags)
- side impacts (head-thorax air bags)

However, no system available today can completely eliminate injuries and fatalities. Deployment of the air bags temporarily releases a small amount of dust from the air bags. This dust, however, is neither harmful to your health, nor does it indicate a fire in the vehicle. The dust might cause some temporary breathing difficulty for people with asthma or other breathing trouble. To avoid this, you may wish to get out of the vehicle as soon as it is safe to do so. If you have any breathing difficulty but cannot get out of the vehicle after the air bag inflates, then get fresh air by opening a window or door.

### **Warning!**

To reduce the risk of injury when the front air bags inflate, it is very important for the driver

and passenger to always be in a properly seated position and to wear their seat belts.

For maximum protection in the event of a collision always be in normal seated position with your back against the seat backrest.

Fasten your seat belt and make sure it is properly positioned on your body.

Since the air bag inflates with considerable speed and force, a proper seating position and correct positioning of the hands on the steering wheel will help to keep you at a safe distance from the air bag. Occupants who are not wearing their seat belt, are not seated properly or are too close to the air bag can be seriously injured or killed by an air bag as it inflates with great force instantaneously:

- Sit with the seat belt properly fastened in a position that is as upright as possible with your back against the seat backrest.
- Move the driver's seat as far back as possible, still permitting proper operation of vehicle controls. The distance from the center of the driver's chest to the center of the air bag cover on the steering wheel must be at least 10 inches (25 cm) or more. You should be able to accomplish this by adjusting the seat and steering wheel. If you have any difficulties, please contact an authorized Mercedes-Benz Center.
- Do not lean your head or chest close to the steering wheel or dashboard.
- Keep hands on the outside of the steering wheel rim. Placing hands and arms inside the rim can increase the risk and potential severity of hand/arm injury when the driver front air bag inflates.
- Adjust the passenger seat as far as possible rearward from the dashboard when the seat is occupied.
- Occupants, especially children, should never place their bodies or lean their heads in the area of the door where the head-thorax air bag inflates. This could result in serious injuries or death should the head-

thorax air bag be deployed. Always sit as upright as possible, wear the seat belt properly and use an appropriately sized infant restraint, toddler restraint, or booster seat recommended for the size and weight of the child.

Failure to follow these instructions can result in severe injuries to you or other occupants. If you sell your vehicle, it is important that you make the buyer aware of this safety information. Be sure to give the buyer this Operator's Manual.

 **Warning!**

There is a possibility of a head-thorax air bag-related injury if occupants, especially children, are not properly seated or restrained when next to a head-thorax air bag which needs to deploy rapidly in a side impact in order to do its job.

To help avoid the possibility of injury, please follow these guidelines:

- (1) Occupants, especially children, should never place their bodies or lean their heads in the area of the door where the head-thorax air bag inflates. This could result in serious injuries or death should the head-thorax air bag be deployed.
- (2) Always sit as upright as possible, wear the seat belt properly, and for children 12 years old and under, use an appropriately sized infant restraint, toddler restraint, or booster seat recommended for the size and weight of the child.
- (3) Always wear seat belts properly.

If you believe that, even with the use of these guidelines, it would be safer for your passenger seat occupants to have the passenger side head-thorax air bag deactivated, then deactivation can be carried out upon your written request at an

authorized Mercedes-Benz Center at an additional cost.

Please contact an authorized Mercedes-Benz Center or call the Customer Assistance Center (in the USA) at 1-800-FOR-MERCEdes (1-800-367-6372), or Customer Service (in Canada) at 1-800-387-0100 for details.

Air bags are designed to deploy only in certain frontal impacts (front air bags and knee bags) and in side impacts (head-thorax air bags) if the system determines the need for air bag deployment. Only in the event of such a situation will they provide their supplemental protection.

The driver and passenger should always wear their seat belts. Otherwise it is not possible for the air bags to provide their supplemental protection.

In case of other types of impacts and impacts below air bag deployment thresholds, air bags will not deploy. The driver and passenger will then be protected to the extent possible by a properly fastened seat belt. A properly fastened seat belt is also needed to provide the best possible protection in a rollover.

Air bags are not a substitute for seat belts. Always wear your seat belt, regardless of whether or not your vehicle is equipped with air bags.

It is important to your safety and that of your passenger to have deployed air bags replaced and to have any malfunctioning air bags repaired. This will help to make sure the air bags will continue to provide supplemental crash protection for occupants.

**Safety guidelines for the seat belt, Emergency Tensioning Device (ETD) and air bag**

 **Warning!**

- Damaged seat belts or seat belts that have been subjected to stress in an accident must be replaced. Their anchoring points must also be checked. Only use seat belts

installed or supplied by an authorized Mercedes-Benz Center.

- Air bags and pyrotechnic Emergency Tensioning Devices (ETDs) contain perchlorate material, which may require special handling and regard for the environment. Check with your local government's disposal guidelines. California residents, see [www.dtsc.ca.gov/HazardousWaste/Perchlorate/index.cfm](http://www.dtsc.ca.gov/HazardousWaste/Perchlorate/index.cfm).
- Air bags and ETDs are designed to function on a one-time-only basis. An air bag or ETD that has deployed must be replaced.
- Do not pass seat belts over sharp edges. They could tear.
- Do not make any modification that could change the effectiveness of the seat belts.
- Do not bleach or dye seat belts as this may severely weaken them. In a crash they may not be able to provide adequate protection.
- No modifications of any kind may be made to any components or wiring of the SRS.
- Do not change or remove any component or part of the SRS.
- Do not install additional trim material, seat covers, badges, etc. over the steering wheel hub, passenger front air bag cover, outboard sides of the seat backrests, door trim panels, or door frame trims.
- Do not install additional electrical/electronic equipment on or near SRS components and wiring.
- Keep area between air bags and occupants free of objects (e.g. packages, purses, umbrellas, etc.).
- Air bag system components will be hot after an air bag has inflated. Do not touch them.
- Never place your feet on the instrument panel, dashboard, or on the seat. Always keep both feet on the floor in front of the seat.

- Improper repair work on the SRS creates a risk of rendering the SRS inoperative or causing unintended air bag deployment. Work on the SRS must therefore only be performed by qualified technicians. Contact an authorized Mercedes-Benz Center.
- For your protection and the protection of others, when scrapping the air bag unit or ETD, our safety instructions must be followed. These instructions are available from any authorized Mercedes-Benz Center.
- Given the considerable deployment speed, required inflation volume, and the material of the air bags, there is the possibility of abrasions or other, potentially more serious injuries resulting from air bag deployment.

If you sell your vehicle, we strongly recommend that you inform the subsequent owner that the vehicle is equipped with SRS. Also refer them to the applicable section in the Operator's Manual.

### Front air bags

 **Observe Safety notes, see page 33.**



Driver's front air bag ① and passenger front air bag ② are designed to provide increased protection for the driver and passenger against the risk of injuries to the head and thorax.

Driver and passenger front air bags and knee bags are deployed

- in the event of certain frontal impacts
- if the system determines that air bag deployment can offer additional protection to that provided by the seat belt
- depending on whether the respective seat belt is in use
- independently of the head-thorax air bags

The front air bags in this vehicle have been designed to inflate in two stages. This allows the air bags to have different rates of inflation. The rate of inflation is based on the vehicle deceleration rate as assessed by the air bag control unit.

The passenger front air bag deployment is additionally influenced by the passenger's weight category as identified by the Occupant Classification System (OCS) (▷ page 37).

The lighter the passenger-side occupant, the higher the vehicle deceleration rate required for second stage inflation of the passenger front air bag.

The air bags will not deploy in impacts which do not exceed the system's preset deployment thresholds. You will then be protected by the fastened seat belts.

The front air bags will not deploy in the event of a rollover unless the vehicle's rate of longitudinal deceleration or acceleration exceeds the preset deployment threshold for the front air bags.

The passenger air bag will only be deployed if

- the system, based on OCS weight sensor readings, detects that the passenger seat is occupied
- the **PASS AIR BAG OFF**  indicator lamp in the center console is not lit (▷ page 37)
- the impact exceeds a preset deployment threshold

### Knee bags

The knee bags are designed to provide increased protection for the driver and passenger against the risk of injuries to the knees, thighs and lower legs.

Driver side knee bag ④ is located on the driver side lower instrument panel. Passenger side knee bag ③ is located on the passenger side below the glove box. They are designed to operate together with the front air bags in certain frontal impacts if the system determines that air bag deployment can offer additional protection to that provided by the seat belt. The knee bags operate best in conjunction with properly positioned and fastened seat belts.

### Head-thorax air bags

 **Observe Safety notes, see page 33.**



Head-thorax air bags ① are designed to provide increased protection for the head and thorax but not for the arms.

Head-thorax air bags ① are deployed

- on the impacted side of the vehicle
- in instances with a high rate of lateral vehicle deceleration or acceleration
- if the system determines that air bag deployment can offer additional protection to that provided by the seat belt
- depending on whether the seat belt is in use

- independently of the front air bags
- independently of the ETDs

The passenger head-thorax air bag ① will only deploy if the OCS senses that the passenger seat is occupied and the impact exceeds a preset deployment threshold.

Head-thorax air bags ① are not deployed in side impacts which do not exceed the system's deployment threshold.

#### **Warning!**

Only use seat covers which have been tested and approved by Mercedes-Benz for your vehicle model. Using other seat covers may interfere with or prevent the deployment of the head-thorax air bags. Contact an authorized Mercedes-Benz Center for availability.

### Occupant Classification System

The Occupant Classification System (OCS) activates or deactivates the passenger front air bag and passenger-side knee bag automatically. The respective status is based on the classified occupant weight category determined by weight sensor readings from the passenger seat.

The system does not deactivate the passenger head-thorax air bag and the Emergency Tensioning Devices (ETDs).

To be classified correctly, the passenger must sit

- with the seat belt properly fastened
- in a position that is as upright as possible with the back against the seat backrest
- with the feet on the floor

If the occupant's weight is transferred to another object in the vehicle (e.g. by leaning on armrests), the OCS may not be able to properly approximate the occupant's weight category.

If your seat, including the trim cover and cushion, needs to be serviced in any way, take

the vehicle to an authorized Mercedes-Benz Center.

Only seat accessories approved by Mercedes-Benz may be used.

Both the driver and the passenger should always use the  indicator lamp as an indication of whether or not the passenger is properly positioned.

#### **Warning!**

If the  indicator lamp illuminates when an adult or someone larger than a small individual is in the passenger seat, have the passenger reposition himself or herself in the seat until the

 indicator lamp goes out.

In the event of a collision, the air bag control unit will not allow passenger front air bag deployment when the OCS has classified the passenger seat occupant as weighting as much as or less than a typical 12-month-old child in a standard child restraint or if the passenger seat is classified as being empty.

When the OCS senses that the passenger seat occupant is classified as being up to or less than the weight of a typical 12-month-old child in a standard child restraint, the

 indicator lamp will illuminate when the engine is started and remain illuminated, indicating that the passenger front air bag is deactivated.

When the OCS senses that the passenger seat is classified as being empty, the

 indicator lamp will illuminate when the engine is started and remain illuminated, indicating that the passenger front air bag is deactivated.

When the OCS senses that the passenger seat occupant is classified as being heavier than the weight of a typical 12-month-old child seated in a standard child restraint or as being a small individual (such as a young teenager or a small adult), the  indicator lamp will illuminate for approximately 6 seconds when the engine is started and then, depending on occupant

weight sensor readings from the seat, remain illuminated or go out. With the

 indicator lamp illuminated, the passenger front air bag is deactivated.

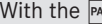
With the  indicator lamp out, the passenger front air bag is activated.

When the OCS senses that the passenger seat occupant is classified as an adult or someone larger than a small individual, the

 indicator lamp will illuminate for approximately 6 seconds when the engine is started and then go out, indicating that the passenger front air bag is activated.

If the  indicator lamp is illuminated, the passenger front air bag is deactivated and will not be deployed.

If the  indicator lamp is not illuminated, the passenger front air bag is activated and will be deployed

- in the event of certain frontal impacts
- if impact exceeds a preset deployment threshold
- independently of the head-thorax air bag

If the passenger front air bag is deployed, the rate of inflation will be influenced by

- the rate of relevant vehicle deceleration as assessed by the air bag control unit
- the passenger's weight category as identified by the OCS

For more information on air bag display messages in the multifunction display, see (> page 239).



### **Warning!**



Children 12 years old and under must be seated and properly secured in an appropriate infant restraint, toddler restraint, or booster seat recommended for the size and weight of the child.

The infant or child restraint must be properly secured with the vehicle's seat belt fully in accordance with the child seat manufacturer's instructions.

Occupants, especially children, should always sit as upright as possible, wear the seat belt properly and use an appropriately sized infant restraint, toddler restraint, or booster seat recommended for the size and weight of the child.

Children can be killed or seriously injured by an inflating air bag. Note the following important information:

- Your vehicle is equipped with air bag technology designed to deactivate the passenger front air bag in your vehicle when the system senses the weight of a typical 12-month-old child or less along with the weight of a standard appropriate child restraint on the passenger seat.
- A child in a rear-facing child restraint on the passenger seat will be seriously injured or even killed if the passenger front air bag inflates in a collision which could occur under some circumstances, even with the air bag technology installed in your vehicle.
- If you install a rear-facing child restraint on the passenger seat, make sure the  indicator lamp is illuminated, indicating that the passenger front air bag is deactivated. Should the  indicator lamp not illuminate or go out while the restraint is installed, please check installation.

Periodically check the  indicator lamp while driving to make sure the  indicator lamp is illuminated. If the  indicator lamp goes out or remains out, do not transport a child on the passenger seat until the system has been repaired.

A child in a rear-facing child restraint on the passenger seat will be seriously injured or even killed if the passenger front air bag inflates.

- If you place a child in a forward-facing child restraint on the passenger seat, move the seat as far back as possible, use the proper child restraint recommended for the age,



size and weight of the child, and secure child restraint with the vehicle's seat belt according to the child seat manufacturer's instructions. For children larger than the typical 12-month-old child, the passenger front air bag may or may not be activated.

Deployment of the driver front air bag does not mean that the passenger front air bag also should have deployed.

The OCS may have determined

- that the seat was empty or occupied by the weight up to or less than that of a typical 12-month-old child seated in a standard child restraint – both of which are instances where the system suppresses deployment of the passenger front air bag even though the impact met the criteria and was of sufficient severity to deploy the driver front air bag
- that the seat was occupied by a small individual (such as a young teenager or a small adult) or a child who weighs more than the weight of a typical 12-month-old child in a standard child restraint – both of which are instances where the system may suppress deployment of the passenger front air bag even though the impact met the criteria and was of sufficient severity to deploy the driver front air bag



**PASS AIR BAG OFF**  indicator lamp ① will be illuminated, except with the SmartKey removed from the starter switch or with the starter switch in position **0**.

### **Warning!**

If the red SRS indicator lamp **SRS** in the instrument cluster and the **PASS AIR BAG OFF**  indicator lamp are lit at the same time, there is a malfunction in the OCS. The passenger front air bag will be deactivated in this case. Have the system checked by qualified technicians as soon as possible. Contact an authorized Mercedes-Benz Center.



Only have the seat repaired or replaced at an authorized Mercedes-Benz Center.

In order to ensure proper operation of the air bag system and OCS:

- Sit with the seat belt properly fastened in a position that is as upright as possible with your back against the seat backrest.
- While seated, an occupant should not position him/herself in such a way as to cause the occupant's weight to be lifted from the seat bottom as this may result in the OCS being unable to correctly approximate the occupant's weight category.
- Read and observe all warnings in this chapter.

### **OCS Self-test**

After turning the SmartKey in the starter switch to position **1** or **2** the

**PASS AIR BAG OFF**  indicator lamp illuminates. If an adult occupant is properly sitting on the passenger seat and the system classifies the occupant as an adult, the **PASS AIR BAG OFF**  indicator lamp will illuminate and go out after approximately 6 seconds.

If the seat is not occupied and the system classifies the passenger seat as being empty, the **PASS AIR BAG OFF**  indicator lamp will illuminate and not go out.

### **Warning!**

If the **PASS AIR BAG OFF**  indicator lamp does not illuminate, the system is not functioning. You must contact an authorized Mercedes-Benz

Center before seating any child on the passenger seat.

For more information, see the “Practical hints” section (▷ page 263).

 **Warning!**

Never place anything between seat cushion and child seat (e.g. pillow), since it reduces the effectiveness of the OCS. The bottom and back of the child seat must make full contact with the passenger seat cushion and backrest.

If necessary, adjust the tilt of the passenger seat backrest.

An incorrectly mounted child seat could cause injuries to the child in case of an accident, instead of increasing protection for the child.

Follow the manufacturer’s instructions for installation of child seats.

### Seat belts

#### Safety notes

The use of seat belts and infant and child restraint systems is required by law in all 50 states, the District of Columbia, the U.S. territories and all Canadian provinces. Even where this is not the case, all vehicle occupants should have their seat belts fastened whenever the vehicle is in motion.

-  See “Children in the vehicle” (▷ page 45) for information on
  - infants and children traveling with you in the vehicle
  - restraint systems for infants and children

 **Warning!**

Always fasten your seat belt before driving off. Always make sure your passenger is properly restrained. You and your passenger should always wear seat belts.

Failure to wear and properly fasten and position your seat belt greatly increases your

risk of injuries and their likely severity in an accident.

If you are ever in an accident, your injuries can be considerably more severe without your seat belt properly buckled. Without your seat belt buckled, you are much more likely to hit the interior of the vehicle or be ejected from it. You can be seriously injured or killed.

In the same crash, the possibility of injury or death is lessened if you are properly wearing your seat belt. The air bags can only protect as intended if the occupants are properly wearing their seat belts.

 **Warning!**

Never ride in a moving vehicle with the seat backrest in an excessively reclined position as this can be dangerous. You could slide under the seat belt in a collision. If you slide under it, the seat belt would apply force at the abdomen or neck. That could cause serious or even fatal injuries. The seat backrest and seat belt provide the best restraint when the wearer is in a position that is as upright as possible and the seat belt is properly positioned on the body.

 **Warning!**

Never let more people ride in the vehicle than there are seat belts available. Make sure everyone riding in the vehicle is correctly restrained with a separate seat belt. Never use a seat belt for more than one person at a time.

 **Warning!**

Damaged seat belts or seat belts that have been subjected to stress in an accident must be replaced. Also, the seat belt anchoring points must be checked.

Only use seat belts which have been approved by Mercedes-Benz.

Do not make any modifications to the seat belts. This can lead to unintended activation of the ETDs or to their failure to activate when necessary.

Do not bleach or dye seat belts as this may severely weaken them. In a crash they may not be able to provide adequate protection. Have all work carried out only by qualified technicians. Contact an authorized Mercedes-Benz Center.

## Proper use of seat belts

### **Warning!**

#### USE SEAT BELTS PROPERLY

- Seat belts can only protect when used properly. Never wear seat belts in any other way than as described in this section, as that could result in serious injuries in case of an accident.
- Each occupant should wear their seat belt at all times, because seat belts help reduce the likelihood of and potential severity of injuries in accidents, including rollovers. The integrated restraint system includes SRS (driver front air bag, knee bags, passenger front air bag, head-thorax air bags), Emergency Tensioning Devices (ETDs) and seat belt force limiters. The system is designed to enhance the protection offered to properly belted occupants in certain frontal (front air bags, knee bags and ETDs) and side (head-thorax air bags and ETDs) impacts which exceed preset deployment thresholds.
- Never wear the shoulder belt under your arm, against your neck or off your shoulder. In a frontal crash, your body would move too far forward. That would increase the chance of head and neck injuries. The seat belt would also apply too much force to the ribs or abdomen, which could severely injure internal organs such as your liver or spleen.

Adjust the seat belt so that the shoulder section is located as close as possible to the middle of the shoulder. It should not touch the neck. Never pass the shoulder portion of the seat belt under your arm.

- Position the lap belt as low as possible on your hips and not across the abdomen. If the lap belt is positioned across your abdomen, it could cause serious injuries in a crash.
- Never wear seat belts over rigid or breakable objects in or on your clothing, such as eyeglasses, pens, keys etc., as these might cause injuries.
- Make sure the seat belt is always fitted snugly. Take special care of this when wearing loose clothing.
- Never use a seat belt for more than one person at a time. Do not fasten a seat belt around a person and another person or other objects at the same time.
- Seat belts should not be worn twisted. In a crash, you would not have the full width of the seat belt to distribute impact forces. The twisted seat belt against your body could cause injuries.
- Pregnant women should also always use a lap/shoulder belt. The lap belt portion should be positioned as low as possible on the hips to avoid any possible pressure on the abdomen.
- Place the seat backrest in a position that is as upright as possible.
- Check your seat belt during travel to make sure it is properly positioned.
- Never place your feet on the instrument panel, dashboard, or on the seat. Always keep both feet on the floor in front of the seat.
- When using a seat belt to secure infant restraints, toddler restraints, or children in booster seats, always follow the child seat manufacturer's instructions.

### **Warning!**

Do not pass seat belts over sharp edges. They could tear.

Do not allow the seat belt to get caught in the door or in the seat adjustment mechanism.

This could damage the seat belt.

Never attempt to make modifications to seat belts. This could impair the effectiveness of the seat belts.

### Fastening the seat belts

#### **Warning!**

Children 12 years old and under must be seated and properly secured in an appropriately sized infant restraint, toddler restraint, or booster seat recommended for the size and weight of the child. For additional information, see section “Children in the vehicle”.

A child’s risk of serious or fatal injuries is significantly increased if the child restraints are not properly secured in the vehicle and/or the child is not properly secured in the child restraint.

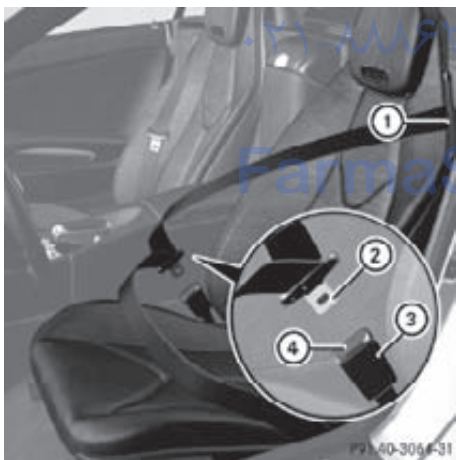

- ▶ With a smooth motion, pull the seat belt out of the seat belt outlet. Loop ① guides the seat belt.
- ▶ Place the shoulder portion of the seat belt across the top of your shoulder and the lap portion across your hips.

- ▶ Push latch plate ② into buckle ③ until it clicks.

- ▶ If necessary, tighten the lap portion to a snug fit by pulling shoulder portion up.

The passenger lap/shoulder belt has a special seat belt retractor to secure child restraints properly. For more information on special seat belt retractors, see “Infant and child restraint systems” (▷ page 45).

To release the seat belt with seat belt release button ④, see (▷ page 42).

### Releasing the seat belts

- ▶ Press seat belt release button ④ (▷ page 42).

Allow the retractor to completely rewind the seat belt by guiding latch plate ② (▷ page 42).

- ❗ Make sure the seat belt retracts completely. Otherwise the seat belt and/or latch plate could get caught or pinched in the door or in the seat mechanism. This can damage the seat belt and impair its effectiveness, and/or cause damage to the door and/or door trim panel. Such damage is not covered by the Mercedes-Benz Limited Warranty.



Damaged seat belts must be replaced. Contact an authorized Mercedes-Benz Center.

### Enhanced seat belt reminder system

When the engine is started, the seat belt telltale  will always illuminate for 6 seconds to remind you and your passenger to fasten your seat belts.

If the driver’s seat belt is not fastened when the engine is started, an additional warning chime will sound. The warning chime goes out after approximately 6 seconds or once the driver’s seat belt is fastened.

If after these 6 seconds the driver's or the passenger's seat belt (with the passenger seat occupied) is not fastened with both doors closed,

- the seat belt telltale  remains illuminated for as long as either the driver's or passenger's seat belt is not fastened.
- and if the vehicle speed once exceeds 15 mph (25 km/h), the seat belt telltale  starts flashing and a warning chime sounds with increasing intensity for a maximum of 60 seconds or until the driver's and passenger's seat belt are fastened.

If you and/or your passenger release the seat belt during driving, the seat belt telltale  starts flashing and the warning chime sounds as described before.

If the driver's or the passenger's seat belt remains unfastened after 60 seconds, the warning chime stops sounding, the seat belt telltale  stops flashing but continues to be illuminated.

After a vehicle standstill, the warning chime is reactivated and the seat belt telltale  is flashing again if the vehicle speed once exceeds 15 mph (25 km/h).

The seat belt telltale  will only go out if both the driver's and the passenger's seat belt (with the passenger seat occupied) are fastened, or the vehicle is standing still and a door is opened.

For more information, see "Practical hints" (▷ page 259).

### Emergency Tensioning Device (ETD), seat belt force limiter

The seat belts are equipped with ETDs and seat belt force limiters.

The ETDs are designed to activate in the following cases:

- in frontal or rear-end impacts exceeding the system's preset deployment threshold
- if the restraint systems are operational and functioning correctly, see "SRS indicator lamp" (▷ page 32)
- in certain vehicle rollovers if the system determines an additional degree of protection

The ETDs will only activate if the seat belts are fastened (latch plate properly inserted into buckle).

In an impact, the ETDs remove slack from the seat belts in such a way that the seat belts fit more snugly against the body. Seat belt force limiters, when activated, are employed to help reduce the peak force exerted by the seat belts on occupants during a crash.

- ❗ The ETDs do not correct an incorrect seat position or incorrectly worn seat belts.

The ETDs do not pull occupants back toward the seat backrest.

#### Warning!

Pyrotechnic ETDs that were activated must be replaced.

For your safety, when disposing of the pyrotechnic ETDs always follow our safety instructions. These are available at any authorized Mercedes-Benz Center.

#### Correct driver seat adjustment

#### Warning!

In order to avoid possible loss of vehicle control the following must be done before the vehicle is put into motion:

- seat adjustment
- head restraint adjustment
- steering wheel adjustment

- rear view mirror adjustment
- fastening of seat belts



### Steering wheel

 **Observe Safety notes, see page 66.**

- Position steering wheel ① properly. See (▷ page 66) for manual adjustment and (▷ page 66) for electrical adjustment.

Make sure:

- You can reach the steering wheel with your arms slightly bent at the elbows.
- You can move your legs freely.
- All displays (including malfunction and indicator lamps) on the instrument cluster are clearly visible.

### Seat belt

 **Observe Safety notes, see page 40.**

- Fasten and position your seat belt ② correctly (▷ page 42).

Make sure:

- The seat belt is always fitted snugly.
- Adjust the seat belt so that the shoulder section is located as close as possible to the middle of the shoulder.
- Place the lap portion of the seat belt as low as possible on your hips.

### Seat and head restraint

 **Observe Safety notes, see page 62.**

- Position seat ③ and head restraint properly. See (▷ page 63) for seat and head restraint adjustment.

Observe the following points:

- Always be in a properly seated position.
- The position should be as far rearward from the front air bag in the steering wheel as possible, while still permitting proper operation of vehicle controls.
- Adjust the seat to a comfortable seating position that still allows you to reach the accelerator/brake pedal safely.
- The seat must be adjusted so that you can correctly fasten and position your seat belt.
- The seat backrest must be in a position that is as nearly upright as possible.
- Adjust the seat cushion so that the front edge of the seat cushion lightly supports your legs.
- Adjust the head restraint so that it is as close to the head as possible and the center of the head restraint supports the back of the head at eye level.
- Never place hands under the seat or near any moving parts while the seat is being adjusted.

## Children in the vehicle

### Safety notes

If an infant or child is traveling with you in the vehicle:

- ▶ Secure the child using an infant or child restraint appropriate to the age and size of the child.
- ▶ Make sure the infant or child is properly secured at all times while the vehicle is in motion.

#### **Warning!**

When leaving the vehicle, always remove the SmartKey from the starter switch. Always take the SmartKey with you and lock the vehicle. Do not leave children unattended in the vehicle, even if they are secured in a child restraint system, or with access to an unlocked vehicle. A child's unsupervised access to a vehicle could result in an accident and/or serious personal injury. The children could

- injure themselves on parts of the vehicle
- be seriously or fatally injured through excessive exposure to extreme heat or cold
- injure themselves or cause an accident with vehicle equipment that can be operated even if the SmartKey is removed from the starter switch or removed from the vehicle, such as seat adjustment, steering wheel adjustment, or the memory function

If children open a door, they could injure other persons or get out of the vehicle and injure themselves or be injured by following traffic.

Do not expose the child restraint system to direct sunlight. The child restraint system's metal parts, for example, could become very hot, and the child could be burned by these parts.

#### **Warning!**

Do not carry heavy or hard objects in the passenger compartment unless they are firmly secured in place.

Unsecured or improperly positioned cargo increases a child's risk of injury in the event of

- strong braking maneuvers
- sudden changes of direction
- an accident

### Infant and child restraint systems

#### **Observe Safety notes, see page 45.**

We recommend all infants and children be properly restrained at all times while the vehicle is in motion.

The passenger lap/shoulder belt has a special seat belt retractor for secure fastening of child restraints.

To fasten a child restraint, follow the child restraint manufacturer's instructions for mounting.

To activate the special seat belt retractor:

- ▶ Pull the shoulder belt out completely and let it retract.

During seat belt retraction, a ratcheting sound can be heard to indicate that the special seat belt retractor is activated. The seat belt is now locked.

- ▶ Push down on child restraint to take up any slack.

To deactivate the special seat belt retractor:

- ▶ Release the seat belt buckle and let the seat belt retract completely.

The seat belt can then again be used in the usual manner.

#### **Warning!**

Never release the seat belt buckle while the vehicle is in motion, since the special seat belt retractor will be deactivated.

The use of infant or child restraints is required by law in all 50 states, the District of Columbia, the U.S. territories and all Canadian provinces.

Infants and small children should be seated in an appropriate infant or child restraint system. They must be properly secured by a lap/shoulder belt in accordance with the manufacturer's instructions for the child restraint. All infant or child restraint systems must comply with U.S. Federal Motor Vehicle Safety Standards 213 and 225 and Canadian Motor Vehicle Safety Standards 213 and 210.2.

A statement by the child restraint manufacturer of compliance with these standards can be found on the instruction label on the restraint and in the instruction manual provided with the restraint.

When using any infant restraint, toddler restraint, or booster seat, make sure to carefully read and follow all manufacturer's instructions for installation and use.

Please read and observe warning labels affixed to the inside of the vehicle and to infant or child restraints.

#### **Warning!**

Children 12 years old and under must be seated and properly secured in an appropriate infant restraint, toddler restraint, or booster seat recommended for the size and weight of the child.

The infant or child restraint must be properly secured with the vehicle's seat belt fully in accordance with the child seat manufacturer's instructions.

Occupants, especially children, should always sit as upright as possible, wear the seat belt properly and use an appropriately sized infant restraint, toddler restraint, or booster seat recommended for the size and weight of the child.

Children can be killed or seriously injured by an inflating air bag. Note the following important information:

- Your vehicle is equipped with air bag technology designed to deactivate the passenger front air bag in your vehicle when the system senses the weight of a

typical 12-month-old child or less along with the weight of a standard appropriate child restraint on the passenger seat.

- A child in a rear-facing child restraint on the passenger seat will be seriously injured or even killed if the passenger front air bag inflates in a collision which could occur under some circumstances, even with the air bag technology installed in your vehicle.

- If you install a rear-facing child restraint on the passenger seat, make sure the

 indicator lamp is illuminated, indicating that the passenger front air bag is deactivated. Should the

 indicator lamp not illuminate or go out while the restraint is installed, please check installation.

Periodically check the 

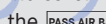
indicator lamp while driving to make sure the  indicator lamp is

illuminated. If the  indicator lamp goes out or remains out, do not transport a child on the passenger seat until the system has been repaired.

A child in a rear-facing child restraint on the passenger seat will be seriously injured or even killed if the passenger front air bag inflates.

- If you place a child in a forward-facing child restraint on the passenger seat, move the seat as far back as possible, use the proper child restraint recommended for the age, size and weight of the child, and secure child restraint with the vehicle's seat belt according to the child seat manufacturer's instructions. For children larger than the typical 12-month-old child, the passenger front air bag may or may not be activated.

#### **Warning!**

Infants and small children should never share a seat belt with another occupant. During an accident, they could be crushed between the occupant and seat belt.



A child's risk of serious or fatal injuries is significantly increased if the child restraints are not properly secured in the vehicle and/or the child is not properly secured in the child restraint.

Children too big for a toddler restraint must ride in seats using regular seat belts. Position shoulder belt across chest and shoulder, not face or neck. A booster seat may be necessary to achieve proper seat belt positioning for children over 41 lb (18 kg) until they reach a height where a lap/shoulder belt fits properly without a booster.

When the child restraint is not in use, remove it from the vehicle or secure it with the seat belt to prevent the child restraint from becoming a projectile in the event of an accident.

### Panic alarm



- ▶ **Activating:** Press and hold **PANIC** button ① for at least 1 second. An audible alarm and flashing exterior lamps will operate.

- ① Without the antenna on the left rear side of the vehicle installed, the SmartKey signaling range for the panic alarm is considerably reduced. The panic alarm then only functions if the SmartKey is held in close proximity towards the antenna base.

- ▶ **Deactivating:** Press **PANIC** button ① again.
- or

- ▶ Insert the SmartKey into the starter switch.

- ① **USA only:**

This device complies with Part 15 of the FCC Rules. Operation is subject to the following two conditions:

1. This device may not cause harmful interference, and
2. this device must accept any interference received, including interference that may cause undesired operation.

Any unauthorized modification to this device could void the user's authority to operate the equipment.

- ① **Canada only:**

This device complies with RSS-210 of Industry Canada. Operation is subject to the following two conditions:

1. This device may not cause interference, and
2. this device must accept any interference received, including interference that may cause undesired operation of the device.

Any unauthorized modification to this device could void the user's authority to operate the equipment.

### Driving safety systems

#### Introduction

This section contains information about the following driving safety systems:

- ABS (Antilock Brake System)
- BAS (Brake Assist System)
- ESP® (Electronic Stability Program)

- i** In winter operation, the maximum effectiveness of most of the driving systems described in this section is only achieved with winter tires, or snow chains as required.

### Safety notes

#### **Warning!**

The following factors increase the risk of accidents:

- Excessive speed, especially in turns
- Wet and slippery road surfaces
- Following another vehicle too closely

The driving safety systems described in this section cannot reduce these risks or prevent the natural laws of physics from acting on the vehicle. They cannot increase braking or steering efficiency beyond that afforded by the condition of the vehicle brakes and tires or the traction afforded.

Only a safe, attentive, and skillful driver can prevent accidents.

The capabilities of a vehicle equipped with the driving safety systems described in this section must never be exploited in a reckless or dangerous manner which could jeopardize the user's safety or the safety of others.

Always adjust your driving style to the prevailing road and weather conditions and keep a safe distance to other road users and objects on the street.

If a driving system malfunctions, other driving safety systems may also switch off. Observe indicator and warning lamps that may come on as well as messages in the multifunction display that may appear.

### ABS

 **Observe Safety notes, see page 48.**

#### **Warning!**

Do not pump the brake pedal. Use firm, steady brake pedal pressure instead. Pumping the brake pedal defeats the purpose of the ABS and significantly reduces braking effectiveness.

The Antilock Brake System (ABS) regulates the brake pressure so that the wheels do not lock during braking. This allows you to maintain the ability to steer your vehicle.

The ABS is functional above a speed of approximately 5 mph (8 km/h) independent of road surface conditions.

On slippery road surfaces, the ABS will respond even to light brake pressure.

The ABS indicator lamp  in the instrument cluster comes on when you switch on the ignition. It goes out when the engine is running.

#### **Braking** تلفن شبانه روزی ۰۲۱ ۸۸۴۲۰۸۸

At the instant one of the wheels is about to lock up, a slight pulsation can be felt in the brake pedal. The pulsation indicates that the ABS is in the regulating mode.

- ▶ Keep firm and steady pressure on the brake pedal while you feel the pulsation.

Continuous, steady brake pedal pressure yields the advantages provided by the ABS, namely braking power and the ability to steer the vehicle.

The pulsating brake pedal can be an indication of hazardous road conditions and functions as a reminder to take extra care while driving.

#### **Emergency brake maneuver**

- ▶ Keep continuous full pressure on the brake pedal.

**⚠ Warning!**

If the ABS malfunctions, other driving safety systems such as the BAS or the ESP® are also switched off. Observe indicator and warning lamps that may come on as well as messages in the multifunction display that may appear. If the ABS malfunctions, the wheels may lock during hard braking, reducing steering capability and extending the braking distance.

**BAS****⚠ Observe Safety notes, see page 48.**

The Brake Assist System (BAS) operates in emergency situations. If you apply the brakes very quickly, the BAS provides full brake boost automatically, thereby potentially reducing the braking distance.

- ▶ Apply continuous full braking pressure until the emergency braking situation is over. The ABS will prevent the wheels from locking.

When you release the brake pedal, the brakes function again as normal. The BAS is then deactivated.

**⚠ Warning!**

If the BAS malfunctions, the brake system still functions, but without the additional brake boost available that the BAS would normally provide in an emergency braking maneuver. Therefore, the braking distance may increase.

**ESP®****⚠ Observe Safety notes, see page 48.**

The Electronic Stability Program (ESP®) is operational as soon as the engine is running. It monitors the vehicle's traction (force of adhesive friction between the tires and the road surface) and handling.

The ESP® recognizes that the vehicle deviates from the direction of travel as intended by the driver. By applying brakes to individual

wheels and by limiting the engine output, the ESP® works to stabilize the vehicle. The ESP® is especially useful while driving off and on wet or slippery road surfaces. The ESP® also stabilizes the vehicle during braking and steering maneuvers.

The ESP® warning lamp  in the instrument cluster comes on when you switch on the ignition. It goes out when the engine is running.

The ESP® warning lamp  in the instrument cluster flashes when the ESP® is engaged.

**⚠ Warning!**

Never switch off the ESP® when you see the ESP® warning lamp  flashing in the instrument cluster. In this case proceed as follows:

- When driving off, apply as little throttle as possible.
- While driving, ease up on the accelerator pedal.
- Adapt your speed and driving style to the prevailing road conditions.

Failure to observe these guidelines could cause the vehicle to skid. The ESP® cannot prevent accidents resulting from excessive speed.

- ❗ Because the ESP® operates automatically, the engine and ignition must be shut off (SmartKey in starter switch position **0** or **1**) when the parking brake is being tested on a brake test dynamometer or when the vehicle is being towed with the front axle raised.

Active braking action through the ESP® may otherwise seriously damage the brake system which is not covered by the Mercedes-Benz Limited Warranty.

- ❗ The ESP® will only function properly if you use wheels of the recommended tire size

as specified in the “Technical data” section of this Operator’s Manual.

- i** The cruise control switches off automatically when the ESP® engages.

### Electronic Traction System (ETS)

#### **Observe Safety notes, see page 48.**

The ETS (Electronic Traction System) is a component of the ESP®. The ETS improves the vehicle’s ability to utilize available traction, especially under slippery road conditions by applying the brakes to a spinning wheel.

When you switch off the ESP®, the ETS is still enabled.

### Switching off the ESP®

#### **Warning!**

The ESP® should not be switched off during normal driving other than in the circumstances described below. Disabling the system will reduce vehicle stability in driving maneuvers.

Do not switch off the ESP® when a spare wheel is mounted.

To improve the vehicle’s traction, switch off the ESP®. This allows the drive wheels to spin and thus cut into surfaces for better grip, for example

- when driving with snow chains
- in deep snow
- in sand or gravel

#### **Warning!**



Switch on the ESP® immediately if the aforementioned circumstances do not apply anymore. Otherwise the ESP® will not stabilize the vehicle when it is starting to skid or a wheel is spinning.

When you switch off the ESP®,

- the ESP® does not stabilize the vehicle
- the engine output is not limited, which allows the drive wheels to spin and thus cut into surfaces for better grip
- the ETS will still apply the brakes to a spinning wheel
- the ESP® continues to operate when you are braking
- the cruise control cannot be activated
- the cruise control switches off if activated

- i** When the ESP® is switched off and one or more drive wheels are spinning, the ESP® warning lamp  in the instrument cluster flashes. However, the ESP® will then not stabilize the vehicle.



- ▶ With the engine running, press ESP® switch  until the ESP® warning lamp  in the instrument cluster comes on. The ESP® is switched off.

#### **Warning!**

When the ESP® warning lamp  is illuminated continuously, the ESP® is switched off or is not operational due to a malfunction. Vehicle stability in standard driving maneuvers is reduced.

Adapt your speed and driving to the prevailing road conditions and to the non-operating status of the ESP®.

**!** Avoid spinning of a drive wheel for an extended period with the ESP® switched off. This may cause serious damage to the drivetrain which is not covered by the Mercedes-Benz Limited Warranty.

### Switching on the ESP®

- ▶ Press ESP® switch ① until the ESP® warning lamp  in the instrument cluster goes out. You are now again in normal driving mode with the ESP® switched on.

## Anti-theft systems

### Immobilizer

The immobilizer prevents unauthorized persons from starting your vehicle.

When leaving the vehicle, always take the SmartKey with you and lock the vehicle. The engine can be started by anyone with a valid SmartKey that is left inside the vehicle.

### Activating

- ▶ Remove the SmartKey from the starter switch.

### Deactivating

- ▶ Switch on the ignition.

**i** Starting the engine will also deactivate the immobilizer.

In the event that the engine cannot be started (yet the vehicle's battery is charged), the system is not operational. Contact an authorized Mercedes-Benz Center or call 1-800-FOR-MERCEdes (in the USA) or 1-800-387-0100 (in Canada).

### Anti-theft alarm system

Once the alarm system has been armed, a visual and audible alarm is triggered when someone opens

- a door
- the trunk
- the hood
- the glove box
- the storage compartment under the armrest

The alarm will stay on even if the activating element, a door, for example, is closed immediately.

The alarm system will also be triggered when

- the vehicle is raised (tow-away alarm)
- the vehicle is opened with the mechanical key
- a door is opened from the inside
- the trunk is opened with the emergency release button

To cancel the alarm after it has been triggered, see "Canceling the alarm" (▶ page 53).

**i** If the alarm stays on for more than 30 seconds, the Tele Aid system initiates a call to the Customer Assistance Center automatically. The Tele Aid system will initiate the call provided that

- you have subscribed to the Tele Aid service
- the Tele Aid service has been activated properly
- the necessary mobile phone, power supply and GPS coverage are available

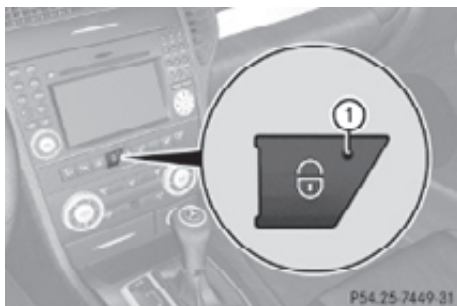

- ▶ **Arming:** Lock the vehicle with the SmartKey.

The turn signal lamps flash three times and an acoustic warning sounds three times to indicate that the vehicle is locked. Indicator lamp ① flashes to indicate that the alarm system is armed.

- ❗ If the turn signal lamps do not flash three times and the acoustic warning does not sound three times, a door or the trunk may not be properly closed.

Close the respective element.

- ▶ **Disarming:** Unlock the vehicle with the SmartKey.

The turn signal lamps flash once and an acoustic warning sounds once to indicate that the alarm system is disarmed.

- ❗ Unless you open a door or the trunk within approximately 40 seconds after unlocking the vehicle:

- The vehicle will be locked again.
- The anti-theft alarm system will be rearmed.

### Tow-away alarm

Once the tow-away alarm is armed, a visual and audible alarm will be triggered when someone attempts to raise the vehicle.

To cancel the alarm after it has been triggered, see “Canceling the alarm” (> page 53).

- ❗ If the alarm stays on for more than 30 seconds, a call to the Customer Assistance Center is initiated automatically by the Tele Aid system provided that you have subscribed to the Tele Aid service and that it has been activated properly, and that the necessary mobile phone, power supply and GPS coverage are available.

- ▶ **Arming:** Lock the vehicle with the SmartKey.

The tow-away alarm is armed after about 30 seconds automatically.

- ▶ **Disarming:** Unlock the vehicle with the SmartKey.

The tow-away alarm remains disarmed until you lock the vehicle again.

### Disabling tow-away alarm

To prevent triggering the tow-away alarm, disable the tow-away alarm feature before towing the vehicle, or when parking on a surface subject to movement, such as a ferry or auto train.

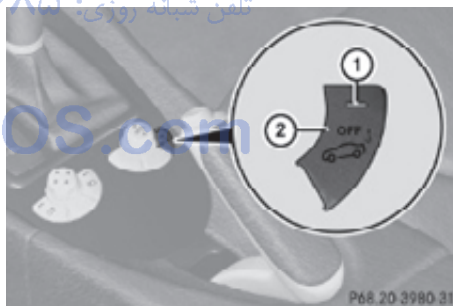

- ▶ Remove the SmartKey from the starter switch.



- ▶ Press tow-away alarm switch ②. Indicator lamp ① comes on briefly.

- ▶ Exit and lock the vehicle.

The tow-away alarm remains disabled until you lock the vehicle again.

### Canceling the alarm

To cancel the alarm, do one of the following:

- ▶ Insert the SmartKey into the starter switch.
- ▶ Press button  or  on the SmartKey.

امداد خودرو فارما

تلفن شبانه روزی: ۰۲۱-۸۸۸۶۲۰۸۵

FarmaSOS.com

# امداد خودرو فارما

تلفن شبانه روزی: ۰۲۱-۸۸۸۶۲۰۸۵

[FarmaSOS.com](http://FarmaSOS.com)



Vehicle equipment .....	56
Locking and unlocking .....	56
Starter switch positions .....	61
Seats .....	62
Multifunction steering wheel .....	66
Mirrors .....	68
Memory function .....	70
Lighting .....	70
Wipers .....	76
Power windows .....	78
Driving and parking .....	79
Manual transmission .....	84
Automatic transmission .....	85
Instrument cluster .....	92
Control system .....	93
Audio system .....	112
Driving systems .....	159
Climate control system .....	162
Rear window defroster .....	170
Retractable hardtop .....	170
Loading and storing .....	174
Useful features .....	176

ایجاد و درو فارما

۰۲۱-۸۸۸۶۲۰۸۵

FarmaSOS.com



### Vehicle equipment

**i** This Operator's Manual describes all features, standard or optional, potentially available for your vehicle at the time of purchase. Please be aware that your vehicle might not be equipped with all features described in this manual.

### Locking and unlocking

#### Notes

**⚠ Observe Safety notes, see page 45.**

When unlocking or locking the vehicle with the SmartKey an acoustic signal sounds. The acoustic signal is activated at the factory. If you wish to deactivate the feature, or adjust its signal volume, contact an authorized Mercedes-Benz Center.

When unlocking the vehicle, all turn signal lamps flash once. An acoustic signal sounds once, and the locking knobs in the doors move up. The anti-theft alarm system is disarmed.

When locking the vehicle, all turn signal lamps flash three times. An acoustic signal sounds three times, and the locking knobs in the doors move down. The anti-theft alarm system is armed.

All doors and the trunk must be closed.

If you cannot lock or unlock the vehicle with the SmartKey, the batteries in the SmartKey are discharged, the SmartKey is malfunctioning, or the vehicle battery is drained.

- ▶ Check the batteries in the SmartKey (▷ page 57) and replace them if necessary.
- ▶ Use the mechanical key to unlock the driver's door and the trunk (▷ page 264).

- ▶ Use the mechanical key to lock the vehicle (▷ page 265).
- ▶ Have the vehicle battery and the vehicle battery connections checked at an authorized Mercedes-Benz Center.

If the SmartKey is malfunctioning, contact Roadside Assistance or an authorized Mercedes-Benz Center.

### SmartKey

Your vehicle comes supplied with two SmartKeys, each with remote control and a removable mechanical key.

The SmartKey centrally locks and unlocks

- the doors
- the trunk lid
- the fuel filler flap
- the glove box
- the storage compartment under the armrest



- ① Lock button
- ② Unlock button for trunk lid
- ③ Unlock button

When you open a door, the windows on that side lowers slightly. Once you close the door, the windows move up again.

**!** A window will not work if it is blocked with ice or if the vehicle battery is discharged. If you cannot shut a door, do not force it or you could damage the door or the window.

Fix whatever is affecting the window before trying to shut the door.

- i** Without the antenna on the left rear side of the vehicle installed, the SmartKey signaling range is considerably reduced. Hold the SmartKey in close proximity towards the antenna base when locking or unlocking the vehicle.

**i** USA only:

This device complies with Part 15 of the FCC Rules. Operation is subject to the following two conditions:

1. This device may not cause harmful interference, and
2. this device must accept any interference received, including interference that may cause undesired operation.

Any unauthorized modification to this device could void the user's authority to operate the equipment.

**i** Canada only:

This device complies with RSS-210 of Industry Canada. Operation is subject to the following two conditions:

1. This device may not cause interference, and
2. this device must accept any interference received, including interference that may cause undesired operation of the device.

Any unauthorized modification to this device could void the user's authority to operate the equipment.

### Factory setting

- ▶ **Global unlocking:** Press button .



Unless you open a door or the trunk within approximately 40 seconds after unlocking the vehicle:

- The vehicle will be locked again.
- The anti-theft alarm system will be rearmed.

- ▶ **Global locking:** Press button .

### Selective setting

If you frequently travel alone, you may wish to reprogramm the SmartKey. Pressing button  will then only unlock the driver's door, interior lockable storage compartments, and the fuel filler flap.

- ▶ **Switching on/off:** Press and hold buttons  and  simultaneously for approximately 6 seconds until the battery check lamp (> page 57) flashes twice.

The SmartKey will then function as follows:



- ▶ **Unlocking driver's door and fuel filler flap:** Press button  once.

- ▶ **Global unlocking:** Press button  twice.

- ▶ **Global locking:** Press button .

### Checking SmartKey batteries





- ▶ Press button  or  on the SmartKey. Battery check lamp ① comes on briefly to indicate that the SmartKey batteries are in order.

If the battery check lamp does not come on briefly during check, the SmartKey batteries are discharged.

► Replace the batteries (▷ page 266).

**i** You can obtain the required batteries at any authorized Mercedes-Benz Center.

**i** If the batteries are checked within signal range of the vehicle, pressing button  or  will lock or unlock the vehicle accordingly.

### Loss of the SmartKey

If you lose your SmartKey or mechanical key, you should do the following:

- Have the SmartKey deactivated by an authorized Mercedes-Benz Center.
- Report the loss of the SmartKey or the mechanical key to your car insurance company immediately.
- Have the mechanical lock replaced if necessary.

Any authorized Mercedes-Benz Center will be glad to supply you with a replacement. For information on replacing the SmartKey, see “Replacing the SmartKey” (▷ page 58).

### Replacing the SmartKey

Only you, or someone authorized by you can order a replacement key from any Mercedes-Benz Center. In order to do so, the Mercedes-Benz Center will require proof of identity and vehicle ownership with original documents, including the following:

**If you are the current owner of the vehicle:**

- the vehicle’s current state registration
- a current identity card, passport, or drivers license

**If you are an authorized person:**

- the vehicle’s current state registration
  - a current identity card, passport, or drivers license for the authorized individual
  - signed and dated authorization from the owner of the vehicle for which the key is being requested
- i** Duplicated or photocopied documentation will not be accepted.

### Activating the key

Once you, or an authorized person, has provided the appropriate documents, the Mercedes-Benz Center will need to synchronize the key to your vehicle before it can be used. In order to do so, the Mercedes-Benz Center need access to your vehicle.

### Opening the doors from the inside

You can open a locked door from the inside. Open door only when conditions are safe to do so.



Example illustration driver’s door

If the vehicle has previously been locked with the SmartKey, opening a door from the inside will trigger the anti-theft alarm system.

To cancel the alarm, see (▷ page 53).

- Pull on inside door handle ② on the respective door.  
If the door was locked, locking knob ① will move up.

When you open a door, the windows on that side lowers slightly. Once you close the door, the windows move up again.

**!** A window will not work if it is blocked with ice or if the vehicle battery is discharged. If you cannot shut a door, do not force it or you could damage the door or the window. Fix whatever is affecting the window before trying to shut the door.

### Automatic central locking

You can switch the automatic central locking on or off using the control system (▷ page 108).

The doors and the trunk lock automatically when the vehicle is set into motion.

You can open a locked door from the inside. Open door only when conditions are safe to do so.

The doors are designed to unlock automatically after an accident if the force of the impact exceeds a preset threshold.

The vehicle locks automatically when the ignition is switched on and the wheels are turning at a vehicle speed of above 9 mph (15 km/h). You could therefore lock yourself out when the vehicle is pushed or towed or is on a test stand.

### Locking and unlocking from the inside

**!** Observe Safety notes, see page 45.

You can lock or unlock the vehicle from the inside using the central locking or unlocking switch. This can be useful, for example, if you want to lock the vehicle before starting to drive.

The central locking or unlocking switch does not lock or unlock the fuel filler flap or the interior storage compartments, such as the glove box.

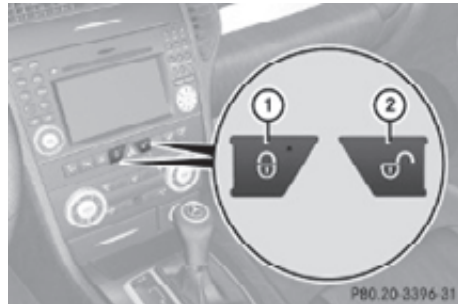

► **Locking:** Press central locking switch ①. When all doors are closed, the vehicle locks.

► **Unlocking:** Press central unlocking switch ②.

You can open a locked door from the inside. Open door only when conditions are safe to do so.

If the vehicle was previously locked with the central locking switch

- and the SmartKey is set to factory settings, the complete vehicle is unlocked when a door is opened from the inside
- and the SmartKey is set to selective settings, only the door opened from inside is unlocked

If the vehicle has been locked centrally with the SmartKey, it will not unlock using the central unlocking switch.

### Opening the trunk

**!** Warning!

Make sure the trunk is closed when the engine is running and while driving. Among other dangers, deadly carbon monoxide (CO) gases may enter vehicle interior resulting in unconsciousness and death.

**!** When you open the trunk, the trunk lid swings open upwards. Always make sure there is sufficient overhead clearance.

You can open the trunk when the vehicle is stationary and the retractable hardtop is fully opened or closed.

A minimum height clearance of 5.78 ft (1.76 m) is required to open the trunk lid.

### Controls in detail

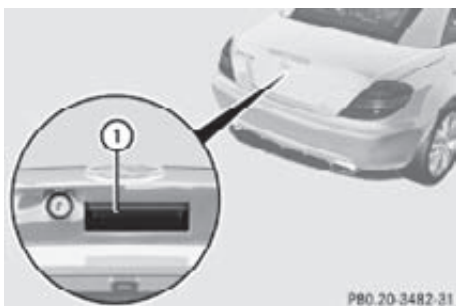

- ▶ Press and hold button  on the SmartKey.  
The trunk lid is unlocked and opens slightly.

or

- ▶ Pull on handle .
- ▶ Lift the trunk lid and swing it open.

### Closing the trunk

#### **Warning!**

Make sure the trunk is closed when the engine is running and while driving. Among other dangers, deadly carbon monoxide (CO) gases may enter vehicle interior resulting in unconsciousness and death.

#### **Warning!**

To prevent possible personal injury, always keep hands and fingers away from the trunk opening when closing the trunk lid. Be especially careful when small children are around.

#### **Observe Safety notes, see page 45.**

Do not leave the SmartKey in the open trunk. You may lock yourself out.

If the vehicle was previously locked centrally with the SmartKey, the trunk lid will lock

automatically when closed. All turn signal lamps flash three times to confirm locking.

-  When the hardtop is retracted, it must be completely lowered in the trunk before the trunk can be closed (▷ page 170).



- ▶ Lower the trunk lid using handle .
- ▶ Close trunk lid with hands placed flat on trunk lid.

### Trunk lid emergency release

The trunk lid can be opened from inside the trunk with the emergency release button.

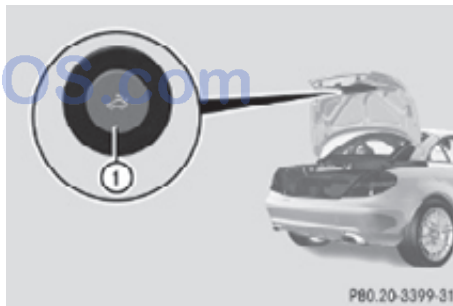

- ▶ Briefly press emergency release button .
- ▶ Push up the trunk lid to fully open.

The emergency release button unlocks the trunk while the vehicle is standing still or in motion.

Illumination of the emergency release button:

- The button flashes for 30 minutes after opening the trunk.
- The button flashes for 60 minutes after closing the trunk.

The emergency release button does not unlock the trunk, if the vehicle battery is discharged or disconnected.

If the vehicle has previously been locked centrally with the SmartKey, opening the trunk from the inside using the emergency release button will trigger the anti-theft alarm system.

To cancel the alarm, see (▷ page 53).

### Valet locking

You can lock the trunk separately with the mechanical key. This denies unauthorized access to the trunk, e.g. when you valet park the vehicle.

- ▶ Leave only the SmartKey less its mechanical key with the vehicle.



- ▶ **Valet locking:** Close the trunk.
- ▶ Remove the mechanical key from the SmartKey (▷ page 264).
- ▶ Insert the mechanical key in the trunk lid lock.
- ▶ Turn the mechanical key clockwise to position **2** and remove the mechanical key in that position to lock the trunk.

The trunk remains locked even when the vehicle is centrally unlocked.

You can then only open the trunk with the mechanical key.

- ▶ **Canceling:** Insert the mechanical key in the trunk lid lock.
- ▶ Turn the mechanical key counterclockwise to neutral position **1** and remove the mechanical key in that position to unlock the trunk.  
You can now open the trunk.

### Starter switch positions

#### SmartKey

⚠ Observe Safety notes, see page 45.

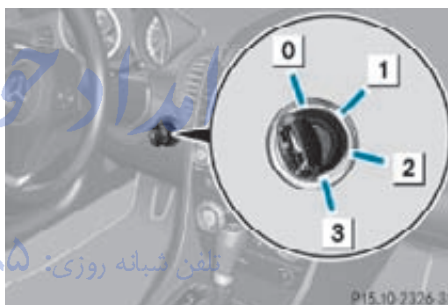

Starter switch

- 0** For removing SmartKey  
Vehicles with automatic transmission:  
Gear selector lever must be in park position **P**.
- 1** Power supply for some electrical consumers, e.g. wipers
- 2** Ignition (power supply for all electrical consumers) and driving position
- 3** Starting position

When you switch on the ignition, all lamps in the instrument cluster come on. The high-beam headlamp indicator lamp and turn signal indicator lamps will only come on if activated. If a lamp in the instrument cluster fails to come on when the ignition is switched on, have it checked and replaced if necessary. If a lamp in the instrument cluster remains on after starting the engine or comes on while

driving, refer to “Lamps in instrument cluster” (▷ page 256).

If the SmartKey is left in starter switch position **0** for an extended period of time, it can no longer be turned in the starter switch. In this case, the steering is locked. To unlock, remove SmartKey from the starter switch and reinsert.

The steering is locked when the SmartKey is removed from the starter switch.

- ▶ Always remove the SmartKey from the starter switch when the engine is not in operation.  
This will help to prevent accelerated vehicle battery discharge or a completely discharged vehicle battery.

If the SmartKey cannot be turned in the starter switch, the vehicle battery may not be sufficiently charged.

- ▶ Check the vehicle battery and charge it if necessary (▷ page 283).

or

- ▶ Get a jump start (▷ page 283).

## Seats

### Safety notes

#### **Warning!**

In order to avoid possible loss of vehicle control the following must be done before the vehicle is put into motion:

- seat adjustment
- head restraint adjustment
- steering wheel adjustment
- rear view mirror adjustment
- fastening of seat belts

#### **Warning!**

Do not adjust the driver's seat while driving. Adjusting the seat while driving could cause the driver to lose control of the vehicle.

Never ride in a moving vehicle with the seat backrest in an excessively reclined position as this can be dangerous. You could slide under the seat belt in a collision. If you slide under it, the seat belt would apply force at the abdomen or neck. That could cause serious or fatal injuries. The seat backrest and seat belts provide the best restraint when the wearer is in a position that is as upright as possible and seat belts are properly positioned on the body.

#### **Warning!**

Your seat must be adjusted so that you can correctly fasten your seat belt.

Observe the following points:

- Adjust the seat backrest until your arms are slightly angled when holding the steering wheel.
- Adjust the seat to a comfortable seating position that still allows you to reach the accelerator/brake pedal safely. The position should be as far back as possible with the driver still able to operate the controls properly.
- Adjust the head restraint so that it is as close to the head as possible. The center of the head restraint must support the back of the head at eye level.
- Never place hands under the seat or near any moving parts while a seat is being adjusted.

Failure to do so could result in an accident and/or serious personal injury.

#### **Warning!**

Children 12 years old and under must be seated and properly secured in an appropriately sized infant restraint, toddler restraint, or booster seat recommended for the size and weight of the child. For additional information, see section “Children in the vehicle”.

A child's risk of serious or fatal injuries is significantly increased if the child restraints



are not properly secured in the vehicle and/or the child is not properly secured in the child restraint.

### **Warning!**

For your protection, drive only with properly positioned head restraints.

Adjust the head restraint so that it is as close to the head as possible and the center of the head restraint supports the back of the head at eye level. This will reduce the potential for injury to the head and neck in the event of an accident or similar situation.

Do not drive the vehicle without the seat head restraints. Head restraints are intended to help reduce injuries during an accident.

## Seat adjustment

The seats can be adjusted either manually or electrically, depending on the vehicle's equipment.

- !** When moving the seats, make sure there are no items in the footwell or behind the seats. Otherwise, you could damage the seats and/or the items.

### Manual seat adjustment

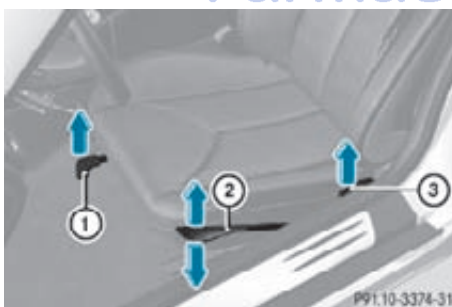

- ▶ **Seat fore and aft adjustment:** Pull handle ①.
- ▶ Slide the seat to the desired position.
- ▶ Allow handle ① to reengage with an audible click.

- ▶ Check for proper engagement before driving.
- ▶ **Seat height:** Pull or push handle ② up or down and adjust the seat height until your legs are lightly supported.
- ▶ **Seat backrest tilt:** Pull handle ③ and adjust the seat backrest until your arms are slightly angled when holding the steering wheel.
- ▶ Release handle ③ when the desired seat backrest tilt is reached. When you hear an audible click, the seat backrest is again fixed into place.

### Power seats

#### **Warning!**

The power seats can be operated at any time. Therefore, do not leave children unattended in the vehicle, or with access to an unlocked vehicle. A child's unsupervised access to a vehicle could result in an accident and/or serious personal injury.

- i** Vehicles without memory function:

The seats can be adjusted within 5 minutes after either front door has been opened.

The counter resets each time

- you open or close a front door
- you insert the SmartKey into the starter switch
- you remove the SmartKey from the starter switch
- you switch the ignition on or off

Just like in vehicles with memory function, the power seats can be operated at any time when the ignition is switched on.

- i** The memory function (> page 70) lets you store the settings for the seat position together with the settings for the steering wheel (electrical) and exterior rear view mirrors.

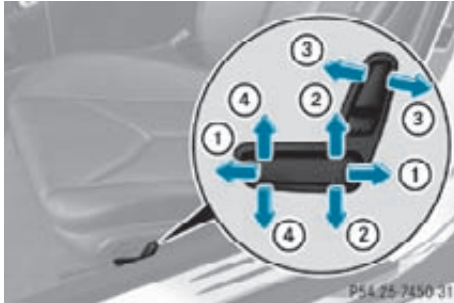

- ▶ **Seat fore and aft adjustment:** Press the switch forward or backward in direction of arrow ①.
- ▶ **Seat backrest tilt:** Press the switch forward or backward in direction of arrow ③.
- ▶ **Seat height:** Press the switch up or down in direction of arrow ②.
- ▶ **Seat cushion tilt:** Press the switch up or down in direction of arrow ④ until your upper legs are lightly supported.

#### Head restraint height adjustment, manual

##### **Warning!**

For your protection, drive only with properly positioned head restraints.

Adjust the head restraint so that it is as close to the head as possible and the center of the head restraint supports the back of the head at eye level. This will reduce the potential for injury to the head and neck in the event of an accident or similar situation.

Do not drive the vehicle without the seat head restraints. Head restraints are intended to help reduce injuries during an accident.



- ▶ Adjust the height of head restraints manually by pulling them upwards or pushing them downwards.

#### Lumbar support

You can adjust the contour of the seat's lumbar support to help enhance support to your spine.

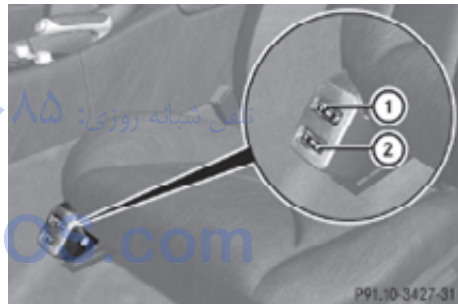

- ▶ Switch on the ignition.
- ▶ Turn adjustment wheels ① and ② until you have reached the desired seat curvature.

### Seat heating

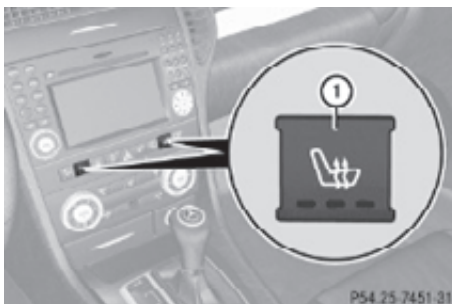

The red indicator lamps in seat heating switch ① come on to show which heating level you have selected.

The seat heating switches from level **3** (high) to level **2** after approximately 5 minutes.

The seat heating switches from level **2** to level **1** (low) after approximately 10 minutes.

After approximately 20 minutes in level **1**, the seat heating switches off automatically.

- ▶ Switch on the ignition.
- ▶ **Switching on:** Press seat heating switch ①.  
Three red indicator lamps in seat heating switch ① come on.
- ▶ Press seat heating switch ① repeatedly until the desired seat heating level is set.
- ▶ **Switching off:** Press seat heating switch ① repeatedly until all indicator lamps go out.

If one or more of the indicator lamps in seat heating switch ① are flashing, there is insufficient voltage available since too many electrical consumers are turned on. The seat heating switches off automatically.

The seat heating will switch back on again automatically as soon as sufficient voltage is available.

### AIRSCARF neck-level heating

The AIRSCARF neck-level heating provides the area surrounding the occupants' necks

with a heated air stream flowing from openings in the head restraints.

#### ⚠ Warning!

When switching on the AIRSCARF neck-level heating, the air streaming from the openings may be very hot. When in close proximity to the openings, you could be seriously burned. To help avoid serious personal injuries, switch the AIRSCARF to a lower heating level.

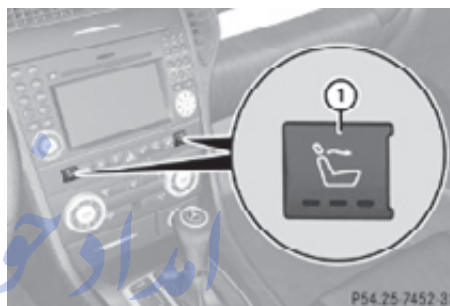

- ▶ Switch on the ignition.
- ▶ **Switching on:** Press AIRSCARF switch ① for the desired side.  
All three indicator lamps on respective AIRSCARF switch ① come on. After a preheating time of approximately 7 seconds, the blower starts.
- ▶ Press AIRSCARF switch ① repeatedly until the desired AIRSCARF heating level for the corresponding seat is reached.
- ▶ **Switching off:** Press AIRSCARF switch ① repeatedly until all indicator lamps on AIRSCARF switch ① go out.

After switching off the AIRSCARF neck-level heating, the AIRSCARF fan continues to operate for approximately 10 seconds to cool down the heater elements.

If one or more indicator lamps on AIRSCARF switch ① are flashing, there is insufficient voltage available since too many electrical consumers are turned on. The AIRSCARF neck-level heating switches off automatically.

The AIRSCARF neck-level heating will switch back on again automatically as soon as sufficient voltage is available.

## Multifunction steering wheel

### Safety notes

#### ⚠ Warning!

Do not adjust the steering wheel while driving. Adjusting the steering wheel while driving, or driving without the steering wheel adjustment feature locked could cause the driver to lose control of the vehicle.

The electrical steering wheel adjustment feature can be operated at any time. Therefore, do not leave children unattended in the vehicle, or with access to an unlocked vehicle. A child's unsupervised access to a vehicle could result in an accident and/or serious personal injury.

Make sure

- you can reach the steering wheel with your arms slightly bent at the elbows
- you can move your legs freely
- all displays (including malfunction and indicator lamps) on the instrument cluster are clearly visible

### Steering wheel adjustment, manual

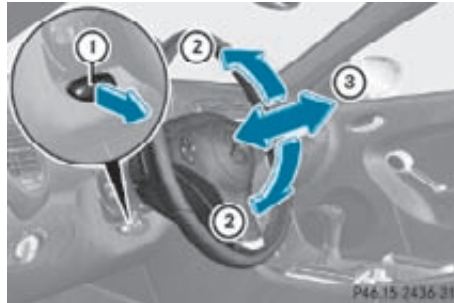

- ① Release handle
- ② Adjusting steering wheel, up or down
- ③ Adjusting steering wheel, in or out

► **Unlocking:** Pull release handle ① out to its stop limit.

► Move steering wheel to the desired position.

► **Locking:** Push release handle ① back to its original position.

► Make sure the steering wheel is securely locked by trying to move it up and down as well as in and out before driving off.

### Steering wheel adjustment, electrical

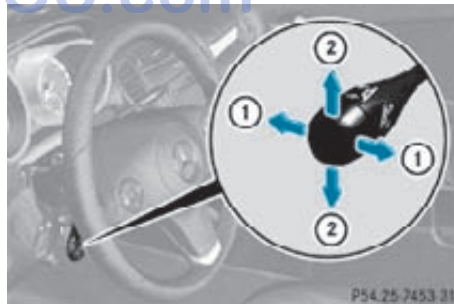

► **Adjusting steering wheel in or out:** Move stalk in direction of arrows ①.

► **Adjusting steering wheel up or down:** Move stalk in direction of arrows ②.

ⓘ The memory function (▷ page 70) lets you store the settings for the steering

wheel together with the settings for the seat position and the exterior rear view mirrors.

### Easy-entry/exit feature

This feature allows the driver an easier entry into and exit from the vehicle. When entering and exiting the vehicle, the steering wheel is in its uppermost position.

The easy-entry/exit feature can be activated or deactivated in the Convenience submenu of the control system (▷ page 108).

#### **Warning!**

You must make sure no one can become trapped or injured by the moving steering wheel when the easy-entry/exit feature is activated.

To stop steering wheel movement do one of the following:

- Move steering wheel adjustment stalk.
- Press one of the memory position buttons.
- Press memory button **M**.

Do not leave children unattended in the vehicle, or with access to an unlocked vehicle. Children could open the driver's door and unintentionally activate the easy-entry/exit feature, which could result in an accident and/or serious personal injury.

With the easy-entry/exit feature activated, the steering wheel will return to its last set position when you close the driver's door with the ignition switched on. The steering wheel will also return to its last set position when you insert the SmartKey into the starter switch.

- i** The last set steering wheel position is stored when the ignition is switched off or the position is stored in memory (▷ page 70).

With the easy-entry/exit feature activated, the steering wheel tilts upwards when you remove the SmartKey from the starter switch.

The steering wheel also tilts upwards when you open the driver's door with the SmartKey in starter switch position **0** or **1**.

- i** When the current position for the steering wheel is in the uppermost tilt position, the steering wheel will no longer be able to move upward when the easy-entry/exit feature is activated.

The adjustment procedure is briefly interrupted when the engine is started.

#### **Warning!**

Let the system complete the adjustment procedure before setting the vehicle in motion. All steering wheel adjustment must be completed before setting the vehicle in motion. Driving off with the steering wheel still adjusting could cause the driver to lose control of the vehicle.

### Crash-responsive exit aid

When you open the driver's door after an accident has occurred, the steering column moves up. The position of the SmartKey in the starter switch is insignificant. This function facilitates exiting as well as rescue of vehicle occupants.

The crash-responsive exit aid can only be triggered when the easy-entry/exit feature is activated via the control system.

### Heated steering wheel

The steering wheel heating warms up the leather area of the steering wheel.

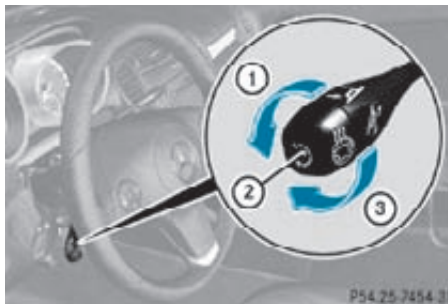

- ▶ Switch on the ignition.
- ▶ **Switching on:** Turn switch at the tip of the stalk in direction of arrow ①. Indicator lamp ② comes on.

**i** The steering wheel heating may be suspended temporarily. However, indicator lamp ② remains on. The steering wheel heating is suspended when the temperature of the vehicle interior is above 86°F (30°C). It is also suspended when the temperature of the steering wheel is above 95°F (35°C).

When these conditions do not apply anymore, steering wheel heating continues.

- ▶ **Switching off:** Turn switch at the tip of stalk in direction of arrow ③. Indicator lamp ② goes out.

**i** Indicator lamp ② flashes or goes out in case of power surge or undervoltage or if the steering wheel heating malfunctions.

**i** The steering wheel heating switches off automatically when you remove the SmartKey from the starter switch.

For more information on the steering wheel, see “Multifunction steering wheel” (> page 94).

## Mirrors

### Notes

Adjust the interior and exterior rear view mirrors before driving so that you have a good view of the road and traffic conditions.

### Interior rear view mirror

- ▶ Adjust the interior rear view mirror manually.

### Interior rear view mirror, antiglare position



- ▶ Tilt the mirror to the antiglare position by moving lever towards the windshield. The interior rear view mirror is dimmed.

### Exterior rear view mirrors

#### ⚠ Warning!

Exercise care when using the passenger-side exterior rear view mirror. The mirror surface is convex (outwardly curved surface for a wider field of view). Objects in mirror are closer than they appear. Check your interior rear view mirror and glance over your shoulder before changing lanes.

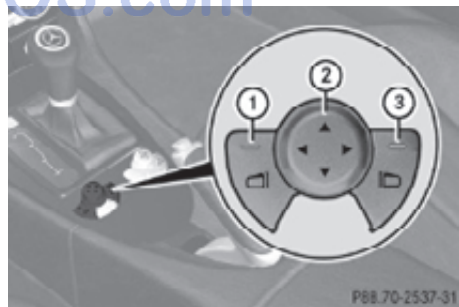

- ▶ Switch on the ignition.
- ▶ Press button ① for the driver's side exterior rear view mirror or button ③ for

the passenger-side exterior rear view mirror.

The indicator lamp in the respective button comes on for approximately 10 seconds.

If you do not make adjustments to the selected exterior rear view mirror within 10 seconds, the indicator lamp goes out. You will then have to select the desired exterior rear view mirror again before adjustments can be made. Adjustments can only be made with the indicator lamp for the respective exterior rear view mirror button illuminated.

- ▶ Press adjustment button ② up, down, left or right according to the desired setting.

**!** If an exterior rear view mirror was forcibly hit from the front, manually snap it back into place.

- i** At low ambient temperatures, the exterior rear view mirrors will be heated automatically.

### Auto-dimming rear view mirrors

The exterior rear view mirror on the driver's side and the interior rear view mirror will respond automatically to glare when the ignition is switched on and incoming light from headlamps falls on the sensor in the interior rear view mirror.

The rear view mirrors will not react if reverse gear **R** is engaged or the interior lighting is switched on.

#### **⚠ Warning!**

The auto dimming function does not react if incoming light is not aimed directly at sensors in the interior rear view mirror.

The interior rear view mirror and the exterior rear view mirror on the driver's side do not react, for example, if the cloth wind screen is installed.

Light hitting the mirror(s) at certain angles (incident light) could blind you. As a result,

you may not be able to observe traffic conditions and could cause an accident.

### Exterior rear view mirror parking position

To assist during parking maneuvers, you can set the passenger-side exterior rear view mirror so that you can see the rear wheel and the road curb.

### Setting and storing the parking position

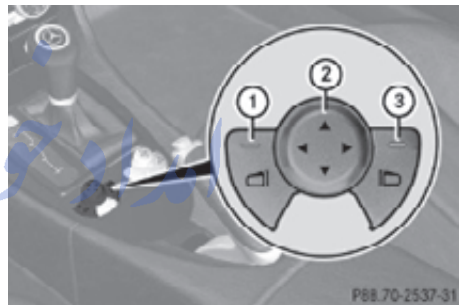

- ▶ Switch on the ignition.
- ▶ Press button ③, to select the passenger-side exterior rear view mirror.
- ▶ Shift the automatic transmission into reverse gear **R** (manual transmission to reverse gear).  
The passenger-side exterior rear view mirror moves to the preset parking position.
- ▶ Adjust the passenger-side exterior rear view mirror with adjustment button ② so that you see the rear wheel and the road curb.
- ▶ Press memory button **M** (▷ page 70) and within 3 seconds, press one of the arrows of adjustment button ②.  
The parking position is stored if the exterior rear view mirror does not move.

### Calling up the parking position

- ▶ Switch on the ignition.
- ▶ Press button ②, to select the passenger-side exterior rear view mirror.
- ▶ Shift the automatic transmission into reverse gear **R** (manual transmission to reverse gear).  
The passenger-side exterior rear view mirror moves to the stored parking position.

The passenger-side exterior rear view mirror returns to its previously stored driving position

- 10 seconds after you have put the gear selector lever out of reverse gear **R** (manual transmission out of reverse)
- immediately once your vehicle exceeds a speed of approximately 6 mph (10 km/h)
- immediately when you press button ① to select the driver's side exterior rear view mirror

### Memory function

#### Notes

With the memory function you can store up to three different configurations per front seat.

Each memory position button on the driver's side can store all of the following settings:

- Seat position
- Steering wheel position
- Exterior rear view mirrors' position

#### **Warning!**

Do not activate the memory function while driving. Activating the memory function while driving could cause the driver to lose control of the vehicle.

Each memory position button on the passenger side can store the setting of the seat position.

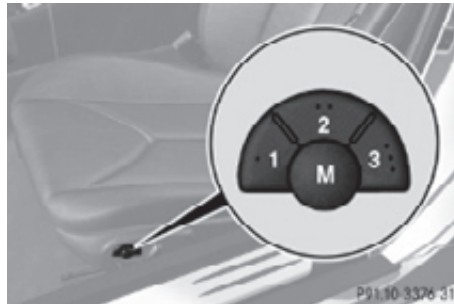

### Storing positions into memory

- ▶ Adjust the seats.
- ▶ On the driver's side, also adjust the steering wheel and exterior rear view mirrors to the desired positions.
- ▶ Press memory button **M** once and within 3 seconds press memory position button **1**, **2** or **3**.

When the settings are stored to the selected position, an acknowledgement signal sounds.

### Recalling positions from memory

- ▶ Press and hold desired memory position button **1**, **2** or **3** until the seat has moved to the stored position completely. On the driver's side, also wait for the steering wheel and exterior rear view mirrors to move to the stored position.

- i** Releasing the memory position button stops movement to the stored positions immediately.

### Lighting

#### Notes

- i** If you drive in countries with left-hand driving, you must have the headlamps modified for symmetrical low beams.



Relevant information can be obtained at any authorized Mercedes-Benz Center.

**i** Vehicles equipped with active Bi-Xenon headlamps:

The active Bi-Xenon headlamps increase usable illumination over conventional headlamps because they follow the curvature of the road ahead. The beams of the active Bi-Xenon headlamps shift to either side according to the vehicle's steering angle and speed.

### Exterior lamp switch

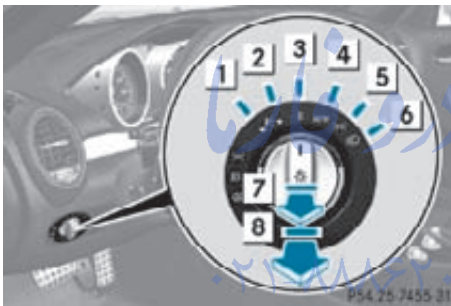

- 1 Standing lamps, left
- 2 Standing lamps, right
- 3 Off  
Daytime running lamp mode
- 4 Automatic headlamp mode  
Daytime running lamp mode
- 5 Parking lamps (also tail lamps, license plate lamps, side marker lamps and instrument panel lamps)
- 6 Low-beam headlamps or high-beam headlamps
- 7 Front fog lamps
- 8 Rear fog lamp

**i** If you hear a warning signal you have forgotten to switch off the low-beam headlamps or the parking lamps before opening the driver's door.

In addition, the message Switch Off Lights appears in the multifunction display.

Switch off the low-beam headlamps or the parking lamps.

If the message Switch off lights or remove key appears in the multifunction display remove the SmartKey from the starter switch or switch off the headlamps.

**!** Failure to switch off the exterior lamps when leaving the vehicle may result in a discharged battery.

### Low-beam headlamps

The low-beam headlamps can be switched on and off with the exterior lamp switch.

► **Switching on:** Turn the exterior lamp switch to position .

The following lamps come on:

- Low-beam headlamps
- Tail lamps
- Parking lamps
- License plate lamps
- Side marker lamps
- Instrument panel lamps
- Green indicator lamp in the exterior lamp switch

► **Switching off:** Turn the exterior lamp switch to position .

### Automatic headlamp mode



The following lamps come on and go out automatically depending on the brightness of the ambient light:

- Low-beam headlamps
- Tail lamps
- Parking lamps
- License plate lamps
- Side marker lamps

 **Warning!**

If the exterior lamp switch is set to **AUTO**, the headlamps will not automatically come on under foggy conditions.

To minimize risk to you and to others, activate headlamps by turning exterior lamp switch to  when driving or when traffic and/or ambient lighting conditions require you to do so.

In low ambient lighting conditions, only switch from position **AUTO** to  with the vehicle at a standstill in a safe location. Switching from **AUTO** to  will briefly switch off the headlamps. Doing so while driving in low ambient lighting conditions may result in an accident.

The automatic headlamp feature is only an aid to the driver. The driver is responsible for the operation of the vehicle's lights at all times.

- ▶ **Switching on:** Turn the exterior lamp switch to position **AUTO**.

The following lamps come on and go out depending on the brightness of the ambient light with the SmartKey in starter switch position **1**:

- Tail lamps
- Parking lamps
- License plate lamps
- Side marker lamps

When the engine is running, the low-beam headlamps will also come on and turn off automatically.

**Canada only:** High-beam headlamps are only available with the exterior lamp switch in position .

**Daytime running lamp mode**

In Canada, the daytime running lamp mode is mandatory and therefore in a constant mode. In the USA, the daytime running lamp mode is deactivated by default.

- ▶ Activate the daytime running lamp mode using the control system, see "Switching daytime running lamp mode on or off (USA only)" (▷ page 106).

- ▶ Turn the exterior lamp switch to position  or **AUTO**.

When the engine is running, the low-beam headlamps come on.

In low ambient lighting conditions, the following lamps will come on additionally:

- Tail lamps
- Parking lamps
- License plate lamps
- Side marker lamps

With the daytime running lamp mode activated and the engine running, you cannot switch off the low-beam headlamps manually.



**Canada only**

With the exterior lamp switch in position  or **AUTO**, you cannot switch on the high-beam headlamps.

The high-beam flasher is available at all times.

- ▶ For nighttime driving turn the exterior lamp switch to position  to permit activation of the high-beam headlamps.

When the engine is running, and you

- shift from a driving position to neutral position **N** or park position **P** with the vehicle at a standstill (vehicles with automatic transmission), the low-beam headlamps will go out with a delay of 3 minutes
- turn the exterior lamp switch to position , the low-beam headlamps, the tail and parking lamps, the license plate lamps and the side marker lamps come on
- turn the exterior lamp switch to position , the manual headlamp mode has priority over the daytime running lamp mode



The corresponding exterior lamps come on (▷ page 71).

### USA only

With the exterior lamp switch in position  or **AUTO**, you cannot switch on the high-beam headlamps.

The high-beam flasher is available at all times.

- ▶ For nighttime driving turn the exterior lamp switch to position  to permit activation of the high-beam headlamps.

When the engine is running, and you turn the exterior lamp switch to position  or , the manual headlamp mode has priority over the daytime running lamp mode.

The corresponding exterior lamps come on (▷ page 71).

### Fog lamps



Fog lamps cannot be switched on with the exterior lamp switch in position **AUTO**.

#### **Warning!**



In low ambient lighting or foggy conditions, only switch from position **AUTO** to  with the vehicle at a standstill in a safe location.

Switching from **AUTO** to  will briefly switch off the headlamps. Doing so while driving in low ambient lighting conditions may result in an accident.

Fog lamps will operate with the parking lamps and/or the low-beam headlamps on. Fog lamps should only be used in conjunction with low-beam headlamps. Consult your State or Province Motor Vehicle Regulations regarding permissible lamp operation.

- ▶ Turn the exterior lamp switch to position  or  (▷ page 71).
- ▶ **Switching on front fog lamps:** Pull out the exterior lamp switch to first stop. The green indicator lamp  in the exterior lamp switch comes on.

- ▶ **Switching on rear fog lamp:** Pull out the exterior lamp switch to second stop.

The rear fog lamp, the front fog lamps, the green  and the yellow indicator lamp  in the exterior lamp switch come on.

- ▶ **Switching off front fog lamps/rear fog lamp:** Push in the exterior lamp switch to its stop.



### Locator lighting and night security illumination

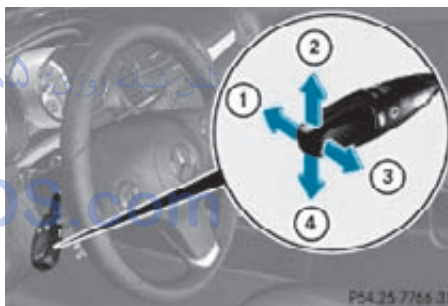

Locator lighting and night security illumination are described in the “Control system” section, see “Switching locator lighting on or off” (▷ page 106) and “Switching night security illumination (Headlamps delayed shut-off feature) on or off” (▷ page 107).

### Combination switch



### Turn signals

- ▶ Press the combination switch in direction of arrow  or .



The corresponding turn signal indicator lamp  or  in the instrument cluster flashes.

The combination switch resets automatically after major steering wheel movements.

### To signal minor directional changes:

- ▶ Press the combination switch only to the point of resistance in direction of arrow ② or ④ and release.  
The corresponding turn signal lamps will flash three times.

### High beam

- ▶ Turn the exterior lamp switch to position  (▷ page 71).
- ▶ **Switching on:** Push the combination switch in direction of arrow ①.  
The high-beam headlamp indicator lamp  in the instrument cluster comes on.
- ▶ **Switching off:** Pull the combination switch in direction of arrow ③ to its original position.
- ❗ Also note the information on high-beam headlamps with activated automatic headlamp mode (▷ page 71) or the daytime running lamp mode (▷ page 72).

### High-beam flasher

- ▶ **Switching on:** Pull the combination switch briefly in direction of arrow ③.

### Hazard warning flasher

The hazard warning flasher can be switched on at all times, even with the SmartKey removed from the starter switch.  
The hazard warning flasher comes on automatically when an air bag deploys.

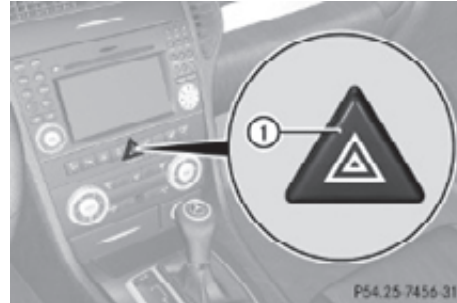

- ▶ **Switching on:** Press hazard warning flasher switch ①.  
All turn signal lamps are flashing.
- ❗ With the hazard warning flasher activated and the combination switch set for either left or right turn, only the respective left or right turn signals will operate when the ignition is switched on.
- ▶ **Switching off:** Press hazard warning flasher switch ① again.
- ❗ If the hazard warning flasher has been activated automatically, press hazard warning flasher switch ① to switch it off.

### Headlamp cleaning system

The headlamps will be cleaned with a high-pressure water jet automatically when the engine is running and you have

- switched on the headlamps and
- the windshield wipers have wiped the windshield with washer fluid five times

The counter resets when you switch off the headlamps.

For information on filling up the washer reservoir, see “Washer system and headlamp cleaning system” (▷ page 196).

### Corner-illuminating front fog lamps

The corner-illuminating front fog lamps improve illumination of the area in the direction into which you are turning.

The corner-illuminating front fog lamps will only operate

- in low ambient lighting conditions
- at vehicle speeds below 25 mph (40 km/h)
- with the front fog lamps switched off
- when the engine is running

### Switching on

- ▶ Turn the exterior lamp switch to position  or **AUTO**.

or

- ▶ Activate the daytime running lamp mode (▷ page 72).
- ▶ Switch on the left or right turn signal, depending on whether you are turning left or right.

The respective front fog lamp comes on. If you have switched on the turn signal for one side but turn the steering wheel in the other direction, the corner-illuminating front fog lamp on the side of the turn signal comes on.

or

- ▶ Turn the steering wheel in the desired direction.

Driving forward: The front fog lamp on the side of your steering direction comes on.

Driving in reverse: The front fog lamp opposite to your steering direction comes on.

The corner-illuminating front fog lamps will come on automatically depending on the steering angle, even if you did not switch on either turn signal. If the corner-illuminating front fog lamps came on automatically, they will also go out automatically depending on the steering angle and vehicle speed.

The corner-illuminating front fog lamps temporarily come on on both sides of the vehicle if you turn the steering wheel in one direction and then again in the other direction shortly thereafter.

The corner-illuminating front fog lamp remains lit for a short time only. It then goes out automatically.





### Switching off

- ▶ Switch off the left or right turn signal.
- or
- ▶ Steer straight ahead.

- ⓘ There may be a brief delay before the corner-illuminating front fog lamps go out.

### Interior lighting



- ①  Interior lighting on/off
- ②  Automatic control on/off
- ③  Right reading lamp on/off
- ④  Left reading lamp on/off

### Automatic control

- ▶ **Activating:** Press switch .

The interior lighting comes on in darkness, when you

- unlock the vehicle
- remove the SmartKey from the starter switch (Interior Lighting Delayed

Shut-off must be switched on  
(▷ page 107))

- open a door

The interior lighting goes out after a short time.

- i** If a door remains open, the interior lamps go out automatically after approximately 5 minutes when the SmartKey is removed or in starter switch position **0**.

- ▶ **Deactivating:** Press switch .

### Manual control

- !** An interior lamp switched on manually does not go out automatically.

Leaving an interior lamp switched on for an extended period of time with the engine turned off could result in a discharged battery.

- ▶ **Switching interior lighting on/off:** Press switch .

- i** The footwell lighting is switched on and off simultaneously with the manual control. The standard reading lamps are located to the left and right of the overhead control panel. Reading lamps as part of the interior lighting package are located on the lower edge of the interior rear view mirror.

- ▶ **Switching reading lamps on/off:** Press respective switch .

### Emergency lighting

The interior lighting comes on automatically if the vehicle is involved in an accident.

#### Switching off:

- ▶ Press switch .
- or
- ▶ Press hazard warning flasher switch (▷ page 74).

## Wipers

### Notes

- !** Do not operate the wipers when the windshield is dry. Dust that accumulates on a windshield might scratch the glass and/or damage the wiper blades when wiping occurs on a dry windshield. If it is necessary to operate the wipers in dry weather conditions, always operate the wipers with washer fluid.



### Windshield wipers

- ▶ Observe notes on page (▷ page 76).

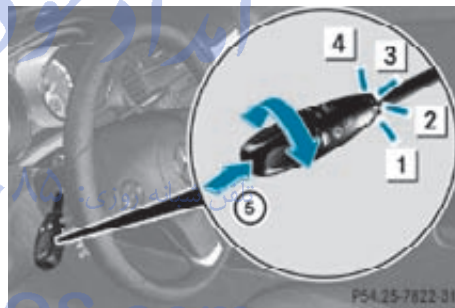
### Switching on/off



Combination switch

- 1** **0** Windshield wipers off
- 2** **I** Intermittent wiping
- 3** **II** Normal wiper speed
- 4** **III** Fast wiper speed
- 5**  Single wipe/  Wiping with washer fluid

- ▶ Switch on the ignition.
- ▶ Turn the combination switch to the desired position, depending on the intensity of the rain.

### Intermittent wiping

Only switch on intermittent wiping under wet weather conditions or in the presence of precipitation.

**!** Vehicles with rain sensor: Do not leave windshield wipers on an intermittent setting when the vehicle is taken to an automatic car wash or during windshield cleaning. Windshield wipers will operate in the presence of water sprayed on the windshield, and windshield wipers may be damaged as a result.

**!** Vehicles with rain sensor: If you have set intermittent wiping, dirt on the surface of the rain sensor or optical effects may cause the windshield wipers to wipe in an undesired fashion. This could then damage the windshield wiper blades or scratch the windshield. You should therefore switch off the windshield wipers when weather conditions are dry.

Vehicles with rain sensor: Intermittent wiping interval is dependent on the wetness of the windshield. After the initial wipe, pauses between wipes are controlled by the rain sensor automatically.

▶ Turn the combination switch to position **I**. Intermittent wiping is interrupted when the vehicle is at a standstill and a door is opened. This protects persons getting into or out of the vehicle from being sprayed.

Intermittent wiping will be continued when all doors are closed and

- the clutch pedal is depressed (vehicles with manual transmission)
- or
- the automatic transmission is in drive position **D** or reverse gear **R** (vehicles with automatic transmission)
- the automatic transmission is in drive position **D** or reverse gear **R**
- or
- the wiper setting is changed using the combination switch

### Single wipe

- ▶ Press the combination switch briefly in direction of arrow **⑤** to the resistance point.  
The windshield wipers wipe one time without washer fluid.

### Wiping with washer fluid

- ▶ Press the combination switch in direction of arrow **⑤** past the resistance point.  
The windshield wipers operate with washer fluid.

**i** To prevent smears on the windshield or noisy/chattering wiper blades, wipe with washer fluid every now and then even when it is raining.

For information on filling up the washer reservoir, see “Washer system and headlamp cleaning system” (▷ page 196).

For information on cleaning the headlamps with washer fluid, see “Headlamp cleaning system” (▷ page 74).

### Problems with wipers

**!** If anything blocks the windshield wipers (leaves, snow, etc.), switch them off immediately.

For safety reasons, do the following before attempting to remove any blockage:

- Stop the vehicle in a safe location.
- Remove the SmartKey from the starter switch.
- Engage the parking brake.
- Remove blockage.
- Turn the windshield wipers on again.

If the windshield wipers fail to function at all with the combination switch in position I,

- set the combination switch to the next higher wiper speed
- have the windshield wipers checked at the nearest authorized Mercedes-Benz Center

## Power windows

### Opening and closing

The windows are opened and closed electrically. The switches for all windows are located on the driver's door. The switch for operating the passenger-side windows is located on the passenger door.

 **Observe Safety notes, see page 45.**

#### **Warning!**

When closing the windows, make sure there is no danger of anyone being harmed by the closing procedure.

The door windows are equipped with the express operation and automatic reversal function. If in express operation mode a door window encounters an obstruction that blocks its path, the automatic reversal function will stop the door window and open it slightly.

The door windows operate differently when the switch is pulled and held. See the "Closing when a door window is blocked" section for details.

The closing of the door windows can be immediately halted by releasing the switch or, if the switch was pulled past the resistance point and released, by pressing or pulling the respective switch.

The closing of the rear side windows can be immediately halted by releasing the switch.

If a window encounters an obstruction that blocks its path in a circumstance where you are closing the windows by pressing and

holding button  on the SmartKey the automatic reversal function will not operate.

- i** You can also open or close the windows using the SmartKey, see "Summer opening feature" (▷ page 172) and "Convenience closing feature" (▷ page 172).
- i** After switching off the ignition or removing the SmartKey from the starter switch, you can operate the windows until you open a door. If no door was opened you can operate the windows for up to 5 minutes.

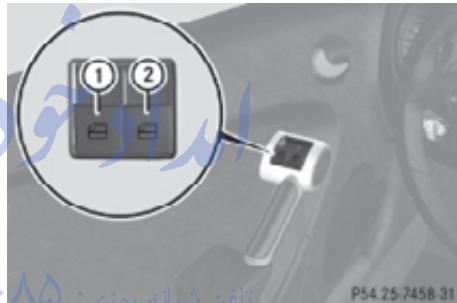

### Door windows

- ▶ Switch on the ignition.
- ▶ **Opening/closing:** Press or pull and hold switch ① or ② to the resistance point. The corresponding door window moves downward or upward until you release the switch.
- ▶ **Express operation:** Press or pull switch ① or ② past the resistance point and release. The corresponding door window opens or closes completely.
- ▶ **Stopping during express operation:** Press or pull the respective switch again.



### Closing when a door window is blocked

#### **Warning!**

Make sure that nobody can become trapped and be seriously or even fatally injured when closing a door window with greater force or without automatic reversal function.

If the upward movement of a door window is blocked during the closing procedure, the door window will stop and open slightly.

- ▶ Immediately after the door window has stopped because it was blocked, pull and hold the respective switch upward until the door window is fully closed.  
The door window closes with greater force.

If the door window is blocked again and opens slightly:

- ▶ Immediately after the door window was blocked, pull and hold the respective switch upward until the door window is fully closed.  
The door window closes without automatic reversal function.

#### **Warning!**

Pulling and holding the switch to close the door window immediately after it had been blocked two times will cause the door window to close without any reversal function for as long as you hold the switch.

### Opening and closing the rear side windows when the hardtop is closed

- ▶ **Opening:** Open the door window.
- ▶ Press switch ① or ② again.  
The corresponding rear side window will open completely.
- ▶ **Closing:** Close the door window.
- ▶ Pull and hold switch ① or ②.  
The corresponding rear side window moves upward until you release the switch.

### Synchronizing power windows

The windows must be synchronized after the battery has been disconnected or if the windows cannot be fully closed (express operation).

Each window must be synchronized separately.

- ▶ Close all doors.
- ▶ Switch on the ignition.
- ▶ Pull and hold switch ① or ② (▷ page 78) until the respective window is closed.  
The window opens again slightly.
- ▶ Pull and hold the respective switch once more immediately until the window is closed completely.
- ▶ Hold the respective switch for approximately 1 second.  
The window is synchronized.

### Driving and parking

#### Safety notes

#### **Warning!**

Make sure absolutely no objects are obstructing the pedals' range of movement. Keep the driver's footwell clear of all obstacles. If there are any floor mats or carpets in the footwell, make sure the pedals still have sufficient clearance.

During sudden driving or braking maneuvers the objects could get caught between or under the pedals. You could then no longer brake or accelerate. This could lead to accidents and injury.

#### **Warning!**

With the engine not running, there is no power assistance for the brake and steering systems. In this case, it is important to keep in mind that a considerably higher degree of effort is necessary to brake and steer the vehicle. Adapt your driving accordingly.

### Starting the engine

#### Warning!

Inhalation of exhaust gas is hazardous to your health. All exhaust gas contains carbon monoxide (CO), and inhaling it can cause unconsciousness and possible death.

Do not run the engine in confined areas (such as a garage) which are not properly ventilated. If you think that exhaust gas fumes are entering the vehicle while driving, have the cause determined and corrected immediately. If you must drive under these conditions, drive only with at least one window fully open at all times.

### Manual transmission

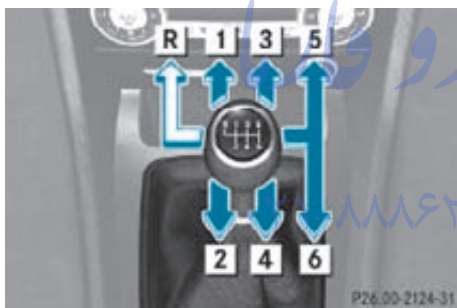

Gearshift pattern for manual transmission

- R** Reverse gear
- 1** to **6** Forward gears

For more information, see “Manual transmission” (▷ page 84).

- ▶ Depress the brake pedal.
- ▶ Make sure the manual transmission is in the neutral position (no gear selected).
- ▶ Fully depress the clutch pedal. Otherwise the engine cannot be started due to the integrated safety interlock.

### Automatic transmission

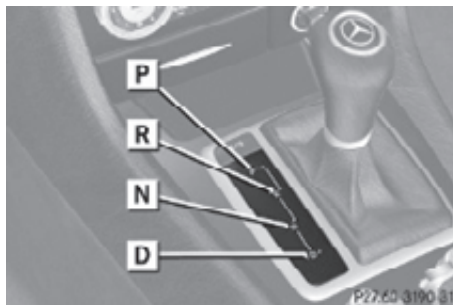

Gearshift pattern for automatic transmission

- P** Park position with gear selector lever lock
- R** Reverse gear
- N** Neutral position
- D** Drive position

For more information, see “Automatic transmission” (▷ page 85).

- ▶ Make sure the automatic transmission is in park position **P**.

### Starting

- ▶ Do not depress the accelerator pedal.
- ▶ Turn the SmartKey in the starter switch to position **3** (▷ page 61) and hold until the engine starts.

- i** Vehicles with automatic transmission: You can also use the “touch-start” function. Turn the SmartKey in the starter switch to position **3** and release it again immediately. The engine then starts automatically.

### Starting difficulties

- !** Remember that extended starting attempts can drain the battery.

If the SmartKey is left in starter switch position **0** for an extended period of time, it can no longer be turned in the starter switch. In this case, the steering is locked.

- ▶ To unlock, remove the SmartKey from the starter switch and reinsert.

**The engine does not start. You can hear the starter.**

There could be a malfunction in the engine electronics or in the fuel supply system.

- ▶ Turn the SmartKey in the starter switch to position **0** and repeat the starting procedure.

If the engine does not start after several starting attempts:

- ▶ Contact an authorized Mercedes-Benz Center or call Roadside Assistance.

**The engine does not start. You cannot hear the starter.**

The battery may not be charged sufficiently.

- ▶ Get a jump start (▷ page 283).

If the engine will not start despite a jump start:

- ▶ Contact an authorized Mercedes-Benz Center or call Roadside Assistance.

The starter has been exposed to excessive temperatures.

- ▶ Let the starter cool for about 2 minutes.
- ▶ Repeat the starting procedure.

If the engine does not start after several starting attempts:

- ▶ Contact an authorized Mercedes-Benz Center or call Roadside Assistance.

**Driving off**

 **Warning!**

On slippery road surfaces, never downshift in order to obtain braking action. This could result in drive wheel slip and reduced vehicle control. Your vehicle's ABS will not prevent this type of loss of control.

- ❗ Do not run a cold engine at high engine speeds. Running a cold engine at high engine speeds may shorten the service life

of the engine. This is not covered by the Mercedes-Benz Limited Warranty.

- ❗ If an acoustic warning sounds and the message Release Parking Brake appears in the multifunction display when driving off, you have forgotten to release the parking brake.

Release the parking brake.

- ❗ Avoid spinning of a drive wheel. This may cause serious damage to the drivetrain which is not covered by the Mercedes-Benz Limited Warranty.

- ❗ Simultaneously depressing the accelerator pedal and applying the brakes reduces engine performance and causes premature brake and drivetrain wear which is not covered by the Mercedes-Benz Limited Warranty.

- i Once the vehicle is in motion, the automatic central locking function engages and the locking knobs in the doors move down. *تلفن شبانه رو.* The automatic central locking function can be switched off (▷ page 108).

**Manual transmission**

- ▶ Depress the brake pedal.
- ▶ Fully depress the clutch pedal.

- ❗ Only shift the manual transmission into reverse gear **R** when the vehicle is stopped. Otherwise the manual transmission could be damaged.

- ▶ Shift the manual transmission into **1st** gear or reverse gear **R**.
- ▶ If engaged, release the parking brake.
- ▶ Release the brake pedal.
- ▶ Simultaneously slowly release the clutch pedal and carefully depress the accelerator pedal.

- ❗ Avoid driving at excessive engine speeds. This may result in serious engine damage that is not covered by the Mercedes-Benz Limited Warranty.  
Shift gear in a timely manner.

For more information on driving, see “Driving instructions” (▷ page 221).

### Automatic transmission

#### Warning!

It is dangerous to shift the automatic transmission out of park position **P** or neutral position **N** if the engine speed is higher than idle speed. If your foot is not firmly on the brake pedal, the vehicle could accelerate quickly forward or in reverse. You could lose control of the vehicle and hit someone or something. Only shift into gear when the engine is idling normally and when your right foot is firmly on the brake pedal.

- ❗ Only shift the automatic transmission into reverse gear **R** or park position **P** when the vehicle is stopped. Otherwise the automatic transmission could be damaged.

- ▶ Depress the brake pedal. The gear selector lever lock is released.
- ▶ Shift the automatic transmission into drive position **D** or reverse gear **R**.

- i Shifting the automatic transmission out of park position **P** is only possible with the brake pedal depressed.

Only depressing the brake pedal releases the gear selector lever lock.

- ▶ Wait for the gear selection process to complete before setting the vehicle in motion.
- ▶ If engaged, release the parking brake.
- ▶ Release the brake pedal.
- ▶ Carefully depress the accelerator pedal.

After a cold start, the automatic transmission shifts at a higher engine speed. This allows

the catalytic converter to reach its operating temperature earlier.

For more information on driving, see “Driving instructions” (▷ page 221).

### Problems while driving

#### The engine runs erratically and misfires

- An ignition cable may be damaged.
  - The engine electronics may not be operating properly.
  - Unburned gasoline may have entered the catalytic converter and damaged it.
- ▶ Give very little gas.
  - ▶ Have the problem checked at an authorized Mercedes-Benz Center as soon as possible.

#### The coolant temperature is above 248°F (120°C)

The coolant is too hot and is no longer cooling the engine.

- ▶ Stop the vehicle in a safe location as soon as possible.
- ▶ Turn off the engine immediately.
- ▶ Allow the engine and coolant to cool off.
- ▶ Check the coolant level and add coolant if necessary (▷ page 196).

#### In case of accident

If the vehicle is leaking fuel:

- ▶ Do not start the engine under any circumstances.
- ▶ Exit the vehicle at a safe distance from the roadway.
- ▶ Notify local fire and/or police authorities.

If the extent of the damage cannot be determined:

- ▶ Contact an authorized Mercedes-Benz Center or call Roadside Assistance.

If no damage on major assemblies, fuel system, and engine mount can be determined:

- ▶ Start the engine in the usual manner.

## Parking

### ⚠ Warning!

Do not park this vehicle in areas where combustible materials such as grass, hay or leaves can come into contact with the hot exhaust system. These materials could be ignited and cause a vehicle fire.

Vehicle movement can cause serious personal injury or damage to the vehicle or the vehicle drivetrain. Therefore, always do the following before turning off the engine and leaving the vehicle:

- Keep right foot on the brake pedal.
- Engage the parking brake.
- Manual transmission: Shift the manual transmission into **1st** gear or reverse gear **R**.
- Automatic transmission: Shift the automatic transmission into park position **P**.
- Slowly release the brake pedal.
- When parked on an incline, always turn the front wheels towards the road curb.
- Turn the SmartKey in the starter switch to position **0** and remove the SmartKey from the starter switch.
- Take the SmartKey with you and lock the vehicle when leaving.

### ⚠ Warning!

Manual transmission:  
Wait until the vehicle is stationary before removing the SmartKey from the starter switch. The vehicle cannot be steered when the SmartKey is removed from the starter switch.

## Parking brake

### ⚠ Warning!

Engaging the parking brake while the vehicle is in motion can cause the rear wheels to lock up. You could lose control of the vehicle and cause an accident. In addition, the vehicle's brake lights do not light up when the parking brake is engaged.

### ⚠ Warning!

When leaving the vehicle, always remove the SmartKey from the starter switch, take it with you, and lock the vehicle. Do not leave children unattended in the vehicle, or with access to an unlocked vehicle. Children could release the parking brake and/or shift the automatic transmission out of park position **P** (manual transmission: shift into the neutral position), either of which could result in an accident and/or serious personal injury.

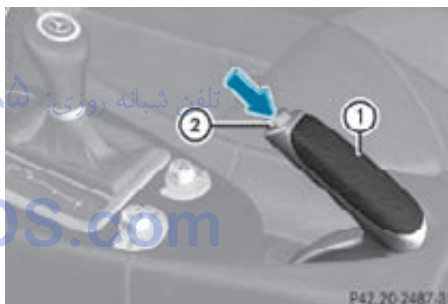

- ▶ **Releasing:** Pull up slightly on parking brake lever ① and press release button ②.
- ▶ Push parking brake lever ① down to its original position.  
When the ignition is switched on or the engine is running, the brake warning lamp **BRAKE** (USA only) or **(P)** (Canada only) in the instrument cluster goes out.
- ▶ **Engaging:** Pull up parking brake lever ① firmly.  
When the engine is running, the brake warning lamp **BRAKE** (USA only) or **(P)** (Canada only) in the instrument cluster comes on.

**Turning off the engine****⚠ Warning!**

Do not turn off the engine before the vehicle has come to a complete stop. With the engine not running, there is no power assistance for the brake and steering systems. In this case, it is important to keep in mind that a considerably higher degree of effort is necessary to brake and steer the vehicle.

- ▶ Manual transmission: Shift the manual transmission into **1st** gear or reverse gear **R**.
- ▶ Automatic transmission: Shift the automatic transmission into park position **P**.
- ▶ Engage the parking brake.
- ❗ Always engage the parking brake in addition to shifting the automatic transmission into park position **P** (manual transmission: shifting into **1st** gear or reverse gear **R**).
- ▶ Turn the SmartKey in the starter switch to position **0**.
- ▶ Remove the SmartKey from the starter switch.  
The immobilizer is activated.

Automatic transmission:

The SmartKey can only be removed from the starter switch with the automatic transmission in park position **P**.

**Manual transmission****Introduction**

For information on driving with a manual transmission, see “Driving and parking” (> page 79).

**⚠ Warning!**

Make sure absolutely no objects are obstructing the pedals' range of movement. Keep the driver's footwell clear of all

obstacles. If there are any floor mats or carpets in the footwell, make sure the pedals still have sufficient clearance.

During sudden driving or braking maneuvers the objects could get caught between or under the pedals. You could then no longer brake or accelerate. This could lead to accidents and injury.

**⚠ Warning!**

When working on the vehicle, engage the parking brake and shift the manual transmission into **1st** gear or reverse gear **R**. Otherwise the vehicle could roll away which could result in an accident and/or serious personal injury.

- ❗ Allow the engine to warm up under low load use. Do not place full load on the engine until the operating temperature has been reached.

Avoid spinning of a drive wheel for an extended period when driving off on slippery road surfaces.

This may cause serious damage to the engine and the drivetrain which is not covered by the Mercedes-Benz Limited Warranty.

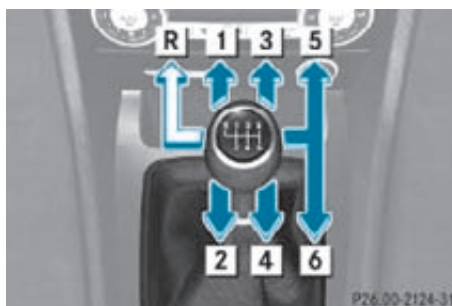
**Gearshift lever**

Gearshift pattern for manual transmission

- R** Reverse gear
- 1** to **6** Forward gears

 **Warning!**

On slippery road surfaces, never downshift in order to obtain braking action. This could result in drive wheel slip and reduced vehicle control. Your vehicle's ABS will not prevent this type of loss of control.

- ❗ When you are shifting the manual transmission into the **5th** or **6th** gear, make sure you move the gearshift lever to the right. Otherwise, you could accidentally shift into the **3rd** or **4th** gear and damage the manual transmission.

Downshifting gears leading to overrevving the engine can result in engine damage that is not covered by the Mercedes-Benz Limited Warranty.

Never hold the vehicle stopped on a hill by using the clutch pedal. The clutch may be damaged which is not covered by the Mercedes-Benz Limited Warranty.

- ❗ Avoid driving at excessive engine speeds. This may result in serious engine damage that is not covered by the Mercedes-Benz Limited Warranty.  
Shift gear in a timely manner.

### **Shifting into reverse gear R**

- ❗ Only shift the manual transmission into reverse gear **R** when the vehicle is stopped. Otherwise the manual transmission could be damaged.

- ▶ Stop the vehicle completely.
- ▶ Fully depress the clutch pedal.
- ▶ Shift the manual transmission into the neutral position (no gear selected).
- ▶ Move the gearshift lever to the left until you feel a certain resistance.
- ▶ Push the gearshift lever past this resistance and hold.
- ▶ Move the gearshift lever forward to select reverse gear **R**.

## Automatic transmission

### Introduction

For information on driving with an automatic transmission, see "Driving and parking" (▷ page 79).

 **Warning!**

Make sure absolutely no objects are obstructing the pedals' range of movement. Keep the driver's footwell clear of all obstacles. If there are any floor mats or carpets in the footwell, make sure the pedals still have sufficient clearance.

During sudden driving or braking maneuvers the objects could get caught between or under the pedals. You could then no longer brake or accelerate. This could lead to accidents and injury.

- ❗ Allow the engine to warm up under low load use. Do not place full load on the engine until the operating temperature has been reached.

Avoid spinning of a drive wheel for an extended period when driving off on slippery road surfaces.

This may cause serious damage to the engine and the drivetrain which is not covered by the Mercedes-Benz Limited Warranty.

- i During the brief warm-up, transmission upshifting is delayed. This allows the catalytic converter to heat up more quickly to operating temperature.

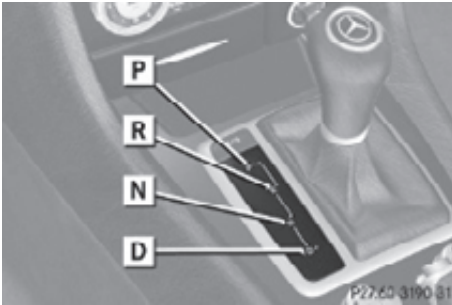
**Gear selector lever**

Gearshift pattern for automatic transmission

- P** Park position with gear selector lever lock
- R** Reverse gear
- N** Neutral position
- D** Drive position

**⚠ Warning!**

It is dangerous to shift the automatic transmission out of park position **P** or neutral position **N** if the engine speed is higher than idle speed. If your foot is not firmly on the brake pedal, the vehicle could accelerate quickly forward or in reverse. You could lose control of the vehicle and hit someone or something. Only shift into gear when the engine is idling normally and when your right foot is firmly on the brake pedal.

**!** Only shift the automatic transmission into reverse gear **R** or park position **P** when the vehicle is stopped. Otherwise the automatic transmission could be damaged.

**i** Shifting the automatic transmission out of park position **P** is only possible with the brake pedal depressed.

Only depressing the brake pedal releases the gear selector lever lock.

**i** The current gear selector lever position corresponds with the current transmission position.

The current transmission position **P**, **R**, **N**, or **D** appears in the multifunction display (▷ page 87).

There are additional indicators on the cover of the shifting gate showing the current gear selector lever position.

The indicators come on when you insert the SmartKey into the starter switch, and go out when you remove the SmartKey from the starter switch.

**Shifting procedure**

The automatic transmission selects individual gears automatically, depending on

- the selected gear range (▷ page 88)
- the selected program mode:
  - C/S** (▷ page 88)
  - or
  - M** (vehicles with AMG Sport Package and SLK 55 AMG only) (▷ page 90)

- the position of the accelerator pedal
- the vehicle speed

With drive position **D** selected, you can influence transmission shifting by

- limiting the gear range
- extending the gear range
- changing the gears manually (vehicles with AMG Sport Package and SLK 55 AMG only)



### Transmission positions

The current transmission position appears in the multifunction display.



① Transmission position indicator

	Effect
<b>P</b>	<p><b>Park position</b></p> <p>Shift the automatic transmission into park position <b>P</b> only when the vehicle is stopped. The park position is not intended to serve as a brake when the vehicle is parked. Rather, the driver should always engage the parking brake in addition to shifting the automatic transmission into park position <b>P</b> to secure the vehicle.</p> <p>The SmartKey can only be removed from the starter switch with the gear selector lever in park position <b>P</b>. With the SmartKey removed from the starter switch, the gear selector lever is locked in park position <b>P</b>. If the vehicle's electrical system is malfunctioning, the gear selector lever could remain locked in park position <b>P</b>. To unlock the gear selector lever manually, see "Manually unlocking the gear selector lever" (▷ page 266).</p>
<b>R</b>	<p><b>Reverse gear</b></p> <p>Shift the automatic transmission into reverse gear <b>R</b> only when the vehicle is stopped.</p>

	Effect
<b>N</b>	<p><b>Neutral position</b></p> <p>No power is transmitted from the engine to the drive axle. When the brakes are released, the vehicle can be moved freely (pushed or towed).</p> <p>To avoid damage to the transmission, never shift the automatic transmission into neutral position <b>N</b> while driving.</p> <p>Exception: If the ESP® is switched off or malfunctioning, shift the automatic transmission into neutral position <b>N</b> if the vehicle is in danger of skidding.</p> <p><b>!</b> Coasting the vehicle, or driving for any other reason with the automatic transmission in neutral position <b>N</b> can result in transmission damage that is not covered by the Mercedes-Benz Limited Warranty.</p>
<b>D</b>	<p><b>Drive position</b></p> <p>The automatic transmission shifts automatically. All forward gears are available.</p>

### Driving tips

#### Kickdown

Use the kickdown when you want maximum acceleration.

- ▶ **U.S. vehicles except AMG vehicles:**  
Fully depress the accelerator pedal. Depending on the engine speed the automatic transmission shifts into a lower gear.
- ▶ **Canada vehicles and AMG vehicles:**  
Depress the accelerator pedal past the point of resistance. Depending on the engine speed the automatic transmission shifts into a lower gear.

Controls in detail

### Working on the vehicle

#### **Warning!**

When working on the vehicle, engage the parking brake and shift the automatic transmission into park position **P**. Otherwise the vehicle could roll away which could result in an accident and/or serious personal injury.

#### Gear ranges

With the automatic transmission in drive position **D** and driving in automatic program mode **C** or **S**, you can limit or extend the gear range, see “One-touch gearshifting” (▷ page 89).

The current gear range appears in the multifunction display.



① Gear range indicator

	Effect
3	With this selection you can use the braking effect of the engine.
2	Allows the use of the engine's braking effect when driving <ul style="list-style-type: none"> <li>• on steep downgrades</li> <li>• in mountainous regions</li> <li>• under extreme operating conditions</li> </ul>
1	For maximum use of the engine's braking effect on very steep or lengthy downgrades.

### Automatic shift program

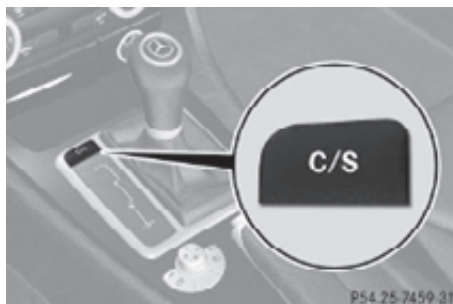

Program mode selector switch

<b>C</b> Comfort	For comfort driving
<b>S</b> Sport	For sporty driving

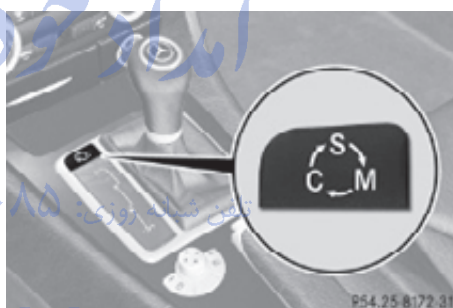

Program mode selector switch on vehicles with AMG Sport Package and SLK 55 AMG

<b>C</b> Comfort	For comfort driving
<b>S</b> Sport	For standard driving
<b>M</b> Manual	For manual gearshifting (▷ page 90)

The current program mode appears in the multifunction display.



#### ① Program mode indicator

You should only change the program mode when the automatic transmission is in park position **P**.

Automatic program mode **S** will not be stored. When the engine is turned off with the automatic program mode **S** selected, the automatic transmission will go to the automatic program mode **C** when the engine is restarted.

- ▶ Press the program mode selector switch repeatedly until the letter of the desired program mode appears in the multifunction display.

Selecting program mode **C** means:

- The vehicle starts out more gentle, both forward and reverse, except when driving off with full throttle.
- Traction and driving stability are improved on icy roads.
- Upshifts occur earlier even when you give more gas. The engine then operates at lower revolutions and the wheels are less likely to spin.

Selecting program mode **S** means that upshifts occur later.

### One-touch gearshifting

With the automatic transmission in drive position **D** and driving in automatic program

mode **C** or **S**, you can limit or extend the gear range using the gear selector lever or the steering wheel gearshift control.

Vehicles with AMG Sport Package and SLK 55 AMG: For information on using the gear selector lever or the steering wheel gearshift control in manual program mode **M**, see “Manual shift program” (> page 90).

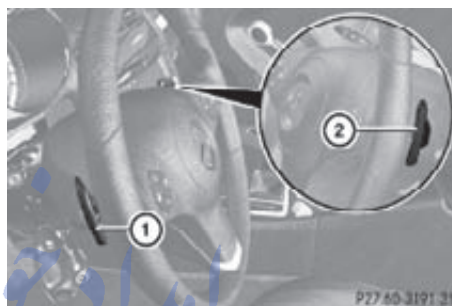

Steering wheel gearshift control (example illustration)

- ⓘ You cannot shift with the steering wheel gearshift control when the automatic transmission is in park position **P**, neutral position **N**, or reverse gear **R**.

### Limiting gear range

#### ⚠ Warning!

On slippery road surfaces, never downshift in order to obtain braking action. This could result in drive wheel slip and reduced vehicle control. Your vehicle's ABS will not prevent this type of loss of control.

- ▶ Briefly press the gear selector lever to the left in the **D**- direction.

or

- ▶ Briefly pull left gearshift control ①. The automatic transmission will shift into the next lower gear as permitted by the shift program. This action simultaneously limits the gear range of the automatic transmission.

- i** To avoid overrevving the engine when downshifting, the automatic transmission will not shift into a lower gear if the engine's maximum speed would be exceeded.

### Extending gear range

- ▶ Briefly press the gear selector lever to the right in the **D+** direction.

or

- ▶ Briefly pull right gearshift control ②. The automatic transmission will shift into the next higher gear as permitted by the shift program. This action simultaneously extends the gear range of the automatic transmission.

- i** If you press on the accelerator pedal when the engine has reached the revolution limit of the current gear range, the automatic transmission will upshift beyond any gear range limit selected.

### Canceling gear range limit

- ▶ Press and hold the gear selector lever to the right in the **D+** direction until **D** reappears in the multifunction display.

or

- ▶ Pull and hold right gearshift control ② until **D** reappears in the multifunction display. The automatic transmission will shift from the current gear range directly into drive position **D**.

### Shifting into optimal gear range

- ▶ Press and hold the gear selector lever to the left in the **D-** direction.

or

- ▶ Pull and hold left gearshift control ①. The automatic transmission will select the gear range suited for optimal acceleration and deceleration automatically. This will involve shifting down one or more gears.

### Manual shift program

The manual shift program is available on vehicles with AMG Sport Package and on SLK 55 AMG only.

Manual program mode **M** differs with regard to spontaneity, response time, and shifting smoothness from automatic program mode **S**.

In manual program mode **M**, system-controlled automatic gearshifting is switched off. You need to change the gears by manually upshifting or downshifting using the gear selector lever or the steering wheel gearshift control.

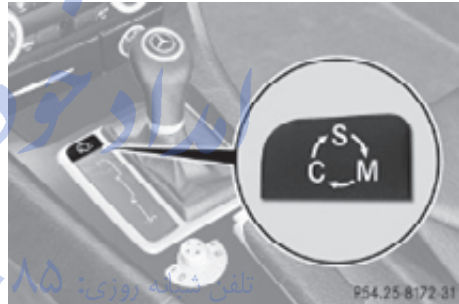

Program mode selector switch on vehicles with AMG Sport Package and SLK 55 AMG

<b>C</b> Comfort	For comfort driving
<b>S</b> Sport	For standard driving
<b>M</b> Manual	For manual gearshifting

The current program mode appears in the multifunction display (▷ page 89).

For information on automatic program mode (**C** or **S**), see “Automatic shift program” (▷ page 88) and “One-touch gearshifting” (▷ page 89).

### Activating manual shift program

- ▶ Press the program mode selector switch repeatedly until **M** appears in the multifunction display.

The automatic transmission switches to manual program mode **M**. Automatic shifting is switched off. The gear range is not limited.

You can change the gears manually with drive position **D** selected. You can upshift or downshift through the gears in succession.

- i** Manual program mode **M** will not be stored. When the engine is turned off with manual program mode **M** selected, the automatic transmission will go to automatic program mode **C** when the engine is restarted.

### Upshifting

- !** In manual program mode **M**, the automatic transmission will not upshift, even if the engine has reached its overrevving range. Shift up into the next gear before the engine has reached its overrevving range. Make absolutely certain that the engine speed does not reach the red marking on the tachometer. Otherwise the engine could be damaged which is not covered by the Mercedes-Benz Limited Warranty.

- ▶ Briefly press the gear selector lever to the right in the **D+** direction.

or

- ▶ Briefly pull right gearshift control ② (> page 89).  
The automatic transmission shifts into the next higher gear.

### Upshift indicator

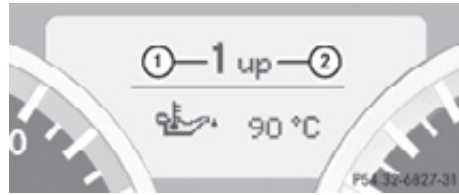

In manual program mode **M**, upshift indicator ② in the multifunction display advises you to upshift before the engine reaches the overspeed range. In addition, symbol **^** may appear instead of manual program mode symbol **M** in the multifunction display. Thus you can drive at the maximum engine speed for each gear without overrevving the engine.

- ▶ Shift the automatic transmission from current gear ① into the next higher gear. The fuel supply will otherwise be interrupted to prevent the engine from overrevving.

### Downshifting

#### **!** Warning!

On slippery road surfaces, never downshift in order to obtain braking action. This could result in drive wheel slip and reduced vehicle control. Your vehicle's ABS will not prevent this type of loss of control.

- ▶ Briefly press the gear selector lever to the left in the **D-** direction.

or

- ▶ Briefly pull left gearshift control ① (> page 89).  
The automatic transmission shifts into the next lower gear.

- i** For maximum acceleration, press and hold the gear selector lever to the left in the **D-** direction or pull and hold the left gearshift control. Depending on the engine speed the automatic transmission selects

the optimal gear for maximum acceleration.

- i** When you brake or stop, the automatic transmission shifts down into a gear from which you can easily accelerate or take off.

### Kickdown

Using the kickdown while driving in manual program mode **M** is not possible.

### Deactivating manual shift program

- ▶ Press the program mode selector switch repeatedly until **C** or **S** appears in the multifunction display.

or

- ▶ Restart the engine.  
The automatic transmission will go to automatic program mode **C**.

Manual program mode **M** is not stored.

### Emergency operation (limp-home mode)

If vehicle acceleration becomes less responsive or sluggish or the automatic transmission no longer shifts, the automatic transmission is most likely operating in limp-home (emergency operation) mode. In this mode only second gear and reverse gear **R** can be selected.

- ▶ Stop the vehicle in a safe location.
- ▶ Shift the automatic transmission into park position **P**.
- ▶ Turn off the engine.
- ▶ Wait at least 10 seconds before restarting.
- ▶ Restart the engine.
- ▶ Shift the automatic transmission into drive position **D** (for second gear) or reverse gear **R**.
- ▶ Have the automatic transmission checked at an authorized Mercedes-Benz Center as soon as possible.

## Instrument cluster

### Introduction

For a full view illustration of the instrument cluster, see “Instrument cluster” (▷ page 26).

### Warning!

No messages will be displayed if either the instrument cluster or the multifunction display is inoperative.

As a result, you will not be able to see information about your driving conditions, such as

- speed
- outside temperature
- warning/indicator lamps
- malfunction/warning messages
- failure of any systems

Driving characteristics may be impaired.

If you must continue to drive, do so with added caution. Contact an authorized Mercedes-Benz Center as soon as possible.

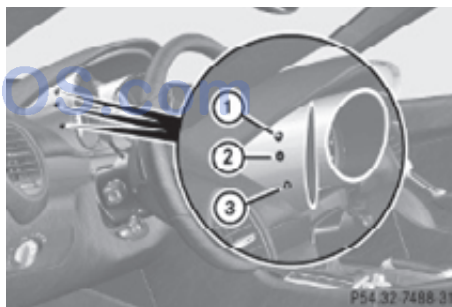

- ① To brighten instrument cluster illumination (knob +)
- ② To dim instrument cluster illumination (knob -)
- ③ Reset button 

For information on changing the instrument cluster settings, e.g. the language, see (▷ page 103).

### Activating the instrument cluster

The instrument cluster is activated when you

- open the driver's door
- switch on the ignition
- press reset button (R)
- switch on the exterior lamps

**i** Opening the driver's door or pressing the reset button (R) without switching on the ignition or the exterior lamps activates the instrument cluster illumination only for 30 seconds.

### Adjusting the instrument cluster illumination

▶ **To brighten illumination:** Press knob ① briefly.

▶ **To dim illumination:** Press knob ② briefly.

The illumination brightness for the instrument cluster changes each time you press knob ① or ②. Several settings are possible.

**i** The instrument cluster illumination is dimmed or brightened automatically to suit ambient light conditions. You can only adjust the brightness of the instrument cluster illumination when it is dark outside.

**i** With the exterior lighting switched on, the brightness of the switches in the center console will also be adjusted when using knob ① or ②.

### Resetting trip odometer

- ▶ Make sure you are viewing the standard display (▷ page 96) in the multifunction display.
- ▶ Press and hold reset button (R) until the trip odometer is reset.

### Tachometer

The red marking on the tachometer (▷ page 26) denotes excessive engine speed.

**!** Avoid driving at excessive engine speeds, as it may result in serious engine damage that is not covered by the Mercedes-Benz Limited Warranty.

To help protect the engine, the fuel supply is interrupted if the engine is operated within the red marking.

### Clock

In vehicles with the audio system, the clock can be set via the control system (▷ page 105).

For setting the time with the COMAND system, see separate COMAND system operating instructions.

## Control system

### Introduction

The control system is activated as soon as the starter switch is in position 1.

The control system enables you to call up information about your vehicle and to change vehicle settings.

For example, you can use the control system to find out when your vehicle is next due for maintenance service, to set the language for messages in the instrument cluster display, and much more.

### Warning!

A driver's attention to the road and traffic conditions must always be his/her primary focus when driving.

For your safety and the safety of others, selecting features through the multifunction steering wheel should only be done by the driver when traffic and road conditions permit it to be done safely.

Bear in mind that at a speed of just 30 mph (approximately 50 km/h), your vehicle is covering a distance of 44 feet (approximately 14 m) every second.



The control system relays information to the multifunction display.

Controls in detail



**Multifunction steering wheel**

The displays in the multifunction display and the settings in the control system are controlled by using the buttons on the multifunction steering wheel.





- ① Multifunction display
- ② Press button
  -  to answer a call to dial<sup>3</sup> to redial<sup>3</sup>
  -  to end a call to reject an incoming call



Press button

-  to select submenus in the Settings menu
-  to set values to operate the RACETIMER<sup>4</sup> to set the volume



③ Press button

-  to select next or previous menu
- 

Press button briefly

-  to move within a menu
-  Within **Audio/DVD** menu to select previous or next track, scene or stored station
- Within **Telephone** menu to switch to the phone book and select a name or number

Press and hold button

-  Within **Audio/DVD** menu to select previous or next track with quick search or to select previous or next station in station list or wave band
-  Within **Telephone** menu to start the quick search in the phone book

Depending on the selected menu, pressing the buttons on the multifunction steering wheel will alter what appears in the multifunction display.

The information available in the multifunction display is arranged in menus and accompanying functions and submenus.

The individual functions are then found within the relevant menu (radio or CD operations under **Audio/DVD** menu, for example).

These functions serve to call up relevant





<sup>3</sup> Function only available in telephone menu.

<sup>4</sup> AMG vehicles only.



information or to customize the settings for your vehicle.

It is helpful to think of the menus, and the functions within each menu, as being arranged in a circular pattern.

- ▶ Press button  or  repeatedly to pass through each menu one after the other.
- ▶ Press button  or  repeatedly to pass through each function display, one after the other, in the current menu.

In the Settings menu, instead of functions, you will find a number of submenus for calling up and changing settings. For instructions on using these submenus, see “Settings menu” (▷ page 102).

The number of menus available in the system depends on which optional equipment is installed in your vehicle.

- ③ Automatic transmission program mode indicator<sup>5</sup>
- ④ Outside temperature/digital speedometer
- ⑤ Transmission position/gear range indicator<sup>5</sup>

For more information on menus displayed in the multifunction display, see “Menus and submenus” (▷ page 96).

#### Multifunction display



- ① Main odometer
- ② Trip odometer

<sup>5</sup> Automatic transmission only

## Menus and submenus

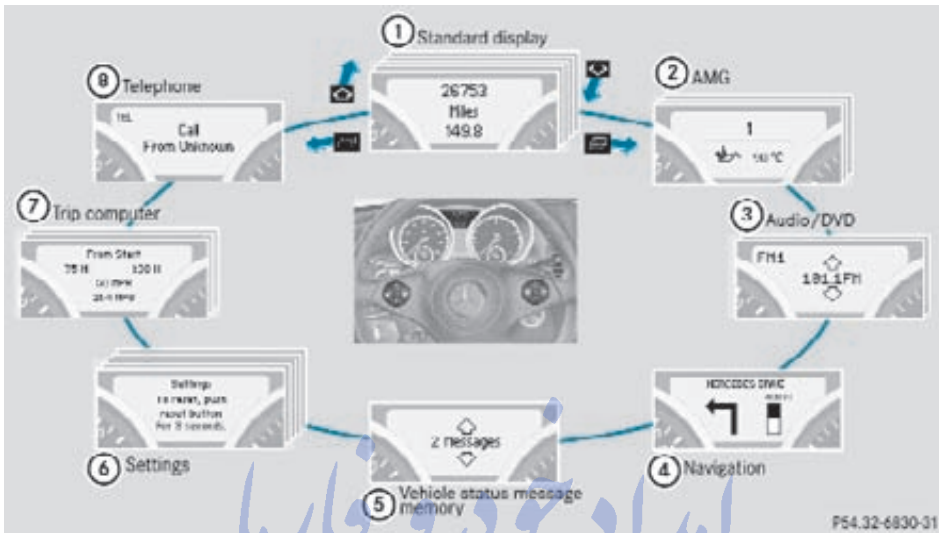

**i** The headings used in the menus table are designed to facilitate navigation within the system and are not necessarily identical to those shown in the multifunction display. The first function displayed in each menu will automatically show you which part of the system you are in.





	Function
①	<b>Standard display</b> menu (▷ page 96)
②	<b>AMG<sup>6</sup></b> menu (▷ page 97)
③	<b>Audio/DVD</b> menu (▷ page 100)
④	<b>Navigation</b> menu (▷ page 101)
⑤	<b>Vehicle status message memory<sup>7</sup></b> menu (▷ page 101)
⑥	<b>Settings</b> menu (▷ page 102)
⑦	<b>Trip computer</b> menu (▷ page 109)
⑧	<b>Telephone</b> menu (▷ page 110)

## Standard display menu



## Standard display

In the standard display, main odometer ① and trip odometer ② appear in the multifunction display.

- ▶ If you see another display, press button  or  repeatedly until the standard display appears.
- ▶ Press button  or  to select the functions in the **Standard display** menu.

<sup>6</sup> AMG vehicles only.

<sup>7</sup> The vehicle status message memory menu is only displayed if there is a message stored.

The following functions are available:

- Checking tire inflation pressure with the Advanced TPMS (▷ page 201) (USA only)
- Checking coolant temperature (▷ page 97)
- Calling up digital speedometer or outside temperature (▷ page 97)
- Calling up maintenance service indicator display (▷ page 226)
- Checking engine oil level (SLK 55 AMG only) (▷ page 194)



### Checking coolant temperature

#### Warning!

Driving when your engine is overheated can cause some fluids which may have leaked into the engine compartment to catch fire. You could be seriously burned.

Steam from an overheated engine can cause serious burns which can occur just by opening the engine hood. Stay away from the engine if you see or hear steam coming from it.

Stop the vehicle in a safe location away from other traffic. Turn off the engine, get out of the vehicle and do not stand near the vehicle until the engine has cooled down.

- ▶ Press button  or  repeatedly until the coolant temperature appears in the multifunction display.

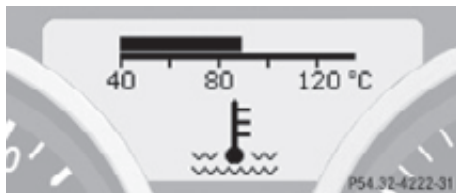

During severe operating conditions, e.g. stop-and-go traffic, the coolant temperature may rise close to 248°F (120°C).

- ! Excessive coolant temperature triggers a warning in the multifunction display.

The engine should not be operated with a coolant temperature above 248°F (120°C). Doing so may cause serious engine damage which is not covered by the Mercedes-Benz Limited Warranty.



### Calling up digital speedometer or outside temperature

You can select whether the digital speedometer or the outside temperature appears in the multifunction display (▷ page 104).

#### Warning!

The outside temperature indicator is not designed to serve as an ice-warning device and is therefore unsuitable for that purpose.

Indicated temperatures just above the freezing point do not guarantee that the road surface is free of ice. The road may still be icy, especially in wooded areas or on bridges.

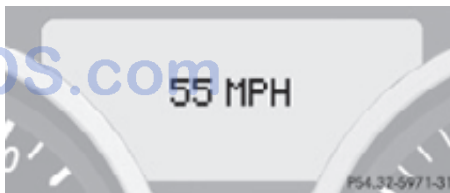

- ▶ Press button  or  repeatedly until the digital speedometer or the outside temperature appears in the multifunction display.



Digital speedometer

### AMG menu

This function is only available in AMG vehicles.

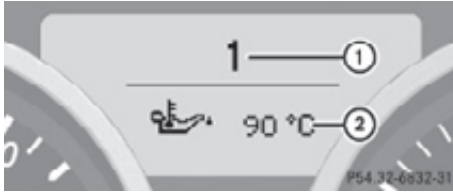

- ▶ Press button  or  repeatedly until the **AMG** menu appears in the multifunction display.



The main screen of the **AMG** menu shows you the gear currently engaged ① as well as the engine oil temperature ②.



The engine oil temperature flashes if the engine oil temperature has not yet reached 80°C. During this time, avoid driving at full engine speed.

If the engine reaches the overspeed range in the manual shift program, the menu will be shown in red. In addition, you will see UP next to gear indicator ① as a reminder to upshift.

Use buttons  or  to select the following functions in the **AMG** menu:

- Vehicle supply voltage (▷ page 98)
- RACETIMER (▷ page 98)
- Overall analysis (▷ page 99)
- Lap analysis (▷ page 99)

### Vehicle supply voltage

- ▶ Press button  or  repeatedly until the **AMG** menu appears in the multifunction display.
- ▶ Press button  repeatedly until the vehicle supply voltage appears in the multifunction display.





- ① Gear indicator
- ② Vehicle supply voltage indicator

### RACETIMER

#### **Warning!**

The RACETIMER feature is only for use on roads and in conditions where high speed driving is permitted. Racing on public roads is prohibited under all circumstances. The driver is and must always remain responsible for following posted speed limits.



The RACETIMER allows you to time and save driving stretches.

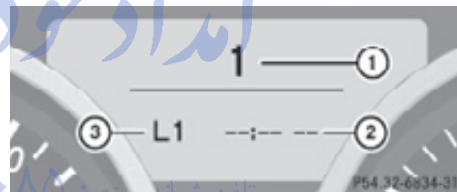

- ▶ Press button  or  repeatedly until the **AMG** menu appears in the multifunction display.
- ▶ Press button  repeatedly until the RACETIMER appears in the multifunction display.



- ① Gear indicator
- ② RACETIMER
- ③ Lap number

You can start the RACETIMER when the engine is running or the starter switch is in position 2 (▷ page 61).

While the RACETIMER is being displayed, you cannot adjust the audio volume using buttons  or .



- ▶ **Starting:** Press button .
- ▶ **Displaying intermediate time:** Press button  while the timer is running. The intermediate time is shown for 5 seconds.
- ▶ **Stopping:** Press button .

When you stop the vehicle and turn the SmartKey to position 1 (▷ page 61), the RACETIMER stops timing. Timing is resumed when you switch the ignition back on or

restart the engine and then press button .

### Saving lap time and starting a new lap

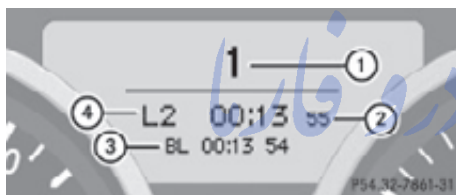

You can save up to nine laps.

- ▶ Press button  while the timer is running.  
The intermediate time will be shown for 5 seconds.
- ▶ Press button  within 5 seconds.  
The intermediate time shown will be saved as a lap time.  
The RACETIMER begins timing the new lap.  
The new lap begins to be timed as soon as the intermediate time is called up.





- ① Gear indicator
- ② RACETIMER
- ③ Best lap time
- ④ Lap number

### Resetting current lap

- ▶ Press button  while the timer is running.  
The timer stops.
  - ▶ Press button .
- The lap time is reset to "0".



### Deleting all laps

It is not possible to delete a single saved lap. When you turn off the engine, the RACETIMER will be reset to "0" after 30 seconds. All laps are deleted.

- ▶ Press button  while the timer is running.  
The timer stops.
  - ▶ Press reset button  twice (▷ page 92).
  - ▶ Press button .
- The timer starts. The saved laps are deleted.

### Overall analysis

This function is only available if you have saved at least one lap and have stopped the RACETIMER.

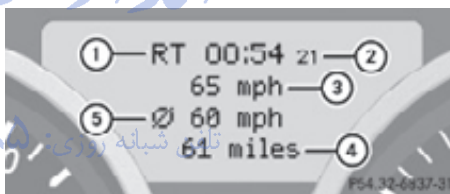

- ▶ Press button  or  repeatedly until the **AMG** menu appears in the multifunction display.
- ▶ Press button  repeatedly until the overall analysis appears in the multifunction display.



- ① Overall analysis of RACETIMER
- ② Overall driving time
- ③ Maximum speed
- ④ Overall distance driven
- ⑤ Average speed

### Lap analysis

This function is only available if you have saved at least two laps and have stopped the RACETIMER.

- ▶ Press button  or  repeatedly until the **AMG** menu appears in the multifunction display.
- ▶ Press button  repeatedly until the lap analysis appears in the multifunction display.

Each lap is shown in its own submenu. The fastest lap is indicated by flashing symbol ①.

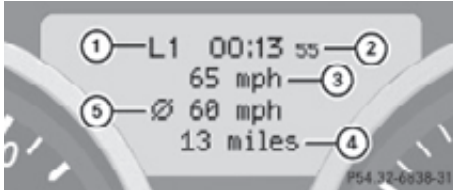

- ① Lap number
- ② Lap time
- ③ Maximum speed during lap
- ④ Lap length
- ⑤ Average speed during lap

► Press button or to see other lap analyses.

### Audio/DVD menu

The functions in the **Audio/DVD** menu operate the audio or video equipment which you have currently switched on.

The following functions are available:

- Selecting radio station (▷ page 100)
- Operating audio devices/audio media (▷ page 100)
- Operating video DVD (▷ page 101)

If no audio equipment is currently switched on, the message **AUDIO Off** appears in the multifunction display.

### Selecting radio station

**i** The SIRIUS XM Satellite Radio is treated as a radio application.

For more information on satellite radio operation, see "Satellite radio" (▷ page 125).

Vehicles with COMAND system:  
Refer to separate COMAND system operating instructions.

► Switch on the audio system (▷ page 112) and select radio.

Vehicles with COMAND system:  
Refer to separate COMAND system operating instructions.

► Press button or repeatedly until the currently tuned station appears in the multifunction display.



Example illustration

- ① Wave band setting and stored memory position
- ② Station frequency

► **Selecting next or previous stored station:** Press button or briefly to select a stored station.

► **Selecting next or previous station in the station list:** Press and hold button or to select a station.

► **Selecting next or previous station in wave band** (Only if no station list is available): Press and hold button or to select a station.

You can only store new stations using the corresponding feature on the radio (▷ page 124).

Vehicles with COMAND system:  
Refer to separate COMAND system operating instructions.



### Operating audio devices/audio media

► Switch on the audio system and select the audio device (▷ page 131) or audio media (▷ page 139).

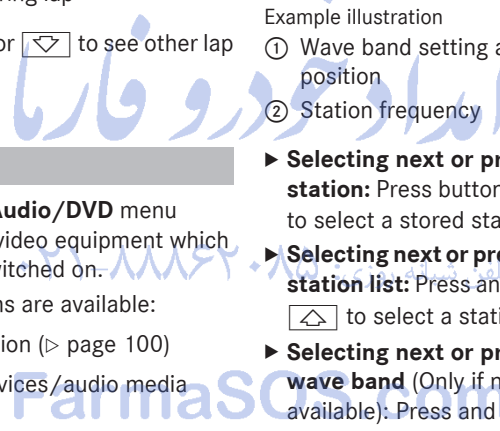
Vehicles with COMAND system:







Refer to separate COMAND system operating instructions.

- ▶ Press button  or  repeatedly until the **Audio/DVD** menu appears in the multifunction display.



Example illustration



- ① Disc number
- ② Current track

- ▶ **Selecting next or previous track:** Press button  or  briefly.
- ▶ **Selecting a track from the track list (quick search):** Press and hold button  or .

The current track does not appear during Audio AUX mode operation.

### Operating video DVD

This function is only available if your vehicle is equipped with the COMAND system.

- ▶ Switch on the COMAND system and select DVD-Video. Refer to separate COMAND system operating instructions.
- ▶ Press button  or  repeatedly until the **Audio/DVD** menu appears in the multifunction display.





- ① Disc number
- ② Current scene

- ▶ Press button  or  to select a scene.

### Navigation menu

The **Navigation** menu contains the functions needed to operate your navigation system.

- ▶ Press button  or  repeatedly until the **Navigation** menu appears in the multifunction display.

The message shown in the multifunction display depends on the status of the navigation system:

- With the COMAND system switched off, the message NAVI Off appears in the multifunction display.
- With the COMAND system switched on but route guidance not activated, the direction of travel and, if applicable, the name of the street currently traveled on appear in the multifunction display.
- With the COMAND system switched on and route guidance activated, the direction of travel and maneuver instructions appear in the multifunction display.

Please refer to separate COMAND system operating instructions for instructions on how to activate the route guidance system.

### Vehicle status message memory menu



Use the **Vehicle status message memory** menu to scan malfunction and warning messages that may be stored in the memory. Such messages appear in the multifunction display and are based on conditions or system status the vehicle's system has recorded.

The **Vehicle status message memory** menu only appears if messages have been stored.

#### **Warning!**



Malfunction and warning messages are only indicated for certain systems and are intentionally not very detailed. The malfunction and warning messages are

simply a reminder with respect to the operation of certain systems. They do not replace the owner's and/or driver's responsibility to maintain the vehicle's operating safety. Have all required maintenance and safety checks performed on the vehicle. Bring the vehicle to an authorized Mercedes-Benz Center to address the malfunction and warning messages.

- ▶ Press button  or  repeatedly until the **Vehicle status message memory** menu appears in the multifunction display. If conditions have occurred causing status messages to be recorded, the number of messages appears in the multifunction display.



- ① Number of recorded status messages

- ▶ Press button  or .
- The stored messages will now be displayed in the order in which they have occurred. For malfunction and warning messages, see "Vehicle status messages in the multifunction display" (▷ page 236).

Should the vehicle's system record any conditions while driving, the number of messages will reappear in the multifunction display when the SmartKey in the starter switch is turned to position **0** or removed from the starter switch.

Except for high-priority messages, the vehicle status message memory will be cleared when you switch off the ignition.

## Settings menu

### Introduction

In the Settings menu there are two functions: The function To reset, push reset button for 3 seconds, with which you can reset all the settings to the original factory settings and a collection of submenus with which you can make individual settings for your vehicle.



The following settings and submenus are available in the Settings menu:

- Resetting to factory settings (▷ page 102)
- Submenus in the Settings menu (▷ page 103)
- Instrument cluster submenu (▷ page 103)
- Time/Date submenu (▷ page 105)
- Lighting submenu (▷ page 105)
- Vehicle submenu (▷ page 108)
- Convenience submenu (▷ page 108)

### Resetting to factory settings

You can reset the settings of all submenus to the factory settings.

For safety reasons, the function Headlamp Mode in the Lighting submenu cannot be reset while driving.

- ▶ Press button  or  repeatedly until the Settings menu appears in the multifunction display.













- ▶ Press the reset button (R) in the instrument cluster for approximately 3 seconds. The message Reset to factory settings? Push reset button to confirm appears in the multifunction display.
- ▶ Press the reset button (R) once more. The settings of all the submenus will be reset to factory settings.

The settings you have changed will not be reset unless you confirm the action by pressing the reset button (R) a second time. After approximately 5 seconds, the Settings menu reappears in the multifunction display.

### Submenus in the Settings menu

- ▶ Press button  or  repeatedly until the Settings menu appears in the multifunction display.
- ▶ Press button . The collection of the submenus appears in the multifunction display. There are more submenus than can be displayed simultaneously.



- ▶ Press button . The selection marker moves to the next submenu.
- ▶ Scroll down with button , scroll up with button .
- ▶ With the selection marker on the desired submenu, use button  to access the individual functions within that submenu.
- ▶ Once within the submenu, use button  to move to the next function or button

 to move to the previous function within that submenu.

- ▶ Use button  or  to change the settings of the respective function.

The following lists show what settings can be changed within the various menus. Detailed instructions on making individual settings can be found on the following pages.

### Instrument cluster submenu

- Selecting speedometer display mode (▷ page 104)
- Selecting language (▷ page 104)
- Selecting display (digital speedometer or outside temperature) for status indicator (▷ page 104)

### Time/Date submenu

- Setting the time (▷ page 105)
- Setting the date (▷ page 105)

### Lighting submenu

- Switching daytime running lamp mode on or off (USA only) (▷ page 106)
- Switching locator lighting on or off (▷ page 106)
- Switching night security illumination (Headlamps delayed shut-off feature) on or off (▷ page 107)
- Switching interior lighting delayed shut-off on or off (▷ page 107)

### Vehicle submenu

- Switching automatic central locking on or off (▷ page 108)

### Convenience submenu

- Activating easy-entry/exit feature (▷ page 108)

### Instrument cluster submenu

Access the Instr. Cluster submenu via the Settings menu. Use the Instr.







## 104 Control system

Cluster submenu to change the instrument cluster display settings.



The following functions are available:

- Selecting speedometer display mode (▷ page 104)
- Selecting language (▷ page 104)
- Selecting display (digital speedometer or outside temperature) for status indicator (▷ page 104)



### Selecting speedometer display mode





- ▶ Press button  or  repeatedly until the Settings menu appears in the multifunction display.
- ▶ Press button .
- ▶ Move the selection marker with button  or  to the Instr. Cluster submenu.
- ▶ Press button  or  repeatedly until the message Display Unit Speed-/ Odometer appears in the multifunction display. The selection marker is on the current setting.





- ▶ Press button  or  to set speedometer unit to Km or Miles.

### Selecting language







- ▶ Press button  or  repeatedly until the Settings menu appears in the multifunction display.
- ▶ Press button .

- ▶ Move the selection marker with button  or  to the Instr. Cluster submenu.
- ▶ Press button  or  repeatedly until the message Language appears in the multifunction display. The selection marker is on the current setting.





- ▶ Press button  or  to select the language to be used for the multifunction display messages.

### Selecting display (digital speedometer or outside temperature) for status indicator

- ▶ Press button  or  repeatedly until the Settings menu appears in the multifunction display.
- ▶ Press button .
- ▶ Move the selection marker with button  or  to the Instr. Cluster submenu.
- ▶ Press button  or  repeatedly until the message Select Display appears in the multifunction display. The selection marker is on the current setting.



- ▶ Press button  or  to select the desired setting.  
The selected display is then shown continuously in the status indicator (lower display).  
The other display now appears in the **Standard display** menu (▷ page 96).

### Time/Date submenu

Access the Time/Date submenu via the Settings menu. Use the Time/Date submenu to change the time and date display settings.

The following functions are available:







- Setting the time (▷ page 105)
- Setting the date (▷ page 105)

### Setting the time

This function is only available in vehicles with audio system.



Vehicles with COMAND system:

For information on setting the time in the COMAND system, refer to the separate COMAND system operating instructions.







- ▶ Press button  or  repeatedly until the Settings menu appears in the multifunction display.
- ▶ Press button .
- ▶ Move the selection marker with button  or  to the Time/Date submenu.
- ▶ Press button  or  repeatedly until the message Time-Hours Press R To Confirm or Time-Minute(s) Press R To Confirm appears in the multifunction display.  
The selection marker is on the current setting.



Example illustration for setting the hour



- ▶ Press button  or  to set the hours or minute(s).
- ▶ Press reset button  to confirm.

### Setting the date

- ▶ Press button  or  repeatedly until the Settings menu appears in the multifunction display.
- ▶ Press button .
- ▶ Move the selection marker with button  or  to the Time/Date submenu.
- ▶ Press button  or  repeatedly until the message Set Date Month, Set Date Day, or Set Date Year appears in the multifunction display.  
The selection marker is on the current setting.



Example illustration for setting the month

- ▶ Press button  or  to set the month, day, or year.







### Lighting submenu

Access the Lighting submenu via the Settings menu. Use the Lighting submenu to change the lamp and lighting settings on your vehicle.



The following functions are available:

- Switching daytime running lamp mode on or off (USA only) (▷ page 106)
- Switching locator lighting on or off (▷ page 106)
- Switching night security illumination (Headlamps delayed shut-off feature) on or off (▷ page 107)
- Switching interior lighting delayed shut-off on or off (▷ page 107)

#### Switching daytime running lamp mode on or off (USA only)

- ▶ Press button  or  repeatedly until the Settings menu appears in the multifunction display.
- ▶ Press button .
- ▶ Move the selection marker with button  or  to the Lighting submenu.
- ▶ Press button  or  repeatedly until the message Headlamp Mode appears in the multifunction display. The selection marker is on the current setting.



- ▶ Press button  or  to select manual operation (Manual) or daytime running lamp mode (Constant).

With daytime running lamp mode switched on and the exterior lamp switch in position  or **AUTO**, the low-beam headlamps are switched on when the engine is running.

In low ambient light conditions the following lamps will come on additionally:

- Parking lamps
- Tail lamps

- License plate lamps
- Side marker lamps

For more information on the daytime running lamp mode, see (▷ page 72).

For safety reasons, resetting all the functions of all submenus to the factory settings while driving (▷ page 102) will not deactivate the daytime running lamp mode.

The following message appears in the multifunction display:

Lighting Cannot be completely reset to factory settings while driving.







#### Switching locator lighting on or off

With the locator lighting feature activated and the exterior lamp switch in position **AUTO**, the following lamps will come on during darkness when the vehicle is unlocked using button



- Parking lamps
- Tail lamps
- License plate lamps
- Side marker lamps
- Front fog lamps

The locator lighting goes out when the driver's door is opened.

If you do not open the driver's door after unlocking the vehicle with the SmartKey, the lamps will go out automatically after approximately 40 seconds.

- ▶ Press button  or  repeatedly until the Settings menu appears in the multifunction display.
- ▶ Press button .
- ▶ Move the selection marker with button  or  to the Lighting submenu.
- ▶ Press button  or  repeatedly until the message Surround Lighting Function appears in the multifunction display. The selection marker is on the current setting.



- ▶ Press button  or  to switch the locator lighting function On or Off.
- ▶ Turn the exterior lamp switch to position **AUTO** when exiting the vehicle. The locator lighting feature is activated.



### Switching night security illumination (Headlamps delayed shut-off feature) on or off





Use this function to set whether you would like the exterior lamps to remain on for 15 seconds during darkness after exiting the vehicle and closing all doors.

With the headlamps delayed shut-off feature activated and the exterior lamp switch in position **AUTO** before the engine is turned off, the following lamps will come on when the engine is turned off:



- Parking lamps
- Tail lamps
- License plate lamps
- Side marker lamps
- Front fog lamps

If, after turning off the engine, you do not open a door or do not close an opened door, the lamps will automatically go out after 60 seconds.

- ▶ Press button  or  repeatedly until the Settings menu appears in the multifunction display.
- ▶ Press button .

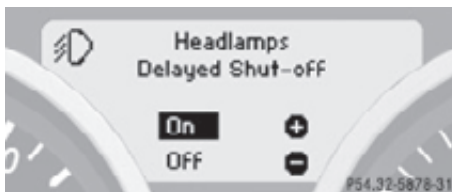
- ▶ Move the selection marker with button  or  to the Lighting submenu.
- ▶ Press button  or  repeatedly until the message Headlamps Delayed Shut-off appears in the multifunction display. The selection marker is on the current setting.





- ▶ Press button  or  to switch the headlamps delayed shut-off feature On or Off.
- ▶ Turn the exterior lamp switch to position **AUTO** before turning off the engine. The headlamps delayed shut-off feature is activated.





You can temporarily deactivate the headlamps delayed shut-off feature:

- ▶ Before exiting the vehicle, turn the SmartKey in the starter switch to position **0**.
- ▶ Then turn it to position **2** and back to position **0**. The headlamps delayed shut-off feature is deactivated. It will reactivate as soon as you start the engine.



### Switching interior lighting delayed shut-off on or off

Use this function to set whether you would like the interior lighting to remain on for 10 seconds during darkness after you have removed the SmartKey from the starter switch.

- ▶ Press button  or  repeatedly until the Settings menu appears in the multifunction display.
- ▶ Press button .

- ▶ Move the selection marker with button  or  to the Lighting submenu.
- ▶ Press button  or  repeatedly until the message Interior Lighting Delayed Shut-off appears in the multifunction display. The selection marker is on the current setting.









- ▶ Press button  or  to switch the interior lighting delayed shut-off feature On or Off.

### Vehicle submenu



Access the Vehicle submenu via the Settings menu. Use the Vehicle submenu to set the automatic central locking.

#### Switching automatic central locking on or off

Use this function to switch the automatic central locking on or off. With the automatic central locking activated, the vehicle is locked centrally at a vehicle speed of approximately 9 mph (15 km/h).

- ▶ Press button  or  repeatedly until the Settings menu appears in the multifunction display.
- ▶ Press button .
- ▶ Move the selection marker with button  or  to the Vehicle submenu.
- ▶ Press button  or  repeatedly until the message Automatic Door Lock appears in the multifunction display. The selection marker is on the current setting.



- ▶ Press button  or  to switch the automatic central locking On or Off.

### Convenience submenu

Access the Convenience submenu via the Settings menu. Use the Convenience submenu to activate the easy-entry/exit feature.

#### Activating easy-entry/exit feature

Use this function to activate and deactivate the easy-entry/exit feature (▶ page 67).



#### Warning!





You must make sure no one can become trapped or injured by the moving steering wheel when the easy-entry/exit feature is activated.

To stop steering wheel movement do one of the following:



- Move steering wheel adjustment stalk.
- Press one of the memory position buttons.
- Press memory button **M**.

Do not leave children unattended in the vehicle, or with access to an unlocked vehicle. Children could open the driver's door and unintentionally activate the easy-entry/exit feature, which could result in an accident and/or serious personal injury.

- ▶ Press button  or  repeatedly until the Settings menu appears in the multifunction display.
- ▶ Press button .

- ▶ Move the selection marker with button  or  to the Convenience submenu.
- ▶ Press button  or  repeatedly until the message Easy-entry Function appears in the multifunction display. The selection marker is on the current setting.



- ▶ Press button  or  to activate (On) or deactivate (Off) the easy-entry/exit feature.

### Trip computer menu

Use the **Trip computer** menu to call up statistical data on your vehicle.

The following information is available:

- Fuel consumption statistics since start (▷ page 109)
- Fuel consumption statistics since last reset (▷ page 109)
- Resetting fuel consumption statistics (▷ page 110)
- Distance to empty (▷ page 110)

### Fuel consumption statistics since start



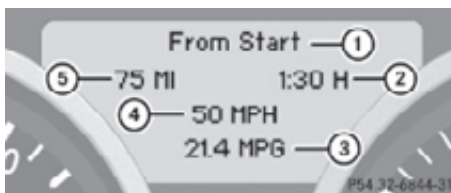

- ▶ Press button  or  repeatedly until the message From Start appears in the multifunction display.



- ① Statistics called up: since start
- ② Time elapsed since start
- ③ Average fuel consumption since start
- ④ Average speed since start
- ⑤ Distance driven since start

All statistics stored since the last engine start will be reset approximately 4 hours after the SmartKey in the starter switch is turned to position **0** or removed from the starter switch. Resetting will not occur if you turn the SmartKey back to position **1** or **2** within this time period.



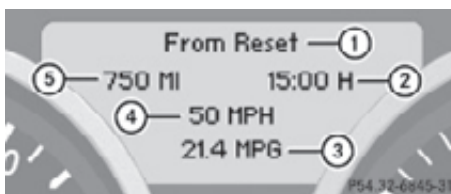

### Fuel consumption statistics since last reset

- ▶ Press button  or  repeatedly until the message From Start appears in the multifunction display.
- ▶ Press button  or  repeatedly until the message From Reset appears in the multifunction display.







- ① Statistics called up: since last reset
- ② Time elapsed since last reset
- ③ Average fuel consumption since last reset
- ④ Average speed since last reset
- ⑤ Distance driven since last reset

### Resetting fuel consumption statistics

- ▶ Press button  or  repeatedly until the message **From Start** appears in the multifunction display.
- ▶ Press button  or  repeatedly until the reading that you want to reset appears in the multifunction display.
- ▶ Press and hold the reset button  in the instrument cluster until the respective values are reset to 0.

The fuel consumption statistics reset automatically to 0 after 99 999 miles or 9 999 hours, whichever occurs first.

### Distance to empty

- ▶ Press button  or  repeatedly until the message **From Start** appears in the multifunction display.
- ▶ Press button  or  repeatedly until the message **Range:** appears in the multifunction display.

The calculated remaining driving range based on the current fuel tank level appears in the multifunction display.

If only very little fuel is left in the tank, a vehicle at the fuel pump  appears instead of the remaining driving range.





### Telephone menu

#### **Warning!**

A driver's attention to the road must always be his/her primary focus when driving. For your safety and the safety of others, we recommend that you pull over to a safe location and stop before placing or taking a

telephone call. If you choose to use the telephone while driving, please use the hands-free device and only use the telephone when weather, road and traffic conditions permit. Some jurisdictions prohibit the driver from using a mobile phone while driving a vehicle. Bear in mind that at a speed of just 30 mph (approximately 50 km/h), your vehicle is covering a distance of 44 feet (approximately 14 m) every second.

You can connect your telephone to the audio system (▷ page 146) or to the COMAND system via Bluetooth®, see separate COMAND system operating instructions.

- ▶ Switch on the audio system (▷ page 117) or the COMAND system, see separate COMAND system operating instructions.
- ▶ Press button  or  repeatedly until the **Telephone** menu appears in the multifunction display. One of the following messages will appear in the multifunction display:
  - **No Service:** No network is available.
  - **Bluetooth Ready:** The telephone has not been connected to the audio system or COMAND system via Bluetooth® yet.
    - ▶ Connect the telephone to the audio system or COMAND system via Bluetooth®.
  - **Ready or name of the network provider** (if available): The telephone has found a network and is ready for use. You can operate it using the control system.

### Answering a call

When your telephone is ready to receive calls, you can answer a call at any time. In the multifunction display you will then see the following message, or if available, the caller ID (number or name):





- ▶ Press button . You have answered the call.

### Ending a call or rejecting an incoming call

- ▶ Press button .

### Dialing a number from the phone book

When your telephone is ready to receive calls, you may select and dial a number from the phone book. You can add new numbers to the phone book with the telephone (▷ page 153). Vehicles with COMAND, see separate operating instructions.

- ▶ Press button or repeatedly until the **Telephone** menu appears in the multifunction display.
- ▶ Press button or repeatedly until the desired name appears in the multifunction display. If you press and hold button or for longer than 1 second, the system scrolls rapidly through the list of names until you release the button again. The stored names are displayed in alphabetical order.



Example illustration

- ① Selected name from the phone book

- ▶ Press button . The control system dials the selected phone number. If the connection is successful and this feature is supported by your network provider, the name of the party (if stored in your phone book) you are calling will appear in the multifunction display. The control system stores the dialed number in the redial memory.

or

- ▶ Press button if you do not want to make the call.

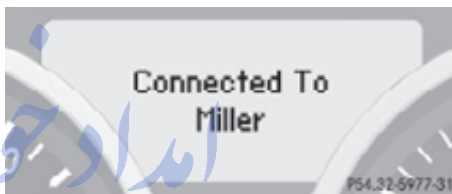

### Redialing

The control system stores the most recently dialed phone numbers. This eliminates the need to search through your entire phone book.

- ▶ Press button or repeatedly until the **Telephone** menu and the standby message appears in the multifunction display.
- ▶ Press button . The first number in the redial memory appears in the multifunction display.
- ▶ Press button or repeatedly until the desired number or name appears in the multifunction display.
- ▶ Press button . The control system dials the selected phone number.

## Audio system

### Audio and telephone operation

These instructions are intended to help you become familiar with your Mercedes-Benz audio system. They contain useful tips and a detailed description of the user functions.

#### **Warning!**

In order to avoid distraction which could lead to an accident, the driver should enter system settings with the vehicle at a standstill and operate the system only when road and traffic conditions permit. Always pay full attention to traffic conditions first before operating system controls while driving.

Bear in mind that at a speed of just 30 mph (approximately 50 km/h), your vehicle is covering a distance of 44 feet (approximately 14 m) every second.

### Operating safety

#### **Warning!**

Any alterations made to electronic components can cause malfunctions.

The radio, amplifier, CD changer, satellite radio, and telephone are interconnected.

When one of the components is not operational or has not been removed/replaced properly, the function of other components may be impaired.

This condition might seriously impair the operating safety of your vehicle.

We recommend that you have any service work on electronic components carried out at an authorized Mercedes-Benz Center.

### Audio system components

With the audio system you can operate the following main functions:

- Audio function with the radio, Satellite radio, disc (CD audio or MP3 mode), Audio AUX and external audio devices
- the mobile phone with the phone book
- various system settings

In addition, the audio system can also be operated with the multifunction steering wheel (▷ page 94).

In these instructions, the keypad (right side of audio control unit) and the function buttons are referred to as “buttons”.

### Audio control unit

With the audio control unit you can

- switch the audio system on/off
- adjust the volume
- select the operating modes
- enter telephone numbers and accept, reject, initiate and end telephone calls
- load and eject CDs

Audio control unit overview

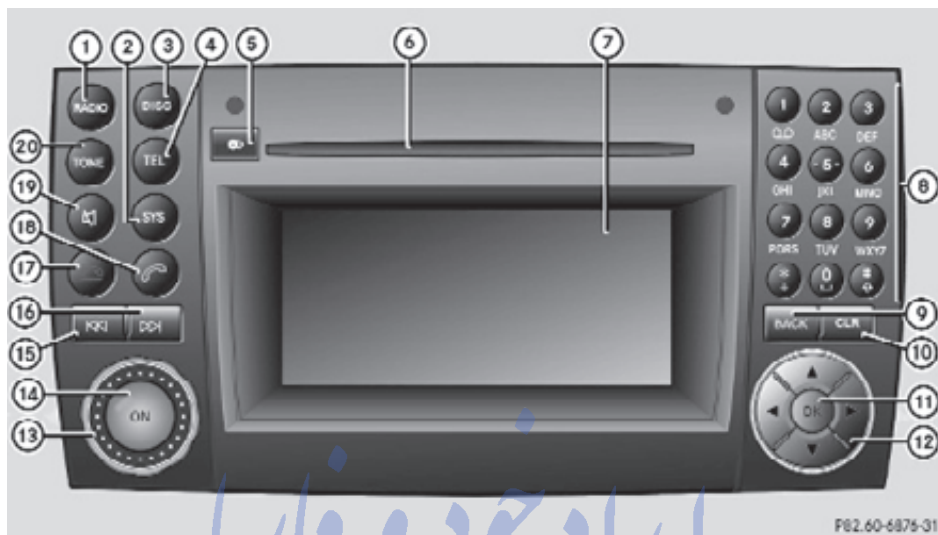

Controls in detail

Item	
①	Switching to radio mode (> page 122) Calling up wave bands (> page 122) Switching on Sat mode (> page 127)
②	Calling up the System Settings menu (> page 120)
③	Switching to CD and MP3 mode (> page 131) or media interface mode (> page 139)
④	Switching to telephone mode (> page 146)
⑤	Load/eject button (> page 134)
⑥	Disc slot
⑦	Display
⑧	Keypad Tuning to a station via the station memory (> page 123) Storing stations manually (> page 124) Entering a passcode (> page 150) Entering a phone number (> page 156) Sending DTMF tones (> page 159) CD changer: Selecting a CD (> page 137) CD: Selecting a track (> page 138)
⑨	Back button
⑩	Clear button for deleting digits or entire entries (> page 157)
⑪	Confirmation button
⑫	Navigation buttons for moving within menus and for exiting menus
⑬	Adjusting the volume (> page 117)
⑭	Switching audio system on/off (> page 117)

15	Tuning to a station via station search (▷ page 123) Fast rewind (▷ page 138) Skipping backwards to a track (▷ page 138)
16	Tuning to a station via station search (▷ page 123) Fast forward (▷ page 138) Skipping forwards to a track (▷ page 138)
17	Rejecting a call (▷ page 158) Ending an active call (▷ page 158)
18	Confirming a passcode (▷ page 150) Accepting a call (▷ page 158) Initiating a call (▷ page 156) Redial (▷ page 157)
19	Switching sound on/off (▷ page 118) Switching hands-free microphone on/off (▷ page 158)
20	Sound settings (▷ page 118)

### Audio display

**!** Avoid touching the audio display at all times. The display has a very sensitive high-gloss surface, there is a risk of it being scratched. Do not press directly in the display face. Otherwise, the audio display will be damaged.

**i** For information about cleaning and care of the audio display, see “Audio or COMAND display” (▷ page 231).

### Display

The currently selected mode and the associated menus are shown on the audio display. The audio display is divided into several areas.

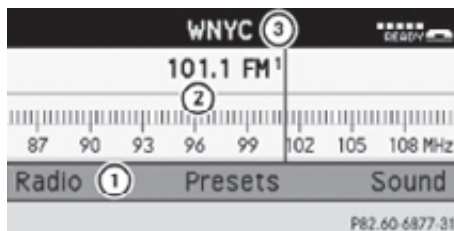

Example illustration: Radio selected

Status line ③ displays the current settings for radio and telephone mode.

You can request the required function using menu bar ①.

The selection is made using buttons



Mobile phone readiness is indicated by additional information being shown in the status line:

- In the telephone main menu: Name of the Bluetooth® device (calls made and received via the Bluetooth® interface) (▷ page 151).
- Mobile phone network signal strength . This information will only be shown with suitable mobile phones.
- The receiver symbol indicates whether a call is active or not.
  - No active call
  - Active call

In this example, the audio main function is set to the FM radio mode and main area ② is active.

**i** The layout of the menus may vary depending on your vehicle's equipment. This manual shows the menus for a fully equipped vehicle.

### Instrument cluster multifunction display

Please refer to the “Control system” section of this manual (▷ page 93) for function descriptions and operation of the instrument cluster multifunction display and

multifunction steering wheel buttons as they relate to audio functions described in this section.

### Menu

The table below shows the structure of the modes and their menus. Each mode has a basic menu. Each menu item in turn has several submenu items.

Button	Mode/Menu
[RADIO]	<b>Radio mode</b>
	Radio (FM/AM) (▷ page 121)
	Weather Band (▷ page 121)
	Satellite radio (▷ page 125)
[DISC]	<b>Disc mode</b>
	CD/MP3 mode (▷ page 131)
	Media interface operation (▷ page 139)
	Audio AUX mode (▷ page 145)
[TEL]	<b>Telephone mode</b>
	Telephone mode (▷ page 146)
[SYS]	<b>System menu</b>
	System settings (▷ page 119)
	Display on/off (▷ page 120)

### Calling up an operating mode

- ▶ Press the respective button ([RADIO], [DISC], [TEL], or [sys]) on the audio control unit. The basic menu of the selected mode appears in the audio display. The main area is active. The active area is highlighted.

**i** The following screens show the audio display's day design. The appearance of the highlighted items in the menu will vary depending on the display design.

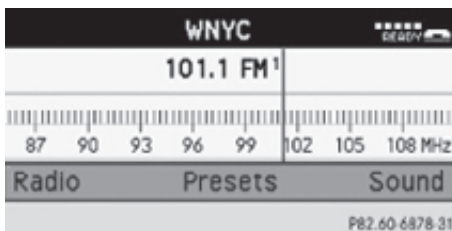
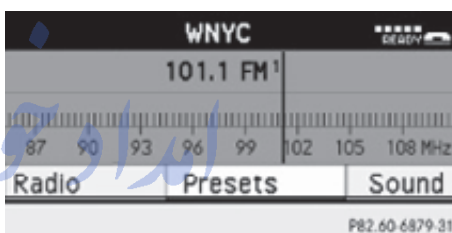

Illustration: Radio function basic menu

- ▶ **Moving to the menu bar:** Press button .

### Horizontal menus



- ▶ **Moving through the menu bar:** Press button  or .
- The currently selected item is highlighted.
- ▶ **Confirming the selected menu item:** Press button .
- ▶ **Exiting the menu bar without confirming a selection:** Press button  or .

### Vertical submenus

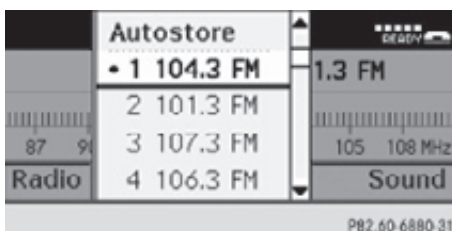

- ▶ **Moving through the submenu:** Press button  or .
- The currently selected item is highlighted.
- ▶ **Confirming the selected submenu item:** Press button .
- ▶ **Exiting the submenu without confirming a selection:** Press button  or .

### Back button

- ▶ **Moving to the superordinate menu:** Press back button  briefly.
- ▶ **Moving to the main menu of the current operating mode:** Press and hold back button .

### Clear button

Use clear button  for deleting digit or entire entries (▷ page 157).

- ▶ **Deleting a single digit:** Press button  briefly.
- ▶ **Deleting entire entry:** Press and hold button .

### Example of how to use the audio system

Example: direct frequency input, FM 104.5 MHz.

→ Radio → Enter Frequency

The individual steps for the above-mentioned example are described below.

- ▶ Press button  on audio control unit repeatedly until desired wave band FM has been selected.
- ▶ **Switching to the menu bar:** Press button .

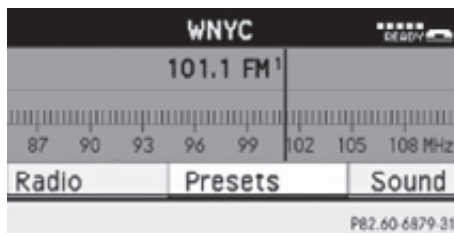

- ▶ **Selecting Radio in the menu bar:** Press button .

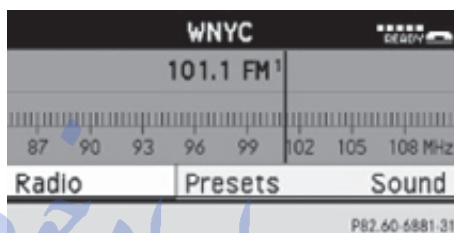

- ▶ **Confirming selection:** Press button .
- The Radio menu is selected and a list of submenus appears.



- ▶ Enter Frequency is selected.
- ▶ **Confirming selection:** Press button .
- The Enter Frequency submenu appears.

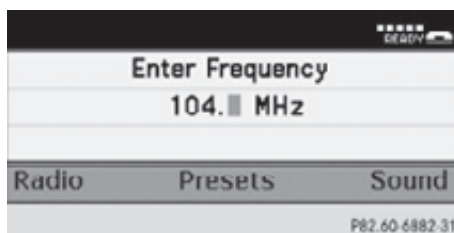

- ▶ **Information:** It is not possible to enter a frequency in the respective wave band which is outside

the frequency range. Frequencies within the current frequency range, but outside the current frequency step width are rounded to the next lower allowed frequency.

- ▶ Enter 1045 with the keypad on the audio control unit.  
The audio system tunes in to the frequency entered.

### Operation

In the following description, an operation step is described as in the example below.

- ▶ **RADIO** → Radio → Enter Frequency is the short for
- ▶ Press button **RADIO** on audio control unit repeatedly until desired wave band has been selected.
- ▶ Press button **▼**.
- ▶ Press button **◀** to select Radio.
- ▶ Press button **OK**.  
The Radio menu is selected and a list of submenus appears.
- ▶ Enter Frequency is selected. If it is not selected, press button **▲** to select Enter Frequency.
- ▶ Press button **OK**.  
The Enter Frequency submenu appears in the audio display.

### Switching audio system on or off



- ▶ **Switching on:** Press push button **ON**.

or

- ▶ If the audio system was on as you switched off the ignition, turn the SmartKey in the starter switch to position 1.  
The audio system will come back on with the last selected function.

- i** If the audio system is switched on without the SmartKey in the starter switch, it will automatically switch off again after approximately 30 minutes.

- ▶ **Switching off:** Press push button **ON**.

or

- ▶ Turn the SmartKey in the starter switch to position 0 and remove SmartKey from starter switch.

- i** Should excessively high temperatures occur while the audio system is being operated, Temperature Too High - Device switching off now. will appear in the audio display, after which the audio system will be switched off for a cooling-down period.

- i** When you switch off the audio system, you also switch off the currently playing audio source. Also, telephone operation via the audio control unit is not possible.

### Adjusting volume







- ▶ **Adjusting:** Turn rotary control . The volume will increase or decrease depending on the direction turned.

### Adjusting volume for telephone calls



In hands-free mode, you can adjust the volume of a telephone call while the call is currently active.

During a telephone call:

- ▶ Turn rotary control . The volume will increase or decrease depending on the direction turned.
-  The volume of the audio system or a telephone call can also be adjusted by pressing the button  or  on the multifunction steering wheel (▶ page 94).

### Sound

- ▶ **Switching on/off:** Press button  on the audio control unit (▶ page 113). The sound of the current audio source is switched on or off.

-  When the sound is switched off, the symbol  appears in the status line. If you change the audio source, or alter the volume, the sound is automatically switched on again. In CD and MP3 mode, button  switches the pause function on or off.

### Selecting sound settings

You can select different bass and treble settings for each individual audio source. The particular Sound menu can be opened from the basic menu for the desired operating mode, or by pressing the button  on the audio control unit.

Example:

 → Sound → Bass

### Adjusting bass or treble





- ▶  → Bass or Treble.

or

- ▶ Select Sound → Bass or Treble. A longer and brighter bar indicates the previously stored setting. The red pointer indicates the currently selected setting.



Example for adjusting bass

- ▶ **Changing setting:** Press button  or  until desired treble or bass setting is reached.
- ▶ **Saving setting:** Press button  or . The setting is stored and the menu is exited.

### Adjusting balance

Balance is used to determine whether the sound focus should be shifted toward the driver's side or the passenger side.

- ▶  → Balance.

or

- ▶ Select Sound → Balance. The current setting is indicated by a red line.

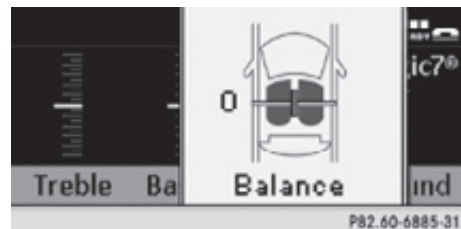

Adjusting balance



▶ **Changing setting:** Press button ◀ or ▶ until desired balance setting is achieved.

▶ **Saving setting:** Press button OK or BACK. The balance setting is stored for all audio sources and the menu is exited.

### Surround sound

If your vehicle is equipped with the harman/kardon Logic7® Surround Sound system, you can choose between Logic7® On and Logic7® Off for surround sound.

harman/kardon Logic7® Surround Sound is available for the following operating modes:

- Radio (FM only)
- Satellite radio
- CD audio
- MP3
- Media interface
- AUX

**i** By selecting Logic7® Off, all compatible formats are played back as they are present on the medium.

### Adjusting surround sound

With surround sound, you can choose between Logic7® On and Logic7® Off.

▶ TONE → Sound.

or

▶ Select Sound → Sound.

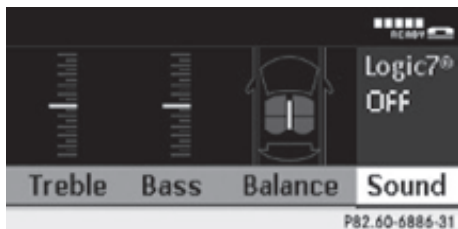

▶ **Changing setting:** Press button OK.  
▶ Press button ▲ or ▼ to switch Logic7® on or off.

▶ **Saving setting:** Press button OK. The setting is stored and the menu is exited.

▶ **Exiting menu without saving:** Press button ◀ or ▶.

**i** Please note the following:

- For an optimal sound experience from all seats, the balance should be adjusted to the center setting with Logic7® switched on.
- The best sound results are achieved when playing high-quality audio CDs.
- For MP3 tracks, the bit rate should be at least 128 kbit/s.
- Surround playback cannot be activated in mono-signal sources as AM or Weatherband. It will not function for mono-signal sources as, e.g. mono audio tracks on some specific audio CDs.
- In the case of poor radio reception quality, e.g. during long tunnel passages, Logic7® should be switched off, as otherwise a dynamic switchover from stereo to mono and thus temporary sound characteristic shifts can occur.
- With certain stereo recordings, the resulting sound characteristic may deviate from conventional stereo playback.

### SYS menu

#### System settings menu overview

Menu
System Settings
Language (▷ page 121)
Display (▷ page 120)
Brightness
Day Mode

Menu
Night Mode
Automatic
<b>Bluetooth®</b> (▷ page 120)
<b>Reset</b> (▷ page 121)
<b>Display off</b> (▷ page 120)

### Calling up the System Settings menu

- ▶ Press button **[sys]**.  
The System menu appears.



- ① Calling up menu options
- ② Switching off display

### Display settings

You can adapt the brightness of the audio display to the prevailing light conditions.

#### Setting the display design

- ▶ **[sys]** → System Settings → Display.
- ▶ Select Brightness, Day Mode, Night Mode or Automatic.

- i** When you select Brightness, a scale appears on which you can set the brightness manually.

In the Automatic setting, the audio system analyzes the automatic vehicle light sensor and switches between the display designs automatically.

### Switching display on/off

- ▶ **Switching display off:** Select Display Off.

- ▶ **Switching display on:** Press button **[ON]**, button **[BACK]**, or either of the navigation buttons **[◀]**, **[▶]**, **[▲]**, **[▼]**.

or

- ▶ Press button **[ON]**.  
The System menu appears.

- i** Pressing any of the function buttons, for example button **[DISC]**, will also switch on the display. The system will then switch to the respective function.

### Bluetooth® settings

#### General information about Bluetooth®

Bluetooth® technology is the standard for short-range wireless technologies, suitable for transmitting voice and data. It is possible to connect Bluetooth® devices wirelessly. Bluetooth® can be used to exchange vCards or to make calls using a hands-free device.

Bluetooth® technology uses the freely available ISM (Industrial Scientific Medical) wave band that works at 2.45 GHz. Bluetooth® works within a range of up to 33 ft (10 m).

#### Activate or deactivate Bluetooth®

- ▶ **[sys]** → System Settings → Bluetooth → Activate Bluetooth.

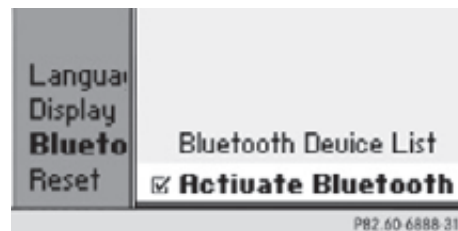

You have activated or deactivated Bluetooth®. A checkmark  appears when Bluetooth® is activated.

## Reset

- i** You can reset the audio system back to its factory settings. In this case, all personal data (e.g. address book entries, call lists, paired mobile phones, and presets) are deleted. We recommend that you reset the values before selling your vehicle.
- ▶ **[sys]** → System Settings → Reset.  
A prompt appears asking whether you really want to reset.
- ▶ Select Yes or No.  
If you select Yes another prompt will appear asking whether you really want to reset.
- ▶ Select Yes or No.  
If you select Yes, the audio system will be reset and restarted.

## Setting the system language

- ▶ **[sys]** → System Settings → Language.



The language list appears. A dot • in front of an entry indicates the current setting.

- ▶ **Changing setting:** Press button **[▲]** or **[▼]** to select desired language.
- ▶ **Saving setting:** Press button **[OK]**.  
The setting is stored and the menu is exited.
- ▶ **Exiting menu without saving:** Press button **[◀]**.

When choosing setting Language Synchronization, the audio system switches to the same language that is used in the multifunction display.

## Radio operation

### ⚠ Warning!

Please devote your attention first and foremost to the traffic situation you are in. Before your journey, please familiarize yourself with the radio functions. Only use the audio system when road and traffic conditions permit you to do so. Otherwise you could be involved in an accident in which you or others could be injured.

- !** Do not attach metallic window tinting film to the inside or outside of windows which are fitted with an aerial. Obstructing the metallic aerial structure on the window will interfere with radio reception. Cutting the film on the window can permanently damage the aerial wires.

- i** The radio mode is interrupted by an incoming call on the mobile phone (▷ page 146).

## Menu overview

- i** The components and operating principles of the audio system can be found on (▷ page 112) and (▷ page 116). Information about sound settings can be found on (▷ page 118).

Menu	Function
<b>Radio</b> (except Weather Band/satellite radio)	Enter frequency Station information (in FM wave band only)
<b>Presets</b> (except Weather Band)	Autostore (except satellite radio) List of stored stations
<b>Channel</b> (only Weather Band)	List of channels

Menu	Function
Sound	Treble
	Bass
	Balance
	Surround Sound

### Switching to radio mode

- ▶ Press button **RADIO** on audio control unit. The radio basic menu appears in the audio display. The radio switches to the last station you have listened to. Weather Band will automatically tune to the strongest station in the area.

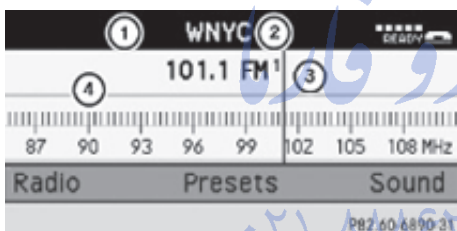

Illustration: Radio mode in FM wave band

- Status line
  - Station name or other information from the station
  - Station frequency and stored position
  - Main area with wave band
- i** Station name or other information ②, available for the FM wave band, can only be seen when the station transmits the name or other information and the function Show Station Info in the Radio menu is activated.

- ▶ **RADIO** → Radio → Show Station Info

In the WB wave band, the audio system displays the channel number, e.g. Channel 6, instead of the station names and/or frequency.

### Information displayed in the status line (example)

Station name (e.g. WNYC) and mobile phone readiness are displayed in the status line.

Mobile phone readiness is indicated by additional information being shown:

- Mobile phone network signal strength
- Receiver symbol

### Calling up wave bands

You can select FM, AM, and WB wave bands as well as the Sat mode (▷ page 125). When you have selected the Sat mode, pressing button **RADIO** will switch back to FM radio mode.

Wave band	Frequency
FM	87.7..... 107.9 MHz
AM	530..... 1710 KHz
WB (Weather Band)	Weather channels
Satellite radio	Satellite radio channels

- ▶ Press button **RADIO** on audio control unit repeatedly until the desired wave band has been selected. The FM, AM, and WB wave bands and the satellite radio mode are called up one after another. The wave band currently selected appears in the main area of the audio display. The last selected station in the selected wave band is heard.

### Selecting a station/channel

The following functions are available:

- Station search function
- Channel list (Weather Band/satellite radio)

- Station memory (except Weather Band)
- Manual frequency entry (except Weather Band/satellite radio)

For using satellite radio see (▷ page 125).

The station search proceeds in the following frequency increments:

- 200 kHz in FM range
- 10 kHz in AM range

### Tuning to a station/channel via station/channel search function

**i** The search function searches for the next receivable station in the FM or AM wave band. In Weather Band (WB) the search function switches to the next channel in the channel list. For tuning to a station/channel you can also use the buttons on the multifunction steering wheel, see **Audio/DVD** menu (▷ page 100).

- ▶ Press button **RADIO** on audio control unit repeatedly until the FM/AM/WB wave band is selected.
- ▶ Press buttons **◀◀** **▶▶** or **◀** **▶** on audio control unit. Depending on the pressed button, the system searches downward or upward and stops at the next station/channel.

### Selecting a station using station memory

**i** This function is not available for Weather Band.

- ▶ Press button **RADIO** on audio control unit repeatedly until desired wave band has been selected.
- ▶ Select Presets. The memory menu appears. The dot • in front of a memory position indicates that the currently selected station is saved there.

- ▶ Select a station in the memory menu using the buttons **▲** and **▼** and press **OK**.

or

- ▶ Press desired station button **1** to **9**, with the keypad in audio control unit briefly.

### Tuning to a station by entering the frequency manually

**i** This function is not available for Weather Band/satellite radio.

- ▶ **RADIO** → Radio → Enter Frequency  
The menu for manual frequency entry appears.

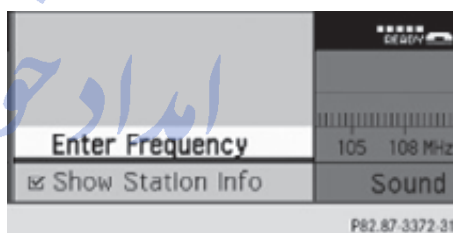

or **تلفن شبانه روزی: ۰۲۱-۸۸۴۲۰۸۵**

- ▶ Press button **✱** on the keypad in audio control unit briefly. The Enter Frequency submenu appears.

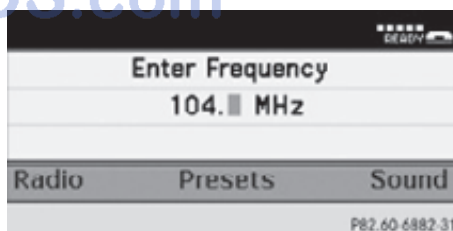

- ▶ **Entering frequency with keypad:** Enter desired frequency with buttons  $\boxed{1}$  to  $\boxed{0}$  on the keypad in audio control unit. The audio system tunes in to the frequency entered.

**i** It is not possible to enter a frequency in the respective wave band which is outside the frequency range.

- ▶ **Exiting menu without making an entry:** Press button  $\boxed{\text{BACK}}$ .

### Storing stations

You can store ten AM and ten FM stations in the memory.

**i** If you select a memory preset which is already in use, it will be overwritten by the new station.

### Storing stations manually with keypad

- ▶ Tune in desired station.  
The basic menu appears in the audio display.
- ▶ Press and hold desired station button  $\boxed{1}$  to  $\boxed{0}$  until a brief signal tone sounds.  
The station is stored.

### Storing stations manually with station memory menu

- ▶ Tune in desired station.  
The basic menu appears in the audio display.
  - ▶ Press button  $\boxed{\text{OK}}$  when the main area is active.
- or
- ▶ Select Presets.  
The station memory display appears in the audio display.

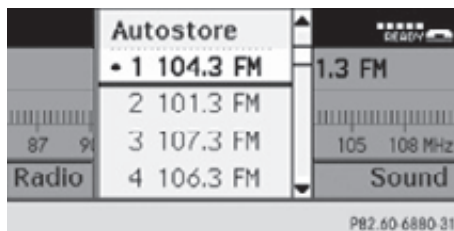





The dot • in front of a memory position indicates that the currently tuned station is stored there.

- ▶ **Selecting a memory position:** Press button  $\boxed{\blacktriangle}$  or  $\boxed{\blacktriangledown}$ .
  - ▶ **Storing a station to a selected memory position:** Press and hold button  $\boxed{\text{OK}}$  until a brief signal tone sounds.
- or
- ▶ Press and hold desired station button  $\boxed{1}$  to  $\boxed{0}$  on keypad, until a brief signal tone sounds.  
The station is stored.

### Autostore – automatic station memory

- i** This function is not available for Weather Band/satellite radio. The autostore function automatically assigns receivable stations to the memory. The stations are sorted according to reception quality at the moment of performing the autostore. The stations which were stored in the station memory manually are overwritten in this process. If less than ten stations are found, the remaining entries are left empty.
  - ▶ Press button  $\boxed{\text{RADIO}}$  on audio control unit repeatedly until desired wave band has been selected.  
The basic menu appears in the audio display.
  - ▶ Press button  $\boxed{\text{OK}}$  when the main area is active.
- or
- ▶ Select Presets.  
The station memory display appears in the audio display.





- ▶ Press button  or  to select Autostore.
- ▶ Press button .
 

The audio system searches for receivable stations. A corresponding message is displayed. The available stations are automatically stored in the station memory. The first received station will be automatically played.
- ▶ **Canceling storage procedure:** Select Cancel and press  while the message Rewriting memory... is being displayed.

### Displaying information

You can display program information or other additional information when provided by the radio station you are listening to.

- ▶ Press button .
 

The available information appears. The content and scope of the information depends on the radio station.
- ▶ **Closing screen:** Press button , , , , or .

### Satellite radio

#### **Warning!**

Please devote your attention first and foremost to the traffic situation you are in.

Before your journey, please familiarize yourself with the radio functions.

Only use the audio system when road and traffic conditions permit you to do so. Otherwise you could be involved in an accident in which you or others could be injured.

### Submenu overview

-  The components and operating principles of the audio system can be found on (> page 112) and (> page 116).

Menu	Submenu
<b>Sat</b>	Channel List
	Channel Entry
	Service
<b>Presets</b>	Station presets
<b>Info</b>	Information menu (if available)
<b>Category (Cat.)</b>	All channels
	Select category
<b>Sound</b>	Treble
	Bass
	Balance
	Surround Sound

### Satellite radio

-  Additional satellite radio equipment and a subscription to SIRIUS XM Satellite Radio service provider are required for the satellite radio operation described in this chapter.

Contact an authorized Mercedes-Benz Center for details and availability for your vehicle.

SIRIUS XM Satellite Radio provides over 130 channels of digital-quality radio, including 100% commercial-free music, sports, news and entertainment. SIRIUS XM Satellite Radio uses a fleet of high-power satellites to broadcast 24 hours per day, coast to coast, in the contiguous U.S. and Canada.

This diverse, satellite-delivered programming is available for a monthly subscription fee.

For more information and service availability call the SIRIUS XM Service Center at 1-888-539-7474 (> page 130), or visit [www.sirius.com](http://www.sirius.com) (USA) or [www.siriuscanada.ca](http://www.siriuscanada.ca) (Canada).

**i** Note that categories and channels shown in illustrations are dependent on programming content delivered by the service provider. Programming content is subject to change. Therefore, channels and categories shown in illustrations and descriptions contained in this manual may differ from the channels and categories delivered by the service provider.

**i** Satellite radio service may be unavailable or interrupted from time to time for a variety of reasons, such as environmental or topographic conditions and other things we cannot control. Service might also not be available in certain places (e.g. in tunnels, parking garages, under leafy trees, or within or next to buildings) or near other obstructions. In such situations, the satellite radio's main menu shows the No Service screen. At this point, the radio's functions are restricted.

### Subscribing to satellite radio

- ▶ Press button **RADIO** on audio control unit repeatedly until Sat is selected.

The following conditions are possible:

- Satellite radio service is not activated (only the preview channel is displayed).
- Satellite radio service is activated.

**i** If a satellite receiver is not installed or not properly installed:  
The message **Device Unavailable** will appear.  
If the satellite radio service is not activated, the "SIRIUS Preview" display appears.

### Satellite radio service is not activated

The telephone number of the SIRIUS XM Service Center and the twelve-digit electronic serial number (SIRIUS-ID) of the particular receiver are required when calling the SIRIUS XM Service Center for an activation request.

- ▶ **RADIO** (repeatedly, if necessary) → Sat  
→ Service.



- ▶ **Closing screen:** Press button **OK** or **BACK**.

- ▶ **Activating satellite radio service:**  
Contact satellite radio service provider at the telephone number displayed in the service display.

After the connection is made:

- ▶ Follow the instructions given by the operator.  
The activation process may take up to 10 minutes. If it is successful, you will see the display with the message **Updating Channels...** followed by the satellite radio basic menu.

**i** Activating the satellite radio service might not be available in certain places (e.g. in tunnels, parking garages, under leafy trees, or within or next to buildings). If a subscription is not included with system purchase, credit card information is required to activate your account.

The activation process takes approximately 5 to 10 minutes after calling the SIRIUS XM Service Center.

If a satellite receiver is not installed or not properly installed: The message **Device Unavailable** will appear.

- i** It is also possible to activate the satellite radio service online. To do so please visit SIRIUS XM Satellite Radio's website at **www.sirius.com** (USA) or **www.siriuscanada.ca** (Canada).



### Preview Channel

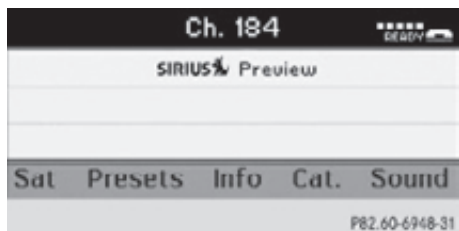

- i** If the satellite radio service has not been subscribed to, only the preview channel is available. You cannot tune in another channel. If you try to do this, the message Call SIRIUS to activate: appears.

### Satellite radio service is activated

The basic satellite radio menu appears. You will hear the last tuned channel, provided that it can be received.

### Switching on Sat mode

For important subscription information see “Subscribing to satellite radio” (▷ page 126).

- ▶ Press button **RADIO** on audio control unit repeatedly until Sat is selected. The message No Service will appear when the signal is not available. After the audio system acquires the signal, the satellite radio basic menu will appear. The last tuned station will begin to play.

### Main satellite radio menu

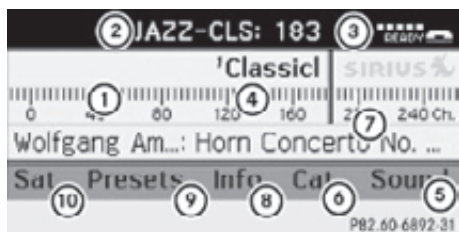

- ① Main area with channel display
- ② Selected program category
- ③ Number of selected channel
- ④ Selected channel

- ⑤ Sound settings
- ⑥ Selecting program category
- ⑦ Current artist and title
- ⑧ Channel information
- ⑨ Preset options
- ⑩ Satellite radio options

- i** Main area ① displays only channels that you have subscribed to. Which channels are shown depends on the selected program category ②. Only the currently selected channel ④ is displayed.

Note that categories and channels shown in illustrations are dependent on programming content delivered by the service provider. Programming content is subject to change.

Therefore, channel and categories shown in illustrations and descriptions contained in this manual may differ from the channels and categories delivered by the service provider.

### Selecting program category

- i** The channels are categorized. Categories allow you to tune to stations broadcasting a certain type of program.

Satellite radio channels are split up into categories such as News, Sports, Rock, or Country, if available. The category list is sorted alphabetically.

- ▶ **Calling up category list:** **RADIO** (repeatedly, if necessary) → Cat.

or

- ▶ In Sat mode, press button **◀** or **▶** until Cat. is highlighted and press button **OK**. The category list appears.

► **Selecting a category:** Press button  or .

► **Setting the selected category:** Press button .

The selected program category (alphabetical order) will appear in the audio display. The last tuned channel in the new category will begin to play.

When searching, tuning in, or selecting from the channel list, the All Channels option accesses all of your subscribed channels.



**i** When you select the category All Channels, you have access to all the channels you subscribed to, regardless of category.

### Tuning in channels

You have the following selection options:

- the channel search function
- the manual channel number entry
- the channel list
- the channel presets

### Tuning in channels using channel search function

► Press button  or  when the main area in the basic menu is active. Depending on the pressed button, the system searches upward or downward and stops at the next subscribed channel.

or

► Press button  or  on audio control unit.

Depending on the pressed button, the system searches upward or downward and stops at the next subscribed channel.

**i** Which channels are available depends on which channels you have subscribed to and the program category you have selected (> page 127). For tuning in channels you can also use the buttons on the

multifunction steering wheel, see “Audio menu” (> page 100).

### Tuning in channels using manual channel number entry



►  (repeatedly, if necessary) → Sat → Enter Channel.

The menu for manual channel number entry appears.

or

► In Sat mode, press button  on the keypad in audio control unit briefly.

► **Channel number entry with keypad:**

Enter desired channel number with buttons  to  with the keypad in audio control unit briefly.

Further operation depends on whether the selected channel number is valid or if the channel is included in your subscription.

► **Exiting menu without making an entry:**





Press button .

**Channel number is valid and channel is included in subscription:** The audio system tunes in the channel entered.

**Channel number is invalid:** The message Invalid Channel appears in the audio display.

► Press button , ,  or  to close the message.

**Channel number is valid, but channel is not included in subscription:** The message Call SIRIUS to activate: appears (> page 126).

► Press button , ,  or  to close the message in the audio display.

### Tuning in channels using the satellite radio channel list

- ▶ **RADIO** (repeatedly, if necessary) → Sat → Channel List.
- The channel list appears. The dot • in front of a list entry indicates the currently selected channel.
- ▶ Select channel by pressing button **▲** or **▼**.
- ▶ Press button **OK** to confirm.

**i** The contents of the channel list depends on which channels are included in your subscription and which program category you have selected (▶ page 127). The channel list contains only the preview channel if the satellite radio service has not been subscribed to.

### Tuning in channels using satellite radio channel presets

- ▶ **RADIO** (repeatedly, if necessary) → Presets.
- or
- ▶ Press button **OK** when the main area is selected in Sat mode.
- The preset menu appears. The dot • in front of a preset position indicates that this is the channel currently selected and being listened to.



- ▶ Select station in memory by pressing button **▲** or **▼**.
- ▶ Press button **OK** to confirm.
- or
- ▶ Press desired station button **1** to **0**, with the keypad in audio control unit briefly.

The audio system tunes in the corresponding channel as long as it is included in your subscription and is still available.

If the channel is not included in your subscription, the message Call SIRIUS to activate: appears.

If the channel is no longer available, the message Invalid Channel appears.

- ▶ **Closing message:** Press button **OK**.

### Storing channels

- i** There are ten preset positions available.
- ▶ Press button **OK** when the main area is selected.
- or
- ▶ **RADIO** (repeatedly, if necessary) → Presets.



In both cases, the preset menu will appear in the audio display. The dot • in front of a preset position indicates that the channel currently selected is stored there.



► **Selecting a preset position:** Press button  or .

► **Storing a preset position:** Press and hold button  until you hear a signal. The channel is stored.

or

► Press and hold desired channel button  to  on keypad, until a brief signal tone sounds. The channel is stored.

### Displaying information

►  (repeatedly, if necessary) → Info (if available).





**i** If the program provider does not offer any information, the Info menu item cannot be selected.

You will see a screen that may contain the following information:

- the selected program category
- the selected channel
- the artist of the track currently being played
- the name of the current track

**i** SIRIUS XM determines what information is displayed on the screen. If the information is too long, the audio system shortens it.

With the telephone keypad button  you can call up a popup screen, if provided by SIRIUS XM, that shows the artist and title of the current track being played on the selected channel.

► **Closing screen:** Press button , , , or .



### Calling SIRIUS XM Service Center

**i** It may be necessary to call the SIRIUS XM Service Center if, for example:

- You want to cancel the subscription or re-subscribe at a later date.
- You have questions regarding billing.
- You sell the car.

►  (repeatedly, if necessary) → Sat → Service.

The telephone number of the SIRIUS XM Service Center and the twelve-digit electronic serial number (SIRIUS-ID) of the particular receiver are displayed.

► **Closing screen:** Press button , , , or .

### Channel update

The service provider may conduct a channel update.

During the update, the message Updating Channels... will appear on the audio display. *تلفن شبانه روزی*

The last tuned channel will be muted until the update is completed. You cannot operate the satellite radio during the update.

After completion of the update, the satellite radio basic menu will appear. The last tuned station will begin to play. If not available, the next subscribed channel starts beginning with channel 1.

### Sound settings

For sound adjustment see:

- Volume (▷ page 117)
- Balance control (▷ page 118)
- Bass and treble control (▷ page 118)
- Surround sound (▷ page 119)

**CD and MP3 mode****Submenu overview**

Menu	Submenu
<b>CD or MP3</b>	Normal Track Sequence
	Random Tracks
	Random Folders (MP3 mode only)
	AUX
<b>Track list (Audio CD) or Folder (MP3)</b>	Select track (CD mode only)
	Select folder and/or tracks (MP3 mode only)
<b>CD changer or other media</b>	Media selection
<b>Sound</b>	Treble
	Bass
	Balance
	Surround sound

- i** The components and operating principles of the audio system can be found on (▷ page 112) and (▷ page 116).

The audio system is fitted with a CD changer. The CD changer can play audio CDs as well as CDs with MP3 or WMA files. The available menu options will vary depending on the equipment and the type of CD.

**Safety precautions****⚠ Warning!**

The CD changer is classified as a Class 1 laser product. You must not open the casing. There is a risk of exposure to invisible laser radiation

if you open the casing, or if the casing is faulty or damaged.

The CD changer does not contain any parts that you are able to maintain yourself. For safety reasons, all maintenance work must be carried out by qualified technicians.

**⚠ Warning!**

In order to avoid distraction which could lead to an accident, the driver should insert or eject CDs with the vehicle at a standstill and operate the audio system only if permitted by road, weather and traffic conditions.

Bear in mind that at a speed of just 30 mph (approximately 50 km/h), your vehicle is covering a distance of 44 feet (approximately 14 m) every second.

**General notes**

- i** Audio CDs with copy protection are not compatible with the CD audio standard and therefore may not be able to be played by the CD changer. There may be playback problems when playing copied discs.

There is a large variety of discs, disc-writing software and writers available. This variety means that there is no guarantee that the system will be able to play discs that you have written/copied yourself.

There may be playback problems if you use CD-R or CD-RW type discs you have compiled yourself with a storage capacity of more than 700 MB. These CDs are not compatible with currently applicable standards.

- !** Do not affix stickers or labels to the CDs, they can become warped due to the heat that develops in the CD changer.

In certain situations, the CDs can then no longer be ejected and cause damage to the CD changer. Such damage is not covered by the Mercedes-Benz Limited Warranty.

**!** Your CD changer has been designed to play CDs which correspond to the IEC 60908 standard. You can therefore only use CDs with a maximum thickness of 1.3 mm.

If you insert thicker discs, e.g. ones that have data on both sides (one side with DVD data, the other side with audio data), they cannot be ejected and will damage the CD changer.

Do not use CDs with a diameter of 8 cm. Attempting to play CDs with a diameter of 8 cm or playing such CDs with an adapter may cause damage to the CD changer. Such damage is not covered by the Mercedes-Benz Limited Warranty.

Only use round discs with a diameter of 12 cm.

Should excessively high or low temperatures occur while in CD changer mode, a message will appear in the display, and the CD will be muted until the temperature has reached an acceptable level for the system to continue operation.

#### Tips on handling CDs

- Only touch the CDs at the edges.
- Handle CDs carefully to prevent interference during playback.
- Avoid scratches, fingerprints and dust on the CDs.
- The CDs must only be labeled using pens specially designed for this purpose.
- Clean CDs from time to time with a commercially available cleaning cloth. Never wipe the CD in a circular motion; instead, wipe it in a straight line starting in the center and moving outward. Do not use solvents, anti-static sprays, etc. for cleaning.
- Replace the CD in its case after use.
- Protect CDs from heat and direct sunlight.

#### Notes about MP3 mode

The CD changer can play audio CDs as well as CDs with MP3/WMA files.

**i** Due to the branched data structure, playback of the first track may be delayed slightly.

#### Permissible media for MP3/WMA files

- CD-R
- CD-RW

#### Permissible file systems

- ISO9660/Joliet for CDs

#### Multisession CDs

For multisession CDs, the first session type of the CD determines how the audio system will process the CD.

For example, if the first session type is according to the audio CD standard and the second session type is according to the data CD standard containing MP3/WMA tracks, the audio system will treat the CD as a conventional audio CD. This means that it is only possible to access the audio CD tracks. Access to the MP3/WMA tracks is not possible.

Similarly, if the first session type is according to the data CD standard containing MP3/WMA tracks and the second session type is according to the audio CD standard, the audio system will treat the CD as a data CD. This means that it is only possible to access the MP3/WMA tracks. Access to the audio CD tracks is not possible.

#### File structure on a disc

When you create an MP3/WMA disc, the MP3/WMA tracks can be organized in folders.

A folder can also contain other folders.

A disc can contain a maximum of 255 folders.

A folder can contain a maximum of 255 tracks and 255 subfolders.

A data medium may contain a maximum of 500 tracks.

The directory depth may not exceed a maximum of 8 levels. The system will ignore files in lower levels.

### Track and folder names

When you create an MP3/WMA disc, you can assign names to the MP3/WMA tracks and folders.

The audio system uses these names for the corresponding display in MP3 mode. Empty folders or folders which contain data other than MP3/WMA tracks are not displayed by the audio system.

If MP3/WMA files are saved in the root directory itself (uppermost directory on storage medium), the root directory will also be treated as a folder. The audio system will then show the name of the root directory as the folder name.

You must observe the following when assigning track names:

- Track names must have at least one character.
- Track names must have the extension “mp3” or “wma”.
- There must be a period between the track name and the extension.

Example of a correct track name:

Track1.mp3

The audio system is unable to recognize an MP3/WMA track if

- there is no period between the track title and the extension
- there is no extension

**i** The audio system does not support ID3 tags.

### Supported file formats

Supported file formats are:

- MP3
- WMA

**i** If music files of file formats other than MP3 are stored together with MP3 files on one disc, the loading process may take longer.

### Permissible MP3 formats

The audio system supports the MPEG1 Audio Layer 3 format.

**i** This format is generally known as “MP3”.

Permissible bit and sampling rates are:

- fixed and variable bit rates up to 320 kbit/s
- Sampling rates of 24 kHz – 48 kHz

**i** Only use MP3 tracks with a bit rate of at least 128 kbit/s or higher and a sampling rate of at least 44.1 kHz or higher. Smaller rates can cause a noticeable deterioration in sound quality. This is especially the case if you have the surround sound function activated.

### WMA (Windows Media® Audio)

Windows Media® Audio (WMA) is an audio data compression technology developed by Microsoft®.

The audio system supports the following types of audio files:

- fixed bit rates of 5 kbit/s up to 384 kbit/s
- Sampling rates from 8 kHz to 48 kHz

The audio system does not support the following WMA files:

- DRM (Digital Rights Management) coded files
- variable bit rates
- WMA Pro
- 5.1 Surround

### Notes on copyright

The music tracks that you create and play back in the MP3 and WMA format are generally subject to copyright protection in

accordance with the applicable international and national regulations.



In many countries, reproductions are not permitted without the prior consent of the copyright holder, not even for private use.

Make sure you know the applicable copyright regulations and that you comply with these.

If you own these rights yourself, e.g. for your own compositions and recordings, or the copyright holder has granted you permission, these restrictions do not apply.

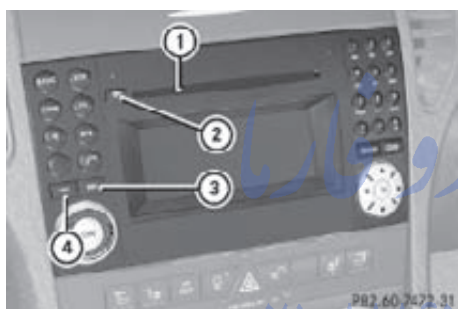
### Operating the CD changer



- ① CD slot
- ② Load/eject button 
- ③ Forward 
- ④ Rewind 

The CD changer can hold up to a total of six audio CDs.

- ▶ **Switching to CD mode:** Press button  on the audio control unit.

The CD mode display appears when you switch to CD mode. If there is a CD in one of the magazine trays, it will start to play automatically. The following message will appear if no CDs are inserted.

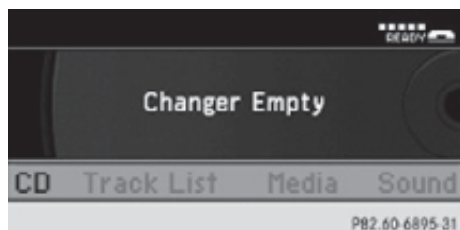

### Warning!



In order to avoid distraction which could lead to an accident, the driver should insert or eject CDs with the vehicle at a standstill and operate the audio system only if permitted by road, weather and traffic conditions.

Bear in mind that at a speed of just 30 mph (approximately 50 km/h), your vehicle is covering a distance of 44 feet (approximately 14 m) every second.



- ❗ If the audio CD is printed on one side, this side must face upwards when loaded. If neither side is printed, the side to be played must face downwards.

If a CD has been inserted incorrectly or cannot be read, Disc Unreadable appears in the display.

### Loading an individual magazine compartment:

- ▶ Press load/eject button . A menu indicates which magazine compartments are currently loaded.
- ▶ Press desired button  to  in the keypad to select a magazine compartment.

or

- ▶ Press button  or  to select a magazine compartment. The selected magazine compartment is indicated by a red number.
- ▶ Press button  to confirm. The CD changer will switch to the selected magazine compartment. The message Please Wait... appears in the display.

- ❗ Only insert a CD after the audio system has prompted you to do so with the message Please Insert Disc <X>. Only insert one CD per magazine compartment.

- ▶ Insert CD into CD slot. The CD changer automatically pulls the CD into the CD slot and places it in the selected magazine compartment. The message



Loading Disc <X>... appears in the display.

- i** The loading process may take a while, depending on the type of disc. If you do not insert a disc, the display will switch back to the CD changer menu after approximately 20 seconds.
- ▶ Press button **[disc]**, or the load/eject button **[▶]** on the audio control unit to finish the loading process. The CD changer plays the disc if it has been inserted correctly and is permissible.
- ▶ **Interrupting loading procedure:** Press the load/eject button again.

#### Filling an empty magazine compartment

- ▶ Press load/eject button **[▶]**. A menu indicates which magazine compartments are currently loaded. A red number indicates the last magazine compartment that has been played or selected.



- ▶ Press button **[▼]** to select the menu bar.
- ▶ Press button **[▶]** to select Fill Empty Slots.
- ▶ Press button **[OK]**. The message Please Insert Disc <X> appears in the display.
- i** Only insert a CD after the audio system has prompted you to do so with the message Please Insert Disc <X>. Only insert one CD per magazine compartment.
- ▶ Insert CD into CD slot. The CD changer automatically pulls the CD into the CD slot and places it in an empty

magazine compartment. The message Please Wait... appears in the display. If the CD is loaded, the CD changer will switch to the next empty magazine compartment. The message Please Insert Disc <X> appears in the display.

- ▶ Repeat the steps until all compartments have been loaded.
- ▶ Press load/eject button **[▶]** on the audio control unit to finish the loading process. The CD changer plays the last loaded disc if it has been inserted correctly and is permissible.
- ▶ **Interrupting loading procedure:** Press load/eject button **[▶]** again. The loading process has not been completed, the audio system will play the last inserted CD.

#### Ejecting CDs from CD changer

##### **Warning!**

In order to avoid distraction which could lead to an accident, the driver should insert or eject CDs with the vehicle at a standstill and operate the audio system only if permitted by road, weather and traffic conditions.

Bear in mind that at a speed of just 30 mph (approximately 50 km/h), your vehicle is covering a distance of 44 feet (approximately 14 m) every second.

- i** If you eject a CD while another is being played, the audio system interrupts playback.
- ▶ **Ejecting one CD:** Press load/eject button **[▶]**. The magazine menu with active main area appears in the audio display. The magazine compartment with the current CD is highlighted.

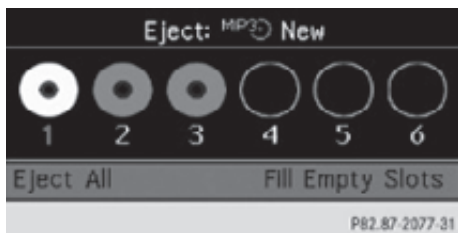

- ▶ Press desired button **1** to **6** in the keypad to select a magazine compartment.
- or

- ▶ Press button **◀** or **▶** to select the desired CD.

- ▶ Press button **OK** to confirm. The CD is ejected.

- ▶ Remove the CD from CD slot **1**. If you do not remove the CD from the CD slot, the CD changer will automatically pull the CD back in after a short while.

- ▶ **Ejecting all CDs:** Press load/eject button **⏻**.

The magazine menu with active main area appears in the audio display. The magazine compartment with the current CD is highlighted.



- ▶ Press button **▼** to select the menu bar.
- ▶ Press button **◀** to select Eject All.
- ▶ Press button **OK** to confirm. The CDs are ejected one after the other.
- ▶ Remove the CD from CD slot **1**. The CD changer switches to the next occupied magazine compartment and ejects the CD.

If you do not remove the CD from CD slot **1**, the CD changer will automatically pull the CD back in after a short while.

- i** If audio source is changed during eject procedure (e.g. pressing button **RADIO**) the eject procedure will be aborted and any CDs being ejected will be drawn back into the unit.

- ▶ Repeat the last step until the magazine is empty.

### Switching to audio CD or MP3 operation

- ▶ Load a CD.

The audio system loads the inserted audio source and starts playback.

or

- ▶ Press function button **DISC** repeatedly until the main menu of the CD or MP3 mode appears.

- i** The function button switches directly to the last selected disc operation mode (audio or MP3 CD). In doing so, the audio system accesses all media in the CD changer.

- i** Pressing the function button repeatedly switches from CD or MP3 mode to the media interface mode and then to the AUX mode. Pressing again switches back to CD or MP3 mode.

### Display example for audio CD operation



- ① Media type
- ② Medium position in the media list
- ③ Track number

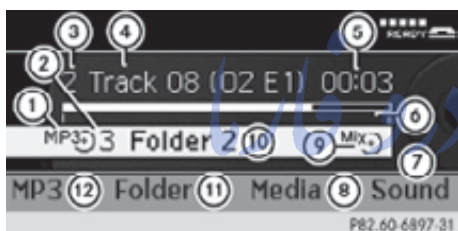

- ④ Track name (only if stored on the medium as CD text)
- ⑤ Elapsed track time
- ⑥ Elapsed track time (graphical display)
- ⑦ Sound settings
- ⑧ Media selection (Changer or Media)
- ⑨ Current playback option (visible if activated)
- ⑩ Medium name (only if stored on the medium as CD text)
- ⑪ Calling up track list
- ⑫ Playback options

#### Display example for MP3 operation



- ① Media type
- ② Medium position in the media list
- ③ Track number
- ④ Track name
- ⑤ Elapsed track time
- ⑥ Elapsed track time (graphical display)
- ⑦ Sound settings
- ⑧ Media selection (Changer or Media)
- ⑨ Current playback option (visible if activated)
- ⑩ Current folder
- ⑪ Calling up folder list
- ⑫ Playback options

#### Pause function

- ▶ **Pausing playback:** Press  briefly.
- ▶ **Continuing playback:** Press  again briefly.

#### Selecting audio CD or MP3 medium

- ▶ Switching to audio CD or MP3 operation (▷ page 136).
  - ▶ Select Changer or Media.
- or
- ▶ In audio CD operation only: Press button  when the main area is selected in the display.

The media list appears. A dot • indicates the currently selected medium.

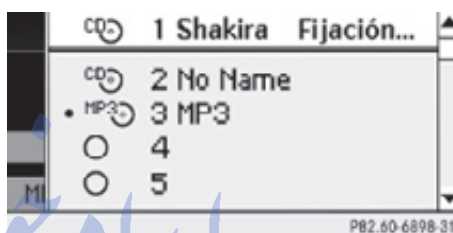



#### Media list

The media list displays all media that are currently available:



- in the CD changer (magazine compartments 1 through 6)
- The following media can be read:
  - audio and MP3 CDs
- devices connected to the media interface (▷ page 139).

**i** The message **Disc unreadable** appears behind the magazine compartment number if a medium cannot be read.

- ▶ **Selecting medium:** Press button  or .

- ▶ Press button .

or

- ▶ **Selecting medium directly:** In CD mode you can select a disc directly by pressing the respective number of the magazine compartment on the keypad ( through .

### Selecting a track

- ▶ **Skipping forwards or backwards to a track:** Press button or when the main area is selected in the display.

or

- ▶ Briefly press button or on audio control unit.

- ❗ Skipping forwards through the tracks skips to the next track. Skipping backwards through the tracks skips to the beginning of the current track if the track has been playing for more than 8 seconds. If the track has been playing for less than 8 seconds, it skips to the start of the previous track. If you have switched on the Random Tracks playback option, the order of the tracks is random.

### Selecting via track list

- ▶ **In audio CD operation:** Select Track List.

or

- ▶ **In MP3 operation:** Press button when the main area is selected in the display.

The track list appears. A dot • indicates the current track.

- ▶ **Selecting a track:** Press button or .

- ▶ Press button to confirm.

- ❗ In MP3 mode, the list shows all the tracks in alphabetical order.

### Selecting via keypad

- ▶ Press button on the keypad. A numerical input field appears. The number of available digits depends on the number of tracks on the CD. You can only enter digits that correspond with the number of tracks on the CD.

- ▶ Select the desired track number.

- ❗ When you press a keypad button for longer than 2 seconds, input is completed and the respective track is played. You can

then omit the next step by pressing button .

- ▶ **Completing input:** Press button . The track is played.

### Fast forward/rewind

- ▶ **Main area is selected:** Press and hold button or until desired place is reached.

or

- ▶ Press and hold button or on audio control unit.

### Selecting a folder

- ❗ This function is only available in audio MP3 mode.

- ▶ Switch to MP3 operation (▷ page 136).
- ▶ Select Folder.

or

- ▶ Press button when the main area is selected in the display. The folder list appears.

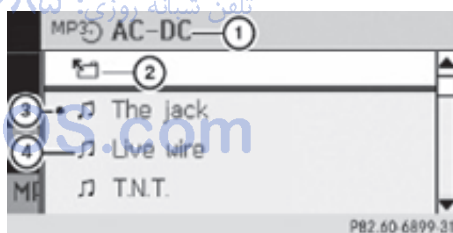

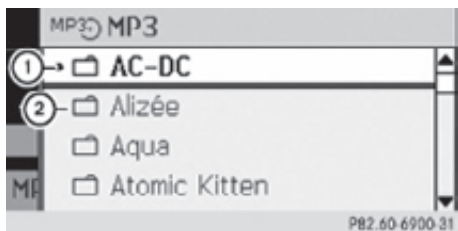

- ① Current folder name
- ② Moving to superordinate folder
- ③ Current track
- ④ Track symbol

- ▶ **Move to the superordinate folder:** Select the symbol and press button . The display now shows the next higher folder level.



- ① Current folder
- ② Folder symbol

▶ **Selecting a folder:** Press button  or .

▶ Press button  to confirm.  
You will see the tracks in the folder.

**i** Due to the large amount of information found on an MP3 disc it may take a while before all folder and track information becomes available. During this time the folder list may be unavailable or slow.

▶ **Selecting a track:** Press button  or .

▶ Press button  to confirm.  
The track is played and the corresponding folder is now the active folder.

### Playback options

The following options are available:

- Normal Track Sequence  
Tracks playback in the order on the disc (e.g. track 1, 2, 3, etc.).
- Random Tracks  
Tracks playback in a random order (e.g. track 3, 8, 5, etc.).
- Random Folder (in MP3 mode only)  
Tracks in the active folder playback in random order.

▶ **Selecting options:** Switch to audio CD or MP3 operation.

▶ Select CD or MP3 and press button .

The option list appears. A dot • indicates which option is switched on.

▶ Select an option and press .

The option is switched on. For all options except Normal Track Sequence, you will see a corresponding indicator in the main area.

**i** The Normal Track Sequence option is automatically activated when you select a different medium. If an option is activated, it remains activated after the audio system is switched on/off.

### Media interface

#### Warning!

Operating an external audio source while the vehicle is in motion will distract you. You may not notice changing road and/or traffic conditions which may cause an accident. Bear in mind that at a speed of just 30 mph (approximately 50 km/h), your vehicle is covering a distance of 44 feet (approximately 14 m) every second.

For your safety and the safety of others, pull over to a safe location and stop before operating an external audio source.



① Media interface

**Notes**

**i** The media interface allows for connection of the following media with the audio system:

- iPod®
- USB storage media
- Audio devices with analog output (AUX), e.g. MP3 or tape players.

**i** Do not leave external devices in the vehicle under extremely high or low temperatures. Read and observe the operating instructions of the respective device. Damage to external devices due to excessive temperature is not covered by the Mercedes-Benz Limited Warranty.

Do not operate iPods® or USB storage media with a remote control such as Bluetooth® in addition to the media interface control. Otherwise malfunctions may occur.

Always use the latest firmware for the iPod® or USB storage media.

Only use genuine software for uploading to your iPod® or MP3 player as otherwise certain functions may not be available or the system may not recognize the device.

Connecting a completely discharged iPod® or USB storage medium can increase the initialization time.

Only use genuine Mercedes-Benz connectors.

**i** Suitable connector cables are located in the vehicle or can be purchased at any authorized Mercedes-Benz Center.

Depending on the device, loading large audio files may take several minutes.

When the power consumption of the external device is too high or the media interface is not functioning properly, malfunction messages will be displayed.

**i** For information on compatible multimedia devices and iPod® versions

- visit [www.mbusa-mobile.com](http://www.mbusa-mobile.com)
- call the Mercedes-Benz Customer Assistance Center at 1-800-FOR-MERCEdes (1-800-367-6372) (in the USA)
- call Customer Service at 1-800-387-0100 (in Canada)

**Special characteristics of USB storage media**

- If the storage medium contains other data than audio data, the time required for initialization increases. Initialization may then take several minutes. Therefore, audio data should be stored on a separate partition.
- Up to 8 folder levels containing up to 1 000 tracks per folder are supported.
- Do not use USB extension cables or connectors as they may impair functionality.
- The playlists on the device are searched for in the background. They are provided in a separate category once they are available.
- The media interface does not support files that are protected by DRM (Digital Rights Management).

**Supported USB storage media**

The following USB storage media are supported:

- USB Flash Drives
- USB hard disks, 1", 1.8", and 2.5" drives with a starting/continuous current rating of maximum 800 mA (otherwise a separate power supply will be necessary)
- MP3 players
  - basic MP3 player are treated as USB storage media
  - for selected MP3 players additional functions are supported

The media interface supports USB storage media of USB Device SubClass 6. Information

on USB Device SubClasses of storage medium are available from the manufacturer of the device.

### Supported file formats on USB storage media

The following file formats are supported:

- mp3: CBR, VBR (up to 320 kbit/s)
- wma: CBR, VBR (up to 320 kbit/s)
- m4a: low complexity (LC) codec
- playlists: m3u, pls

ID3 Tags (version 1.x, 2.3, 2.4) and WMA tags in ASCII and UTF16 coding are supported to display meta data during playback.

### Connecting external audio devices

 **Observe Safety notes, see page 139.**

 External devices that you take into the vehicle can interfere with radio reception.

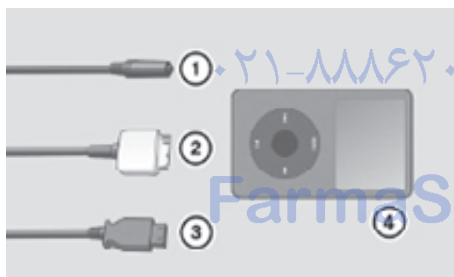

P82.60-6736-31

- ① 3.5 mm stereo jack AUX cable (4-pin) for connecting external devices via a headphone port or a separate audio out port (AUX), e.g. MP3 or tape player
- ② iPod® cable
- ③ USB cable for supported USB storage media (optional)
- ④ Example device iPod®

▶ Connect the audio device to the media interface in the glove box using the

required cable ①, ②, or ③ while the vehicle is standing still.

▶ Store the audio device carefully in the glove box and make sure not to clamp or pitch the cables.

 You can control playback of devices that are connected by USB cable ③ or iPod® cable ② via the audio system. Devices that are connected by an AUX cable ① must be controlled on the device itself.

### Media interface operation

#### Selecting device

▶ Press button  repeatedly until the main menu for media interface operation appears (▶ page 142).

▶ Select Media.

▶ Press button .

The media list appears.

 You can also select Media to open the media list when CD mode is active.





P82.60-6902-31

The following are available:

- **List number 0:** iPod® or USB storage medium (The name of the device appears or, if no device is connected, Media Interface.)
- **List numbers 1 - 6:** CD magazine
- **List number 7:** Device connected to the AUX socket

A dot • indicates the currently selected device.

- ▶ Select the desired device by pressing button  and/or .
- ▶ Press button  to confirm.

The main menu for media interface operation appears. The selected device starts to playback.

- i** You can also select external devices directly: Press button  when CD mode is active.

When you have connected a new device, the audio system initializes it. The respective message appears.

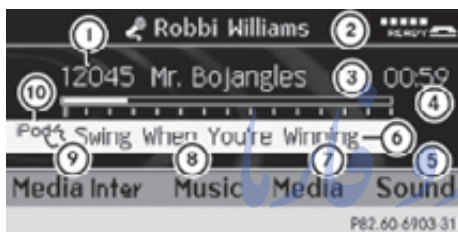

Main menu for media interface operation

- ① Current track number
- ② Name of artist (if stored on the medium)
- ③ Track name
- ④ Elapsed track time (graphical display)
- ⑤ Sound settings
- ⑥ Name of current album (if stored on the medium)
- ⑦ Medium list
- ⑧ Music (categories)
- ⑨ Settings menu
- ⑩ Symbol of connected medium

- i** When you connect a medium via iPod® or USB cable while the audio function is active, the audio system initializes the device and starts to playback.

### Selecting AUX device

-  **Observe Safety notes, see page 139.**

#### **Warning!**

Due to the different volumes of the external audio sources, system messages of the vehicle may be much louder. You may need to disable these system messages or adjust the volume of these messages manually.

- i** The volume of external audio sources is extremely variable. It is possible that a device connected as an external audio source will sound quieter or louder in the vehicle or that the usual maximum volume cannot be achieved. On certain devices the volume can be set separately. In this case, start at a moderate volume and increase it slowly. In this way, you can determine whether the system is capable of playback without distortion, even at high volume.

### Selecting an AUX device:

- ▶ Press button  repeatedly until the main menu for AUX operation appears.



- ▶ Select Media.
  - ▶ Press button .
- The media list appears.

- i** You can also select Media to open the media list when CD mode is active.
- ▶ Select AUX device at list number 7 of the media list.
- i** You can also select an AUX device directly: Press button  when CD mode is active.



### Deselecting an AUX device:

- ▶ Press **[DISC]** to switch back to CD mode.

### Selecting audio files

- i** The audio system lists the stored data on an iPod®, MP3 player, or USB storage medium according to their own respective file structure.

### Selecting via track skipping

- ▶ **Skipping backwards or forwards to a track:** Press button **[◀]** or **[▶]**.

or

- ▶ Briefly press button **[⏮]** or **[⏭]** on audio control unit.

- i** Skipping forwards through the tracks skips to the next track. Skipping backwards through the tracks skips to the beginning of the current track if the track has been playing for more than 8 seconds. If the track has been playing for less than 8 seconds, it skips to the start of the previous track. When you have chosen a playback option other than Normal Track Sequence, the track sequence is random.

### Selecting via keypad

- ▶ **Initiating input:** Press button **[\*]**.

A numerical input field appears. The number of available digits depends on the number of stored tracks.

- ▶ **Entering track number:** Press a keypad button, e.g. **[7]**.

The digit appears in first place of the entry line.

- i** The audio system will reject invalid entries and does not display them.

- ▶ Enter additional digits as required.
- ▶ **Completing input:** Press button **[OK]**.

or

- ▶ Press and hold keypad button for last digit of desired track number.

The track is played.

### Fast forward/rewind

- ▶ **Main area is selected:** Press and hold button **[◀]** or **[▶]** until desired place is reached.

or

- ▶ Press and hold button **[⏮]** or **[⏭]** on audio control unit.

- i** With an iPod® the function “fast rewind” is only available within the current track.

### Selecting categories and folders

#### iPod® and selected MP3 players

iPods® and selected MP3 players let you select tracks via categories and folders.

The following categories may be available:

- Current Track List
- Playlists
- Artists
- Albums
- Tracks
- Podcasts
- Genres
- Composers
- Audiobooks

- i** Some categories contain the entry All. When you select this entry, the category is played completely.

#### USB storage media

With USB storage media you can select folders and, if available, playlists. When playing playlists, the audio system can display the respective album name and artist, e.g. meta data, if such information has been read into the system.

Playlists are displayed using a particular symbol. When you open a playlist, the contained tracks are opened and playback begins. The available playback option is now Random Categories instead of Random Folder.

You can determine whether the meta data or the file name and folder are to be displayed during playback for USB storage media.

- **Displaying artist name:** Select Media Inter → Display Metadata.

### Selecting category and opening folder

- **Opening category/folder:** Press button  when the main area is selected.

or

- Select Music.

The available categories or folder content, e.g. subfolders, are displayed. The status line displays the selected category or folder name.

- i** To select Music, the external device must be activated.

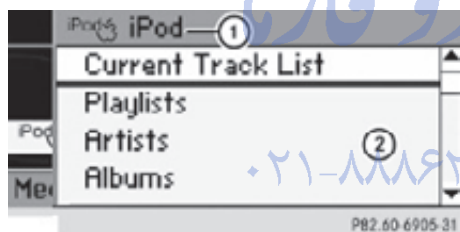

- ① Device name and symbol
- ② Available categories

- **Selecting category, folder, album:** Press button  or  and confirm selection by pressing button .

The content of the category or folder is displayed.

- i** If the data has not been read-in completely, the message Please Wait... appears.
- If necessary repeat the above step until the tracks of the selected category, folder, or album appear.

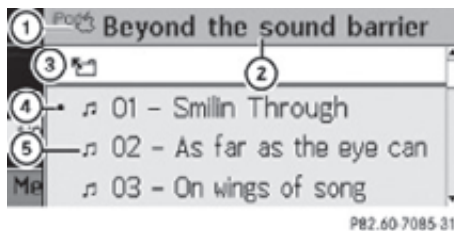

- ① Symbol of the connected medium
- ② Name of current album, folder or category
- ③ Symbol for superordinate folder
- ④ Current track (not available for all devices)
- ⑤ Track symbol

- **Playback track:** Press button  or  and confirm selection by pressing button .

- **Moving to superordinate folder:** Press button  or  until  is selected and press button .

### Playing category or folder content

- Select category or folder.
- Press button  for more than 2 seconds. The category or folder content is played according to the selected playback option (► page 145).

### Alphabetical track selection

#### iPods® and selected MP3 players

- i** This function is only available for alphabetically ordered categories. It is not available for albums or playlists for example.
  - Select a category, for example Artists. The available artists are displayed.
  - Press the respective keypad button once or multiple times to enter the initial letter of the desired artist name. The available initial letters are displayed.
  - Press button .
- While the data is being read, the message Please Wait... appears. Once the data

has been read-in completely, the first list entry with the entered initial letter is highlighted.

- ❗ If no match is found, the last entry that matches a previous initial letter is highlighted.

The quality of the search results depends on the version and the language of the software, e.g. iTunes™ used to store data on the iPod® or MP3 player.

### USB storage media

- ❗ This function is only available for alphabetically ordered files. It is not available for playlists.
- ▶ Press the respective keypad button once or multiple times to enter the initial letter of the desired artist name. The available initial letters are displayed. If the file system contains folders only, the system searches for folders and the message *Please Wait...* appears. Once the search is concluded, the first list entry with the entered initial letter is highlighted. If this is not the case, the system searches for tracks. The message *Please Wait...* appears. Once the search is concluded, the first list entry with the entered initial letter is highlighted.

### Select active partition

USB storage media may contain up to 4 partitions (primary or logical; formatted to FAT16 or FAT32).

- ▶ **Selecting partition:**  → Media Inter → Select Active Partition.

### Playback options

The following options are available:

- Normal Track Sequence  
Tracks are played in standard order (e.g. numerical or alphabetical order).
- Random Tracks

Tracks are played in random order.

- Random Categories or Random Folder (when folder was selected on USB storage medium)  
Tracks of the current category or of the current folder are played in random order.

### Audio AUX mode

- ❗ This section applies to vehicles without media interface only.

An external audio source can be connected to the AUX socket of the audio system. Please contact an authorized Mercedes-Benz Center for more information.



AUX socket ① is designed for a 3.5 mm stereo jack (3-pin), for devices with dedicated analog audio output or connection via headphone port, e.g. MP3 or tape player.

### ⚠ Warning!

Operating an external audio source while the vehicle is in motion will distract you. You may not notice changing road and/or traffic conditions which may cause an accident.

Bear in mind that at a speed of just 30 mph (approximately 50 km/h), your vehicle is covering a distance of 44 feet (approximately 14 m) every second.

For your safety and the safety of others, pull over to a safe location and stop before operating an external audio source.

### Calling up AUX mode

#### Warning!

Due to the different volumes of the external audio sources, system messages of the vehicle may be much louder. You may need to disable these system messages or adjust the volume of these messages manually.

#### ► Selecting audio AUX mode:

Press button **[DISC]** repeatedly until the main menu for AUX operation appears.

or

► In CD mode: Select CD/MP3 → Aux.

The audio AUX menu appears. The medium in the external audio source is heard, provided it is connected and switched to playback.

- i** Please refer to the relevant operating guide for operation of the external audio source.

The following settings can be made in the audio AUX mode:

- Volume (▷ page 117)
- Balance control (▷ page 118)
- Bass and treble control (▷ page 118)
- Surround sound (▷ page 119)

- i** The volume of external audio sources is extremely variable. It is possible that a device connected as an external audio source will sound quieter or louder in the vehicle or that the usual maximum volume cannot be achieved. On certain devices the volume can be set separately. In this case, start at a moderate volume and increase it slowly. In this way, you can determine whether the system is capable of playback without distortion, even at high volume.

#### Volume adjustment for the audio device

You can increase the volume for the AUX socket in case the internal volume of the connected audio device is too low. Use the setting **Boost** for such devices.

You should set the system back to **Standard** before connecting a different audio device to the AUX socket.

- Select **Volume** in AUX mode.  
The selection list appears. The dot • indicates the currently selected setting.

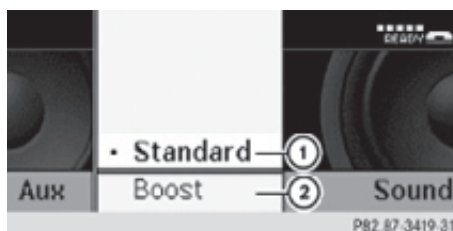

- ① Default setting
- ② Volume boost

### Switch back to CD mode

► Press button **[DISC]**.

or

► Select **Back To Disc** in the audio AUX menu.

### Telephone

#### Safety precautions

##### Warning!

Please do not forget that your primary responsibility is to drive the vehicle. A driver's attention to the road must always be his/her primary focus when driving. For your safety and the safety of others, we recommend that you pull over to a safe location and stop before placing or taking a telephone call.



If you choose to use the mobile phone<sup>8</sup> while driving, please use the hands-free device and only use the mobile phone when road, weather and traffic conditions permit. Some jurisdictions prohibit the driver from using a mobile phone while driving a vehicle.

<sup>8</sup> Observe all legal requirements.

Bear in mind that at a speed of just 30 mph (approximately 50 km/h), your vehicle is covering a distance of 44 feet (approximately 14 m) every second.

- i** The functions and services available to you while using the mobile phone depend on your service provider and the type of mobile phone you are using. Also see separate operating manual of your mobile phone for instructions on how to use your mobile phone.

When the mobile phone is connected via the Bluetooth® interface to the audio system, you can operate the mobile phone using the following devices:

- Audio control unit (▷ page 156)
- Buttons  and  on the multifunction steering wheel (▷ page 94)
- Mobile phone keypad or similar input device

Please note that these functions are only available with Mercedes-Benz approved mobile phones.

### TEL Menu

Menu	Function
<b>Telephone</b>	Bluetooth® phones
	Download contacts
	Delete contacts
	Adjust volume
<b>Name</b>	Phone book
<b>Call lists</b> <b>Microphone off/on</b>	Call Lists or Mic On/ Mic Off
	Delete Call Lists

### General notes

#### Making calls via Bluetooth® interface

The audio system telephone function via the Bluetooth® interface is available in conjunction with a Bluetooth® enabled mobile phone.

With a suitable mobile phone, you can use the hands-free device and receive electronic business cards (vCards) via the Bluetooth® interface.

#### Calls disconnected while the vehicle is in motion



Interruptions to the connection may occur if

- there is insufficient mobile network coverage
- you move from one mobile network transmitter/receiver area (mobile network cell) into another and no channels are free or the cell is full
- you are using a SIM card that is not compatible with the available network
- when using a mobile phone with “Twincard”, the mobile phone is simultaneously logged into the network with the second SIM card

#### Operating options

- i** The components and operating principles of the audio system can be found on (▷ page 112) and (▷ page 116).

When the mobile phone is connected via the Bluetooth® interface to the audio system, you can operate the mobile phone using the following devices:

- Buttons  and  and keypad on audio control unit (▷ page 113)
- Multifunction steering wheel (▷ page 94)

Please note that these functions are only available with Mercedes-Benz approved mobile phones. Please contact an authorized Mercedes-Benz Center for information on

features available for your mobile phone of choice.

**i** In order for the functions described in this section to work correctly, the Bluetooth® telephone must be linked to the audio system. Please make sure any other Bluetooth® device linked with the mobile phone is switched off before you use the telephone functions with the audio system.

Changes or modifications not expressly approved by the party responsible for compliance could void the user's authority to operate the equipment.

The head unit internal Bluetooth® transmitter must not be co-located or operated in conjunction with any other antenna or transmitter.

This equipment complies with FCC/IC radiation exposure limits set forth for uncontrolled equipment and meets the FCC radio frequency (RF) Exposure Guidelines in Supplement C to OET65 and RSS-102 of the IC radio frequency (RF) Exposure rules. This equipment has very low levels of RF energy that it is deemed to comply without testing of specific absorption ratio (SAR).

Unless otherwise indicated, the descriptions and illustrations in this section refer to the audio system.

### Caller ID

The audio system can display the telephone number and the name of the caller, e.g. for an incoming call and also in other menus or displays.

For the telephone number to be displayed, the caller must transmit their telephone number. Otherwise Unknown will be shown on the audio display.

This is also the case for name displays. For this, the telephone number and the name of the caller must also be saved in the telephone book.

### Functional restrictions

You will not be able to use the mobile phone, or you may have to wait a while, in the following situations:

- If the mobile phone is switched off.
- If the mobile phone is not connected via the Bluetooth® interface to the audio system.
- If the mobile phone is locked.
- If the mobile phone has not yet acquired a network signal.

The mobile phone automatically tries to log into a network. If no network is available, you will also not be able to make a "911" emergency call. If you attempt to make an outgoing call, the No Service message will appear for a short while.

- If you switch off the audio system in the middle of a call, e.g. by switching off the ignition, that call will be cut off. You can prevent this from happening as follows:
  - Switch the mobile phone to "private mode" before switching the audio system off (see mobile phone operating instructions).

### Activating the mobile phone

#### Prerequisites for the mobile phone

For making calls using the audio system via the Bluetooth® interface, you will need a Bluetooth® enabled mobile phone.

Your mobile phone must support the Bluetooth® hands-free profile 1.0 or higher to make or receive calls (see mobile phone operating instructions).

**i** For further information on suitable mobile phones and connecting Bluetooth®-enabled mobile phones to the audio system

- visit [www.mbusa-mobile.com](http://www.mbusa-mobile.com)
- call the Mercedes-Benz Customer Assistance Center at

1-800-FOR-MERCEdes  
(1-800-367-6372) (in the USA)

- call Customer Service at  
1-800-387-0100 (in Canada)

### Activating Bluetooth®

- ▶ Switch on the mobile phone (see mobile phone operating instructions).
- ▶ Enter the PIN (not necessary with some mobile phones or network).
- ▶ Activate Bluetooth® connection on the mobile phone (see mobile phone operating instructions).
- ▶ Press button **TEL** on the audio control unit to call up the telephone mode.

**i** On certain mobile phones, not only you will have to activate the Bluetooth® function but in addition, your own device must be made "visible" for other devices. Each Bluetooth® device has a Bluetooth® device name. It is recommended to give your mobile phone a personal name, by which you can clearly recognize your mobile phone.

**i** If the Bluetooth® function on the audio system is disabled, the message Bluetooth not activated in system settings appears.

- ▶ Activate Bluetooth® connection on the audio system (▷ page 120).
- ▶ **sys** → System Settings → Bluetooth → Activate Bluetooth. You have activated or deactivated Bluetooth®. A checkmark appears when Bluetooth® is activated.

### Registering a mobile phone (authorizing)

When you use your mobile phone in conjunction with the audio system for the first time, you must register (authorize) it.

It is possible to register up to 15 mobile phones. The connection is always established to the last activated mobile phones in signal range. When you authorize a new mobile phone, it is activated automatically. You can switch between the authorized mobile phones.

### Searching for a mobile phone

- ▶ **TEL** → Phone → Bluetooth Phones → Update.

The audio system searches for up to 10 suitable Bluetooth® telephones within range and enters them into the telephone list.

Authorized Bluetooth® telephones will be identified by a telephone-symbol  in front of the list entry once the telephone list has been updated. The symbol will be grayed out if the authorized mobile phone is not located within the Bluetooth® range.

**i** The duration of the search procedure depends on the number and type of Bluetooth® telephones. The search may take a few minutes.

**i** If the telephone list is already full (15 entries), you must de-authorize one of the authorized devices (▷ page 151), and start the search again. Otherwise a new device you are looking for will not appear in the list.

If the audio system does not find your mobile phone, external authorization may be necessary (▷ page 150).

### Authorizing a Bluetooth® device

- ▶ Select the desired unauthorized device from the telephone list by pressing the buttons **▲**, **▼** and **OK**.

or

- ▶ Select Options → Authorize. The input menu for the passcode appears.

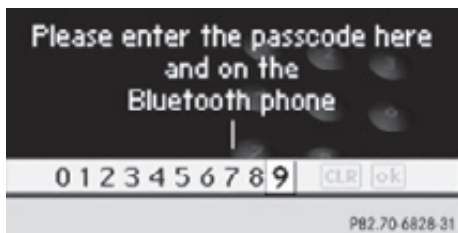

- i** The passcode is any one- to sixteen-digit number, which you can set yourself. For the quality of coding of the connection it is recommend to use a passcode of at least four digits. You must enter the same passcode into the audio system and the device to be authorized. Also refer to the operating instructions of the mobile phone.

On the audio system, you can enter the passcode via the digits in the on-screen menu bar or via the telephone keypad in the audio control unit.

#### With the menu bar:

- ▶ **Entering passcode:** Select the digits in the menu bar one by one, by pressing the buttons and .
- ▶ Press button to confirm each digit.
- ▶ **Confirming passcode:** Select in the menu bar and press button to confirm.
- ▶ **Deleting digits:** Select in the menu bar and briefly press button to delete one digit, or press and hold button to delete all entered digits.
- ▶ **Canceling entry:** Press button .

#### With keypad on audio control unit:

- ▶ **Entering passcode:** Press the desired numbers on the keypad.
- ▶ **Confirming passcode:** Press button .
- ▶ **Deleting digits:** Briefly press button in the audio control unit to delete one number, or press and hold button to delete all entered numbers.
- ▶ **Canceling entry:** Press button .

#### Entering passcode into the mobile phone

If a Bluetooth® connection is established successfully, you will be prompted to enter a code into the mobile phone (see mobile phone operating instructions).

- ▶ Enter the same passcode on the mobile phone as you did on the audio system.

- i** You may need to confirm the authorizing on the mobile phone. Check your mobile phone display.

If the message *Authorization Procedure Unsuccessful* appears on the audio system display, you may have exceeded the preset period for authorization. Repeat the process.

The device is authorized. You can now make calls via the audio system hands-free device using the authorized mobile phone.

#### External authorization

If the audio system cannot find your mobile phone, this may be due to special security settings on your mobile phone. In this case, you can check whether, conversely, your mobile phone can find the audio system. The audio system's Bluetooth® device name is "MB Bluetooth".

- ▶ → Phone → Bluetooth Phones → Update → Options → External Authorization.

or

- ▶ → System Settings → Bluetooth → Bluetooth device list → Update → Options → External Authorization.

The message *Ready for External Authorization* appears.



- ▶ Start Bluetooth® search procedure on the mobile phone (see mobile phone operating instructions).
- ▶ Select the audio system (“MB Bluetooth”) at your mobile phone.
- ▶ When prompted to do so, enter the passcode on the mobile phone and then on the audio system.

### Displaying details on a mobile phone

- ▶ **[TEL]** → Phone → Bluetooth Phones.
- ▶ Select the mobile phone from the list.
- ▶ Select Options → Details.  
The details screen for the device is shown in the audio display.
- ▶ **Closing details screen:** Press button **[▶]**, **[◀]** or **[OK]**.

### De-authorizing a Bluetooth® device

- ▶ **[TEL]** → Phone → Bluetooth Phones.
- ▶ Select authorized device.
- ▶ Select Options → De-Authorize.  
A prompt appears asking whether you really want to de-authorize this device.
- ▶ Select Yes or No.  
If you select Yes, the device will be de-authorized.

- i** If you de-authorize a device which has been authorized in the past and which is not detected in the search, this device will no longer be displayed in the device list.  
Devices which have been authorized in the past but which are not detected in the search are either not switched on or not in the vehicle.

### Activating another mobile phone

If you have several authorized mobile phones, you can switch between the individual mobile phones.

- i** You cannot switch to another authorized mobile phone during a call.

When you authorize a new mobile phone, it is automatically activated. Only one mobile phone can be active at a time.

- ▶ **[TEL]** → Phone → Bluetooth Phones.
- ▶ Select an authorized mobile phone from the list.
- ▶ Press button **[OK]** to confirm.  
The selected mobile phone will be searched for and connected if it is located in the Bluetooth® range and Bluetooth® is activated on the corresponding device.  
The selected mobile phone is activated.  
A dot • in front of the entry, indicates the current active mobile phone in the phone list.

### Receiving business cards

You can import business cards (vCards) into the address book from external Bluetooth® devices (▷ page 153).

### TEL-Basic display



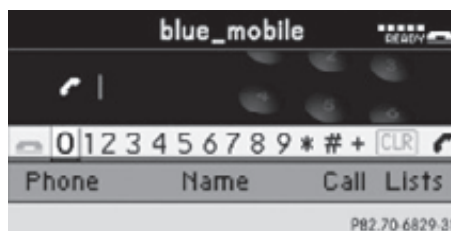

- ▶ Press button **[TEL]** on the audio control unit to call up the telephone mode.

- i** When in telephone mode, you can access the TEL-Basic display by pressing button **[BACK]** repeatedly.



When the connected mobile phone is ready for operation, the display will look similar like this:



The following information is displayed in the status bar:

- Bluetooth® device name of the connected mobile phone, in this case: blue\_mobile.
- Mobile phone network signal strength . This information will only be shown with suitable mobile phones. The bars indicate the current signal strength of the mobile phone network for reception. Optimum reception is indicated by all bars full. All bars empty indicates very poor or no reception.
- Receiver symbol  or . The receiver symbol indicates whether a call is being connected or is in progress:  - not active
- READY indicates that a call is possible.
- NO SERVICE indicates that the mobile network is not available.

### Setting transmit and receive volume

- **i** These settings should normally not be changed as the factory settings are matched to most mobile phones. Find out about the optimum settings for your mobile phone at an authorized Mercedes-Benz Center.
  - **i** Changes may result in significant impairments to the transmission quality. These settings may not be changed during an active phone call.
- **[TEL]** → Phone → Adjust Volume → Reception Volume or Transmission Volume.
- **Setting the volume:** Press button  or . The volume bar moves up or down.
- **Confirming selection:** Press button .

### Emergency calls “911”

- **i** The “911” emergency call system is a public service. Using it without due cause is a criminal offense.
- **i** This function places a call to the local “911” provider. It does not initiate a Tele Aid call.

The following describes how to dial a “911” emergency call using the audio system head unit when a Mercedes-Benz specified mobile phone is connected via the Bluetooth® interface to the audio system. Unless otherwise specified, the descriptions refer to the audio system head unit.

Consult the separate mobile phone operating instructions that came with your mobile phone for information on how to place a “911” emergency call on the mobile phone. The following conditions must be met for a “911” emergency call via the audio system:

- Mobile phone must be switched on.
- The corresponding mobile communications network must be available.
- **i** Emergency calls may not be possible with all telephone networks or if certain network services and/or telephone functions are active. Check with your local service providers and mobile phone instructions.

If you cannot make an emergency call, you will have to initiate rescue measures yourself.

### Placing a “911” emergency call using audio control unit with the mobile phone unlocked

- Press button **[TEL]** to switch to telephone mode.
- Enter 911 using the number keypad on the audio control unit.

- ▶ Press button . Connecting... appears in the audio display while the mobile phone establishes the connection.
- ▶ Wait until the emergency call center answers, then describe the emergency.
- i** Depending on the phone type, if no SIM card is inserted in a GSM mobile phone or if there is no service on a CDMA mobile phone, NO SERVICE may appear in the audio display. In that case, you only can make an emergency call on the mobile phone itself, without the use of the audio control unit.

### Placing a "911" emergency call with the mobile phone locked

- i** If the mobile phone is locked, you only can make an emergency call on the mobile phone itself, without the use of the audio control unit.

### Phone book

You can save telephone numbers in the audio system's phone book.







- i** These entries are retained even if you use the audio system with another mobile phone. You should delete these entries before handing over or selling your vehicle.

### Receiving business cards (vCards)

You can import business cards (vCards) from external Bluetooth® phones into your audio system's phone book. To do this:

- Bluetooth® must be activated on the audio system and on the external Bluetooth® phone (see the operating instructions of the mobile phone).
- The external Bluetooth® phone must be able to send vCards via Bluetooth® (see the

operating instructions of the mobile phone).

- The external Bluetooth® phone in the vehicle must be switched on and authorized.
- i** If you switch to a different mode while vCards are being received (e.g., press button ), reception of vCards will be aborted.
- ▶  → Phone → Download Contacts.
- ▶ Press button  to confirm.
- ▶ **Importing:** Start the data transfer on the external Bluetooth® phone ("Export business cards (vCards)", see the operating instructions of the mobile phone). The audio system imports the data for the business cards and displays the number of business cards received.
- i** Select Back, press button  or switch to a different mode to abort reception.
- ▶ **Aborting reception:** Press .
- OR تلفن شبانه روزی: ۰۲۱-۸۸۶۲۰۸۵
- ▶ Press button .

### Deleting external Data

- ▶  → Phone → Delete Contacts. A prompt appears asking whether the data should be deleted.
- ▶ Select Yes or No. If you select Yes all personal data are then deleted from the phone book.



### Opening the phone book

- ▶  → Name. Entries in the phone book are displayed in alphabetical order. The search speller is active when more multiple entries are available. The search speller appears on the lower edge of the display.

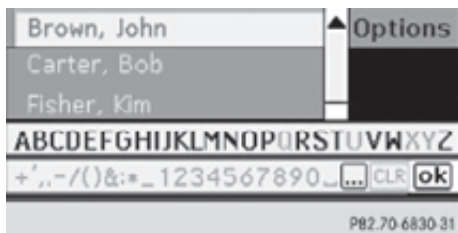
You can use the search speller to reduce the number of entries you need to make.







Symbol  indicates that an entry contains more than one phone number. You can select these subentries (> page 155).

- ▶ **Closing phone book:** Press button .
- ▶ **Switching from the search speller to the list:** Press button  repeatedly.
- ▶ **Switching from the list to the search speller:** Press button .

## Selecting an entry

### Selecting via search speller

- ▶ If necessary, switch from the list to the search speller.
- ▶ **Switching search speller character set:** Select . Depending on the previous setting, this switches the search speller to letters with special characters or numbers with special characters.
- ▶ **Entering characters:** Press button  or  to select the characters for the required entry. The first letters you enter determine the first letters of the name you are looking for.
- ▶ Press button  to confirm. The first entry containing the selected initial letters is highlighted in the list. If there are a number of similar entries, the next different character is displayed.

### Example:

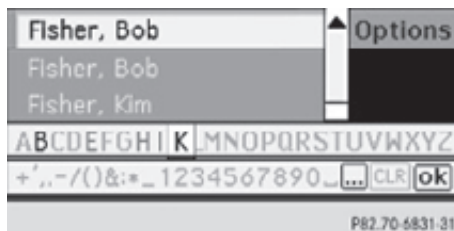

In the example, the first letters of the names Fisher, Bob and Fisher, Kim are the same. The first possible distinct letter is the B or the K.



Therefore, B and K are offered as possibilities.

- ▶ Select the characters for the required entry one after another. As soon as the selection has been narrowed down to a single entry, the audio system will switch to the list automatically.

- ▶ **Deleting an individual character:** Select  and briefly press .

or

- ▶ Press button . After entering each character or after each deletion of a character, the closest matching entry is given at the top of the list.

- ▶ **Deleting an entire entry:** Select  and press and hold  until the entire entry has been deleted.

or

- ▶ Press and hold button  until the entire entry has been deleted.

- ▶ **Ending search:** Switch from the search speller to the list. The top list entry is highlighted automatically.

### Selecting via list

- ▶ If necessary, switch from the search speller to the list.

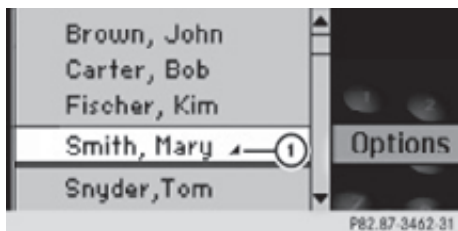

Phone book list

Entries with symbol ① have additional options available, e.g. more phone numbers.

- ▶ Press button ▲ or ▼ until the desired entry is highlighted.
- ▶ Press Ⓚ to confirm and a call will be initiated.

### Selecting subentries

- ▶ Select an entry with the symbol ① from the list and press button Ⓚ.  
Symbol ① changes to ▼ and the subentries appear.

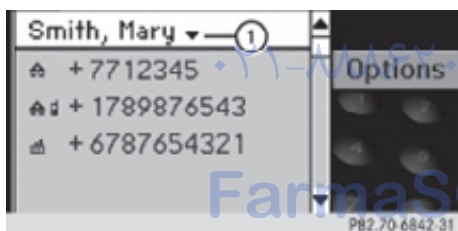

① Phone book entry with subentries

- ▶ Press button ▲ or ▼ until the desired subentry is highlighted.
- ▶ Press button Ⓚ to confirm and a call will be initiated.

Depending on the mobile phone and the entries in the mobile phone book, the phone numbers are assigned to categories. The categories are indicated by category symbols.

Number category	Display
Not classified	☎
Home	🏠
Work	🏢

Phone category	Display
Not classified	☎
Mobile	📱
Car	🚗
Pager	📠

### Displaying details on an entry

The audio system can also fully display an abbreviated entry.

- ▶ Select entry.
- ▶ Select Options → Details.

A screen with the details of the selected entry appears.

- ▶ **Closing details screen:** Press button ◀ or ▶ until the desired entry is highlighted.

### Deleting entry

- ▶ Select entry.
- ▶ Select Options → Delete.  
You will be prompted to confirm that you really want to delete the entry.
- ▶ Select Yes or No.  
If you select Yes the actual entry is deleted from the phone book.

### Call lists

The audio system displays the calls received (including missed calls) or made during phone mode in their own lists.

- i** The particular menu item can only be selected if calls have already been received or made from audio system.

Displaying missed calls in the audio system display is not possible with all mobile phones.

The control system displays the list of dialed numbers in the multifunction display.

- i** The audio system's call lists are not synchronized with the call lists on your mobile phone. If you make a call from your mobile phone and only use the audio system's hands-free device, these calls will not be listed.

### Calling up the list

- ▶ **TEL** → Call Lists.
- ▶ Select Calls Received or Calls Dialed.  
The appropriate list appears.

- i** If there is a symbol with a telephone receiver in front of the phone number or the name, then you have missed this call (e.g. in the highlighted line of the following figure).

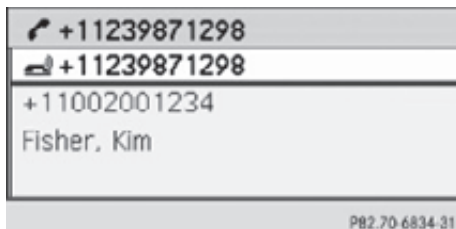

- ▶ Press button or until the desired entry is highlighted.
- ▶ **Initiating call:** Press button or .
- ▶ **To close the lists:** Press button .

### Deleting call lists

- i** The saved call lists are retained in the audio system, even if you use the audio system with another mobile phone. For this reason you should delete any call lists before handing over or selling the vehicle.

- ▶ In the phone main menu select Call Lists.
- ▶ Select Delete Call Lists.  
You will be prompted to confirm that you really want to delete the entry. The question Do you want to delete the call lists appears in the display.
- ▶ Select Yes or No.
- ▶ Press button to confirm.  
If you select Yes both lists are deleted.

### Making calls

- ▶ Press button **TEL** on the audio control unit to call up the telephone mode.

When the mobile phone is ready for operation, the display will look similar like this:







### Initiating an outgoing call

#### Entering phone number via the audio control unit

You can enter numbers and special characters via the telephone keypad.

- ▶ **Entering:** Use to , and to enter characters.  
You can enter the \* character by pressing button once. You can enter the +

character by pressing button  once and then again within approx. 1.5 seconds.

- ▶ **Initiating a call:** Press button .
- ▶ **Deleting individual digits:** Briefly press button  in the audio control unit.
- ▶ **Deleting an entire entry:** Press and hold button  until the entire entry has been deleted.

or





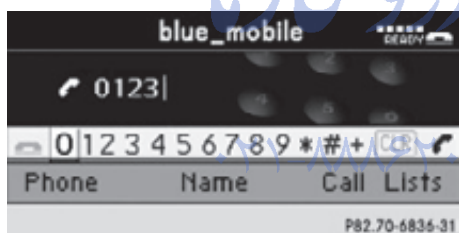

- ▶ Press button .

### Entering phone number via the telephone main menu

In addition to the actual menu bar, the telephone main menu features a second bar containing numbers, the number menu.

When the bar is active (highlighted), you can select elements.



- ▶ **Entering digits:** Press button  or  to select the required digit.
- ▶ Press  to confirm.
- ▶ Repeat the procedure until you have select all digits for the necessary phone number.
- ▶ **Deleting individual digits:** Press button  or  to select  and briefly press .



or

- ▶ Press button .
- ▶ **Deleting entire phone number:** Press button  or  to select , press

and hold  until the phone number has been deleted.

or

- ▶ Press and hold button  until the entire entry has been deleted.



- ▶ **Initiating a call:** Press button  or  to select .

- ▶ Press  to confirm.



or

- ▶ Press button .

### Initiating a call to a phone book entry

- ▶  → Name.
- ▶ Select entry (▷ page 154).
- ▶ Press button  or .

### Initiating a call to a call list entry

- ▶  → Call Lists.
- ▶ Select Calls Received or Calls Dialed.  
The appropriate list appears.
- ▶ Select entry (▷ page 156).
- ▶ Press button  or .



### Redialing







-  In order to use the redial function, no numbers may have been entered.





- ▶ Press button .

or

- ▶ Select  and press button .
- The dialed calls list appears. The call dialed last will be at the top of the list.

- ▶ **Selecting a call:** Press button  or  until the desired entry is highlighted.
- ▶ **Initiating call:** Press button  or .

### Aborting dial or ending a call

- ▶  →  and press button .
- or
- ▶ Press button  on the audio control unit or on the multifunction steering wheel.

### Rejecting or accepting calls

You will be notified of an incoming call by the ringing tone and a message on the display.

- ❗ Depending on the mobile phone you are using, the audio system's ringing tone may differ from the one you have set on your mobile phone. You may hear
  - the ringing tone set on the mobile phone
  - the audio system's preset ringing tone
  - the audio system's preset ringing tone and the ringing tone set on the mobile phone

If the caller's name and number are among the entries in the audio system's phone book and the caller has not withheld this information, it will appear on the display. If the caller withholds this information, you will see:

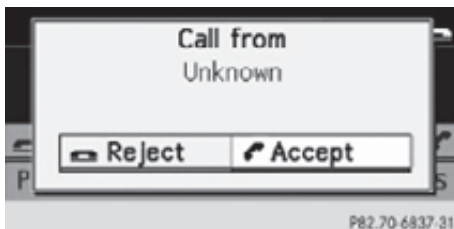



- ▶ **Accepting:** Press button  on audio control unit or on the multifunction steering wheel.

or

- ▶ Press button .

- ▶ **Rejecting:** Press button  on audio control unit.

or

- ▶ Press button  to select Reject, and press button  to confirm. The call is rejected.

If you have accepted the call using the audio control unit or the multifunction steering wheel, the call will be conducted via the hands-free system. The volume of the call can be adjusted (> page 117).

Further operating functions can be found in the "Functions during a single-call" section (> page 158).

You can also accept a call if the audio display is showing a screen other than the telephone mode screen. After accepting the call, the display switches to the phone display. Once the call is over, the display for the previous mode will appear again.

### Functions during a single call

#### Switching hands-free microphone on or off

The menu bar changes when you make or receive a call. Instead of the Call Lists menu item, Mic Off or Mic On will appear.

- ▶ **Switching off:** Select Mic Off.

The following message will flash up on the display: The microphone is off.

When the microphone is switched off the symbol  appears in the main area.

- ▶ **Switching on:** Select Mic On.

The following message will flash up on the display: The microphone is on.

The microphone is switched on and the symbol  disappears in the main area.



- i** You can also switch the microphone on or off by pressing button .

### Sending DTMF tones

- i** This function is not possible with all mobile phones.

Answering machines or other devices can be controlled via DTMF tones, e.g. for remote query functions.

▶ **Transmitting individual characters:**

During a call select the required characters.

or

- ▶ Press the corresponding button on the audio control unit.

Every selected character is transmitted immediately.

▶ **Transmitting a phone number of a phone book entry as a sequence of characters:** Select Name.

- ▶ Select the desired phone book entry. The entry is transmitted immediately as a sequence of characters.

- ▶ **Switching back to call display:** Select Back.

The currently set speed or last set speed (“Resume” function) appears in the status indicator of the multifunction display:

- USA only: e.g. CRUISE 55 Miles
- Canada only: e.g.  90 Km/h

#### **Warning!**

The cruise control is a convenience system designed to assist the driver during vehicle operation. The driver is and must always remain responsible for the vehicle’s speed and for safe brake operation.

Only use the cruise control if the road, traffic, and weather conditions make it advisable to travel at a constant speed.

- The use of the cruise control can be dangerous on winding roads or in heavy traffic because conditions do not allow safe driving at a constant speed.
- The use of the cruise control can be dangerous on slippery roads. Rapid changes in tire traction can result in wheel spin and loss of control.
- Deactivate the cruise control when driving in fog.

The “Resume” function should only be operated if the driver is fully aware of the previously set speed and wishes to resume this particular preset speed.

#### **Warning!**

When the cruise control is braking, the brake pedal is retracted (i.e. depressed automatically). The pedals’ range of motion must not be impeded by any obstacles:

- Do not place any objects in the footwell.
- Make sure that the floor mats and carpets are securely in place.
- Do not rest your foot underneath the brake pedal, as it could otherwise be trapped.

You could otherwise cause an accident and injure yourself and/or others.

## Driving systems

### Introduction

The cruise control driving system is described on the following pages.

The driving safety systems ABS, BAS and ESP® are described in the “Safety and security” section (> page 47).

### Cruise control

The cruise control maintains the speed you set for your vehicle automatically.

The use of the cruise control is recommended for driving at a constant speed for extended periods of time.



- ① Setting current or higher speed
- ② Setting current or lower speed
- ③ Canceling the cruise control
- ④ Resume to last set speed

### Activating cruise control

You can activate the cruise control at a vehicle speed above 20 mph (30 km/h).

You cannot activate the cruise control

- when you brake
- when you have engaged the parking brake
- when the automatic transmission is in park position **P**, reverse gear **R**, or neutral position **N**
- the ESP® is switched off or has switched off due to a malfunction

### Setting current speed

- ▶ Accelerate or decelerate to the desired speed.
- ▶ Briefly lift the cruise control lever in direction of arrow ① or press in direction of arrow ②.
- ▶ Remove your foot from the accelerator pedal.

**i** On uphill grades, the cruise control may not be able to maintain the set speed. Once the grade eases, the set speed will be resumed.

On downhill grades, the cruise control maintains the set speed by braking with the vehicle's brake system.

Vehicles with automatic transmission: In addition, on longer downhill grades the automatic transmission will downshift automatically.

- i** Vehicles with manual transmission: If you depress the clutch pedal when shifting into another gear, the engine speed may increase.
- Always drive with sufficient, but not excessive, engine speed.
  - Shift the gear in a timely manner.
  - Avoid shifting down more than one gear if at all possible.

### Canceling cruise control

- ▶ Depress the brake pedal.

or

- ▶ Briefly push the cruise control lever in direction of arrow ③.

The last set speed is stored for later use.

The last stored speed is deleted from memory when the engine is turned off.

The cruise control switches off automatically when

- you depress the brake pedal
- you engage the parking brake
- the vehicle speed falls below 20 mph (30 km/h)
- the ESP® is in operation
- the ESP® is switched off with the ESP® switch
- the ESP® has switched off due to a malfunction
- Vehicles with manual transmission: you engage neutral or depress the clutch pedal for more than 7 seconds during shifting into another gear

- Vehicles with manual transmission: you engage a gear too high for the current speed and thus the engine speed is too low
- Vehicles with automatic transmission: you shift the automatic transmission into neutral position **N** while driving

Depressing the accelerator pedal does not deactivate the cruise control. After a brief acceleration (e.g. for passing), the cruise control will resume the last set speed.

### Changing the set speed

#### **Warning!**

Keep in mind that it may take a brief moment until the vehicle has made the necessary adjustments.

Increase or decrease the set vehicle speed to a value that the prevailing road conditions and legal speed limits permit. Otherwise, sudden and unexpected acceleration or deceleration of the vehicle could cause an accident and/or serious injury to you and others.

When you use the cruise control lever to decelerate, the brake system will brake the vehicle automatically if the engine's braking power does not brake the vehicle sufficiently.

- ▶ **Increasing:** Lift the cruise control lever in direction of arrow ① and hold it up until the desired speed is reached.
- ▶ **Decreasing:** Press the cruise control lever in direction of arrow ② and hold it down until the desired speed is reached.
- ▶ Release the cruise control lever. The new speed is set and the vehicle will accelerate or decelerate.

### Fine adjustment in 1 mph (Canada: 1 km/h) increments

- ▶ **Increasing:** Briefly tip the cruise control lever in direction of arrow ①.
- ▶ **Decreasing:** Briefly tip the cruise control lever in direction of arrow ②.

### Setting stored speed (Resume function)

#### **Warning!**

The set speed stored in memory should only be set again if prevailing road conditions and legal speed limits permit. Possible acceleration or deceleration differences arising from returning to the preset speed could cause an accident and/or serious injury to you and others.

- ▶ Briefly pull the cruise control lever in direction of arrow ④.
- ▶ Remove your foot from the accelerator pedal.

The last stored speed is deleted from memory when the engine is turned off.

Climate control system

Overview of climate control system functions

Your vehicle is equipped with either of the following climate control systems:

Climate control (▷ page 162)

Automatic climate control (▷ page 163)



P83.30-4643-31



P83.40-4262-31

The climate control combines a heating and ventilation system with a cooling system.

The automatic climate control combines an automatic heating and ventilation system with a cooling system. You can adjust the automatic climate control separately for the driver's and passenger side.

Controls in detail

Control panels

Climate control

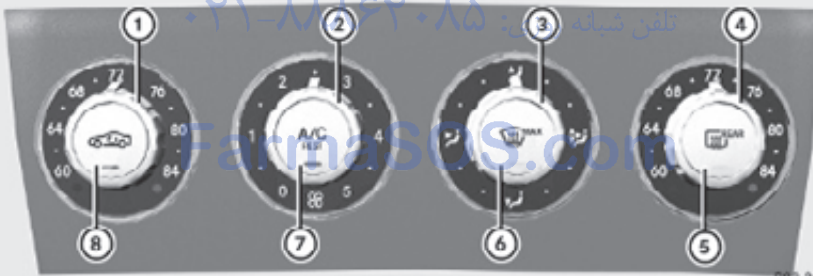

P83.30-4644-31

Function	Recommendation/Notes	
① Temperature control, driver's side	<b>i</b> Set the temperature to 72°F (22°C).	(▷ page 166)
② Air volume control		(▷ page 168)
Climate control on/off	<b>i</b> Switch on/off the climate control system.	(▷ page 165)
③ Air distribution control		(▷ page 168)

Function	Recommendation/Notes	
④ Temperature control, passenger side	<b>i</b> Set the temperature to 72°F (22°C).	(▷ page 166)
⑤ Rear window defroster		(▷ page 170)
⑥ Front defroster	<b>i</b> Keep this setting selected only until the windshield or the side windows are clear again.	(▷ page 168)
⑦ AC cooling on/off	<b>i</b> Switch on/off the air conditioning.	(▷ page 165)
Residual heat/ventilation	<b>i</b> With the engine turned off, it is possible to continue to heat or ventilate the interior.	(▷ page 169)
⑧ Air recirculation	<b>i</b> Only use this function for a short time, e.g. in a tunnel. Otherwise, the windows can fog up due to lack of fresh air.	(▷ page 169)

### Automatic climate control

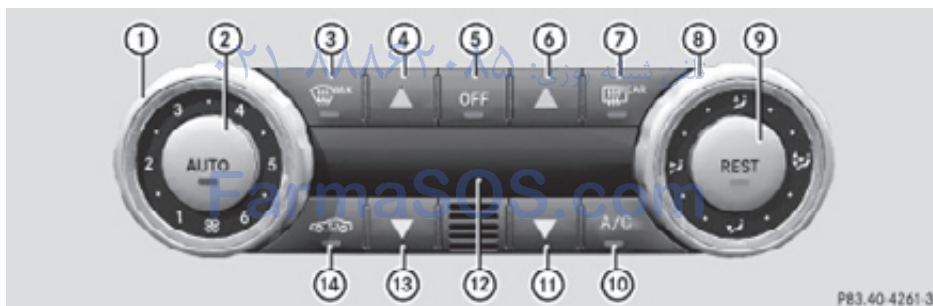

Function	Recommendation/Notes	
① Air volume		(▷ page 168)
② Air distribution and air volume (automatic mode)	<b>i</b> Switch on the automatic mode. The indicator lamp in button <b>AUTO</b> comes on.	(▷ page 166)
③ Front defroster	<b>i</b> Keep this setting selected only until the windshield or the side windows are clear again.	(▷ page 168)
④ Temperature control, driver's side, raising	<b>i</b> Set the temperature to 72°F (22°C).	(▷ page 166)

	Function	Recommendation/Notes	
⑤	Climate control on/off	<b>i</b> Switch on/off the climate control system.	(▷ page 165)
⑥	Temperature control, passenger side, raising	<b>i</b> Set the temperature to 72°F (22°C).	(▷ page 166)
⑦	Rear window defroster		(▷ page 170)
⑧	Air distribution		(▷ page 168)
⑨	Residual heat/ventilation	<b>i</b> With the engine turned off, it is possible to continue to heat or ventilate the interior.	(▷ page 169)
⑩	AC cooling on/off	<b>i</b> Switch on/off the air conditioning.	(▷ page 165)
⑪	Temperature control, passenger side, lowering	<b>i</b> Set the temperature to 72°F (22°C).	(▷ page 166)
⑫	Display		
⑬	Temperature control, driver's side, lowering	<b>i</b> Set the temperature to 72°F (22°C).	(▷ page 166)
⑭	Air recirculation	<b>i</b> Only use this function for a short time, e.g. in a tunnel. Otherwise, the windows can fog up due to lack of fresh air.	(▷ page 169)

### Notes on climate control system

The climate control system is operational whenever the engine is running. You can operate the climate control system in either the automatic<sup>9</sup> or manual mode. The system cools or heats the interior depending on the selected interior temperature.

It can only function optimally when you are driving with the windows and the retractable hardtop closed.

Nearly all dust particles, pollutants and odors are filtered out before outside air enters the

passenger compartment through the air distribution system.

### **Warning!**

Severe conditions (e.g. strong air pollution) may require replacement of the filter before its scheduled replacement interval. A clogged filter will reduce the air volume to the interior and the windows could fog up, impairing visibility and endangering you and others. Have a clogged filter replaced as soon as possible at an authorized Mercedes-Benz Center.

<sup>9</sup> Vehicles with automatic climate control

The air conditioning will not engage (no cooling) if the **A/C** mode (▷ page 165) is deactivated.

#### **Warning!**

Follow the recommended settings for heating and cooling given on the following pages. Otherwise the windows could fog up, impairing visibility and endangering you and others.

- ▶ Keep the air intake grille in front of the windshield free of snow and debris.

When the retractable hardtop is closed, do not obstruct air flow by placing objects on the air flow-through exhaust slots below the rear window.



- i** If the vehicle interior is hot, ventilate the interior before driving off. The climate control will then adjust the interior temperature to the set value much faster.

#### **Deactivating the climate control system**



#### **Warning!**

When the climate control system is deactivated, the outside air supply and circulation are also deactivated. Only choose this setting for a short time when the retractable hardtop is closed. Otherwise the windows could fog up, impairing visibility and endangering you and others.

#### **Climate control**

- ▶ **Deactivating:** Set air volume control  (▷ page 162) to position **0**.
- ▶ **Reactivating:** Set air volume control  to any speed.  
The previous settings are once again in effect.

#### **Automatic climate control**

- ▶ **Deactivating:** Press button .  
The indicator lamp in the button comes on.
  - ▶ **Reactivating:** Press button .  
The indicator lamp in the button goes out. The previous settings are once again in effect.
- or
- ▶ Press button .  
The indicator lamp in the button comes on. Air volume and air distribution are adjusted automatically.

#### **Air conditioning**

The air conditioning is operational while the engine is running and cools the interior air to the temperature set by the operator. In addition, the air conditioning dehumidifies the interior air and helps prevent window fogging.

#### **Warning!**



If you deactivate the air conditioning, the vehicle will not be cooled when weather conditions are warm. The windows can fog up more quickly. Window fogging may impair visibility and endanger you and others.

- i** Condensated water may drip out from underneath the vehicle. This is normal and not an indication of a malfunction.

The air conditioning uses the refrigerant R134a. This refrigerant is free of CFCs which are harmful to the ozone layer.

#### **Deactivating**

It is possible to deactivate the air conditioning. The interior air will then no longer be cooled or dehumidified.

- ▶ Press button <sup>10</sup> / <sup>11</sup>.  
The indicator lamp in the button goes out.



<sup>10</sup> Vehicles with climate control

<sup>11</sup> Vehicles with automatic climate control

The cooling function switches off after a short delay.

### Activating

Moist air can fog up the windows. You can dehumidify the interior air with the air conditioning.

- ▶ Press button <sup>10</sup> / <sup>11</sup>.  
The indicator lamp in the button comes on.

### Automatic mode



The automatic mode is available in vehicles with automatic climate control only.

When operating the climate control system in automatic mode, the interior air temperature, air volume and air distribution are adjusted automatically.

In automatic mode, cooling with dehumidification is switched on. This function can be switched off if necessary.

#### **Warning!**

If you deactivate the air conditioning, the vehicle will not be cooled when weather conditions are warm. The windows can fog up more quickly. Window fogging may impair visibility and endanger you and others.

- ▶ Set the desired temperature (▷ page 166).
- ▶ **Activating:** Press button . The indicator lamp in the button comes on. The air volume and air distribution are adjusted automatically.
- ▶ **Deactivating:** Press button  again. The indicator lamp in the button goes out. The air volume changes to level **2** and the air distribution changes to .



<sup>10</sup> Vehicles with climate control

<sup>11</sup> Vehicles with automatic climate control



### Setting the temperature

You can adjust the air temperature on each side of the passenger compartment. You should raise or lower the temperature setting in small increments, preferably starting at 72°F (22°C).

### Climate control

- ▶ **Increasing/decreasing:** Turn temperature control  and/or  (▷ page 162) slightly clockwise or counterclockwise.

### Automatic climate control

- ▶ **Increasing/decreasing:** Press button  or  until the desired temperature appears in display  (▷ page 163).

### Adjusting air vents

#### **Warning!**

When operating the climate control, the air that enters the passenger compartment through the air vents can be very hot or very cold (depending on the set temperature). This may cause burns or frostbite to unprotected skin in the immediate area of the air vents.

Always keep sufficient distance between unprotected parts of the body and the air vents. If necessary, use the air distribution adjustment to direct the air to air vents in the vehicle interior that are not in the immediate area of unprotected skin.

For best possible performance of the climate control:

- ▶ Keep the air intake grille in front of the windshield free of snow, leaves, sticks, and any other debris.
- ▶ Always keep all air vents and grilles in the passenger compartment free from obstruction.



- i** For draft-free ventilation, move the adjustable center and side air vents to the middle position.

### Center air vents

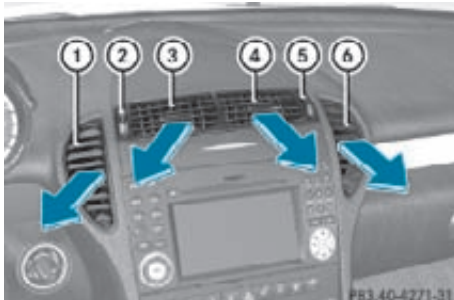

- ① Left center air vent, fixed
- ② Thumbwheel for air volume control for fixed/adjustable left center air vents
- ③ Left center air vent, adjustable
- ④ Right center air vent, adjustable
- ⑤ Thumbwheel for air volume control for fixed/adjustable right center air vents
- ⑥ Right center air vent, fixed

- ▶ **Opening the center air vents:** Turn thumbwheels ② and ⑤ upward to the first stop. Center air vents ①, ③, ④ and ⑥ are open.
- ▶ Turn thumbwheels ② and ⑤ upward all the way. Only center air vents ③ and ④ are open.
- ▶ **Closing the center air vents:** Turn thumbwheels ② and ⑤ downward all the way. Center air vents ①, ③, ④ and ⑥ are closed.

### Side air vents

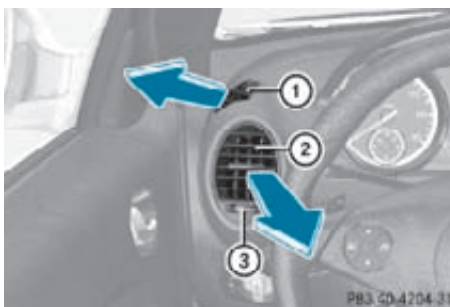

Example illustration driver's side

- ① Left side defroster air vent, fixed
- ② Left side air vent, adjustable
- ③ Thumbwheel for air volume control for adjustable left side air vent

- ▶ **Opening/closing:** Turn thumbwheel ③ in the required direction.

### AIRSCARF vent

#### **Warning!**

When switching on the AIRSCARF neck-level heating, the air streaming from the openings may be very hot. When in close proximity to the openings, you could be seriously burned. To help avoid serious personal injuries, switch the AIRSCARF to a lower heating level.







- ① AIRSCARF vent

You can switch on the AIRSCARF neck-level heating with the AIRSCARF switch (> page 65).

### Adjusting air distribution

The symbols on the control represent the following functions:

Symbol	Function
	Directs air to the windshield and through the side defroster air vents
	Directs air into the entire vehicle interior
	Directs air to the footwells and through the side air vents
	Directs air through the center and side air vents

### Climate control

The air distribution can be adjusted manually.

- ▶ Turn air distribution control ③ (> page 162) to the desired symbol. The air distribution is adjusted according to the chosen setting.

You can also turn the control to a position between two symbols.

### Automatic climate control

- ▶ Turn air distribution control ⑧ (> page 163) to the desired symbol. The air distribution is adjusted according to the chosen setting.

You can also turn the control to a position between two symbols.

### Adjusting air volume

#### Climate control

- ▶ **Decreasing/increasing:** Turn air volume control ② (> page 162) clockwise or counterclockwise.

### Automatic climate control

- ▶ **Decreasing/increasing:** Turn air volume control ① (> page 163) clockwise or counterclockwise.

### Front defroster

You can use this setting to defrost the windshield, for example if it is iced up.

You can also defog the windshield and the door windows.

- ❗ Keep this setting selected only until the windshield or the door windows are clear again.

- ▶ **Activating:** Press button .

The indicator lamp in the button comes on.

The climate control switches to the following functions automatically:

- most efficient blower speed and heating power, depending on outside temperature
- air flows onto the windshield and the door windows (side air vents must be open)
- the air conditioning compressor switches on at outside temperatures above approximately 41°F (5°C) for air-drying
- the air recirculation mode is switched off



- ▶ **Deactivating:** Press button  again. The indicator lamp in the button goes out. The previous settings are once again in effect.

- ❗ The cooling remains switched on.

### Windshield fogged on the outside

- ▶ Switch the windshield wipers on (▷ page 76).
- ▶ Press button  <sup>12</sup>.  
The indicator lamp in the button comes on.  
Air distribution and air volume are adjusted automatically.



or

- ▶ Turn air distribution control to  or .

### Maximum cooling MAX COOL

MAX COOL is only available in U.S. vehicles with automatic climate control.

MAX COOL is only operational when the engine is running.

If the air distribution controls as well as the air volume control are set to  and there is a high demand for cooling, MAX COOL is activated. MAX COOL appears in display  (▷ page 163).

This provides the fastest possible cooling of the vehicle interior (when retractable hardtop is closed).

### Air recirculation mode

Switch to air recirculation mode to prevent unpleasant odors from entering the vehicle from the outside (e. g. before driving through a tunnel). This setting cuts off the intake of outside air and recirculates the air in the passenger compartment.

#### **Warning!**

Fogged windows impair visibility, endangering you and others. If the windows begin to fog on the inside, switching off the air recirculation mode immediately should clear interior window fogging. If interior window fogging persists, make sure the air

conditioning is activated, or press button



- ▶ **Activating:** Press button .  
The indicator lamp in the button comes on.

**i** The air recirculation mode is activated automatically at high outside temperatures.

The indicator lamp in button  is not lit when the air recirculation mode is switched on automatically.

A quantity of outside air is added after approximately 30 minutes.

- ▶ **Deactivating:** Press button  again.  
The indicator lamp in the button goes out.

**i** The manually selected air recirculation mode is deactivated automatically:

- after 5 minutes if the outside temperature is below approximately 41°F (5°C)
- after 5 minutes if the air conditioning is turned off
- after 30 minutes if the outside temperature is above approximately 41°F (5°C)





### Residual heat and ventilation

With the engine turned off, it is possible to continue to heat or ventilate the interior for up to 30 minutes. This feature makes use of the residual heat produced by the engine.

**i** If you switch on the residual heat function when outside temperatures are high, only the ventilation will be switched on.

**i** How long the system will provide heating depends on the coolant temperature and the selected temperature. The blower will run at speed setting **1** regardless of the air volume control setting.

<sup>12</sup> Vehicles with automatic climate control

- ▶ **Activating:** Switch off the ignition.
- ▶ Press button  <sup>13</sup> /  <sup>14</sup>.  
The indicator lamp in the button comes on.
- ▶ **Deactivating:** Press button  <sup>13</sup> /  <sup>14</sup>.  
The indicator lamp in the button goes out.

The residual heat is deactivated automatically:

- when the ignition is switched on
- after approximately 30 minutes
- if the battery voltage drops
- if the coolant temperature is too low

### Rear window defroster

#### **Warning!**

Any accumulation of snow and ice should be removed from the rear window before driving. Visibility could otherwise be impaired, endangering you and others.

The rear window defroster uses a large amount of power. To keep the battery drain to a minimum, switch off the defroster as soon as the rear window is clear. The defroster is switched off automatically after some time of operation depending on the outside temperature.

- ▶ Switch on the ignition.
- ▶ **Switching on:** Press button  on the respective climate control panel.  
The indicator lamp in the button comes on.

**!** The rear window defroster cannot be switched on when the retractable hardtop is open. The indicator lamp will start flashing if the hardtop is open.

- Close the retractable hardtop.

The rear window defroster can then be switched on.

- ▶ **Switching off:** Press button  again.

The rear window defroster switches off when the battery voltage is too low. The indicator lamp in button  flashes. Too many electrical consumers may be operating simultaneously.

- ▶ Switch off consumers that are currently not needed if required.

### Retractable hardtop

#### Safety notes

For safety reasons, the retractable hardtop can only be opened and closed when the vehicle is standing still.

-  **Observe Safety notes, see page 45.**

#### **Warning!**

To prevent possible accidents, only drive the vehicle with the retractable hardtop either completely closed and locked, or fully lowered into its storage compartment.

If the retractable hardtop does not completely open or close, the roof hydraulics will lose pressure and the retractable hardtop is lowered

- after approximately 7 minutes when the ignition is switched on
- after approximately 15 seconds when the ignition is switched off

Shortly before the retractable hardtop is lowered, a warning will sound. In the multifunction display you will see  and the message **Retractable Roof Lowering**. Properly lock the retractable hardtop before continuing to drive. Otherwise, the unlocked hardtop could open while the vehicle is in motion and cause you to lose control of the vehicle. You or others could be injured as a result.





<sup>13</sup> Vehicles with climate control

<sup>14</sup> Vehicles with automatic climate control

**⚠ Warning!**

Before operating the retractable hardtop, make sure there is no danger of anyone being injured by the moving parts (retractable hardtop, roof frame, and trunk lid).

Hands must never be placed near the roof frame, upper windshield area, hardtop, shelf behind roll bars, or trunk lid while the retractable hardtop is being raised or lowered. Serious personal injury may occur.

If potential danger exists, release the retractable hardtop switch or button  or  on the SmartKey. This immediately interrupts the raising or lowering procedure. You then can operate the retractable hardtop switch or press button  or  on the SmartKey to raise or lower the retractable hardtop away from the danger zone

**!** Never sit or place heavy objects on the rear shelf. Doing so could cause damage to the retractable hardtop and the rear shelf.

**!** Please keep in mind that weather conditions can sometimes change rapidly. Make sure to close the retractable hardtop when leaving the vehicle. If water enters the vehicle interior, vehicle electronics could be damaged which is not covered by the Mercedes-Benz Limited Warranty.

**!** When opening and closing the retractable hardtop, make sure

- there is sufficient clearance for the retractable hardtop to move up and for the trunk lid to move back
- the luggage cover is installed, extended and closed
- the trunk is loaded only to the height of the luggage cover
- the luggage/cargo does not push up the closed luggage cover

- the trunk lid is closed
- the outside temperature is above +5°F (-15°C)

Otherwise the retractable hardtop and trunk as well as other parts of the vehicle could be damaged.

**Opening and closing****With the retractable hardtop switch**

**⚠ Observe Safety notes, see page 170.**

- ▶ Engage the parking brake.
- ▶ Close the luggage cover (▷ page 173).
- ▶ Close the trunk lid.
- ▶ Switch on the ignition.

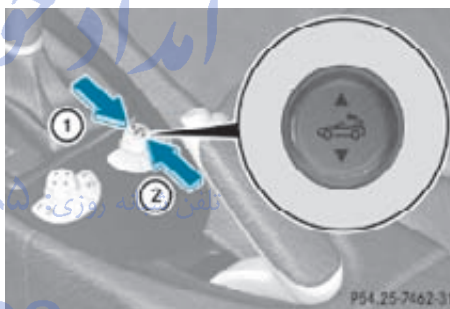

Retractable hardtop switch

**Opening**

- i** Make sure the retractable hardtop is dry before you open it. Otherwise water may enter the trunk interior.
- ▶ Push and hold the retractable hardtop switch in direction of arrow ① until the retractable hardtop is completely lowered into its trunk storage compartment.

**Closing**

- ▶ Push and hold the retractable hardtop switch in direction of arrow ② until the retractable hardtop is completely closed and locked.

**With the SmartKey**



 **Observe Safety notes, see page 170.**





- ▶ Close the luggage cover (▷ page 173).
- ▶ Close the trunk lid.
- ▶ Aim the transmitter eye at an outside door handle.  
The SmartKey must be in close proximity to the outside door handle.

**Opening (Summer opening feature)**

**i** Make sure the retractable hardtop is dry before you open it. Otherwise water may enter the trunk interior.

- ▶ Press and hold button  until the retractable hardtop is completely open. The rear side windows also open.
- ▶ Release button  to interrupt the opening procedure.
- ▶ Press and hold button  once more to open the door windows.

**Closing (Convenience closing feature)**

- ▶ Press and hold button  until the retractable hardtop is completely closed. All currently open windows also close.
- ▶ Release button  to interrupt the closing procedure.

**Locking**

 **Observe Safety notes, see page 170.**

The retractable hardtop is not fully closed and locked or not fully opened and locked if

- the message  Retractable Roof In Operation appears in the multifunction display
- a warning sounds for 10 seconds when driving off or while driving

If the retractable hardtop is not properly locked, lock it as follows.

**Unlocked status noticed when stopped**

- ▶ Switch on the ignition.
- ▶ To lock the retractable hardtop in its fully closed position, push the retractable hardtop switch (▷ page 171) forward until the retractable hardtop is fully closed.

or

- ▶ To lock the retractable hardtop in its fully opened position, push the retractable hardtop switch (▷ page 171) rearward until the retractable hardtop is fully opened.

**Unlocked status noticed while driving**

 **Warning!**

Stop the vehicle in a safe location or as soon as it is safe to do so and lock the retractable hardtop before continuing to drive. You could otherwise endanger yourself and others.

- ▶ Stop the vehicle in a safe location or as soon as it is safe to do so.
- ▶ Leave the ignition switched on.
- ▶ To lock the retractable hardtop in its fully closed position, push the retractable hardtop switch (▷ page 171) forward until the retractable hardtop is fully closed.

or

- ▶ To lock the retractable hardtop in its fully opened position, push the retractable

hardtop switch (▷ page 171) rearward until the retractable hardtop is fully opened.

### Wind screen

The wind screen deflects drafts away from the driver and passenger when the retractable hardtop is lowered. Your vehicle may be equipped with a cloth wind screen or a transparent glass wind screen. This section applies to installing and removing the cloth wind screen. For information on the glass wind screen, refer to the separate mounting instructions that come with the glass wind screen.

#### **Warning!**

The cloth wind screen can restrict the driver's vision to the rear of the vehicle. To prevent a possible accident when visibility is limited (e.g. in darkness), the upper part of the wind screen should be folded back.

The cloth wind screen is stored in a storage bag located on the wall behind the seat backrests.

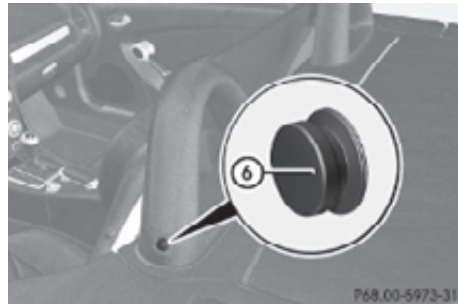
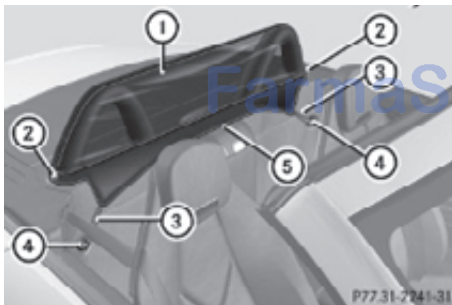

### Installing

- ▶ Remove wind screen ① from its storage bag and unfold.
- ▶ Attach supporting straps ③ to fastening pins ④.
- ▶ Make sure the lower wind screen edging is inserted through gap ⑤ between the storage compartment and the rear panel.
- ▶ Close snap fasteners ② by pushing in handle cap ⑥.
- ▶ Pull wind screen ① on molding over roll bars. Pull the wind screen edging, not on the netting itself.

### Removing

- ▶ Pull wind screen ① from roll bars.
- ▶ Open snap fasteners ② by pulling out handle cap ⑥.
- ▶ Loosen supporting straps ③ from fastening pins ④.
- ▶ Fold the wind screen and put it back into storage bag.

### Luggage cover

The luggage cover covers luggage/cargo in the trunk.

**!** To prevent damage to the retractable hardtop or luggage/cargo when lowering the retractable hardtop:

- Load trunk only to the height of the luggage cover.
- Do not permit luggage/cargo to push up the closed luggage cover.
- Do not place anything on top of or in front of the luggage cover.
- Do not place anything on the shelf behind the roll bar.



### Closing

- ▶ Pull the luggage cover at the handle in direction of the arrow until it engages on both sides at the trunk sill.

### Opening

- ▶ Press the release handle on the luggage cover.
- ▶ Guide the luggage cover forward to its end stop.

## Loading and storing

### Roof rack

**!** This vehicle is not designed to carry items on its roof. Roof rails and any roof-mounted devices, unless expressly approved by Mercedes-Benz for use on this vehicle model, must not be used as they will

damage the vehicle and retractable hardtop.

At time of printing, Mercedes-Benz does not offer any roof racks or any other roof-mounted devices for use on this vehicle.

**!** This vehicle is not designed to carry any items on its trunk lid or accommodate any type of trunk lid rack or device. Using such devices may damage the vehicle and retractable hardtop mechanism.

### Parcel nets

#### **!** Warning!

Parcel nets are intended for storing light-weight items only, such as road maps, mail, etc.

Heavy objects, objects with sharp edges, or fragile objects may not be transported in the parcel nets. In an accident, during hard braking, or sudden maneuvers, they could be thrown around inside the vehicle and cause injury to vehicle occupants.

Parcel nets cannot protect transported goods in the event of an accident.

Parcel nets are located in the passenger footwell and behind the driver's seat.

### Front storage compartments

#### **!** Warning!

To help avoid personal injury during a collision or sudden maneuver, exercise care when storing objects in the vehicle. Put luggage or cargo in the trunk if possible.

Keep compartment lids closed. This will help to prevent stored objects from being thrown about and injuring vehicle occupants during

- braking
- vehicle maneuvers
- an accident



### Glove box



The glove box and the storage compartment under the armrest are locked and unlocked centrally.

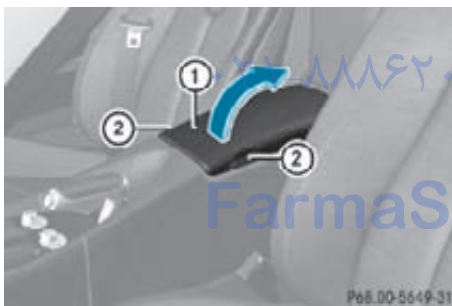

- ▶ **Opening:** Pull glove box lid release ①.
- ▶ **Closing:** Push glove box lid ② upwards until it engages.

### Armrest storage compartment



- ▶ **Information:** The Roadside Assistance button  (> page 180) and the Information button  (> page 181) are located in the storage compartment.
- ▶ **Opening:** Reach into recess ② on the left or right side and lift armrest ① in direction of arrow.
- ▶ **Closing:** Lower armrest ① until it engages.

### Rear storage compartment

#### ⚠ Warning!

To help avoid personal injury during a collision or sudden maneuver, exercise care when storing objects in the vehicle. Put luggage or cargo in the trunk if possible.

Keep compartment lid closed. This will help to prevent stored objects from being thrown about and injuring vehicle occupants during

- braking
- vehicle maneuvers
- an accident

### Storage compartment between the seat backrests



- ▶ **Opening:** Press storage compartment lid release ①.
- ▶ **Closing:** Push storage compartment lid ② up until it engages.

### Shelf behind roll bars

#### ⚠ Warning!

The shelf behind the roll bars should not be used to carry objects. This will prevent such objects from being thrown around and injuring vehicle occupants during an accident or sudden maneuver.

The trunk is the preferred place to carry objects.

## Useful features

### Cup holder

#### Warning!

In order to help prevent spilling liquids on vehicle occupants and/or vehicle equipment, only use containers that fit into the cup holder. Use lids on open containers and do not fill containers to a height where the contents, especially hot liquids, could spill during braking, vehicle maneuvers, or in an accident. Liquids spilled on vehicle occupants may cause serious personal injury. Liquids spilled on vehicle equipment may cause damage not covered by the Mercedes-Benz Limited Warranty.

When not in use, keep the cup holder closed. An open cup holder may cause injury to you or others when contacted during braking, vehicle maneuvers, or in an accident.

Keep in mind that objects placed in the cup holder may come loose during braking, vehicle maneuvers, or in an accident and be thrown around in the vehicle interior. Objects thrown around in the vehicle interior may cause an accident and/or serious personal injury.



- ▶ **Opening:** Press briefly on cover plate ①.
- ▶ **Closing:** Press cover plate ① until the cup holder engages.

## Sun visors

#### Warning!

Do not use the vanity mirror while driving. Keep the vanity mirrors in the sun visors closed while vehicle is in motion. Reflected glare can endanger you and others.

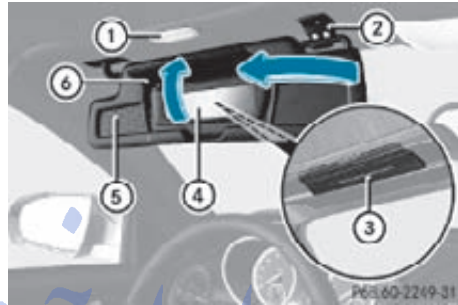

- ① Vanity mirror lamp
- ② Mounting
- ③ Holder, e.g. for gas cards
- ④ Vanity mirror
- ⑤ Sun visor
- ⑥ Vanity mirror cover

### Glare through the windshield

- ▶ Flip sun visor ⑤ down when you experience glare.

### Glare through a door window

- i** This feature is only available on vehicles with interior lighting package.
- ▶ Close vanity mirror cover ⑥ if opened.
- ▶ Disengage sun visor ⑤ from mounting ②.
- ▶ Pivot sun visor ⑤ to the side.
- ▶ Adjust sun visor ⑤ by pushing or pulling.

### Vanity mirror

The vanity mirror lamp only functions when the sun visor is engaged in mounting ②.

- ▶ Lift up vanity mirror cover ⑥.  
Vanity mirror lamp ① comes on.

### Ashtray



- ▶ **Opening:** Press cover plate ① briefly in direction of the arrow.
- ▶ **Removing ashtray insert:** Secure vehicle from movement by setting the parking brake.
- ▶ Automatic transmission: Shift the automatic transmission into neutral position **N**.
- ▶ Manual transmission: Shift the manual transmission into **2nd** gear.
- ▶ Reach into both recesses on the left and right side of the retainer and pull out the ashtray insert.
- ▶ **Reinstalling ashtray insert:** Place the ashtray insert into the retainer.
- ▶ Push the ashtray insert down into the retainer until it engages.
- ▶ **Closing:** Press cover plate ① until the ashtray engages.

### Cigarette lighter

⚠ **Observe Safety notes, see page 45.**

⚠ **Warning!**

Never touch the heating element or sides of the lighter; they are extremely hot. Hold the knob only.

Make sure any children traveling with you do not injure themselves or start a fire with the hot cigarette lighter.

If the engine is off and the cigarette lighter is being used extensively, the vehicle battery may become discharged.



- ▶ Switch on the ignition.
- ▶ Push in cigarette lighter ①.  
Cigarette lighter ① will pop out automatically when hot.
- ▶ Reinsert cigarette lighter ① in its socket after use.

### Power outlet

The power outlet can be used to accommodate 12V DC electrical accessories (e.g. auxiliary lamps, mobile phone chargers) up to a maximum of 15 A (180 W).

If the engine is off and the power outlet is being used extensively, the vehicle battery may become discharged.

- ▶ Switch on the ignition.

### Power outlet in passenger footwell



### Tele Aid

**!** In order to activate the Tele Aid system, a subscriber agreement must be completed. To ensure your system is activated and operational, please press Information button  to perform the acquaintance call. Failure to complete either of these steps may result in a system that is not activated.

If you have any questions regarding activation, please call the Customer Assistance Center at 1-800-FOR-MERCEdes (1-800-367-6372) (USA only) or 1-888-923-8367 (Canada only).

Shortly after the completion of your Tele Aid acquaintance call, you will receive a user ID and password in the mail. You may use this password to access the Tele Aid section in "Owner's Online" at [www.mbusa.com](http://www.mbusa.com) (USA only). The "My Tele Aid" section will give you access to account information, remote door unlock and more.

The Tele Aid system is available if

- it has been activated and is operational. Activation requires a subscription for monitoring services, connection and cellular air time
- vehicle battery power is available
- the relevant cellular phone network and GPS signals are available and pass the

information on to the Customer Assistance Center

- i** Location of the vehicle on a map is only possible if the vehicle is able to receive signals from the GPS satellite network and pass the information on to the Customer Assistance Center.



### The Tele Aid system

(Telematic Alarm Identification on Demand)

The Tele Aid system consists of three types of response:

- Automatic and manual emergency
- Roadside Assistance
- Information

To adjust the speaker volume during a Tele Aid call do the following:

- ▶ Press button  or  on the multifunction steering wheel.

or

- ▶ Use the adjustment button on your audio system or COMAND system.

Be sure to check "Owner's Online" at [www.mbusa.com](http://www.mbusa.com) (USA only) for more information and a description of all available features.



### System self-test

The system performs a self-test after you have switched on the ignition.

#### **Warning!**

A malfunction in the system has been detected if any or all of the following conditions occur:

- The indicator lamp in the SOS button does not come on during the system self-test.
- The indicator lamp in Roadside Assistance button  does not come on during the system self-test.

- The indicator lamp in Information button  does not come on during the system self-test.
- The indicator lamp in the SOS button, Roadside Assistance button , or Information button  remains illuminated constantly in red after the system self-test.
- The message Tele Aid Inoperative appears in the multifunction display after the system self-test.

If a malfunction is indicated as outlined above, the system may not operate as expected. In case of an emergency, help will have to be summoned by other means.

Have the system checked at the nearest Mercedes-Benz Center or contact the Customer Assistance Center at 1-800-FOR-MERcedes (1-800-367-6372) (USA only) or 1-888-923-8367 (Canada only) as soon as possible.

### Emergency calls

**!** In order to activate the Tele Aid system, a subscriber agreement must be completed. To ensure your system is activated and operational, please press Information button  to perform the acquaintance call. Failure to complete either of these steps may result in a system that is not activated.

If you have any questions regarding activation, please call the Customer Assistance Center at 1-800-FOR-MERcedes (1-800-367-6372) (USA only) or 1-888-923-8367 (Canada only).

An emergency call is initiated automatically following an accident in which the Emergency Tensioning Devices (ETDs) or air bags have deployed.

**i** An automatically initiated Tele Aid emergency call cannot be canceled.

An emergency call can also be initiated manually ([▷ page 180](#)).

Once the emergency call is in progress, the indicator lamp in the SOS button will begin to flash. The message Connecting Call appears in the multifunction display and the audio system or the COMAND system is muted. When the connection is established, the message Call Connected appears in the multifunction display.

All information relevant to the emergency, such as the location of the vehicle (determined by the GPS satellite location system), vehicle model, identification number and color are generated.

A voice connection between the Customer Assistance Center and the occupants of the vehicle will be established automatically soon after the emergency call has been initiated. The Customer Assistance Center will attempt to determine the nature of the emergency more precisely, provided they can speak to an occupant of the vehicle.

**i** If no vehicle occupant responds, an ambulance will be sent to the vehicle immediately.

#### Warning!

If the indicator lamp in the SOS button is flashing continuously and there was no voice connection to the Customer Assistance Center established, then the Tele Aid system could not initiate an emergency call (e.g. the relevant cellular phone network is not available).

The message Call Failed appears in the multifunction display for approximately 10 seconds.

Should this occur, assistance must be summoned by other means.

**i** The “911” emergency call system is a public service. Using it without due cause is a criminal offense.

### Initiating an emergency call manually

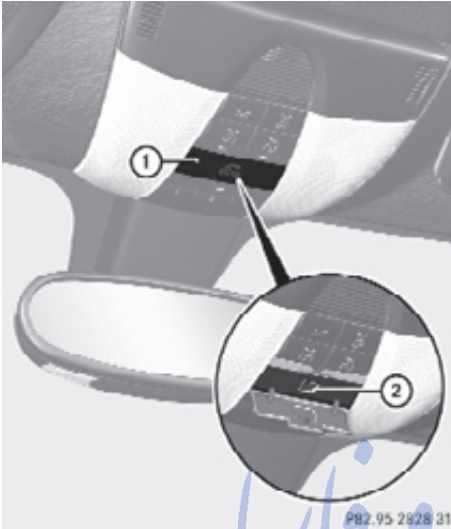

- ▶ Briefly press on cover ① to open.
- ▶ Press SOS button ② briefly. The indicator lamp in SOS button ② will flash until the emergency call is concluded.
- ▶ Wait for a voice connection to the Customer Assistance Center.
- ▶ Close cover ① after the emergency call is concluded.

#### **Warning!**

If you feel at any way in jeopardy when in the vehicle (e.g. smoke or fire in the vehicle, vehicle in a dangerous road location), please do not wait for voice contact after you have pressed the emergency button. Carefully leave the vehicle and move to a safe location. The Customer Assistance Center will automatically contact local emergency officials with the vehicle's approximate location if they receive an automatic SOS signal and cannot make voice contact with the vehicle occupants.

- ▶ **Terminating calls:** Press button  on the multifunction steering wheel.
- or
- ▶ Press the respective button for ending a telephone call on the audio system or the COMAND system.

### Roadside Assistance button

- ▶ Open the storage compartment under the armrest (▶ page 175).

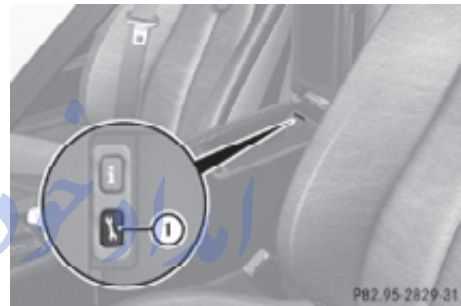

- ▶ Press and hold Roadside Assistance button ① for longer than 2 seconds. A call to a Mercedes-Benz Roadside Assistance dispatcher will be initiated. The indicator lamp in Roadside Assistance button ① will flash while the call is in progress. The message Connecting Call will appear in the multifunction display and the audio system or the COMAND system is muted.

When the connection is established, the message Call Connected appears in the multifunction display. The Tele Aid system will transmit data generating the vehicle identification number, model, color and location (subject to availability of cellular and GPS signals).

- i** The audio system or COMAND system display indicates that a Tele Aid call is in progress. While the call is connected you can change to the navigation menu by pressing the NAVI button on the COMAND

system. Spoken commands are not available.

A voice connection between the Roadside Assistance dispatcher and the occupants of the vehicle will be established.

- ▶ Describe the nature of the need for assistance.

The Mercedes-Benz Roadside Assistance dispatcher will either dispatch a qualified Mercedes-Benz technician or arrange to tow your vehicle to the nearest authorized Mercedes-Benz Center. For services such as labor and/or towing, charges may apply. Refer to the Roadside Assistance manual for more information.

Sign and Drive services (USA only):

Services such as a jump start, a few gallons of fuel or the replacement of a flat tire with the vehicle spare wheel are obtainable at no charge.

- ❗ If the indicator lamp in Roadside Assistance button ① is flashing continuously and there was no voice connection to the Customer Assistance Center established, then the Tele Aid system could not initiate a Roadside Assistance call (e.g. the relevant cellular phone network is not available). The message **Call Failed** appears in the multifunction display.

- ▶ **Terminating calls:** Press button  on the multifunction steering wheel.

or

- ▶ Press the respective button for ending a telephone call on the audio system or the COMAND system.

### Information button

- ▶ Open the storage compartment under the armrest (▷ page 175).



- ▶ Press and hold Information button ① for longer than 2 seconds.

A call to the Customer Assistance Center will be initiated. The indicator lamp in Information button ① will flash while the call is in progress. The message **Connecting Call** will appear in the multifunction display and the COMAND system is muted.

When the connection is established, the message **Call Connected** appears in the multifunction display. The Tele Aid system will transmit data generating the vehicle identification number, model, color and location (subject to availability of cellular and GPS signals).

- ❗ The audio system or COMAND system display indicates that a Tele Aid call is in progress. While the call is connected you can change to the navigation menu by pressing the NAVI button on the COMAND system. Spoken commands are not available.

A voice connection between the Customer Assistance Center representative and the occupants of the vehicle will be established. Information regarding the operation of your vehicle, the nearest authorized Mercedes-Benz Center or Mercedes-Benz USA products and services is available to you.

For more details concerning the Tele Aid system, please visit [www.mbusa.com](http://www.mbusa.com) (USA only), log in to “Owner’s Online” and visit the “My Tele Aid” section to learn more.

**i** If the indicator lamp in Information button ① is flashing continuously and there was no voice connection to the Customer Assistance Center established, then the Tele Aid system could not initiate an Information call (e.g. the relevant cellular phone network is not available). The message **Call Failed** appears in the multifunction display.

► **Terminating calls:** Press button  on the multifunction steering wheel.

or

► Press the respective button for ending a telephone call on the audio system or the COMAND system.

### Call priority

If other service calls such as a Roadside Assistance call or Information call are active, an emergency call is still possible. In this case, the emergency call will take priority and override all other active calls.

The indicator lamp in the respective button flashes until the call is concluded. Automatic initiated emergency calls can only be terminated by a Customer Assistance Center representative. All other calls can be terminated by pressing button  on the multifunction steering wheel or the respective button for ending a telephone call on the audio system or the COMAND system.

**i** When a Tele Aid call has been initiated, the audio system or the COMAND system is muted. The mobile phone is no longer connected to the COMAND system. If you must use this phone, we recommend that you use it only with the vehicle at a standstill in a safe location.

### Destination Download to the COMAND system



**i** The components and operating principles of the COMAND system can be found in the

separate COMAND system operating instructions.

Destination Download allows you access to a database of over 10 million points of interest (POIs) that can be downloaded to your vehicle's navigation system. If you know the destination, the address can be downloaded, or can be provided with points of interests near your location.

### Route guidance

You will be prompted to confirm that route guidance to the entered address is to be started.

► Select Yes using button  or  on the COMAND system.

► Press button  on the COMAND system to confirm.

The system calculates the route and subsequently starts the route guidance to the defined address.

**i** If you select No, you can save the address to your address book.

**i** The Destination Download feature is available if the relevant mobile phone network is available and data connection is possible.

### Search & Send

“Search & Send” is a navigation destination address entry service. For more information on “Search & Send”, refer to separate COMAND system operating instructions.

### Remote door unlock

In case you have locked your vehicle unintentionally (e.g. SmartKey inside vehicle), and the reserve SmartKey is not available:

► Contact the Customer Assistance Center at 1-800-FOR-MERcedes



(1-800-367-6372) (USA only) or 1-888-923-8367 (Canada only).

You will be asked to provide your password.

- ▶ Then return to your vehicle at the time arranged with the Customer Assistance Center and pull the trunk recessed handle for a minimum of 20 seconds until the indicator lamp in the SOS button is flashing. The message **Connecting Call** appears in the multifunction display.

As an alternative, you may unlock the vehicle via Internet in the “My Tele Aid” section of “Owner’s Online”, using your ID and password (USA only).

- i** The remote door unlock feature is available if the relevant cellular phone network is available.

The SOS button will flash and the message **Connecting Call** will appear in the multifunction display to indicate receipt of the door unlock command.

If the trunk recessed handle was pulled for more than 20 seconds before door unlock authorization was received by the Customer Assistance Center, you must wait 15 minutes before pulling the trunk recessed handle again.

### Stolen Vehicle Recovery Services

In the event your vehicle was stolen:

- ▶ Report the incident to the police. The police will issue a numbered incident report.
- ▶ Pass this number on to the Customer Assistance Center along with your password. The Customer Assistance Center will then attempt to covertly contact the vehicle’s Tele Aid system. Once the vehicle is located, the Customer Assistance Center will contact the local law enforcement and you. The vehicle’s location will only be provided to law enforcement.

- i** If the anti-theft alarm or the tow-away alarm stays on for more than 30 seconds,

a call to the Customer Assistance Center is initiated automatically by the Tele Aid system provided Tele Aid service was subscribed to and properly activated, and that necessary cellular service and GPS coverage are available. See “Anti-theft alarm system” (▶ page 51) and “Tow-away alarm” (▶ page 52).

### Garage door opener

The integrated remote control can operate up to three separately controlled devices compatible with HomeLink® or some other systems.

#### **⚠ Warning!**

Before programming the integrated remote control to a garage door opener or gate operator, make sure people and objects are out of the way of the device to prevent potential harm or damage. When programming a garage door opener, the door moves up or down. When programming a gate operator, the gate opens or closes.

Do not use the integrated remote control with any garage door opener that lacks safety stop and reverse features as required by U.S. federal safety standards (this includes any garage door opener model manufactured before April 1, 1982). A garage door that cannot detect an object - signaling the door to stop and reverse - does not meet current U.S. federal safety standards.

When programming a garage door opener, park vehicle outside the garage.

Do not run the engine while programming the integrated remote control. Inhalation of exhaust gas is hazardous to your health. All exhaust gas contains carbon monoxide (CO), and inhaling it can cause unconsciousness and possible death.

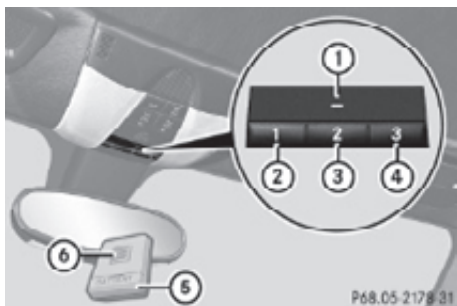

Overhead control panel with integrated remote control

Hand-held remote control (5) is not part of the vehicle equipment.

### Programming the integrated remote control

- ▶ **Step 1:** Switch on the ignition.
- ▶ **Step 2:** If you have previously programmed a signal transmitter button and wish to retain its programming, proceed to step 3.  
or
- ▶ If you are programming the integrated remote control for the first time, press and hold the two outer signal transmitter buttons (2) and (4) and release them when indicator lamp (1) begins to flash after approximately 20 seconds.  
Do not hold the buttons for longer than 30 seconds.  
This procedure erases any previous settings for all three channels and initializes the memory. If you later wish to program a second and/or third hand-held transmitter to the remaining two signal transmitter buttons, do not repeat this step and begin directly with step 3.
- ▶ **Step 3:** Hold the end of hand-held remote control (5) of the device you wish to train approximately 2 to 12 in (5 to 30 cm) away from the signal transmitter button (2), (3) or (4) to be programmed, while keeping indicator lamp (1) in view.

- ▶ **Step 4:** Using both hands, simultaneously press hand-held remote control button (6) and the desired signal transmitter button (2), (3) or (4). Do not release the buttons until step 5 is completed.  
Indicator lamp (1) will flash, first slowly and then rapidly.

**i** Indicator lamp (1) flashes immediately the first time the signal transmitter button is programmed. If this button has already been programmed, the indicator lamp will start flashing after 20 seconds.

- ▶ **Step 5:** After indicator lamp (1) changes from a slow to a rapidly flashing light, release the hand-held remote control button and the signal transmitter button.

- ▶ **Step 6:** Press and hold the just-trained signal transmitter button (2), (3) or (4) and observe indicator lamp (1).  
If indicator lamp (1) stays on constantly, programming is complete and your device should activate when the respective signal transmitter button (2), (3) or (4) is pressed and released.

**i** If indicator lamp (1) flashes rapidly for approximately 2 seconds and then turns to a constant light, continue with programming steps 8 through 12 as your garage door opener may be equipped with the "rolling code" feature.

- ▶ **Step 7:** To program the remaining two signal transmitter buttons, repeat the steps above starting with step 3.

### Rolling code programming

To train a garage door opener (or other rolling code devices) with the rolling code feature, follow these instructions after completing the "Programming" portion (steps 1 through 6) of this text. For your convenience and to complete the procedure faster, you might want to have someone assist you.

- ▶ **Step 8:** Locate the “training” button on the garage door opener motor head unit.
  - ❗ Exact location and color of the button may vary by garage door opener brand. Depending on manufacturer, the “training” button may also be referred to as “learn” or “smart” button. If there is difficulty locating the transmitting button, refer to the garage door opener Operator’s Manual.
- ▶ **Step 9:** Press the “training” button on the garage door opener motor head unit. The “training light” is activated. You have 30 seconds to initiate the following two steps.
- ▶ **Step 10:** Return to the vehicle and firmly press, hold for 2 seconds and release the programmed signal transmitter button (②, ③ or ④).
- ▶ **Step 11:** Press, hold for 2 seconds and release same signal transmitter button a second time to complete the training process.
  - ❗ Some garage door openers (or other rolling code equipped devices) may require you to press, hold for 2 seconds and release the same signal transmitter button a third time to complete the training process.
- ▶ **Step 12:** Confirm the garage door operation by pressing the programmed signal transmitter button (②, ③ or ④).
- ▶ **Step 13:** To program the remaining two signal transmitter buttons, repeat the steps above starting with step 3.

### Gate operator/Canadian programming

Canadian radio-frequency laws require transmitter signals to “time-out” (or quit) after several seconds of transmission which may not be long enough for the integrated signal transmitter to pick up the signal during programming. Similar to this Canadian law, some U.S. gate operators are designed to “time-out” in the same manner.

If you live in Canada or if you are having difficulties programming a gate operator (regardless of where you live) by using the programming procedures, replace step 4 with the following:

- ▶ **Step 4:** Press and hold the signal transmitter button (②, ③ or ④). Do not release this button until it has been successfully trained.
- ▶ While still holding down the signal transmitter button (②, ③ or ④), “cycle” your hand-held remote control button ⑥ as follows: Press and hold button ⑥ for 2 seconds, then release it for 2 seconds, and again press and hold it for 2 seconds. Repeat this sequence on the hand-held remote control until the frequency signal has been learned. Upon successful training, indicator lamp ① will flash slowly and then rapidly after several seconds.
- ▶ Proceed with programming step 5 and step 6 to complete.
  - ❗ Upon completion of programming the integrated remote control, make sure you retain the hand-held remote control that came with the garage door opener, gate operator or other device. You may need it for use in other vehicles, for future programming of an integrated remote control, or simply for continued use as a hand-held remote control to operate the respective device in other situations.

### Reprogramming a single signal transmitter button

To program a device using a signal transmitter button previously trained, follow these steps:

- ▶ Switch on the ignition.
- ▶ Press and hold the desired signal transmitter button (②, ③ or ④). Do not release the button. Indicator lamp ① will begin to flash after 20 seconds.
- ▶ Without releasing the signal transmitter button, proceed with programming starting with step 3.

### Operation of integrated remote control

- ▶ Switch on the ignition.
- ▶ Select and press the appropriate integrated signal transmitter button (②, ③ or ④) to activate the remote controlled device. The integrated remote control transmitter continues to send the signal as long as the button is pressed – up to 20 seconds.

### Erasing the integrated remote control memory

- ❗ If you sell your vehicle, erase the codes of all three channels.
- ▶ Switch on the ignition.
- ▶ Simultaneously press and hold outer signal transmitter buttons ② and ④, for approximately 20 seconds, until indicator lamp ① flashes rapidly. Do not hold for longer than 30 seconds. The codes of all three channels are erased.

### Programming tips

If you are having difficulty programming the integrated remote control, here are some helpful tips:

- Check the frequency of hand-held remote control ⑤ (typically located on the reverse side of the remote). The integrated remote

control is compatible with radio-frequency devices operating between 280-390 MHz.

- Put a new battery in hand-held remote control ⑤. This will increase the likelihood of the hand-held remote control sending a stronger and more accurate signal to the integrated remote control.
- While performing step 3, hold hand-held remote control ⑤ at different lengths and angles from the signal transmitter button (②, ③ or ④) you are programming. Attempt varying angles at the distance of 2 to 12 inches (5 to 30 cm) away or the same angle at varying distances.
- If another hand-held remote control is available for the same device, try the programming steps again using that other hand-held remote control. Make sure new batteries are in the hand-held remote control before beginning the procedure.
- Straighten the antenna wire from the garage door opener assembly. This may help improve transmitting and/or receiving signals. تلفن شبانه روز.
- ❗ Certain types of garage door openers are incompatible with the integrated remote control. If you should experience further difficulties with programming the integrated remote control, contact an authorized Mercedes-Benz Center, or call the Mercedes-Benz Customer Assistance Center (USA only) at 1-800-FOR-MERcedes, or the HomeLink® Hotline (USA only) at 1-800-355-3515, or the Customer Service (Canada only) at 1-800-387-0100.

**i** USA only:

This device complies with Part 15 of the FCC Rules. Operation is subject to the following two conditions:

1. This device may not cause harmful interference, and
2. this device must accept any interference received, including interference that may cause undesired operation.

Any unauthorized modification to this device could void the user's authority to operate the equipment.

**i** Canada only:

This device complies with RSS-210 of Industry Canada. Operation is subject to the following two conditions:

1. This device may not cause interference, and
2. this device must accept any interference received, including interference that may cause undesired operation of the device.

Any unauthorized modification to this device could void the user's authority to operate the equipment.

- Move the driver's seat or passenger seat as far to the rear as possible.

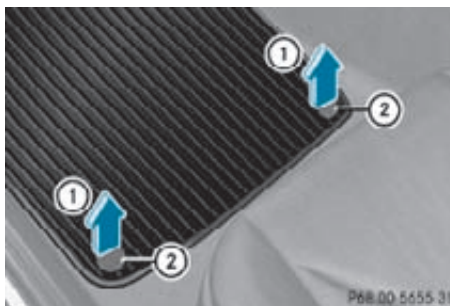

- **Removing:** Pull floormat off of retainer pins ② in direction of arrow ①.

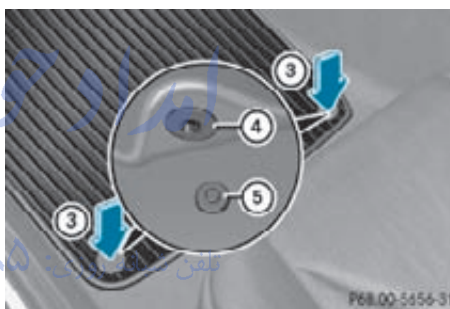

- **Installing:** Press floormat eyelets ④ onto retainer pins ⑤ in direction of arrow ③.

**Floormats****⚠ Warning!**

Whenever you are using floormats, make sure there is enough clearance and that the floormats are securely fastened.

Floormats should always be securely fastened using the fastening equipment.

Before driving off, check that the floormats are securely in place and adjust them if necessary. A loose floor mat could slip and hinder proper functioning of the pedals.

Do not place several floormats on top of each other as this may impair pedal movement.

# امداد خودرو فارما

تلفن شبانه روزی: ۰۲۱-۸۸۸۶۲۰۸۵

[FarmaSOS.com](http://FarmaSOS.com)

Vehicle equipment .....	190
The first 1000 miles (1500 km) .....	190
At the gas station .....	190
Engine compartment .....	192
Tires and wheels .....	197
Winter driving .....	219
Driving instructions .....	221
Maintenance .....	225
Vehicle care .....	227

# امداد خودرو فارما

تلفن شبانه روزی: ۰۲۱-۸۸۸۶۲۰۸۵

FarmaSOS.com



## Vehicle equipment

**i** This Operator's Manual describes all features, standard or optional, potentially available for your vehicle at the time of purchase. Please be aware that your vehicle might not be equipped with all features described in this manual.

## The first 1000 miles (1500 km)

The more cautiously you treat your vehicle during the break-in period, the more satisfied you will be with its performance later on.

- Drive your vehicle during the first 1 000 miles (1 500 km) at varying but moderate vehicle and engine speeds.
- During this period, avoid heavy loads (full throttle driving) and excessive engine speeds (no more than  $\frac{2}{3}$  of maximum rpm in each gear).
- Vehicles with automatic transmission:
  - Select **C** as the preferred shift program (▷ page 88) for the first 1 000 miles (1 500 km).
  - Do not attempt to slow the vehicle down by shifting to a lower gear using the gear selector lever.
  - Select gear ranges **3, 2** or **1** (▷ page 88) only when driving at moderate speeds (for hill driving).
  - Avoid accelerating by kickdown.
- Vehicles with manual transmission:  
Shift gears in a timely manner.

After 1 000 miles (1 500 km) you may gradually increase vehicle and engine speeds to the permissible maximum.

**!** Additional instructions for AMG vehicles:

- During the first 1 000 miles (1 500 km), do not exceed a speed of 85 mph (140 km/h).
- During this period, avoid engine speeds above 4 500 rpm in each gear.
- Shift gears in a timely manner.

All of the above instructions, as may apply to your vehicle type, also apply when driving the first 1 000 miles (1 500 km) after the engine or the rear differential has been replaced.

**i** Always obey applicable speed limits.

## At the gas station

### Refueling

#### **⚠ Warning!**

Gasoline is highly flammable and poisonous. It burns violently and can cause serious personal injury.

Never allow sparks, flames or smoking materials near gasoline!

Turn off the engine before refueling.

Whenever you are around gasoline, avoid inhaling fumes and any skin or clothing contact. Extinguish all smoking materials.

Direct skin contact with fuels and the inhalation of fuel vapors are damaging your health.

#### **⚠ Warning!**

Overfilling of the fuel tank may create pressure in the system which could cause a gas discharge. This could cause the gas to spray back out when removing the fuel pump nozzle, which could cause personal injury.

**!** Never refuel vehicles with gasoline engine with diesel fuel. Even small amounts of diesel fuel will damage the fuel system and engine. Damage resulting from the use of non-approved fuels or fuel additives or resulting from mixing gasoline with diesel



fuel is not covered by the Mercedes-Benz Limited Warranty.

**!** If you have accidentally filled the tank with incorrect or non-approved fuel, do not switch on the ignition. Otherwise the incorrect or non-approved fuel will get into the fuel lines. The fuel system must be drained completely. Contact an authorized Mercedes-Benz Center to have the fuel system drained completely.

**!** To prevent damage to the catalytic converters, only use premium unleaded gasoline in this vehicle.

Any noticeable irregularities in engine operation should be repaired promptly. Otherwise, excessive unburned fuel may reach the catalytic converter, causing it to overheat and potentially start a fire.

**i** Only use premium unleaded gasoline with a minimum Posted Octane Rating of 91 (average of 96 RON/86 MON). Information on gasoline quality can normally be found on the fuel pump. Please contact gas station personnel in case labels on the pump cannot be found. For more information on gasoline, see “Premium unleaded gasoline” (▷ page 303), see “Fuel requirements” (▷ page 303), or contact an authorized Mercedes-Benz Center, or visit [www.mbusa.com](http://www.mbusa.com) (USA only).

Locking/unlocking the vehicle with the SmartKey automatically locks/unlocks the fuel filler flap.

**i** In case the central locking system does not release the fuel filler flap, or the opening mechanism is clamping, contact Roadside Assistance or an authorized Mercedes-Benz Center.

The fuel filler flap is located on the right-hand side of the vehicle towards the rear.

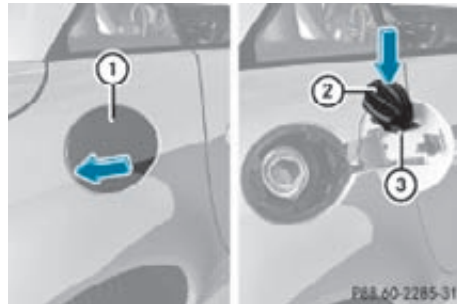

▶ Turn off the engine.

**i** Leaving the engine running and the fuel filler cap open can cause the yellow fuel tank reserve warning lamp to flash and the malfunction indicator lamp **CHECK ENGINE** (USA only) or  (Canada only) to illuminate. For more information, see also “Practical hints” (▷ page 262).

▶ Remove the SmartKey from the starter switch.

▶ **Opening:** Press fuel filler flap ① at the point indicated by the arrow.

▶ Turn fuel filler cap ② counterclockwise.

▶ Take off fuel filler cap ②.

▶ Place fuel filler cap ② in direction of arrow into holder ③.

▶ Fully insert filler nozzle unit and refuel.

▶ Only fill your tank until the filler nozzle unit cuts out – **do not top off or overfill.**

▶ **Closing:** Turn fuel filler cap ② clockwise until it audibly engages.

**i** Close the fuel filler flap before locking the vehicle. Otherwise the flap locking pin will prevent closing the fuel filler flap.

▶ Close fuel filler flap ①.

### Check regularly and before a long trip

For information on quantities and requirements of operating agents, see “Fuels, coolants, lubricants, etc.” (▷ page 300).

Check the following:

- Engine oil level (▷ page 193)
- Tire inflation pressure (▷ page 201)
- Coolant level (▷ page 196)
- Vehicle lighting (▷ page 267)
- Washer system and headlamp cleaning system (▷ page 196)
- Brake fluid (▷ page 197)

## Engine compartment

### Hood

#### ⚠ Warning!

Do not pull the release lever while the vehicle is in motion. Otherwise the hood could be forced open by passing air flow.

This could cause the hood to come loose and injure you and/or others.

### Opening

#### ⚠ Warning!

Do not open the hood when the engine is overheated. You could be seriously injured. Observe the coolant temperature display to determine whether the engine may be overheated. If you see flames or smoke coming from the engine compartment, move away from the vehicle. Wait until the engine has cooled. If necessary, call the fire department.

#### ⚠ Warning!

You could be injured when the hood is open – even when the engine is turned off. Parts of the engine can become very hot. To prevent burns, let the engine cool completely before touching any components on the vehicle. Comply with all relevant safety precautions.

#### ⚠ Warning!

To help prevent personal injury, stay clear of moving parts when the hood is open and the engine is running.

The radiator fan may continue to run for approximately 30 seconds or may even restart after the engine has been turned off. Stay clear of fan blades.

#### ⚠ Warning!

The engine is equipped with a transistorized ignition system. Because of the high voltage it is dangerous to touch any components (ignition coils, spark plug sockets, diagnostic socket) of the ignition system

- with the engine running
- while starting the engine
- when the ignition is switched on and the engine is turned manually

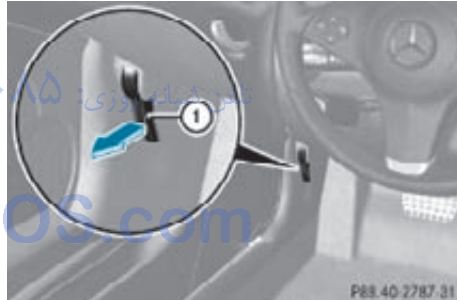

- ▶ Pull hood lock release lever ①.  
The hood is unlocked.

- ⚠ Never open the hood if the wiper arms are folded forward away from the windshield. Otherwise the windshield wipers or the hood could be damaged.



- ▶ Push handle ② under the hood upwards.
- ▶ Lift the hood at the front edge.  
The hood will be held open at shoulder height by gas-filled struts automatically.

### Closing

#### **Warning!**

When closing the hood, use extreme caution not to catch hands or fingers. Be careful that you do not close the hood on anyone.

Make sure the hood is securely engaged before driving off. Do not continue driving if the hood can no longer engage after an accident, for example. The hood could otherwise come loose while the vehicle is in motion and injure you and/or others.

- ▶ Let the hood drop from a height of approximately 8 in (20 cm).
- ▶ Check to make sure the hood is fully closed.

If you can raise the hood at a point above the headlamps, then it is not properly closed. Open it again and let it drop with somewhat greater force.

### Engine oil

The amount of oil your engine consumes will depend on a number of factors, including driving style. Increased oil consumption can occur when the vehicle is new or the vehicle is driven frequently at higher engine speeds.

Engine oil consumption checks should only be made after the vehicle break-in period.

**!** Do not use any special lubricant additives, as these may damage the drive assemblies. Using special additives not approved by Mercedes-Benz may cause damage not covered by the Mercedes-Benz Limited Warranty.

For further information contact an authorized Mercedes-Benz Center.

### Notes on checking engine oil level

When checking the oil level

- the vehicle must be parked on level ground
- with the engine at operating temperature, the vehicle must have been stationary for at least 5 minutes with the engine turned off
- with the engine not at operating temperature, the vehicle must have been stationary for at least 30 minutes with the engine turned off

### Checking engine oil level with the oil dipstick

On the SLK 300 and SLK 350 you can check the engine oil level with the oil dipstick.

- ▶ Open the hood (> page 192).



- ▶ Pull out oil dipstick ①.
- ▶ Wipe oil dipstick ① clean.

- ▶ Slowly insert oil dipstick ① fully into the dipstick guide tube.
- ▶ Pull out oil dipstick ① again after approximately 3 seconds to obtain accurate reading.

The oil level is correct when it is between lower (min) mark ③ and upper (max) mark ② of oil dipstick ①.

**i** The filling quantity between the upper and lower marks on the oil dipstick is approximately 2.1 US qt. (2.0 l).



- ▶ If necessary, add engine oil.

For more information on engine oil, see “Fuels, coolants, lubricants etc.” (▷ page 300).

For information on messages in the multifunction display concerning engine oil, see the “Practical hints” section (▷ page 250).

### Checking engine oil level with the control system

On the SLK 55 AMG you can check the engine oil level with the control system.

- ▶ Switch on the ignition.  
The standard display appears in the multifunction display (▷ page 96).
- ▶ Press button  or  on the multifunction steering wheel repeatedly until the following message appears in the multifunction display:

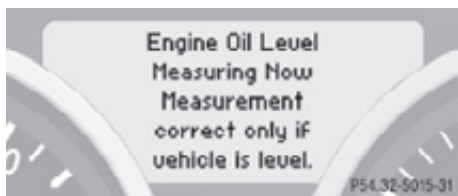



One of the following messages will subsequently appear in the multifunction display:

- Engine Oil Level

OK

- Add 1.0 qt. (Canada: 1.0 liter) to reach max. oil level.
- Add 1.5 qts. (Canada: 1.5 liters) to reach max. oil level.
- Add 2.0 qts. (Canada: 2.0 liters) to reach max. oil level.

**i** If you want to interrupt the checking procedure, press button  or  on the multifunction steering wheel.

- ▶ If necessary, add engine oil.

For more information on engine oil, see “Fuels, coolants, lubricants etc.” (▷ page 300).

### Other display messages

If the ignition is not switched on, the following message appears in the multifunction display:

Turn on ignition to see engine oil level.

- ▶ Switch on the ignition.

If you see the message:



Observe  
Waiting Time

- ▶ If the engine is at operating temperature, wait 5 minutes before repeating check procedure.
- ▶ If the engine is not at operating temperature yet, you must wait 30 minutes before checking oil.

If you see the message:

Cannot check engine oil level with engine on.

- ▶ Turn off the engine.
- ▶ If the engine is at operating temperature, wait 5 minutes before checking oil.
- ▶ If the engine is not at operating temperature yet, you must wait 30 minutes before checking oil.

**i** If you want to interrupt the checking procedure, press button  or  on the multifunction steering wheel.

If there is excess engine oil with the engine at normal operating temperature, the following message appears in the multifunction display:

Engine Oil Level  
Reduce Oil Level

▶ Have excess oil siphoned or drained off. Contact an authorized Mercedes-Benz Center.

**!** Excess oil must be siphoned or drained off. It could cause damage to the engine and emission control system not covered by the Mercedes-Benz Limited Warranty.

For information on messages in the multifunction display concerning engine oil, see the “Practical hints” section (▶ page 251).

### Adding engine oil

**!** Only use approved engine oils and oil filters required for vehicles with Maintenance System. For a listing of approved engine oils and oil filters, contact an authorized Mercedes-Benz Center or visit [www.mbusa.com](http://www.mbusa.com) (USA only).

The following will result in engine or emission control system damage not covered by the Mercedes-Benz Limited Warranty:

- Using engine oils and oil filters of specification other than those expressly required for the Maintenance System.
- Changing of oil and oil filter at change intervals longer than those called for by the Maintenance System.
- Using any oil additives.



Example illustration: SLK 350 (SLK 300 similar)

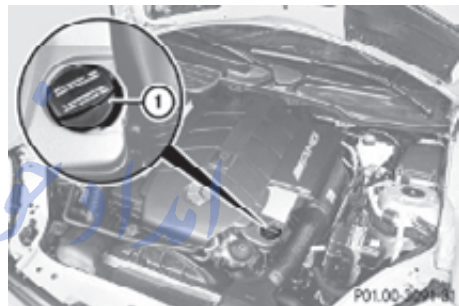

SLK 55 AMG

- ▶ Unscrew filler cap  from filler neck.
- ▶ Add engine oil as required. Be careful not to overfill with oil.

Be careful not to spill any oil when adding. Avoid environmental damage caused by oil entering the ground or water.

**!** Excess oil must be siphoned or drained off. It could cause damage to the engine and emission control system not covered by the Mercedes-Benz Limited Warranty.

- ▶ Screw filler cap  back on filler neck.

For more information on engine oil, see the “Technical data” section (▶ page 300) and (▶ page 302).

### Transmission fluid level

Vehicles with automatic transmission:  
The transmission fluid level does not need to be checked. If you notice transmission fluid loss or gearshifting malfunctions, have an

authorized Mercedes-Benz Center check the transmission.

### Coolant level

The engine coolant is a mixture of water and anticorrosion/antifreeze.

When checking the coolant level, the vehicle must be parked on level ground, and the coolant temperature must be below 158°F (70°C).

#### Warning!

In order to avoid any potentially serious burns:

- Use extreme caution when opening the hood if there are any signs of steam or coolant leaking from the cooling system, or if the coolant temperature display indicates that the coolant is overheated.
- Do not remove the cap on the coolant expansion tank if the coolant temperature is above 158°F (70°C). Allow the engine to cool down before removing the cap. The coolant expansion tank contains hot fluid and is under pressure.
- Using a rag, slowly open the cap approximately  $\frac{1}{2}$  turn counterclockwise to relieve excess pressure. If opened immediately, scalding hot fluid and steam will be blown out under pressure.
- Do not spill antifreeze on hot engine parts. Antifreeze contains ethylene glycol which may burn if it comes into contact with hot engine parts.

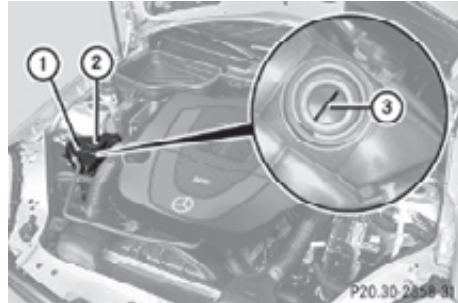

Example illustration: SLK 350

- ▶ Using a rag, slowly open cap ② approximately  $\frac{1}{2}$  turn counterclockwise to relieve excess pressure.
- ▶ Continue turning cap ② counterclockwise and remove it.

The coolant level is correct if the level

- for cold coolant: reaches marking bar ③ in coolant expansion tank ①
  - for warm coolant: is approximately 0.6 in (1.5 cm) higher
- ▶ Add coolant as required.
  - ▶ Screw cap ② back on and tighten it.

For more information on coolant, see the “Technical data” section (▶ page 301) and (▶ page 304).

### Washer system and headlamp cleaning system

#### Warning!

Washer solvent/antifreeze is highly flammable. Do not spill washer solvent/antifreeze on hot engine parts, because it may ignite and burn. You could be seriously burned.

- Always use washer solvent/antifreeze where temperatures may fall below freezing point. Failure to do so could result in damage to the washer system/fluid reservoir.

**!** Only use washer fluid which is suitable for plastic lenses. Improper washer fluid can damage the plastic lenses of the headlamps.

**!** Do not use distilled or deionized water in the washer fluid reservoir. Otherwise, the washer fluid level sensor could be damaged.

Fluid for the washer system and the headlamp cleaning system is supplied from the washer fluid reservoir.

During all seasons, use MB Windshield Washer Concentrate “MB SummerFit”. Mix it with water or premixed washer solvent/antifreeze depending on the ambient temperature (▷ page 306).



Example illustration: SLK 350

- ▶ **Opening washer fluid reservoir:** Pull tab of cap ① upwards.
- ▶ Refill the washer fluid reservoir.
- ▶ **Closing washer fluid reservoir:** Press cap ① onto filler hole until it engages.

For more information, see “Washer system and headlamp cleaning system” (▷ page 302).

### Brake fluid level

**!** If you find that the brake fluid in the brake fluid reservoir has fallen to the minimum mark or below, have the brake system checked for brake pad thickness and leaks immediately. Contact an authorized

Mercedes-Benz Center immediately. Do not add brake fluid as this will not solve the problem. For more information, see “Practical hints”.

When checking the brake fluid level, the vehicle must be parked on level ground.

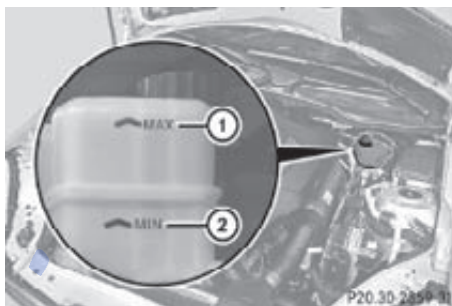

The brake fluid level is correct when it is between lower mark (MIN) ② and upper mark (MAX) ① of the brake fluid reservoir.

### Tires and wheels

#### Safety notes

Contact an authorized Mercedes-Benz Center for information on tested and recommended rims and tires for summer and winter operation. They can also offer advice concerning tire service and purchase.

#### ⚠ Warning!

Replace rims or tires with the same designation, manufacturer and type as shown on the original part. For further information contact an authorized Mercedes-Benz Center. If incorrectly sized rims and tires are mounted, the wheel brakes or suspension components can be damaged. Also, the operating clearance of the wheels and the tires may no longer be correct.

#### ⚠ Warning!

Worn, old tires can cause accidents. If the tire tread is worn to minimum tread depth, or if

the tires have sustained damage, replace them.

When replacing rims, only use genuine Mercedes-Benz wheel bolts specified for the particular rim type. Failure to do so can result in the bolts loosening and possibly an accident.

Retreaded tires are not tested or recommended by Mercedes-Benz, since previous damage cannot always be recognized on retreads. The operating safety of the vehicle cannot be assured when such tires are used.

#### **Warning!**

If you feel a sudden significant vibration or ride disturbance, or you suspect that possible damage to your vehicle has occurred, you should turn on the hazard warning flashers, carefully slow down, and drive with caution to an area which is a safe distance from the road. Inspect the tires and the vehicle underbody for possible damage. If the vehicle or tires appear unsafe, have the vehicle towed to the nearest authorized Mercedes-Benz Center or tire dealer for repairs.

#### **Warning!**

Do not drive with a flat tire. A flat tire affects the ability to steer or brake the vehicle. You could lose control of the vehicle. Continued driving with a flat tire or driving at high speed with a flat tire will cause excessive heat build-up and possibly a fire.

#### **Important guidelines**

- Only use sets of tires and rims of the same type and make.
- Tires must be of the correct size for the rim.
- Break in new tires for approximately 60 miles (100 km) at moderate speeds.
- Regularly check the tires and rims for damage. Dented or bent rims can cause tire

inflation pressure loss and damage to the tire beads.

- If the vehicle is heavily loaded, check tire inflation pressure and correct as required.
- Do not allow your tires to wear down too far. Adhesion properties on wet roads are sharply reduced at tread depths of less than  $\frac{1}{8}$  in (3 mm).
- When replacing individual tires, you should mount new tires on the front wheels first (on vehicles with same-sized wheels all around).

#### **Recommended tire inflation pressure**

##### **Warning!**

Follow recommended tire inflation pressures. Do not underinflate tires. Underinflated tires wear excessively and/or unevenly, adversely affect handling and fuel economy, and are more likely to fail from being overheated.

Do not overinflate tires. Overinflated tires can adversely affect handling and ride comfort, wear unevenly, increase stopping distance, and result in sudden deflation (blowout) because they are more likely to become punctured or damaged by road debris, potholes etc.

Do not overload the tires by exceeding the specified load limit as indicated on the Tire and Loading Information placard on the driver's door B-pillar. Overloading the tires can overheat them, possibly causing a blowout. Overloading the tires can also result in handling or steering problems, or brake failure.

Your vehicle is equipped with the Tire and Loading Information placard located on the driver's door B-pillar (> page 205).

The tire inflation pressure should be checked regularly. Only adjust the tire inflation pressure on cold tires. The tires can be considered cold if the vehicle has been parked for at least 3 hours or driven less than



1 mile (1.6 km). Depending on the ambient temperature, the driving speed and the tire load, the tire temperature changes. When the tire temperature changes by 18°F (10°C), the tire inflation pressure will change by approximately 1.5 psi (0.1 bar). Keep this in mind when checking tire inflation pressure on warm tires and adjust the tire pressure only if the tire inflation pressure is too low for the current operating conditions. If you check the tire inflation pressure when the tires are warm, the reading will be higher than the cold reading. This is normal. Do not let air out to match the specified cold tire inflation pressure. Otherwise, the tire will be underinflated.

Follow recommended cold tire inflation pressures listed on Tire and Loading Information placard on the driver's door B-pillar.

Keeping the tires properly inflated provides the best handling, tread life and riding comfort.

In addition to the Tire and Loading Information placard on the driver's door B-pillar, also consult the tire inflation pressure label on the inside of the filler flap for any additional information pertaining to special driving situations. For more information, see "Important notes on tire inflation pressure" (> page 199).

**i** Data shown on Tire and Loading Information placard example are for illustration purposes only. Tire data are specific to each vehicle and may vary from data shown in the following illustration. Refer to Tire and Loading Information placard on vehicle for actual data specific to your vehicle.

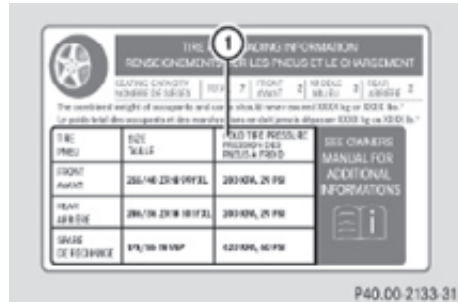

The Tire and Loading Information placard lists the recommended cold tire inflation pressures **i** for maximum loaded vehicle weight. The tire inflation pressures listed apply to the tires installed as original equipment.

### Important notes on tire inflation pressure

#### **⚠ Warning!**

If the tire inflation pressure drops repeatedly, check the tires for punctures from foreign objects and/or whether air is leaking from the valves or from around the rim.

Tire temperature and tire inflation pressure are also increased while driving, depending on the driving speed and the tire load.

If you will be driving your vehicle at high speeds of 100 mph (160 km/h) or higher, where it is legal and conditions allow, consult the tire inflation pressure label on the inside of the fuel filler flap on how to adjust the cold tire inflation pressure. If you do not adjust the tire inflation pressure, excessive heat can build up and result in sudden tire failure.

If you are not sure about the proper tire inflation, contact an authorized Mercedes-Benz Center.

**i** Driving comfort may be reduced when the tire inflation pressure is adjusted to the value for speeds above 100 mph (160 km/h) as specified on the tire inflation pressure label located on the inside of the fuel filler flap.

Make sure to readjust the tire inflation pressure for normal driving speeds. Supplemental tire inflation pressure information for different loading conditions of the vehicle can be found on the tire inflation pressure label. The tire inflation pressure label is located on the inside of the fuel filler flap.

For the tire inflation pressure for spare wheels such as Minispare wheels or spare wheels with collapsible tire refer to

- the yellow label on the spare wheel rim
- the “Technical data” section of this Operator’s Manual (▷ page 300)
- the Tire and Loading Information placard on the driver’s door B-pillar

Unless specified otherwise, the tire inflation pressures on the tire inflation pressure label are valid for all approved, factory-equipped tires. When a tire size is specified, the tire inflation pressure that follows applies to that particular tire size only.

- i** Data shown on tire inflation pressure label examples are for illustration purposes only. Tire inflation pressure data are specific to each vehicle and may vary from data shown in the following illustrations. Refer to the tire inflation pressure label on vehicle for actual data specific to your vehicle.

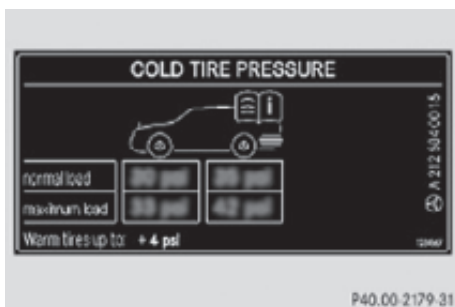

Example illustration: Tire inflation pressures for all approved, factory equipped tires

Some tire inflation pressure labels may only show the rim diameter instead of the entire tire size, e.g. **R 18** or **18"**.

The rim diameter is part of the tire size as specified on the tire sidewall (▷ page 213).

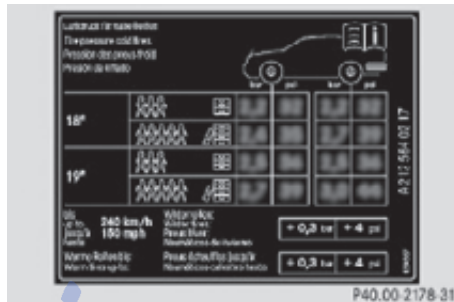

Example illustration: Tire inflation pressures specific to rim diameter

## Potential problems associated with underinflated and overinflated tires

### Underinflated tires

#### **Warning!**

Follow recommended tire inflation pressures. Do not underinflate tires. Underinflated tires wear excessively and/or unevenly, adversely affect handling and fuel economy, and are more likely to fail from being overheated.

Underinflated tires can

- cause excessive and uneven tire wear
- adversely affect fuel economy
- lead to tire failure from being overheated
- adversely affect handling characteristics

### Overinflated tires

#### **Warning!**

Follow recommended tire inflation pressures. Do not overinflate tires. Overinflated tires can adversely affect handling and ride comfort, wear unevenly, increase stopping distance, and result in sudden deflation (blowout) because they are more likely to become

punctured or damaged by road debris, potholes etc.

Overinflated tires can

- adversely affect handling characteristics
- cause uneven tire wear
- be more prone to damage from road hazards
- adversely affect ride comfort
- increase stopping distance

### Checking tire inflation pressure

#### Safety notes

##### **Warning!**

Follow recommended tire inflation pressures.

Do not underinflate tires. Underinflated tires wear excessively and/or unevenly, adversely affect handling and fuel economy, and are more likely to fail from being overheated.

Do not overinflate tires. Overinflated tires can adversely affect handling and ride comfort, wear unevenly, increase stopping distance, and result in sudden deflation (blowout) because they are more likely to become punctured or damaged by road debris, potholes etc.

Do not overload the tires by exceeding the specified load limit as indicated on the Tire and Loading Information placard on the driver's door B-pillar. Overloading the tires can overheat them, possibly causing a blowout. Overloading the tires can also result in handling or steering problems, or brake failure.

Check the tire inflation pressure at least once a month.

Check and adjust the tire inflation pressure when the tires are cold (▷ page 198).

### Checking tire inflation pressure manually

Follow the steps below to achieve correct tire inflation pressure:

- ▶ Remove the cap from the valve on one tire.
- ▶ Firmly press a tire gauge onto the valve.
- ▶ Read the tire inflation pressure on the tire gauge and check against the recommended tire inflation pressure on the Tire and Loading Information placard on the driver's door B-pillar (▷ page 205). If necessary, add air to achieve the recommended tire inflation pressure.
- ▶ If you have overfilled the tire, release tire inflation pressure by pushing the metal stem of the valve with e.g. a tip of a pen. Then recheck the tire inflation pressure with the tire gauge.
- ▶ Install the valve cap.
- ▶ Repeat this procedure for each tire.

### Advanced Tire Pressure Monitoring System (Advanced TPMS), (USA only)

Your vehicle is equipped with the Advanced Tire Pressure Monitoring System (Advanced TPMS). It measures the tire inflation pressure in the vehicle's tires and issues warnings in case of pressure loss in one or more of the tires.

The TPMS is equipped with a combination low tire pressure/ TPMS malfunction telltale in the instrument cluster. Depending on how the telltale illuminates, it indicates a low tire pressure condition or a malfunction in the TPMS system itself:

- If the telltale illuminates continuously, one or more of your tires is significantly underinflated. There is no malfunction in the TPMS.
- If the telltale flashes for 60 seconds and then stays illuminated, the TPMS system itself is not operating properly.

The TPMS only functions on wheels that are equipped with the proper electronic sensors.

 **Warning!**

The TPMS does not indicate a warning for wrongly selected inflation pressures. Always adjust tire inflation pressure according to the Tire and Loading Information placard or the supplemental tire inflation pressure information on the inside of the fuel filler flap.

The TPMS is not able to issue a warning due to a sudden dramatic loss of pressure (e.g. tire blowout caused by a foreign object). In this case bring the vehicle to a halt by carefully applying the brakes and avoiding abrupt steering maneuvers.

 **Warning!**

Each tire, including the spare (if provided), should be checked at least once a month when cold and inflated to the inflation pressure recommended by the vehicle manufacturer on the Tire and Loading Information placard on the driver's door B-pillar or the tire inflation pressure label on the inside of the fuel filler flap. If your vehicle has tires of a different size than the size indicated on the Tire and Loading Information placard or the tire inflation pressure label, you should determine the proper tire inflation pressure for those tires.

As an added safety feature, your vehicle has been equipped with a tire pressure monitoring system (TPMS) that illuminates a low tire pressure telltale when one or more of your tires are significantly underinflated.

Accordingly, when the low tire pressure telltale illuminates, you should stop and check your tires as soon as possible, and inflate them to the proper pressure. Driving on a significantly underinflated tire causes the tire to overheat and can lead to tire failure.

Underinflation also reduces fuel efficiency and tire tread life, and may affect the vehicle's handling and stopping ability. Please note that the TPMS is not a substitute for proper tire maintenance, and it is the driver's responsibility to maintain correct tire pressure, even if underinflation has not

reached the level to trigger illumination of the TPMS low tire pressure telltale.

Your vehicle has also been equipped with a TPMS malfunction indicator to indicate when the system is not operating properly. The TPMS malfunction indicator is combined with the low tire pressure telltale. When the system detects a malfunction, the telltale will flash for approximately 1 minute and then remain continuously illuminated. This sequence will continue upon subsequent vehicle start-ups as long as the malfunction exists. When the malfunction indicator is illuminated, the system may not be able to detect or signal low tire pressure as intended.





TPMS malfunctions may occur for a variety of reasons, including the installation of incompatible replacement or alternate tires or wheels on the vehicle that prevent the TPMS from functioning properly. Always check the TPMS malfunction telltale after replacing one or more tires or wheels on your vehicle to ensure that the replacement or alternate tires and wheels allow the TPMS to continue to function properly.

-  If a condition causing the TPMS to malfunction develops, it may take up to 10 minutes for the system to signal a malfunction using the TPMS telltale flashing and illumination sequence. The telltale extinguishes after a few minutes driving if the malfunction has been corrected.

Tire pressure inquiries are made using the multifunction display. The current tire inflation pressure for each tire appears in the multifunction display after a few minutes of driving.

-  Possible differences between the readings of a tire pressure gauge of an air hose, e.g. gas station equipment, and the vehicle's control system can occur. The tire pressure displayed by the control system apply to sea level. In high-altitude locations, the reading on a tire pressure

gauge will be higher than the reading issued by the vehicle's control system. Do not reduce the tire inflation pressure under such circumstances.

- ▶ Switch on the ignition.
- ▶ Press button  or  on the multifunction steering wheel repeatedly until the standard display appears in the multifunction display (▷ page 96).
- ▶ Press button  or  until the current inflation pressure for each tire appears in the multifunction display.



Example illustration

When the vehicle has been parked for longer than 20 minutes, the message Tire pressure is only displayed after driving for a few minutes. appears in the multifunction display.

The TPMS recognizes new wheels or sensors automatically after the learn-in phase. As long as the tire inflation pressure values cannot be allocated to the individual wheels, the message Tire Pressure Monitor Active Menu: R-Button appears. Despite this message, the tire inflation pressure values are monitored already.

- ▶ **i** With a spare wheel mounted, the system may still indicate the tire inflation pressure of the removed road wheel for some minutes. If this happens, keep in mind that the indicated value where the spare wheel is mounted does not reflect the actual spare tire inflation pressure.
- ▶ **i** Operating radio transmission equipment (e.g. wireless headsets, two-way radios) in or near the vehicle could cause the TPMS to malfunction.

**i** This device complies with Part 15 of the FCC Rules. Operation is subject to the following two conditions:

1. This device may not cause harmful interference, and
2. this device must accept any interference received, including interference that may cause undesired.

Any unauthorized modification to this device could void the user's authority to operate the equipment.

### Tire inflation pressure warnings

If the system detects a significant loss of tire inflation pressure in one or more than one tire, a message appears in the multifunction display. In addition, an acoustic warning sounds and the low tire pressure telltale in the instrument cluster comes on.



Example illustration

The respective tire is indicated by a red rectangle.

### Restarting Advanced TPMS





#### **Warning!**

It is the driver's responsibility to set the tire inflation pressure to the recommended cold tire inflation pressure. Underinflated tires affect the ability to steer or brake the vehicle. You might lose control over the vehicle.

When you restart the TPMS, the system sets new reference values for each tire.

The TPMS must be restarted when you have adjusted the tire inflation pressure to a new level (e.g. because of different load or driving conditions). The TPMS is then recalibrated to the current tire inflation pressures.

Restart the TPMS after adjusting the tire inflation pressure to the inflation pressure recommended for the vehicle operating condition. Tire inflation pressure should only be adjusted on cold tires. Observe the recommended tire inflation pressure on the Tire and Loading Information placard on the driver's door B-pillar. Some vehicles may have supplemental tire inflation pressure information for driving at high speeds or for vehicle loads less than the maximum loaded vehicle condition. If such information is provided, it can be found on the inside of the fuel filler flap.

- ▶ Using the Tire and Loading Information placard on the driver's door B-pillar (▷ page 205) or the supplemental tire inflation pressure information on the inside of the fuel filler flap, make sure the tire inflation pressure of all four tires is correct.
- ▶ Switch on the ignition.
- ▶ Press button  or  on the multifunction steering wheel repeatedly until the standard display appears in the multifunction display (▷ page 96).
- ▶ Press button  or  repeatedly until you see the current inflation pressures for each tire appear in the display or the following message appears in the multifunction display:  
Tire pressure is only displayed after driving for a few minutes.
- ▶ Press the reset button (▷ page 92). The following message will appear in the multifunction display:  
Restart tire pressure monitor?
- ▶ **If you wish to confirm:** Press button .  
The following message will appear in the multifunction display:  
Tire Pressure Monitor Restarted

After driving a few minutes the system verifies that the current tire inflation pressures are within the system's specified range. Afterwards the current tire inflation pressures are accepted as reference values and then monitored.

- ▶ **If you wish to cancel:** Press button .

- ❗ When the wheel positions have been changed, the inflation pressure of a tire may be displayed for the wrong position temporarily. After driving for a few minutes, the inflation pressure will be shown for the correct position.

### Maximum tire inflation pressure

#### Warning!

Never exceed the maximum tire inflation pressure. Follow recommended tire inflation pressures.

Do not underinflate tires. Underinflated tires wear excessively and/or unevenly, adversely affect handling and fuel economy, and are more likely to fail from being overheated.

Do not overinflate tires. Overinflated tires can adversely affect handling and ride comfort, wear unevenly, increase stopping distance, and result in sudden deflation (blowout) because they are more likely to become punctured or damaged by road debris, potholes etc.

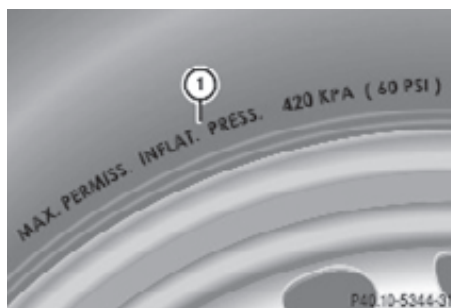

- ❗ For illustration purposes only. Actual data on tires are specific to each vehicle and

may vary from data shown in above illustration.

This is the maximum permissible tire inflation pressure ① for the tire.

Always follow the recommended tire inflation pressure (▷ page 198) for proper tire inflation.

### Loading the vehicle

Two labels on your vehicle show how much weight it may properly carry.

- (1) The Tire and Loading Information placard can be found on the driver's door B-pillar. This placard tells you important information about the number of people that can be in the vehicle and the total weight that can be carried in the vehicle. It also contains information on the proper size and recommended tire inflation pressures for the original equipment tires on your vehicle.
- (2) The certification label, also found on the driver's door B-pillar. It tells you about the gross weight capacity of your vehicle, called the Gross Vehicle Weight Rating (GVWR). The GVWR includes the weight of the vehicle, all occupants, fuel and cargo. The certification label also tells you about the front and rear axle weight capacity, called the Gross Axle Weight Rating (GAWR).

The GAWR is the total allowable weight that can be carried by a single axle (front or rear). Never exceed the GVWR or GAWR for either the front axle or rear axle.

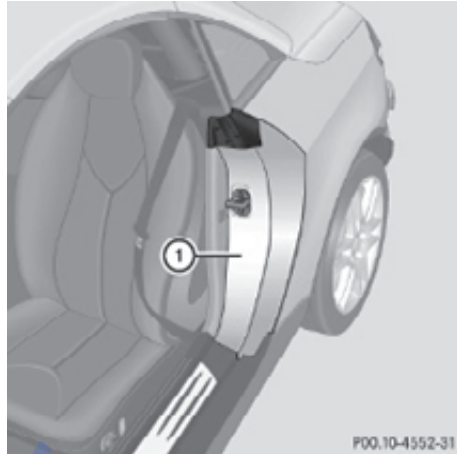

- ① Driver's door B-pillar

Following is a discussion on how to work with the information contained on the Tire and Loading Information placard with regards to loading your vehicle.

### Tire and Loading Information

#### **Warning!**

Do not overload the tires by exceeding the specified load limit as indicated on the Tire and Loading Information placard on the driver's door B-pillar. Overloading the tires can overheat them, possibly causing a blowout. Overloading the tires can also result in handling or steering problems, or brake failure.

### Tire and Loading Information placard

- i** Data shown on Tire and Loading Information placard example are for illustration purposes only. Load limit data are specific to each vehicle and may vary from data shown in the following illustration. Refer to Tire and Loading Information placard on vehicle for actual data specific to your vehicle.

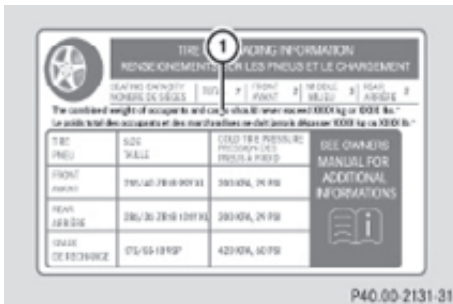

The Tire and Loading Information placard showing load limit information ① is located on the driver's door B-pillar (▷ page 205).

- ▶ Locate the statement "The combined weight of occupants and cargo should never exceed XXX kilograms or XXX lbs." on the Tire and Loading Information placard.

The combined weight of all occupants, cargo/luggage and trailer tongue load (if applicable) should never exceed the weight referenced in that statement.

### Seating capacity

- ① Data shown on Tire and Loading Information placard example are for illustration purposes only. Seating capacity data are specific to each vehicle and may vary from data shown in the following illustration. Refer to Tire and Loading Information placard on vehicle for actual data specific to your vehicle.

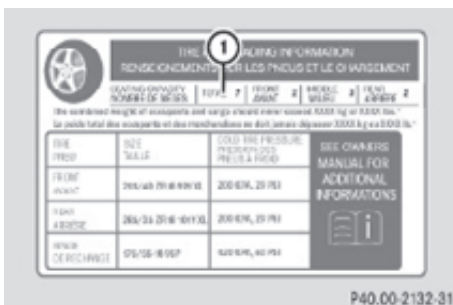

The seating capacity gives you important information on the number of occupants that

can be in the vehicle. The Tire and Loading Information placard showing seating capacity ① is located on the driver's door B-pillar (▷ page 205).

### Steps for determining correct load limit

The following steps have been developed as required of all manufacturers under Title 49, Code of U.S. Federal Regulations, Part 575 pursuant to the "National Traffic and Motor Vehicle Safety Act of 1966".

- ▶ **Step 1:** Locate the statement "The combined weight of occupants and cargo should never exceed XXX kg or XXX lbs." on your vehicle's Tire and Loading Information placard.
- ▶ **Step 2:** Determine the combined weight of the driver and passengers that will be riding in your vehicle.
- ▶ **Step 3:** Subtract the combined weight of the driver and passengers from XXX kilograms or XXX lbs.
- ▶ **Step 4:** The resulting figure equals the available amount of cargo and luggage load capacity. For example, if the "XXX" amount equals 1 400 lbs and there will be five 150 lbs passengers in your vehicle, the amount of available cargo and luggage load capacity is 650 lbs ( $1\,400 - 750 (5 \times 150) = 650$  lbs).
- ▶ **Step 5:** Determine the combined weight of luggage and cargo being loaded on the vehicle. That weight may not safely exceed the available cargo and luggage load capacity calculated in step 4.
- ▶ **Step 6 (if applicable):** If your vehicle will be towing a trailer, load from your trailer will be transferred to your vehicle. Consult this manual to determine how this reduces the available cargo and luggage load capacity of your vehicle (▷ page 208).

The following table shows examples on how to calculate total and cargo load capacities with varying seating configurations and number and size of occupants. The following



examples use a load limit of 1 500 lbs. **This is for illustration purposes only.** Make sure you are using the actual load limit for your vehicle stated on the vehicle's Tire and Loading Information placard (▷ page 206).

امداد خودرو فارما

تلفن شبانه روزی: ۰۲۱-۸۸۸۶۲۰۸۵

FarmaSOS.com

	Example 1	Example 2	
<b>Step 1</b>	<b>Combined weight limit of occupants and cargo from Tire and Loading Information placard</b>	1 500 lbs	1 500 lbs
<b>Step 2</b>	<b>Number of occupants (driver and passengers)</b>	1	2
	<b>Occupants weight</b>	Occupant 1: 175 lbs	Occupant 1: 175 lbs Occupant 2: 195 lbs
	<b>Combined weight of all occupants</b>	175 lbs	370 lbs
<b>Step 3</b>	<b>Available cargo/luggage and trailer tongue weight (total load limit from Tire and Loading Information placard minus combined weight of all occupants)</b>	1 500 lbs - 175 lbs = 1 325 lbs	1 500 lbs - 370 lbs = 1 130 lbs

The higher the weight of all occupants, the less cargo and luggage load capacity is available.

For more information, see "Trailer tongue load" (▷ page 208).

### **Certification label**

Even after careful determination of the combined weight of all occupants, cargo and the trailer tongue load (if applicable) (▷ page 208) as to not exceed the permissible load limit, you must make sure your vehicle never exceeds the Gross Vehicle Weight Rating (GVWR) and the Gross Axle Weight Rating (GAWR) for either the front or rear axle. You can obtain the GVWR and GAWR from the certification label. The certification label can be found on the driver's door B-pillar, see the "Technical data" section (▷ page 292).

**Gross Vehicle Weight Rating (GVWR):** The total weight of the vehicle, all occupants, all cargo, and the trailer tongue load (if applicable) must never exceed the GVWR.

**Gross Axle Weight Rating (GAWR):** The total allowable weight that can be carried by a single axle (front or rear).

To assure that your vehicle does not exceed the maximum permissible weight limits (GVWR and GAWR for front and rear axle), have the loaded vehicle (including driver, passengers and all cargo and, if applicable, trailer fully loaded) weighed on a suitable commercial scale.

### **Trailer tongue load**

The tongue load of any trailer is an important weight to measure because it affects the load you can carry in your vehicle. If a trailer is towed, the tongue load must be added to the weight of all occupants riding and any cargo you are carrying in the vehicle. The tongue load typically is 10% of the trailer weight and everything loaded in it.

Your Mercedes-Benz has been designed primarily to carry passengers and their cargo. Mercedes-Benz does not recommend trailer towing with your vehicle.

### Maximum tire load

#### Warning!

Do not overload the tires by exceeding the specified load limit as indicated on the Tire and Loading Information placard on the driver's door B-pillar. Overloading the tires can overheat them, possibly causing a blowout. Overloading the tires can also result in handling or steering problems, or brake failure.



**i** For illustration purposes only. Actual data on tires are specific to each vehicle and may vary from data shown in above illustration.

The maximum tire load rating **1** is the maximum weight the tires are designed to support.

For more information on tire load rating, see (▷ page 214).

For information on calculating total and cargo load capacities, see (▷ page 206).

### Direction of rotation

Unidirectional tires offer added advantages, such as better hydroplaning performance. To benefit, however, you must make sure the tires rotate in the direction specified.

An arrow on the sidewall indicates the intended direction of rotation of the tire.

Spare wheels may be mounted against the direction of rotation (spinning) even with a unidirectional tire for temporary use only until

the regular drive wheel has been repaired or replaced. Always observe and follow applicable temporary use restrictions and speed limitations indicated on the spare wheel.

### Tire care and maintenance

#### Warning!

Regularly check the tires for damage. Damaged tires can cause tire inflation pressure loss. As a result, you could lose control of your vehicle.

Worn, old tires can cause accidents. If the tire tread is worn to minimum tread depth, or if the tires have sustained damage, replace them.

Check the tire inflation pressure at least once a month. For more information on checking tire inflation pressure, see "Recommended tire inflation pressure" (▷ page 198).

### Tire inspection

Every time you check the tire inflation pressure, you should also inspect your tires for the following:

- excessive treadwear (▷ page 210)
- cord or fabric showing through the tire's rubber
- bumps, bulges, cuts, cracks or splits in the tread or side of the tire

Replace the tire if you find any of the above conditions.

Make sure you also inspect the spare tire periodically for condition and inflation. Spare tires will age and become worn over time even if never used, and thus should be inspected and replaced when necessary.

## Life of tire

### Warning!

Tires and spare tire should be replaced after 6 years, regardless of the remaining tread.

The service life of a tire is dependent upon varying factors including but not limited to:

- Driving style
- Tire inflation pressure
- Distance driven

## Tread depth

### Warning!

Although the applicable federal motor vehicle safety laws consider a tire to be worn when the treadwear indicators (TWI) become visible at approximately  $\frac{1}{16}$  in (1.6 mm), we recommend that you do not allow your tires to wear down to that level. As tread depth approaches  $\frac{1}{8}$  in (3 mm), the adhesion properties on a wet road are sharply reduced. Depending upon the weather and/or road surface (conditions), the tire traction varies widely.

Do not allow your tires to wear down too far. Adhesion properties on wet roads are sharply reduced at tread depths of less than  $\frac{1}{8}$  in (3 mm).

Treadwear indicators (TWI) are required by law. These indicators are located in six places on the tread circumference and become visible at a tread depth of approximately  $\frac{1}{16}$  in (1.6 mm), at which point the tire is considered worn and should be replaced.

The recommended minimum tire tread depth for summer tires is  $\frac{1}{8}$  in (3 mm). The recommended minimum tire tread depth for winter tires is  $\frac{1}{6}$  in (4 mm).

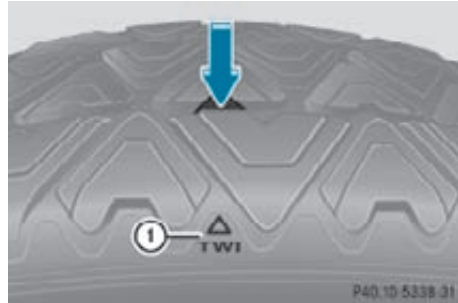

Treadwear indicator ① appears as a solid band across the tread.

## Storing tires

- ❗ Keep unmounted tires in a cool, dry place with as little exposure to light as possible. Protect tires from contact with oil, grease and fuels.

## Cleaning tires

- ❗ Never use a round nozzle to power wash tires. The intense jet of water can result in damage to the tire. Always replace a damaged tire.

## Uniform Tire Quality Grading Standards

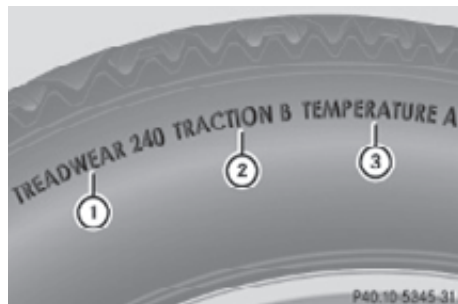

The Uniform Tire Quality Grading is a U.S. Government requirement designed to give drivers consistent and reliable information regarding tire performance. Tire manufacturers are required to grade tires

based on three performance factors: treadwear ①, traction ②, and temperature resistance ③. Although not a Government of Canada requirement, all tires made for sale in North America have these grades branded on the sidewall.

**i** For illustration purposes only. Actual data on tires are specific to each vehicle and may vary from data shown in above illustration.

Quality grades can be found, where applicable, on the tire sidewall between tread shoulder and maximum section width. For example:

Treadwear	Traction	Temperature
200	AA	A

All passenger car tires must conform to federal safety requirements in addition to these grades.

### Treadwear

The treadwear grade is a comparative rating based on the wear rate of the tire when tested under controlled conditions on a specified U.S. Government test course. For example, a tire graded 150 would wear one and one-half ( $1 \frac{1}{2}$ ) times as well on the government course as a tire graded 100.

The relative performance of tires depends upon the actual conditions of their use, however, and may depart significantly from the norm due to variations in driving habits, service practices and differences in road characteristics and climate.

### Traction

#### Warning!

The traction grade assigned to this tire is based on straight-ahead braking traction tests, and does not include acceleration,

cornering, hydroplaning, or peak traction characteristics.

The traction grades, from highest to lowest, are AA, A, B, and C. Those grades represent the tire's ability to stop on wet pavement as measured under controlled conditions on specified government test surfaces of asphalt and concrete. A tire marked C may have poor traction performance.

#### Warning!

If ice has formed on the road, tire traction will be substantially reduced. Under such weather conditions, drive, steer and brake with extreme caution.

The safe speed on a wet, snow covered or icy road is always lower than on a dry road.

You should pay particular attention to the condition of the road whenever the outside temperature is close to the freezing point. Mercedes-Benz recommends winter tires (> page 219) with a minimum tread depth of approximately  $\frac{1}{8}$  in (4 mm) on all four wheels for the winter season to ensure normal balanced handling characteristics. On packed snow, they can reduce your stopping distance compared to summer tires. Stopping distance, however, is still considerably greater than when the road is not covered with snow or ice. Exercise appropriate caution.

**!** Avoid spinning of a drive wheel. This may cause serious damage to the drivetrain which is not covered by the Mercedes-Benz Limited Warranty.

### Temperature

#### Warning!

The temperature grade for this tire is established for a tire that is properly inflated and not overloaded. Excessive speed, underinflation, or excessive loading, either separately or in combination, can cause

excessive heat build-up and possible tire failure.

The temperature grades are A (the highest), B, and C, representing the tire's resistance to the generation of heat and its ability to dissipate heat when tested under controlled conditions on a specified indoor laboratory test wheel. Sustained high temperature can cause the material of the tire to degenerate and reduce tire life, and excessive temperature can lead to sudden tire failure. The grade C corresponds to a level of performance which all passenger car tires must meet under the Federal Motor Vehicle Safety Standard No. 109. Grades B and A represent higher levels of performance on the laboratory test wheel than the minimum required by law.

### Rotating tires

#### **Warning!**

Rotate front and rear wheels only if the tires are of the same dimension.

If your vehicle is equipped with mixed-size tires (different tire dimensions front vs. rear), tire rotation is not possible.

#### **Warning!**

Have the tightening torque checked after changing a wheel. The wheels could come loose if they are not tightened to a torque of 80 lb-ft (110 Nm).

Only use genuine Mercedes-Benz wheel bolts specified for your vehicle's rims.

Tire rotation can be performed on vehicles with tires of the same dimension all around. If your vehicle is equipped with tires of the same dimension all around, tires can be rotated, observing a front-to-rear rotation pattern that will maintain the intended rotation (spinning) direction of the tire (> page 209).

In some cases, such as when your vehicle is equipped with mixed-size tires (different tire

dimension front vs. rear), tire rotation is not possible.

If applicable to your vehicle's tire configuration, tires can be rotated according to the tire manufacturer's recommended intervals in the tire manufacturer's warranty pamphlet located in your vehicle literature portfolio. If none is available, tires should be rotated every 3 000 to 6 000 miles (5 000 to 10 000 km), or sooner if necessary, according to the degree of tire wear. The same rotation (spinning) direction must be maintained.

Rotate tires before the characteristic tire wear pattern becomes visible (shoulder wear on front tires and tread center wear on rear tires).

Thoroughly clean the mounting face of wheels and brake disks, i.e. the inner side of the wheels/tires, during each rotation. Check for and ensure proper tire inflation pressure.

For information on wheel change, see "Flat tire" (> page 273).

### Tire labeling

Besides tire name (sales designation) and manufacturer name, a number of markings can be found on a tire.

Following are some explanations for the markings on your vehicle's tires:

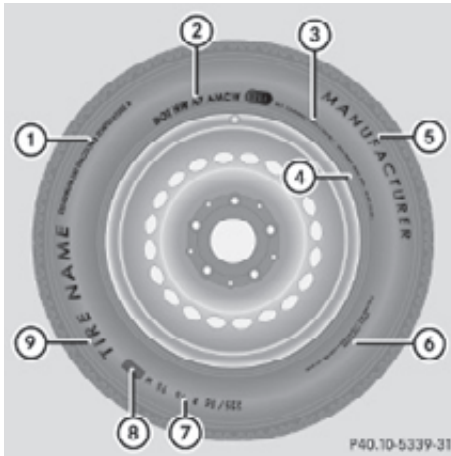

- ① Uniform Tire Quality Grading Standards (▷ page 210)
- ② DOT, Tire Identification Number (▷ page 216)
- ③ Maximum tire load (▷ page 209)
- ④ Maximum tire inflation pressure (▷ page 204)
- ⑤ Manufacturer
- ⑥ Tire ply material (▷ page 217)
- ⑦ Tire size designation, load and speed rating (▷ page 213)
- ⑧ Load identification (▷ page 216)
- ⑨ Tire name

**i** For illustration purposes only. Actual data on tires are specific to each vehicle and may vary from data shown in above illustration.

For more information, see “Rims and tires” (▷ page 297).

## Tire size designation, load and speed rating

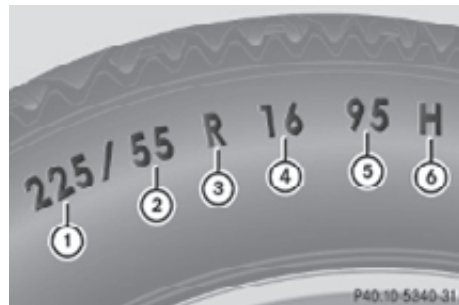

- ① Tire width
- ② Aspect ratio in %
- ③ Radial tire code
- ④ Rim diameter
- ⑤ Load index
- ⑥ Speed symbol

**i** For illustration purposes only. Actual data on tires are specific to each vehicle and may vary from data shown in above illustration.

General: Depending on the design standards used, the tire size molded into the sidewall may have no letter or a letter preceding the tire size designation.

No letter preceding the size designation (as illustrated above): Passenger car tire based on European design standards.

Letter “P” preceding the size designation: Passenger car tire based on U.S. design standards.

Letter “LT” preceding the size designation: Light Truck tire based on U.S. design standards.

Letter “T” preceding the size designation: Temporary spare tires which are high pressure compact spares designed for temporary emergency use only.

### Tire width

Tire width ① indicates the nominal tire width in millimeters.

**Aspect ratio**

Aspect ratio ② is the dimensional relationship between tire section height and section width and is expressed in percentage. The aspect ratio is arrived at by dividing section height by section width.

**Tire code**

Tire code ③ indicates the tire construction type. The “R” stands for radial tire type. Letter “D” means diagonal or bias ply construction; letter “B” means belted-bias ply construction.

At the tire manufacturer’s option, any tire with a speed capability above 149 mph (240 km/h) can include a “ZR” in the size designation (for example: 245/40 ZR 18). For additional information, see “Tire speed rating” (▷ page 214).

**Rim diameter**

Rim diameter ④ is the diameter of the bead seat, not the diameter of the rim edge. The rim diameter is indicated in inches (in).

**Load index****⚠ Warning!**

The tire load rating must always be at least half of the GAWR of your vehicle. Otherwise, tire failure may be the result which may cause an accident and/or serious injury to you or others.

Always replace rims and tires with the same designation, manufacturer and type as shown on the original part.

**⚠ Warning!**

Do not overload the tires by exceeding the specified load limit as indicated on the Tire and Loading Information placard on the driver’s door B-pillar. Overloading the tires can overheat them, possibly causing a blowout. Overloading the tires can also result in handling or steering problems, or brake failure.

Load index ⑤ is a numerical code associated with the maximum load a tire can support.

For example, a load rating of 91 corresponds to a maximum load of 1356 lb (615 kg) the tire is designed to support. See also “Maximum tire load” (▷ page 209) where the maximum load associated with the load index is indicated in kilograms and lbs.

For additional information on the load index, see “Load identification” (▷ page 216).

**Speed symbol****⚠ Warning!**

Even when permitted by law, never operate a vehicle at speeds greater than the maximum speed rating of the tires.

Exceeding the maximum speed for which tires are rated can lead to sudden tire failure, causing loss of vehicle control and possibly resulting in an accident and/or serious personal injury and possible death, for you and for others.

Regardless of the tire speed rating, local speed limits should be obeyed. Use prudent driving speeds appropriate to prevailing conditions.

Speed symbol ⑥ indicates the approved maximum speed (tire speed rating) for the tire.

Summer tires

Index	Speed rating
Q	up to 100 mph (160 km/h)
R	up to 106 mph (170 km/h)
S	up to 112 mph (180 km/h)
T	up to 118 mph (190 km/h)
H	up to 130 mph (210 km/h)
V	up to 149 mph (240 km/h)
W	up to 168 mph (270 km/h)
Y	up to 186 mph (300 km/h)
ZR...Y	up to 186 mph (300 km/h)



Index	Speed rating
ZR...(Y)	above 186 mph (300 km/h)
ZR	above 149 mph (240 km/h)

- At the tire manufacturer's option, any tire with a speed capability above 149 mph (240 km/h) can include a "ZR" in the size designation (for example: 245/40 ZR18). To determine the maximum speed capability of the tire, the service description for the tire must be referred to. The service description is comprised of load index ⑤ and speed symbol ⑥.

If your tire includes "ZR" in the size designation and no service description is given, the tire manufacturer must be consulted for the maximum speed capability.

If a service description is given, the speed capability is limited by the speed symbol in the service description. Example: 245/40 ZR18 97Y. In this example, "97Y" is the service description. The letter "Y" designates the speed rating and the speed capability of the tire is limited to 186 mph (300 km/h).

- Any tire with a speed capability above 186 mph (300 km/h) must include a "ZR" in the size designation AND the service description must be placed in parenthesis. Example: 275/40 ZR 18 (99Y). The "(Y)" speed symbol in parenthesis designates the maximum speed capability of the tire as being above 186 mph (300 km/h). Consult the tire manufacturer for the actual maximum permissible speed of the tire.

#### All-season and winter tires

Index	Speed rating
Q M+S <sup>15</sup>	up to 100 mph (160 km/h)
T M+S <sup>15</sup>	up to 118 mph (190 km/h)

Index	Speed rating
H M+S <sup>15</sup>	up to 130 mph (210 km/h)
V M+S <sup>15</sup>	up to 149 mph (240 km/h)

- Not all M+S rated tires provide special winter performance. Make sure the tires you use show M+S and the mountain/snowflake  marking on the tire sidewall. These tires meet specific snow traction performance requirements of the Rubber Manufacturers Association (RMA) and the Rubber Association of Canada (RAC) and have been designed specifically for use in snow conditions.

An electronic speed limiter prevents your vehicle from exceeding a speed of:

- 149 mph (240 km/h):
  - SLK 300
  - SLK 300 (Sport Package)
  - SLK 300 (Appearance Package)
  - SLK 350 تلفن شیبا
  - SLK 350 (Sport Package)
  - SLK 350 (Appearance Package)
- 155 mph (250 km/h):
  - SLK 55 AMG
- 174 mph (280 km/h):
  - SLK 55 AMG (Performance Package)

The factory equipped tires on your vehicle may have a tire speed rating above the maximum speed permitted by the electronic speed limiter.

Make sure your tires have the required tire speed rating as specified for your vehicle in the "Technical data" section (▷ page 297), for example when purchasing new tires.

If you are uncertain about the correct reading of the information given on a tire's sidewall,

<sup>15</sup> or M+S  for winter tires

any authorized Mercedes-Benz Center will be glad to assist you.

### Load identification



**i** For illustration purposes only. Actual data on tires are specific to each vehicle and may vary from data shown in above illustration.

In addition to the load index, special load identification ① may be molded into the tire sidewall following the letter designating the speed symbol ⑥ (▷ page 213).

- No specification given: absence of any text (like in above example) indicates a standard load (SL) tire.
- XL or Extra Load: designates an extra load (or reinforced) tire.
- Light Load: designates a light load tire.
- C, D, E: designates load range associated with the maximum load a tire can carry at a specified pressure.

### DOT, Tire Identification Number (TIN)

U.S. tire regulations require each new tire manufacturer or tire retreader to mold a TIN into or onto a sidewall of each tire produced.



The TIN is a unique identifier. The TIN facilitates efforts by tire manufacturers to notify purchasers in recall situations or other safety matters concerning tires. It gives purchasers the means to easily identify such tires.

The TIN is comprised of “Manufacturer’s identification mark” ②, “Tire size” ③, “Tire type code” ④ and “Date of manufacture” ⑤.

**i** For illustration purposes only. Actual data on tires are specific to each vehicle and may vary from data shown in above illustration.

### DOT (Department of Transportation)

Tire branding symbol ① denotes that the tire meets requirements of the U.S. Department of Transportation.

### Manufacturer’s identification mark

Manufacturer’s identification mark ② denotes the tire manufacturer.

New tires have a mark with two symbols.

Retreaded tires have a mark with four symbols. For more information on retreaded tires, see (▷ page 197).

### Tire size

Code ③ indicates the tire size.

### Tire type code

Tire type code ④ may, at the option of the manufacturer, be used as a descriptive code for identifying significant characteristics of the tire.

### Date of manufacture

The date of manufacture ⑤ identifies the week and year of manufacture.

The first two figures identify the week, starting with “01” to represent the first full week of the calendar year. The second two figures represent the year.

For example, “3208” represents the 32nd week of 2008.

### Tire ply material

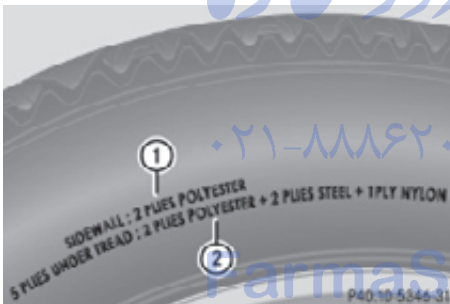

**i** For illustration purposes only. Actual data on tires are specific to each vehicle and may vary from data shown in above illustration.

This marking tells you about the type of cord and number of plies in the sidewall ① and under the tread ②.

### Tire and loading terminology

#### Accessory weight

The combined weight (in excess of those standard items which may be replaced) of automatic transmission, power steering, power brakes, power windows, power seats,

radio, and heater, to the extent that these items are available as factory-installed equipment (whether installed or not).

#### Air pressure

The amount of air inside the tire pressing outward on each square inch of the tire. Air pressure is expressed in pounds per square inch (psi), kilopascal (kPa), or bar.

#### Aspect ratio

Dimensional relationship between tire section height and section width expressed in percentage.

#### Bar

Metric unit for air pressure. There are 14.5038 pounds per square inch (psi) to 1 bar; there are 100 kilopascals (kPa) to 1 bar.

#### Bead

The tire bead contains steel wires wrapped by steel cords that hold the tire onto the rim.

#### Cold tire inflation pressure

Tire inflation pressure when your vehicle has been sitting for at least 3 hours or driven no more than 1 mile (1.6 km).

#### Curb weight

The weight of a motor vehicle with standard equipment including the maximum capacity of fuel, oil, and coolant, and, if so equipped, air conditioning and additional optional equipment, but without passengers and cargo.

#### DOT (Department of Transportation)

A tire branding symbol which denotes the tire meets requirements of the U.S. Department of Transportation.

### **GAWR (Gross Axle Weight Rating)**

The GAWR is the maximum permissible axle weight. The gross vehicle weight on each axle must never exceed the GAWR for the front and rear axle indicated on the certification label located on the driver's door B-pillar.

### **GVW (Gross Vehicle Weight)**

The GVW comprises the weight of the vehicle including fuel, tools, spare wheel, installed accessories, passengers and cargo and, if applicable, trailer tongue load. The GVW must never exceed the GVWR indicated on the certification label located on the driver's door B-pillar.

### **GVWR (Gross Vehicle Weight Rating)**

This is the maximum permissible vehicle weight of the fully loaded vehicle (weight of the vehicle including all options, passengers, fuel, and cargo and, if applicable, trailer tongue load). It is indicated on the certification label located on the driver's door B-pillar.

### **Kilopascal (kPa)**

Metric unit for air pressure. There are 6.9 kPa to 1 psi; another metric unit for air pressure is bar. There are 100 kilopascals (kPa) to 1 bar.

### **Load index**

Numerical code associated with the maximum load a tire can support.

### **Maximum load rating**

The maximum load in kilograms and pounds that can be carried by the tire.

### **Maximum loaded vehicle weight**

The sum of curb weight, accessory weight, total load limit, and production options weight.

### **Maximum permissible tire inflation pressure**

This number is the greatest amount of air pressure that should ever be put in the tire.

### **Normal occupant weight**

The number of occupants the vehicle is designed to seat, multiplied by 68 kilograms (150 lb).

### **Occupant distribution**

The distribution of occupants in a vehicle at their designated seating positions.

### **Production options weight**

The combined weight of those installed regular production options weighing over 5 lbs (2.3 kilograms) in excess of those standard items which they replace, not previously considered in curb weight or accessory weight, including heavy duty brakes, ride levelers, roof rack, heavy duty battery, and special trim.

### **PSI (Pounds per square inch)**

A standard unit of measure for air pressure.

### **Recommended tire inflation pressure**

The recommended tire inflation pressure for normal driving conditions is listed on the Tire and Loading Information placard located on the driver's door B-pillar. It provides best handling, tread life and riding comfort. Supplemental information pertaining to special driving situations can be found on the tire inflation pressure label on the inside of the fuel filler flap.

### **Rim**

A metal support for a tire or a tire and tube assembly upon which the tire beads are seated.

### Sidewall

The portion of a tire between the tread and the bead.

### TIN (Tire Identification Number)

Unique identifier which facilitates efforts by tire manufacturers to notify purchasers in recall situations or other safety matters concerning tires and gives purchasers the means to easily identify such tires. The TIN is comprised of "Manufacturer's identification mark", "Tire size", "Tire type code" and "Date of manufacture".

### Tire ply composition and material used

This indicates the number of plies or the number of layers of rubber-coated fabric in the tire tread and sidewall. Tire manufacturers also must indicate the ply materials in the tire and sidewall, which include steel, nylon, polyester, and others.

### Tire speed rating

Part of tire designation (speed symbol); indicates the speed range for which a tire is approved.

### Total load limit

Rated cargo and luggage load plus 68 kilograms (150 lb) times the vehicle's designated seating capacity.

### Traction

The adhesive friction of a tire on a surface on which it moves. The amount of grip provided.

### Tread

The portion of a tire that comes into contact with the road.

### Treadwear indicators

Narrow bands, sometimes called "wear bars" that show across the tread of a tire when only  $\frac{1}{16}$  in (1.6 mm) of tread remains.

### Uniform Tire Quality Grading Standards

A tire information system that provides consumers with ratings for a tire's traction, temperature and treadwear. Ratings are determined by tire manufacturers using U.S. government testing procedures. The ratings are molded into the sidewall of the tire.

### Vehicle maximum load on the tire

Load on an individual tire that is determined by distributing to each axle its share of the maximum loaded vehicle weight and dividing it by two.

## Winter driving

### General information

Have your vehicle winterized at an authorized Mercedes-Benz Center.

### Winter tires

#### Warning!

Winter tires with a tread depth of less than  $\frac{1}{8}$  in (4 mm) must be replaced. They are no longer suitable for winter operation.

#### Warning!

If you use your spare wheel when winter tires are fitted on the other wheels, be aware that the difference in tire characteristics may very well impair turning stability and that overall driving stability may be reduced. Adapt your driving style accordingly.

Have the spare wheel replaced by a regular road wheel with a winter tire at the nearest authorized Mercedes-Benz Center.

Always use winter tires at temperatures below 45°F (7°C) and whenever wintry road conditions prevail. Not all M+S rated tires provide special winter performance. Make sure the tires you use show the mountain/snowflake  marking on the tire sidewall. These tires meet specific snow traction performance requirements of the Rubber Manufacturers Association (RMA) and the Rubber Association of Canada (RAC) and have been designed specifically for use in snow conditions. Use of winter tires is the only way to achieve the maximum effectiveness of your vehicle's driving safety systems such as the ABS and the ESP® in winter operation.

For safe handling, make sure all mounted winter tires are of the same make and have the same tread design.

For information on winter tires for your vehicle model, see the "Technical data" section (▷ page 297).

Always observe the speed rating of the winter tires installed on your vehicle.

### Snow chains

**!** Some tire sizes do not leave adequate clearance for snow chains. To help avoid serious damage to your vehicle or tires, make sure the use of snow chains is permissible as specified in the "Technical data" section of this Operator's Manual.

Snow chains should only be driven on snow-covered roads at speeds not to exceed 30 mph (50 km/h). Remove chains as soon as possible when driving on roads without snow.

Observe the following guidelines when using snow chains:

- Use of snow chains is not permissible with all wheel/tire combinations (▷ page 297).
- Use snow chains in pairs and on rear wheels only. Follow the manufacturer's mounting instructions.

**!** If snow chains are mounted to the front wheels, they may scrape against the body or axle components. The tires or the vehicle could be damaged as a result.

- Only use snow chains that are approved by Mercedes-Benz. Any authorized Mercedes-Benz Center will be glad to advise you on this subject.
- Use of snow chains may be prohibited depending on location. Always check local and state laws before installing snow chains.
- Do not use snow chains on the spare wheel.

**i** When driving with snow chains, you may wish to switch off the ESP® (▷ page 49) before setting the vehicle in motion. This will improve the vehicle's traction.

### Winter driving instructions

#### Warning!

If the vehicle becomes stuck in snow, make sure snow is kept clear of the exhaust pipe and from around the vehicle with the engine running. Otherwise, deadly carbon monoxide (CO) gases may enter vehicle interior resulting in unconsciousness and death. To assure sufficient fresh air ventilation, open a window slightly on the side of the vehicle not facing the wind.

#### Warning!

The outside temperature indicator is not designed to serve as an ice-warning device and is therefore unsuitable for that purpose. Indicated temperatures just above the freezing point do not guarantee that the road surface is free of ice. The road may still be icy, especially in wooded areas or on bridges.

#### Warning!

On slippery road surfaces, never downshift in order to obtain braking action. This could result in drive wheel slip and reduced vehicle

control. Your vehicle's ABS will not prevent this type of loss of control.

The most important rule for slippery or icy roads is to drive sensibly and to avoid abrupt acceleration, braking and steering maneuvers. Do not use the cruise control system under such conditions.

When the vehicle is in danger of skidding, shift the automatic transmission to neutral position **N** or declutch in case of manual transmission. Try to keep the vehicle under control by corrective steering action.

**i** For information on driving with snow chains, see "Snow chains" (▷ page 220).

Road salts and chemicals can adversely affect braking efficiency. Increased pedal force may become necessary to produce the normal brake effect.

Depressing the brake pedal periodically when traveling at length on salt-strewn roads can bring road-salt-impaired braking efficiency back to normal.

If the vehicle is parked after being driven on salt-treated roads, the braking efficiency should be tested as soon as possible after driving is resumed.

**Warning!**

Make sure not to endanger any other road users when carrying out these braking maneuvers.

**Driving instructions**

**Drive sensibly – save fuel**

To save fuel you should:

- Keep tires at the recommended inflation pressures.
- Remove unnecessary loads.
- Allow engine to warm up under low load use.

- Avoid frequent acceleration and deceleration.
- Have all maintenance work performed at the intervals specified in the Maintenance Booklet and as required by the Maintenance system. Contact an authorized Mercedes-Benz Center.

Fuel consumption is also increased by driving in cold weather, in stop-and-go traffic, on short trips and in mountainous areas.

**Drinking and driving**

**Warning!**

Drinking and driving and/or taking drugs and driving are very dangerous combinations. Even a small amount of alcohol or drugs can affect your reflexes, perceptions and judgment.

The possibility of a serious or even fatal accident are greatly increased when you drink or take drugs and drive.

Do not drink or take drugs and drive or allow anyone to drive who has been drinking or taking drugs.

**Pedals**

**Warning!**

Make sure absolutely no objects are obstructing the pedals' range of movement. Keep the driver's footwell clear of all obstacles. If there are any floor mats or carpets in the footwell, make sure that the pedals still have sufficient clearance.

During sudden driving or braking maneuvers, the objects could get caught between the pedals. You could then no longer brake or accelerate. This could lead to accidents and injury.

### Power assistance

#### Warning!

There is no power assistance for the steering and the brake when the engine is not running. Steering and braking requires significantly more effort and you could lose control of the vehicle and cause an accident as a result.

Do not turn off the engine while the vehicle is in motion.

### Brakes

#### Downhill grades

**!** When driving down long and steep grades, relieve the load on the brakes by shifting into a lower gear to use the engine's braking power. This helps prevent overheating of the brakes and reduces wear.

When using the engine's braking power, a drive wheel may not spin for an extended period of time, e.g. on slippery road surfaces. This may cause serious damage to the drivetrain which is not covered by the Mercedes-Benz Limited Warranty.

#### Continuous or hard braking

#### Warning!

Resting your foot on the brake pedal will cause excessive and premature wear of the brake pads.

It can also result in the brakes overheating, thereby significantly reducing their effectiveness. It may not be possible to stop the vehicle in sufficient time to avoid an accident.

After hard braking, it is advisable to drive on for some time, rather than immediately park, so that the air stream will cool down the brakes faster.

### Wet roads

#### Warning!

After driving in heavy rain for some time without applying the brakes or through water deep enough to wet brake components, the first braking action may be somewhat reduced and increased pedal pressure may be necessary to obtain expected brake effect. Maintain a safe distance from vehicles in front.

To help prevent brake disk corrosion after driving on wet or salt-covered roads, it is advisable to brake the vehicle with considerable force prior to parking. The heat generated serves to dry the brakes.

### Salt-covered roads

#### Warning!

A layer of salt on the brake discs and the brake linings may cause a delay in the braking effect, resulting in a significantly increased braking distance, which could lead to an accident.

To avoid this danger, you should:

- occasionally brake carefully when you are driving on salt-covered roads, so that any layer of salt that may have built up on the brake discs and the brake linings is removed without putting other road users at risk
- maintain a greater distance to the vehicle ahead and drive with particular care
- carefully apply the brakes at the end of a trip and immediately after commencing a new trip, so that salt residues are removed from the brake disc

### Brake service

**!** The brake fluid level in the reservoir may be too low if the brake warning lamp in the instrument cluster comes on and an acoustic warning sounds although the



parking brake is released. Observe additional messages in the multifunction display that may appear.

Brake pad wear or a leak in the system may be the reason for low brake fluid in the reservoir.

Have the brake system inspected immediately. Contact an authorized Mercedes-Benz Center.

All checks and service work on the brake system should be carried out by qualified technicians only. Contact an authorized Mercedes-Benz Center.

Only install brake pads and use brake fluid recommended by Mercedes-Benz.

 **Warning!**

If other than recommended brake pads are installed, or other than recommended brake fluid is used, the braking properties of the vehicle can be degraded to an extent that safe braking is substantially impaired. This could result in an accident.

**!** Because the ESP® operates automatically, the engine and ignition must be shut off (SmartKey in starter switch position **0** or **1**) when the parking brake is being tested on a brake test dynamometer or when the vehicle is being towed with the front axle raised.

Active braking action through the ESP® may otherwise seriously damage the brake system which is not covered by the Mercedes-Benz Limited Warranty.

If your brake system is only subjected to moderate loads, you should occasionally test the effectiveness of the brakes by applying above-normal braking pressure at higher speeds. This will also enhance the grip of the brake pads.

 **Warning!**

Make sure not to endanger any other road users when carrying out these braking maneuvers.

Refer to the description of the Brake Assist System (BAS) (▷ page 49).

### High-performance brake system

The high-performance brake system is only available on SLK 55 AMG.

 **Warning!**

New vehicle brake pads and discs, and replacement brake pads and discs may take several hundred miles of driving until they provide optimum braking efficiency. Until that time, you may need to use increased brake pedal pressure while braking. Please be aware of this and adjust your driving and braking accordingly during this break-in period.

Excessive high-demand braking will cause correspondingly high brake wear. Please be attentive to the brake warning lamp in the instrument cluster and brake condition messages in the multifunction display. Especially for high performance driving, it is important to maintain and have the brake system checked regularly.

The high-performance brake system is designed to operate under the extremely high operating demands required to accommodate the performance capabilities of the vehicle.

The brakes may produce a squeaking-type noise depending on the

- vehicle speed
- brake force applied
- ambient conditions, e.g. temperature and humidity

As with any brake system, the wear of individual brake system components such as brake pads or disks strongly depends on your driving style and the conditions under which you operate the vehicle. Thus, a driving style calling for high-demand braking will cause your vehicle's brakes to wear more quickly.

### Driving off

Warm up the engine smoothly. Do not place full load on the engine until the operating temperature has been reached.

❗ When driving off on a slippery surface, do not allow a drive wheel to spin for an extended period with the ESP® switched off. Doing so may cause serious damage to the drivetrain which is not covered by the Mercedes-Benz Limited Warranty.

❗ Simultaneously depressing the accelerator pedal and applying the brakes reduces engine performance and causes premature brake and drivetrain wear which is not covered by the Mercedes-Benz Limited Warranty.

### Hydroplaning

Depending on the depth of the water layer on the road, hydroplaning may occur, even at low speeds and with new tires. In heavy rain or when conditions indicate possible hydroplaning:

- ▶ Reduce vehicle speed.
- ▶ Avoid track grooves in the road.
- ▶ Apply brakes cautiously.

### Standing water

❗ Do not drive through flooded areas. Before driving through water, determine its depth.

If you must drive through standing water, drive slowly to prevent water from entering the passenger compartment or the engine compartment. Water in these areas could cause damage to electrical components or wiring of the engine or transmission, or could result in water being ingested by the engine through the air intake causing severe internal engine damage. Any such

damage is not covered by the Mercedes-Benz Limited Warranty.

### Driving abroad

If you plan to drive the vehicle outside the U.S. or Canada, you should request dealer network information for your destination from any authorized Mercedes-Benz Center.

### Control and operation of radio transmitter

#### Safety notes

##### ⚠ Warning!

Please do not forget that your primary responsibility is to drive the vehicle. A driver's attention to the road must always be his/her primary focus when driving. For your safety and the safety of others, we recommend that you pull over to a safe location and stop before placing or taking a telephone call.

If you choose to use the telephone<sup>16</sup> while driving, please use the hands-free device and only use the telephone when road, weather and traffic conditions permit. Some jurisdictions prohibit the driver from using a mobile telephone while driving a vehicle.

Only operate the audio system or COMAND<sup>16</sup> (Cockpit Management and Data System) if road, weather and traffic conditions permit. Otherwise, you may not be able to observe traffic conditions and could endanger yourself and others.

Bear in mind that at a speed of just 30 mph (approximately 50 km/h), your vehicle is covering a distance of 44 feet (approximately 14 m) every second.

<sup>16</sup> Observe all legal requirements.

### Emission control

Certain systems of the engine serve to keep the toxic components of the exhaust gases within permissible limits required by law.

These systems will function properly only when maintained strictly according to factory specifications. Any adjustments on the engine should, therefore, be carried out only by qualified Mercedes-Benz Center authorized technicians.

Engine adjustments should not be altered in any way. Moreover, the specified service procedures must be carried out regularly according to Mercedes-Benz servicing requirements. For details refer to the Maintenance Booklet.

#### Warning!

Inhalation of exhaust gas is hazardous to your health. All exhaust gas contains carbon monoxide (CO), and inhaling it can cause unconsciousness and possible death.

Do not run the engine in confined areas (such as a garage) which are not properly ventilated. If you think that exhaust gas fumes are entering the vehicle while driving, have the cause determined and corrected immediately. If you must drive under these conditions, drive only with at least one window fully open at all times.

### Maintenance

#### Notes

The Maintenance System in your vehicle tracks the distance driven and the time elapsed since the last maintenance service. It calculates other maintenance service work required, and calls for the next maintenance service accordingly.

We strongly recommend that you have your vehicle serviced at an authorized Mercedes-Benz Center. Have it serviced in accordance with the Maintenance Booklet at the times

called for by the maintenance service indicator.

-  Failure to have the vehicle maintained in accordance with the Maintenance Booklet and maintenance service indicator at the designated times/mileage will result in vehicle damage not covered by the Mercedes-Benz Limited Warranty.

#### Maintenance service indicator message

Information on maintenance work and maintenance intervals are specified in the Maintenance Booklet. Contact an authorized Mercedes-Benz Center, or visit [www.mbusa.com](http://www.mbusa.com) (USA only) for additional information.

The maintenance service indicator message will notify you when the next maintenance service is required.

Starting approximately 1 month before the next maintenance service is required, one of the following messages will appear in the multifunction display. The messages will appear while you are driving or when you switch on the ignition (example service A):

- Service A Due In XXXX Miles (Km)
- Service A Due In XX Days
- Service A Due In X Day
- Service A Due Now



Refer to Maintenance Booklet for a listing of maintenance services and intervals they need to be performed at.

### Clearing the maintenance service indicator message

The maintenance service indicator message is cleared automatically

- after approximately 10 seconds when you switch on the ignition
- after approximately 10 seconds when reaching the service threshold while driving
- after approximately 30 seconds, once the suggested maintenance service term has passed

- ▶ **Clearing the maintenance service indicator message manually:** Press reset button  on the instrument cluster. The standard display appears in the multifunction display.

### Maintenance service term exceeded

If you have exceeded the suggested maintenance service term, you will see the following message in the multifunction display:

Service A Exceeded By XXXXX Miles (Km)

Service A Exceeded By XXX Days

Service A Exceeded By X Day





In addition, a signal sounds when the message appears.

Any authorized Mercedes-Benz Center will reset the maintenance service indicator following a completed maintenance service.

### Calling up the maintenance service indicator display

- ▶ **i** The menu overview can be found on (> page 96).

You can call up the maintenance service indicator display at any time to check when the next maintenance service is required.

- ▶ Switch on the ignition.
- ▶ Press button  or  on the multifunction steering wheel repeatedly until the standard display (> page 96) appears in the multifunction display.
- ▶ Press button  or  on the multifunction steering wheel until the maintenance service indicator display with the service symbol  and the maintenance service deadline appears in the multifunction display.

- ▶ **i** If the battery was disconnected, the days of disconnection will not be included in the count shown by the maintenance service indicator. To arrive at the true maintenance service deadline, you will need to subtract these days from the days shown in the maintenance service indicator message or maintenance service indicator display.

Do not confuse the maintenance service indicator with the engine oil level indicator .

### Resetting the maintenance service indicator

In the event that the maintenance service on your vehicle is not carried out at an authorized Mercedes-Benz Center, you can have the maintenance service indicator reset.

The automotive maintenance facility carrying out the maintenance service will find the information for resetting the maintenance service indicator in the maintenance-relevant literature for your vehicle.

Such literature is available at any authorized Mercedes-Benz Center or directly from Mercedes-Benz.

- ▶ **!** If the maintenance service indicator was reset inadvertently, have an authorized Mercedes-Benz Center correct it.

Only reset the maintenance service indicator if the proper maintenance service has been performed. Not following the proper maintenance service as described

in the Maintenance Booklet will result in engine damage and/or other vehicle damage not covered by the Mercedes-Benz Limited Warranty.

## Vehicle care

### Cleaning and care of the vehicle

#### Notes

Regular and proper care will help to maintain the value of your vehicle.

#### **Warning!**

Many cleaning products can be hazardous. Some are poisonous, others are flammable. Always follow the instructions on the particular container. Always open your vehicle's doors or windows when cleaning the inside.

Never use fluids or solvents that are not designed for cleaning your vehicle.

Always lock away cleaning products and keep them out of reach of children.

- !** When cleaning the vehicle, do not use scouring agents. Never apply strong force and only use a soft, wet cloth or sponge. Otherwise you may scratch or damage the surface to be cleaned.

While in operation, even while parked, your vehicle is subjected to varying external influences which, if gone unchecked, can attack the paintwork as well as the vehicle underbody and cause lasting damage.

Such damage is caused not only by extreme and varying climatic conditions, but also by:

- Air pollution
- Road salt
- Tar
- Gravel and stone chipping

To avoid paint damage, you should immediately remove:

- Grease and oil
- Fuel
- Coolant
- Brake fluid
- Bird droppings
- Insects
- Tree resins etc.

Frequent washing reduces and/or eliminates the aggressiveness and potency of the above adverse influences.

More frequent washings are necessary to deal with unfavorable conditions:

- near the ocean
- in industrial areas (smoke, exhaust emissions)
- during winter operation

You should check your vehicle from time to time for stone chipping or other damage. Any damage should be repaired as soon as possible to prevent corrosion.

In doing so, do not neglect the underbody of the vehicle. A prerequisite for a thorough check is a washing of the underbody followed by a thorough inspection. Damaged areas need to be re-undercoated.

Your vehicle has been treated at the factory with a wax-base rustproofing in the body cavities which will last for the lifetime of the vehicle. Post-production treatment is neither necessary nor recommended by Mercedes-Benz because of the possibility of incompatibility between materials used in the production process and others applied later.

We have selected vehicle-care products and compiled recommendations which are specially matched to our vehicles and which always reflect the latest technology. You can obtain Mercedes-Benz approved vehicle-care products at an authorized Mercedes-Benz Center.

Scratches, corrosive deposits, corrosion or damage due to negligent or incorrect care cannot always be removed or repaired with the vehicle-care products recommended here. In such cases it is best to seek aid at an authorized Mercedes-Benz Center.

The following topics deal with the cleaning and care of your vehicle and give important "how-to" information as well as references to Mercedes-Benz approved vehicle-care products.

### Power washer

**!** Follow the instructions provided by the power washer manufacturer on maintaining a distance between the vehicle and the nozzle of the power washer.

Never use a round nozzle to power-wash tires. The intense jet of water can result in damage to the tire.

Always replace a damaged tire.

Always keep the jet of water moving across the surface. Do not aim directly at electrical parts, electrical connectors, seals, or other rubber parts.

### Tar stains

Quickly remove tar stains before they dry and become more difficult to remove. A tar remover is recommended.

### Paintwork, painted body components

**!** Affixing stickers, magnets, adhesive tape or similar materials to painted body components may damage the paintwork.

Mercedes-Benz approved Paint Care should be applied when water drops on the paint surface do not "bead up". This should normally be done every 3 to 5 months, depending on the climate and washing detergent used.

Mercedes-Benz approved Paint Cleaner should be applied if the paint surface shows signs of embedded dirt (i.e. loss of gloss).

Do not apply any of these products or wax if your vehicle is parked in the sun or if the hood is still hot.

- ▶ Use the appropriate MB-Touch-Up Stick for quick and provisional repairs of minor paint damage (i.e. chips from stones, vehicle doors, etc.).

### Engine cleaning

Prior to cleaning the engine compartment, make sure to protect electrical components and connectors from contact with water and cleaning agents.

Corrosion protection, such as MB Anticorrosion Wax should be applied to the engine compartment after every engine cleaning. Before applying, all control linkage bushings and joints should be lubricated. The poly-V-belt and all pulleys should be protected from any wax.

### Vehicle washing

In the winter, thoroughly remove all traces of road salt as soon as possible.

When washing the vehicle underbody, do not forget to clean the inner sides of the wheels.

### Hand-wash

- ▶ Do not use hot water or wash your vehicle in direct sunlight.
- ▶ Only use a soft, wet cloth or sponge to clean the vehicle.
- ▶ Only use a mild vehicle wash detergent, such as Mercedes-Benz approved Car Shampoo.
- ▶ Thoroughly spray the vehicle with a diffused jet of water.
- ▶ Do not spray directly towards the ventilation intake.
- ▶ Use plenty of water and rinse the sponge and chamois frequently.
- ▶ Rinse with clean water and dry with a chamois thoroughly.

Do not allow cleaning agents to dry on the finish.

### Automatic car wash

You can have your vehicle washed in an automatic car wash from the start. Brushless car washes are preferable.

- ▶ To protect the filter system, activate the air recirculation mode using button  on the climate control panel.

**!** Do not clean your vehicle in an automatic touchless car wash which uses caustic spray. Caustic spray will damage the paint or ornamental moldings.

If the vehicle is very dirty, prewash it before running it through the automatic car wash.

**!** Make sure the combination switch is set to wiper setting **0**. Otherwise, the rain sensor could activate and cause the wipers to move unintentionally. This may lead to vehicle damage.

Due to the width of the vehicle, fold in exterior rear view mirrors prior to running the vehicle through an automatic car wash to prevent damage to the mirrors.

Vehicles with automatic transmission:

#### ▶ When taking the vehicle through an automatic conveyor-type car wash:

Make sure the automatic transmission remains in neutral position **N**.

When leaving the automatic car wash, make sure the mirrors are folded out.

After running the vehicle through an automatic car wash, wipe any wax off of the windshield and the wiper blade inserts. This will prevent smears and reduce wiping noise which can be caused by residual wax on the windshield.

### Ornamental moldings

- ▶ For regular cleaning and care of ornamental moldings, use a damp cloth.

**!** Do not use chrome cleaner on ornamental moldings. Although ornamental moldings may have chrome appearance, they could be made of anodized aluminum that will be damaged when cleaned with chrome cleaner. Instead, use a damp cloth to clean those ornamental moldings.

For very dirty ornamental moldings of which you are sure are chrome-plated, use a chrome cleaner. If in doubt whether an ornamental molding is chrome-plated, contact an authorized Mercedes-Benz Center.

### Headlamps, brake lamps, tail lamps, side markers, turn signal lenses

- ▶ Use a mild vehicle wash detergent, such as Mercedes-Benz approved Car Shampoo, with plenty of water.

**!** Only use window cleaning solutions that are suitable for plastic lamp lenses. Window cleaning solutions which are not suitable may damage the plastic lamp lenses of the headlamps. Therefore, do not use abrasives, solvents or cleaners that contain solvents.

### Cleaning the windows and the wiper blades



**!** The windshield wipers must be in a vertical position before folding them away from the windshield. They could otherwise damage the hood.

Never open the hood when the wiper arms are folded forward.

- ▶ Make sure the hood is fully closed.
- ▶ Switch on the ignition.
- ▶ Turn combination switch to wiper setting **II** (▷ page 76).
- ▶ With wiper arms in vertical position, switch off the ignition.

 **Warning!**

For safety reasons, switch off wipers and remove SmartKey from starter switch before cleaning the windshield and/or the wiper blades. Otherwise, the wiper motor could suddenly turn on and cause injury.

-  Do not pull on the wiper blade inserts. They could tear.
- ▶ Fold the wiper arms forward until they snap into place.
- ▶ Clean the windshield and the wiper blade inserts with a clean cloth and mild detergent solution.
- ▶ Use a soft, clean cloth and a mild window cleaning solution on all outside and inside glass surfaces.  
An automotive glass cleaner is recommended.
-  Fold the windshield wiper arms back onto the windshield before turning the SmartKey in the starter switch.  
Hold on to the wiper when folding the wiper arm back. If released, the force of the impact from the tensioning spring could crack the windshield.
-  To clean the window interior, do not use a dry cloth, abrasives, solvents or cleaners containing solvents. Do not touch the inside of the windows with hard objects such as an ice scraper or ring. Doing so may damage the windows.

### Rear window cleaning

Clean the rear window with the hardtop fully raised and closed.



 **Warning!**

Do not clean the rear window with the hardtop in a position other than the fully raised and closed position. Otherwise, the hardtop may move unexpectedly which may result in personal injury to you or others.

- ▶ Use a soft, clean cloth and a mild window cleaning solution on all outside and inside glass surfaces.  
An automotive glass cleaner is recommended.

### Light alloy wheels

If possible, clean wheels once a week.

- ▶ Use Mercedes-Benz approved Wheel Care, a soft bristle brush and a strong spray of water for cleaning the light alloy wheels.
-  Only use acid-free cleaning materials. Acid may cause corrosion or damage the clear coat.
-  The vehicle should not be parked for an extended period of time immediately after it has been cleaned. This applies especially after the wheel rims have been cleaned with wheel rim cleaner. Wheel rim cleaners can lead to increased corrosion of the brake disks and brake pads. Non-approved wheel cleaners may also damage the wheel paint if the vehicle is not driven after cleaning.  
Therefore, the vehicle's brake system should always be warmed-up before it is parked after cleaning. Drive your vehicle for several minutes to allow the brakes to dry. When applying Mercedes-Benz approved Tire Care and Mercedes-Benz approved Wheel Care products, take care not to spray them on the brake disks.

### Plastic and rubber parts

- ▶ Use a gentle dishwashing detergent or mild detergent for delicate fabrics as a washing solution.
- ▶ Wipe with a cloth moistened in a lukewarm solution.  
The surface may temporarily change color. If this is the case, wait for it to dry.



 **Warning!**

Do not use cleaners or cockpit care sprays containing solvents to clean the cockpit or the steering wheel. Cleaners containing solvents will make the surface porous and vehicle occupants could suffer serious injuries from plastic parts coming loose in the event of air bag deployment.

- ❗ Do not use oil, wax or scouring agents. Otherwise you may scratch or damage the surface.

**Hard plastic trim items**

- ▶ Use Mercedes-Benz approved Interior Care on a soft, lint-free cloth and apply with light pressure.

**Audio or COMAND display**

- ❗ You must switch off the audio or COMAND display and allow it to cool prior to cleaning.
- ❗ Do not use any liquids or cleaning agents. These can damage or even destroy the audio or COMAND display screen.
- ▶ Use a standard microfiber cloth and apply with light pressure.

**Steering wheel and gearshift/gear selector lever**

- ▶ Wipe with a damp cloth and dry thoroughly or clean with Mercedes-Benz approved Leather Care.

**Carpets**

- ▶ Use Mercedes-Benz approved Carpet and Fabric Care for cleaning the carpets.

**Headliner**

- ▶ Use a soft bristle brush or a dry-shampoo cleaner in case of excessive dirt.

**Seat belts**

- ▶ Only use clear, lukewarm water and soap.
- ❗ The seat belts must not be treated with chemical cleaning agents. Do not dry the seat belts at temperatures above 176°F (80°C) or in direct sunlight.

 **Warning!**

Do not bleach or dye seat belts as this may severely weaken them. In a crash they may not be able to provide adequate protection.

**Upholstery**

Using aftermarket seat covers or wearing clothing that have the tendency to give off coloring (e.g. when wet, etc.) may cause the upholstery to become permanently discolored. By lining the seats with a proper intermediate cover, contact-discoloration will be prevented.

 **Warning!**

Only use seat covers which have been tested and approved by Mercedes-Benz for your vehicle model. Using other seat covers may interfere with or prevent the deployment of the head-thorax air bags. Contact an authorized Mercedes-Benz Center for availability.

**Leather upholstery**

Please note that leather upholstery is a natural product and is therefore subject to a natural aging process. Leather upholstery may also react to certain ambient influences such as high humidity or high temperature by showing wrinkles for example.

- ▶ Wipe leather upholstery with a damp cloth and dry thoroughly or clean with Mercedes-Benz approved Leather Care.
- ❗ To avoid damage to leather upholstery:
  - Wipe with light pressure only.
  - Do not clean with abrasive cleaning agents such as scouring milk or powder.

- Do not soak the leather upholstery.  
As leather is a natural product, it could otherwise harden or become porous.
- Exercise particular care when cleaning perforated leather as its underside should not become wet.

### Wood trims

- ▶ Only use water and a damp cloth to clean wood trims in your vehicle.

**!** Do not use solvents like tar remover or wheel cleaner nor polishes or waxes as these may be abrasive.

### Chrome-plated exhaust tip

Regular cleaning and care of chrome-plated exhaust tips will help to maintain their shine and the classy appearance.

- ▶ Use Mercedes-Benz approved Chrome Polishing Paste each time the vehicle has been washed, especially during the winter.

**!** Do not use alkaline cleaners such as wheel cleaners as they could cause corrosion.

<b>Vehicle equipment</b> .....	234
<b>Where will I find ...?</b> .....	234
<b>Vehicle status messages in the multifunction display</b> .....	236
<b>What to do if ...</b> .....	256
<b>Unlocking/locking manually</b> .....	264
<b>Opening/closing manually</b> .....	266
<b>Replacing SmartKey batteries</b> .....	266
<b>Replacing bulbs</b> .....	267
<b>Replacing wiper blades</b> .....	271
<b>Flat tire</b> .....	273
<b>Battery</b> .....	282
<b>Jump starting</b> .....	283
<b>Towing the vehicle</b> .....	285
<b>Fuses</b> .....	288

امداد خودرو فارما

تلفن شبانه روزی: ۰۲۱-۸۸۸۶۲۰۸۵

FarmaSOS.com



### Vehicle equipment

- i** This Operator's Manual describes all features, standard or optional, potentially available for your vehicle at the time of purchase. Please be aware that your vehicle might not be equipped with all features described in this manual.

### Where will I find ...?

#### First aid kit

- i** Check expiration dates and contents for completeness at least once a year and replace missing/expired items.

The first aid kit is located in a parcel net behind the driver's seat.

#### Vehicle tool kit

The vehicle tool kit is located in the space underneath the trunk floor.

- i** Vehicles without spare wheel are not factory-equipped with the tools required for a wheel change such as a jack or a wheel wrench. Some tools required for a wheel change are specific to your vehicle. Contact an authorized Mercedes-Benz Center to obtain the tools approved for your vehicle.

- ▶ **Removing:** Open the trunk (▷ page 59).
- ▶ Lift the trunk floor.
- ▶ Remove the spare wheel (if so equipped) (▷ page 235).

### Vehicles with spare wheel

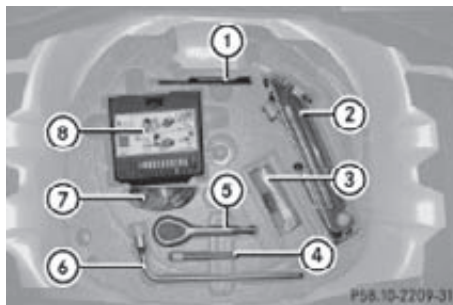

- ① Collapsible wheel chock
- ② Jack
- ③ Protective wrap
- ④ Alignment bolt
- ⑤ Towing eye bolt
- ⑥ Wheel wrench
- ⑦ Valve extractor
- ⑧ Electric air pump

### Vehicles with TIREFIT

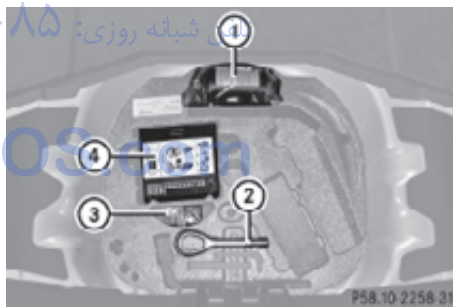

- ① TIREFIT kit
- ② Towing eye bolt
- ③ Valve extractor
- ④ Electric air pump

### Collapsible wheel chock

The collapsible wheel chock serves to secure the vehicle, e.g. while changing a wheel.

- ▶ Take the collapsible wheel chock from the vehicle tool kit (▷ page 234).

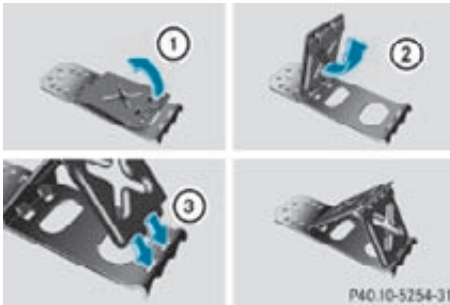

- ▶ **Setting up:** Tilt both plates upward ①.
- ▶ Fold the lower plate outward ②.
- ▶ Guide the tabs of the lower plate all the way into the openings of base plate ③.

For information on where to place wheel chocks when changing a wheel, see “Lifting the vehicle” (▶ page 277).

### Jack

#### **Warning!**

Only use the jack supplied with your vehicle to lift the vehicle briefly for wheel changes. If you use the jack for any other purpose, you or others could be injured, as the jack is designed only for the purpose of changing a wheel.

When using the jack, observe the safety notes in the “Mounting the spare wheel” section and the notes on the jack.

- ▶ Take the jack from the vehicle tool kit (▶ page 234).

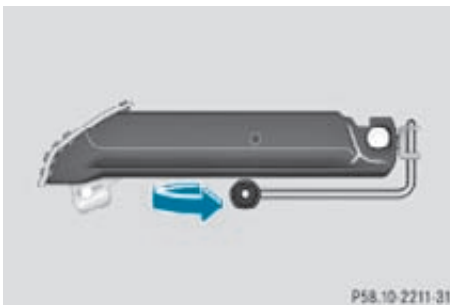

Storage position

- ▶ Turn the crank handle in the direction of arrow as far as it will go.

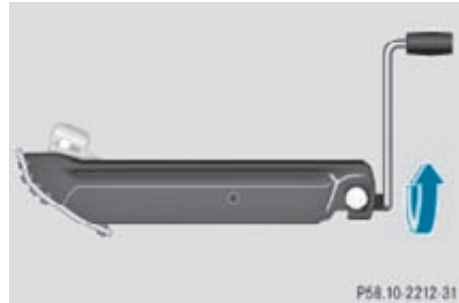

Operational position

- ▶ Turn the crank handle clockwise.
- ▶ Before placing the jack back into the vehicle tool kit:
  - ▶ Fully collapse the jack.
  - ▶ Fold in the crank handle (storage position).

### Spare wheel

#### **Observe Safety notes, see page 273.**

The spare wheel is located in the space underneath the trunk floor.

- ▶ **Removing:** Open the trunk (▶ page 59).
- ▶ Lift the trunk floor.

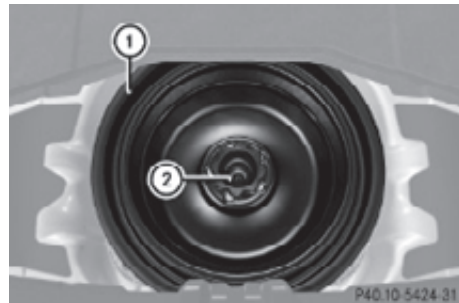

- ▶ Remove retaining screw ② by turning it counterclockwise.
- ▶ Remove spare wheel ①.

The spare wheel bolts are located under a plastic cover on the outside of the spare wheel rim.

- ▶ Take off the spare wheel bolts.

For information on mounting the spare wheel, see “Flat tire” (▷ page 273).

### Storing the spare wheel after use

If you wish to store the spare wheel after use, carry out the following steps. Otherwise, the spare wheel may not fit into the spare wheel well.

- ❗ Make sure the spare wheel is dry before storing it.
- ▶ Take the valve extractor from the vehicle tool kit (▷ page 234).
- ▶ Unscrew the valve cap from the valve of the collapsible tire.
- ▶ Use the valve extractor to unscrew the valve insert from the valve.
- ▶ Allow the air to escape.
- ❗ It may take a few minutes for the collapsible tire to deflate completely.
- ▶ Use the valve extractor to screw the valve insert back into the valve.
- ▶ Screw the valve cap back onto the valve.
- ▶ Place the valve extractor back into the vehicle tool kit.
- ▶ Take the protective wrap from the vehicle tool kit.
- ▶ Pull the protective wrap over the spare wheel.
- ▶ Place the spare wheel into the spare wheel well.
- ▶ Pierce the protective wrap with retaining screw ②.
- ▶ Secure the spare wheel by turning retaining screw ② clockwise.

### Practical hints

## Vehicle status messages in the multifunction display

### Notes





Warning and malfunction messages appear in the multifunction display located in the instrument cluster.





Certain warning and malfunction messages are accompanied by an audible signal.

Address these messages accordingly and follow the additional instructions given in this Operator's Manual.

Selecting the **Vehicle status message memory** menu in the control system (▷ page 101) displays both cleared and uncleared messages.

High-priority messages appear in the multifunction display in red color.

Certain messages of high priority cannot be cleared from the multifunction display using the reset button (R) (▷ page 92) or button , ,  or  on the multifunction steering wheel.

Other messages of high priority and messages of less immediate priority can be cleared from the multifunction display using the reset button (R) or button , ,  or  on the multifunction steering wheel. They are then stored in the **Vehicle status message memory** menu (▷ page 101). Remember that clearing a message will only make the message disappear. Clearing a message will not correct the condition that caused the message to appear.

### Warning!

All categories of messages contain important information which should be taken note of and, where a malfunction is indicated, addressed as soon as possible at an authorized Mercedes-Benz Center.

Failure to repair the condition noted may cause damage not covered by the Mercedes-

## Vehicle status messages in the multifunction display

237

Benz Limited Warranty, or result in property damage or personal injury.

### **Warning!**

No messages will be displayed if either the instrument cluster or the multifunction display is inoperative.

As a result, you will not be able to see information about your driving conditions, such as

- speed
- outside temperature
- warning/indicator lamps

- malfunction/warning messages
- failure of any systems

Driving characteristics may be impaired.

If you must continue to drive, do so with added caution. Contact an authorized Mercedes-Benz Center as soon as possible.

On the pages that follow, you will find a compilation of the most important warning and malfunction messages that may appear. For your convenience the messages are divided into text messages (▷ page 237) and symbol messages (▷ page 243).

### Text messages



#### Safety systems

Display messages		Possible causes/consequences and ► Solutions
ABS	ABS, ESP Inoperative See Operator's Manual	<p>The brake system is still functioning normally but due to a malfunction, the ABS, the BAS, and the ESP® are unavailable.</p> <ul style="list-style-type: none"> <li>► Continue driving with added caution. Wheels may lock during hard braking, reducing steering capability.</li> <li>► Have the system checked at an authorized Mercedes-Benz Center as soon as possible.</li> </ul> <p>Failure to follow these instructions increases the risk of an accident.</p>
ESP	ESP Inoperative See Operator's Manual	<p>The brake system is still functioning normally but due to a malfunction the ESP® is unavailable.</p> <p>The BAS may not be operational.</p> <ul style="list-style-type: none"> <li>► Continue driving with added caution. Wheels may lock during hard braking, reducing steering capability.</li> <li>► Have the system checked at an authorized Mercedes-Benz Center as soon as possible.</li> </ul> <p>Failure to follow these instructions increases the risk of an accident.</p>

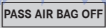

Practical hints

Display messages		Possible causes/consequences and ► Solutions
ESP	ESP Unavailable See Operator's Manual	<p>The brake system still functions normally but due to insufficient power supply the ESP® is unavailable. The BAS may not be operational.</p> <ul style="list-style-type: none"> <li>► Continue driving with added caution. Wheels may lock during hard braking, reducing steering capability.</li> </ul> <p>When the voltage is above the required value again, the ESP® is operational again and the message in the multifunction display should disappear.</p> <p>If the message in the multifunction display does not disappear:</p> <ul style="list-style-type: none"> <li>► Have the alternator and the battery checked.</li> <li>► Have the system checked at an authorized Mercedes-Benz Center as soon as possible.</li> </ul>
ESP	ESP Unavailable See Operator's Manual	<p>The ESP® is temporarily not available. The self-diagnosis may not be completed yet. The BAS may not be operational.</p> <p>The brake system is still functioning normally but without the systems specified above available.</p> <ul style="list-style-type: none"> <li>► Drive a short distance with added caution at a vehicle speed of above 12 mph (20 km/h). When the message disappears, the ESP® is available again.</li> </ul> <p>If the message does not disappear:</p> <ul style="list-style-type: none"> <li>► Continue driving with added caution. Wheels may lock during hard braking, reducing steering capability.</li> <li>► Have the system checked at an authorized Mercedes-Benz Center as soon as possible.</li> </ul> <p>Failure to follow these instructions increases the risk of an accident.</p>



Display messages	Possible causes/consequences and ► Solutions
Front-passenger Airbag Enabled See Operator's Manual	<p>The passenger front air bag and the passenger-side knee bag are activated while driving even though a child, small individual, or object below the system's weight threshold is on the passenger seat, or the passenger seat is empty. Objects on the seat or forces acting on the seat may make the system sense supplemental weight.</p> <ul style="list-style-type: none"> <li>► Stop the vehicle in a safe location as soon as possible.</li> <li>► Engage the parking brake.</li> <li>► Switch off the ignition.</li> <li>► Open the passenger door.</li> <li>► Remove child and child restraint from passenger seat.</li> <li>► Make sure no objects which apply supplemental weight to the seat are present. The system may recognize such supplemental weight and sense that an occupant on the passenger seat is of a greater weight than actually present.</li> <li>► Keep the seat unoccupied, close the passenger door and switch on the ignition.</li> </ul> <p>Monitor the  indicator lamp in the center console (► page 39) and the multifunction display in the instrument cluster (► page 26) for the following:</p> <p>With the seat unoccupied and the ignition switched on,</p> <ul style="list-style-type: none"> <li>• the  indicator lamp in the center console should illuminate and remain illuminated, indicating that the OCS (► page 37) has deactivated the passenger front air bag and the passenger-side knee bag.</li> <li>• the message Front-passenger Airbag Enabled See Operator's Manual or the message Front-passenger Airbag Disabled See Operator's Manual should not appear in the multifunction display at any time the seat is unoccupied. Wait at least 60 seconds for the system to complete the necessary check cycles and to make sure neither message appears in the multifunction display.</li> </ul> <p>If above conditions are met, you can occupy the passenger seat again. Depending on the passenger classification sensed by the OCS, the  indicator lamp will remain illuminated or go out.</p> <p>If above conditions are not met, the system is not working properly. Have the system checked at an authorized Mercedes-Benz Center as soon as possible.</p>

 **Warning!**



If the   indicator lamp remains out even after performing the above corrective steps, do not have any children 12 years old and under and other small individuals use the passenger seat until the system has been repaired.

**Display messages****Possible causes/consequences and ► Solutions**



Front-  
passenger  
Airbag  
Disabled  
See  
Operator's  
Manual



The passenger front air bag and the passenger-side knee bag are deactivated while driving even though an adult or someone larger than a small individual is occupying the passenger seat. Forces acting on the seat may make the system sense a decrease in weight.

- Stop the vehicle in a safe location as soon as possible.
- Engage the parking brake.
- Switch off the ignition.
- Have the passenger vacate the seat and exit the vehicle.
- Keep the seat unoccupied, close the passenger door and switch on the ignition.

Monitor the   indicator lamp in the center console (► page 39) and the multifunction display in the instrument cluster (► page 26) for the following:

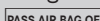

With the seat unoccupied and the ignition switched on,

- the   indicator lamp in the center console should illuminate and remain illuminated, indicating that the OCS (► page 37) has deactivated the passenger front air bag and the passenger-side knee bag.
- the message Front-passenger Airbag Enabled See Operator's Manual or the message Front-passenger Airbag Disabled See Operator's Manual should not appear in the multifunction display at any time the seat is unoccupied. Wait at least 60 seconds for the system to complete the necessary check cycles and to make sure neither message appears in the multifunction display.

If above conditions are met, you can occupy the passenger seat again. Depending on the passenger classification sensed by the OCS, the   indicator lamp will remain illuminated or go out.

If above conditions are not met, the system is not working properly. Have the system checked at an authorized Mercedes-Benz Center as soon as possible.

 **Warning!**

If the   indicator lamp remains illuminated with an adult occupant on the passenger seat even after performing the above corrective steps, do not have any passenger use the passenger seat until the system has been repaired.

**Driving systems**

Display messages		Possible causes/consequences and ► Solutions
Cruise Control	Inoperative	The cruise control is malfunctioning. ► Have the cruise control checked at an authorized Mercedes-Benz Center.
Cruise Control	- - - MPH	One of the activation conditions for cruise control has not been fulfilled. You may have attempted to set a speed below 20 mph (30 km/h). ► Drive faster than 20 mph (30 km/h) if the situation allows and set the speed. ► Check the activation conditions for cruise control (► page 160).

Practical hints

**Vehicle**

Display messages		Possible causes/consequences and ► Solutions
Close Rear Side	Windows	You are getting out of the vehicle and a rear side window is still open. ► Close the rear side window (► page 79).

**Tires**

Display messages		Possible causes/consequences and ► Solutions
Tire pressure displayed only after	driving for a few minutes.	The tire inflation pressure is being checked by the Advanced TPMS. ► Drive the vehicle for a few minutes.
Tire Pressure Monitor	Inoperative	The Advanced TPMS is malfunctioning. ► Have the Advanced TPMS checked at an authorized Mercedes-Benz Center.

Display messages		Possible causes/consequences and ► Solutions
Tire Pressure Monitor	Inoperative No Wheel Sensors	<p>There are wheels without appropriate wheel sensors mounted (e.g. winter tires).</p> <ul style="list-style-type: none"> <li>► Have the Advanced TPMS checked at an authorized Mercedes-Benz Center.</li> <li>► Have the appropriate wheel sensors installed at an authorized Mercedes-Benz Center.</li> </ul>
Tire Pres. Monitor	Whl. Sens. Miss.	<p>At least one sensor is defect (e.g. battery is empty). The respective tire is indicated by - - instead of the tire inflation pressure in the multifunction display.</p> <ul style="list-style-type: none"> <li>► Have the Advanced TPMS checked at an authorized Mercedes-Benz Center.</li> <li>► Have the wheel sensors installed at an authorized Mercedes-Benz Center.</li> </ul>
		<p>At least one wheel without appropriate wheel sensors is mounted (e.g. spare wheel). The respective tire is indicated by - - instead of the tire inflation pressure in the multifunction display.</p> <ul style="list-style-type: none"> <li>► Have the Advanced TPMS checked at an authorized Mercedes-Benz Center.</li> <li>► Have the wheel sensors installed at an authorized Mercedes-Benz Center.</li> </ul>
Tire Pressure Monitor	Currently Unavailable	<p>The Advanced TPMS cannot monitor the tire inflation pressure due to a nearby radio interference source or insufficient power supply.</p> <p>As soon as the causes of the malfunction have been rectified, the Advanced TPMS becomes active again automatically after a few minutes of driving.</p>
Please correct the tire pressure.		<p>The tire inflation pressure is too low in at least one tire. or The tire inflation pressures of the individual tires differ from each other significantly. The tire inflation pressure values are shown in the multifunction display.</p> <ul style="list-style-type: none"> <li>► Check and correct tire inflation pressure as required (► page 201).</li> <li>► Restart the Advanced TPMS (► page 203).</li> </ul>

Display messages	Possible causes/consequences and ► Solutions
Caution Tire Defect	At least one tire is deflating. The respective tire is indicated in the multifunction display. ► Carefully bring the vehicle to a halt, avoiding abrupt steering and braking maneuvers. ► If necessary, change the wheel (▷ page 273).
Check Tires	The tire inflation pressure in at least one tire is significantly below the reference value. The respective tire is indicated in the multifunction display. ► Carefully bring the vehicle to a halt, avoiding abrupt steering and braking maneuvers. ► Check and adjust tire inflation pressure as required. ► If necessary, change the wheel (▷ page 273).

 **Warning!**

Do not drive with a flat tire. A flat tire affects the ability to steer or brake the vehicle. You may lose control of the vehicle. Continued driving with a flat tire will cause excessive heat build-up and possibly a fire.

 **Warning!**





Follow recommended tire inflation pressures:  
Do not underinflate tires. Underinflated tires wear excessively and/or unevenly, adversely affect handling and fuel economy, and are more likely to fail from being overheated.  
Do not overinflate tires. Overinflated tires can adversely affect handling and ride comfort, wear unevenly, increase stopping distance, and result in sudden deflation (blowout) because they are more likely to become punctured or damaged by road debris, potholes etc.

**Symbol messages**

**Brake**

Display messages	Possible causes/consequences and ► Solutions
 Brake Wear	The brake pads have reached their wear limit. ► Have the brake pads replaced as soon as possible at an authorized Mercedes-Benz Center.

 Brake pad thickness must be visually inspected by a qualified technician at the intervals specified in the Maintenance Booklet.

Display messages	Possible causes/consequences and ► Solutions
 (USA only)  (Canada only)	Release Parking Brake  You are driving with the parking brake engaged. In addition an acoustic warning sounds. ► Release the parking brake.
 (USA only)  (Canada only)	Check Brake Fluid Level  There is insufficient brake fluid in the reservoir. Risk of accident! ► Stop the vehicle in a safe location or as soon as it is safe to do so. ► Engage the parking brake. ► Do <b>not</b> drive any further. ► Contact an authorized Mercedes-Benz Center or call Roadside Assistance. Do not add brake fluid! This will not solve the problem.

Practical hints



 **Warning!**

Driving with the message Check Brake Fluid Level displayed can result in an accident. Have your brake system checked immediately.

Do not add brake fluid before checking the brake system. Overfilling the brake fluid reservoir can result in spilling brake fluid on hot engine parts and the brake fluid catching fire. You can be seriously burned.

- !** If you find that the brake fluid in the brake fluid reservoir has fallen to the minimum mark or below, have the brake system checked for brake pad thickness and leaks.

Safety systems

Display messages	Possible causes/consequences and ► Solutions
 <p>Tele Aid Inoperative</p>	<p>One or more main functions of the Tele Aid system are malfunctioning.</p> <ul style="list-style-type: none"> <li>► Have the Tele Aid system checked at an authorized Mercedes-Benz Center.</li> </ul>
 <p>Restraint System Malfunction Service Required</p>	<p>There is a malfunction in the Supplemental Restraint System (SRS). The air bags or the Emergency Tensioning Devices (ETDs) could deploy unexpectedly or fail to activate in an accident.</p> <ul style="list-style-type: none"> <li>► Drive with added caution to the nearest authorized Mercedes-Benz Center and have the system checked immediately.</li> </ul>

 **Warning!**



In the event a malfunction of the SRS is indicated as outlined above, the SRS may not be operational.







For your safety, we strongly recommend that you contact an authorized Mercedes-Benz

Center immediately to have the system checked. Otherwise the SRS may not be activated when needed in an accident, which could result in serious or fatal injury, or it might deploy unexpectedly and unnecessarily which could also result in injury.

Practical hints

Vehicle



Display messages	Possible causes/consequences and ► Solutions
	<p>The trunk is open.</p> <ul style="list-style-type: none"> <li>► Close the trunk (► page 60).</li> </ul>
	<p>You are driving with the hood open.</p> <ul style="list-style-type: none"> <li>► Stop the vehicle in a safe location as soon as it is safe to do so.</li> <li>► Close the hood (► page 193).</li> </ul> <p>There is otherwise danger of an accident.</p>
	<p>You are driving with at least one door open.</p> <ul style="list-style-type: none"> <li>► Close all doors.</li> </ul>

Display messages		Possible causes/consequences and ► Solutions
	Retractable Roof Operation Please Wait	<p>The on-board voltage is too low.</p> <ul style="list-style-type: none"> <li>► Repeat the opening or closing procedure.</li> <li>► Start the engine.</li> </ul> <p>The hardtop drive system was shut down for safety reasons after multiple, consecutive attempts to raise or lower the hardtop.</p> <p>After about 10 minutes you can open or close the retractable hardtop.</p> <ul style="list-style-type: none"> <li>► Switch on the ignition.</li> <li>► Repeat the opening or closing procedure.</li> <li>► If the retractable hardtop still does not open or close properly, have the hardtop system checked at an authorized Mercedes-Benz Center.</li> </ul>
	Retractable Roof Lowering	<p>The retractable hardtop is not completely opened or closed. The roof hydraulics will start to lose pressure.</p> <ul style="list-style-type: none"> <li>► Make sure the retractable hardtop is completely opened or closed (► page 170).</li> </ul>
	Retractable Roof Operation Only At Standstill	<p>You have attempted to open the retractable hardtop while driving.</p> <ul style="list-style-type: none"> <li>► Stop the vehicle in a safe location and try to open the hardtop again.</li> </ul>
	Retractable Roof Not Opened/Closed Completely	<p>You are driving with the retractable hardtop not properly locked.</p> <ul style="list-style-type: none"> <li>► Stop the vehicle in a safe location. Observe the traffic situation around you.</li> <li>► Push the retractable hardtop switch forward or rearward until the retractable hardtop is completely closed or open (► page 170).</li> <li>► If the retractable hardtop still does not lock properly, have the hardtop system checked at an authorized Mercedes-Benz Center.</li> </ul>
	Trunk Partition Open	<p>You are trying to open or close the retractable hardtop even though the luggage cover in the trunk is not closed and/or properly engaged.</p> <ul style="list-style-type: none"> <li>► Close the luggage cover (► page 173).</li> </ul>
	Remove Key	<p>You have forgotten to remove the SmartKey.</p> <ul style="list-style-type: none"> <li>► Remove the SmartKey from the starter switch.</li> </ul>







## Vehicle status messages in the multifunction display

247

Display messages	Possible causes/consequences and ► Solutions
 Please get a new key.	The SmartKey is malfunctioning. ► Contact an authorized Mercedes-Benz Center.
 Bluetooth Ready	The telephone has not yet been connected to the audio system or COMAND system via Bluetooth®. ► Connect the telephone to the audio system or COMAND system via Bluetooth®.
 Top Up Washer Fluid	The washer fluid in the washer fluid reservoir has fallen below the minimum level. ► Add washer fluid (► page 196).

### Engine

Display messages	Possible causes/consequences and ► Solutions
 (USA only)  (Canada only)                     Engine Service	There may be a malfunction in <ul style="list-style-type: none"> <li>• the fuel management system</li> <li>• the ignition system</li> <li>• the exhaust system</li> <li>• the fuel system</li> </ul> ► Have the engine checked as soon as possible at an authorized Mercedes-Benz Center.
 Display Malfunction Drive To Workshop	Certain electronic systems are unable to relay information to the control system. The coolant temperature display or the tachometer may have failed. ► Have the electronic systems checked at an authorized Mercedes-Benz Center.
 Top Up Coolant See Operator's Manual	The coolant level is too low. ► Add coolant (► page 196). ► If you have to add coolant frequently, have the cooling system checked at an authorized Mercedes-Benz Center.

#### Warning!

Do not spill antifreeze on hot engine parts. Antifreeze contains ethylene glycol which may burn if it comes into contact with hot engine parts. You could be seriously burned.

**!** Do not ignore the low engine coolant level warning. Extended driving with the message and symbol displayed may cause serious engine damage not covered by the Mercedes-Benz Limited Warranty.

Do not drive without sufficient amount of coolant in the cooling system. The engine will overheat causing major engine damage.

Practical hints

Display messages	Possible causes/consequences and ► Solutions
 <p>Coolant Stop, turn engine off.</p>	<p>The coolant is too hot.</p> <ul style="list-style-type: none"> <li>► Stop the vehicle immediately as soon as it is safe to do so.</li> <li>► Turn off the engine immediately.</li> <li>► Engage the parking brake.</li> <li>► Only start the engine again after the message disappears. You could otherwise damage the engine.</li> <li>► Observe the coolant temperature in the multifunction display.</li> <li>► If the temperature rises again: Contact an authorized Mercedes-Benz Center immediately.</li> </ul> <p>During severe operation conditions and stop-and-go city traffic, the coolant temperature may rise close to 248°F (120°C).</p>



**⚠ Warning!**



Driving when your engine is overheated can cause some fluids which may have leaked into the engine compartment to catch fire. You could be seriously burned.

Steam from an overheated engine can cause serious burns which can occur just by opening the engine hood. Stay away from the engine if you see or hear steam coming from it.

Stop the vehicle in a safe location away from other traffic. Turn off the engine, get out of the vehicle and do not stand near the vehicle until the engine has cooled down.

**!** The engine should not be operated with the coolant temperature above 248°F (120°C). Doing so may cause serious damage which is not covered by the Mercedes-Benz Limited Warranty.

Display messages	Possible causes/consequences and ► Solutions
 <p>Coolant Stop, turn engine off.</p>	<p>The poly-V-belt could be broken.</p> <ul style="list-style-type: none"> <li>► Stop the vehicle immediately as soon as it is safe to do so.</li> <li>► Turn off the engine immediately.</li> <li>► Check the poly-V-belt.</li> <li>► <b>If it is broken:</b> Do not continue to drive. Otherwise the engine will overheat due to an inoperative water pump which may result in damage to the engine. Contact an authorized Mercedes-Benz Center.</li> <li>► <b>If it is intact:</b> Do not continue to drive the vehicle with this message displayed. Doing so could result in serious engine damage that is not covered by the Mercedes-Benz Limited Warranty.</li> <li>► Observe the coolant temperature in the multifunction display.</li> <li>► Drive to the nearest authorized Mercedes-Benz Center immediately.</li> </ul>
	<p>The radiator cooling fan is malfunctioning.</p> <ul style="list-style-type: none"> <li>► Observe the coolant temperature in the multifunction display.</li> </ul> <p>If the coolant temperature is below 248°F (120°C), you may continue driving to an authorized Mercedes-Benz Center.</p> <ul style="list-style-type: none"> <li>► Avoid placing heavy loads on the engine (e.g. by driving uphill) as well as stop-and-go traffic.</li> <li>► Have the fan replaced as soon as possible.</li> </ul>
	<p>The battery is no longer charging.</p> <p>Possible causes:</p> <ul style="list-style-type: none"> <li>• alternator malfunctioning</li> <li>• broken poly-V-belt</li> </ul> <ul style="list-style-type: none"> <li>► Stop immediately in a safe location or as soon as it is safe to do so and check the poly-V-belt.</li> <li>► <b>If it is broken:</b> Do not continue to drive. Otherwise the engine will overheat due to an inoperative water pump which may result in damage to the engine. Contact an authorized Mercedes-Benz Center.</li> <li>► <b>If it is intact:</b> Drive to the nearest authorized Mercedes-Benz Center immediately. Adjust driving to be consistent with reduced braking responsiveness.</li> </ul>

Display messages	Possible causes/consequences and ► Solutions
 <p>Check engine oil level at next refueling.</p>	<p>SLK 300 and SLK 350 only: The engine oil has dropped to a critical level.</p> <ul style="list-style-type: none"> <li>► Check the engine oil level (► page 193) and add engine oil as required (► page 195).</li> <li>► If you must add engine oil frequently, have the engine checked for possible leaks.</li> </ul>
 <p>Add 1 qt. engine oil at next refueling. (USA only) Add 1 liter engine oil at next refueling. (Canada only)</p>	<p>SLK 55 AMG only: The engine oil level is too low.</p> <ul style="list-style-type: none"> <li>► Add engine oil (► page 195) and check the engine oil level (► page 193).</li> <li>► If you must add engine oil frequently, have the engine checked for possible leaks.</li> </ul>

If the message Add 1 qt. (Canada: 1 liter) engine oil at next refueling (SLK 55 AMG) or Check engine oil level at next refueling (SLK 300, SLK 350) appears while the engine is running and at operating temperature, the engine oil level has dropped to approximately the minimum level.







The message will be stored in the vehicle status message memory after you have cleared it from the multifunction display.

Visually check for oil leaks. If there are no obvious oil leaks, drive to the nearest service

station to refill your engine oil to the required level.







For information on approved engine oils contact an authorized Mercedes-Benz Center or visit [www.mbusa.com](http://www.mbusa.com) (USA only).

**!** Engine oil level warnings should not be ignored. Extended driving with the symbol displayed could result in serious engine damage that is not covered by the Mercedes-Benz Limited Warranty.

Display messages	Possible causes/consequences and ► Solutions
 <p>Cannot Measure Engine Oil Level</p>	<p>SLK 55 AMG only: The measuring system is malfunctioning.</p> <ul style="list-style-type: none"> <li>► Have the measuring system checked at an authorized Mercedes-Benz Center.</li> </ul>
 <p>Engine Oil Level Reduce Oil Level</p>	<p>SLK 55 AMG only: You have added too much engine oil. There is a risk of damaging the engine or the catalytic converter.</p> <ul style="list-style-type: none"> <li>► Have oil siphoned or drained off. Observe all legal requirements with respect to its disposal.</li> </ul>
 <p>Engine Oil Level Stop, turn engine off.</p>	<p>The engine oil level is too low. There is a danger of engine damage.</p> <ul style="list-style-type: none"> <li>► Stop the vehicle in a safe location or as soon as it is safe to do so.</li> <li>► Turn off the engine.</li> <li>► Engage the parking brake.</li> <li>► Add engine oil (► page 195) and check the engine oil level (► page 193).</li> </ul>
	<p>The fuel level is low.</p> <ul style="list-style-type: none"> <li>► Refuel at the next gas station.</li> </ul>
 <p>Reserve Fuel</p>	<p>The fuel level has dropped below the reserve mark.</p> <ul style="list-style-type: none"> <li>► Refuel at the next gas station.</li> </ul>
 <p>Gas Cap Is Open</p>	<p>A loss of pressure has been detected in the fuel system. The fuel cap may not be closed properly or the fuel system may be leaking.</p> <ul style="list-style-type: none"> <li>► Check the fuel cap (► page 191).</li> <li>► <b>If it is not closed properly:</b> Close the fuel cap.</li> <li>► <b>If it is closed properly:</b> Have the fuel system checked at an authorized Mercedes-Benz Center.</li> </ul>





## 252 Vehicle status messages in the multifunction display

## Lamps





Display messages	Possible causes/consequences and ► Solutions
 Reverse Lamp Left or Reverse Lamp Right	The left or right backup lamp is malfunctioning. ► Contact an authorized Mercedes-Benz Center as soon as possible.
 Brake-/ Tail Lamp Left or Brake-/ Tail Lamp Right	The left or right brake lamp is malfunctioning. This message will only appear if all LEDs have stopped working. ► Contact an authorized Mercedes-Benz Center as soon as possible.
 3rd Brake Lamp	The high-mounted brake lamp is malfunctioning. This message will only appear if all LEDs have stopped working. ► Contact an authorized Mercedes-Benz Center as soon as possible.
 Front Foglamp Left or Front Foglamp Right	The left or right front fog lamp is malfunctioning. ► Contact an authorized Mercedes-Benz Center as soon as possible.
 Marker Lamp Front Left or Marker Lamp Front Right	The front left side or right side marker lamp is malfunctioning. ► Contact an authorized Mercedes-Benz Center as soon as possible.
 Marker Lamp Rear Left or Marker Lamp Rear Right	The rear left side or right side marker lamp is malfunctioning. This message will only appear if all LEDs have stopped working. ► Contact an authorized Mercedes-Benz Center as soon as possible.

## Vehicle status messages in the multifunction display



253

Display messages		Possible causes/consequences and ► Solutions
	Parking Lamp, Front Left Auxiliary Bulb On or Parking Lamp, Front Right Auxiliary Bulb On	The left or right front parking lamp is malfunctioning. A substitute bulb is being used. ► Replace the bulb as soon as possible (► page 267).
	High Beam Left or High Beam Right	The left or right high-beam lamp (halogen headlamps)/high-beam flasher lamp (Bi-Xenon headlamps) is malfunctioning. ► Replace the bulb as soon as possible (► page 267).
	License Plate Lamp Left or License Plate Lamp Right	The left or right license plate lamp is malfunctioning. ► Replace the bulb as soon as possible (► page 267).
	AUTO-Light Inoperative	The light sensor is malfunctioning. The headlamps come on automatically. ► Contact an authorized Mercedes-Benz Center as soon as possible.  To switch off the headlamps (U.S. vehicles only): ► In the control system, set daytime running lamp mode to manual (► page 106). ► Switch off the headlamps using the exterior lamp switch (► page 71).
	Low Beam Left or Low Beam Right	The left or right low-beam lamp is malfunctioning. ► <b>Halogen headlamp:</b> Replace the bulb as soon as possible (► page 267). ► <b>Bi-Xenon headlamp:</b> Contact an authorized Mercedes-Benz Center as soon as possible.



Practical hints

Display messages	Possible causes/consequences and ► Solutions
 <p>Rear Foglamp Auxiliary Bulb On</p>	<p>The rear fog lamp is malfunctioning. A substitute bulb is being used.</p> <p>► Contact an authorized Mercedes-Benz Center as soon as possible.</p>
 <p>Switch Off Lights</p>	<p>You have removed the SmartKey from the starter switch, opened the driver's door and left the headlamps on.</p> <p>► Turn the exterior lamp switch to <b>0</b> or <b>AUTO</b> (&gt; page 71).</p>
 <p>Switch off lights or remove key</p>	<p>The exterior lamp switch is set to <b>AUTO</b> and you have forgotten to remove the SmartKey from the starter switch. The parking lamps remain switched on.</p> <p>► Remove the SmartKey from the starter switch. or ► Switch off the headlamps.</p>
 <p>Tail Lamp, Left Auxiliary Bulb On or Tail Lamp, Right Auxiliary Bulb On</p>	<p>The left or right tail lamp is malfunctioning. This message will only appear if all LEDs have stopped working. A substitute bulb is being used.</p> <p>► Contact an authorized Mercedes-Benz Center as soon as possible.</p>
 <p>Rear Left Turn Signal Auxiliary Bulb On or Rear Right Turn Signal Auxiliary Bulb On</p>	<p>The left or right rear turn signal lamp is malfunctioning. A substitute bulb is being used.</p> <p>► Contact an authorized Mercedes-Benz Center as soon as possible.</p>



Display messages	Possible causes/consequences and ► Solutions
 <p>Turn Signal Front Left or Turn Signal Front Right</p>	<p>The left or right front turn signal lamp is malfunctioning.</p> <p>► Replace the bulb as soon as possible (► page 267).</p>
 <p>Left Mirror Turn Signal or Right Mirror Turn Signal</p>	<p>The turn signal in the left or right exterior rear view mirror is malfunctioning. This message will only appear if all LEDs have stopped working.</p> <p>► Contact an authorized Mercedes-Benz Center as soon as possible.</p>

## Tires

Display messages	Possible causes/consequences and ► Solutions
 <p>Please correct the tire pressure.</p>	<p>The tire inflation pressure is too low in at least one tire. or The tire inflation pressure of the individual tires differ from each other significantly.</p> <p>► Check and correct tire inflation pressure as required (► page 201).</p>
 <p>Tire Pressure Caution - Tire Defect</p>	<p>At least one tire is deflating.</p> <p>► Carefully bring the vehicle to a halt, avoiding abrupt steering and braking maneuvers.</p> <p>► If necessary, change the wheel (► page 273).</p>
 <p>Tire Pressure Check Tires</p>	<p>The tire inflation pressure in at least one tire is significantly below the reference value.</p> <p>► Carefully bring the vehicle to a halt, avoiding abrupt steering and braking maneuvers.</p> <p>► Check and adjust tire inflation pressure as required.</p> <p>► If necessary, change the wheel (► page 273).</p>

 **Warning!**

Do not drive with a flat tire. A flat tire affects the ability to steer or brake the vehicle. You may lose control of the vehicle. Continued driving with a flat tire will cause excessive heat build-up and possibly a fire.

 **Warning!**

Follow recommended tire inflation pressures.

Do not underinflate tires. Underinflated tires wear excessively and/or unevenly, adversely affect handling and fuel economy, and are more likely to fail from being overheated.

Do not overinflate tires. Overinflated tires can adversely affect handling and ride comfort, wear unevenly, increase stopping distance, and result in sudden deflation (blowout) because they are more likely to become punctured or damaged by road debris, potholes etc.

**What to do if ...**

**Lamps in instrument cluster**



**Notes**





If any of the following lamps in the instrument cluster fails to come on during the bulb self-check when switching on the ignition, have the respective bulb checked and replaced if necessary.

When you switch on the ignition, all lamps in the instrument cluster come on. The high-beam headlamp indicator lamp and turn signal indicator lamps will only come on if activated. If a lamp in the instrument cluster fails to come on when the ignition is switched on, have it checked and replaced if necessary.

تلفن شبانه روزی: ۰۸۵-۸۸۶۲۰۲۱

## Brake

Problem	Possible causes/consequences and ► Solutions
 The yellow ABS indicator lamp comes on while the engine is running.	<p>The ABS has detected a malfunction and switched off. The BAS and the ESP<sup>®</sup> are also switched off.</p> <p>The brake system is still functioning normally but without the systems specified above available.</p> <p>If the ABS control unit is malfunctioning, other systems such as the navigation system or the automatic transmission may also be malfunctioning.</p> <ul style="list-style-type: none"> <li>► Continue driving with added caution. Wheels may lock during hard braking, reducing steering capability.</li> <li>► Adjust driving to be consistent with reduced braking responsiveness.</li> <li>► Read and observe messages that may appear in the multifunction display (► page 236).</li> <li>► Have the system checked at an authorized Mercedes-Benz Center as soon as possible.</li> </ul> <p>Failure to follow these instructions increases the risk of an accident.</p>
 The yellow ABS indicator lamp comes on while the engine is running.	<p>The ABS has switched off due to insufficient power supply.</p> <p>The battery might not be charged sufficiently.</p> <p>When the voltage is above the required value again, the ABS is operational again. The ABS indicator lamp should go out.</p> <ul style="list-style-type: none"> <li>► Continue driving with added caution. Wheels may lock during hard braking, reducing steering capability.</li> <li>► Adjust driving to be consistent with reduced braking responsiveness.</li> <li>► Read and observe messages that may appear in the multifunction display (► page 236).</li> <li>► If the ABS indicator lamp does not go out: Have the alternator and the battery checked.</li> </ul>
 The yellow ABS indicator lamp comes on while the engine is running.	<p>The self-diagnosis has not been completed yet.</p> <p>The indicator lamp will go out after driving a short distance at a vehicle speed of above 12 mph (20 km/h).</p>

Problem	Possible causes/consequences and ► Solutions
 (USA only)  (Canada only) The red brake warning lamp comes on while driving and an acoustic warning sounds.	You are driving with the parking brake engaged. ► Release the parking brake.
 (USA only)  (Canada only) The red brake warning lamp comes on while the engine is running.	There is insufficient brake fluid in the reservoir. Risk of accident! ► Do not drive any further. Stop the vehicle in a safe location as soon as it is safe to do so. ► Engage the parking brake. ► Read and observe messages that may appear in the multifunction display (► page 236). ► Contact an authorized Mercedes-Benz Center. Do not add brake fluid! This will not solve the problem.





 **Warning!**

Driving with the brake warning lamp illuminated can result in an accident. Have your brake system checked immediately if the brake warning lamp stays on. Do not add brake fluid before checking the brake system. Overfilling the brake fluid reservoir can result in spilling brake fluid on hot engine parts and

the brake fluid catching fire. You can be seriously burned.

-  If you find that the brake fluid in the brake fluid reservoir has fallen to the minimum mark or below, have the brake system checked for brake pad thickness and leaks.

## Safety systems

Problem	Possible causes/consequences and ► Solutions
 The red seat belt telltale comes on for a maximum of 6 seconds after starting the engine.	The seat belt telltale reminds you and your passenger to fasten your seat belts before driving off. <ul style="list-style-type: none"> <li>► Fasten your seat belts.</li> </ul> Regardless of whether the seat belts are fastened or not, the seat belt telltale always comes on and remains lit for 6 seconds after starting the engine.
 The red seat belt telltale comes on. In addition you hear a warning chime for a maximum of 6 seconds after starting the engine.	You have forgotten to fasten your seat belt. <ul style="list-style-type: none"> <li>► Fasten your seat belt.</li> </ul> The warning chime stops sounding.
 The red seat belt telltale comes on while the vehicle is standing still and the engine is running or while driving.	You and/or your passenger have forgotten to fasten your seat belts. <ul style="list-style-type: none"> <li>► Fasten your seat belts.</li> </ul> The seat belt telltale goes out. There are items placed on the passenger seat and therefore the system senses the passenger seat as being occupied. <ul style="list-style-type: none"> <li>► Remove the items from the passenger seat and put them in a safe place.</li> </ul> The seat belt telltale goes out.
 The red seat belt telltale flashes while driving. In addition, an intermittent warning chime sounds with increasing intensity.	The vehicle's speed once exceeded 15 mph (25 km/h) and you and/or your passenger have forgotten to fasten your seat belts. <ul style="list-style-type: none"> <li>► Fasten your seat belts.</li> </ul> The seat belt telltale goes out and the warning chime stops sounding. There are items placed on the passenger seat and therefore the system senses the passenger seat as being occupied. <ul style="list-style-type: none"> <li>► Remove the items from the passenger seat and put them in a safe place.</li> </ul> The seat belt telltale goes out and the warning chime stops sounding.

**i** After 60 seconds with an unfastened seat belt the warning chime stops sounding and the seat belt telltale illuminates continuously. The seat belt telltale will only go out if both, the driver and passenger's seat belt are fastened, or the vehicle is standing still and a door is opened.

Problem	Possible causes/consequences and ► Solutions
<b>SRS</b> The red SRS indicator lamp comes on while driving.	There is a malfunction in the restraint systems. The air bags or Emergency Tensioning Devices (ETDs) could deploy unexpectedly or fail to activate in an accident. ► Drive with added caution to the nearest authorized Mercedes-Benz Center.

Practical hints

**⚠ Warning!**

In the event a malfunction of the SRS is indicated as outlined above, the SRS may not be operational.



For your safety, we strongly recommend that you contact an authorized Mercedes-Benz

Center immediately to have the system checked. Otherwise the SRS may not be activated when needed in an accident, which could result in serious or fatal injury, or it might deploy unexpectedly and unnecessarily which could also result in injury.



Problem	Possible causes/consequences and ► Solutions
<b>⚠</b> The yellow ESP® warning lamp comes on while the engine is running.	The ESP® has been switched off. Risk of accident! When the ESP® is switched off it will not stabilize the vehicle if the system recognizes that the vehicle starts to skid or that a wheel is spinning. ► Switch the ESP® back on. Exceptions: (► page 50). ► If leaving the ESP® switched off, adapt your speed and driving to the prevailing road and weather conditions. ► If the ESP® cannot be switched back on: Have the system checked at an authorized Mercedes-Benz Center as soon as possible.
<b>⚠</b> The yellow ESP® warning lamp comes on while the engine is running.	The ESP® is not operational due to a malfunction. Risk of accident! ► Read and observe additional messages that may appear in the multifunction display. ► Continue driving with added caution. Wheels may lock during hard braking, reducing steering capability. ► Adapt your speed and driving to the prevailing road and weather conditions. ► Have the system checked at an authorized Mercedes-Benz Center as soon as possible.

Problem	Possible causes/consequences and ► Solutions
 The yellow ESP® warning lamp flashes while driving.	<p>The ESP® or the Electronic Traction System (ETS) has come into operation because of detected traction loss in at least one tire.</p> <ul style="list-style-type: none"> <li>► When driving off, apply as little throttle as possible.</li> <li>► While driving, ease up on the accelerator pedal.</li> <li>► Adapt your speed and driving to the prevailing road and weather conditions.</li> <li>► Do not deactivate the ESP®.</li> </ul> <p>Exceptions: (► page 50).</p> <p>Failure to follow these instructions increases the risk of an accident.</p>



### Vehicle

Problem	Possible causes/consequences and ► Solutions
 The yellow fuel tank reserve warning lamp comes on when the engine is running. In addition the message Reserve Fuel appears in the multifunction display.	<p>The fuel level has gone below the reserve mark.</p> <ul style="list-style-type: none"> <li>► Refuel at the next gas station. After refueling you will see the message 1 Message in the multifunction display.</li> <li>► Press reset button (R) to confirm the message (► page 92).</li> </ul>
 The yellow fuel tank reserve warning lamp comes on when the engine is running.	<p>The fuel cap is not closed properly.</p> <ul style="list-style-type: none"> <li>► Close the fuel cap.</li> </ul>

## Engine

Problem	Possible causes/consequences and ► Solutions
 (USA only)  (Canada only) The yellow engine malfunction indicator lamp comes on when the engine is running.	There may be a malfunction in <ul style="list-style-type: none"> <li>• the fuel management system</li> <li>• the ignition system</li> <li>• the emission control system</li> <li>• systems which affect emissions</li> </ul> Such malfunctions may result in excessive emissions values and may switch the engine to limp-home (emergency operation) mode. <ul style="list-style-type: none"> <li>► Have the vehicle checked as soon as possible at an authorized Mercedes-Benz Center.</li> </ul> <p><b>i</b> Some states may by law require you to visit a workshop as soon as the engine malfunction indicator lamp comes on. Check local requirements.</p>

## Tires

Problem	Possible causes/consequences and ► Solutions
 USA only: Combination low tire pressure telltale/TPMS malfunction telltale for the Advanced TPMS illuminates continuously.	The Advanced TPMS detects a loss of pressure in at least one tire. <ul style="list-style-type: none"> <li>► Carefully bring the vehicle to a halt, avoiding abrupt steering and braking maneuvers. Observe the traffic situation around you.</li> <li>► Read and observe messages in the multifunction display (► page 236).</li> </ul> If the tire inflation pressure in the respective tire(s) has (have) been corrected, the combination low tire pressure/TPMS malfunction telltale goes out after a few minutes of driving.
 USA only: Combination low tire pressure telltale/TPMS malfunction telltale for the Advanced TPMS flashes 60 seconds and then stays illuminated.	There is a malfunction in the Advanced TPMS. <ul style="list-style-type: none"> <li>► Read and observe messages in the multifunction display (► page 236).</li> <li>► Have the Advanced TPMS checked at an authorized Mercedes-Benz Center.</li> </ul> After the malfunction has been remedied, the combination low tire pressure/TPMS malfunction telltale goes out after a few minutes of driving.



 **Warning!**

Each tire, including the spare (if provided), should be checked at least once a month when cold and inflated to the inflation pressure recommended by the vehicle manufacturer on the Tire and Loading Information placard on the driver's door B-pillar or the tire inflation pressure label on the inside of the fuel filler flap. If your vehicle has tires of a different size than the size indicated on the Tire and Loading Information placard or the tire inflation pressure label, you should determine the proper tire inflation pressure for those tires.

As an added safety feature, your vehicle has been equipped with a tire pressure monitoring system (TPMS) that illuminates a low tire pressure telltale when one or more of your tires are significantly underinflated. Accordingly, when the low tire pressure telltale illuminates, you should stop and check your tires as soon as possible, and inflate them to the proper pressure. Driving on a significantly underinflated tire causes the tire to overheat and can lead to tire failure.

Underinflation also reduces fuel efficiency and tire tread life, and may affect the vehicle's handling and stopping ability. Please note that the TPMS is not a substitute for proper tire

maintenance, and it is the driver's responsibility to maintain correct tire pressure, even if underinflation has not reached the level to trigger illumination of the TPMS low tire pressure telltale.

Your vehicle has also been equipped with a TPMS malfunction indicator to indicate when the system is not operating properly. The TPMS malfunction indicator is combined with the low tire pressure telltale. When the system detects a malfunction, the telltale will flash for approximately 1 minute and then remain continuously illuminated. This sequence will continue upon subsequent vehicle start-ups as long as the malfunction exists. When the malfunction indicator is illuminated, the system may not be able to detect or signal low tire pressure as intended.

TPMS malfunctions may occur for a variety of reasons, including the installation of incompatible replacement or alternate tires or wheels on the vehicle that prevent the TPMS from functioning properly. Always check the TPMS malfunction telltale after replacing one or more tires or wheels on your vehicle to ensure that the replacement or alternate tires and wheels allow the TPMS to continue to function properly.

**Lamp in center console**

Problem	Possible causes/consequences and ► Solutions
<p> The passenger front air bag off indicator lamp illuminates and remains illuminated with the weight of a typical adult or someone larger than a small individual on the passenger seat.</p>	<p>The system is malfunctioning.</p> <ul style="list-style-type: none"> <li>► Have the system checked as soon as possible at an authorized Mercedes-Benz Center.</li> <li>► Read and observe messages in the multifunction display and follow corrective steps (► page 236).</li> </ul>

## 264 Unlocking/locking manually

### Warning!

If the  indicator lamp illuminates and remains illuminated with the weight of a typical adult or someone larger

than a small individual on the passenger seat, do not have any passenger use the passenger seat until the system has been repaired.

### Problem

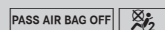

The passenger front air bag off indicator lamp does not illuminate and/or does not remain illuminated with the weight of a typical 12-month-old child in a standard child restraint or less on the passenger seat.

### Possible causes/consequences and ► Solutions

The system is malfunctioning.

- Make sure there is nothing between seat cushion and child seat and check installation of the child seat.
- Make sure no objects applying supplemental weight onto the seat are present.
- If the passenger front air bag off indicator lamp remains out, have the system checked as soon as possible at an authorized Mercedes-Benz Center. Do not transport a child on the passenger seat until the system has been repaired.
- Read and observe messages in the multifunction display and follow corrective steps (► page 236).

### Practical hints

### Warning!

If the  indicator lamp does not illuminate or remains out with the weight of a typical 12-month-old child in a standard child restraint or less on the passenger seat, do not transport a child on the passenger seat until the system has been repaired.

### Removing the mechanical key

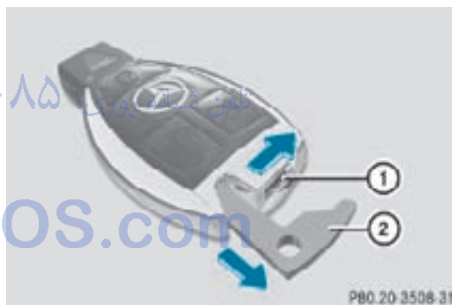

## Unlocking/locking manually

### Unlocking the vehicle

If you cannot unlock the vehicle with the SmartKey, unlock the driver's door and the trunk using the mechanical key.

The anti-theft alarm system will trigger when you

- unlock the driver's door or the trunk with the mechanical key
- and
- open the driver's door or the trunk

To cancel the alarm, insert the SmartKey into the starter switch.

- Move locking tab ① in the direction of arrow.
- Slide mechanical key ② out of the housing.

### Unlocking the driver's door



- ▶ Insert mechanical key ② into the driver's door lock.
- ▶ Turn mechanical key ② counterclockwise to position ① until the locking knob moves up. The driver's door is unlocked.
- ▶ Pull the door handle to open the driver's door.
- ▶ Turn mechanical key ② back and remove it from the driver's door lock.

### Unlocking the trunk

A minimum height clearance of 5.78 ft (1.76 m) is required to open the trunk lid.

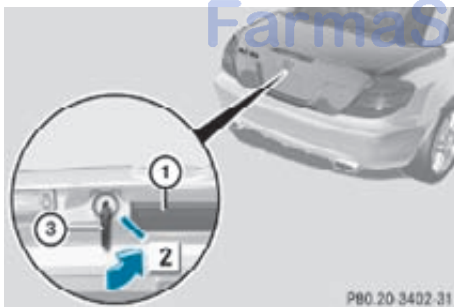

- ▶ Insert mechanical key ③ into the trunk lid lock.
- ▶ Turn mechanical key ③ counterclockwise to position ② and simultaneously pull handle ① and lift trunk lid.

**!** When you open the trunk, the trunk lid swings open upwards. Always make sure there is sufficient overhead clearance.

- ▶ Turn mechanical key ③ back and remove it from the trunk lid lock.

### Locking the vehicle

If you cannot lock the vehicle with the SmartKey, lock it as follows:

- ▶ Open the driver's door.
- ▶ Close the passenger door and the trunk.
- ▶ Press the central locking switch (▶ page 59).
- ▶ Check to see whether the locking knob on the passenger door has moved down.
- ▶ If necessary, push it down manually.
- ▶ Exit the vehicle and close the driver's door.
- ▶ Remove the mechanical key from the SmartKey (▶ page 264).
- ▶ Check whether the trunk is locked.
- ▶ If it is not locked, lock it with the mechanical key (▶ page 61). Except for the driver's door, the vehicle should now be locked.



- ▶ Insert mechanical key ② into the driver's door lock.
- ▶ Turn mechanical key ② clockwise to position ①. The driver's door is locked.
- ▶ Turn mechanical key ② back and remove it from the driver's door lock.

- i** This procedure does not arm the anti-theft alarm system, nor does it lock the fuel filler flap and the storage compartments.

### Manually unlocking the gear selector lever

If the vehicle's electrical system is malfunctioning, the gear selector lever could remain locked in park position **P**. In this case the gear selector lever can be unlocked manually, e.g. to tow the vehicle.

- ▶ Engage the parking brake.

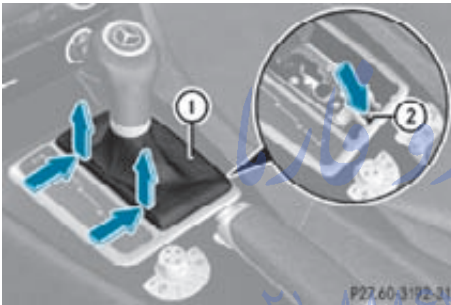

- !** Do not use sharp objects to loosen the gear selector lever cover in the center console, as this could damage the gear selector lever cover or the center console.

- ▶ Insert a flat, blunt object into the left edge of gear selector lever cover ① at the positions indicated by the arrows.
- ▶ Loosen gear selector lever cover ① using this object.
- ▶ Pull gear selector lever cover ① out and remove.
- ▶ Simultaneously push down release ② and move the gear selector lever out of park position **P**.  
The gear selector lever is unlocked.

- i** The gear selector lever is locked again as soon as you move it back to park position **P**.

### Opening/closing manually

#### Raising retractable hardtop manually

##### **⚠ Warning!**

If the retractable hardtop does not completely open or close, the roof hydraulics will lose pressure and the retractable hardtop is lowered

- after approximately 7 minutes when the ignition is switched on
- after approximately 15 seconds when the ignition is switched off

Shortly before the hardtop is lowered, a warning will sound. In the multifunction display you will see  and the message Retractable Roof Lowering.

Properly lock retractable hardtop before continuing to drive.

##### **⚠ Warning!**

Manually closing the retractable hardtop is a complicated and technically demanding procedure and should only be performed by an authorized Mercedes-Benz Center or qualified technician.

Attempting to manually close the retractable hardtop may cause damage to the retractable hardtop and/or personal injury.

##### **⚠ Warning!**

To prevent possible accidents, drive the vehicle only with the retractable hardtop either completely closed and locked, or fully lowered into its storage compartment.

### Replacing SmartKey batteries

If the batteries in the SmartKey are discharged, the vehicle can no longer be locked or unlocked. It is recommended to have the batteries replaced at an authorized Mercedes-Benz Center.

**Warning!**

Batteries contain poisonous and corrosive substances. Therefore, keep the batteries out of reach of children.

If a battery is swallowed, seek medical help immediately.

**Warning!**

SmartKey batteries contain perchlorate material, which may require special handling and regard for the environment. Check with your local government's disposal guidelines. California residents, see [www.dtsc.ca.gov/HazardousWaste/Perchlorate/index.cfm](http://www.dtsc.ca.gov/HazardousWaste/Perchlorate/index.cfm).

Batteries contain materials that can harm the environment if disposed of improperly. Recycling of batteries is the preferred method of disposal. Many states (USA only) or provinces (Canada only) require sellers of batteries to accept old batteries for recycling. When inserting the batteries, make sure they are clean and free of lint.

When replacing batteries, always replace both batteries.

**i** The required replacement batteries are available at any authorized Mercedes-Benz Center.

Replacement batteries: Lithium, type CR 2025 or equivalent.

- ▶ Remove the mechanical key from the SmartKey (▷ page 264).

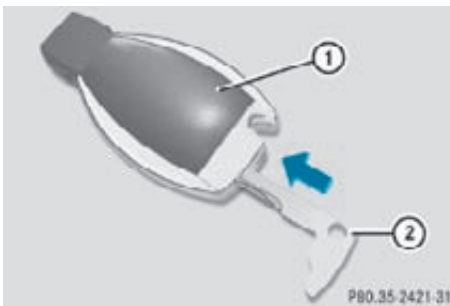

- ▶ Press mechanical key ② into the SmartKey opening until battery compartment cover ① opens. Do not keep the cover shut.



- ▶ Remove the battery compartment cover.
- ▶ Pat the SmartKey against the palm of your hand until battery ③ falls out.
- ▶ Insert the new battery with the positive terminal (+) facing up. Use a lint-free cloth.
- ▶ Insert the tabs of the battery compartment cover into the housing and press the cover closed.
- ▶ Check the operation of the SmartKey.

**Replacing bulbs**

**Safety notes**

Safe vehicle operation depends on proper exterior lighting and signaling to a large degree.

Correct headlamp adjustment is extremely important. Have headlamps checked and readjusted at regular intervals and when a bulb has been replaced. Contact an authorized Mercedes-Benz Center for headlamp adjustment.

**Warning!**

Bulbs and bulb sockets can be very hot. Allow the lamp to cool down before changing a bulb. Keep bulbs out of reach of children.

Halogen lamps contain pressurized gas. A bulb can explode if you

- touch or move it when hot
- drop the bulb
- scratch the bulb

Wear eye and hand protection.

Because of high voltage in Xenon lamps, it is dangerous to replace the bulb or repair the lamp and its components. We recommend that you have such work done by a qualified technician.

**i** Since replacing bulbs is a technically highly demanding process, we recommend to have them replaced at an authorized Mercedes-Benz Center.

**i** If the headlamps or front fog lamps are fogged up on the inside as a result of high humidity, driving the vehicle a distance with the lights on should clear up the fogging.

امداد خودرو فارما

تلفن شبانه روزی: ۰۲۱-۸۸۸۶۲۰۸۵

FarmaSOS.com

## Bulbs

You can replace the following bulbs yourself:

### Halogen headlamps

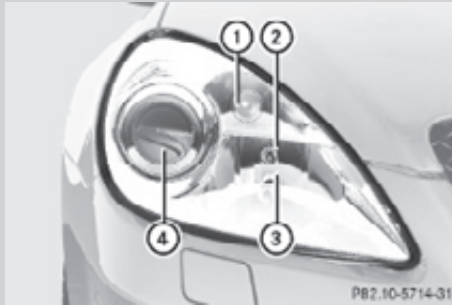

#### Type

- ① Turn signal lamp: 3457A
- ② High-beam lamp: H7 55 W
- ③ Parking and standing lamp: W 5 W
- ④ Low-beam lamp: H7 55 W

### Bi-Xenon headlamps



#### Type

- ① Turn signal lamp: 3457A
- ② High-beam flasher lamp: H7 55 W
- ③ Parking and standing lamp: W 5 W

### License plate lamps



#### Type

- ① License plate lamps: C 5 W

### Notes on bulb replacement

**!** Do not replace LEDs or bulbs not described in this section. You could otherwise damage the LEDs, the bulbs or parts of the vehicle. Only have the LEDs and

bulbs replaced at an authorized Mercedes-Benz Center.

**⚠ Observe Safety notes, see page 267.**

- Only use 12-volt bulbs of the same type and with the specified watt rating.
- Switch the lights off before changing a bulb to prevent short circuits.
- Always use a clean lint-free cloth when handling bulbs.
- Your hands should be dry and free of oil and grease.
- If the newly installed bulb does not come on, contact an authorized Mercedes-Benz Center.

**i** Mercedes-Benz recommends using Longlife (LL) bulbs.

**Replacing bulbs for front lamps**

Before you start to replace a bulb for a front lamp, do the following:

- ▶ Switch off the ignition.
- ▶ Turn the exterior lamp switch to position **0**.
- ▶ Open the hood (▷ page 192).

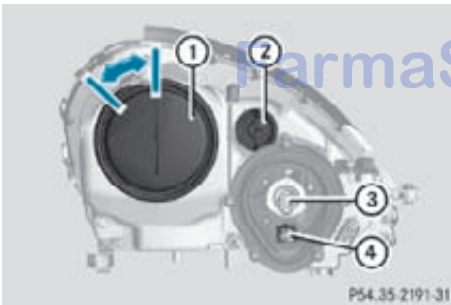

- ① Housing cover for low beam (halogen headlamps only)  
Housing cover for Bi-Xenon headlamps.  
**Do not remove!**
- ② Bulb socket for turn signal lamp
- ③ Bulb socket for high beam/high-beam flasher lamp
- ④ Bulb socket for parking and standing lamp

**⚠ Warning!**

Do not remove the cover for the Bi-Xenon headlamp. Because of high voltage in Xenon lamps, it is dangerous to replace the bulb or repair the lamp and its components. It is recommended to have such work done by a qualified technician.

**Low-beam bulb (halogen headlamps only)**

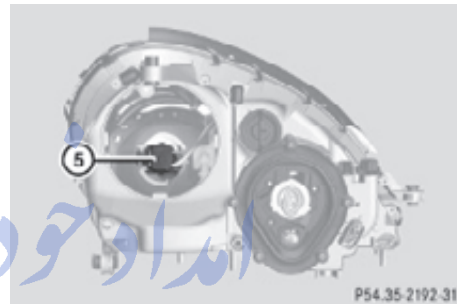

- ⑤ Bulb socket for low-beam headlamp
- ▶ Turn housing cover ① counterclockwise and remove it.
- ▶ Turn bulb socket ⑤ with the bulb counterclockwise and remove it.
- ▶ Pull the bulb out of bulb socket ⑤.
- ▶ Gently press the new bulb into bulb socket ⑤.
- ▶ Place bulb socket ⑤ back into the housing and turn it clockwise.
- ▶ Align housing cover ① and turn it clockwise until it engages.

**High-beam and high-beam flasher bulb (halogen headlamps only)/high-beam flasher bulb (Bi-Xenon headlamps only)**

- ▶ Turn bulb socket ③ with the bulb counterclockwise and remove it.
- ▶ Pull the bulb out of bulb socket ③.



- ▶ Gently press the new bulb into bulb socket ③.
- ▶ Place bulb socket ③ back into the housing and turn it clockwise until it engages.

### Front turn signal lamp bulb

- ▶ Turn bulb socket ② with the bulb counterclockwise and remove it.
- ▶ Gently press onto the bulb and turn it counterclockwise out of bulb socket ②.
- ▶ Gently press the new bulb into bulb socket ② and turn it clockwise until it engages.
- ▶ Place bulb socket ② back into the housing and turn it clockwise until it engages.

### Parking and standing lamp bulb

- ▶ Turn bulb socket ④ with the bulb counterclockwise and remove it.
- ▶ Pull the bulb out of bulb socket ④.
- ▶ Gently press the new bulb into bulb socket ④.
- ▶ Place bulb socket ④ back into the housing and turn it clockwise until it engages.

### Replacing bulbs for rear lamps

#### Tail lamp unit

Since replacing bulbs in the tail lamp unit is a technically highly demanding process, we recommend to have them replaced at an authorized Mercedes-Benz Center.

### License plate lamps

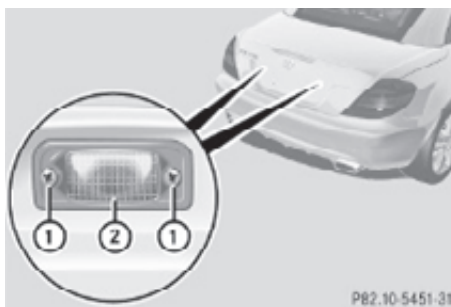

- ▶ Switch off the ignition.
- ▶ Turn the exterior lamp switch to position **0**.
- ▶ Open the trunk.
- ▶ Loosen screws ① of lamp cover to be removed.
- ▶ Remove lamp cover ②.
- ▶ Replace the bulb.
- ▶ Reinstall lamp cover ②.
- ▶ Retighten screws ①.

### Replacing wiper blades

#### Safety notes

##### ⚠ Warning!

For safety reasons, switch off the wipers and remove the SmartKey from the starter switch before replacing a wiper blade. Otherwise, the wiper motor could suddenly turn on and cause injury.

##### ⚠ Warning!

Wiper blades are components that are subject to wear and tear. Replace the wiper blades twice a year, preferably in the spring and fall. Otherwise the windshield will not be wiped properly. As a result, you may not be able to observe surrounding traffic conditions and could cause an accident.

## 272 Replacing wiper blades

**!** To avoid damage to the hood, the wiper arms should only be folded forward when in the vertical position.

**!** Never open the hood when a wiper arm is folded forward.

Hold on to the wiper when folding a wiper arm back. If released, the force of the impact from the tensioning spring could crack the windshield.

Do not allow a wiper arm to contact the windshield glass without a wiper blade inserted.

Mercedes-Benz recommends that you have this work carried out at an authorized Mercedes-Benz Center.

## Practical hints

## Placing wiper arms in vertical position



Wiper arms in vertical position

- ▶ Make sure the hood is fully closed.
- ▶ Turn the SmartKey in the starter switch to position **1**.
- ▶ Turn the combination switch to wiper setting **II**.
- ▶ With wiper arms **1** in vertical position, turn the SmartKey in the starter switch to position **0**.
- ▶ Remove the SmartKey from the starter switch.

## Removing wiper blades

**!** Do not pull on the wiper blade inserts. They could tear.

- ▶ Fold the wiper arm forward until it snaps into place.

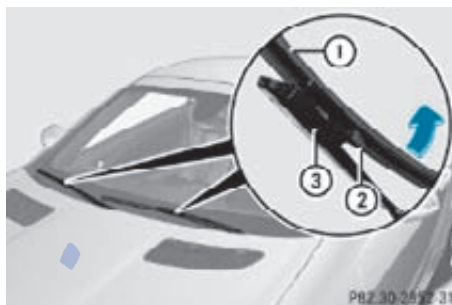

- ▶ Press tabs **2** together and tilt wiper blade **1** in direction of arrow. Tabs **2** on both recesses of attachment **3** are detached.
- ▶ Maintaining its tilted position, remove wiper blade **1** out of attachment **3**.

## Installing wiper blades



- ▶ Maintaining a tilted position of the wiper blade, move cover **1** onto attachment **3** and slip guide tab **2** into cover opening.
- ▶ Tilt the wiper blade in direction of the arrow towards the wiper arm.

- ▶ Simultaneously press tabs ④ together and let the wiper blade engage into both recesses of attachment ③.
  - ▶ Check if the wiper blade is securely fastened.
  - ▶ Fold the wiper arm backward to rest on the windshield.  
Make sure you hold on to the wiper arm when folding it back.
- !** Make sure the wiper blades are installed properly. Improperly installed wiper blades may cause windshield damage.

## Flat tire

### Safety notes

Your vehicle may be equipped with a TIREFIT kit or a spare wheel with collapsible tire. Vehicles with a TIREFIT kit do not have a spare wheel.

For information on your vehicle's equipment, see "Rims and tires" (> page 297).

### Warning!

The dimensions of the spare wheel are different from those of the road wheels. As a result, the vehicle handling characteristics change when driving with a spare wheel mounted. Adapt your driving style accordingly.

The spare wheel is for temporary use only. When driving with a spare wheel mounted, ensure proper tire inflation pressure and do not exceed a vehicle speed of 50 mph (80 km/h).

Contact the nearest authorized Mercedes-Benz Center as soon as possible to have the spare wheel replaced with a regular road wheel.

Never operate the vehicle with more than one spare wheel mounted.

Do not switch off the ESP® when a spare wheel is mounted.

### Preparing the vehicle

- ▶ Whenever possible, park the vehicle in a safe distance from moving traffic on a hard, flat surface.
- ▶ Turn on the hazard warning flasher.
- ▶ Turn the steering wheel so that the front wheels are in a straight-ahead position.
- ▶ Engage the parking brake.
- ▶ Shift the automatic transmission into park position **P** (manual transmission to **1st** or reverse gear **R**).
- ▶ Turn off the engine.
- ▶ Remove the SmartKey from the starter switch.
- ▶ Have any passenger exit the vehicle at a safe distance from the roadway. Open doors only when conditions are safe to do so.

### Sealing tires with TIREFIT

This section applies to SLK 55 AMG with Performance Package only.

Small tire punctures, particularly those in the tread, can be sealed with TIREFIT.

TIREFIT can be used in ambient temperatures down to -4°F (-20°C).

### Warning!

TIREFIT is a limited repair device. TIREFIT cannot be used for cuts or punctures larger than approximately 0.16 in (4 mm) and tire damage caused by driving with extremely low tire inflation pressure, or on a flat tire, or a damaged wheel.

Do not drive the vehicle under such circumstances.

Contact the nearest authorized Mercedes-Benz Center for assistance or call Roadside Assistance.

## 274 Flat tire

- ▶ Foreign objects (e.g. screws or nails) should not be removed from the tire.
- ▶ Take the TIREFIT kit, the sticker, and the electric air pump out of the trunk(▶ page 234).

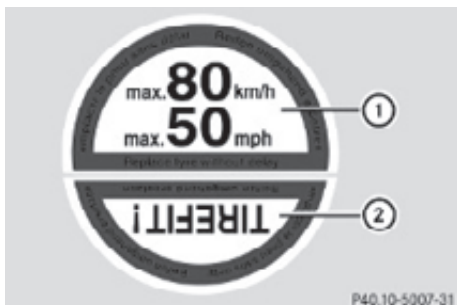

Two-part sticker

- ▶ Attach upper part ① of the sticker where it will be easily seen by the driver on the instrument cluster.
- ▶ Attach lower part ② of the sticker to the damaged tire (close to the tire valve).

### ⚠ Warning!

Take care not to allow the contents of TIREFIT to come in contact with hair, eyes or clothing. TIREFIT is harmful if inhaled, swallowed or absorbed through the skin - causes skin, eye and respiratory irritation.

Any contact with eyes or skin should be flushed immediately with plenty of water.

If clothing comes in contact with TIREFIT, change clothing as soon as possible.

In case of allergic reaction or rash, consult a physician immediately.

### ⚠ Warning!

Keep TIREFIT out of reach of children. If swallowed, rinse mouth immediately with plenty of water and drink plenty of water.

Do not induce vomiting!

Consult a physician immediately.

Keep away from open flame or heat source.

- ❗ If sealant has leaked out, let it dry. You can then peel it off.

If clothing has come in contact with TIREFIT, have it dry-cleaned with perchloroethylene as soon as possible.

### ⚠ Warning!

Observe safety instructions on air pump label.

Your vehicle may be equipped with either of two versions of the electric air pump:

- **Version 1:** The air hose with pressure gauge and the electrical plug are located behind a flap.
- **Version 2:** The pressure gauge is located in the pump housing. The air hose and electrical plug are located at the bottom of the pump housing.

The following description applies to both versions. Differences in usage are expressly declared.

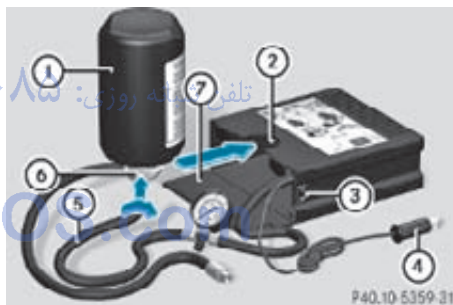

Version 1

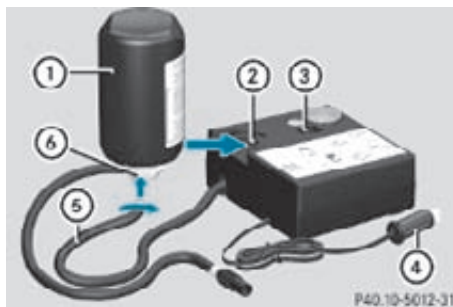

Version 2

- ▶ **Version 1 only:** Open flap ⑦ on the electric air pump.
- ▶ Pull plug ④ and air hose ⑤ out of the pump housing.
- ▶ Screw the air pump's air hose ⑤ onto flange ⑥ of TIREFIT container ①.
- ▶ Stick TIREFIT container ① upside down into notch ② of the electric air pump.

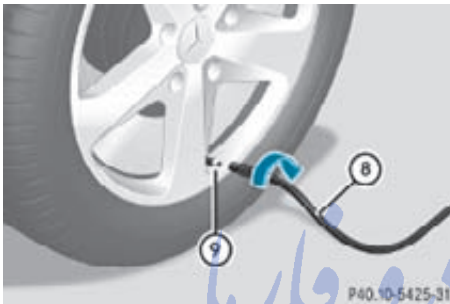

- ▶ Unscrew the valve cap of the damaged tire from tire valve ⑨.



Version 1

- ▶ **Version 1 only:** Close vent screw ⑩ on pressure gauge ⑪.
- ▶ Screw filler hose ⑧ onto tire valve ⑨.
- ▶ Insert electrical plug ④ into the cigarette lighter socket (> page 177) or a power outlet (> page 177).
- ▶ Turn the SmartKey in the starter switch to position 1.
- ▶ Press I on electric air pump switch ③. The electric air pump is switched on and inflates the tire.

- ▶ **i** First, the sealing is pumped into the tire. The pressure may briefly rise to up to 73 psi (5 bar). This is normal and not an indication of a malfunction. **Do not switch off the electric air pump.**

- ▶ Let the electric air pump inflate the tire for approximately 5 minutes. The pressure gauge must display at least 26 psi (1.8 bar).

**⚠ Warning!**

The air hose can become hot during inflation. Please exercise appropriate caution.

- ▶ **!** Do not operate the electric air pump longer than 6 minutes without interruption. Otherwise it may overheat.

You may operate the air pump again after it has cooled off.

**If the tire inflation pressure of at least 26 psi (1.8 bar) is not attained:**

- ▶ Turn off the electric air pump by pressing 0 on electric air pump switch ③.
- ▶ Detach filler hose ⑧ from tire valve ⑨.
- ▶ Drive vehicle back or forth very slowly approximately 30 ft (10 m). This serves to better distribute the TIREFIT sealant material inside the tire.
- ▶ Inflate the tire again.

**⚠ Warning!**

If a tire inflation pressure of 26 psi (1.8 bar) is not attained, the tire is too severely damaged for TIREFIT to provide a reliable tire repair.

In this case, TIREFIT cannot properly seal the tire.

Do not drive the vehicle.

Contact the nearest Mercedes-Benz Center or call Roadside Assistance.

**After attaining a tire inflation pressure of at least 26 psi (1.8 bar):**

- ▶ Press **0** on electric air pump switch ③.  
The electric air pump is switched off.
- ▶ Detach the TIREFIT kit from the tire valve.

**⚠ Warning!**

The air hose may still be hot. Exercise proper caution to avoid burning yourself when detaching the electric air pump.

- ❗ Remaining TIREFIT sealant could escape from the filler hose after it has been detached from the tire valve. TIREFIT sealant may cause stains.

Therefore, cover the filler hose, e.g. by inserting it into the plastic bag the TIREFIT kit was packed in.

- ▶ **Drive off immediately.**

**⚠ Warning!**

Do not exceed a vehicle speed of 50 mph (80 km/h). A TIREFIT repair is not designed to operate at higher speeds.

The sticker must be attached on the instrument cluster where it will be easily seen by the driver.

Vehicle handling characteristics of a TIREFIT repaired tire may change. Adapt your driving accordingly.

- ▶ After driving the vehicle for an initial 10 minutes, check the tire inflation pressure using pressure gauge.

**⚠ Warning!**

If tire inflation pressure has fallen below 20 psi (1.3 bar) do not continue to drive the vehicle.

Park your vehicle safely away from the roadway and contact the nearest authorized Mercedes-Benz Center or Roadside Assistance.

Have the damaged tire replaced.

If the tire inflation pressure is at least 20 psi (1.3 bar), inflate or deflate the tire to the correct tire inflation pressure (see Tire and Loading Information placard on the driver's door B-pillar):

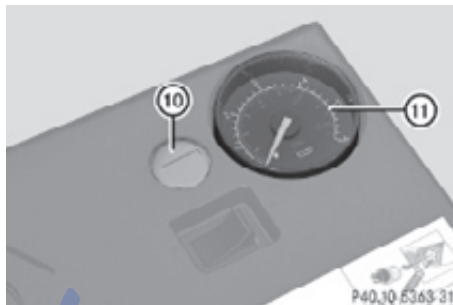

Version 2

- ▶ **To increase tire inflation pressure:**  
Switch on the electric air pump.
- ▶ **To decrease tire inflation pressure:**
  - Version 1:** Open vent screw ⑩ on pressure gauge ⑪ (▶ page 275).
  - Version 2:** Press yellow deflate button ⑪ located in air pump housing next to pressure gauge ⑪.
- ⚠ **Observe Safety notes, see page 201.**
- ▶ Drive to the nearest qualified workshop, e.g. an authorized Mercedes-Benz Center, to have the damaged tire replaced.
- ▶ Recommended duration of use: A maximum of 300 miles (500 km) at 50 mph (80 km/h) or below with the recommended tire inflation pressure.
- ▶ Contact an authorized Mercedes-Benz Center as soon as possible to obtain a new TIREFIT kit.
- ▶ Bring used TIREFIT materials to an authorized Mercedes-Benz Center for proper disposal.
- ▶ Replace your TIREFIT container every 4 years. Replacement containers are available at any authorized Mercedes-Benz Center.

## Mounting the spare wheel

### Introduction

- ▶ Prepare the vehicle as described (▷ page 273).
- ▶ Take the following out of the vehicle:
  - spare wheel
  - jack
  - wheel wrench
  - collapsible wheel chock
  - wheel bolts for spare wheel
  - alignment bolt
  - electric air pump

For information on where to find the respective items, see “Where will I find ...?” (▷ page 234) and (▷ page 235).

- i** Vehicles without spare wheel are not factory-equipped with the tools required for a wheel change such as a jack or a wheel wrench. Some tools required for a wheel change are specific to your vehicle. Contact an authorized Mercedes-Benz Center to obtain the tools approved for your vehicle. This section describes the wheel change using the tools approved and recommended for your vehicle.

### Lifting the vehicle

#### **Warning!**

When jacking up the vehicle, only use the jack which has been specifically approved by Mercedes-Benz for your vehicle.

The jack is designed exclusively for jacking up the vehicle at the jack take-up brackets built into both sides of the vehicle. Make sure the jack arm is fully seated in the jack take-up bracket. The jack must always be vertical when in use, especially on inclines or declines.

The jack is intended only for lifting the vehicle briefly for wheel changes. It is not suited for performing maintenance work under the

vehicle. To help avoid personal injury, use the jack only to lift the vehicle during a wheel change.

Never get beneath the vehicle while it is supported by the jack. Keep hands and feet away from the area under the lifted vehicle. Always lower the vehicle onto sufficient capacity jackstands before working under the vehicle.

Always engage the parking brake firmly and block the wheels with wheel chocks or other sizeable objects before raising the vehicle with the jack. Do not disengage the parking brake while the vehicle is raised.

Make sure that the ground on which the vehicle is standing and where you place the jack is solid, level and not slippery. If necessary, use a large underlay. On slippery surfaces, such as tiled floors, you should use a non-slip underlay, for example a rubber mat.

Do not use wooden blocks or similar objects to support the jack. Otherwise the jack may not be able to achieve its load-bearing capacity if it is not at its full height.

Never start the engine when the vehicle is raised.

Also observe the notes on the jack.

- ▶ Prevent the vehicle from rolling away by blocking wheels with wheel chocks or other sizeable objects.

When your vehicle is equipped with a wheel chock, it is included with the vehicle tool kit (▷ page 234). For information on setting up the collapsible wheel chock, see (▷ page 234).

When changing a wheel on a level surface:

- ▶ Place a wheel chock or other sizeable object in front of and another wheel chock or other sizeable object behind the wheel that is diagonally opposite to the wheel being changed.

## 278 Flat tire

Always try lifting the vehicle using the jack on a level surface. However, should circumstances require you to do so on a hill:

- ▶ Place wheel chocks or other sizeable objects on the downhill side in front of both wheels on the side opposite to the side on which the wheel is to be changed.

**⚠ Warning!**

Only jack up the vehicle on level ground or on slight inclines/declines. Otherwise, the vehicle could fall off the jack and injure you or others.

Practical hints

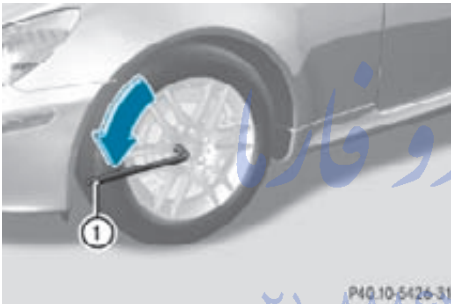

- ▶ On the wheel to be changed, loosen but do not yet remove the wheel bolts (approximately one full turn with wheel wrench ①).

The jack take-up brackets are located directly behind the front wheel housings and in front of the rear wheel housings.

**⚠ Warning!**

The jack is designed exclusively for jacking up the vehicle at the jack take-up brackets. Make sure the jack arm is fully seated in the jack take-up bracket.

If you do not position the jack correctly in the jack take-up bracket, the vehicle can fall off the jack and seriously or fatally injure you or others.

- ❗ Do not position the jack on the body of the vehicle, as this may cause damage to the vehicle.

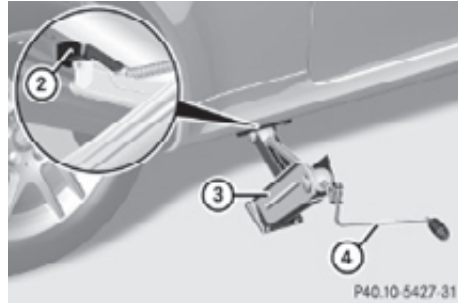

- ▶ Place jack ③ on firm ground.
- ▶ Position jack ③ under take-up bracket ② so that it is always vertical as seen from the side, even if the vehicle is parked on an incline.

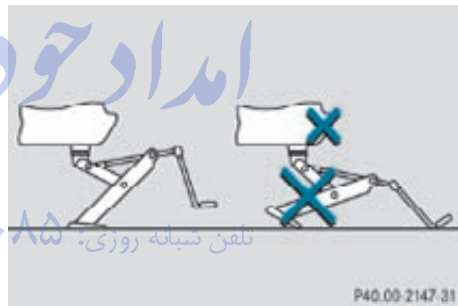

- ▶ Turn crank ④ clockwise until jack ③ is fully seated in take-up bracket ② and the jack base evenly meets the ground.
- ▶ Jack up the vehicle until the wheel is a maximum of 1.2 in (3 cm) from the ground.

### Removing the wheel





- ▶ Unscrew the uppermost wheel bolt and remove it.
  - ▶ Replace this wheel bolt with alignment bolt ①.
  - ▶ Remove the remaining bolts.
- !** Do not place wheel bolts in sand or dirt. This could result in damage to the wheel bolts and wheel hub threads.
- ▶ Remove the wheel.

### Attaching the spare wheel

#### **⚠ Warning!**

Inflate collapsible tire only after the wheel is properly attached.

Inflate the collapsible tire using the electric air pump before lowering the vehicle.

#### **⚠ Warning!**

Always replace wheel bolts that are damaged or rusted.

Never apply oil or grease to wheel bolts. Damaged wheel hub threads should be repaired immediately. Do not continue to drive under these circumstances! Contact an authorized Mercedes-Benz Center or call Roadside Assistance.

Incorrect wheel bolts or improperly tightened wheel bolts can cause the wheel to come off. This could cause an accident. Make sure to use the correct wheel bolts.

#### **⚠ Warning!**

Only use genuine Mercedes-Benz wheel bolts. Other wheel bolts may come loose.

Do not tighten the wheel bolts when the vehicle is raised. Otherwise the vehicle could fall off the jack.

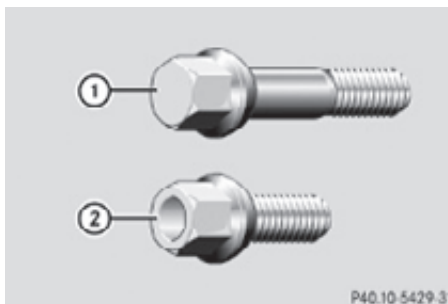

P40.10-5429-31

Wheel bolt ① must be used for light alloy rims. Wheel bolt ② must be used for the spare wheel with collapsible tire. The wheel bolts for the spare wheel are located under a plastic cover on the outside of the spare wheel rim.

**!** Wheel bolts ② must be used when mounting the spare wheel with collapsible tire. The use of any wheel bolts other than wheel bolts ② for the spare wheel with collapsible tire will damage the vehicle's brakes.

#### **⚠ Warning!**

Make sure to use the original length wheel bolts when remounting the original wheel after it has been repaired.

- ▶ Clean contact surfaces of wheel and wheel hub.

**!** To avoid paint damage, place wheel flat against hub and hold it there while installing first wheel bolt.



P40.10-5430-31

## 280 Flat tire

- ▶ Guide the spare wheel onto the alignment bolt and push it on.
- ▶ Insert the wheel bolts and tighten them slightly.
- ▶ Unscrew the alignment bolt.
- ▶ Install the last wheel bolt and tighten it slightly.
- ▶ Inflate the collapsible tire (▷ page 280).

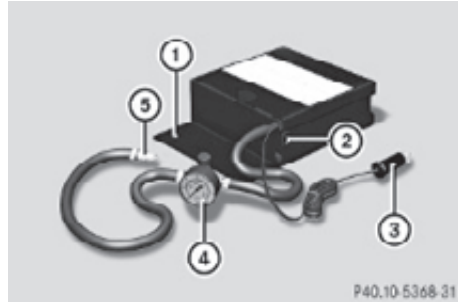

Version 1

## Inflating the collapsible tire

## ⚠ Warning!

Inflate collapsible tire only after the wheel is properly attached.

Inflate the collapsible tire using the electric air pump before lowering the vehicle.

## ⚠ Warning!

Observe safety instructions on air pump label.

- ❗ Do not lower the vehicle before inflating the collapsible tire. Otherwise the rim may be damaged.

Your vehicle may be equipped with either of two versions of the electric air pump:

- **Version 1:** The air hose with pressure gauge and the electrical plug are located behind a flap.
- **Version 2:** The pressure gauge is located in the pump housing. The air hose and electrical plug are located at the bottom of the pump housing.

The following description applies to both versions. Differences in usage are expressly declared.

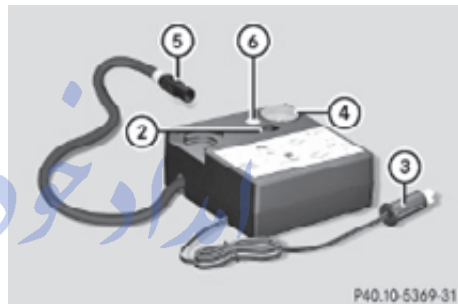

Version 2

- ▶ **Version 1 only:** Open flap ① on electric air pump.
- ▶ **Version 1 only:** Pull out electrical plug ③ and air hose with pressure gauge and vent screw ④.
- ▶ **Version 2 only:** Pull electrical plug ③ and the air hose out of the pump housing bottom.
- ▶ **Version 1 only:** Close vent screw on air hose ④.
- ▶ Remove the valve cap from the collapsible tire valve.
- ▶ Screw union nut ⑤ onto the collapsible tire valve.
- ▶ Make sure air pump switch ② is set to **0**.
- ▶ Insert electrical plug ③ into the cigarette lighter socket (▷ page 177) or a power outlet (▷ page 177).

- ▶ Turn the SmartKey in the starter switch to position **1**.
- ▶ Press **I** on electric air pump switch **②**. The electric air pump switches on and inflates the collapsible tire.
- ▶ Inflate the collapsible tire to the recommended tire inflation pressure as specified for your vehicle (▶ page 300). This should take approximately 5 minutes.

#### **Warning!**

The air hose and the union nut can become hot during inflation. Exercise proper caution to avoid burning yourself when using the equipment.

- ❗ Do not operate the electric air pump longer than 6 minutes without interruption. Otherwise it may overheat. You may operate the air pump again after it has cooled off.

- ❗ Compare the recommended tire inflation pressure for your vehicle with the tire inflation pressure on the yellow label located on the spare wheel rim.

If the tire inflation pressure on the yellow label on the spare wheel rim differs from the values given in this Operator's Manual, inflate the tire to the recommended tire inflation pressure given on the yellow label on the spare wheel rim.

- ▶ Press **0** on electric air pump switch **②**.
- ▶ Turn the SmartKey in the starter switch to position **0**.
- ▶ **Version 1 only:** If the tire inflation pressure is above the recommended tire inflation pressure as specified for your vehicle (▶ page 300), decrease tire pressure using the vent screw on air hose **④**.
- ▶ **Version 2 only:** If the tire inflation pressure is above the recommended tire inflation pressure as specified for your vehicle (▶ page 300), decrease tire pressure using deflate button **⑥**.

#### **Observe Safety notes, see page 201.**

- ▶ Detach the electric air pump.
- ▶ Reinstall collapsible tire valve cap.
- ▶ **Version 1 only:** Store electrical plug **③** and air hose **④** behind flap **①**.
- ▶ **Version 2 only:** Store electrical plug **③** and the air hose back into the pump housing bottom.
- ▶ Place the electric air pump back in its designated storage space.
- ▶ Lower the vehicle.

#### Lowering the vehicle

#### **Warning!**

Inflate collapsible tire only after the wheel is properly attached.

Inflate the collapsible tire using the electric air pump before lowering the vehicle.

- ▶ Lower the vehicle by turning the crank counterclockwise until the vehicle is resting fully on its own weight.
- ▶ Remove the jack.



- ▶ Tighten the five wheel bolts evenly, following the diagonal sequence illustrated (**①** to **⑤**), until all bolts are tight. Observe a tightening torque of 80 lb-ft (110 Nm).

#### **Warning!**

Have the tightening torque checked after changing a wheel. The wheels could come

loose if they are not tightened to a torque of 80 lb-ft (110 Nm).

- ▶ Fully collapse the jack, with handle folded in (storage position), see (▷ page 235).
- ▶ Store the jack and the other vehicle tools in the designated storage space.
- ▶ If so equipped, wrap the damaged wheel in the protective wrap provided with the vehicle tool kit and put the wheel in the trunk.

The retractable hardtop must be closed.

For information on storing the spare wheel after it has been replaced by a regular road wheel, see (▷ page 235).

Practical hints

Battery

Safety notes

A battery should always be sufficiently charged in order to achieve its rated service life. Refer to Maintenance Booklet for battery maintenance intervals.

If you use your vehicle mostly for short-distance trips, you will need to have the battery charge checked more frequently.

When replacing a battery, always use a battery approved by Mercedes-Benz.

If you do not intend to operate your vehicle for an extended period of time, contact an authorized Mercedes-Benz Center about steps you need to observe.

 **Warning!**

Observe all safety instructions and precautions when handling automotive batteries.



Risk of explosion.



Fire, open flames and smoking are prohibited when handling batteries. Avoid creating sparks.



Battery acid is caustic. Do not allow it to come into contact with skin, eyes or clothing.

Wear suitable protective clothing, especially gloves, apron and faceguard.

Wear eye protection.

Rinse any acid spills immediately with clear water. Contact a physician if necessary.

Keep children away.



Follow the instructions in this Operator's Manual.

A battery contains materials that can harm the environment if disposed of improperly. A large 12 V storage battery contains lead. Recycling of the battery is the preferred method of disposal. Many states (USA only) or provinces (Canada only) require sellers of batteries to accept the old battery for recycling.

 **Warning!**

Failure to follow these instructions can result in severe injury or death.

Never lean over batteries while connecting. You might get injured.

Battery fluid contains sulfuric acid. Do not allow this fluid to come in contact with eyes, skin or clothing. In case it does, immediately flush affected area with water and seek medical help if necessary.

A battery will also produce hydrogen gas, which is flammable and explosive. Keep flames or sparks away from battery, avoid improper connection of jumper cables, smoking etc.

**⚠ Warning!**

Do not place metal objects on the battery as this could result in a short circuit.

Use leak-proof batteries only to avoid the risk of acid burns in the event of an accident.

Take care that you do not become statically charged, e.g. by wearing synthetic clothing or rubbing against textiles. For this reason, you also should not pull or push the battery over carpets or other synthetic materials.

Never touch the battery first. First touch the outside body of the vehicle in order to release any possible electrostatic charges.

Do not rub the battery with rags or cloths. The battery could explode if touched due to electrostatic charge or due to spark formation.

**!** As any other battery, the battery may discharge if you do not operate the vehicle for an extended period of time. Have the battery disconnected at a qualified workshop or an authorized Mercedes-Benz Center in such a case. You may also connect an accessory battery charge unit expressly approved by Mercedes-Benz for your vehicle model to maintain the battery charge. Contact an authorized Mercedes-Benz Center for further information.

The battery, the battery ventilation hose and the lateral plug must always be securely installed when the vehicle is in operation.

**!** Never loosen or detach battery terminal clamps while the engine is running or the SmartKey is in the starter switch. Otherwise the alternator and other electronic components could be severely damaged.

Have the battery checked regularly at an authorized Mercedes-Benz Center.

Refer to Maintenance Booklet for maintenance intervals or contact an authorized Mercedes-Benz Center for further information.

**i** After battery power was interrupted, do the following:

- Set the clock (▷ page 105).
- Synchronize the power windows (▷ page 79).

**Charging the battery****⚠ Warning!**

Never charge a battery while still installed in the vehicle unless the accessory battery charge unit approved by Mercedes-Benz is being used. Gases may escape during charging and could cause an explosion that may result in personal injury, paint damage or corrosion.

An accessory battery charge unit specially adapted for Mercedes-Benz vehicles and tested and approved by Mercedes-Benz is available. It permits the charging of the battery in its installed position. Contact an authorized Mercedes-Benz Center for information and availability.

Charge battery in accordance with the separate instructions for the accessory battery charger.

Have the battery charged at an authorized Mercedes-Benz Center. If you charge the battery yourself, follow the operating instructions for your charging device.

Only use a battery charge unit with a maximum charging voltage of 14.8 V.

- ▶ Charge battery in accordance with the instructions of the battery charger manufacturer.

**Jump starting****⚠ Warning!**

Failure to follow these directions will cause damage to the electronic components, and

can lead to a battery explosion and severe injury or death.

Never lean over batteries while connecting or jump starting. You might get injured.

Battery fluid contains sulfuric acid. Do not allow this fluid to come in contact with eyes, skin or clothing. In case it does, immediately flush affected area with water, and seek medical help if necessary.

A battery will also produce hydrogen gas, which is flammable and explosive. Keep flames or sparks away from battery, avoid improper connection of jumper cables, smoking, etc.

Attempting to jump start a frozen battery can result in it exploding, causing personal injury.

Read all instructions before proceeding.

**!** Vehicles with automatic transmission:

Do not tow-start the vehicle. You could otherwise seriously damage the automatic transmission which is not covered by the Mercedes-Benz Limited Warranty.

**!** Jump starting should only be performed using the jump-start terminals located in the engine compartment.

Avoid repeated and lengthy starting attempts.

Do not attempt to start the engine using a battery quick-charge unit.

If the engine does not run after several unsuccessful starting attempts, have it checked at the nearest authorized Mercedes-Benz Center.

Excessive unburned fuel generated by repeated failed starting attempts may damage the catalytic converter and may present a fire risk.

Make sure the jumper cables do not have loose or missing insulation.

Make sure the cable clamps do not touch any other metal part while the other end is still attached to a battery.

If the battery is discharged, the engine can be started with jumper cables and the fully charged battery of another vehicle or an equivalent starter pack. Observe the following:

- Access to the battery is not possible on all vehicles. If you cannot access the battery of the other vehicle, provide jump start power by an external battery or starter pack.
- Jump starting should only be performed when the engine and catalytic converter are cold.
- Do not jump start the engine or charge the battery if the battery is frozen. Let the battery thaw out first.
- Only jump start from batteries with the same voltage rating (12 V). Jump starting with a more powerful battery could damage the vehicle's electrical system. Such damage will not be covered by the Mercedes-Benz Limited Warranty.
- Only use jumper cables with sufficient cross-section and insulated terminal clamps.
- Always make sure the jumper cables are not on or near pulleys, fans or other parts that move when an engine is started or running.
- Should the battery be drained completely, let the donating power source charge the vehicle for several minutes before reattempting the starting process.

The jump-start contacts are located in the engine compartment on the passenger side.

- ▶ Make sure the two vehicles do not touch.
- ▶ Switch off all electrical consumers.
- ▶ Engage the parking brake.
- ▶ Make sure the automatic transmission is in park position **P** (manual transmission to Neutral).
- ▶ Open the hood (▷ page 192).

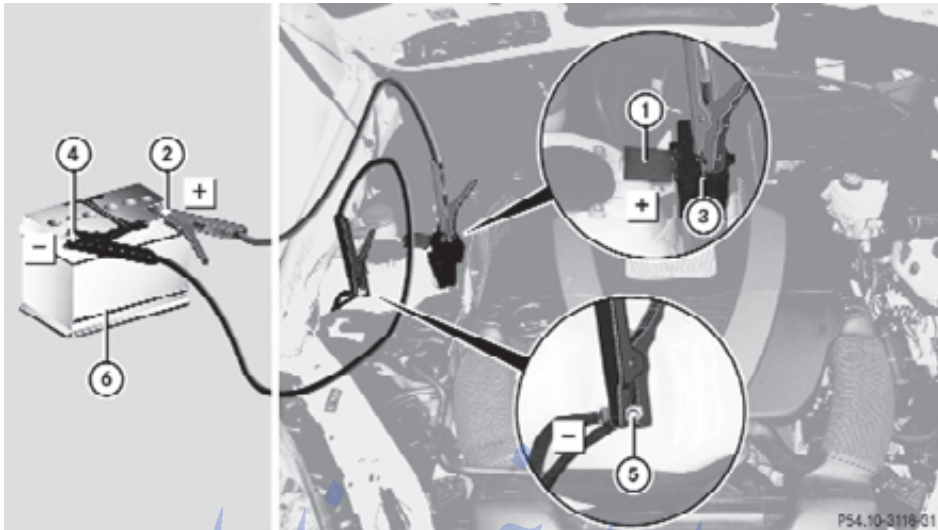

Position ⑥ represents the charged battery of another vehicle or an equivalent starter pack.

- ▶ Flip up cover ① of positive terminal ③.

**!** Never invert the terminal connections!

- ▶ Connect positive terminal ② of charged battery ⑥ with positive terminal ③ with a jumper cable. Clamp the cable to positive terminal ② of charged battery ⑥ first.
- ▶ Start engine of the vehicle with charged battery ⑥ and run at idle speed.
- ▶ Connect negative terminal ④ of charged battery ⑥ with negative terminal ⑤ with a jumper cable. Clamp the cable to negative terminal ④ of charged battery ⑥ first.
- ▶ Start engine of the vehicle with the discharged battery and run at idle speed. You can now turn on the electrical consumers. Do not switch on the headlamps under any circumstances.
- ▶ Remove the jumper cables from negative terminals ④ and ⑤ first.

- ▶ Remove the jumper cables from positive terminals ② and ③.

You can now switch on the headlamps.

- ▶ Close cover ① of positive terminal ③.

- ▶ Have the battery checked at the nearest authorized Mercedes-Benz Center.

## Towing the vehicle

### Safety notes

Mercedes-Benz recommends that the vehicle be transported with all wheels off the ground using flatbed or appropriate wheel lift/dolly equipment. This method is preferable to other types of towing.

- !** To prevent damage during transport, do not tie down vehicle by its chassis or suspension parts.

If circumstances do not permit the recommended towing methods, the vehicle may be towed with all wheels on the ground or one axle raised only so far as necessary to have the vehicle moved to a safe location where the recommended towing methods can be employed.

- ▶ Switch off the tow-away alarm before towing the vehicle with all wheels on the ground or one axle raised (▷ page 52).

**!** Before towing the vehicle observe the following instructions:

- Vehicles with automatic transmission: Do not tow-start the vehicle. You could otherwise seriously damage the automatic transmission which is not covered by the Mercedes-Benz Limited Warranty.
- Do not tow with sling-type equipment. Towing with sling-type equipment over bumpy roads will damage radiator and supports.
- Towing of the vehicle should only be done using the properly installed towing eye bolt. Never attach a tow cable, tow rope or tow rod to the vehicle chassis, frame or suspension parts.

#### **⚠ Warning!**

With the engine not running, there is no power assistance for the brake and steering systems. In this case, it is important to keep in mind that a considerably higher degree of effort is necessary to brake and steer the vehicle. Adapt your driving accordingly.

**!** Avoid pulling the vehicle abruptly or diagonally, since it could result in damage to the chassis alignment.

**!** Do not use the towing eye bolt for recovery, as this could damage the vehicle. If in doubt, recover the vehicle with a crane.

**i** If the battery is disconnected or discharged

- the SmartKey will not turn in the starter switch
- Vehicles with automatic transmission: the automatic transmission will remain in park position **P**

For more information see “Battery” (▷ page 282) or “Jump starting” (▷ page 283).

Vehicles with automatic transmission: For information on manually unlocking the gear selector lever, see (▷ page 266).

#### **Installing towing eye bolt**

Depending on whether you are towing a vehicle or you are being towed, the towing eye bolt can be screwed into threaded holes which are located behind covers on each bumper.

The towing eye bolt is supplied with the vehicle tool kit, located in the compartment underneath the trunk floor (▷ page 234).

- ▶ Take the vehicle tool kit out of the trunk.

#### **Removing cover in front bumper**



- ▶ Press mark on cover ① as indicated by the arrow.
- ▶ Lift cover ① off to reveal the threaded hole for the towing eye bolt.

#### **Removing cover in rear bumper**

##### **⚠ Warning!**

In order to avoid possible serious burns or injury, use extreme caution when removing the rear cover, because the rear exhaust pipe is extremely hot.



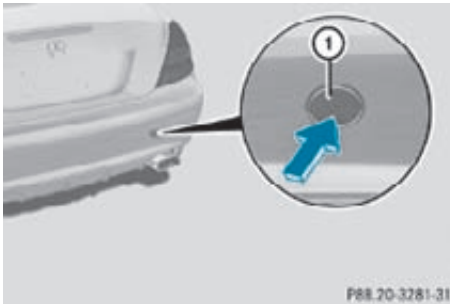

- ▶ Press mark on cover ① as indicated by the arrow.
- ▶ Lift cover ① off to reveal the threaded hole for the towing eye bolt.

### Fixing towing eye bolt

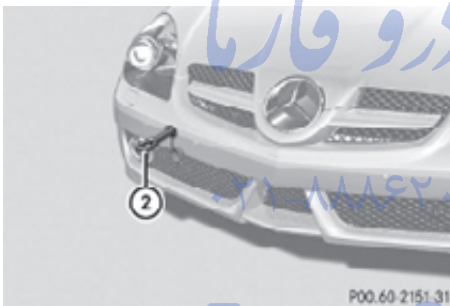

Example illustration front bumper

- ▶ Take the towing eye bolt and, if so equipped, the wheel wrench from the vehicle tool kit (▷ page 234).
  - ▶ Screw towing eye bolt ② clockwise into threaded hole to its stop.
  - ▶ Insert wheel wrench into towing eye and tighten towing eye bolt ② by turning it clockwise.
- or
- ▶ If your vehicle is not equipped with a wheel wrench, use a suitable object to turn the towing eye bolt.

### Removing towing eye bolt

- ▶ Loosen towing eye bolt ② by turning it counterclockwise.
- ▶ Unscrew towing eye bolt ②.
- ▶ **Reinstalling cover:** Fit cover ① (▷ page 286) and snap it into place.
- ▶ Store the towing eye bolt ② and wheel wrench back into the vehicle tool kit.

### Towing with front axle raised

**!** The vehicle may be towed only for distances up to 30 miles (50 km) and at a speed not to exceed 30 mph (50 km/h).

- ▶ Make sure the ignition is switched on.
- ▶ With the vehicle at a standstill, depress the brake pedal and keep it pressed.
- ▶ Vehicles with manual transmission: Shift the manual transmission into the neutral position (no gear selected).

or

- ▶ Vehicles with automatic transmission: Shift the automatic transmission into neutral position **N**.
- ▶ Release the brake pedal.
- ▶ If engaged, release the parking brake.
- ▶ Switch off the automatic central locking (▷ page 108).
- ▶ Switch off the ignition and leave the SmartKey in the starter switch.
- ▶ Switch on the hazard warning flasher (▷ page 74).

**!** Because the ESP® operates automatically, the engine and ignition must be shut off (SmartKey in starter switch position **0** or **1**) when the vehicle is being towed with the front axle raised.

Active braking action through the ESP® may otherwise seriously damage the brake system which is not covered by the Mercedes-Benz Limited Warranty.

**Towing with all wheels on the ground** **Warning!**

If circumstances require towing the vehicle with all wheels on the ground, always tow with a tow bar if:

- the engine will not run
- there is a malfunction in the brake system
- there is a malfunction in the power supply or in the vehicle's electrical system

This is necessary to adequately control the towed vehicle.

Prior to towing the vehicle with all wheels on the ground, make sure the SmartKey is in starter switch position **2**.

If the SmartKey is left in the starter switch position **0** for an extended period of time, it can no longer be turned in the switch. In this case, the steering is locked. To unlock, remove SmartKey from starter switch and reinsert.

 **Warning!**

With the engine not running, there is no power assistance for the brake and steering systems. In this case, it is important to keep in mind that a considerably higher degree of effort is necessary to brake and steer the vehicle. Adapt your driving accordingly.

- ▶ Make sure the ignition is switched on.
  - ▶ With the vehicle at a standstill, depress the brake pedal and keep it pressed.
  - ▶ Vehicles with manual transmission: Shift the manual transmission into the neutral position (no gear selected).
- or
- ▶ Vehicles with automatic transmission: Shift the automatic transmission into neutral position **N**.
  - ▶ Release the brake pedal.
  - ▶ If engaged, release the parking brake.
  - ▶ Switch on the hazard warning flasher (▷ page 74).

 The vehicle may be towed only for distances up to 30 miles (50 km) and at a speed not to exceed 30 mph (50 km/h).

 While being towed with the hazard warning flasher in use, use the combination switch in the usual manner to signal turns. Only the selected turn signal will operate. Upon canceling the turn signal, the hazard warning flasher will operate again.

**Fuses****Introduction**

The electrical fuses in your vehicle serve to switch off malfunctioning power circuits.

If a fuse is blown, the components and systems secured by that fuse will stop operating.

 **Warning!**

Only use fuses approved by Mercedes-Benz with the specified amperage for the system in question and do not attempt to repair or bridge a blown fuse. Using other than approved fuses or using repaired or bridged fuses may cause an overload leading to a fire, and/or cause damage to electrical components and/or systems. Have the cause determined and remedied by an authorized Mercedes-Benz Center.

A blown fuse must be replaced by an appropriate spare fuse (recognizable by its color or the fuse rating given on the fuse) of the amperage recommended in the fuse chart. Any Mercedes-Benz Center will be glad to advise you on this subject.

 In case of a blown fuse contact Roadside Assistance or an authorized Mercedes-Benz Center.

If a newly inserted fuse blows again, have the cause determined and rectified by an authorized Mercedes-Benz Center.

The fuse chart is located in the fuse box in the passenger compartment. The fuse chart

explains the fuse allocation and fuse amperages.

### Before replacing fuses

- ▶ Engage the parking brake.
- ▶ Make sure the automatic transmission is in park position **P** (manual transmission to Neutral).
- ▶ Switch off all electrical consumers.
- ▶ Turn off the engine.
- ▶ Remove the SmartKey from the starter switch.

### Fuse box in passenger compartment

- ❗ Do not use sharp objects such as a screwdriver to open the fuse box cover in the dashboard. You could damage the fuse box cover or the dashboard.



- ▶ Open the driver's door.
- ▶ **Opening:** Insert flat, blunt object as a lever in recess on the edge of cover ① at the position indicated by the arrow.
- ▶ Loosen fuse box cover ① from the dashboard using the lever.
- ▶ **Closing:** Hook fuse box cover ① into the opening at the front.
- ▶ Press fuse box cover ① back on until it engages.

- ❗ The fuse box cover must be properly positioned as described. Otherwise,

moisture or dirt could enter the fuse box and possibly impair fuse operation.

### Fuse box in engine compartment

- ▶ Open the hood.

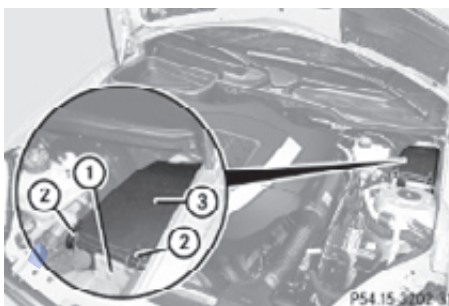

- ▶ With a dry cloth, remove any moisture from fuse box cover ①.
- ▶ **Opening:** Release clamps ②.
- ▶ Remove fuse box cover ③.
- ▶ **Closing:** Make sure the sealing rubber is positioned properly.
- ▶ Press fuse box cover ③ down and secure with clamps ②.

- ❗ The fuse box cover must be properly positioned as described. Otherwise, moisture or dirt could enter the fuse box and possibly impair fuse operation.

- ▶ Close the hood after checking or replacing fuses.

# امداد خودرو فارما

تلفن شبانه روزی: ۰۲۱-۸۸۸۶۲۰۸۵

[FarmaSOS.com](http://FarmaSOS.com)

<b>Vehicle equipment</b> .....	292
<b>Parts service</b> .....	292
<b>Warranty coverage</b> .....	292
<b>Identification labels</b> .....	292
<b>Vehicle specification SLK 300</b> (171.454) .....	294
<b>Vehicle specification SLK 350</b> (171.458) .....	295
<b>Vehicle specification SLK 55 AMG</b> (171.473) .....	296
<b>Rims and tires</b> .....	297
<b>Fuels, coolants, lubricants, etc.</b> .....	300

امداد خودرو فارما

تلفن شبانه روزی: ۰۲۱-۸۸۸۶۲۰۸۵

FarmaSOS.com



### Vehicle equipment

**i** This Operator's Manual describes all features, standard or optional, potentially available for your vehicle at the time of purchase. Please be aware that your vehicle might not be equipped with all features described in this manual.

### Parts service

All authorized Mercedes-Benz Centers maintain a stock of Genuine Mercedes-Benz Parts required for maintenance and repair work. In addition, strategically located parts distribution centers provide quick and reliable parts service.

More than 300 000 different parts for Mercedes-Benz models are available.

Genuine Mercedes-Benz Parts are subjected to stringent quality inspections. Each part has been specifically developed, manufactured or selected for and adapted to Mercedes-Benz vehicles.

Therefore, Genuine Mercedes-Benz Parts should be installed.

**!** Do not use non-genuine Mercedes-Benz parts and accessories not authorized by Mercedes-Benz. Doing so could damage the vehicle, which is not covered by the Mercedes-Benz Limited Warranty. Also, it could compromise the vehicle's durability or safety.

### Warranty coverage

Your vehicle is covered under the terms of the warranties printed in the Service and Warranty Information booklet.

Your authorized Mercedes-Benz Center will exchange or repair any defective parts originally installed in the vehicle in accordance with the terms of the following warranties:

- New Vehicle Limited Warranty
- Emission System Warranty
- Emission Performance Warranty
- California, Connecticut, Maine, Massachusetts, New York, Pennsylvania, Rhode Island, and Vermont Emission Control Systems Warranty
- State Warranty Enforcement Laws (Lemon Laws)

Replacement parts and accessories are covered by the Mercedes-Benz Parts and Accessories warranties, copies of which are available at any authorized Mercedes-Benz Center.

### Loss of Service and Warranty Information booklet

Should you lose your Service and Warranty Information booklet, have an authorized Mercedes-Benz Center arrange for a replacement. It will be mailed to you.

### Identification labels



The Vehicle Identification Number (VIN) can be found

- on certification label ① on the driver's door B-pillar
- embossed on the center tunnel behind the passenger seat (▷ page 293)
- on the lower edge of the windshield (▷ page 293)



Example certification label (U.S. vehicles)

- ② VIN
- ③ Paintwork code



Example certification label (Canada vehicles)

- ② VIN
- ③ Paintwork code

**i** Data shown on certification label are for illustration purposes only. These data are

specific to each vehicle and may vary from data shown in the illustration. Refer to certification label on vehicle for actual data specific to your vehicle.



- ▶ Move the passenger seat forward as far as possible (▷ page 63).
- ▶ Fold cover ④ upward. VIN ⑤ is now visible.



- ⑥ Engine number (engraved on engine)
- ⑦ VIN (on lower edge of windshield)
- ⑧ Emission control information label, includes both federal and California certification exhaust emission standards

**i** When ordering parts, please specify vehicle identification and engine number.

## 294 Vehicle specification SLK 300 (171.454)

Vehicle specification SLK 300  
(171.454)

The quoted data apply only to the standard vehicle. Contact an authorized Mercedes-Benz Center for the corresponding data of all special bodies and special equipment.

## Engine SLK 300

<b>Engine, type</b>	272
<b>Mode of operation</b>	4-stroke engine, gasoline injection
<b>No. of cylinders</b>	6
<b>Bore</b>	3.46 in (88.00 mm)
<b>Stroke</b>	3.23 in (82.10 mm)
<b>Total piston displacement</b>	182.8 cu in (2 996 cm <sup>3</sup> )
<b>Compression ratio</b>	11.3:1
<b>Output acc. to SAE J 1349<sup>17</sup></b>	228 hp/6 100 rpm (170 kW/6 100 rpm)
<b>Maximum torque acc. to SAE J 1349</b>	221 lb-ft/2 500 - 5 000 rpm (300 Nm/2 500 - 5 000 rpm)
<b>Maximum engine speed</b>	6 500 rpm
<b>Firing order</b>	1-4-3-6-2-5
<b>Poly-V-belt</b>	2 401 mm

## Electrical system SLK 300

<b>Alternator</b>	14 V/150 A
<b>Starter motor</b>	12 V/1.4 kW
<b>Battery</b>	12 V/74 Ah

## Electrical system SLK 300

<b>Spark plugs, type</b>	Bosch Y 7 MPP33
<b>Spark plugs, electrode gap</b>	0.031 in (0.8 mm)
<b>Spark plugs, tightening torque</b>	15 - 18 lb-ft (20 - 25 Nm)

## Main dimensions SLK 300

<b>Overall vehicle length</b>	161.7 in (4 107 mm)
<b>Overall vehicle width<sup>18</sup></b>	79.2 in (2 012 mm)
<b>Overall vehicle height</b>	51.0 in (1 296 mm)
	60.8 in (1 545 mm) <sup>19</sup>
<b>Wheelbase</b>	95.7 in (2 430 mm)
<b>Track, front</b>	60.2 in (1 530 mm)
<b>Track, rear</b>	61.0 in (1 549 mm)
<b>Turning circle</b>	34.5 ft (10.5 m)

## Weights SLK 300

<b>Roof load</b>	max. 110 lb (50 kg)
<b>Trunk load</b>	max. 220 lb (100 kg)

**!** This vehicle is not designed to carry items on its roof. Roof rails and any roof-mounted devices, unless expressly approved by Mercedes-Benz for use on this vehicle model, must not be used as they will damage the vehicle and retractable hardtop.

At time of printing, Mercedes-Benz does not offer any roof racks or any other roof-mounted devices for use on this vehicle.

<sup>17</sup> Premium fuel required. Performance may vary with fuel octane rating.

<sup>18</sup> Exterior rear view mirrors folded out.

<sup>19</sup> When opening/closing hardtop.



## Vehicle specification SLK 350 (171.458)

295

**!** This vehicle is not designed to carry any items on its trunk lid or accommodate any type of trunk lid rack or device. Using such devices may damage the vehicle and retractable hardtop mechanism.

### Vehicle specification SLK 350 (171.458)

The quoted data apply only to the standard vehicle. Contact an authorized Mercedes-Benz Center for the corresponding data of all special bodies and special equipment.

Engine SLK 350	
Engine, type	272
Mode of operation	4-stroke engine, gasoline injection
No. of cylinders	6
Bore	3.66 in (92.90 mm)
Stroke	3.39 in (86.00 mm)
Total piston displacement	213.5 cu in (3498 cm <sup>3</sup> )
Compression ratio	11.7:1
Output acc. to SAE J 1349 <sup>20</sup>	300 hp/6 500 rpm (224 kW/6 500 rpm)
Maximum torque acc. to SAE J 1349	266 lb-ft/4 900 rpm (360 Nm/4 900 rpm)
Maximum engine speed	7 200 rpm
Firing order	1-4-3-6-2-5
Poly-V-belt	2401 mm

Electrical system SLK 350	
Alternator	14 V/180 A
Starter motor	12 V/1.4 kW
Battery	12 V/74 Ah
Spark plugs, type	Bosch Y 7 MPP33
Spark plugs, electrode gap	0.031 in (0.8 mm)
Spark plugs, tightening torque	15 - 18 lb-ft (20 - 25 Nm)

Main dimensions SLK 350	
Overall vehicle length	161.7 in (4 107 mm)
Overall vehicle width <sup>21</sup>	79.2 in (2 012 mm)
Overall vehicle height	51.1 in (1 298 mm) 60.8 in (1 545 mm) <sup>22</sup>
Wheelbase	95.7 in (2 430 mm)
Track, front	60.1 in (1 526 mm)
Track, rear	61.0 in (1 549 mm)
Turning circle	34.5 ft (10.5 m)

Weights SLK 350	
Roof load	max. 110 lb (50 kg)
Trunk load	max. 220 lb (100 kg)

**!** This vehicle is not designed to carry items on its roof. Roof rails and any roof-mounted devices, unless expressly approved by Mercedes-Benz for use on this vehicle model, must not be used as they will

Technical data

<sup>20</sup> Premium fuel required. Performance may vary with fuel octane rating.

<sup>21</sup> Exterior rear view mirrors folded out.

<sup>22</sup> When opening/closing hardtop.

damage the vehicle and retractable hardtop.

At time of printing, Mercedes-Benz does not offer any roof racks or any other roof-mounted devices for use on this vehicle.

**!** This vehicle is not designed to carry any items on its trunk lid or accommodate any type of trunk lid rack or device. Using such devices may damage the vehicle and retractable hardtop mechanism.

### Vehicle specification SLK 55 AMG (171.473)

The quoted data apply only to the standard vehicle. Contact an authorized Mercedes-Benz Center for the corresponding data of all special bodies and special equipment.

### Technical data

Engine SLK 55 AMG	
Engine, type	113
Mode of operation	4-stroke engine, gasoline injection
No. of cylinders	8
Bore	3.82 in (97.00 mm)
Stroke	3.62 in (92.00 mm)
Total piston displacement	331.9 cu in (5 439 cm <sup>3</sup> )
Compression ratio	11.0:1
Output acc. to SAE J 1349 <sup>23</sup>	355 hp/5 750 rpm (265 kW/5 750 rpm)
Maximum torque acc. to SAE J 1349	376 lb-ft/4 000 rpm (510 Nm/4 000 rpm)
Maximum engine speed	6 500 rpm

Engine SLK 55 AMG	
Firing order	1-5-4-2-6-3-7-8
Poly-V-belt	2 380 mm

Electrical system SLK 55 AMG	
Alternator	14 V/150 A
Starter motor	12 V/1.7 kW
Battery	12 V/74 Ah
Spark plugs, type	NGK IFR 6D10
Spark plugs, electrode gap	0.039 in (1.0 mm)
Spark plugs, tightening torque	18 - 22 lb-ft (25 - 30 Nm)

Main dimensions SLK 55 AMG	
Overall vehicle length	161.5 in (4 103 mm)
Overall vehicle width <sup>24</sup>	79.2 in (2 012 mm)
Overall vehicle height	50.7 in (1 287 mm)
	60.4 in (1 535 mm) <sup>25</sup>
Wheelbase	95.7 in (2 430 mm)
Track, front	60.0 in (1 524 mm)
Track, rear	61.0 in (1 549 mm)
Turning circle	34.5 ft (10.5 m)

Weights SLK 55 AMG	
Roof load	max. 110 lb (50 kg)
Trunk load	max. 220 lb (100 kg)

<sup>23</sup> Premium fuel required. Performance may vary with fuel octane rating.

<sup>24</sup> Exterior rear view mirrors folded out.

<sup>25</sup> When opening/closing hardtop.

**!** This vehicle is not designed to carry items on its roof. Roof rails and any roof-mounted devices, unless expressly approved by Mercedes-Benz for use on this vehicle model, must not be used as they will damage the vehicle and retractable hardtop.

At time of printing, Mercedes-Benz does not offer any roof racks or any other roof-mounted devices for use on this vehicle.

**!** This vehicle is not designed to carry any items on its trunk lid or accommodate any type of trunk lid rack or device. Using such devices may damage the vehicle and retractable hardtop mechanism.

## Rims and tires

### Notes

**!** Only use tires which have been tested and approved by Mercedes-Benz. Tires approved by Mercedes-Benz are developed to provide best possible performance in conjunction with the driving safety systems on your vehicle such as the ABS or the ESP®. Tires specially developed for your vehicle and tested and approved by Mercedes-Benz can be identified by finding the following on the tire's sidewall:

- MO = Mercedes-Benz Original equipment tires

Using tires other than those approved by Mercedes-Benz may result in damage that is not covered by the Mercedes-Benz Limited Warranty.

**!** Using tires other than those approved by Mercedes-Benz can have detrimental effects, such as

- poor handling characteristics
- increased noise
- increased fuel consumption

Moreover, tires and rims not approved by Mercedes-Benz may, under load, exhibit dimensional variations and different tire deformation characteristics that could cause them to come into contact with the vehicle body or axle parts. Damage to the tires or the vehicle may be the result.

**i** Further information on tires and rims is available at any authorized Mercedes-Benz Center. The Tire and Loading Information placard with the recommended tire inflation pressures for cold tires is located on the driver's door B-pillar. Supplemental tire inflation pressure information for driving at high speeds or for vehicle loads less than the maximum loaded vehicle condition can be found on the tire inflation pressure label. The tire inflation pressure label is located on the inside of the fuel filler flap. The tire inflation pressure should be checked regularly and should only be adjusted on cold tires. Follow tire manufacturer's maintenance recommendation included with the vehicle.

For information on recommended tire inflation pressure and supplemental tire inflation pressure information for special driving situations, see (▷ page 198).

**i** Please keep in mind that the vehicle must be equipped





- with wheels of identical dimensions on each axle (left and right)
- with tires of identical characteristics all around, i.e. summer tires, winter tires, or all-season tires etc.

**i** The following pages also list the approved rim and tire sizes for equipping your vehicle with winter tires. Winter tires are not available as standard or optional factory equipment, but can be purchased from an authorized Mercedes-Benz Center.

Equipping your vehicle with winter tires approved for your vehicle model may require the purchase of rims of the

recommended size for use with these winter tires. This depends on vehicle model and the standard or optional factory-

equipped wheel rim/tire configuration on your vehicle. For more information contact an authorized Mercedes-Benz Center.

Same size tires			
		<b>SLK 300</b>	
16" wheels	Rims (light alloy)	7 J x 16 H2	
	Wheel offset	1.34 in (34 mm)	
	Winter tires <sup>26,27</sup>	205/55 R16 91H M+S 	
17" wheels		<b>SLK 300</b> <b>SLK 300 (Sport Package)</b> <b>SLK 350</b> <b>SLK 350 (Sport Package)</b>	<b>SLK 55 AMG</b>
	Rims (light alloy)	7.5 J x 17 H2	—
	Wheel offset	1.42 in (36 mm)	—
	AMG rims (light alloy)	—	7.5 J x 17 H2
	Wheel offset	—	1.46 in (37 mm)
Winter tires <sup>26,27</sup>	225/45 R17 91H M+S 	205/50 R17 89H M+S  <sup>28</sup>	
Winter tires <sup>26,27</sup>	—	225/45 R17 91H M+S  <sup>28</sup>	
18" wheels		<b>SLK 55 AMG</b> <b>SLK 55 AMG (Performance Package)</b>	
	AMG rims (light alloy)	7.5 J x 18 H2	
	Wheel offset	1.46 in (37 mm)	
	Winter tires <sup>26,27,28</sup>	225/40 R18 92H XL (Extra Load) M+S 	

<sup>26</sup> Radial-ply tires.

<sup>27</sup> Not available as factory equipment.

<sup>28</sup> For use with snow chains, contact an authorized Mercedes-Benz Center.

Mixed size tires			
			<b>SLK 300<sup>29</sup></b>
<b>16"</b> <b>wheels</b>	<b>Front axle</b>	<b>Rims (light alloy)</b>	7 J x 16 H2
		<b>Wheel offset</b>	1.34 in (34 mm)
		<b>Summer tires<sup>30</sup></b>	205/55 R16 91W
	<b>Rear axle</b>	<b>Rims (light alloy)</b>	8 J x 16 H2
		<b>Wheel offset</b>	1.18 in (30 mm)
		<b>Summer tires<sup>30,31</sup></b>	225/50 R16 92W
			<b>SLK 300<sup>32</sup></b> <b>SLK 300 (Sport Package)<sup>29</sup></b> <b>SLK 350<sup>32</sup></b>
<b>17"</b> <b>wheels</b>	<b>Front axle</b>	<b>Rims (light alloy)</b>	7.5 J x 17 H2
		<b>Wheel offset</b>	1.42 in (36 mm)
		<b>Summer tires<sup>30</sup></b>	225/45 R17 91W
	<b>Rear axle</b>	<b>Rims (light alloy)</b>	8.5 J x 17 H2
		<b>Wheel offset</b>	1.18 in (30 mm)
		<b>Summer tires<sup>30,31</sup></b>	245/40 R17 91W
			<b>SLK 300 (AMG Sport Package)<sup>32</sup></b> <b>SLK 350<sup>29</sup></b> <b>SLK 350 (AMG Sport Package)<sup>32</sup></b> <b>SLK 55 AMG</b> <b>SLK 55 AMG (Performance Package)</b>
<b>18"</b> <b>wheels</b>	<b>Front axle</b>	<b>AMG rims (light alloy)</b>	7.5 J x 18 H2
		<b>Wheel offset</b>	1.46 in (37 mm)
		<b>Summer tires<sup>30</sup></b>	225/40 ZR18 92Y XL (Extra Load)
	<b>Rear axle</b>	<b>AMG rims (light alloy)</b>	8.5 J x 18 H2
		<b>Wheel offset</b>	1.18 in (30 mm)
		<b>Summer tires<sup>30,31</sup></b>	245/35 ZR18 92Y XL (Extra Load)

<sup>29</sup> Canada only.<sup>30</sup> Radial-ply tires.<sup>31</sup> Must not be used with snow chains.<sup>32</sup> USA only.

## 300 Fuels, coolants, lubricants, etc.

## Spare wheel

- !** Compare the recommended tire inflation pressure for your vehicle with the tire inflation pressure on the yellow label located on the spare wheel rim.  
If the tire inflation pressure on the yellow label on the spare wheel rim differs from the values given in this Operator's Manual, inflate the tire to the recommended tire inflation pressure given on the yellow label on the spare wheel rim.
- i** Please note that the tire inflation pressure of the spare wheel differs from the tire inflation pressure of the road tires.
- i** The SLK 55 AMG with Performance Package does not have a spare wheel. The SLK 55 AMG with Performance Package is equipped with TIREFIT (▷ page 273).

## Technical data

	All models (except SLK 55 AMG with Performance Package)
Rim	4.5 B x 17 H2
Wheel offset	0.47 in (12 mm)
Collapsible tire <sup>33</sup>	145/70-17 92P
Recommended tire inflation pressure	51 psi (3.5 bar)

## Fuels, coolants, lubricants, etc.

## Capacities

Vehicle components and their respective lubricants must match. Therefore only use products tested and approved by Mercedes-Benz.

For information on tested and approved products, contact an authorized Mercedes-Benz Center or visit [www.mbusa.com](http://www.mbusa.com) (USA only).

## ⚠ Warning!

Comply with all valid regulations with respect to handling, storing, and disposing of service

fluids. Otherwise you could endanger persons or the environment.

Keep service fluids out of the reach of children.

For health reasons, you should prevent service fluids from coming into direct contact with your skin or clothing.

If a service fluid is swallowed, contact a physician immediately.

<sup>33</sup> Must not be used with snow chains.

	Model	Capacity	Fuels, coolants, lubricants, etc.
<b>Engine with oil filter</b>	All models	8.5 US qt (8.0 l)	Approved engine oils
<b>Manual transmission</b>	SLK 300 SLK 350	1.6 US qt (1.5 l)	MB Manual Transmission Fluid
<b>Automatic transmission</b>	SLK 300 SLK 350	9.8 US qt (9.3 l)	MB Automatic Transmission Fluid
	SLK 55 AMG	9.2 US qt (8.7 l)	
<b>Rear axle</b>	SLK 300	1.1 US qt (1.0 l)	MB Hypoid Gear Oil (SAE 85W-90)
	SLK 350	1.2 US qt (1.1 l)	
	SLK 55 AMG	1.3 US qt (1.2 l)	Fuchs Titan EG 5010 D
<b>Power steering</b>	All models	approx. 1.1 US qt (1.0 l)	MB Power Steering Fluid (Chevron Texaco PSF 9109)
<b>Brake system</b>	All models	0.53 US qt (0.5 l)	MB Brake Fluid (DOT 4+)
<b>Cooling system</b>	SLK 300 SLK 350	approx. 10.4 US qt (9.8 l)	MB 325.0 Anticorrosion/Antifreeze
	SLK 55 AMG	approx. 11.7 US qt (11.1 l)	
<b>Fuel tank</b>	All models	18.5 US gal (70.0 l)	Premium unleaded gasoline (Minimum Posted Octane 91 [Avg. of 96 RON/86 MON])
<b>Fuel tank reserve</b>	SLK 300 SLK 350	approx. 2.4 US gal (9.0 l)	
	SLK 55 AMG	approx. 2.6 US gal (10.0 l)	
<b>Air conditioning system</b>	All models	–	R134a refrigerant and special PAG lubricant oil (never R 12)

## 302 Fuels, coolants, lubricants, etc.

	Model	Capacity	Fuels, coolants, lubricants, etc.
<b>Hydraulic system for retractable hardtop</b>	All models	0.2 US qt (0.195 l)	MB Hydraulic Oil
<b>Washer system and headlamp cleaning system</b>	All models	7.4 US qt (7.0 l)	MB Windshield Washer Concentrate <sup>34</sup> (▷ page 306) Washer fluid mixing ratio (▷ page 306)

## Technical data

**Approved engine oils**

Engine oils are specifically tested for their suitability in our engines and durability for our service intervals. Therefore, only use approved engine oils and oil filters required for vehicles with the Maintenance System.

For a listing of approved engine oils and oil filters, contact an authorized Mercedes-Benz Center or visit [www.mbusa.com](http://www.mbusa.com) (USA only).

**!** Using engine oils and oil filters of a specification other than those expressly required for the Maintenance System, or changing of oil and oil filter at change intervals longer than those called for by the Maintenance System will result in engine or emission control system damage not covered by the Mercedes-Benz Limited Warranty.

Please follow Maintenance System recommendations for scheduled oil changes. Failure to do so will result in engine or emission control system damage not covered by the Mercedes-Benz Limited Warranty.

Mercedes-Benz recommends MOBIL OIL.

Use the table below to determine the MB sheet number.

Model	Engine, type	MB sheet number
SLK 300	272	229.5
SLK 350	272	229.5
SLK 55 AMG	113	229.5

**i** MB sheet numbers are printed on the outside of oil containers.

**Viscosity grades for engine oils**

Using the chart below, select oil viscosity according to the lowest air temperature expected before the next oil change.

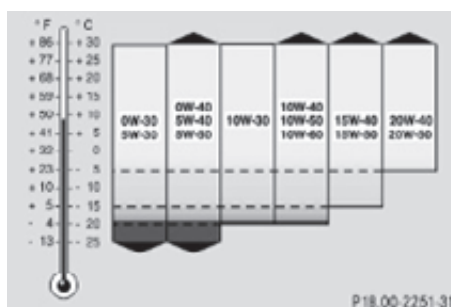

<sup>34</sup> Mixed with water or commercially available premixed washer solvent/antifreeze.



### Engine oil additives

- ❗ Do not blend oil additives with engine oil. They may damage the engine. Damage or malfunctions resulting from blending oil additives are not covered by the Mercedes-Benz Limited Warranty.

### Air conditioning refrigerant

R 134a (HFC) refrigerant and special PAG lubricating oil are used in the air conditioning system.

- ❗ Never use R 12 (CFC) or mineral-based lubricating oil. Otherwise damage to the system will occur.

### Brake fluid

#### ⚠ Warning!

During vehicle operation, the boiling point of the brake fluid is continuously reduced through the absorption of moisture from the atmosphere.

Under extremely strenuous operating conditions, this moisture content can lead to the formation of bubbles in the system, thus reducing the system's efficiency.

Therefore, the brake fluid must be replaced regularly. Refer to your vehicle's Maintenance Booklet for replacement interval.

Only brake fluid approved by Mercedes-Benz is recommended. Any authorized Mercedes-Benz Center will provide you with additional information.

### Premium unleaded gasoline

#### ⚠ Warning!

Gasoline is highly flammable and poisonous. It burns violently and can cause serious personal injury.

Never allow sparks, flames or smoking materials near gasoline!

Turn off the engine before refueling.

Whenever you are around gasoline, avoid inhaling fumes and any skin or clothing contact. Extinguish all smoking materials.

Direct skin contact with fuels and the inhalation of fuel vapors are damaging your health.

- ❗ To maintain the engine's durability and performance, premium unleaded gasoline must be used.

If premium unleaded gasoline is not available and low octane gasoline is used, follow these precautions:

- Have the fuel tank only partially filled with unleaded regular gasoline and fill up with premium unleaded gasoline as soon as possible.
- Avoid full throttle driving and abrupt acceleration.
- Do not exceed an engine speed of 3000 rpm if the vehicle is loaded with a light load such as two persons and no luggage.
- Do not exceed  $\frac{2}{3}$  of maximum accelerator pedal position if the vehicle is fully loaded or operating in mountainous terrain.

### Fuel requirements

Only use premium unleaded gasoline. The octane number (posted at the pump) must be 91 min. It is an average of both the Research Octane Number (RON) and the Motor Octane Number (MON):  $(RON+MON)/2$ . This is also known as the ANTI-KNOCK INDEX.

Reformulated gasolines (RFG) and/or unleaded gasoline containing oxygenates such as ethanol, TAME, ETBE, IPA, IBA, and TBA can be used provided the ratio of any one

304 **Fuels, coolants, lubricants, etc.**

of these oxygenates to gasoline does not exceed 10%; MTBE must not exceed 15%.

The ratio of methanol to gasoline must not exceed 3% plus additional cosolvents.

Using mixtures of ethanol and methanol is not allowed. Gasohol, which contains 10% ethanol and 90% unleaded gasoline, can be used.

These blends must also meet all other fuel requirements, such as resistance to spark knock, boiling range, vapor pressure, etc.

### Gasoline additives

A major concern among engine manufacturers is carbon build-up caused by gasoline. Mercedes-Benz recommends only the use of quality gasoline containing additives that prevent the build-up of carbon deposits.

After an extended period of using fuels without such additives carbon deposits can build up, especially on the intake valves and in the combustion area, leading to engine performance problems such as:

- Warm-up hesitation
- Unstable idle
- Knocking/pinging
- Misfire
- Power loss

In areas where carbon deposits may be encountered due to lack of availability of gasoline which contains these additives, the use of Mercedes-Benz approved additives is recommended.

Contact an authorized Mercedes-Benz Center or visit [www.mbusa.com](http://www.mbusa.com) (USA only) for a listing of approved products. Follow directions on the product label.

Do not blend other fuel additives with fuel. This only results in unnecessary cost and may be harmful to the engine operation.

**!** Damage or malfunction resulting from poor fuel quality or from blending additional fuel additives other than those tested and approved by us for use on Mercedes-Benz vehicles are not covered by the Mercedes-Benz Limited Warranty or by any pre-owned or Extended Limited Warranties.

### Coolants

The engine coolant is a mixture of water and anticorrosion/antifreeze, which provides:

- Corrosion protection
- Freeze protection
- Boiling protection (by increasing the boiling point)

The cooling system was filled at the factory with a coolant providing freeze protection to approximately -35°F (-37°C) and corrosion protection.

**!** Add premixed coolant solution only. Adding water and MB 325.0 Anticorrosion/Antifreeze separately from each other, could cause engine damage not covered by the Mercedes-Benz Limited Warranty.

If the antifreeze mixture is effective to -35°F (-37°C), the boiling point of the coolant in the pressurized cooling system is reached at approximately 266°F (130°C).

The coolant solution must be used year round to provide the necessary corrosion protection and increase boil-over protection. Refer to the Maintenance Booklet for replacement interval.

Coolant system design and coolant used determine the replacement interval. The replacement interval published in the Maintenance Booklet is only applicable if MB 325.0 Anticorrosion/Antifreeze solution or other Mercedes-Benz approved products of equal specification are used to renew the coolant concentration or bring it back up to the proper level.

For information on other Mercedes-Benz approved products of equal specification, contact an authorized Mercedes-Benz Center or visit **www.mbusa.com** (USA only).

To provide important corrosion protection, the solution must be at least 50% anticorrosion/antifreeze (equivalent to freeze protection to approximately -35°F [-37°C]).

If you use a solution that is more than 55% anticorrosion/antifreeze (freeze protection to approximately -49°F [-45°C]), the engine temperature will increase due to the lower heat transfer capability of the solution. Therefore, do not use more than this amount of anticorrosion/antifreeze.

If the coolant level is low, water and MB 325.0 Anticorrosion/Antifreeze should be used to bring it up to the proper level (have cooling system checked for signs of leakage). Please make sure the mixture is in accordance with label instructions.

The water in the cooling system must meet minimum requirements, which are usually satisfied by normal drinking water.

If you are not sure about the water quality, contact an authorized Mercedes-Benz Center.

### Anticorrosion/antifreeze

Your vehicle contains a number of aluminum parts. The use of aluminum components in motor vehicle engines necessitates that anticorrosion/antifreeze coolant used in such engines be specifically formulated to protect the aluminum parts. Failure to use such anticorrosion/antifreeze coolant will result in a significantly shortened service life.

Therefore, the following product is strongly recommended for use in your vehicle: MB 325.0 Anticorrosion/Antifreeze agent.

Before the start of the winter season (or once a year in hot southern regions), you should have the anticorrosion/antifreeze concentration checked.

The coolant is also regularly checked each time you bring your vehicle to an authorized Mercedes-Benz Center for service.

	Model	Approximate freeze protection	
		-35°F (-37°C)	-49°F (-45°C)
Cooling system	SLK 300	5.2 US qt (4.9 l)	5.7 US qt (5.4 l)
	SLK 350		
	SLK 55 AMG	5.9 US qt (5.55 l)	6.5 US qt (6.1 l)

### Washer system and headlamp cleaning system

#### **Warning!**

Washer solvent/antifreeze is highly flammable. Do not spill washer solvent/antifreeze on hot engine parts, because it may ignite and burn. You could be seriously burned.

- ▶ Use MB Windshield Washer Concentrate “MB SummerFit”.
- ▶ Mix with water for temperatures above freezing point.
- ▶ Mix with commercially available premixed washer solvent/antifreeze for temperatures below freezing point.

#### **Washer fluid mixing ratio**

For temperatures above the freezing point:

1 part “MB SummerFit” to 100 parts water  
(1.34 fl oz [40 ml] “MB SummerFit” to 1 gal [4.0 l] water)

For temperatures below freezing point:

1 part “MB SummerFit” to 100 parts solvent  
(1.34 fl oz [40 ml] “MB SummerFit” to 1 gal [4.0 l] solvent)

# امداد خودرو فارما

تلفن شبانه روزی: ۰۲۱-۸۸۸۶۲۰۸۵

[FarmaSOS.com](http://FarmaSOS.com)

# امداد خودرو فارما

تلفن شبانه روزی: ۰۲۱-۸۸۸۶۲۰۸۵

[FarmaSOS.com](http://FarmaSOS.com)

## Service and Literature

Your authorized Mercedes-Benz Center has trained technicians and Genuine Mercedes-Benz Parts to service your vehicle properly. For expert advice and quality service, contact an authorized Mercedes-Benz Center.

If you are interested in obtaining service literature for your vehicle, please contact an authorized Mercedes-Benz Center.

We consider this the best way for you to obtain accurate information for your vehicle.

For further information you can find us on the Mercedes-Benz web site **www.mbusa.com** (USA only) or **www.mercedes-benz.ca** (Canada only).

### **Warning!**

To help avoid personal injury, be extremely careful when performing any service work or repairs. Improper or incomplete service or the use of incorrect or inappropriate parts or materials may damage the vehicle or its equipment, which may in turn result in personal injury.

If you have any questions about carrying out any type of service, turn to the advice of an authorized Mercedes-Benz Center.

We reserve the right to make changes in design and equipment.

Therefore, information, illustrations and descriptions in this Operator's Manual might differ from your vehicle.

Reprinting, translation and copying, even of excerpts, is not permitted without our prior authorization in writing.

Press time May 13, 2009

GSP/OIS

Printed in U. S. A.

# امداد خودرو فارما

تلفن شبانه روزی: ۰۲۱-۸۸۸۶۲۰۸۵

[FarmaSOS.com](http://FarmaSOS.com)



1715842796

Order no. 6515 3297 13 Part no. 171 584 27 96 Edition A 2010