

## TABLE OF CONTENTS

1	<b>Before driving</b>	Adjusting and operating features such as door locks, mirrors, and steering column
2	<b>When driving</b>	Driving, stopping and safe-driving information
3	<b>Interior features</b>	Air conditioning and audio systems, as well as other interior features for a comfortable driving experience
4	<b>Maintenance and care</b>	Cleaning and protecting your vehicle, performing do-it-yourself maintenance, and maintenance information
5	<b>When trouble arises</b>	What to do if the vehicle needs to be towed, gets a flat tire, or is involved in an accident
6	<b>Vehicle specifications</b>	Detailed vehicle information
7	<b>For U.S. owners</b>	Reporting safety defects for U.S. owners
	<b>Index</b>	Alphabetical listing of information contained in this manual

<p><b>1 Before driving</b></p> <p><b>1-1. Key information</b>  Keys ..... 24</p> <p><b>1-2. Opening, closing and locking the doors</b>  Smart key system..... 26  Wireless remote control ..... 39  Side doors ..... 42  Back door..... 47</p> <p><b>1-3. Adjustable components (seats, mirrors, steering wheel)</b>  Front seats ..... 52  Rear seats..... 54  Driving position memory system..... 63  Head restraints..... 67  Seat belts ..... 71  Steering wheel ..... 80  Inside rear view mirror..... 81  Outside rear view mirrors ..... 83</p> <p><b>1-4. Opening and closing the windows and moon roof</b>  Power windows ..... 86  Moon roof..... 89</p> <p><b>1-5. Refueling</b>  Opening the fuel tank cap .... 92</p>	<p><b>1-6. Theft deterrent system</b>  Engine immobilizer system ..... 96  Alarm ..... 98</p> <p><b>1-7. Safety information</b>  Correct driving posture ..... 102  SRS airbags ..... 104  Front passenger occupant classification system..... 119  Child restraint systems ..... 125  Installing child restraints ..... 129</p> <hr/> <p><b>2 When driving</b></p> <p><b>2-1. Driving procedures</b>  Driving the vehicle ..... 144  Engine (ignition) switch..... 154  Automatic transmission ..... 158  Turn signal lever ..... 163  Parking brake ..... 164  Horn..... 165</p> <p><b>2-2. Instrument cluster</b>  Gauges and meters ..... 166  Indicators and warning lights ..... 169  Multi-information display..... 172</p> <p><b>2-3. Operating the lights and wipers</b>  Headlight switch ..... 175  Fog light switch..... 178</p>
--	--

Windshield wipers and washer .....	179
Rear window wiper and washer .....	184
Headlight cleaner switch .....	185

**2-4. Using other driving systems**

Cruise control.....	186
Intuitive parking assist.....	190
Four-wheel drive system.....	199
Crawl Control .....	204
Driving assist systems .....	208
Pre-Collision System.....	214

**2-5. Driving information**

Off-road precautions .....	215
Cargo and luggage .....	220
Vehicle load limits .....	227
Winter driving tips .....	228
Trailer towing .....	233
Dinghy towing .....	245

**3 Interior features**

**3-1. Using the air conditioning system and defogger**

Front air conditioning system .....	248
Rear air conditioning system .....	258
Rear window and outside rear view mirror defoggers.....	262
Windshield wiper de-icer.....	263

**3-2. Using the audio system**

Audio system type.....	264
Using the radio .....	267
Using the CD player .....	276
Playing back MP3 and WMA discs .....	284
Operating an iPod .....	291
Operating a USB memory.....	298
Optimal use of the audio system .....	306
Using the AUX port.....	308
Using the steering switches .....	309

**3-3. Using the Bluetooth® audio system**

Bluetooth® audio system....	313
Using the Bluetooth® audio system .....	316
Operating a Bluetooth® enabled portable player....	322
Setting up a Bluetooth® enabled portable player....	325
Bluetooth® audio system setup .....	332

**3-4. Using the hands-free system (for cellular phone)**

Hands-free system (for cellular phone) .....	333
Using the hands-free system.....	337
Making a phone call .....	345
Setting a cellular phone.....	350
Security and system setup .....	356
Using the phone book .....	362

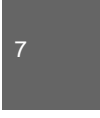
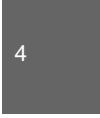

**3-5. Using the interior lights**

Interior lights list ..... 371

- Interior lights ..... 372
- Personal lights ..... 373

**3-6. Using the storage features**

List of storage features..... 374

- Glove box..... 375
- Console box ..... 376
- Overhead console ..... 377
- Cup holders..... 378
- Bottle holders ..... 379
- Card holders ..... 381
- Auxiliary box..... 381

**3-7. Other interior features**

Cool box ..... 382

Sun visors ..... 384

Vanity mirror ..... 385

Clock ..... 386

Outside temperature display ..... 387

Ashtrays ..... 388

Cigarette lighter ..... 390

Power outlets ..... 391

Seat heaters ..... 393

Armrest..... 395

Floor mats ..... 396

Luggage compartment features ..... 397

Garage door opener ..... 399

Safety Connect..... 406

**4 Maintenance and care**

**4-1. Maintenance and care**

Cleaning and protecting the vehicle exterior ..... 414

Cleaning and protecting the vehicle interior ..... 417

**4-2. Maintenance**

Maintenance requirements ..... 420

General maintenance ..... 422

Emission inspection and maintenance (I/M) programs ..... 425

**4-3. Do-it-yourself maintenance**

Do-it-yourself service precautions ..... 426

Hood ..... 429

Engine compartment ..... 430

Tires..... 445

Tire inflation pressure ..... 454

Wheels..... 458

Air conditioning filter ..... 460

Electronic key battery ..... 463

Checking and replacing fuses ..... 466

Light bulbs ..... 479

## 5 When trouble arises

### 5-1. Essential information

- Emergency flashers ..... 492
- If your vehicle needs  
to be towed ..... 493
- If you think something  
is wrong ..... 498
- Fuel pump shut off  
system ..... 499
- Event data recorder ..... 500

### 5-2. Steps to take in an emergency

- If a warning light turns on  
or a warning sounds... ..... 502
- If a warning message  
is displayed ..... 513
- If you have a flat tire ..... 516
- If the engine will not start .... 530
- If the shift lever cannot  
be shifted from P..... 532
- If you lose your keys ..... 533
- If you cannot operate  
back door opener ..... 534
- If the electronic key  
does not operate  
properly ..... 535
- If the battery  
is discharged ..... 538
- If your vehicle overheats ..... 541
- If the vehicle  
becomes stuck ..... 544
- If your vehicle has to  
be stopped in  
an emergency ..... 545

## 6 Vehicle specifications

### 6-1. Specifications

- Maintenance data  
(fuel, oil level, etc.) ..... 548
- Fuel information ..... 558
- Tire information ..... 561

### 6-2. Customization

- Customizable features ..... 573

### 6-3. Initialization

- Items to initialize ..... 582

## 7 For U.S. owners

- Reporting safety defects  
for U.S. owners ..... 584

## Index

- Abbreviation list ..... 586

- Alphabetical index ..... 588

- What to do if ..... 596

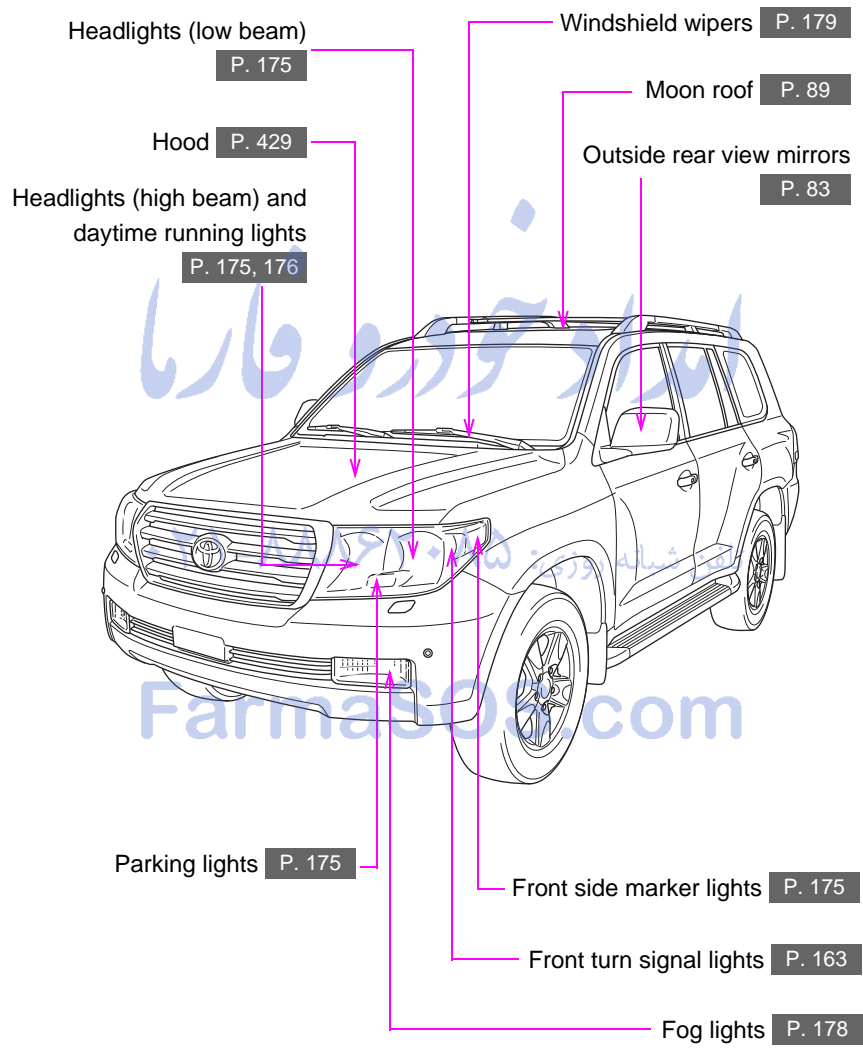

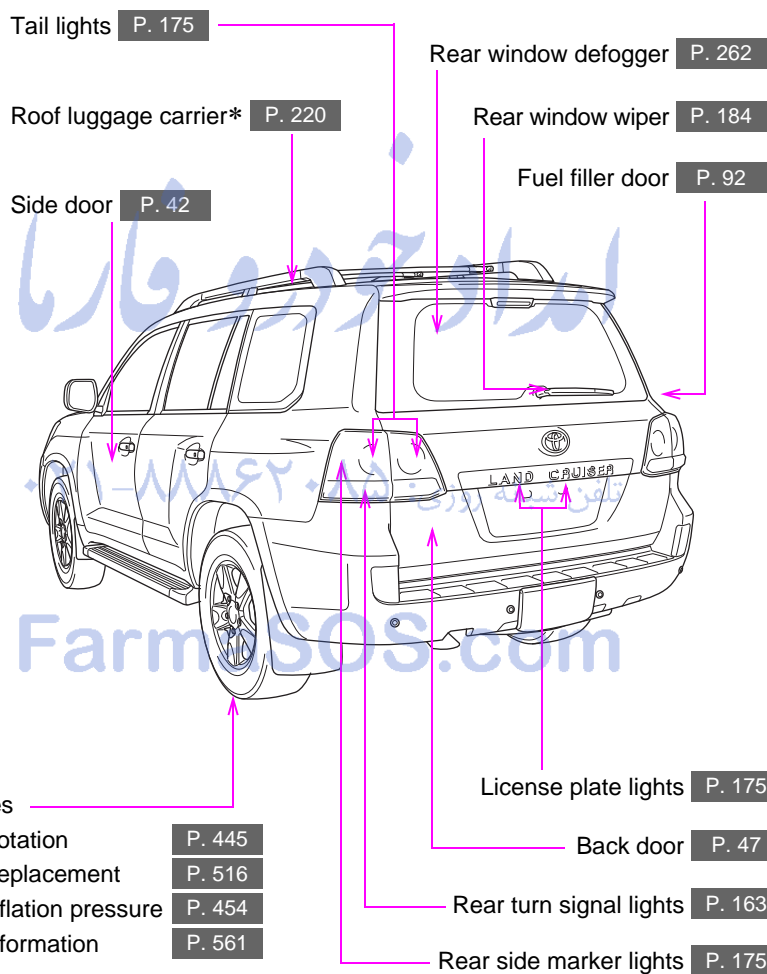

\*: If equipped

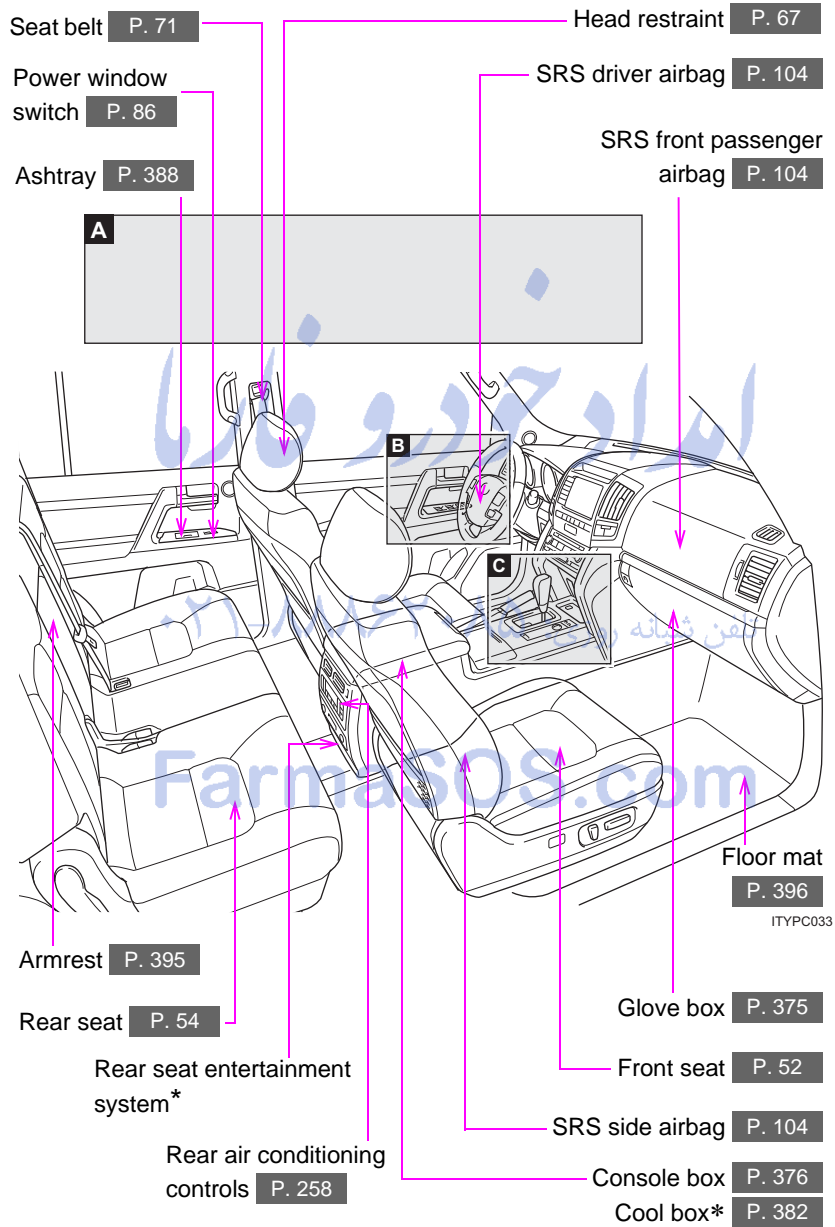



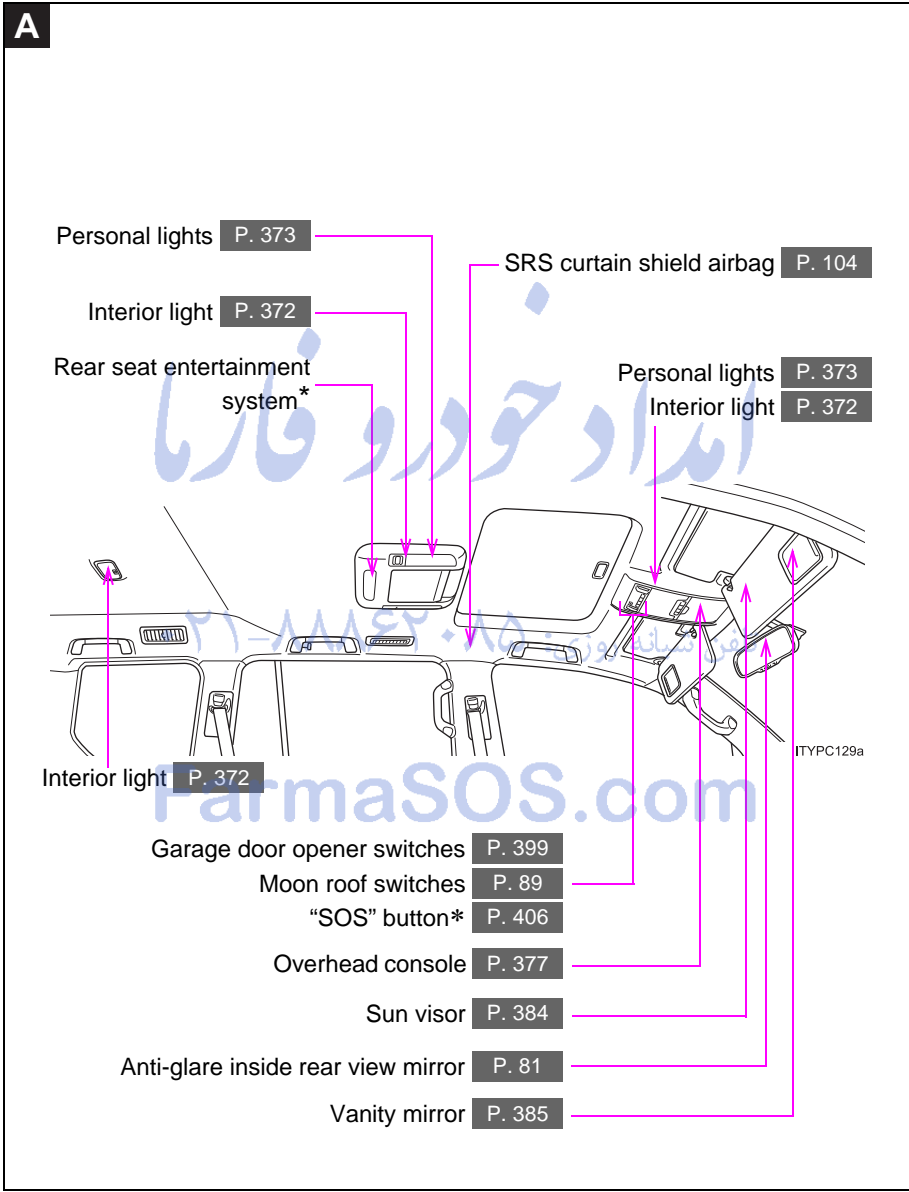

\*: If equipped  
 \*: Refer to "Navigation System Owner's Manual".

**B**

Driving position memory switches P. 63

Door lock switch P. 42

Power window switches P. 86

Window lock switch P. 86

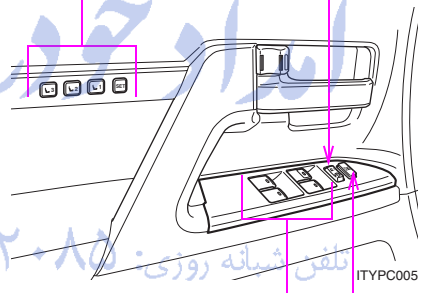

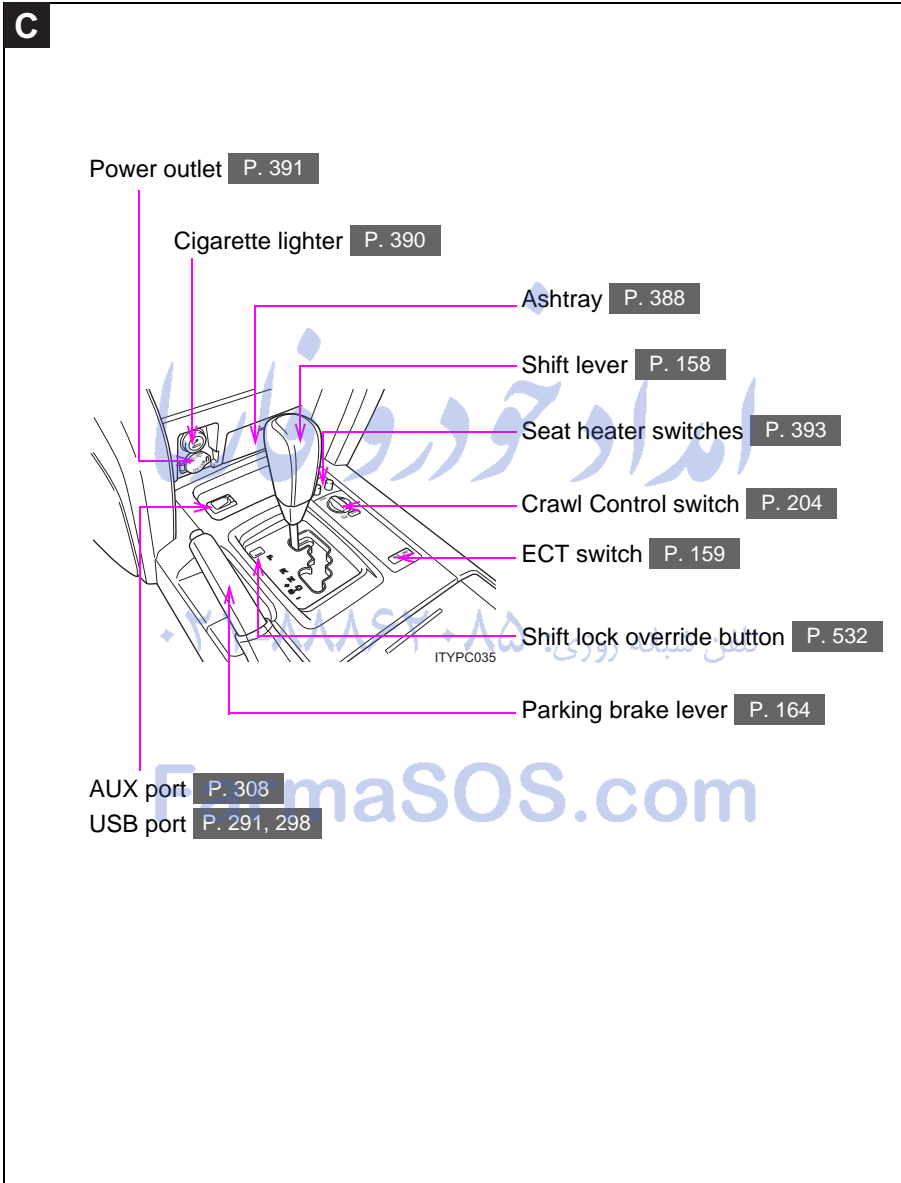

## Pictorial index

## Instrument panel

Headlight switch P. 175

Turn signal lever P. 163

Fog light switch P. 178

Audio remote controls (steering switches) P. 309

Gauges and meters P. 166

Multi-information display P. 172

Windshield wipers and washer switch P. 179

Rear window wiper and washer switch P. 184

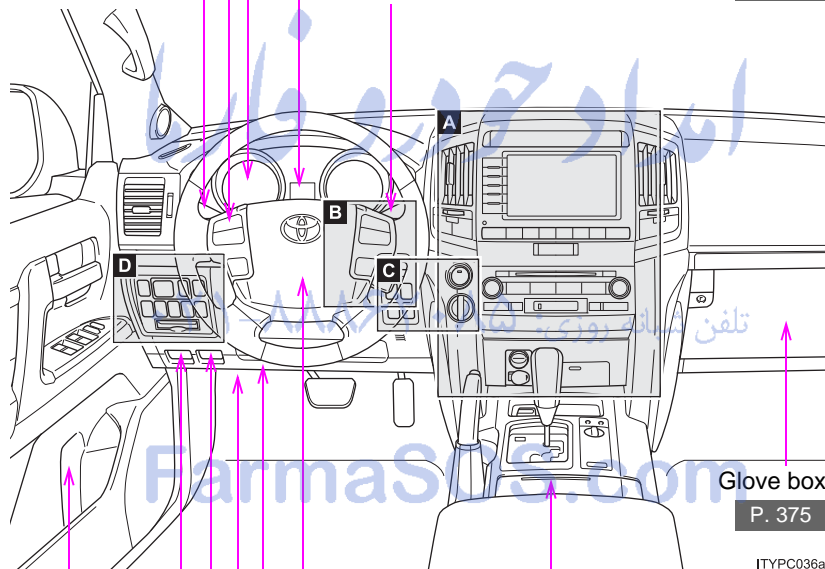

Glove box  
P. 375

ITYPC036a

Horn P. 165

Cup holders P. 378

SRS knee airbags P. 104

Tire pressure warning  
reset switch P. 445

Hood opener P. 429

Fuel filler door opener P. 92

Bottle holder P. 379

**A**

▶ Without navigation system

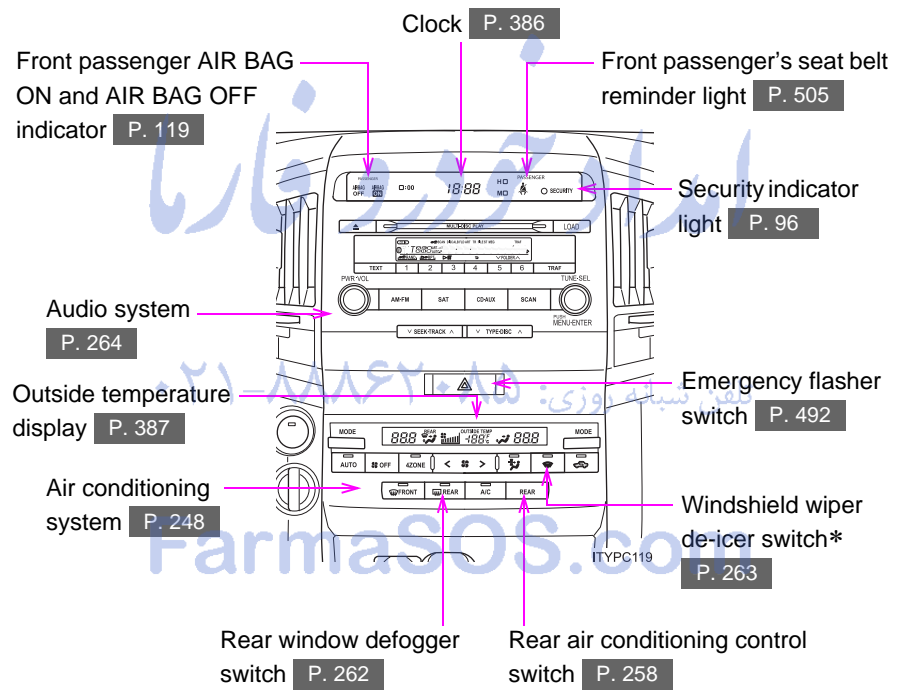

\*: If equipped

**A**

► With navigation system

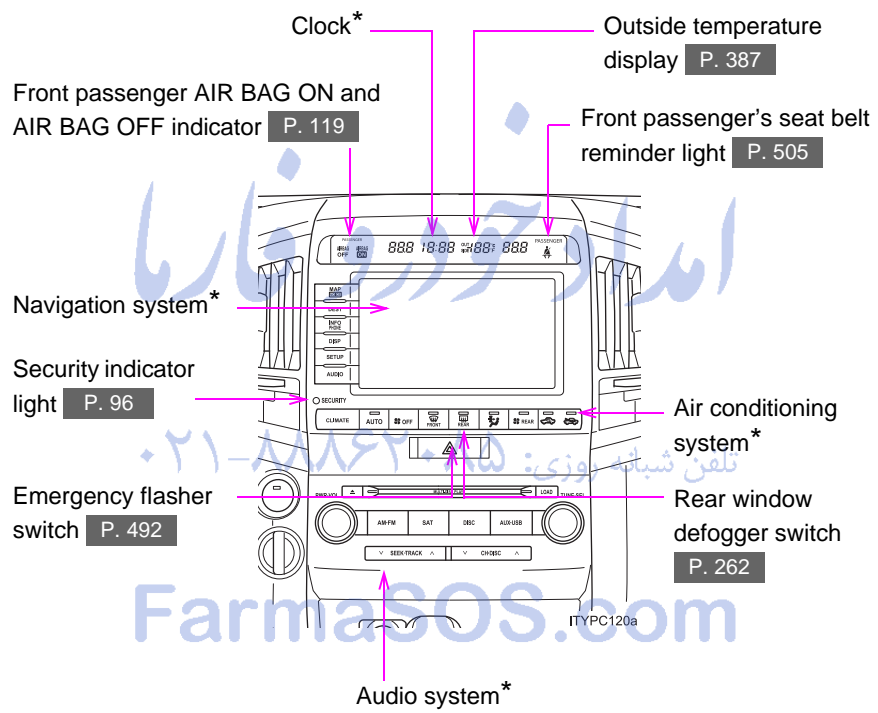

**B**

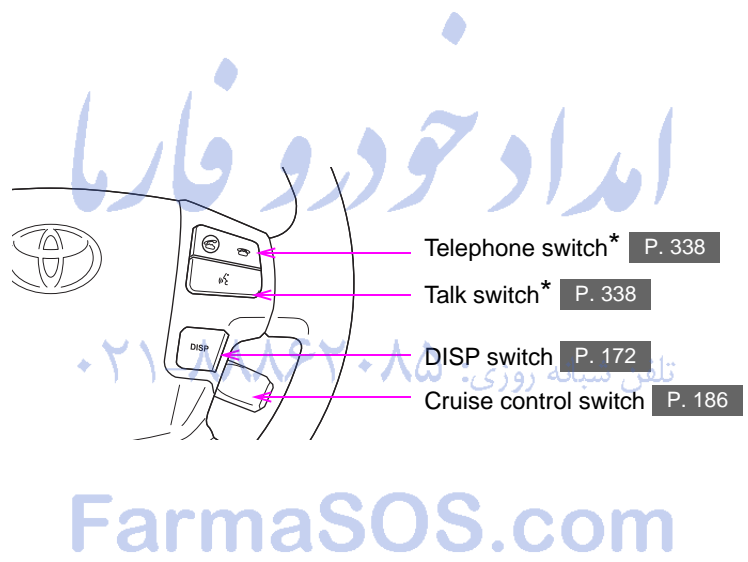

\*: Refer to "Navigation System Owner's Manual".

C

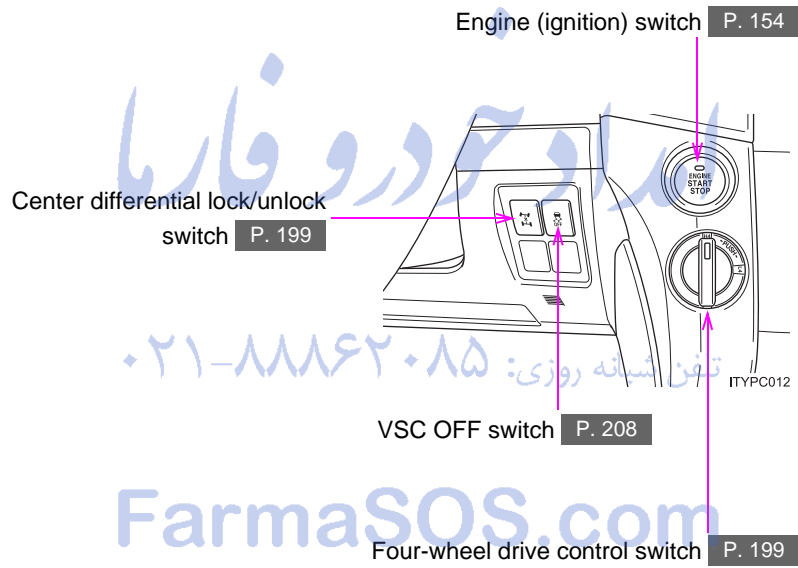



**D**

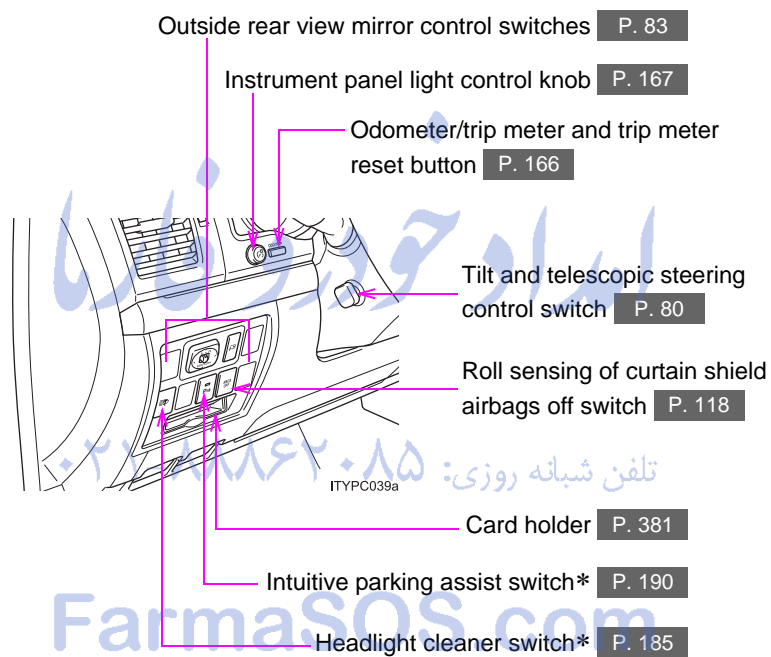

\*: If equipped

## For your information

### **Main Owner's Manual**

Please note that this manual applies to all models and explains all equipment, including options. Therefore, you may find some explanations for equipment not installed on your vehicle.

All specifications provided in this manual are current at the time of printing. However, because of the Toyota policy of continual product improvement, we reserve the right to make changes at any time without notice.

Depending on specifications, the vehicle shown in the illustration may differ from your vehicle in terms of equipment.

### **Noise from under vehicle after turning off the engine**

Approximately five hours after the engine is turned off, you may hear sound coming from under the vehicle for several minutes. This is the sound of a fuel evaporation leakage check and, it does not indicate a malfunction.

### **Accessories, spare parts and modification of your Toyota**

A wide variety of non-genuine spare parts and accessories for Toyota vehicles are currently available in the market. You should know that Toyota does not warrant these products and is not responsible for their performance, repair, or replacement, or for any damage they may cause to, or adverse effect they may have on, your Toyota vehicle.

This vehicle should not be modified with non-genuine Toyota products. Modification with non-genuine Toyota products could affect its performance, safety or durability, and may even violate governmental regulations. In addition, damage or performance problems resulting from the modification may not be covered under warranty.

### **Installation of a mobile two-way radio system**

As the installation of a mobile two-way radio system in your vehicle could affect electronic systems such as the multiport fuel injection system/sequential multiport fuel injection system, cruise control system, anti-lock brake system, SRS airbag system and seat belt pretensioner system, be sure to check with your Toyota dealer for precautionary measures or special instructions regarding installation.

### **Scrapping of your Toyota**

The SRS airbag and seat belt pretensioner devices in your Toyota contain explosive chemicals. If the vehicle is scrapped with the airbags and seat belt pretensioners left as they are, this may cause an accident such as fire. Be sure to have the systems of the SRS airbag and seat belt pretensioner removed and disposed of by a qualified service shop or by your Toyota dealer before you scrap your vehicle.

### **Perchlorate Material**

Special handling may apply,  
See [www.dtsc.ca.gov/hazardouswaste/perchlorate](http://www.dtsc.ca.gov/hazardouswaste/perchlorate).  
Your vehicle has components that may contain perchlorate. These components may include airbag, seat belt pretensioners, and wireless remote control batteries.

FarmaSOS.com

 CAUTION

■ **General precautions while driving**

**Driving under the influence:** Never drive your vehicle when under the influence of alcohol or drugs that have impaired your ability to operate your vehicle. Alcohol and certain drugs delay reaction time, impair judgment and reduce coordination, which could lead to an accident that could result in death or serious injury.

**Defensive driving:** Always drive defensively. Anticipate mistakes that other drivers or pedestrians might make and be ready to avoid accidents.

**Driver distraction:** Always give your full attention to driving. Anything that distracts the driver, such as adjusting controls, talking on a cellular phone or reading can result in a collision with resulting death or serious injury to you, your occupants or others.

■ **General precaution regarding children's safety**

Never leave children unattended in the vehicle, and never allow children to have or use the key.

Children may be able to start the vehicle or shift the vehicle into neutral. There is also a danger that children may injure themselves by playing with the cigarette lighter, the windows, the moon roof, or other features of the vehicle. In addition, heat build-up or extremely cold temperatures inside the vehicle can be fatal to children.

FarmaSOS.com

## Symbols used throughout this manual

### Cautions & Notices

#### CAUTION

This is a warning against anything which may cause injury to people if the warning is ignored. You are informed about what you must or must not do in order to reduce the risk of injury to yourself and others.

#### NOTICE

This is a warning against anything which may cause damage to the vehicle or its equipment if the warning is ignored. You are informed about what you must or must not do in order to avoid or reduce the risk of damage to your Toyota and its equipment.

### Symbols used in illustrations



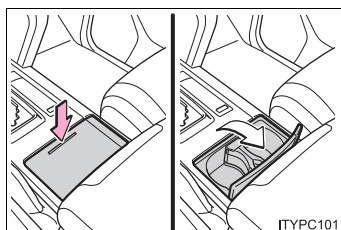

#### Safety symbol

The symbol of a circle with a slash through it means “Do not”, “Do not do this”, or “Do not let this happen”.



#### Arrows indicating operations

-  Indicates the action (pushing, turning, etc.) used to operate switches and other devices.
-  Indicates the outcome of an operation (e.g. a lid opens).

# امداد خودرو فارما

تلفن شبانه روزی: ۰۲۱-۸۸۸۶۲۰۸۵

**FarmaSOS.com**

## Before driving

# 1

<b>1-1. Key information</b>		<b>1-4. Opening and closing the windows and moon roof</b>	
Keys .....	24	Power windows .....	86
<b>1-2. Opening, closing and locking the doors</b>		Moon roof .....	89
Smart key system .....	26	<b>1-5. Refueling</b>	
Wireless remote control .....	39	Opening the fuel tank cap .....	92
Side doors .....	42	<b>1-6. Theft deterrent system</b>	
Back door .....	47	Engine immobilizer system .....	96
<b>1-3. Adjustable components (seats, mirrors, steering wheel)</b>		Alarm .....	98
Front seats .....	52	<b>1-7. Safety information</b>	
Rear seats .....	54	Correct driving posture .....	102
Driving position memory system .....	63	SRS airbags .....	104
Head restraints .....	67	Front passenger occupant classification system .....	119
Seat belts .....	71	Child restraint systems .....	125
Steering wheel .....	80	Installing child restraints .....	129
Inside rear view mirror .....	81		
Outside rear view mirrors .....	83		

## 1-1. Key information

### Keys

The following keys are provided with the vehicle.

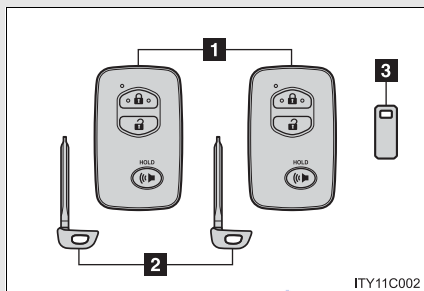

#### 1 Electronic keys

- Operating the smart key system (→P. 26)
- Operating the wireless remote control function (→P. 39)

#### 2 Mechanical keys

#### 3 Key number plate

### Using the mechanical key

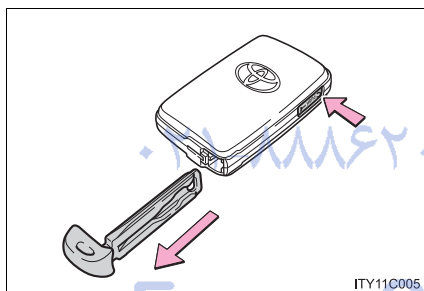

Take out the mechanical key.

After using the mechanical key, store it in the electronic key. Carry the mechanical key together with the electronic key. If the electronic key battery depletes or entry function does not operate properly, you will need the mechanical key. (→P. 535)



### ■ When required to leave the vehicle's key with a parking attendant

Lock the glove box as circumstances demand. (→P. 375)

Remove the mechanical key for your own use and provide the attendant with the electronic key only.

### ■ Key number plate

Keep the plate in a safe place such as your wallet, not in the vehicle. In the event that a key is lost, a new key can be made at your Toyota dealer using the key number plate. (→P. 533)

### ■ When riding in an aircraft

When bringing an electronic key onto an aircraft, make sure you do not press any buttons on the electronic key while inside the aircraft cabin. If you are carrying an electronic key in your bag etc., ensure that the buttons are not likely to be pressed accidentally. Pressing a button may cause the electronic key to emit radio waves that could interfere with the operation of the aircraft.

#### ⚠ NOTICE

#### ■ To prevent key damage

- Do not subject the keys to strong shocks, expose them to high temperatures by placing them in direct sunlight, or get them wet.
- Do not expose the keys to electromagnetic materials or attach any material that blocks electromagnetic waves to the key surface.
- Do not disassemble the electronic key.

## 1-2. Opening, closing and locking the doors Smart key system

The following operations can be performed simply by carrying the electronic key on your person, for example in your pocket.  
(The driver should always carry the electronic key.)

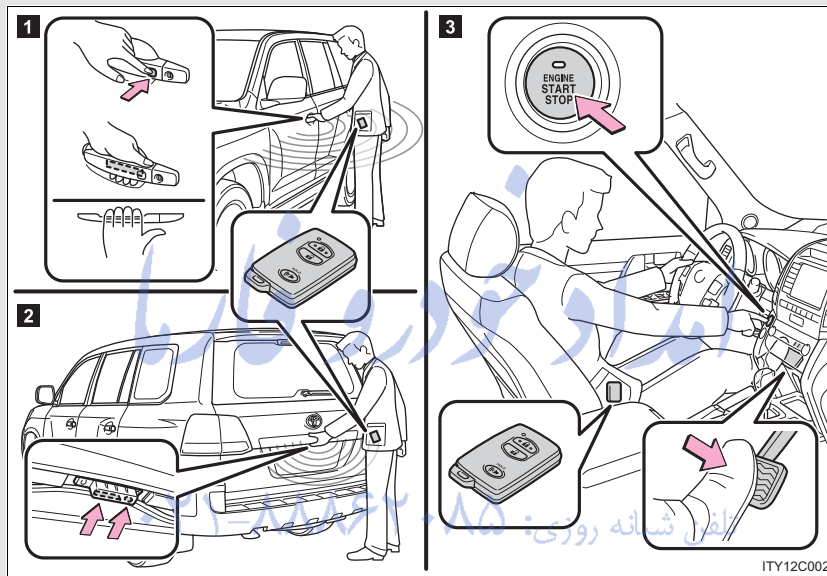

- 1** Locks and unlocks the doors (→P. 27)
- 2** Locks and unlocks the doors (→P. 27)
- 3** Starts and stops the engine (→P. 154)

## Unlocking and locking the doors

### ► Side door handle

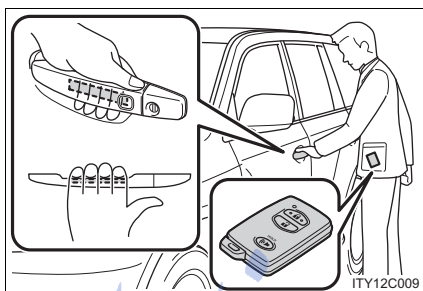

Grip the handle to unlock the doors.

Make sure to touch the sensor on the back of the handle.

The doors cannot be unlocked for 3 seconds after the doors are locked.

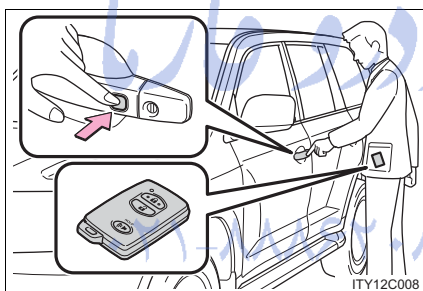

Press the lock button to lock the doors.

Pressing and holding the button closes the windows and moon roof. (This setting must be customized at your Toyota dealer.)

### ► Back door

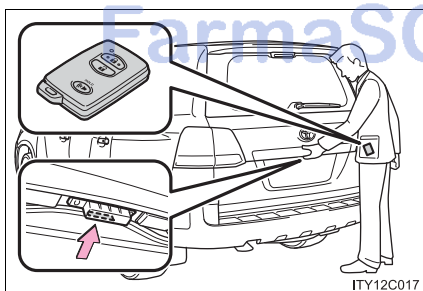

Press the unlock button to unlock the doors.

The door cannot be unlocked for 3 seconds after the door is locked.

Lock the back door again when you leave the vehicle. The back door will not lock automatically after it has been opened and then closed.

1

Before driving

## 1-2. Opening, closing and locking the doors

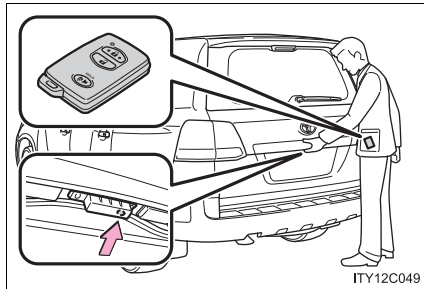

Press the lock button to lock the doors.

## Antenna location and effective range

### ■ Antenna location

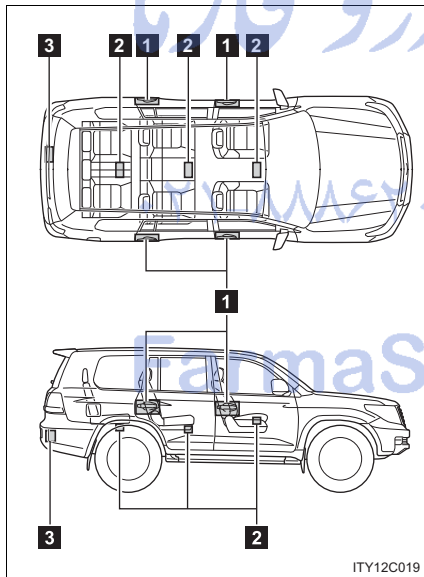

- 1 Antennas outside cabin
- 2 Antennas inside cabin
- 3 Antenna outside luggage compartment

■ **Effective range (areas within which the electronic key is detected)**

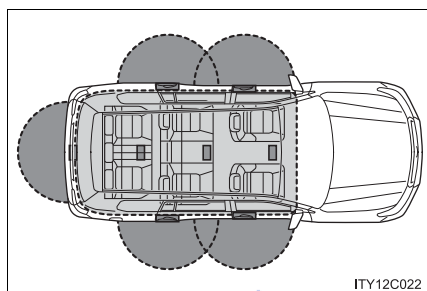

- When locking or unlocking the doors

The system can be operated when the electronic key is within about 2.3 ft. (0.7 m) of an outside door handle.

- When starting the engine or changing "ENGINE START STOP" switch modes

The system can be operated when the electronic key is inside the vehicle.

1

Before driving

تلفن شبانه روزی: ۰۲۱-۸۸۸۶۲۰۸۵

FarmaSOS.com

## 1-2. Opening, closing and locking the doors

### ■ Operation signals

A buzzer sounds and the emergency flashers flash to indicate that the doors have been locked/unlocked. (Locked: Once; Unlocked: Twice)

### ■ Conditions affecting operation

The smart key system uses weak radio waves. In the following situations, the communication between the electronic key and the vehicle may be affected, preventing the smart key system and wireless remote control from operating properly. (Ways of coping →P. 535)



- When the electronic key battery is depleted
- Near a TV tower, electric power plant, gas station, radio station, large display, airport or other facility that generates strong radio waves or electrical noise
- When carrying a portable radio, cellular phone, cordless phone or other wireless communication devices
- When the electronic key has come into contact with, or is covered by a metallic object
- When multiple electronic keys are in the vicinity
- When carrying or using the electronic key together with the following devices that emit radio waves
  - Another vehicle's electronic key
  - A wireless key that emits radio waves
  - Personal computer
- If window tint with a metallic content or metallic objects are attached to the rear window

## 1-2. Opening, closing and locking the doors



### ■ Switching the door unlock function

If it is possible to set which doors the entry function unlocks.

**STEP 1** Turn the “ENGINE START STOP” switch OFF.

**STEP 2** When the indicator on the key surface is turned off, press and hold  or  for approximately 5 seconds while pressing  on the key.

The setting changes each time an operation is performed, as shown below. (When changing the setting continuously, release the buttons, wait for at least 5 seconds, and repeat **STEP 2**.)

Multi-information display	Unlocking function	Beep
	Hold the driver's door handle to unlock only the driver's door.	Exterior: Beeps three times Interior: Pings once
	Hold either door handle to unlock all doors.	Exterior: Beeps twice Interior: Pings once

**STEP 3** Unlock the doors using the electronic key and open one of the doors.

If a door is not opened within 60 seconds after  is pressed, the doors will be locked again and the alarm will automatically be set.

In case that the alarm is triggered, immediately stop the alarm.

(→P. 98)

1

Before driving

## 1-2. Opening, closing and locking the doors

### ■ Battery-saving function

In the following circumstances, the entry function is disabled in order to prevent the vehicle and electronic key batteries from discharging.

- When the entry function has not been used for 2 weeks or more
- When the electronic key has been left within approximately 3 ft. (1 m) of the vehicle for 10 minutes or more

The system will resume operation when...

- The vehicle is locked using the door handle lock switch.
- The vehicle is locked/unlocked using the wireless remote control function (→P. 39) or the mechanical key. (→P. 535)

### ■ Electronic key battery depletion

- The standard battery life is 1 to 2 years. (The battery becomes depleted even if the electronic key is not used.) If the smart key system or the wireless remote control function does not operate, or the detection area becomes smaller, the battery may be depleted. Replace the battery when necessary. (→P. 463)
- If the battery becomes low, an alarm will sound in the cabin when the engine stops. (→P. 34)
- To avoid serious deterioration, do not leave the electronic key within 3 ft. (1 m) of the following electrical appliances that produce a magnetic field.
  - TVs
  - Personal computers
  - Recharging cellular phones or cordless phones
  - Table lamps

### ■ To operate the system properly

Make sure to carry the electronic key when operating the system. Do not get the electronic key too close to the vehicle when operating the system from the outside of the vehicle.

Depending on the position and holding condition of the electronic key, the key may not be detected correctly and the system may not operate properly. (The alarm may go off accidentally, or the door lock prevention may not function.)



■ **Note for the smart key system**

- Even when the electronic key is within the effective range (detection areas), the system may not operate properly in the following cases.
  - The electronic key is too close to the window or outside door handle, near the ground, or in a high place when the doors are locked or unlocked.
  - The electronic key is near the ground or in a high place, or too close to the rear bumper center when the back door is locked or unlocked.
  - The electronic key is on the instrument panel, floor or in the glove box when the engine is started or “ENGINE START STOP” switch modes are changed.
- As long as the electronic key is within the effective range, the doors may be locked or unlocked by anyone.
- Even if the electronic key is not inside the vehicle, it may be possible to start the engine if the electronic key is near the window.
- The doors may unlock if a large amount of water splashes on the door handle, such as in the rain or in a car wash. (The doors will automatically be locked after approximately 60 seconds if the doors are not opened and closed.)
- Gripping the door handle when wearing a glove may not unlock the door.
- If the wireless remote control is used to lock the doors when the electronic key is near the vehicle, there is a possibility that the door may not be unlocked by the smart key system. (Use the wireless remote control to unlock the doors.)
- A sudden approach to the effective range or door handle operation may prevent the doors from being unlocked. In this case, return the door handle to the original position and check that the doors unlock before pulling the door handle.

■ **When the vehicle is not driven for extended periods**

To prevent theft of the vehicle, do not leave the electronic key within 6 ft. (2 m) of the vehicle.

■ **Security feature**

If a door is not opened within approximately 60 seconds after the vehicle is unlocked, the security feature automatically locks the vehicle again.

## 1-2. Opening, closing and locking the doors

### ■ Alarms and warning indicators

A combination of exterior and interior alarms as well as warnings displayed on the multi-information display are used to prevent theft of the vehicle and unforeseeable accidents resulting from erroneous operation. Perform the appropriate correction procedure described in the following table.

Alarm	Situation	Correction procedure
Exterior alarm sounds once for 2 seconds	An attempt was made to lock the doors using the entry function while the electronic key was still inside the passenger compartment	Retrieve the electronic key from the passenger compartment and lock the doors again
Exterior alarm sounds once for 60 seconds	An attempt was made to exit the vehicle and lock the doors without first turning the "ENGINE START STOP" switch OFF	Turn the "ENGINE START STOP" switch OFF and lock the doors again
Exterior alarm sounds once for 10 seconds	An attempt was made to lock the vehicle while a door is open	Close all of the doors and lock the doors again
Interior alarm pings continuously*1	The "ENGINE START STOP" switch was turned to ACCESSORY mode while the driver's door was open (or the driver's door was opened while the "ENGINE START STOP" switch was in ACCESSORY mode)	Turn the "ENGINE START STOP" switch OFF and close the driver's door
	The "ENGINE START STOP" switch was turned OFF while the driver's door was open	Close the driver's door

1-2. Opening, closing and locking the doors

Alarm	Situation	Correction procedure
Interior alarm sounds continuously*1	When the "ENGINE START STOP" switch is in IGNITION ON or ACCESSORY mode, an attempt was made to open the door and exit the vehicle, and the shift lever was not in "P"	Shift the shift lever to "P" and turn the "ENGINE START STOP" switch OFF
Interior and exterior alarms sound continuously*1	When the "ENGINE START STOP" switch is in IGNITION ON or ACCESSORY mode, the driver's door was closed after the key was carried outside the vehicle, and the shift lever not in "P"	Shift the shift lever to "P", turn the "ENGINE START STOP" switch OFF and close the driver's door again
Interior alarm pings once*1	The electronic key has a low battery	Replace the electronic key battery
	An attempt was made to start the engine without the electronic key being present, or the electronic key was not functioning normally	Start the engine with the electronic key present*2

1

Before driving

## 1-2. Opening, closing and locking the doors

Alarm	Situation	Correction procedure
Interior alarm pings once and exterior alarm sounds 3 times*1	The driver's door was closed after the key was carried outside the vehicle, and the "ENGINE START STOP" switch was not turned OFF	Turn the "ENGINE START STOP" switch OFF and close the driver's door again
	An occupant carried the electronic key outside the vehicle and closed the door while the "ENGINE START STOP" switch was not OFF	Bring the electronic key back into the vehicle

\*1: A message will be shown on the multi-information display in the instrument cluster.

\*2: If the engine does not start when the electronic key is inside the vehicle, the electronic key battery may be depleted or there may be difficulties receiving signal from the key. (→P. 535)

### ■ If the smart key system does not operate properly

- Locking and unlocking the doors: Use the mechanical key. (→P. 535)
- Starting the engine (→P. 154)

### ■ When the electronic key battery is fully depleted

→P. 463

### ■ Customization

Settings (e.g. smart key system) can be changed. (Customizable features →P. 573)

1-2. Opening, closing and locking the doors

■ Certification for the smart key system

FCC ID:NI4TMLF-5

NOTE:

This device complies with Part 15 of the FCC Rules. Operation is subject to the following two conditions: (1) This device may not cause harmful interference, and (2) this device must accept any interference received, including interference that may cause undesired operation.

FCC WARNING:

Changes or modifications not expressly approved by the party responsible for compliance could void the user's authority to operate the equipment.

1

Before driving

TCB **امداد خودرو فارما** TCB

GRANT OF EQUIPMENT AUTHORIZATION  
Certification  
Issued Under the Authority of the  
Federal Communications Commission  
By:

PHOENIX TESTLAB GmbH  
Koenigswinkel 10  
D-32825 Blomberg,  
Germany

Date of Grant: 10/05/2006  
Application Dated: 10/05/2006

Toyota Motor Corporation  
1, Toyota-Cho  
Toyota Aichi, 471-71  
Japan

تلفن شبانه روزی: ۰۸۵۲۸۸۶۲۰۸۵

Attention: Kazunori Sakai , General Manager

NOT TRANSFERABLE

EQUIPMENT AUTHORIZATION is hereby issued to the named GRANTEE, and is VALID ONLY for the equipment identified hereon for use under the Commission's Rules and Regulations listed below.

FCC IDENTIFIER: NI4TMLF-5  
Name of Grantee: Toyota Motor Corporation  
Equipment Class: Part 15 Low Power Transmitter Below 1705 kHz  
Notes: Smart LF Oscillator

Grant Notes	FCC Rule Parts	Frequency Range (MHZ)	Output Watts	Frequency Tolerance	Emission Designator
	15C	0.1342 - 0.1342			

## 1-2. Opening, closing and locking the doors

### CAUTION

#### ■ Caution regarding interference with electronic devices

- People with implanted pacemakers or cardiac defibrillators should keep away from the smart key system antennas. (→P. 28) The radio waves may affect the operation of such devices. If necessary, the entry function can be disabled. Ask your Toyota dealer for details, such as the frequency of radio waves and timing of emitting the radio waves. Then, consult your doctor to see if you should disable the entry function.
- Users of any electrical medical device other than implanted pacemakers and implanted cardiac defibrillators should consult the manufacturer of the device for information about its operation under the influence of radio waves. Radio waves could have unexpected effects on the operation of such medical devices.

Ask your Toyota dealer for details for disabling the smart key system.

تلفن شبانه روزی: ۰۲۱-۸۸۸۶۲۰۸۵

FarmaSOS.com

## 1-2. Opening, closing and locking the doors Wireless remote control

The wireless remote control can be used to lock and unlock the vehicle from outside the vehicle.

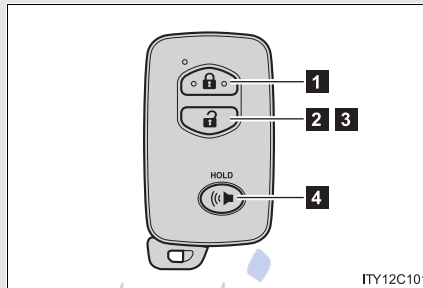

**1** Locks all doors

**2** Unlocks all doors

Pressing the button unlocks the driver's door. Pressing the button again within 3 seconds unlocks the other doors.

**3** Opens the windows and moon roof (press and hold)\*

**4** Sounds alarm (press and hold) (→P. 98)

\*: This setting must be customized at your Toyota dealer.

1

Before driving

### ■ Operation signals

- Doors: A buzzer sounds and the emergency flashers flash to indicate that the doors have been locked/unlocked. (Locked: Once; Unlocked: Twice)
- Windows and moon roof: A buzzer sounds when the windows and moon roof begin to open.

### ■ Door lock buzzer

If a door is not fully closed, a buzzer sounds continuously for 10 seconds if an attempt to lock the door is made. Fully close the door to stop the buzzer, and lock the vehicle once more.

### ■ Security feature

→P. 33

## 1-2. Opening, closing and locking the doors

### ■ Alarm

Using the wireless remote control to lock the door will set the alarm system.  
(→P. 98)

### ■ Electronic key battery depletion

→P. 535

### ■ If the wireless remote control does not operate properly

- Locking and unlocking the doors: Use the mechanical key. (→P. 535)
- Starting the engine (→P. 154)

### ■ When the electronic key battery is fully depleted

→P. 463

### ■ Conditions affecting operation

→P. 30

### ■ Customization

Settings (e.g. 2-step unlocking function) can be changed. (Customizable features →P. 573)

تلفن شبانه روزی: ۰۲۱-۸۸۸۶۲۰۸۵

FarmaSOS.com



■ **Certification for wireless remote control**

FCC ID: HYQ14AAB

FCC ID: HYQ13BZS

FCC ID: HYQ14ABK\*

FCC ID: HYQ13CZA\*

\*: For U.S. mainland only

**NOTE:**

This device complies with Part 15 of the FCC Rules. Operation is subject to the following two conditions: (1) this device may not cause harmful interference, and (2) this device must accept any interference received, including interference that may cause undesired operation.

**NOTICE:**

This equipment has been tested and found to comply with the limits for a Class B digital device, pursuant to Part 15 of the FCC Rules. These limits are designed to provide reasonable protection against harmful interference in a residential installation. This equipment generates, uses and can radiate radio frequency energy and, if not installed and used in accordance with the instructions, may cause harmful interference to radio communications. However, there is no guarantee that interference will not occur in a particular installation. If this equipment does cause harmful interference to radio or television reception, which can be determined by turning the equipment off and on, the user is encouraged to try to correct the interference by one or more of the following measures:

- Reorient or relocate the receiving antenna.
- Increase the separation between the equipment and receiver.
- Connect the equipment into an outlet on a circuit different from that to which the receiver is connected.
- Consult the dealer or an experienced radio/TV technician for help.

**FCC WARNING:**

Changes or modifications not expressly approved by the party responsible for compliance could void the user's authority to operate the equipment.

## 1-2. Opening, closing and locking the doors Side doors

The vehicle can be locked and unlocked using the smart key system, wireless remote control or door lock switch.

### ■ Entry function

→P. 26

### ■ Wireless remote control

→P. 39

### ■ Door lock switch

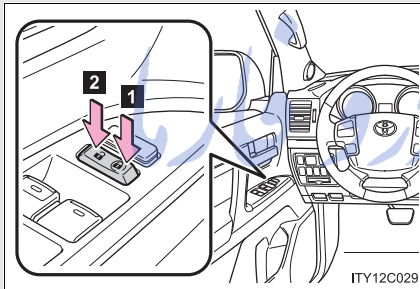

- 1 Locks all doors
- 2 Unlocks all doors

### ■ Inside lock button

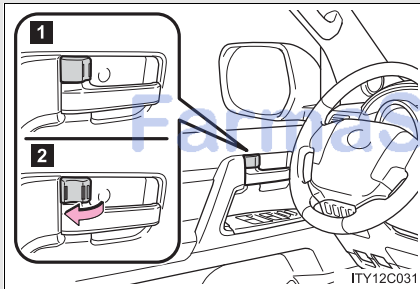

- 1 Locks the door
- 2 Unlocks the door

The front doors can be opened by pulling the inside handles even if the lock buttons are in the lock position.

### Locking the driver's door from the outside without a key

**STEP 1** Move the inside lock button to the lock position.

**STEP 2** Close the door.

The door cannot be locked if the "ENGINE START STOP" switch is in ACCESSORY or IGNITION ON mode, or the electronic key is left inside the vehicle.

Depending on the position of the electronic key, the key may not be detected correctly and the door may be locked.

### Rear door child-protector lock

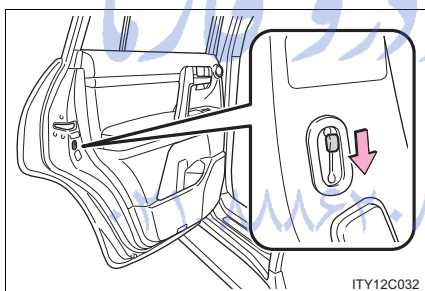

The door cannot be opened from inside the vehicle when the locks are set.

These locks can be set to prevent children from opening the rear doors. Press down rear door switches to lock the rear doors.

1

Before driving

### Automatic door locking and unlocking systems

The following functions can be set or canceled:



Function	Operation
Shift position linked door locking function	Shifting the shift lever out of "P" locks all doors.
Shift position linked door unlocking function	Shifting the shift lever to "P" unlocks all doors.
Speed linked door locking function	All doors are locked when the vehicle speed is approximately 12 mph (20 km/h) or higher.
Driver's door linked door unlocking function	All doors are unlocked when the driver's door is opened within 10 seconds after turning the "ENGINE START STOP" switch OFF.

#### ■ Setting and canceling the functions

To switch between setting and canceling, follow the procedure below:

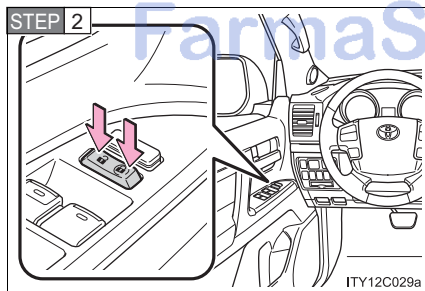
**STEP 1** Close all the doors and switch the "ENGINE START STOP" switch IGNITION ON mode. (Perform step 2 within 20 seconds.)







Shift the shift lever to "P" or "N", press and hold the driver's door lock switch (  or  ) for 5 seconds then release.

The shift lever and switch positions corresponding to the desired function to be set are shown as follows.

Use the same procedure to cancel the function.

## 1-2. Opening, closing and locking the doors

Function	Shift lever position	Driver's door lock switch position
Shift position linked door locking function	"P"	
Shift position linked door unlocking function		
Speed linked door locking function	"N"	
Driver's door linked door unlocking function		

1

Before driving

When the setting or canceling operation is complete, all doors are locked and then unlocked.

### ■ Impact detection door lock release system

In the event that the vehicle is subject to a strong impact, all the doors are unlocked.

Depending on the force of the impact or the type of accident, however, the system may not operate.

### ■ Using the mechanical key

The doors can also be locked and unlocked with the mechanical key.  
(→P. 535)

### ■ Customization

Settings (e.g. unlocking function using a key) can be changed. (Customizable features →P. 573)

## 1-2. Opening, closing and locking the doors

### CAUTION

#### ■ To prevent an accident

Observe the following precautions while driving the vehicle.

Failing to do so may result in a door opening and an occupant falling out, resulting in death or serious injury.

- Always use a seat belt.
- Always lock all doors.
- Ensure that all doors are properly closed.
- Do not pull the inside handle of the doors while driving.  
The doors may be opened and the passengers are thrown out of the vehicle and it may result in serious injury or death.  
Be especially careful of the front doors, as the doors may be opened even if the inside lock buttons are in locked position.
- Set the rear door child-protector locks when children are seated in the rear seat.

تلفن شبانه روزی: ۰۲۱-۸۸۸۶۲۰۸۵

FarmaSOS.com

## 1-2. Opening, closing and locking the doors Back door

The back door can be locked/unlocked and opened by the following procedures.

### ■ Locking and unlocking the back door

- ▶ Door lock switch  
→P. 42
- ▶ Entry function  
→P. 26
- ▶ Wireless remote control  
→P. 39

### ■ Opening the back door from outside the vehicle

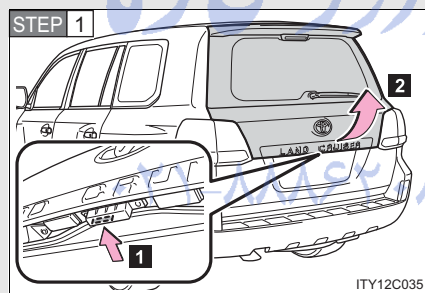

- 1 Unlock the back door
- 2 Raise the back door

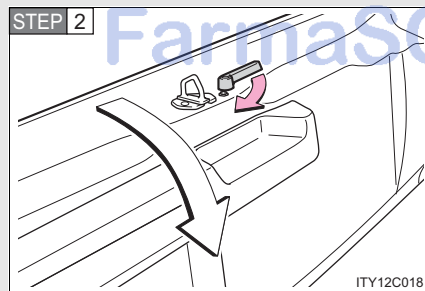

Pull the handle

1

Before driving

## 1-2. Opening, closing and locking the doors

### Rear step bumper

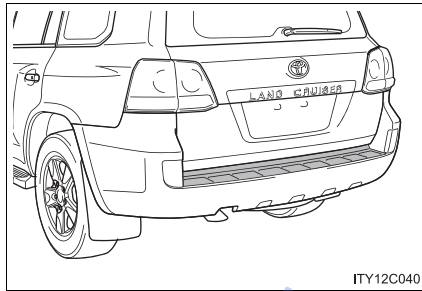

The rear step bumper is for rear end protection and easier step-up loading.

### ■ When closing the back door

- Make sure that the lower side of the back door is closed before closing the upper side of the back door.

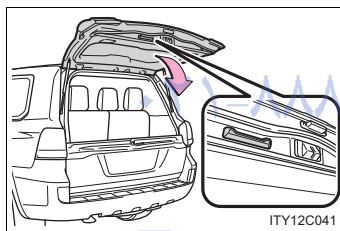

- Lower the back door using the back door handle, and make sure to push the back door down from the outside to close it.

### ■ If the back door opener is inoperative

→P. 534



 CAUTION

■ **While driving**

- Keep the back door closed while driving.  
If the back door is left open, it may hit near-by objects while driving or luggage may be unexpectedly thrown out, causing an accident.  
In addition, exhaust gases may enter the vehicle, causing death or a serious health hazard. Make sure to close the back door before driving.
- Before driving the vehicle, make sure that the back door is fully closed. If the back door is not fully closed, it may open unexpectedly while driving, causing an accident.
- Never let anyone sit in the luggage compartment. In the event of sudden braking or a collision, they are susceptible to death or serious injury.

■ **When children are in the vehicle**

Observe the following precautions.

Failure to do so may result in death or serious injury.

- Do not leave children alone in the luggage compartment.  
If a child is accidentally locked in the luggage compartment, they could have heat exhaustion.
- Do not allow a child to open or close the back door.  
Doing so may cause the back door to operate unexpectedly, or cause the child's hands, head, or neck to be caught by the closing back door.

1

Before driving

FarmaSOS.com

## 1-2. Opening, closing and locking the doors

### ⚠ CAUTION

#### ■ Operating the back door

Observe the following precautions.

Failure to do so may cause parts of the body to be caught, resulting in serious injury.

- Remove any heavy loads, such as snow and ice, from the back door before opening it. Failure to do so may cause the back door fall closed again after it is opened.
- When opening or closing the back door, thoroughly check to make sure the surrounding area is safe.
- If anyone is in the vicinity, make sure they are safe and let them know that the back door is about to open or close.
- Use caution when opening or closing the back door in windy weather as it may move abruptly in strong wind.

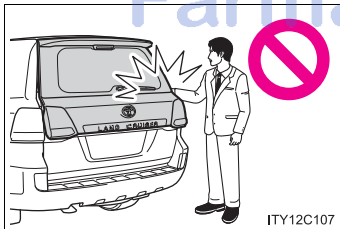
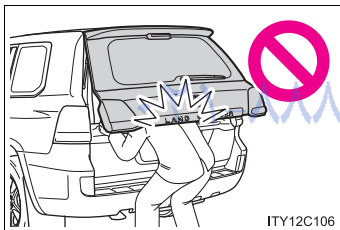

- The back door may fall if it is not opened fully. It is more difficult to open or close the back door on an incline than on a level surface, so beware of the back door unexpectedly opening or closing by itself. Make sure that the back door is fully open and secure before using the luggage compartment.
- When closing the back door, take extra care to prevent your fingers etc. from being caught.
- When closing the back door, make sure to press it lightly on its outer surface. If the back door handle is used to fully close the back door, it may result in hands or arms being caught.

**⚠ CAUTION**

- Do not pull on the back door damper stay to close the back door, and do not hang on the back door damper stay. Doing so may cause hands to be caught or the back door damper stay to break, causing an accident.
- Do not attach any accessories other than genuine Toyota parts to the back door. Such additional weight on the back door may cause the back door to fall closed again after it is opened.

1

Before driving

**⚠ NOTICE**

■ **Back door damper stays**

The back door is equipped with damper stays that hold the back door in place.

Observe the following precautions.

Failure to do so may cause damage to the back door damper stay, resulting in malfunction.

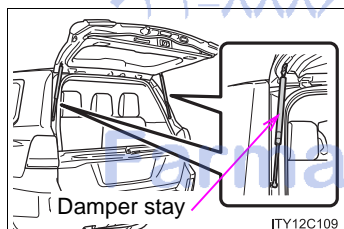

- Do not attach any foreign objects, such as stickers, plastic sheets, or adhesives to the damper stay rod.
- Do not touch the damper stay rod with gloves or other fabric items.
- Do not attach any accessories other than genuine Toyota parts to the back door.
- Do not place your hand on the damper stay or apply lateral forces to it.

### 1-3. Adjustable components (seats, mirrors, steering wheel) Front seats

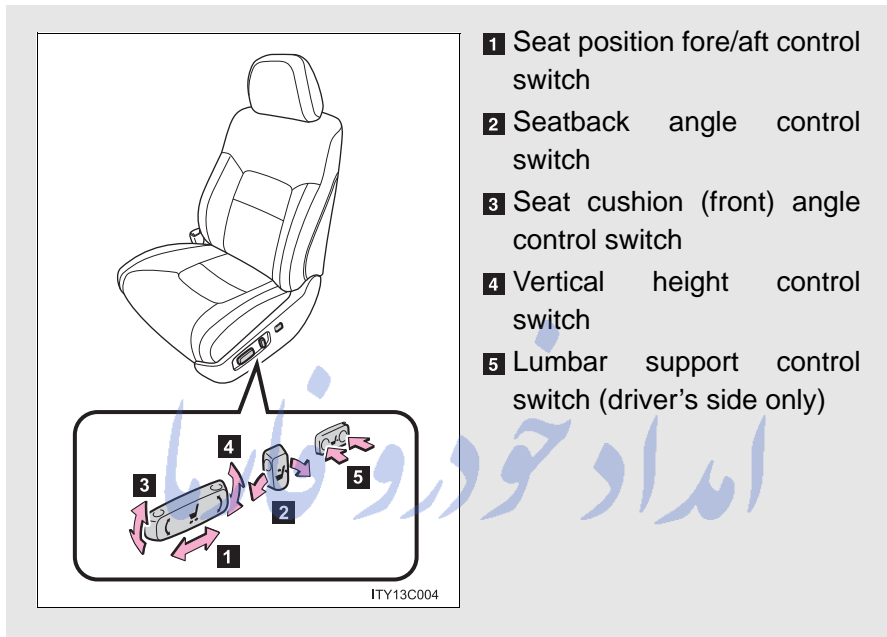

#### Active head restraint

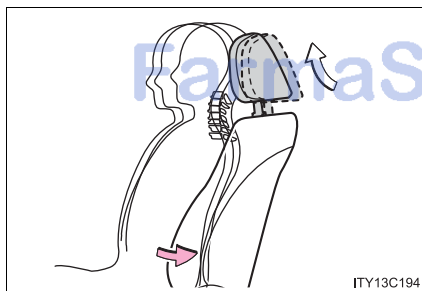

When the occupant's lower back presses against the seatback during a rear-end collision, the head restraint moves slightly forward and upward to help reduce the risk of whiplash on the seat occupant.

### ■ Active head restraint

Even small forces applied to the seatback may cause the head restraint to move. Pushing up a locked head restraint forcibly may make the inner structure of the head restraint appear. This does not indicate a problem.

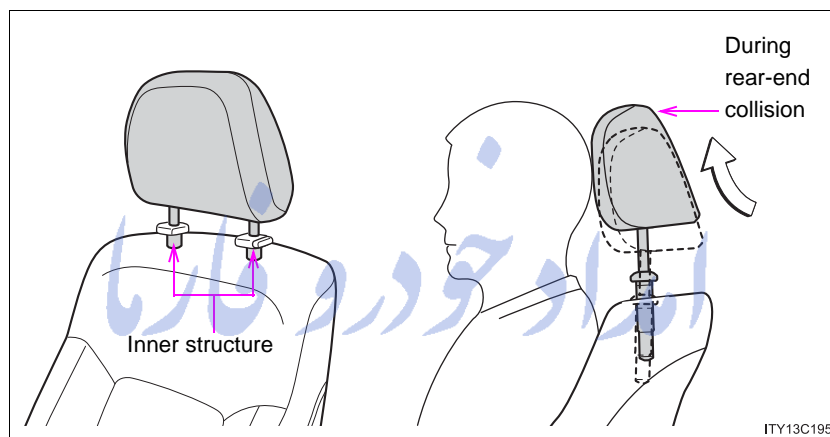

1

Before driving

### ⚠ CAUTION

#### ■ Seat adjustment

- Be careful that the seat does not hit passengers or luggage.
- Do not recline the seat more than necessary when the vehicle is in motion to reduce the risk of sliding under the lap belt.  
If the seat is too reclined, during an accident the lap belt may slide past the hips and apply restraint forces directly to the abdomen or your neck may contact the shoulder belt, increasing the risk of death or serious injury.

1-3. Adjustable components (seats, mirrors, steering wheel)  
Rear seats

► Second seat

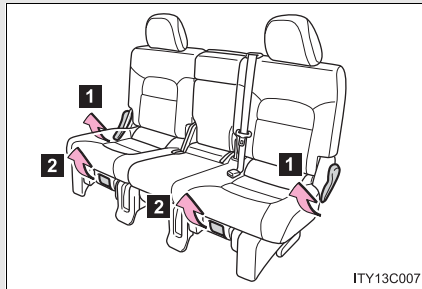

**1** Seatback angle adjustment lever

**2** Seat position adjustment lever

► Third seat

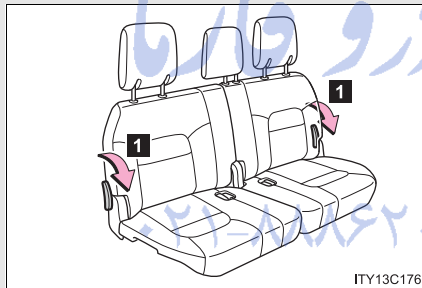

FarmaSOS.com

### Tumbling the second seats and third seat entry

For easy access to the third seat, perform **STEP 1** in “Tumbling the second seats”. (→P. 56)

#### ■ Before tumbling the second seats

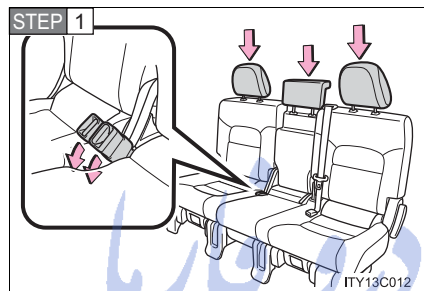

Stow the seat belt buckles and lower the head restraints to the lowest position.

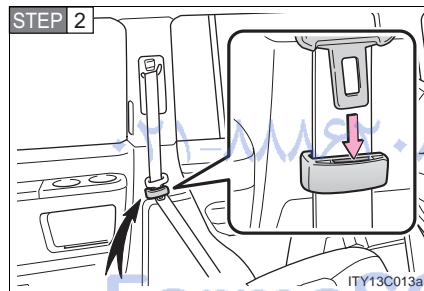

Pass the outer seat belts through the seat belt hangers and secure the seat belt plates.

This prevents the shoulder belt from being damaged.

Make sure that the seat belts are removed from the hangers before using them.

1  
Before driving

1-3. Adjustable components (seats, mirrors, steering wheel)

■ **Tumbling the second seats**

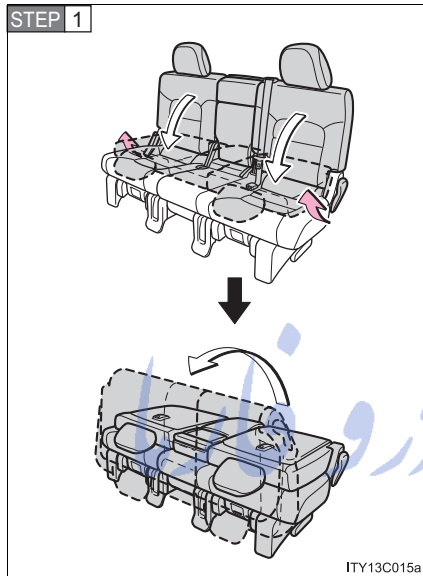

Fold down the seatback while pulling the seatback angle adjustment lever, and swing the whole seat up and forward.

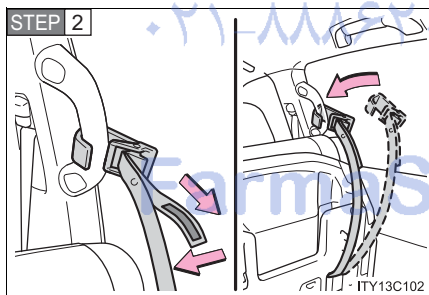

Hook the holding strap to the assist grip and secure the seat by pulling its free end.

When returning the second seat to its original position, stow the holding strap.



1-3. Adjustable components (seats, mirrors, steering wheel)

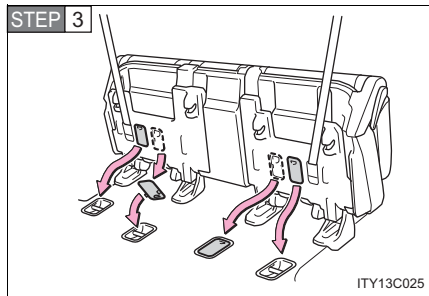

Remove the seat hook covers from the back of the seat cushion, and install them on the seat hooks.

When returning the second seat to its original position, remove the seat hook covers from the floor and install them in the back of the seat cushion.

1  
Before driving

■ If you cannot raise the left side seatback

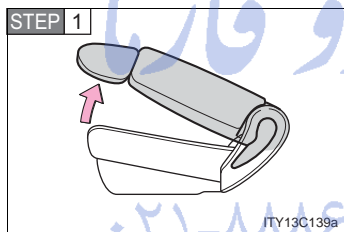

Lift the seatback until it stops.

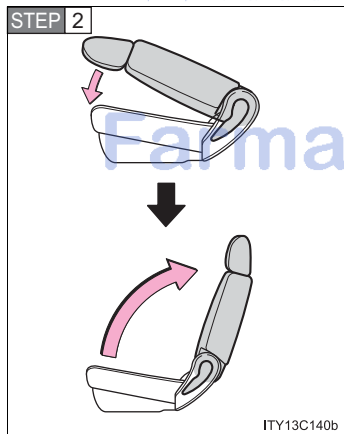

Lower the seatback a little then lift it again.

### Folding up the third seats

#### ■ Before folding up the third seats

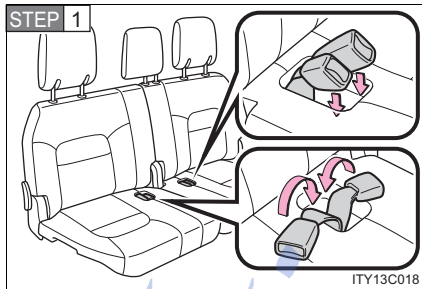

Stow the seat belts buckles.

**STEP 2** Stow the center head restraint in the seatback. (→P. 70)

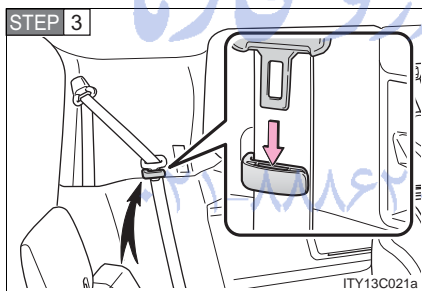

Pass the outer seat belts through the seat belt hangers and secure the seat belt plates.

This prevents the shoulder belt from being damage.

Make sure that the seat belts are removed from the hangers before using them.

**STEP 4** Stow the center seat belt tabs in the cover set in the roof. (→P. 73)

1-3. Adjustable components (seats, mirrors, steering wheel)

■ Folding up the third seats

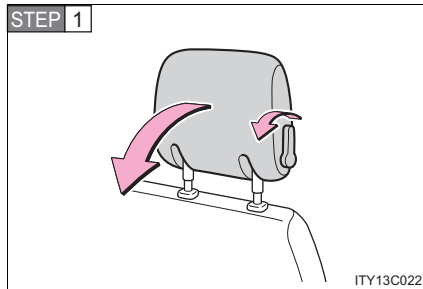

Fold down the head restraints while pulling the head restraint angle lever.

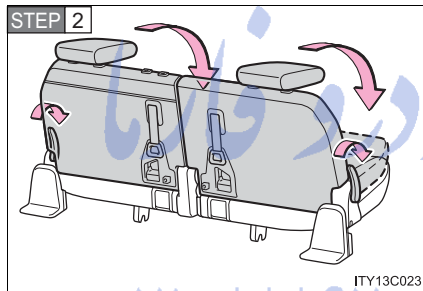

Push the seatback angle levers and fold the third seats.

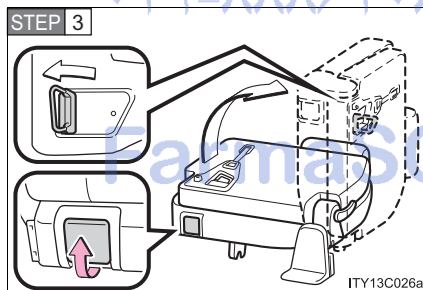

Pull the seat leg lock release levers.

The seat will rise, and the seat-back striker will also automatically sit up.

Before raising, make sure that the handle on the rear of the seat-back is secure.

1

Before driving

1-3. Adjustable components (seats, mirrors, steering wheel)

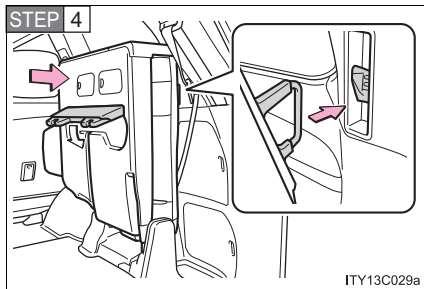

Secure the seats by the strikers.

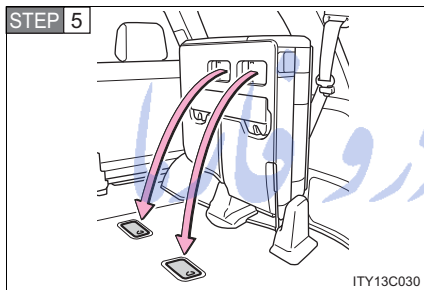

Remove the seat hook covers from the back of the seat cushion, and install them on the seat hooks.

■ Returning the third seats

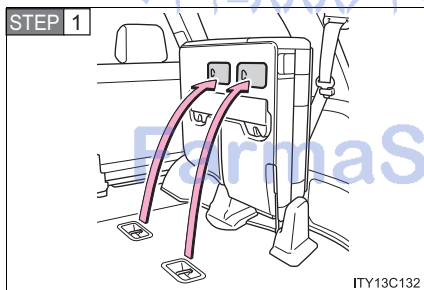

Remove the seat hook covers from the floor and install them into the back of the seat cushion.

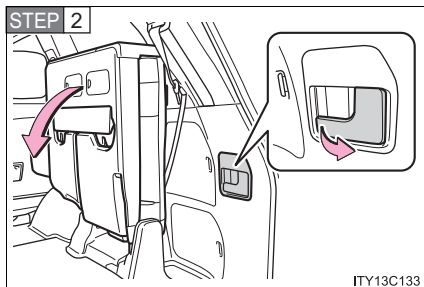

Unlock the seats by pulling the stowed seat lock release levers and lower the seats to its original position.

1-3. Adjustable components (seats, mirrors, steering wheel)

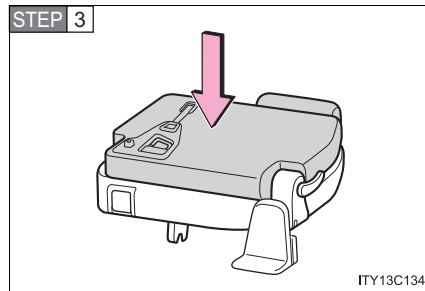

Secure the seats by the strikers.

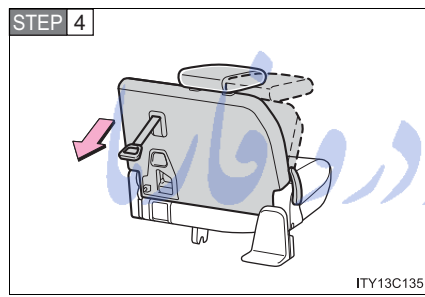

Pull the handle and raise the seatbacks.

Fix the handle securely in its original position after use.

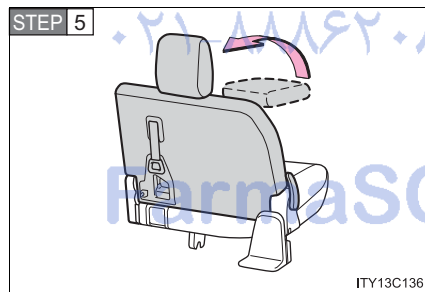

Raise the head restraints.

1

Before driving

### 1-3. Adjustable components (seats, mirrors, steering wheel)

#### CAUTION

##### ■ **Seat adjustment**

Do not recline the seat more than necessary when the vehicle is in motion, to reduce the risk of sliding under the lap belt.

If the seat is too reclined, during an accident the lap belt may slide past the hips and apply restraint forces directly to the abdomen or your neck may contact the shoulder belt, increasing the risk of death or serious injury.

##### ■ **When the seatback is folded**

- Do not sit on or place anything on the seatback while driving.
- Be sure to install the seat hook covers on the seat hooks, or you may get burned when they become hot.

##### ■ **When returning the seatbacks to their original position**

Observe the following precautions. Failure to do so may result in death or serious injury.

- Be careful not to get your hands or feet pinched in the seat.
- Make sure the seats are securely locked. Failure to do so will prevent the seat belt from operating properly.
- Check that the seat belts are not twisted or caught under the seat.
- Arrange the seat belts in the proper positions for ready use.

##### ■ **Avoiding damage to seat components**

Do not hang or attach anything on the seatback striker.

#### NOTICE

##### ■ **Before tumbling, folding up the seats**

The seat belts and buckles must be stowed.

##### ■ **After returning the third seat**

Make sure that the handle on the rear of the seatback has been secured.

## 1-3. Adjustable components (seats, mirrors, steering wheel) Driving position memory system

Your preferred driving position (the position of the driver's seat, steering wheel and outside rear view mirrors) can be entered into the computer's memory and recalled with the touch of a button. It is also possible to set this function to activate automatically when the doors are unlocked.

Three different driving positions can be entered into memory.

### ■ Entering a position to memory

**STEP 1** Turn the "ENGINE START STOP" switch to IGNITION ON mode.

**STEP 2** Adjust the driver's seat, steering wheel, and outside rear view mirrors to the desired positions.

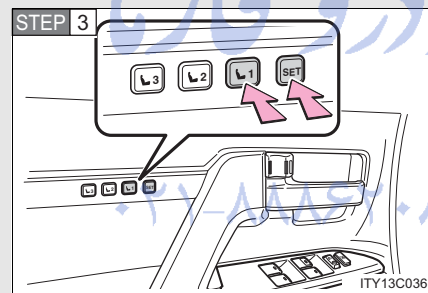

While pressing the "SET" button, or within 3 seconds after the "SET" button is pressed, press and hold button "1", "2" or "3" until the signal beeps.

If the selected button has already been preset, the previously recorded position will be overwritten.

1

Before driving

FarmaSOS.com

### 1-3. Adjustable components (seats, mirrors, steering wheel)

#### ■ Recalling the memorized position

Check that the shift lever is set in "P".

**STEP 1** Turn the "ENGINE START STOP" switch to IGNITION ON mode.

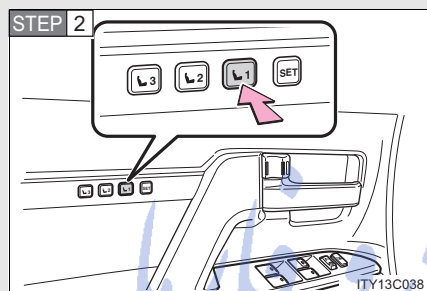

Press button "1", "2" or "3" to recall the desired position.

#### Linking driving position memory with door unlock operation

Record your driving position to button "1", "2" or "3" before performing the following:

► Using the wireless remote control

**STEP 1** Turn the "ENGINE START STOP" switch to OFF after closing the driver's door.

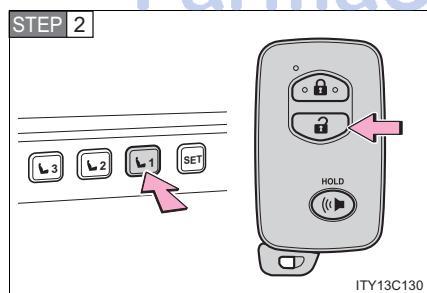

While pressing the desired button ("1", "2" or "3"), press  on the wireless remote control until the signal beeps.

The driving position is recalled when the driver's door is unlocked using the entry function or wireless remote control and the driver's door is opened.



### 1-3. Adjustable components (seats, mirrors, steering wheel)

#### STEP 3 Open one of the doors.

If a door is not opened within 60 seconds after  is pressed, the doors will be locked again and the alarm will automatically be set. In case that the alarm is triggered, immediately stop the alarm. (→P. 98)

#### ► Using the door lock switch

Carry only the key to which you want to link the driving position. If 2 or more keys are in the vehicle, the driving position cannot be linked properly.

#### STEP 1 Turn the “ENGINE START STOP” switch to OFF after closing the driver’s door.

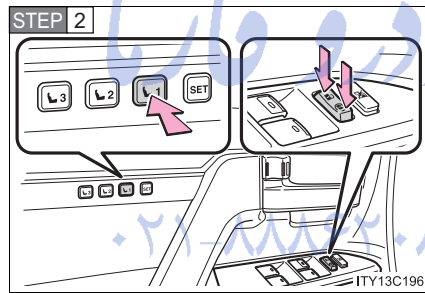

While pressing the desired button (“1”, “2”, or “3”), press the lock or unlock side on the door lock switch until the signal beeps.

The driving position is recalled when the driver’s door is unlocked using the entry function or wireless remote control and the driver’s door is opened.

1

Before driving

FarmaSOS.com

#### ■ Canceling the linked door unlock operation

**STEP 1** Turn the “ENGINE START STOP” switch to OFF after closing the driver’s door.

**STEP 2** Using the wireless remote control: While pressing “SET” button, press  button on the wireless remote control until the signal beeps.

Using the door lock switch: While pressing “SET” button, press the lock or unlock side on the door lock switch until the signal beeps.

#### ■ Retained accessory power

- Each memorized position (except for the steering wheel position) can be activated within 3 minutes after the driver’s door is opened, even if the “ENGINE START STOP” switch is turned off.
- Each memorized position (except for the steering wheel position) can be activated within 60 seconds after the driver’s door is closed, even if the “ENGINE START STOP” switch is turned off.

#### ■ To cancel seat position recall

Perform any one of the following operations.

- Press the “SET” button
- Press button “1”, “2” or “3”.
- Adjust the seat using the switches (only cancels seat position recall)
- Adjust the steering wheel using the tilt and telescopic steering control switch (only cancels steering wheel position recall)

#### ■ If the battery is disconnected

The memorized positions must be reset because the computer’s memory is erased when the battery is disconnected.

#### CAUTION

##### ■ Seat adjustment caution

Take care during seat adjustment that the seat does not strike the rear passenger or squeeze your body against the steering wheel.

## 1-3. Adjustable components (seats, mirrors, steering wheel) Head restraints

Head restraints are provided for all seats.

### ► Front seats

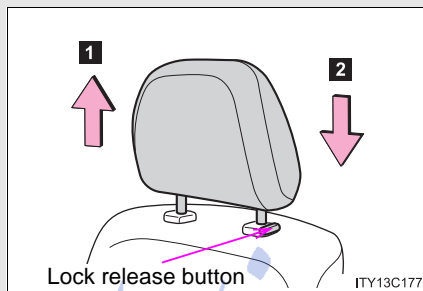

#### Vertical adjustment

##### 1 Up

Pull the head restraint up.

##### 2 Down

Press and hold the lock release button when lowering the head restraint.

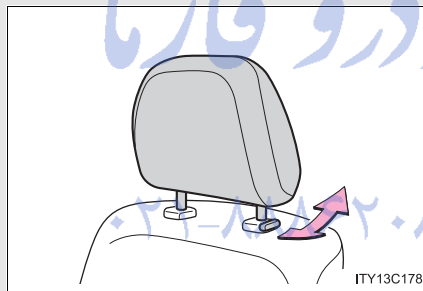

#### Angle adjustment

### ► Second seats

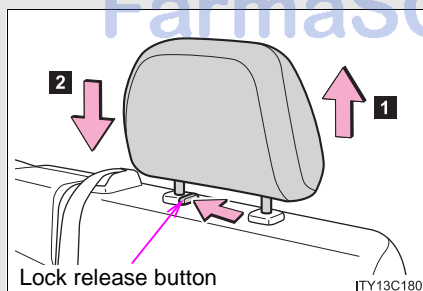

#### Vertical adjustment

##### 1 Up

##### 2 Down

Push the head restraint up or down while pressing the lock release button.

1

Before driving

### 1-3. Adjustable components (seats, mirrors, steering wheel)

#### ▶ Third outboard seats

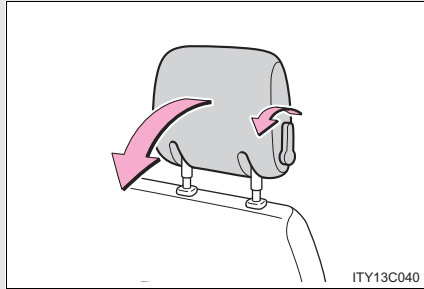

#### To fold

Pull the head restraint angle lever to fold the head restraint.

#### ■ Adjusting the height of the head restraints

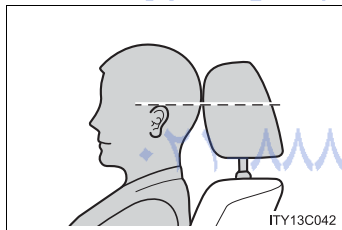

Make sure that the head restraints are adjusted so that the center of the head restraint is closest to the top of your ears.

#### ■ Adjusting the second center seat head restraint

Always raise the head restraint one level from the stowed position when using.

### 1-3. Adjustable components (seats, mirrors, steering wheel)

#### ■ Removing the head restraints

##### ► Front seats and third center seat

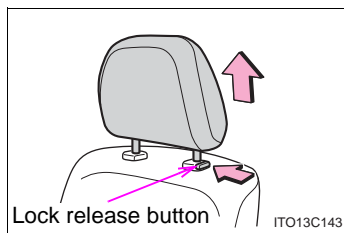

Pull the head restraint up while pressing the lock release button.

##### ► Second seats

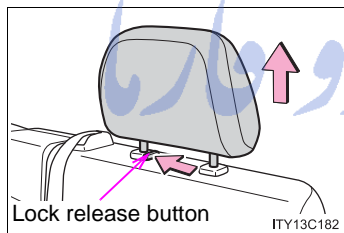

Pull the head restraint up while pressing the lock release button.

##### ► Third outboard seats

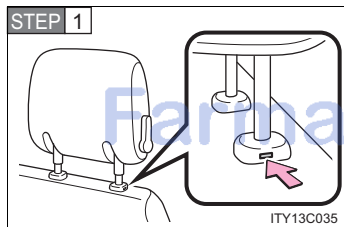

Push a flathead screwdriver into the slot. The slot is located on the left side of the left head restraint anchor.

**STEP 2** While pressing in the screwdriver, pull up the head restraint.

1

Before driving

### 1-3. Adjustable components (seats, mirrors, steering wheel)

#### ■ Installing the head restraints

**STEP 1** Align the head restraint with the installation holes.

**STEP 2** Push down the head restraint to the lock position.

#### ■ When not using the third center seat head restraint

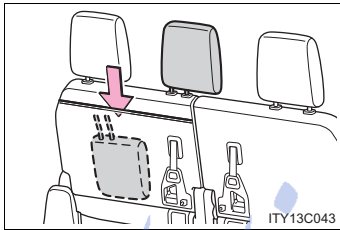

Open the zipper on the back of the third seat and stow the head restraint inside.

#### ⚠ CAUTION

##### ■ Head restraint precautions

Observe the following precautions regarding the head restraints. Failure to do so may result in death or serious injury.

- Use the head restraints designed for each respective seat.
- Adjust the head restraints to the correct position at all times.
- After adjusting the head restraints, push down on them and make sure they are locked in position.
- Do not drive with the head restraints removed.

## 1-3. Adjustable components (seats, mirrors, steering wheel) Seat belts

**Make sure that all occupants are wearing their seat belts before driving the vehicle.**

### ■ Correct use of the seat belts

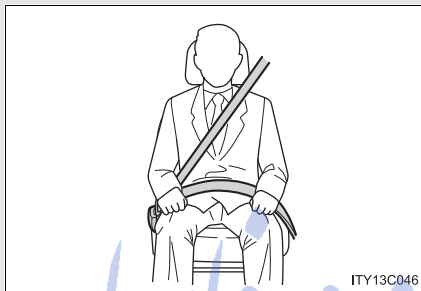

- Extend the shoulder belt so that it comes fully over the shoulder, but does not come into contact with the neck or slide off the shoulder.
- Position the lap belt as low as possible over the hips.
- Adjust the position of the seatback. Sit up straight and well back in the seat.
- Do not twist the seat belt.

### ■ Fastening and releasing the seat belt

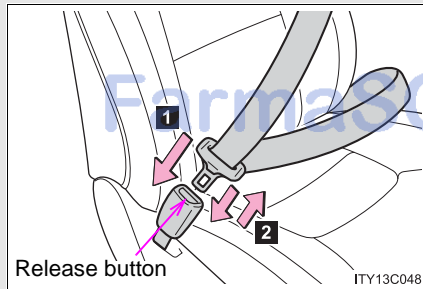

#### 1 Fastening the belt

Push the tab into the buckle until a clicking sound is heard.

#### 2 Releasing the belt

Press the release button.

1

Before driving

1-3. Adjustable components (seats, mirrors, steering wheel)

■ **Adjusting the height of the belt (front and second outboard seats)**

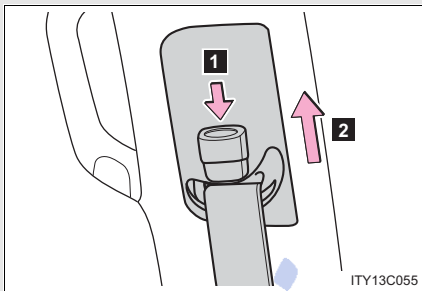

**1** Down

**2** Up

Move the height adjuster up and down as needed until you hear a click.

**Third center seat belt**

The third center seat belt is a 3-point type restraint with 2 buckles. Both seat belt buckles must be correctly located and securely latched for proper operation.

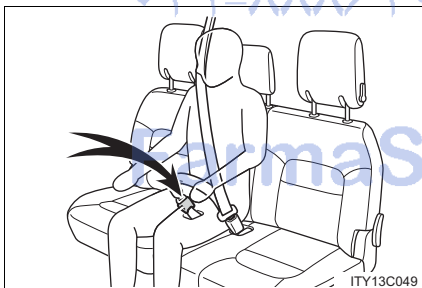

Make sure that the buckle with the gray buckle release button is securely latched for ready use of the center seat belt.



### 1-3. Adjustable components (seats, mirrors, steering wheel)

#### ■ Release method

The belt can be completely released when not required, such as when removing the third seat.

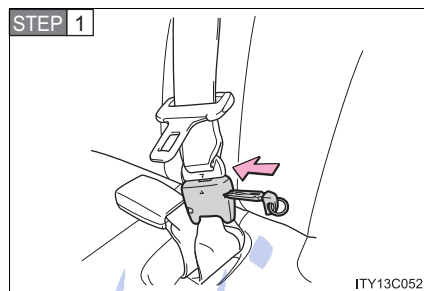

To release the hooked tab, insert the mechanical key into the hole on the buckle with the light gray buckle release button.

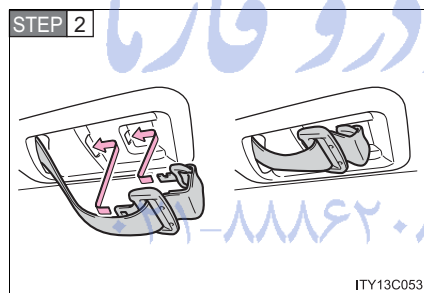

Stow the seat belt tabs in the cover set in the roof as shown.

#### ■ Extracting the belt

Pull the belt out partially, then remove the tabs from the cover.

1  
Before driving

1-3. Adjustable components (seats, mirrors, steering wheel)

### Seat belt pretensioners (front and second outboard seats)

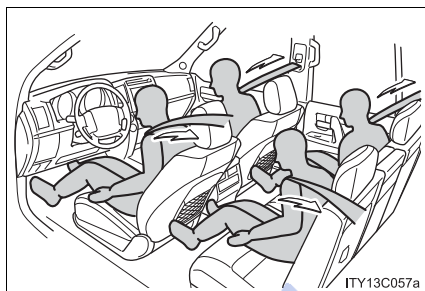

The pretensioner helps the seat belt to quickly restrain the occupant by retracting the seat belt when the vehicle is subjected to certain types of severe frontal collision.

The pretensioner may not activate in the event of a minor frontal impact, a side impact or a rear impact.

### Pre-collision seat belts (front seats of vehicles with pre-collision system)

When operating in the event of sudden braking, the seat belts lessen collision injury by retracting the slack in the front seat belts before the collision, thus enhancing the effectiveness of the seat belt pretensioner in a crash. (→P. 214)

#### ■ Emergency locking retractor (ELR)

The retractor will lock the belt during a sudden stop or on impact. It may also lock if you lean forward too quickly. A slow, easy motion will allow the belt to extend, and you can move around fully.

#### ■ Automatic locking retractor (ALR)

When a passenger's shoulder belt is completely extended and then retracted even slightly, the belt is locked in that position and cannot be extended. This feature is used to hold the child restraint system (CRS) firmly. To free the belt again, fully retract the belt and then pull the belt out once more. (→P. 129)

### 1-3. Adjustable components (seats, mirrors, steering wheel)

#### ■ Pregnant women

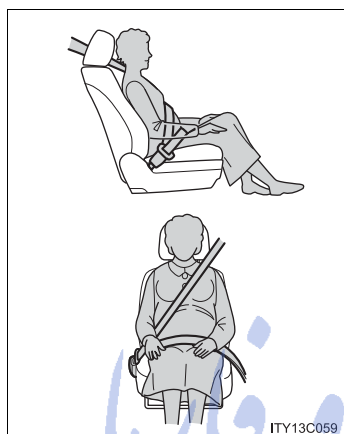

Obtain medical advice and wear the seat belt in the proper way. (→P. 71)

Women who are pregnant should position the lap belt as low as possible over the hips in the same manner as other occupants. Extend the shoulder belt completely over the shoulder and position the belt across the chest. Avoid belt contact over the rounding of the abdominal area.

If the seat belt is not worn properly, not only a pregnant woman, but also the fetus could suffer death or serious injury as a result of sudden braking, sudden swerving or a collision.

1

Before driving

#### ■ People suffering illness

Obtain medical advice and wear the seat belt in the proper way. (→P. 71)

#### ■ When the third center seat belt cannot be extended

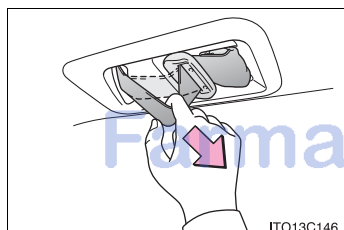

Put your fingers between the seat belt and the holder.

Pull the seat belt forcefully in the direction of the arrow and then release it to unlock.

### 1-3. Adjustable components (seats, mirrors, steering wheel)

#### ■ Child seat belt usage

The seat belts of your vehicle were principally designed for persons of adult size.

- Use a child restraint system appropriately for the child, until the child becomes large enough to properly wear the vehicle's seat belt. (→P. 125)
- When the child becomes large enough to properly wear the vehicle's seat belt, follow the instructions on P. 71 regarding seat belt usage.

#### ■ Replacing the belt after the pretensioner has been activated

If the vehicle is involved in multiple collisions, the pretensioner will activate for the first collision, but will not activate for the second or subsequent collisions.

#### ■ Seat belt extender

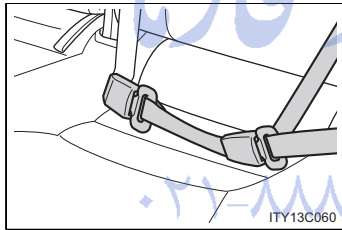

If your seat belts cannot be fastened securely because they are not long enough, a personalized seat belt extender is available from your Toyota dealer free of charge.

FarmaSOS.com

**⚠ CAUTION**

Observe the following precautions to reduce the risk of injury in the event of sudden braking, sudden swerving or an accident. Failing to do so may cause death or serious injury.

**■ Wearing a seat belt**

- Ensure that all passengers wear a seat belt.
- Always wear a seat belt properly.
- Each seat belt should be used by one person only. Do not use a seat belt for more than one person at the same time, including children.
- Children should be seated in the rear seat and always use a seat belt and/or an appropriate child restraint system.
- Do not recline the seat any more than necessary to achieve a proper seating position. The seat belt is most effective when the occupants are sitting up straight and well back in the seats.
- Do not wear the shoulder belt under your arm.
- Always wear your seat belt low and snug across your hips.

**■ Adjustable shoulder anchor**

Always make sure the shoulder belt is positioned across the center of your shoulder. The belt should be kept away from your neck, but not falling off your shoulder. Failure to do so could reduce the amount of protection in an accident and cause death or serious injuries in the event of a sudden stop, sudden swerve or collision. (→P. 72)

**■ Seat belt pretensioners**

- Do not place anything, such as a cushion, on the front passenger's seat. Doing so will disperse the passenger's weight, which prevents the sensor from detecting the passenger's weight properly. As a result, the seat belt pretensioner for the front passenger's seat may not activate in the event of a collision.
- If the pretensioner has activated, the SRS warning light will come on. In that case, the seat belt cannot be used again and must be replaced at your Toyota dealer.

### 1-3. Adjustable components (seats, mirrors, steering wheel)

#### CAUTION

##### ■ Child restraint lock function belt precaution

Do not allow children to play with the child restraint lock function belt. If the belt becomes twisted around a child's neck, it will not be possible to pull the belt out leading to choking or other serious injuries that could result in death.

If this occurs and the buckle cannot be unfastened, scissors should be used to cut the belt.

##### ■ When using the third center seat belt

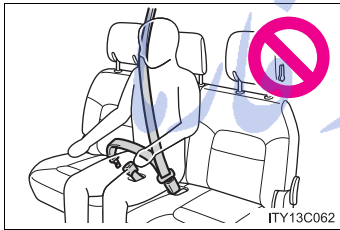

Do not use the third center seat belt with either buckle released. Fastening only one of the buckles may result in death or serious injury in case of sudden braking, sudden swerving or a collision.

##### ■ Seat belt damage and wear

- Do not damage the seat belts by allowing the belt, plate or buckle to be jammed in the door.
- Inspect the seat belt system periodically. Check for cuts, fraying, and loose parts. Do not use a damaged seat belt until it is replaced. Damaged seat belts cannot protect an occupant from death or serious injury.
- Ensure that the belt and tab are locked and the belt is not twisted. If the seat belt does not function correctly, immediately contact your Toyota dealer.
- Replace the seat assembly, including the belts, if your vehicle has been involved in a serious accident, even if there is no obvious damage.
- Do not attempt to install, remove, modify, disassemble or dispose of a seat belt. Have any necessary repairs carried out by your Toyota dealer. Inappropriate handling of the pretensioner may cause it to activate or operate improperly and may cause death or serious injury.

### 1-3. Adjustable components (seats, mirrors, steering wheel)

#### CAUTION

##### ■ Using a seat belt extender

- Do not wear the seat belt extender, if you can fasten the seat belt without the extender.
- Do not use the seat belt extender when installing a child restraint system, because the belt will not securely hold the child restraint system, increasing the risk of death or serious injury in the event of a sudden stop, sudden swerve or accident.
- The personalized extender may not be safe on another vehicle, when used by another person, or at a different seating position other than the one originally intended.

##### ■ Precaution for pre-collision seat belts

Do not rely solely on the pre-collision system to avoid accidents. Always pay attention to the surrounding conditions, and drive safely and responsibly.

#### NOTICE

##### ■ When using a seat belt extender

When releasing the seat belt, press on the buckle release button on the extender, not on the seat belt.  
This helps prevent damage to the vehicle interior and the extender itself.

1

Before driving

### 1-3. Adjustable components (seats, mirrors, steering wheel) Steering wheel

The steering wheel can be adjusted to a comfortable position while the “ENGINE START STOP” switch is in ACCESSORY or IGNITION ON mode.

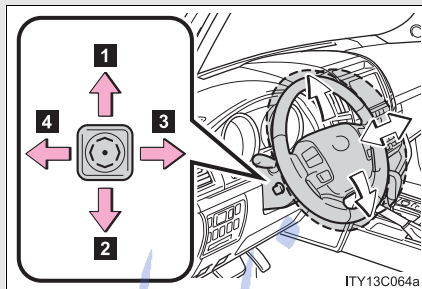

- 1 Up
- 2 Down
- 3 Toward the driver
- 4 Away from the driver

#### Auto tilt away and auto return

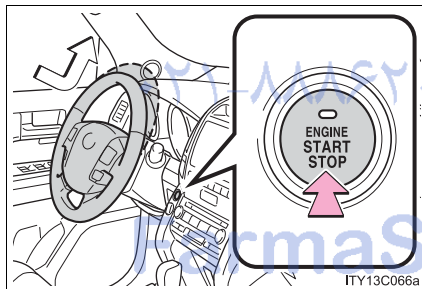

When the “ENGINE START STOP” switch is OFF, the steering wheel returns to its stowed position by moving up and away to enable easier driver entry and exit.

Switching to ACCESSORY or IGNITION ON mode will return the steering wheel to the original position.

#### ■ One-touch adjustment of the steering position

A desired steering position can be entered to memory and recalled automatically by the driving position memory. (→P. 63)

#### ⚠ CAUTION

##### ■ While driving

Do not adjust the steering wheel.

Doing so may cause the driver to mishandle the vehicle and an accident, resulting in death or serious injury.



1-3. Adjustable components (seats, mirrors, steering wheel)  
Inside rear view mirror

**In auto mode, sensors are used to detect the headlights of vehicles behind and automatically reduce the reflected light.**

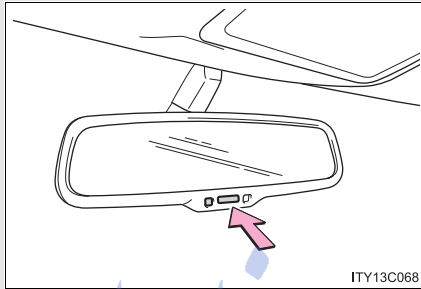

Turns auto mode on/off

The indicator comes on when auto mode is turned on.

The mirror will revert to the auto mode each time the "ENGINE START STOP" switch is turned to IGNITION ON mode.

1

Before driving

**Adjusting the height of the rear view mirror**

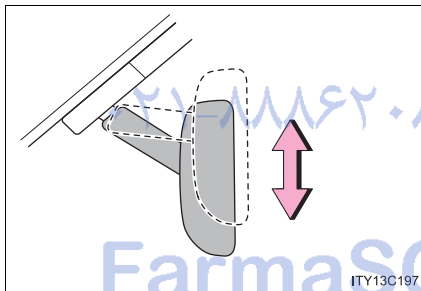

Adjust the height of the rear view mirror by moving it up and down.

1-3. Adjustable components (seats, mirrors, steering wheel)

■ To prevent sensor error

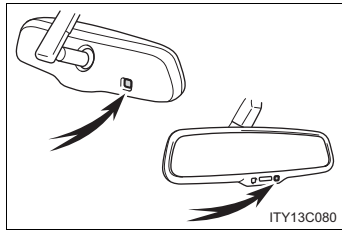

To ensure correct functioning of the sensors, do not touch or cover the sensors.

⚠ CAUTION

■ While driving

Do not adjust the position of the mirror.  
Doing so may lead to mishandling of the vehicle and an accident, or resulting in death or serious injury.

تلفن شبانه روزی: ۰۲۱-۸۸۶۲۰۸۵

FarmaSOS.com

### 1-3. Adjustable components (seats, mirrors, steering wheel) Outside rear view mirrors

Mirror angle can be adjusted using the switch when the “ENGINE START STOP” switch is in ACCESSORY or IGNITION ON mode.

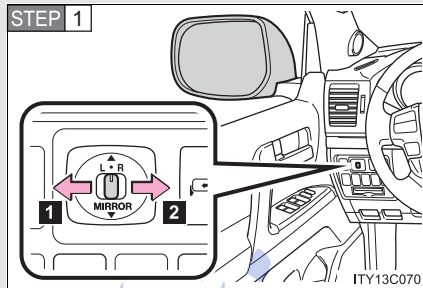

Select a mirror to adjust

- 1 Left
- 2 Right

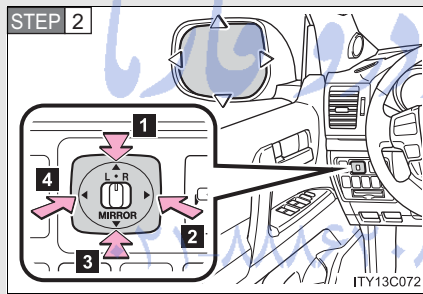

Adjust the mirror

- 1 Up
- 2 Right
- 3 Down
- 4 Left

1  
Before driving

#### Folding back the mirrors

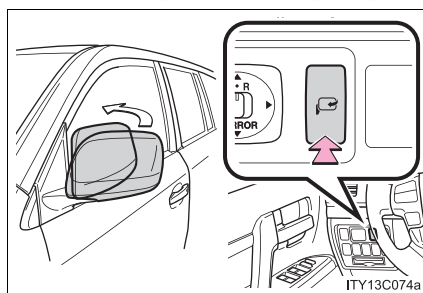

Press the switch

Pressing again will extend the mirror.

### 1-3. Adjustable components (seats, mirrors, steering wheel)

#### ■ When the mirrors are fogged up

Turn on the outside rear view mirror defoggers to defog the mirrors.  
(→P. 262)

#### ■ Auto anti-glare function

When the anti-glare inside rear view mirror is set to auto mode, the outside rear view mirrors will activate in conjunction with the anti-glare inside rear view mirror to reduce reflected light. (→P. 81)

#### ■ Linked mirror function when reversing

The outside rear view mirrors will automatically angle downwards when the vehicle is reversing in order to give a better view of the ground. However, this function will not operate when the mirror select switch is in the neutral position (between "L" and "R").

#### ■ One-touch adjustment of the mirror angle

A desired mirror face angle can be entered to memory and adjusted with the touch of a button. (→P. 63)

#### ⚠ CAUTION

##### ■ While driving

Observe the following precautions.

Failing to do so may result in losing control of the vehicle and cause an accident, resulting in death or serious injury.

- Do not adjust the mirrors.
- Do not drive with the mirrors folded back.
- Before driving, be sure to extend mirrors and make an adjustment properly.

##### ■ When the mirror defoggers are operating

Do not touch the rear view mirror surfaces, as they can become very hot and burn you.

1-3. Adjustable components (seats, mirrors, steering wheel)

 NOTICE

■ **If ice should jam the mirror**

Do not operate the control or scrape the mirror face. Use a spray de-icer to free the mirror.

1

Before driving

امداد خودرو فارما

تلفن شبانه روزی: ۰۲۱-۸۸۸۶۲۰۸۵

FarmaSOS.com

## 1-4. Opening and closing the windows and moon roof Power windows

The power windows can be opened and closed using the following switches.

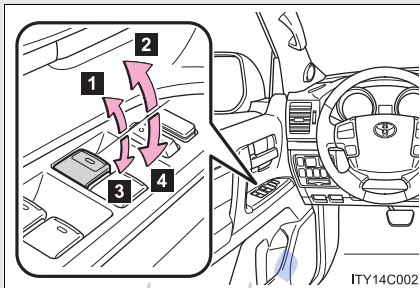

- 1 Closing
- 2 One-touch closing\*
- 3 Opening
- 4 One-touch opening\*

\*: Pressing the switch in the opposite direction will stop window travel partway.

### Lock switch

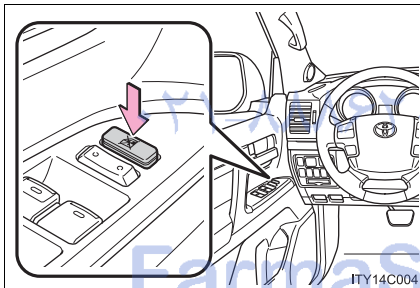

Press the switch down to lock passenger window switches.

Use this switch to prevent children from accidentally opening or closing a passenger window.

■ **The power windows can be operated when**

The “ENGINE START STOP” switch is in IGNITION ON mode.

■ **Door lock linked window operation**

The following functions can be used if customized at your Toyota dealer.

- The power windows can be opened and closed using the mechanical key. (→P. 42)
- The power windows can be opened using the wireless remote control. (→P. 39)
- The power windows can be closed using the smart key system. (→P. 27)

■ **Operating the power windows after turning the “ENGINE START STOP” switch OFF**

The power windows can be operated for approximately 45 seconds even after the “ENGINE START STOP” switch is turned ACCESSORY mode or turned OFF. They cannot, however, be operated once the driver’s or front passenger’s door is opened.

■ **Jam protection function**

If an object becomes caught between the window and the window frame, window travel is stopped and the window is opened slightly.

■ **Customization**

Settings (e.g. linked door lock operation) can be changed. (Customizable features →P. 573)

#### 1-4. Opening and closing the windows and moon roof

##### CAUTION

###### ■ Closing the windows

Observe the following precautions.

Failing to do so may result in death or serious injury.

- Check to make sure that all passengers do not have any part of their body in a position where it could be caught when a window is being operated.
- Do not allow children to operate the power windows.  
Closing a power window on someone can cause death or serious injury.

###### ■ Jam protection function

- Never try jamming any part of your body to activate the jam protection function intentionally.
- The jam protection function may not work if something gets caught just before the window fully closes.

تلفن شبانه روزی: ۰۲۱-۸۸۸۶۲۰۸۵

FarmaSOS.com



## 1-4. Opening and closing the windows and moon roof Moon roof

Use the overhead switches to open, close, and tilt the moon roof up and down.

### ■ Opening and closing

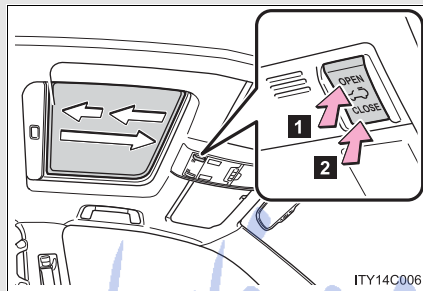

#### 1 Open

Stops just before it is opened fully. Press the switch again to fully open.

#### 2 Close

To stop partway, press the switch lightly.

### ■ Tilt up and down

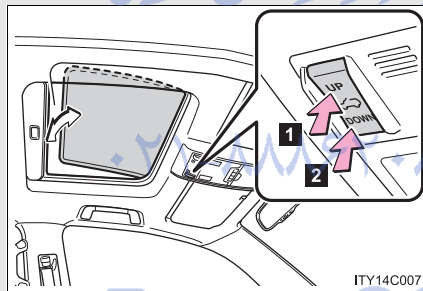

#### 1 Tilt up

#### 2 Tilt down

To stop partway, press the switch lightly.

1

Before driving

FarmaSOS.com

■ **The moon roof can be operated when**

The "ENGINE START STOP" switch is in IGNITION ON mode.

■ **Door lock linked moon roof operation**

The following functions can be used if customized at your Toyota dealer.

- The moon roof can be opened and closed using the mechanical key. (→P. 42)
- The moon roof can be opened using the wireless remote control. (→P. 39)
- The moon roof can be closed using the smart key system. (→P. 27)

■ **Operating the moon roof after turning the "ENGINE START STOP" switch OFF**

The moon roof can be operated for approximately 45 seconds even after the "ENGINE START STOP" switch is turned to ACCESSORY mode or turned OFF. It cannot, however, be operated once the driver's or front passenger's door is opened.

■ **Jam protection function**

If an object is detected between the moon roof and the frame while closing or tilting down, travel is stopped and the moon roof opens slightly.

■ **If the moon roof cannot be closed automatically**

Keep the switch depressed.

■ **To reduce moon roof wind noise**

Drive with the moon roof opened automatically (just before fully opened position).

■ **Sunshade**

The sunshade can be opened and closed manually. However, the sunshade will open automatically when the moon roof is opened.

■ **Moon roof open warning buzzer**

The buzzer sounds and message is shown on the multi-information display in the instrument panel when the “ENGINE START STOP” switch is turned OFF and the driver’s door is opened with the moon roof open.

■ **Customization**

Settings (e.g. linked door lock operation) can be changed. (Customizable features →P. 573)

1

Before driving

**⚠ CAUTION**

■ **Opening the moon roof**  
Observe the following precautions.  
Failing to do so may cause death or serious injury.

- Do not allow any passengers to put their hands or heads outside the vehicle while it is moving.
- Do not sit on top of the moon roof.

■ **Closing the moon roof**  
Observe the following precautions.  
Failing to do so may result in death or serious injury.

- Check to make sure that all passengers do not have any part of their bodies in a position where they could be caught when the moon roof is being operated.
- Do not allow children to operate the moon roof.  
Closing the moon roof on someone can cause death or serious injury.

■ **Jam protection function**

- Never try jamming any part of your body to activate the jam protection function intentionally.
- The jam protection function may not work if something gets caught just before the moon roof fully closes.

## 1-5. Refueling

### Opening the fuel tank cap

Perform the following steps to open the fuel tank cap.

#### ■ Before refueling the vehicle

Turn the “ENGINE START STOP” switch OFF and ensure that all the doors and windows are closed.

#### ■ Opening the fuel tank cap

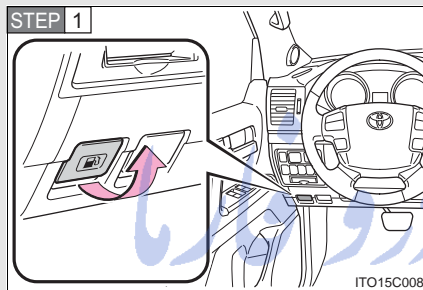

Pull the lever.

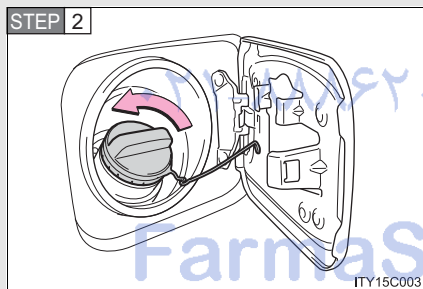

Turn the fuel tank cap slowly to open.

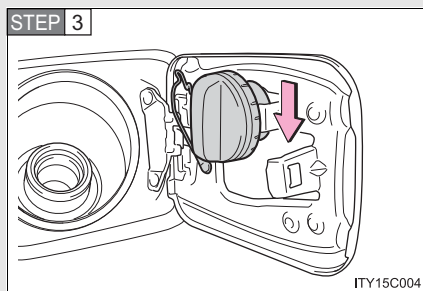

Hang the fuel tank cap on the back of the fuel filler door.

### Closing the fuel tank cap

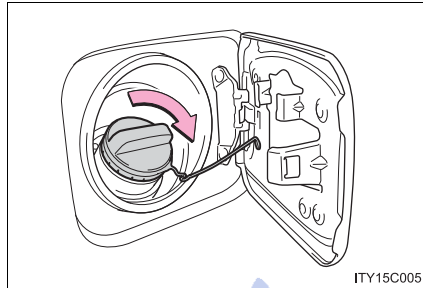

When replacing the fuel tank cap, turn it until a clicking sound is heard.

After releasing your hand, the cap will turn slightly to the opposite direction.

1

Before driving

#### ■ Fuel types

Use unleaded gasoline. (Octane Rating 87 [Research Octane Number 91] or higher)

#### ■ Fuel tank capacity

Approximately 24.6 gal. (93 L, 20.5 Imp. gal.)

تلفن شبانه روزی: ۰۲۱-۸۸۸۶۲۰۸۵

FarmaSOS.com

 CAUTION

■ **Refueling the vehicle**

Observe the following precautions while refueling the vehicle.  
Failure to do so, may result in death or serious injury.

- Touch the vehicle or some other metal surface to discharge any static electricity.  
Sparks resulting from discharging static electricity may cause the fuel vapors to ignite.
- Always hold the grips on the fuel tank cap and turn it slowly to remove it.  
A whooshing sound may be heard when the fuel tank cap is loosened.  
Wait until the sound cannot be heard before fully removing the cap.  
In hot weather, pressurized fuel may spray out the filler neck and cause injury.
- Do not allow anyone that has not discharged static electricity from their bodies to come close to an open fuel tank.
- Do not inhale vaporized fuel.  
Fuel contains substances that are harmful if inhaled.
- Do not smoke while refueling the vehicle.  
Doing so may cause the fuel to ignite and cause a fire.
- Do not return to the vehicle or touch any person or object that is statically charged.  
This may cause static electricity to build up, resulting in a possible ignition hazard.

■ **When replacing the fuel tank cap**

Do not use anything but a genuine Toyota fuel tank cap designed for your vehicle. Failure to do so may cause a fire or other incident which may result in death or serious injury.

 NOTICE

■ Refueling

Do not spill fuel during refueling.

Failing to do so may damage the vehicle, such as causing the exhaust systems to operate abnormally or damaging fuel system components or the vehicle's painted surface.

1

Before driving

امداد خودرو فارما

تلفن شبانه روزی: ۰۲۱-۸۸۸۶۲۰۸۵

FarmaSOS.com

## 1-6. Theft deterrent system Engine immobilizer system

The vehicle's keys have built-in transponder chips that prevent the engine from starting if the key has not been previously registered in the vehicle's on-board computer.

**Never leave the keys inside the vehicle when you leave the vehicle.**

### ► Vehicles with navigation system

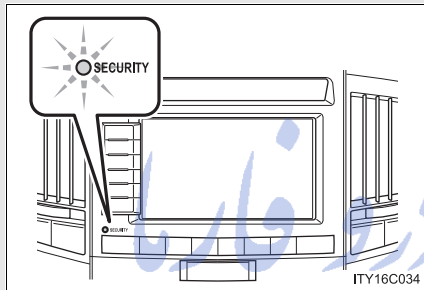

The indicator light flashes after the "ENGINE START STOP" switch has been turned OFF to indicate that the system is operating.

The indicator light stops flashing after the "ENGINE START STOP" switch has been turned to ACCESSORY or IGNITION ON mode to indicate that the system has been canceled.

### ► Vehicles without navigation system

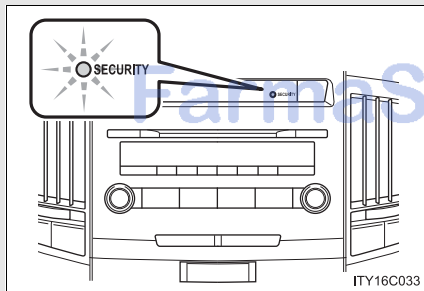



**■ System maintenance**

The vehicle has a maintenance-free type engine immobilizer system.

**■ Conditions that may cause the system to malfunction**

- If the key is in contact with a metallic object.
- If the key is in close proximity to or touching a key to the security system (key with a built-in transponder chip) of another vehicle.

**■ Certifications for the engine immobilizer system**

FCC ID: NI4TMIMB-1

**NOTE:**

This device complies with Part 15 of the FCC Rules. Operation is subject to the following two conditions: (1) this device may not cause harmful interference, and (2) this device must accept any interference received, including interference that may cause undesired operation.

**FCC WARNING:**

Changes or modifications not expressly approved by the party responsible for compliance could void the user's authority to operate the equipment.

**⚠ CAUTION****■ Certifications for the engine immobilizer system**

Changes or modifications not expressly approved by the party responsible for compliance could void the user's authority to operate the equipment.

**⚠ NOTICE****■ To ensure the system operates correctly**

Do not modify or remove the system. If modified or removed, the proper operation of the system cannot be guaranteed.

## 1-6. Theft deterrent system Alarm

**The system sounds the alarm and flashes lights when forcible entry is detected.**

### ■ Triggering of the alarm

The alarm is triggered in the following situations when the alarm is set:

- A locked door is unlocked or opened in any way other than by using the smart key system or wireless remote control. (The doors will lock again automatically)
- The hood is opened.
- The battery is reconnected.

### ■ Setting the alarm system

#### ▶ Vehicles with navigation system

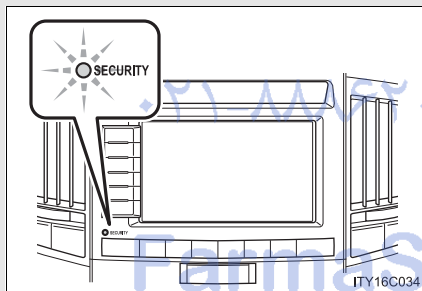

Close the doors and hood, and lock all doors.

The system will be set automatically after 30 seconds.

The indicator light changes from being on to flashing when the system is set.

#### ▶ Vehicles without navigation system

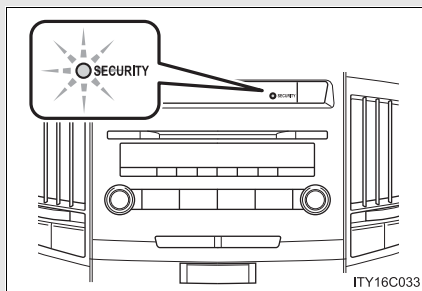

■ **Deactivating or stopping the alarm**

Do one of the following to deactivate or stop the alarm.

- Unlock the doors using the smart key system or the wireless remote control.
- Start the engine. (The alarm will be deactivated or stopped after a few seconds.)

1

Before driving

■ **System maintenance**

The vehicle has a maintenance-free type alarm system.

■ **Items to check before locking the vehicle**

To prevent unexpected triggering of the alarm and vehicle theft, make sure of the following.

- Nobody is in the vehicle.
- The windows and moon roof are closed before the alarm is set.
- No valuables or other personal items are left in the vehicle.

FarmaSOS.com

## 1-6. Theft deterrent system

### ■ Triggering of the alarm

The alarm may be triggered in the following situations.  
(Stopping the alarm deactivates the alarm system.)

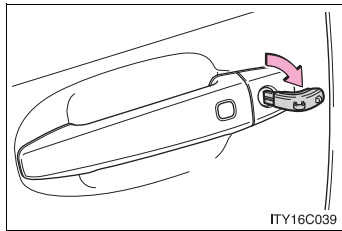

- The door is unlocked using the mechanical key.

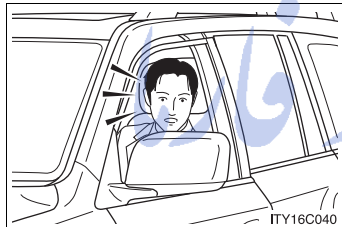

- A person inside the vehicle opens a door or hood.

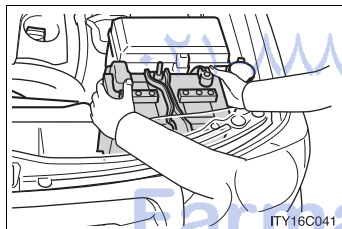

- The battery is recharged or replaced when the vehicle is locked.

■ **When the battery is disconnected**

Be sure to cancel the alarm system.

If the battery is disconnected before canceling the alarm, the system may be triggered when the battery is reconnected.

■ **Alarm-operated door lock**

- When the alarm is operating, the doors are locked automatically to prevent intruders.
- Do not leave the key inside the vehicle when the alarm is operating, and make sure the key is not inside the vehicle when recharging or replacing the battery.

■ **Panic mode**

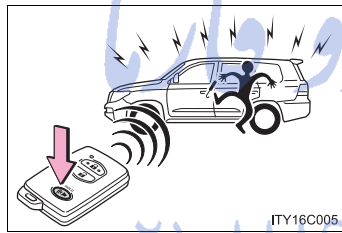

When  is pressed for longer than about one second, the headlights/tail lights/emergency flashers will flash, the front and rear interior lights will come on, and an alarm will sound for about 60 seconds to deter any person from trying to break into or damage your vehicle.

To stop the alarm, press any button on the wireless remote control.

 <b>NOTICE</b>
<p>■ <b>To ensure the system operates correctly</b></p> <p>Do not modify or remove the system. If modified or removed, the proper operation of the system cannot be guaranteed.</p>

## 1-7. Safety information Correct driving posture

Drive with a good posture as follows:

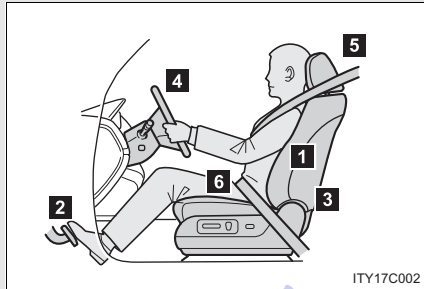

- 1 Sit upright and well back in the seat. (→P. 52)
- 2 Adjust the position of the seat forward or backward to ensure the pedals can be reached and easily depressed to the extent required. (→P. 52)
- 3 Adjust the seatback so that the controls are easily operable.
- 4 Adjust the tilt and telescopic positions of the steering wheel downward so the airbag is facing your chest. (→P. 80)
- 5 Lock the head restraint in place with the center of the head restraint closest to the top of your ears. (→P. 67)
- 6 Wear the seat belt correctly. (→P. 71)

**⚠ CAUTION****■ While driving**

- Do not adjust the position of the driver's seat.  
Doing so could cause the driver to lose control of the vehicle.
- Do not place a cushion between the driver or passenger and the seatback.  
A cushion may prevent correct posture from being achieved, and reduce the effectiveness of the seat belt and head restraint, increasing the risk of death or serious injury to the driver or passenger.
- Do not place anything under the front seats.  
Objects placed under the front seats may become jammed in the seat tracks and stop the seat from locking in place. This may lead to an accident. The adjustment mechanism may also be damaged.

**■ Adjusting the seat position**

- Do not recline the seat more than necessary when the vehicle is in motion, to reduce the risk of sliding under the lap belt.  
If the seat is too reclined during an accident, the lap belt may slide past the hips and apply restraint forces directly to the abdomen or your neck may contact the shoulder belt, increasing the risk of death or serious injury.
- Take care when adjusting the seat position to ensure that other passengers are not injured by the moving seat.
- Do not put your hands under the seat or near the moving parts to avoid injury.  
Fingers or hands may become jammed in the seat mechanism.

1

Before driving

## 1-7. Safety information SRS airbags

The SRS airbags inflate when the vehicle is subjected to certain types of severe impacts that may cause significant injury to the occupants. They work together with the seat belts to help reduce the risk of death or serious injury.

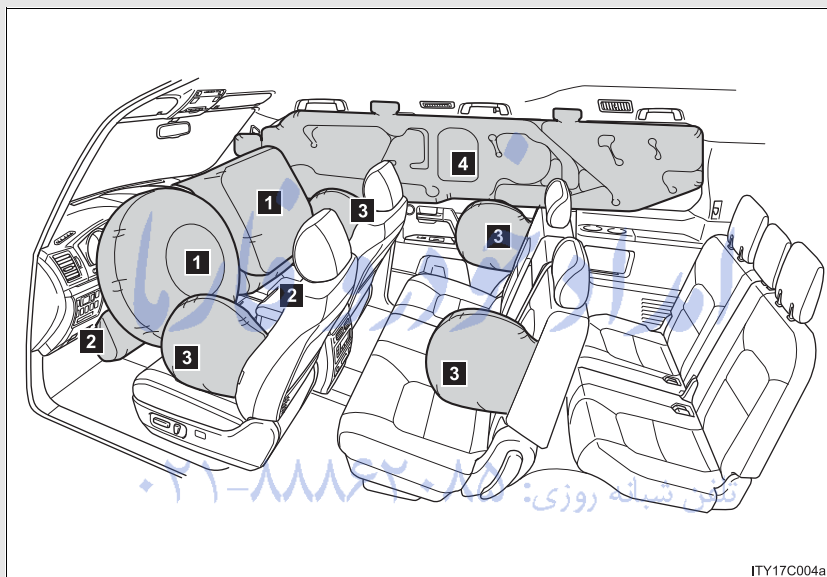

### ► Front airbags

- 1** Driver airbag/front passenger airbag  
Can help protect the head and chest of the driver and front passenger from impact with interior components.
- 2** Knee airbags  
Can help provide driver and front passenger protection.



► Side and curtain shield airbags

3 Side airbags

Can help protect the torso of the front and second outboard seat occupants.

4 Curtain shield airbags

Can help protect primarily the head of front seat occupants, second and third outboard seat occupants.

1

Before driving

امداد خودرو فارما

تلفن شبانه روزی: ۰۲۱-۸۸۸۶۲۰۸۵

FarmaSOS.com

**Airbag system components**

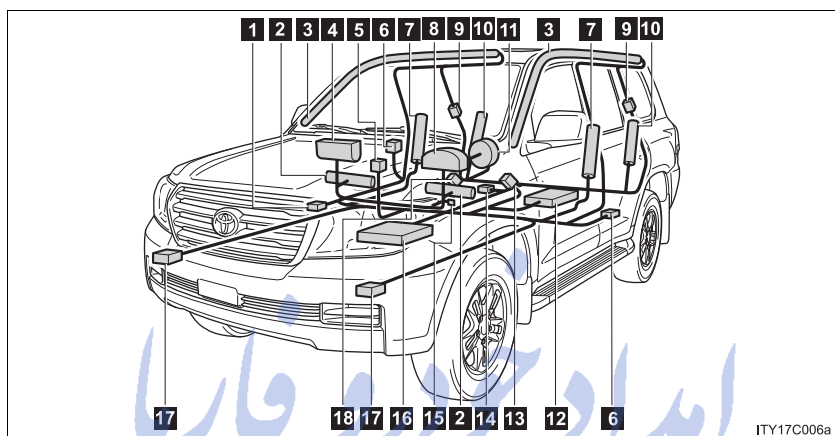

- |  |   |
|--|---|
| <b>1</b> Occupant detection system (ECU & sensors)               | <b>10</b> Side airbags (second outboard seats)              |
| <b>2</b> Knee airbags  | <b>11</b> Driver airbag                                     |
| <b>3</b> Curtain shield airbags                                  | <b>12</b> Driver's seat position sensor                     |
| <b>4</b> Front passenger airbag                                  | <b>13</b> Driver's seat belt buckle switch                  |
| <b>5</b> Front passenger occupant classification indicator light | <b>14</b> Floor sensor                                      |
| <b>6</b> Side and curtain shield airbag sensors                  | <b>15</b> Roll sensing of curtain shield airbags off switch |
| <b>7</b> Side airbags (front seats)                              | <b>16</b> Airbag sensor assembly                            |
| <b>8</b> SRS warning light and "RSCA OFF" indicator light        | <b>17</b> Front airbag sensors                              |
| <b>9</b> Curtain shield airbag sensors                           | <b>18</b> Front passenger's seat belt buckle switch         |

Your vehicle is equipped with ADVANCED AIRBAGS designed based on US motor vehicle safety standards (FMVSS208). The airbag system controls airbag deployment power for the driver and front passenger. The driver airbag system consists of the driver seat's position sensor etc. The front passenger's airbag system consists of the front passenger occupant classification sensor etc.

The main SRS airbag system components are shown above. The SRS airbag system is controlled by the airbag sensor assembly. The airbag sensor assembly consists of a safing sensor and an airbag sensor.

In certain types of severe frontal or side impacts, the SRS airbag system triggers the airbag inflators. A chemical reaction in the inflators quickly fills the airbags with non-toxic gas to help restrain the motion of the occupants.

1

Before driving

#### ■ If the SRS airbags deploy (inflate)

- Bruising and slight abrasions may result from contact with a deploying (inflating) SRS airbag.
- A loud noise and white powder will be emitted.
- Parts of the airbag module (steering wheel hub, airbag cover and inflator) as well as the front seats, second seats, and parts of the front, center and rear pillars, and roof side rail, may be hot for several minutes. The airbag itself may also be hot.
- The windshield may crack.
- For Safety Connect subscribers, if the SRS airbags deploy or in the event of a severe rear-end collision, the system is designed to send an emergency call to the response center, notifying them of the vehicle's location (without needing to push the "SOS" button) and an agent will attempt to speak with the occupants to ascertain the level of emergency and assistance required. If the occupants are unable to communicate, the agent automatically treats the call as an emergency and helps to dispatch the necessary emergency services. (→P. 406)

■ **SRS airbag deployment conditions (SRS front airbags)**

- The SRS front airbag will deploy in the event of an impact that exceeds the set threshold level (the level of force corresponding to an approximately 12 - 18 mph [20 - 30 km/h] frontal collision with a fixed wall that does not move or deform).

However, this threshold velocity will be considerably higher if the vehicle strikes an object, such as a parked vehicle or sign pole, which can move or deform on impact, or if the vehicle is involved in an underride collision (e.g. a collision in which the front of the vehicle “underrides”, or goes under, the bed of a truck, etc.).

- It is possible that in some collisions where the forward deceleration of the vehicle is very close to the designed threshold level, the SRS front airbags and the seat belt pretensioners may not activate together.
- The SRS front passenger airbag will not activate if there is not passenger sitting in the front passenger seat. However, the front passenger airbag may deploy if luggage is put in the seat or the seat belt is fastened, even if the seat is unoccupied.

■ **SRS airbag deployment conditions (SRS side airbags and SRS curtain shield airbags)**

- The SRS side airbags and SRS curtain shield airbags will deploy in the event of an impact that exceeds the set threshold level (the level of force corresponding to the impact force produced by an approximately 3300 lb. [1500 kg] vehicle colliding with the vehicle cabin from a direction perpendicular to the vehicle orientation at an approximately speed of 12 - 18 mph [20 - 30 km/h]).
- The SRS side airbag on the passenger seat will not activate if there is no passenger sitting in the front passenger seat. However, the side airbag on the passenger seat may deploy if luggage is put in the seat or the seat belt is fastened, even if the seat is unoccupied.

### ■ Conditions under which the SRS airbags may deploy (inflate), other than a collision

The SRS front, side and curtain shield airbags may also deploy if a serious impact occurs to the underside of your vehicle. Some examples are shown in the illustration.

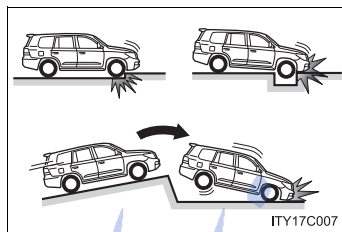

- Hitting a curb, edge of pavement or hard surface
- Falling into or jumping over a deep hole
- Landing hard or vehicle falling

The SRS curtain shield airbags may also deploy under the situations shown in the illustration.

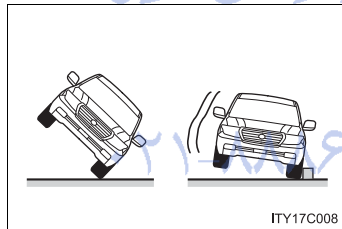

- The angle of vehicle tip-up is marginal.
- The vehicle skids and hits a curb stone.

### ■ Types of collisions that may not deploy the SRS airbag (front airbags)

The SRS front airbags are generally not designed to inflate if the vehicle is involved in a side or rear collision, if it rolls over, or if it is involved in a low-speed frontal collision. But, whenever a collision of any type causes sufficient forward deceleration of the vehicle, deployment of the SRS front airbags may occur.

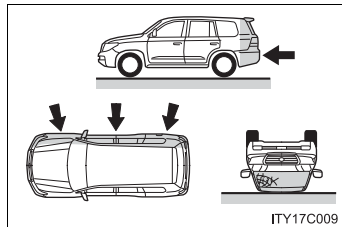

- Collision from the side
- Collision from the rear
- Vehicle rollover

1

Before driving

## 1-7. Safety information

### ■ Types of collisions that may not deploy the SRS airbag (side and curtain shield airbags)

The SRS side airbag and curtain shield airbag system may not activate if the vehicle is subjected to a collision from the side at certain angles, or a collision to the side of the vehicle body other than the passenger compartment.

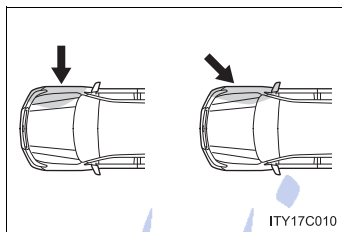

- Collision from the side to the vehicle body other than the passenger compartment
- Collision from the side at an angle

The SRS side airbags are generally not designed to inflate if the vehicle is involved in a frontal or rear collision, if it rolls over, or if it is involved in a low-speed side collision.

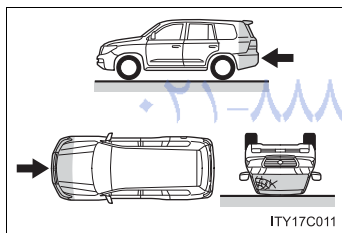

- Collision from the front
- Collision from the rear
- Vehicle rollover

The SRS curtain shield airbags are generally not designed to inflate if the vehicle is involved in a frontal or rear collision, if it pitches end over end, or if it is involved in a low-speed side collision.

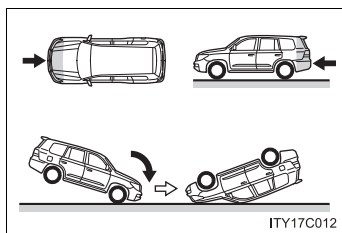

- Collision from the front
- Collision from the rear
- Pitching end over end

■ **When to contact your Toyota dealer**

In the following cases, contact your Toyota dealer as soon as possible.

- Any of the SRS airbags have been inflated.

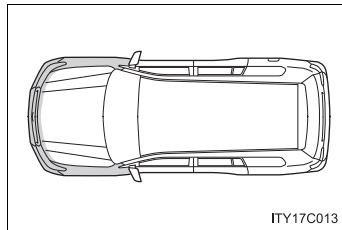

- The front of the vehicle is damaged or deformed, or the vehicle was involved in an accident that was not severe enough to cause the SRS airbags to inflate.

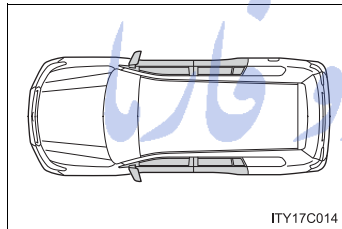

- A portion of the doors is damaged or deformed, or the vehicle was involved in an accident that was not severe enough to cause the SRS side airbags and curtain shield airbags to inflate.

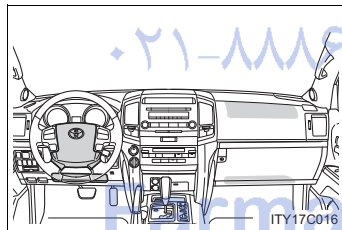

- The pad section of the steering wheel, dashboard near the front passenger airbag or lower portion of the instrument panel is scratched, cracked or otherwise damaged.

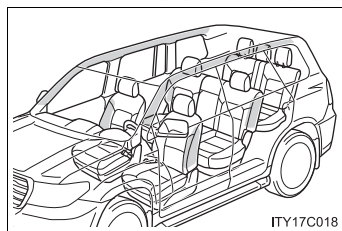

- The surface of the seats with the side airbag is scratched, cracked, or otherwise damaged.
- The portion of the front, center and rear pillar garnish, or roof interior containing the curtain shield airbags inside is scratched, cracked or otherwise damaged.

1

Before driving

 CAUTION

■ **SRS airbag precautions**

Observe the following precautions regarding the airbags.  
Failure to do so may cause death or serious injury.

- The driver and all passengers in the vehicle must wear their seat belts properly.

The SRS airbags are supplemental devices to be used with the seat belts.

- The SRS driver airbag deploys with considerable force, and can cause death or serious injury especially if the driver is very close to the airbag. The National Highway Traffic Safety Administration (“NHTSA”) advises:

Since the risk zone for driver airbag is the first 2 - 3 in. (50 - 75 mm) of inflation, placing yourself 10 in. (250 mm) from your driver airbag provides you with a clear margin of safety. This distance is measured from the center of the steering wheel to your breastbone. If you sit less than 10 in. (250 mm) away now, you can change your driving position in several ways:

- Move your seat to the rear as far as you can while still reaching the pedals comfortably.
- Slightly recline the back of the seat.  
Although vehicle designs vary, many drivers can achieve the 10 in. (250 mm) distance, even with the driver seat all the way forward, simply by reclining the back of the seat somewhat. If reclining the back of your seat makes it hard to see the road, raise yourself by using a firm, non-slippery cushion, or raise the seat if your vehicle has that feature.
- If your steering wheel is adjustable, tilt it downward. This points the airbag toward your chest instead of your head and neck.

The seat should be adjusted as recommended by NHTSA above, while still maintaining control of the foot pedals, steering wheel, and your view of the instrument panel controls.

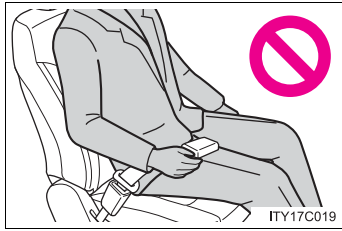

**⚠ CAUTION****■ SRS airbag precautions**

● If the seat belt extender has been connected to the driver's seat belt buckle but the seat belt extender has not also been fastened to the latch plate of the driver's seat belt, the SRS driver's airbag system will judge that the driver is wearing the seat belt even though the seat belt has not been connected. In this case, the driver's airbag may not activate correctly in a collision, resulting in death or serious injury in the event of collision. Be sure to wear the seat belt with the seat belt extender.

- The SRS front passenger airbag also deploys with considerable force, and can cause death or serious injury especially if the front passenger is very close to the airbag. The front passenger seat should be as far from the airbag as possible with the seatback adjusted, so the front passenger sits upright.
- Improperly seated and/or restrained infants and children can be killed or seriously injured by a deploying airbag. An infant or child who is too small to use a seat belt should be properly secured using a child restraint system. Toyota strongly recommends that all infants and children be placed in the rear seats of the vehicle and properly restrained. The rear seats are the safest for infants and children. (→P. 125)

1

Before driving

**CAUTION**

**SRS airbag precautions**

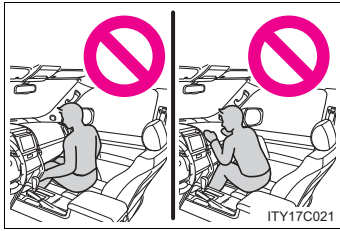

- Do not sit on the edge of the seat or lean against the dashboard.

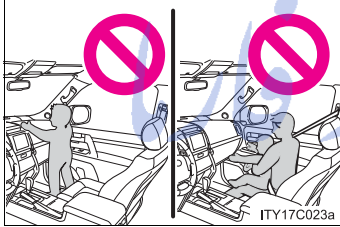

- Do not allow a child to stand in front of the SRS front passenger airbag unit or sit on the knees of a front passenger.
- Do not drive the vehicle while the driver or passenger have items resting on their knees.



- Do not lean against the door, the roof side rail or the front, center and rear pillars.

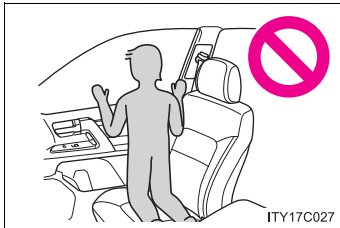

- Do not allow anyone to kneel on the passenger seats toward the door or put their head or hands outside the vehicle.

**⚠ CAUTION**

**■ SRS airbag precautions**

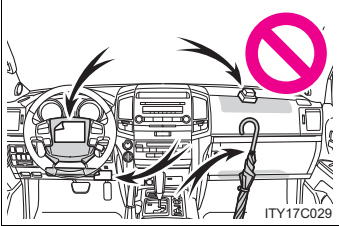

ITY17C029

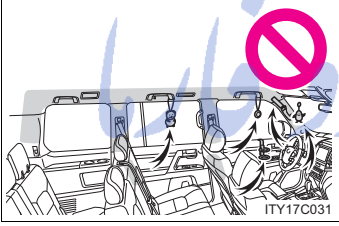

ITY17C031

- Do not attach anything to or lean anything against areas such as the dashboard or steering wheel pad or lower portion of the instrument panel. These items can become projectiles when SRS driver, front passenger and knee airbags deploy.
- Do not attach anything to areas such as the door, windshield glass, side door glass, front, center and rear pillars, roof side rail or assist grip.
- Do not hang coat hangers or other hard objects on the coat hooks. All of these items could become projectiles and seriously injure or kill you, should the SRS curtain shield airbag deploy.

تلفن شبانه روزی: ۰۲۱-۸۸۶۲۰۸۵

1

Before driving

FarmaSOS.com

 CAUTION

■ SRS airbag precautions

- If the vinyl cover is put on the area where the SRS knee airbag will deploy, be sure to remove it.
- Do not use seat accessories which cover the parts where the SRS side airbags inflate as they may interfere with inflation of the airbags.
- Do not strike or apply significant levels of force to the area of the SRS airbag components shown on P. 106. Doing so can cause the SRS airbags to malfunction.
- Do not touch any of the component parts immediately after the SRS airbags have deployed (inflated) as they may be hot.
- If breathing becomes difficult after the SRS airbag has deployed, open a door or window to allow fresh air in, or leave the vehicle if it is safe to do so. Wash off any residue as soon as possible to prevent skin irritation.
- If the areas where the SRS airbags are stored, such as the steering wheel pad and front, center and rear pillar garnishes, are damaged or cracked, have them replaced by your Toyota dealer.

FarmaSOS.com

**⚠ CAUTION****■ Modification and disposal of SRS airbag system components**

Do not dispose of your vehicle or perform any of the following modifications without consulting your Toyota dealer. The SRS airbag may malfunction or deploy (inflate) accidentally, causing death or serious injury.

- Installation, removal, disassembly and repair of the SRS airbags
- Repairs, modifications, removal or replacement of the steering wheel, instrument panel, dashboard, seats or seat upholstery, front, center and rear pillars or roof side rail
- Repairs or modifications of the front fender, front bumper, or side of the occupant compartment
- Installation of snow plows, winches, etc. to the front grille (bull bars, kangaroo bar etc.)
- Modifications to the vehicle's suspension system
- Installation of electronic devices such as mobile two-way radios or CD players
- Modifications to your vehicle for a person with a physical disability

1

Before driving

FarmaSOS.com

### Deactivating the curtain shield airbags in a vehicle rollover

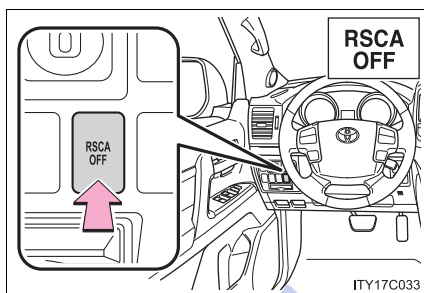

On/off (Hold for a few seconds)

The "RSCA OFF" (roll sensing of curtain shield airbags off) indicator light turns on. (Only when the "ENGINE START STOP" switch is in IGNITION ON mode.)

#### ■ This switch only should be used

In a situation where the inflation is not desired (such as during extreme off road driving).

#### ■ Operating conditions when the "RSCA OFF" indicator is on

- The curtain shield airbag and seat belt pretensioner will not activate in a vehicle rollover.
- The curtain shield airbag will activate in a severe side impact.

#### ⚠ CAUTION

#### ■ While normal driving

Make sure the "RSCA OFF" indicator light is not turned on. If it is left on, the curtain shield airbag will not activate in the event of an accident, which may cause death or serious injury.

## 1-7. Safety information

### Front passenger occupant classification system

Your vehicle is equipped with a front passenger occupant classification system. This system detects the conditions of the front passenger seat and activates or deactivates the devices for front passenger.

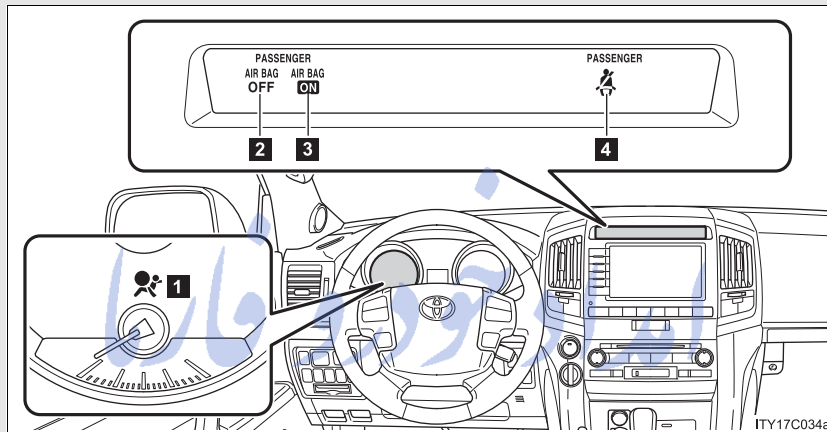

- 1 SRS warning light
- 2 AIR BAG OFF indicator light
- 3 AIR BAG ON indicator light
- 4 Front passenger's seat belt reminder light

1

Before driving

FarmaSOS.com

### Condition and operation in the front passenger occupant classification system

#### ■ Adult\*1

Indicator/ warning light	AIR BAG ON and AIR BAG OFF indicator lights	On
	SRS warning light	Off
	Front passenger's seat belt reminder light	Flashing*2
Devices	Front passenger airbag and knee airbag	Activated
	Side airbag in the front passenger seat	
	Curtain shield airbag on the front passenger side	
	Front passenger's seat belt pretensioner	

#### ■ Child\*3 or child restraint system\*4

Indicator/ warning light	AIR BAG ON and AIR BAG OFF indicator lights	Off*5
	SRS warning light	Off
	Front passenger's seat belt reminder light	Flashing*2
Devices	Front passenger airbag and knee airbag	Deactivated
	Side airbag in the front passenger seat	
	Curtain shield airbag on the front passenger side	Activated
	Front passenger's seat belt pretensioner	



■ **Unoccupied**

Indicator/ warning light	AIR BAG ON and AIR BAG OFF indicator lights	Not illumi- nated
	SRS warning light	Off
	Front passenger's seat belt reminder light	
Devices	Front passenger airbag and knee airbag	Deactivated
	Side airbag in the front passenger seat	
	Curtain shield airbag on the front passenger side	Activated
	Front passenger's seat belt pretensioner	Deactivated

1

Before driving

امداد خودرو فارما  
تلفن شبانه روزی: ۰۲۱-۸۸۸۶۲۰۸۵

FarmaSOS.com

■ System malfunction

Indicator/ warning light	AIR BAG ON and AIR BAG OFF indicator lights	Off
	SRS warning light	On
	Front passenger's seat belt reminder light	Off
Devices	Front passenger airbag and knee airbag	Deactivated
	Side airbag in the front passenger seat	
	Curtain shield airbag on the front passenger side	Activated
	Front passenger's seat belt pretensioner	

- \*1: The system judges a person of adult size as an adult. When a smaller adult sits in the front passenger seat, the system may recognize him/her as a child depending on his/her physique and posture.
- \*2: In the event the front passenger does not wear a seat belt.
- \*3: When a larger child who has outgrown a child restraint system sits in the front passenger seat, the system may recognize him/her as an adult depending on his/her physique or posture.
- \*4: Never install a rear-facing child restraint system on the front passenger seat. A forward-facing child restraint system should only be installed on the front passenger seat when it is unavoidable.  
(→P. 125)
- \*5: In case the indicator is not illuminated, consult this manual as for installing the child restraint system properly. (→P. 129)

**⚠ CAUTION****■ Front passenger occupant classification system precautions**

Observe the following precautions regarding front passenger occupant classification system.

Failure to do so may cause death or serious injury.

- Wear the seat belt properly.
- Make sure the front passenger's seat belt tab has not been left inserted into the buckle before someone sits in the front passenger seat.
- Make sure the AIR BAG OFF indicator light is not illuminated when using the seat belt extender for the front passenger seat. If the AIR BAG OFF indicator light is illuminated, disconnect the extender tongue from the seat belt buckle, then reconnect the seat belt. Reconnect the seat belt extender after making sure the AIR BAG ON indicator light is illuminated. If you use the seat belt extender while the AIR BAG OFF indicator light is illuminated, the front passenger airbag and side airbag on the front passenger side may not activate correctly, which could cause death or serious injury in the event of collision.
- Do not apply a heavy load to the front passenger seat.
- Do not put weight on the front passenger seat by putting your hands or feet on the front passenger seat seatback from the second seat.
- Do not let a second seat passenger lift the front passenger seat with their feet or press on the seatback with their legs.
- Do not put objects under the front passenger seat.
- Do not recline the front passenger seatback so far that it touches a second seat. This may cause the AIR BAG OFF indicator light to be illuminated, which indicates that the passenger's airbags will not deploy in the event of a severe accident. If the seatback touches the second seat, return the seatback to a position where it does not touch the second seat. Keep the front passenger seatback as upright as possible when the vehicle is moving. Reclining the seatback excessively may lessen the effectiveness of the seat belt system.

1

Before driving

 CAUTION

■ **Front passenger occupant classification system precautions**

- If an adult sits in the front passenger seat, the AIR BAG ON indicator light is illuminated. If the AIR BAG OFF indicator is illuminated, ask the passenger to sit up straight, well back in the seat, feet on the floor, and with the seat belt worn correctly. If the AIR BAG OFF indicator still remain illuminated, either ask the passenger to move to the second seat, or if that is not possible, move the front passenger seat fully rearward.
- When it is unavoidable to install the forward-facing child restraint system on the front passenger seat, install the child restraint system on the front passenger seat in the proper order. (→P. 129)
- Do not modify or remove the front seat.
- Do not kick the front passenger seat or subject it to severe impact. Otherwise, the SRS warning light may come on to indicate a malfunction in the detection system. In this case, contact your Toyota dealer immediately.
- Do not use a seat accessory, such as a cushion or seat cover, that covers the seat cushion surface.
- Child restraint systems installed on the second seat should not contact the front seatbacks.

FarmaSOS.com

## 1-7. Safety information

### Child restraint systems

**A child restraint system for a small child or baby must itself be properly restrained on the seat with the lap portion of the lap/shoulder belt.**

**The laws of all 50 states of the U.S.A. now require the use of child restraint systems.**

1

Before driving

#### Points to remember

Studies have shown that installing a child restraint on a rear seat is much safer than installing one to the front passenger seat.

- Choose a child restraint system that suits your vehicle and is appropriate to the age and size of the child.
- For installation details, follow the instructions provided with the child restraint system.

General installation instructions are provided in this manual.

(→P. 129)

#### Types of child restraints

Child restraint systems are classified into the following 3 types according to the age and size of the child.

- ▶ Rear facing—Infant seat/convertible seat

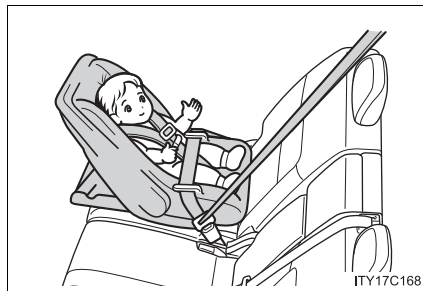

## 1-7. Safety information

### ► Forward facing—Convertible seat



### ► Booster seat

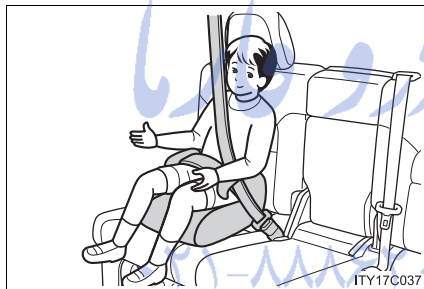

### ■ When installing the child restraint system on the front passenger seat

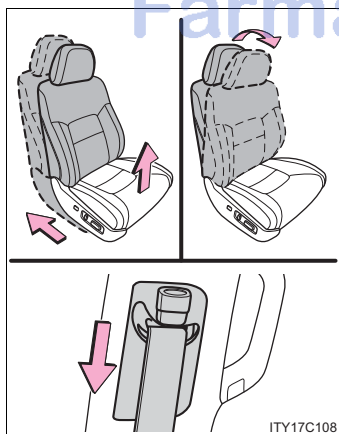

When you have to use a child restraint system on the front passenger seat, adjust the following:

- The seatback to the most upright position
- The seat cushion to the fully rearward and highest position
- The seat belt height to the lowest position

### ■ Selecting an appropriate child restraint system

- Use a child restraint system appropriate for the child until the child becomes large enough to properly wear the vehicle's seat belt.
- If a child is too large for a child restraint system, sit the child on a rear seat and use the vehicle's seat belt. (→P. 71)

1

### ⚠ CAUTION

#### ■ Using a child restraint system

The use of a child restraint system not suitable for the vehicle may not properly secure the infant or child, resulting in serious injury or even death.

#### ■ Child restraint precautions

- For effective protection in automobile accidents and sudden stops, a child must be properly restrained, using a seat belt or child restraint system depending on the age and size of the child. Holding a child in your arms is not a substitute for a child restraint system. In an accident, the child can be crushed against the windshield, or between you and the vehicle's interior.
- Toyota strongly urges the use of a proper child restraint system that conforms to the size of the child, installed on the rear seat. According to accident statistics, the child is safer when properly restrained in the rear seat than in the front seat.
- Never install a rear-facing child restraint system on the front passenger seat even if the AIR BAG OFF indicator light illuminates. In the event of an accident, the force of the rapid inflation of the front passenger airbag can cause death or serious injury to the child if the rear-facing child restraint system is installed on the front passenger seat.
- A forward-facing child restraint system may be installed on the front passenger seat only when it is unavoidable. A child restraint system that requires a top tether strap should not be used in the front passenger seat since there is no top tether strap anchor for the front passenger seat. Adjust the seatback as upright as possible and always move the seat as far back as possible even if the AIR BAG OFF indicator light illuminates, because the front passenger airbag could inflate with considerable speed and force. Otherwise, the child may be killed or seriously injured.

Before driving

 CAUTION

■ **Child restraint precautions**

- Do not use the seat belt extender when installing a child restraint system on the front or rear passenger seat. If installing a child restraint system with the seat belt extender connected to the seat belt, the seat belt will not securely hold the child restraint system, which could cause death or serious injury to the child or other passengers in the event of a sudden stop, sudden swerve or accident.
- Do not allow the child to lean his/her head or any part of his/her body against the door or the area of the seat, front, center and rear pillars or roof side rail from which the side airbags or curtain shield airbags deploy even if the child is seated in the child restraint system. It is dangerous if the side airbags and curtain shield airbags inflate, and the impact could cause death or serious injury to the child.
- Make sure you have complied with all installation instructions provided by the child restraint manufacturer and that the system is properly secured. If it is not secured properly, it may cause death or serious injury to the child in the event of a sudden stop, sudden swerve or accident.

■ **Child restraint lock function belt precaution**

Do not allow children to play with the child restraint lock function belt. If the belt becomes twisted around a child's neck, it will not be possible to pull the belt out leading to choking or other serious injuries that could result in death. If this occurs and the buckle cannot be unfastened, scissors should be used to cut the belt.

■ **When the child restraint system is not in use**

- Keep the child restraint system properly secured on the seat even if it is not in use. Do not store the restraint unsecured in the passenger compartment.
- If it is necessary to detach the child restraint system, remove it from the vehicle or store it securely in the luggage compartment. This will prevent it from injuring passengers in the event of a sudden stop, sudden swerve or accident.



## 1-7. Safety information Installing child restraints

**Follow the child restraint system manufacturer's instructions. Firmly secure the child restraints using the LATCH anchors or a seat belt. Attach the top tether strap when installing a child restraint.**

**The lap/shoulder belt can be used if your child restraint system is not compatible with the LATCH (Lower Anchors and Tethers for Children) system.**

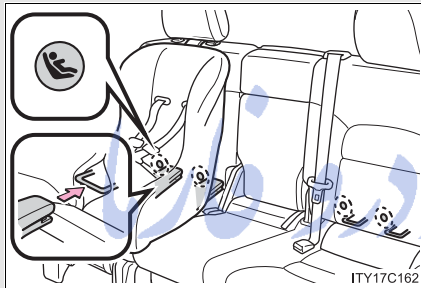

### Child restraint LATCH anchors

LATCH anchors are provided for the outside second seat. (Buttons displaying the location of the anchors are attached to the seats.)

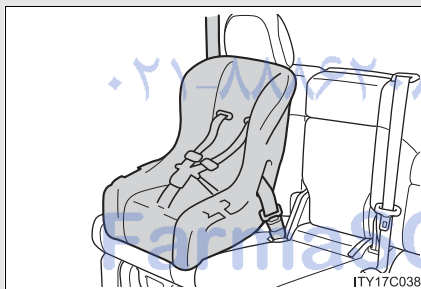

Seat belts equipped with a child restraint locking mechanism (ALR/ELR belts except driver's seat belt) (→P. 71)

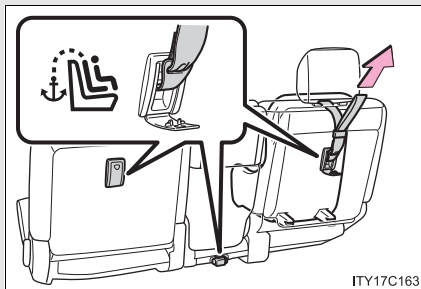

### Anchor bracket (for top tether strap)

Anchor brackets are provided for all second seats.

1

Before driving

## 1-7. Safety information

### Installation with LATCH system

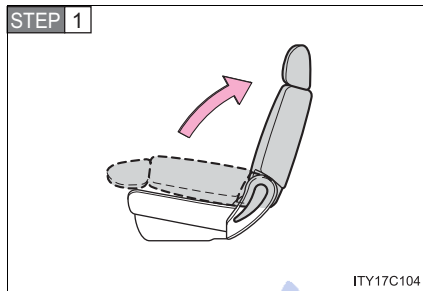

Fold the seatback forward and then adjust it as upright as possible.

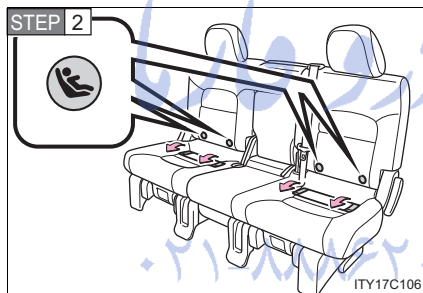

Take off the covers between the seat cushion and seatback, then confirm the position of the LATCH anchors below the symbol in the seatback.

FarmaSOS.com

► Type A

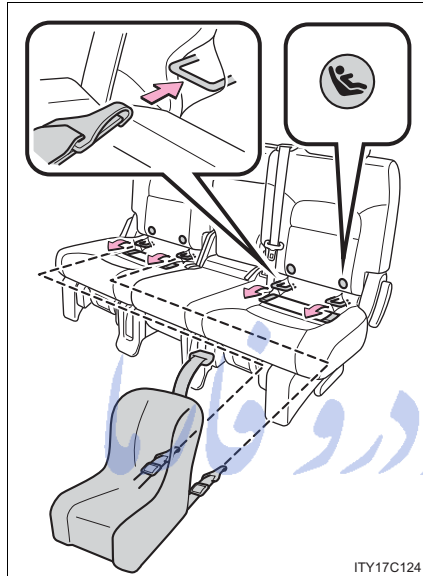

**STEP 3** Latch the hooks of the lower straps onto the LATCH anchors.

**STEP 4** If the child restraint has a top tether strap, the top tether strap should be latched onto the top tether strap anchor.

1  
Before driving

► Type B

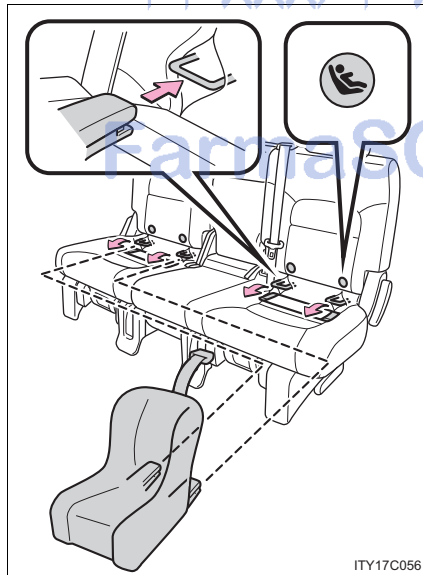

**STEP 3** Latch the buckles onto the LATCH anchors.

**STEP 4** If the child restraint has a top tether strap, the top tether strap should be latched onto the top tether strap anchor.

**Installing child restraints using a seat belt (child restraint lock function belt)**

■ **Rear-facing — Infant seat/convertible seat**

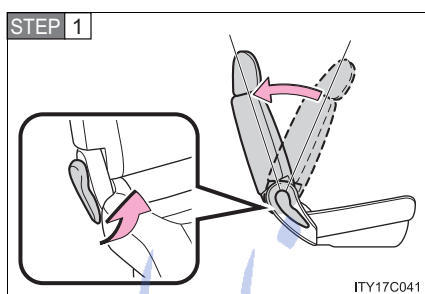

Fold the seatback while pulling the seatback angle lever. Return the seatback and secure it at the first lock position. (→P. 54)

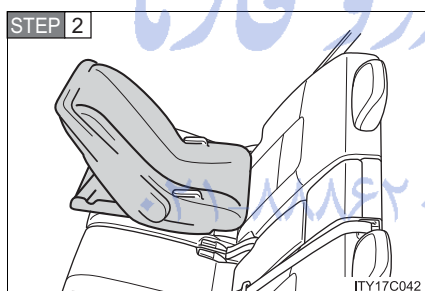

Place the child restraint system on the second or third seat facing the rear of the vehicle.

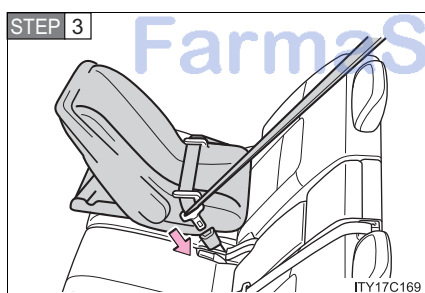

Run the seat belt through the child restraint system and insert the plate into the buckle. Make sure that the belt is not twisted.

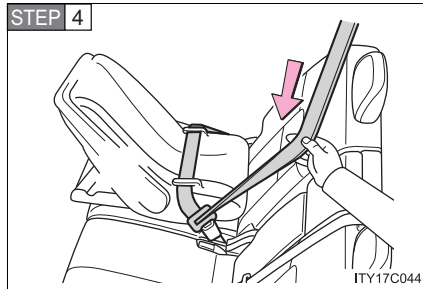

Fully extend the shoulder belt and then allow it to retract slightly in order to activate the ALR lock mode.

Lock mode allows the seat belt to retract only.

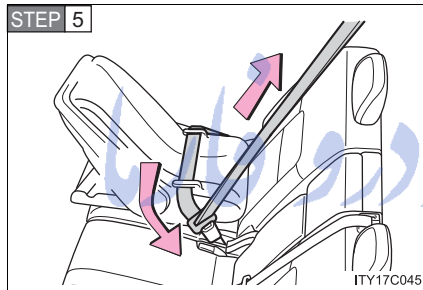

While pushing the child restraint system down into the seat, allow the shoulder belt to retract until the child restraint system is securely in place.

After the shoulder belt has retracted to a point where there is no slack in the belt, pull the belt to check that it cannot be extended.

1

Before driving

تلفن شبانه روزی: ۰۲۱-۸۸۶۲۰۸۵

FarmaSOS.com

■ **Forward-facing — Convertible seat**

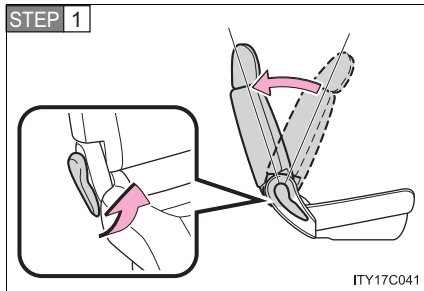

Fold the seatback while pulling the seatback angle lever. Return the seatback and secure it at the first lock position. (→P. 54)

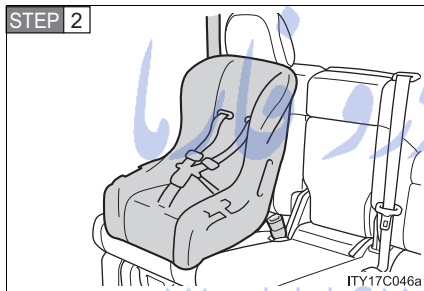

Place the child restraint system on the second or third seat facing the front of the vehicle.

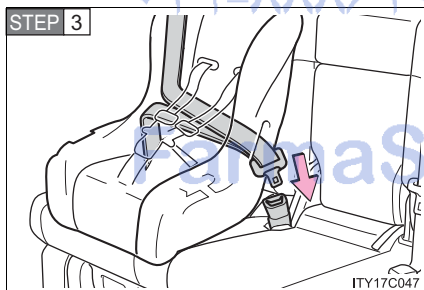

Run the seat belt through the child restraint system and insert the plate into the buckle. Make sure that the belt is not twisted.

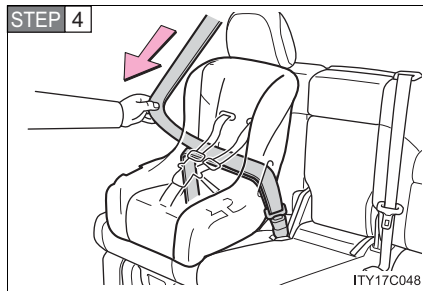

Fully extend the shoulder strap and then allow it to retract slightly into the ALR lock mode.

Lock mode allows the seat belt to retract only.

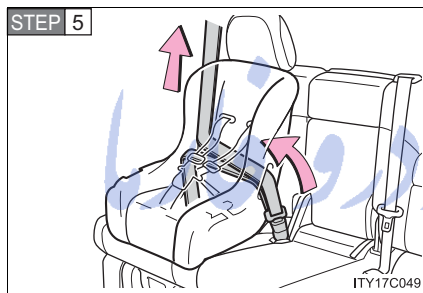

While pushing the child restraint system into the seat, allow the shoulder belt to retract until the child restraint system is securely in place.

After the shoulder belt has retracted to a point where there is no slack in the belt, pull the belt to check that it cannot be extended.

**STEP 6** If the child restraint system has a top tether strap, the top tether strap should be latched onto the top tether strap anchor. (→P. 130)

1

Before driving

FarmaSOS.com

■ **Booster seat**

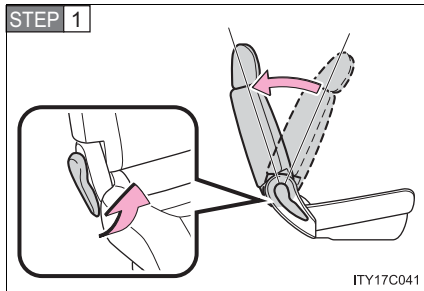

Fold the seatback while pulling the seatback angle lever. Return the seatback and secure it at the first lock position. (→P. 54)

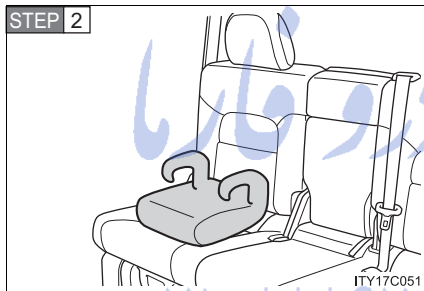

Place the child restraint system on the seat facing the front of the vehicle.

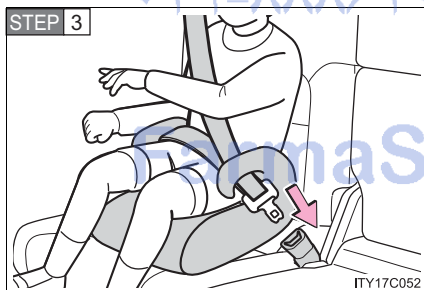

Sit the child in the child restraint system. Fit the seat belt to the child restraint system according to the manufacturer's instructions and insert the plate into the buckle. Make sure that the belt is not twisted.

Check that the shoulder belt is correctly positioned over the child's shoulder, and that the lap belt is as low as possible. (→P. 71)



### Removing a child restraint system installed with a seat belt

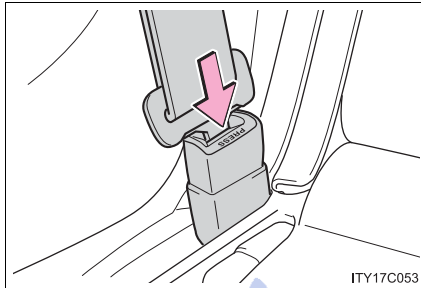

Press the buckle release button and fully retract the seat belt.

1

Before driving

### Child restraint systems with a top tether strap

**STEP 1** Secure the child restraint system using a seat belt or LATCH anchors, and do the following.

► Outside

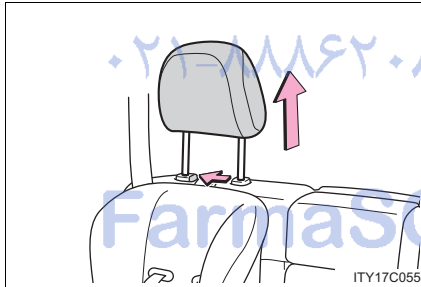

Adjust the head restraint to the upmost position.

► Center

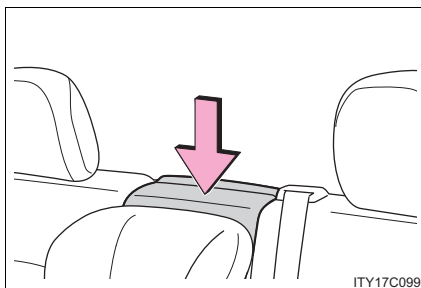

Lower the head restraint to the lowest position.

## 1-7. Safety information

**STEP 2** Open the anchor bracket cover, latch the hook onto the anchor bracket and tighten the top tether strap.

### ► Outside

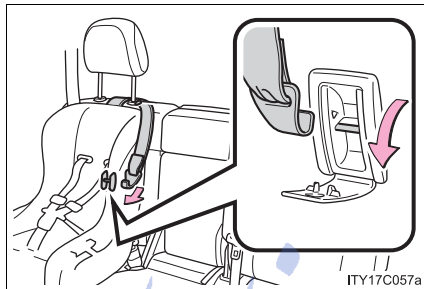

Make sure the top tether strap is securely latched.

### ► Center

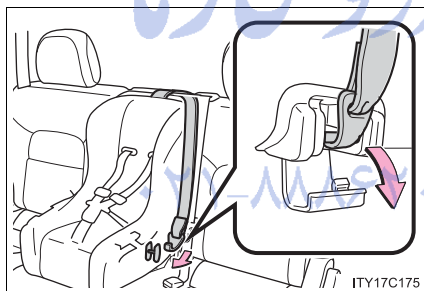

### **STEP 3**

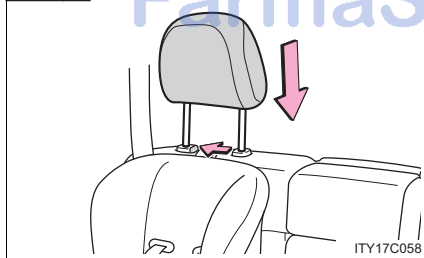

Outside only: Adjust the head restraint to the downmost position.

■ **Laws and regulations pertaining to anchorages**

The LATCH system conforms to FMVSS225.

Child restraint systems conforming to FMVSS213 specifications can be used.

This vehicle is designed to conform to the SAE J1819.

1

Before driving

**⚠ CAUTION**

■ **When installing a booster seat**

Do not fully extend the shoulder belt to prevent the belt from going to ALR lock mode: (→P. 74)

ALR mode causes the belt to tighten only which could cause injury or discomfort to the child.

تلفن شبانه روزی: ۰۲۱-۸۸۶۲۰۸۵

FarmaSOS.com

**! CAUTION**

**■ When installing a child restraint system**

Follow the directions given in the child restraint system installation manual and fix the child restraint system securely in place.

If the child restraint system is not correctly fixed in place, the child or other passengers may be seriously injured or even killed in the event of sudden braking, sudden swerving or an accident.

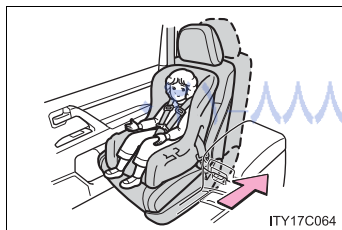
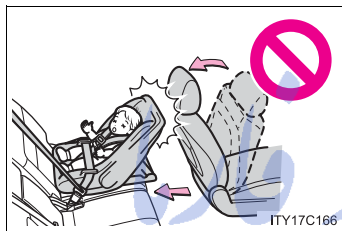

- If the driver's seat interferes with the child restraint system and prevents it from being attached correctly, attach the child restraint system to the right-hand rear seat.
- Child restraint system installed on the third seat should not contact the second seatbacks.
- Only put a forward facing or booster child seat on the front seat when unavoidable. When installing a forward facing or booster child restraint on the front passenger seat, move the seat as far back as possible even if the AIR BAG OFF indicator light illuminates. Failing to do so may result in death or serious injury if the airbags deploy (inflate).

- When using the LATCH anchors for a child restraint system, move the seat as far as possible and adjust the seatback as upright as possible, with the seatback close to the child restraint system.
- When a booster seat is installed, always ensure that the shoulder belt is positioned across the center of the child's shoulder. The belt should be kept away from the child's neck, but not so that it could fall off the child's shoulder. Failing to do so may result in death or serious injury in the event of sudden braking, sudden swerving or an accident.

**⚠ CAUTION****■ When installing a child restraint system**

- Ensure that the belt and tab are securely locked and the seat belt is not twisted.
- Push and pull the child restraint system from side to side and forward to be sure it is secure.
- After securing a child restraint system, never adjust the seat.
- Follow all installation instructions provided by the child restraint system manufacturer.

**■ Do not use a seat belt extender**

If a seat belt extender is used when installing a child restraint system, the seat belt will not securely hold the child restraint system, which could cause death or serious injury to the child or other passengers in the event of a sudden stop, sudden swerve or accident.

**■ To correctly attach a child restraint system to the anchors**

When using the LATCH anchors, be sure that there are no foreign objects around the anchors and that the seat belt is not caught behind the child restraint system. Make sure the child restraint system is securely attached, or it may cause death or serious injury to the child or other passengers in the event of a sudden stop, sudden swerve or accident.

1

Before driving

FarmaSOS.com

امداد خودرو فارما

تلفن شبانه روزی: ۰۲۱-۸۸۸۶۲۰۸۵

**FarmaSOS.com**

**2-1. Driving procedures**

Driving the vehicle..... 144  
 Engine (ignition) switch .... 154  
 Automatic transmission.... 158  
 Turn signal lever ..... 163  
 Parking brake..... 164  
 Horn ..... 165

**2-2. Instrument cluster**

Gauges and meters ..... 166  
 Indicators and warning lights..... 169  
 Multi-information display..... 172

**2-3. Operating the lights and wipers**

Headlight switch..... 175  
 Fog light switch ..... 178  
 Windshield wipers and washer ..... 179  
 Rear window wiper and washer ..... 184  
 Headlight cleaner switch ..... 185

**2-4. Using other driving systems**

Cruise control..... 186  
 Intuitive parking assist..... 190  
 Four-wheel drive system ..... 199  
 Crawl Control ..... 204  
 Driving assist systems .... 208  
 Pre-Collision System..... 214

**2-5. Driving information**

Off-road precautions ..... 215  
 Cargo and luggage ..... 220  
 Vehicle load limits ..... 227  
 Winter driving tips ..... 228  
 Trailer towing ..... 233  
 Dinghy towing ..... 245

## 2-1. Driving procedures

### Driving the vehicle

The following procedures should be observed to ensure safe driving.

#### ■ Starting the engine (→P. 154)

#### ■ Driving

**STEP 1** With the brake pedal depressed, shift the shift lever to “D”.  
(→P. 158)

**STEP 2** Release the parking brake.  
(→P. 164)

**STEP 3** Gradually release the brake pedal and gently push the accelerator pedal to accelerate the vehicle.

#### ■ Stopping

**STEP 1** With the shift lever in “D”, push the brake pedal.

**STEP 2** If necessary, set the parking brake.

When the vehicle is stopped for an extended period of time, shift the shift lever to “P” or “N”.  
(→P. 158)

#### ■ Parking the vehicle

**STEP 1** With the shift lever in “D”, push the brake pedal.

**STEP 2** Set the parking brake.  
(→P. 164)

**STEP 3** Shift the shift lever to “P”.  
(→P. 158)

**STEP 4** Press the “ENGINE START STOP” switch and stop the engine.

**STEP 5** Lock the door, making sure that you have the key on your person.

### Starting on a steep incline

**STEP 1** Firmly set the parking brake and shift the shift lever to “D”.

**STEP 2** Gently depress the accelerator pedal.

**STEP 3** Release the parking brake.



### ■ Driving in the rain

- Drive carefully when it is raining, because visibility will be reduced, the windows may become fogged-up, and the road will be slippery.
- Drive carefully when it starts to rain, because the road surface will be especially slippery.
- Refrain from high speeds when driving on an expressway in the rain, because there may be a layer of water between the tires and the road surface, preventing the steering and brakes from operating properly.

### ■ Breaking in your new Toyota

To extend the life of the vehicle, the following precautions are recommended to observe:

- For the first 200 miles (300 km):  
Avoid sudden stops.
- For the first 500 miles (800 km):  
Do not tow a trailer.
- For the first 1000 miles (1600 km):
  - Do not drive at extremely high speeds.
  - Avoid sudden acceleration.
  - Do not drive continuously in the low gears.
  - Do not drive at a constant speed for extended periods.

### ■ Drum-in-disc type parking brake system

Your vehicle has a drum-in-disc type parking brake system. This type of brake system needs bedding-down of the brake shoes periodically or whenever the parking brake shoes and/or drums are replaced. Have your Toyota dealer perform the bedding-down.

### ■ Operating your vehicle in a foreign country

Comply with the relevant vehicle registration laws and confirm the availability of the correct fuel. (→P. 550)

 CAUTION

■ **When starting the vehicle**

Always keep your foot on the brake pedal while stopped with the engine running. This prevents the vehicle from creeping.

■ **When driving the vehicle**

- Do not drive if you are unfamiliar with the location of the brake and accelerator pedals to avoid depressing the wrong pedal.
  - Accidentally depressing the accelerator pedal instead of the brake pedal will result in sudden acceleration that may lead to an accident that could result in death or serious injury.
  - When backing up, you may twist your body around, leading to a difficulty in operating the pedals. Make sure to operate the pedals properly.
  - Make sure to keep a correct driving posture even when moving the vehicle only slightly, allowing you to depress the brake and accelerator pedals properly.
  - Depress the brake pedal using your right foot. Depressing the brake pedal using your left foot may delay response in an emergency, resulting in an accident.
- Do not drive the vehicle over or stop the vehicle near flammable materials. The exhaust system and exhaust gases can be extremely hot. This may cause a fire if there is any flammable material nearby.
- Do not let the vehicle roll backwards while the shift lever is in a driving position, or roll forward while the shift lever is in "R". Doing so may cause the engine to stall and lead to poor steering performance, resulting in an accident or damage to the vehicle.
- If the smell of exhaust is noticed inside the vehicle, open the windows and check that the back door is closed. Large amounts of exhaust in the vehicle can cause driver drowsiness and an accident, resulting in death or a serious health hazard. Have the vehicle inspected by your Toyota dealer immediately.

**⚠ CAUTION**

- Do not under any circumstances shift the shift lever to “P” or “R” while the vehicle is moving.  
Doing so can cause significant damage to the transmission and may result in a loss of vehicle control.
- Do not shift the shift lever to “N” while the vehicle is moving.  
Doing so may cause the engine brake not to operate properly and lead to an accident.
- Do not turn the engine off while driving.  
The power steering and brake actuator will not operate properly if the engine is not running.
- Use engine braking (downshift) to maintain a safe speed when driving down a steep hill.  
Using the brakes continuously may cause the brakes to overheat and lose effectiveness. (→P. 158)
- When stopped on an inclined surface, use the brake pedal and parking brake to prevent the vehicle from rolling backward or forward and causing an accident.
- Do not adjust the position of the steering wheel, the seat, or the inside or outside rear view mirrors while driving.  
Doing so may result in a loss of vehicle control that can cause accidents that may result in death or serious injury.
- Always check that all passengers' arms, heads or other parts of their bodies are not outside the vehicle, as this may result in death or serious injury.
- Do not drive in excess of the speed limit. Even if the legal speed limit permits it, do not drive over 85 mph (140 km/h) unless your vehicle has high-speed capability tires. Driving over 85 mph (140 km/h) may result in tire failure, loss of control and possible injury. Be sure to consult a tire dealer to determine whether the tires on your vehicle are high-speed capability tires or not before driving at such speeds.

 CAUTION

■ **When driving on slippery road surfaces**

- Sudden braking, acceleration and steering may cause tire slippage and reduce your ability to control the vehicle, resulting in an accident.
- Sudden changes in engine speed, such as engine braking caused by up-shifting or down-shifting, may cause the vehicle to skid, resulting in an accident.
- After driving through a puddle, lightly depress the brake pedal to make sure that the brakes are functioning properly. Wet brake pads may prevent the brakes from functioning properly. If the brakes on only one side are wet and not functioning properly, steering control may be affected, resulting in an accident.

■ **When shifting the shift lever**

Be careful not to shift the shift lever with the accelerator pedal depressed. This may lead to unexpected rapid acceleration of the vehicle that may cause an accident and result in death or serious injury.

■ **When the vehicle is stopped**

- Do not race the engine.  
If the vehicle is in any gear other than "P" or "N", the vehicle may accelerate suddenly and unexpectedly, and may cause an accident.
- Do not leave the vehicle with the engine running for a long time.  
If such a situation cannot be avoided, park the vehicle in an open space and check that exhaust fumes do not enter the vehicle interior.
- In order to prevent accidents due to the vehicle rolling away, always keep depressing the brake pedal while the engine is running, and apply the parking brake as necessary.
- If the vehicle is stopped on an incline, in order to prevent accidents caused by the vehicle rolling forward or backward, always depress the brake pedal and securely apply the parking brake as needed.
- Avoid revving or racing the engine.  
Running the engine at high speed while the vehicle is stopped may cause the exhaust system to overheat, which could result in a fire if combustible material is nearby.

**⚠ CAUTION****■ When the vehicle is parked**

- Do not leave glasses, cigarette lighters, spray cans, or soft drink cans in the vehicle when it is in the sun.  
Failure to do so may result in the following:
  - Gas may leak from a cigarette lighter or spray can, and may lead to a fire.
  - The temperature inside the vehicle may cause the plastic lenses and plastic material of eye glasses to deform or crack.
  - Soft drink cans may fracture, causing the contents to spray over the interior of the vehicle, and may also cause a short circuit in the vehicle's electrical components.
- Always apply the parking brake, shift the shift lever to "P", stop the engine and lock the vehicle.  
Do not leave the vehicle unattended while the engine is running.
- If the shift lever is moved before the low speed four-wheel drive indicator turns on/off, the transfer mode may not be shifted completely. The transfer mode disengages both the front and rear driveshafts from the powertrain and allows the vehicle to move regardless of the shift position. (At this time, the indicator blinks and the buzzer sounds.)  
Therefore, the vehicle is free to roll even if the automatic transmission is in "P". You or someone else could be seriously injured. You must complete the shifting of the transfer mode. (→P. 199)
- Do not touch the exhaust pipe while the engine is running or immediately after turning the engine off.  
Doing so may cause burns.
- Do not leave the engine running in an area with snow build-up, or where it is snowing. If snowbanks build up around the vehicle while the engine is running, exhaust gases may collect and enter the vehicle. This may lead to death or a serious health hazard.

 CAUTION

■ **Exhaust gases**

Exhaust gases include harmful carbon monoxide (CO) that is colorless and odorless. Inhaling exhaust gases may lead to death or a serious health hazard.

- If the vehicle is in a poorly ventilated area, stop the engine. In a closed area, such as a garage, exhaust gases may collect and enter the vehicle. This may lead to death or a serious health hazard.
- The exhaust should be checked occasionally. If there is a hole or crack caused by corrosion, damage to a joint or abnormal exhaust noise, be sure to have the vehicle inspected and repaired by your Toyota dealer. Failure to do so may allow exhaust gases to enter the vehicle, resulting in death or a serious health hazard.

■ **When taking a nap in the vehicle**

Always turn the engine off. Otherwise, you may accidentally move the shift lever or depress the accelerator pedal, which could cause an accident or fire due to engine overheating. Additionally, if the vehicle is parked in a poorly ventilated area, exhaust gases may collect and enter the vehicle, leading to death or a serious health hazard.

FarmaSOS.com

**⚠ CAUTION****■ When braking the vehicle**

- When the brakes are wet, drive more cautiously.  
Braking distance increases when the brakes are wet, and may cause one side of the vehicle to brake differently than the other side. Also the parking brake may not securely hold the vehicle.
- If the power brake assist function does not operate, do not follow other vehicles closely and avoid downhill or sharp turns that require braking.  
In this case, braking is still possible, but it will require more force on the pedal than usual. Braking distance may also increase.
- Do not pump the brake pedal if the engine stalls.  
Each push on the brake pedal uses up the reserve for the power-assisted brakes.
- The brake system consists of 2 individual hydraulic systems: if one of the systems fails, the other will still operate. In this case, the brake pedal should be depressed more firmly than usual and braking distance becomes longer.  
Do not drive your vehicle with only a single brake system. Have your brakes fixed immediately.

2

When driving

FarmaSOS.com

 NOTICE

■ **While driving the vehicle**

- Do not depress the accelerator and brake pedals at the same time during driving. If the brake pedal is depressed while driving with the accelerator pedal depressed, driving torque may be restrained.
- Do not use the accelerator pedal or depress accelerator and brake pedals together to hold the vehicle on a hill.

■ **When parking the vehicle**

Always put the shift lever in "P". Failure to do so may cause the vehicle to move or the vehicle may accelerate suddenly if the accelerator pedal is accidentally depressed.

■ **Avoiding damage to vehicle parts**

- Do not turn the steering wheel fully in either direction and hold it there for a long time.  
Doing so may damage the power steering pump.
- When driving over bumps in the road, drive as slowly as possible to avoid damaging the wheels, underside of the vehicle, etc.

■ **If you hear a squealing or scraping noise (brake pad wear limit indicators)**

Have your Toyota dealer check and replace the brake pads as soon as possible.

The rotor damage can result if the pads are not replaced when needed.

It is dangerous to drive the vehicle when the wear limits of the brake pads and/or that of the brake discs are exceeded.



 NOTICE

■ **If you get a flat tire while driving**

A flat or damaged tire may cause the following situations. Hold the steering wheel firmly and gradually press the brake pedal to slow down the vehicle.

- It may be difficult to control your vehicle.
- The vehicle will make abnormal sounds.
- The vehicle will behave abnormally.

Replace a flat tire with a new one. (→P. 516)

■ **When encountering flooded roads**

Do not drive on a road that has flooded after heavy rain etc. Doing so may cause the following serious damage to the vehicle.

- Engine stalling
- Short in electrical components
- Engine damage caused by water immersion

In the event that you drive on a flooded road and the vehicle is flooded, be sure to have your Toyota dealer check the following.

- Brake function
- Changes in quantity and quality of oil and fluid used for the engine, transmission, transfer, differentials, etc.
- Lubricant condition for the propeller shaft, bearings and suspension joints (where possible) and the function of all joints, bearings, etc.

## 2-1. Driving procedures Engine (ignition) switch

Performing the following operations when carrying the electronic key on your person starts the engine or changes “ENGINE START STOP” switch modes.

### ■ Starting the engine

**STEP 1** Check that the parking brake is set.

**STEP 2** Check that the shift lever is set in “P”.

**STEP 3** Sit in the driver’s seat and firmly depress the brake pedal.

The “ENGINE START STOP” switch indicator turns green.

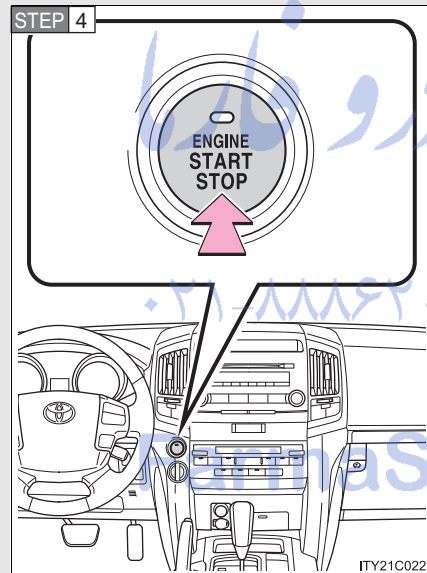

Press the “ENGINE START STOP” switch.

The engine can be started from any mode.

Continue depressing the brake pedal until the engine is completely started. The engine will crank until it starts or for up to 30 seconds, whichever is less.

### ■ Changing “ENGINE START STOP” switch mode

Modes can be changed by pressing the “ENGINE START STOP” switch with the brake pedal released. (The mode changes each time the switch is pressed.)

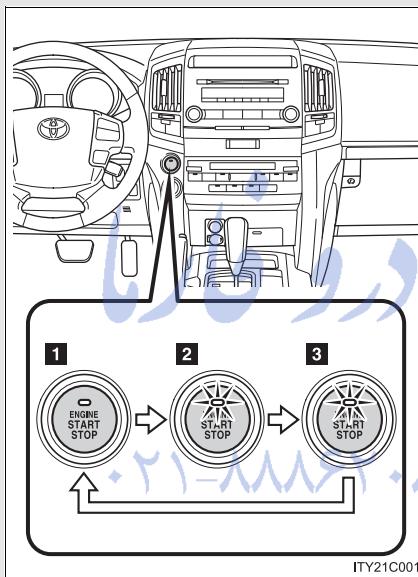

#### 1 OFF\*

Emergency flashers can be used.

#### 2 ACCESSORY mode

Some electrical components such as the audio system can be used.

The “ENGINE START STOP” switch indicator turns amber.

#### 3 IGNITION ON mode

All electrical components can be used.

The “ENGINE START STOP” switch indicator turns amber.

\*: If the shift lever is in a position other than “P” when turning off the engine, the “ENGINE START STOP” switch will be turned to ACCESSORY mode, not to OFF.

■ **When the steering lock cannot be released**

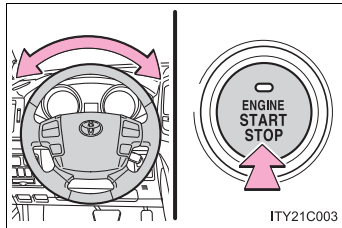

The green indicator light on the “ENGINE START STOP” switch will flash and a message will be shown on the multi-information display. Press the “ENGINE START STOP” switch again while turning the steering wheel left and right.

■ **If the engine does not start**

The engine immobilizer system may not have been deactivated. (→P. 96)

■ **When the “ENGINE START STOP” switch indicator flashes in amber**

The system may be malfunctioning. Have the vehicle inspected by your Toyota dealer immediately.

■ **Auto power off function**

If the vehicle is left in ACCESSORY mode for more than an hour with the shift lever in “P”, the “ENGINE START STOP” switch will automatically turn off.

■ **Electronic key battery depletion**

→P. 32

■ **When the electronic key battery is discharged**

→P. 535

■ **Conditions affecting operation**

→P. 30

■ **Note for the smart key system**

→P. 33

**⚠ CAUTION****■ When starting the engine**

Always start the engine while sitting in the driver's seat. Do not depress the accelerator pedal while starting the engine under any circumstances. Doing so may cause an accident resulting in death or serious injury.

**■ Stopping the engine in an emergency**

If you want to stop the engine in an emergency while driving the vehicle, push and hold the "ENGINE START STOP" switch for more than 3 seconds. However, do not touch the "ENGINE START STOP" switch while driving except in an emergency. If the engine stops while the vehicle is being driven, this could lead to an unexpected accident.

**⚠ NOTICE****■ To prevent battery discharge**

Do not leave the "ENGINE START STOP" switch in ACCESSORY or IGNITION ON mode for long periods without the engine running.

**■ When starting the engine**

- Do not race a cold engine.
- If the engine becomes difficult to start or stalls frequently, have the engine checked immediately.

2

When driving

## 2-1. Driving procedures Automatic transmission

Select a shift position appropriate for the driving conditions.

### ■ Shifting the shift lever

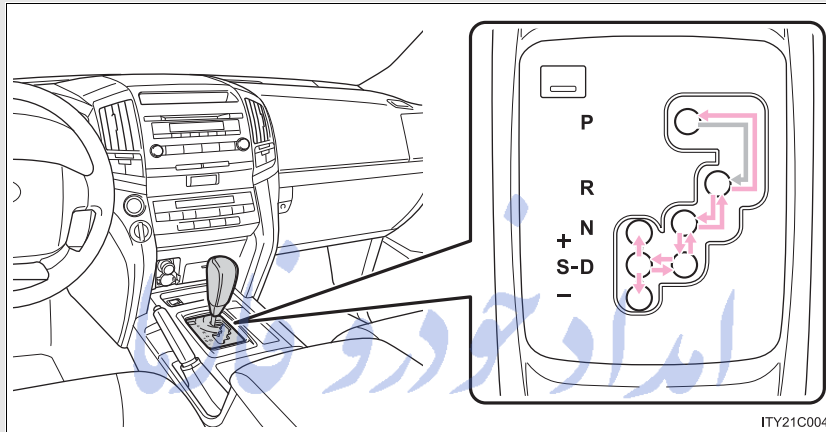

← While the “ENGINE START STOP” switch is in IGNITION ON mode, depress the brake pedal and move the shift lever.

### ■ Shift position uses

Shift position	Function
P	Parking the vehicle or starting the engine
R	Reversing
N	Neutral
D	Normal driving*1
S	“S” mode driving*2

\*1: To improve fuel consumption and reduce noises, set the shift lever in the “D” position for normal driving.

\*2: By selecting shift ranges using “S” mode, you can control engine braking forces.

■ **Selecting a driving mode**

The following patterns can be selected to suit current driving and operating conditions.

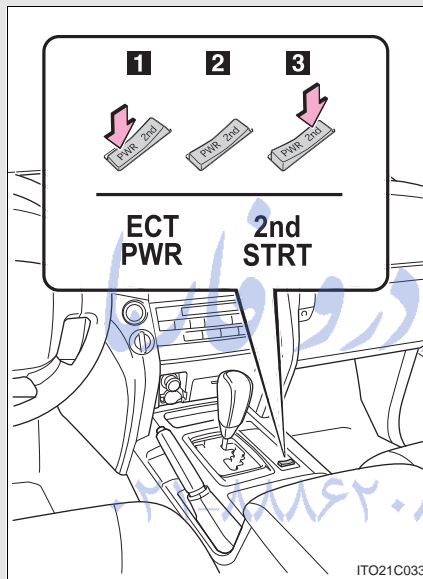

**1** Power mode

For powerful acceleration and driving in mountainous regions.

**2** Normal mode

**3** Second start mode

For starting on slippery road surfaces, such as on snow.

Press “2nd” to return to normal mode.

### Changing shift ranges in "S" mode

Shift the shift lever to the "S" position and operate the shift lever.

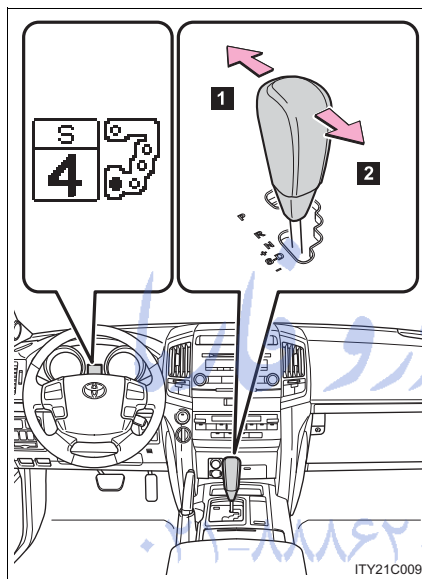

- 1 Upshifting
- 2 Downshifting

The initial shift range in "S" mode is automatically set to "5" or "4" according to the vehicle's speed. However, the initial shift range may be set to "3" or "2" if the AI-SHIFT has operated while the shift lever was in the "D" position. (→P. 162)



### ■ Shift ranges and their functions

Shift range	Function
6	Automatically selecting gears between 1 and 6 according to vehicle speed and driving conditions.
5	Automatically selecting gears between 1 and 5 according to vehicle speed and driving conditions.
4	Automatically selecting gears between 1 and 4 according to vehicle speed and driving conditions.
3	Automatically selecting gears between 1 and 3 according to vehicle speed and driving conditions.
2	Automatically selecting gears between 1 and 2 according to vehicle speed and driving conditions.
1	Setting the gear at 1.

2

When driving

A lower shift range will provide greater engine braking force than a higher shift range, and the engine revolutions will also increase.

تلفن شبانه روزی: ۰۲۱-۸۸۶۲۰۸۵

FarmaSOS.com

■ **“S” mode**

When the shift range is “5” or lower, holding the shift lever toward “+” sets the shift range to “6”.

■ **Downshifting restrictions warning buzzer (in the “S” mode)**

To help ensure safety and driving performance, downshifting operation may sometimes be restricted. In some circumstances, downshifting may not be possible even when the shift lever is operated. (The warning buzzer will sound twice.)

■ **When driving with the cruise control system**

The engine brake will not operate in the “S” mode, even when downshifting to “5” or “4”. (→P. 186)

■ **Second start mode automatic deactivation**

Second start mode is automatically deactivated if the engine is turned off after driving in second start mode.

■ **If the shift lever cannot be shifted from “P”**

→P. 532

■ **If the “S” indicator does not come on even after shifting the shift lever to “S”**

This may indicate a malfunction in the automatic transmission system. Have the vehicle inspected by your Toyota dealer immediately.  
(In this situation, the vehicle will operate as if the shift lever is in “D”.)

■ **AI-SHIFT**

The AI-SHIFT automatically shifts the gear to the optimal position according to the driver performance and driving conditions.

The AI-SHIFT automatically operates when the shift lever is in the “D” position. (Shifting the shift lever to the “S” position cancels the function.)

## 2-1. Driving procedures

### Turn signal lever

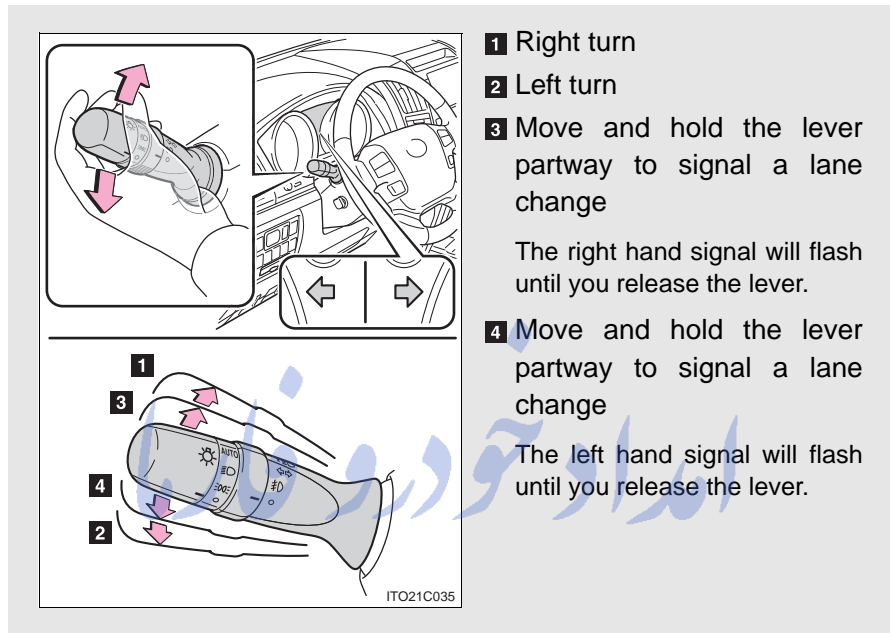

2

When driving

#### ■ Turn signals can be operated when

The "ENGINE START STOP" switch is in IGNITION ON mode.

#### ■ If the indicators flash faster than usual

Check that a light bulb in the front or rear turn signal lights has not burned out.

## 2-1. Driving procedures Parking brake



### 1 Sets the parking brake

Fully set the parking brake while depressing the brake pedal.

### 2 Releases the parking brake

Slightly raise the lever and lower it completely while pressing the button.

تلفن شیشه روزی: ۰۲۱-۸۸۶۲۰۸۵

### ■ Usage in winter time

See "Winter driving tips" for parking brake usage in winter time. (→P. 228)

### ⚠ NOTICE

#### ■ Before driving

Fully release the parking brake.

Driving the vehicle with the parking brake set will lead to brake components overheating, which may affect braking performance and increase brake wear.

## 2-1. Driving procedures

### Horn

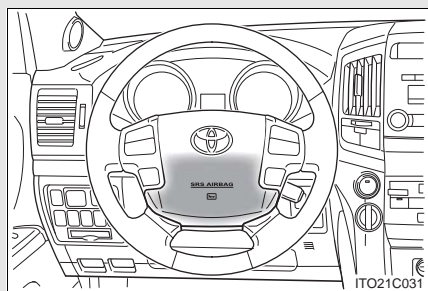

To sound the horn, press on or close to the  mark.

2

When driving

امداد خودرو فارما

تلفن شبانه روزی: ۰۲۱-۸۸۸۶۲۰۸۵

FarmaSOS.com

## 2-2. Instrument cluster Gauges and meters

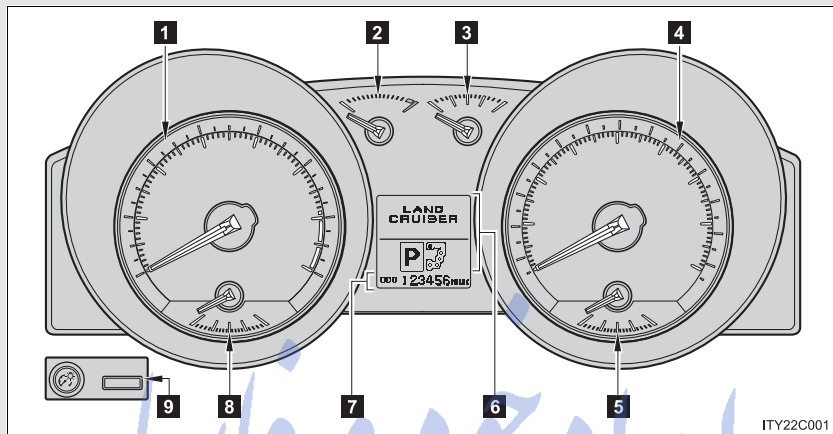

The following gauges, meters and display illuminate when the “ENGINE START STOP” switch is in IGNITION ON mode.

- 1** Tachometer  
Displays the engine speed in revolutions per minute.
- 2** Engine coolant temperature gauge  
Displays the engine coolant temperature.
- 3** Fuel gauge  
Displays the quantity of fuel remaining in the tank.
- 4** Speedometer  
Displays the vehicle speed.
- 5** Voltmeter  
Displays the charge state.
- 6** Multi-information display  
→P. 172

**7 Odometer and trip meter**

Odometer: Displays the total distance the vehicle has been driven.

Trip meter: Displays the distance the vehicle has been driven since the meter was last reset. Trip meters A and B can be used to record and display different distances independently.

**8 Engine oil pressure gauge**

Displays the engine oil pressure.

**9 Odometer/trip meter and trip meter reset button**

Switches between odometer and trip meter displays. Pushing and holding the button will reset the trip meter when the trip meter is being displayed.

2

When driving

**Instrument panel light control**

The brightness of the instrument panel lights can be adjusted.

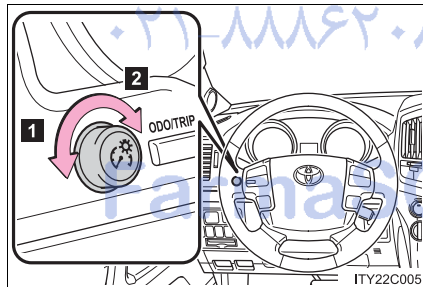

- 1** Darker
- 2** Brighter

## 2-2. Instrument cluster

### NOTICE

#### ■ To prevent damage to the engine and its components

- Do not let the indicator needle of the tachometer enter the red zone, which indicates the maximum engine speed.
- The engine may be overheating if the engine coolant temperature gauge is in the red zone ("H"). In this case, immediately stop the vehicle in a safe place, and check the engine after it has cooled completely. (→P. 541)

#### ■ While driving

- When the voltmeter indicates more than 19 V or less than 9 V, the battery may be malfunctioning. Have your vehicle checked at your Toyota dealer.
- When the engine oil pressure gauge does not work properly, immediately stop the engine and contact your Toyota dealer.

تلفن شبانه روزی: ۰۲۱-۸۸۸۶۲۰۸۵

FarmaSOS.com



## 2-2. Instrument cluster Indicators and warning lights

The indicator and warning lights on the instrument cluster and center panel inform the driver of the status of the vehicle's various systems.

### ► Instrument cluster

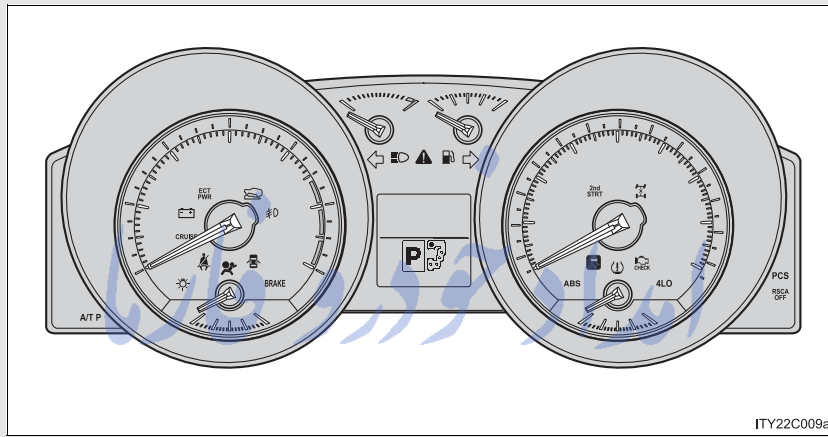

ITY22C009a

### ► Center panel (vehicles with navigation system)

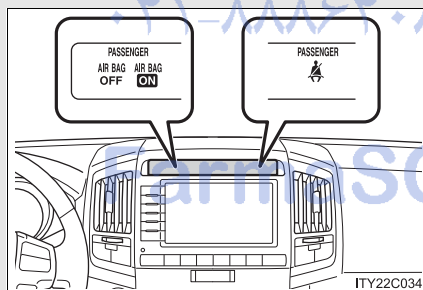

ITY22C034

### ► Center panel (vehicles without navigation system)

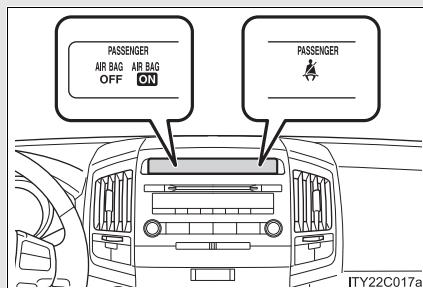

ITY22C017a













2

When driving

## 2-2. Instrument cluster

### ■ Indicators

The indicators inform the driver of the operating state of the vehicle's various systems.

	Turn signal indicator (→P. 163)		*1 Roll sensing of curtain shield airbags off indicator (→P. 118)
	Headlight high beam indicator (→P. 176)		"PWR" mode indicator (→P. 159)
	Headlight indicator (→P. 175)		Automatic transmission second start indicator (→P. 159)
	Fog light indicator (→P. 178)		Low speed four-wheel drive indicator light (→P. 199)
	Cruise control indicator (→P. 186)		Center differential lock indicator (→P. 210)
	*1 Slip indicator (→P. 209)		*1 "AIR BAG ON/OFF" indicator (→P. 119)
	*1 Crawl Control indicator (→P. 204)		

FarmaSOS.com

### ■ Warning lights

Warning lights inform the driver of malfunctions in the indicated vehicle's systems. (→P. 502)

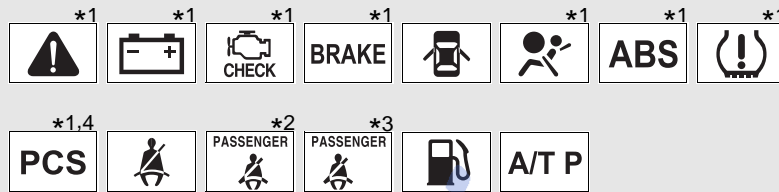

\*1: These lights turn on when the "ENGINE START STOP" switch is turned to IGNITION ON mode to indicate that a system check is being performed. They will turn off after the engine is started, or after a few seconds. There may be a malfunction in a system if the lights do not come on, or if the lights do not turn off. Have the vehicle inspected by your Toyota dealer.

\*2: Vehicles with navigation system

\*3: Vehicles without navigation system

\*4: If equipped

### ⚠ CAUTION

#### ■ If a safety system warning light does not come on

Should a safety system light such as Multi Terrain ABS and the SRS airbag warning lights not come on when you start the engine, this could mean that these systems are not available to help protect you in an accident, which could result in death or serious injury. Have the vehicle inspected by your Toyota dealer immediately if this occurs.

## 2-2. Instrument cluster Multi-information display

The Multi-information display presents the driver with a variety of driving-related data.

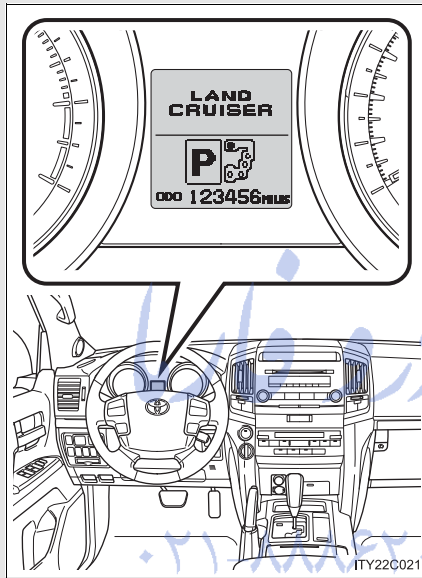

- Trip information (→P. 173)  
Displays driving range, fuel consumption and other cruising-related information.
- Intuitive parking assist display (→P. 190)  
Automatically displayed when using intuitive parking assist.
- Crawl Control display (→P. 204)  
Automatically displayed when using Crawl Control.
- Shift position and shift range (→P. 158)
- Warning messages (→P. 513)  
Automatically displayed when a malfunction occurs in one of the vehicle's system.

### Switch the display

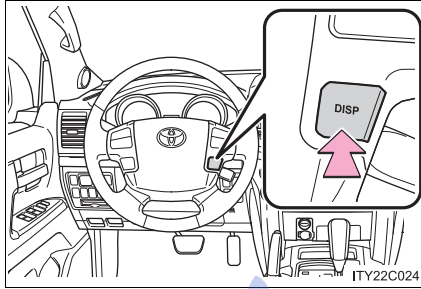

Display items can be switched by pressing the “DISP” button.

### Trip information

#### ■ Current fuel consumption

Displays the current rate of fuel consumption.

#### ■ Average fuel consumption

Displays the average fuel consumption since the vehicle was last refueled.

#### ■ Driving range

Displays the estimated maximum distance that can be driven with the quantity of fuel remaining.

- This distance is computed based on your average fuel consumption. As a result, the actual distance that can be driven may differ from that displayed.
- When only a small amount of fuel is added to the tank, the display may not be updated.

## 2-2. Instrument cluster

### ■ Average vehicle speed

Displays the average vehicle speed since the engine was started.

### ■ Driving distance

Displays the driving distance since the engine was started.

### ■ Tire inflation pressure

Displays inflation pressure of each tire. There is no correlation between the order of the displayed values and the tire positions.

It may take a few minutes to display the tire inflation pressure after the "ENGINE START STOP" switch is turned to IGNITION ON mode. It may also take a few minutes to display the tire inflation pressure after inflation pressure has been adjusted.

---

### ■ System check display

After switching the "ENGINE START STOP" switch to IGNITION ON mode, "LAND CRUISER" is displayed while system operation is checked. When the system check is complete, the normal screen will return.

### ■ Tire inflation pressure

Tire inflation pressure changes with temperature. The displayed values may also be different from the values measured using other gauges.

### ■ Liquid crystal display

Small spots or light spots may appear on the display. This phenomenon is characteristic of liquid crystal displays, and there is no problem to continue using the display.

### NOTICE

#### ■ The multi-information display at low temperatures

Allow the interior of the vehicle to warm up before using the liquid crystal information display. At extremely low temperatures, the information display monitor may respond slowly, and display changes may be delayed.

## 2-3. Operating the lights and wipers Headlight switch

The headlights can be operated manually or automatically.

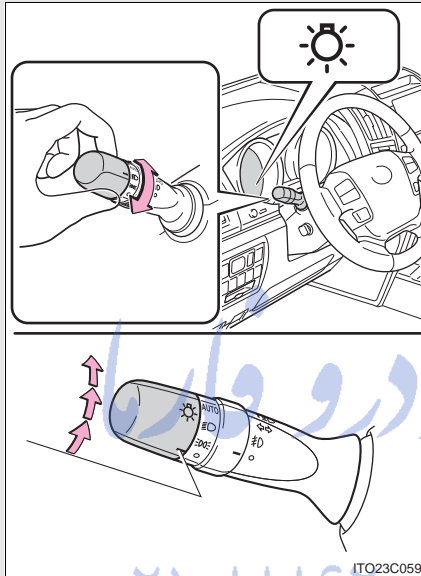

 The side marker, parking, tail, license plate, daytime running lights and instrument panel lights turn on.

 The headlights and all lights listed above (except daytime running lights) turn on.

**AUTO** The headlights, daytime running lights and all lights listed above turn on and off automatically.

(When the “ENGINE START STOP” switch is in IGNITION ON mode.)

 The daytime running lights turn on.

2

When driving

### Turning on the high beam headlights

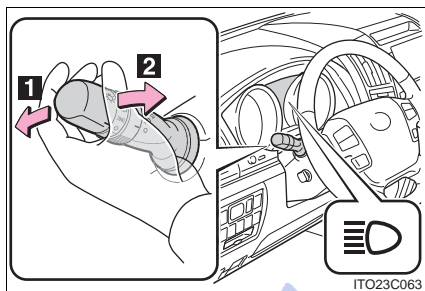

**1** With the headlights on, push the lever forward to turn on the high beams.

Pull the lever back to the center position to turn the high beams off.

**2** Pull the lever toward you to turn on the high beams.

Release the lever to turn them off. You can flash the high beams with the headlights on or off.

### Daytime running light system

- To make your vehicle more visible to other drivers, the headlights turn on automatically (at a reduced intensity) whenever the engine is started and the parking brake is released. Daytime running lights are not designed for use at night.
- Compared to turning on the headlights, the daytime running light system offers greater durability and consumes less electricity, so it can help improve fuel economy.

### Headlight control sensor

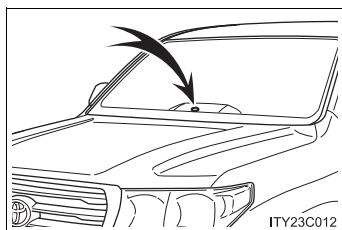



The sensor may not function properly if an object is placed on the sensor, or anything that blocks the sensor is affixed to the windshield.

Doing so interferes with the sensor detecting the level of ambient light and may cause the automatic headlight system to malfunction.



■ **Automatic light off system**

- When the headlights are on: The headlights and tail lights turn off 30 seconds after a door is opened and closed if the “ENGINE START STOP” switch has been switched to ACCESSORY or OFF mode.
- When only the tail lights are on: The tail lights turn off automatically if the “ENGINE START STOP” switch is switched to ACCESSORY or OFF mode and driver’s door is opened.

To turn the lights on again, turn the “ENGINE START STOP” switch to IGNITION ON mode, or turn the light switch off once and then back to the  or  position.

■ **Customization**

Settings (e.g. light sensor sensitivity) can be changed.  
(Customizable features →P. 573)

 **NOTICE**

■ **To prevent battery discharge**

Do not leave the lights on longer than necessary when the engine is not running.

## 2-3. Operating the lights and wipers Fog light switch

The fog lights improve visibility in difficult driving conditions, such as in rain or fog. The fog lights can be used when the headlights are on low beam.

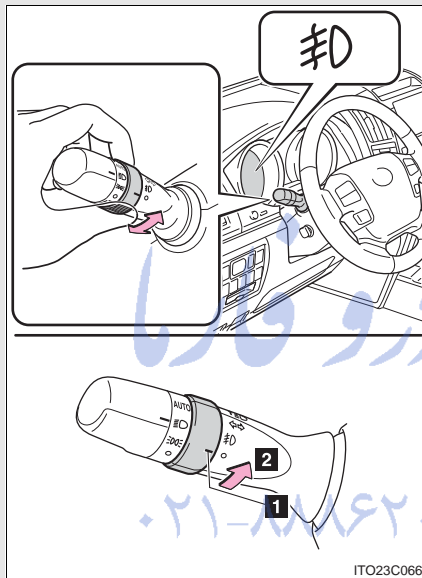

FarmaSOS.com

## 2-3. Operating the lights and wipers Windshield wipers and washer

### ► Intermittent wiper with interval adjuster

Wiper intervals can be adjusted for intermittent operation (when  is selected).

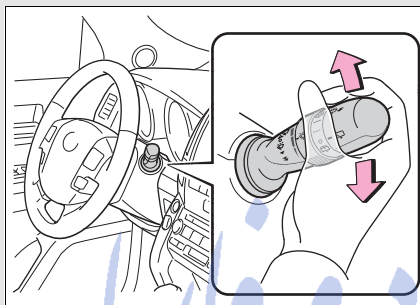

- 1 Intermittent wiper operation
- 2 Low speed wiper operation
- 3 High speed wiper operation
- 4 Temporary operation

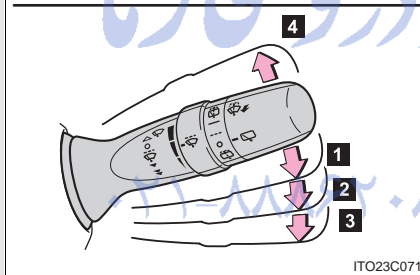

- 5 Increases the intermittent windshield wiper frequency
- 6 Decreases the intermittent windshield wiper frequency

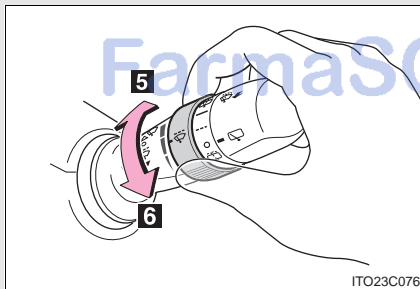

2

When driving

## 2-3. Operating the lights and wipers

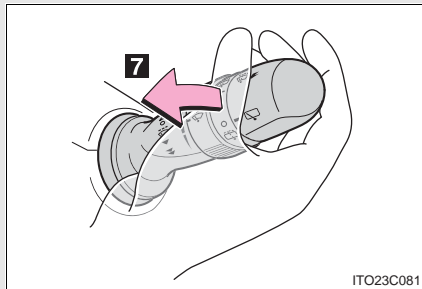

### 7 Washer/wiper dual operation

Wipers operate automatically.

### ► Rain-sensing windshield wipers

With "AUTO" selected, the wipers will operate automatically when the sensor detects falling rain. The system automatically adjusts wiper timing in accordance with rain volume and vehicle speed.

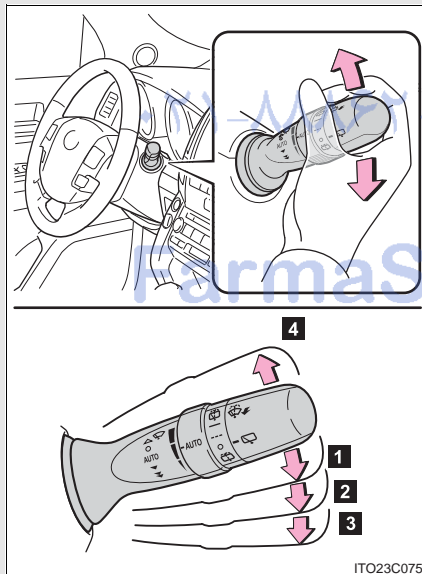

### 1 Rain-sensing wiper operation

### 2 Low speed wiper operation

### 3 High speed wiper operation

### 4 Temporary operation

2-3. Operating the lights and wipers

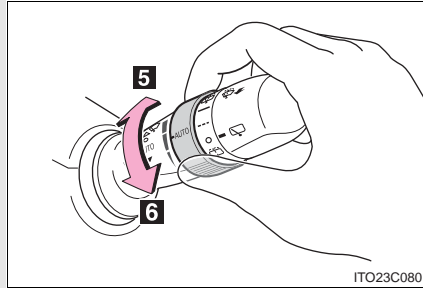

**5** Sensor sensitivity (high)

**6** Sensor sensitivity (low)

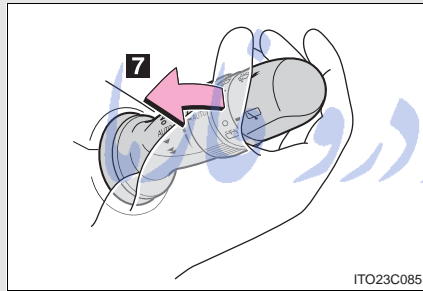

**7** Washer/wiper dual operation

Wipers operate automatically. (After operating several times, the wipers operate one more time after a short delay to prevent dripping.)

2

When driving

تلفن شبانه روزی: ۰۲۱-۸۸۸۶۲۰۸۵

FarmaSOS.com

■ **The windshield wiper and washer can be operated when**

The "ENGINE START STOP" switch is in IGNITION ON mode.

■ **Effects of vehicle speed on wiper operation (vehicles equipped with rain-sensing windshield wipers)**

Vehicle speed affects the wiper operation when the washer is being used (delay until drip prevention wiper sweep occurs) even when the wipers are not in "AUTO" mode.

With "▼" selected, wiper operation will be switched from low speed to intermittent wiper operation only when the vehicle is stationary.

(However, when the sensor sensitivity is adjusted to the highest level, the mode cannot be switched.)

■ **Rain drop sensor (vehicles with rain-sensing windshield wipers)**

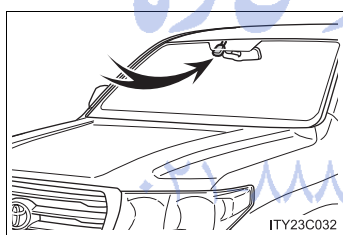

- The sensor judges the amount of rain-drops.

- If the wiper switch is turned to "AUTO" position while the "ENGINE START STOP" switch is in IGNITION ON mode, the wiper will operate once to show that "AUTO" mode is activated.
- If the temperature of the rain drop sensor is 176°F (80°C) or higher, or 14°F (-10°C) or lower, automatic operation may not occur. In this case, operate the wipers in any mode other than "AUTO".

■ **If no windshield washer fluid sprays**

Check that the washer nozzles are not blocked if there is washer fluid in the windshield washer fluid reservoir.

■ **Windshield wiper features**

The rear window and outside rear view mirror defoggers automatically turn on when you operate the wipers.

 **CAUTION**

■ **Caution regarding the use of windshield wipers in “AUTO” mode**

The windshield wipers may operate unexpectedly if the sensor is touched or the windshield is subject to vibration in “AUTO” mode. Take care that your fingers or anything else do not become caught in the windshield wipers.

 **NOTICE**

■ **When the windshield is dry**

Do not use the wipers, as they may damage the windshield.

■ **When there is no washer fluid spray from the nozzle**

Damage to the washer fluid pump may be caused if the lever is pulled toward you and held continually.

■ **When a nozzle becomes blocked**

Do not try to clear it with a pin or other object. The nozzle will be damaged.

2

When driving

FarmaSOS.com

## 2-3. Operating the lights and wipers Rear window wiper and washer

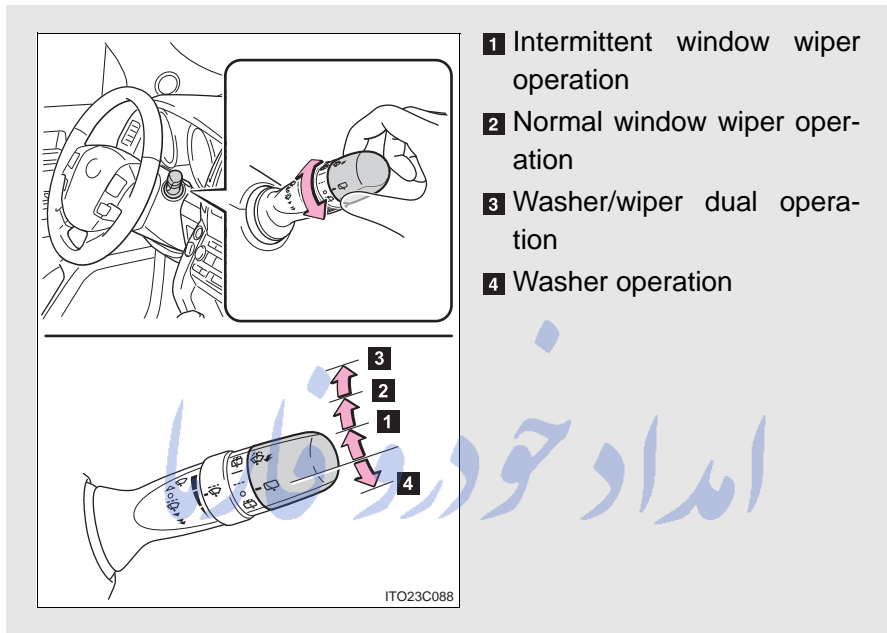

- **The rear window wiper and washer can be operated when**  
The “ENGINE START STOP” switch is in IGNITION ON mode.

 **NOTICE**

■ **When the rear window is dry**

Do not use the wipers, as it may damage the rear window.



## 2-3. Operating the lights and wipers Headlight cleaner switch\*

**Washer fluid can be sprayed on the headlights.**

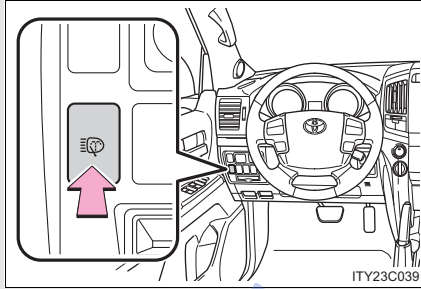

Press the switch to clean the headlights.

2

When driving

### ■ The headlight cleaner can be operated when

The "ENGINE START STOP" switch is in IGNITION ON mode and the headlight switch is turned on.

### ⚠ NOTICE

#### ■ When the washer fluid tank is empty

Do not use this function when the washer fluid tank is empty. This may cause the washer fluid pump to overheat.

\*: If equipped

## 2-4. Using other driving systems Cruise control

Use the cruise control to maintain a set speed without using the accelerator.

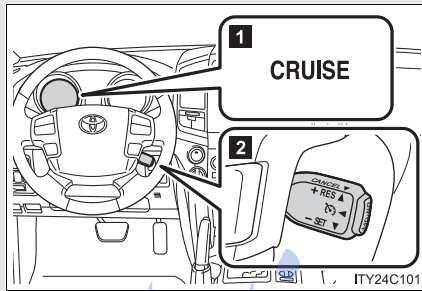

- 1 Indicator
- 2 Cruise control switch

### ■ Set the vehicle speed

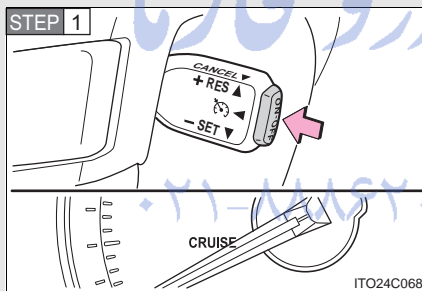

Press the "ON-OFF" button to operate the cruise control.

Press the switch once more to deactivate the cruise control.

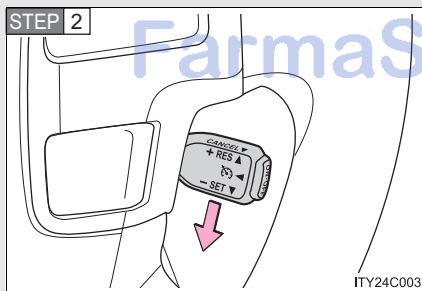

Accelerate or decelerate to the desired speed and push the lever down to set the cruise control speed.

■ **Adjusting the speed setting**

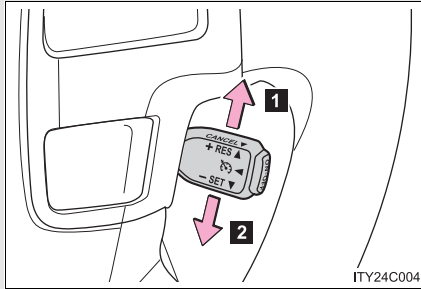

- 1** Increase speed
- 2** Decrease speed

Hold the lever until the desired speed setting is obtained.

Fine adjustment of the set speed (approximately 1.0 mph [1.6 km/h]) can be made by lightly pushing the lever up or down and releasing it.

■ **Canceling and resuming regular acceleration**

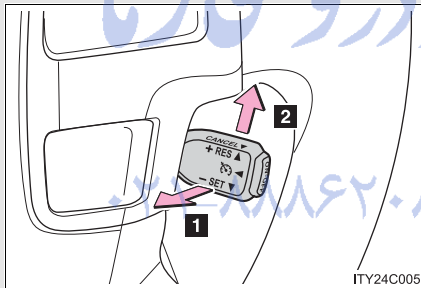

- 1** Cancel

Pull the lever towards you to cancel cruise control.

The speed setting is also canceled when the brakes are applied.

- 2** Resume

To resume cruise control and return to the set speed, push the lever up.

■ **Cruise control can be set when**

- The shift lever is in the “D” or “4”, “5” or “6” range of “S”.
- Vehicle speed is more than approximately 25 mph (40 km/h).

■ **Accelerating**

The vehicle can be accelerated normally. After acceleration, the set speed resumes.

■ **Automatic cruise control cancelation**

The set speed is automatically canceled in any of the following situations.

- Actual vehicle speed falls more than approximately 10 mph (16 km/h) below the preset vehicle speed.  
At this time, the memorized set speed is not retained.
- VSC is activated.
- Actual vehicle speed is below approximately 25 mph (40 km/h).
- The switching operation continues for 5 seconds or more after the center differential lock switch has been operated.

■ **If the cruise control indicator light flashes**

Press the “ON-OFF” button once, and then press the button again to reactivate the system.

If the cruise control speed cannot be set or if the cruise control cancels immediately after being activated, there may be a malfunction in the cruise control system. Contact your Toyota dealer, and have your Toyota inspected.

**⚠ CAUTION**

■ **To avoid operating the cruise control by mistake**

Keep the "ON-OFF" button off when not in use.

■ **Situations unsuitable for cruise control**

Do not use cruise control in any of the following situations. Doing so may result in control of the vehicle being lost and could cause an accident resulting in death or serious injury.

- In heavy traffic
- On roads with sharp bends
- On slippery roads, such as those covered with rain, ice or snow
- On steep hills  
Vehicle speed may exceed the set speed when driving down a steep hill.
- On winding roads
- When towing a trailer or emergency towing

2

When driving

تلفن شبانه روزی: ۰۲۱-۸۸۶۲۰۸۵

FarmaSOS.com

## 2-4. Using other driving systems Intuitive parking assist\*

Intuitive parking assist uses sensors in the corners and rear of the vehicle to detect the distance between the vehicle and any obstacles, and informs the driver of this distance using the multi-information display, the touch screen, and warning beeps.

### ■ Sensor types

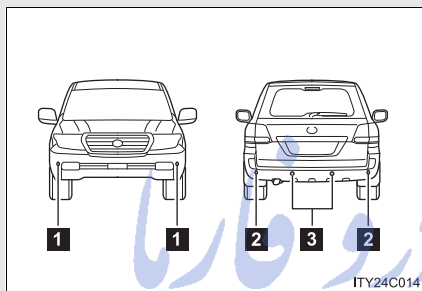

- 1 Front corner sensors
- 2 Rear corner sensors
- 3 Back sensors

### ■ Intuitive parking assist switch

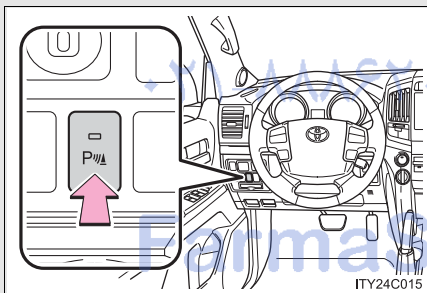

#### On/off

To turn the system on, press the switch. The indicator light comes on to inform the driver that the system is operational.

To turn the system off, press the switch again.

\*: If equipped

■ Multi-information display

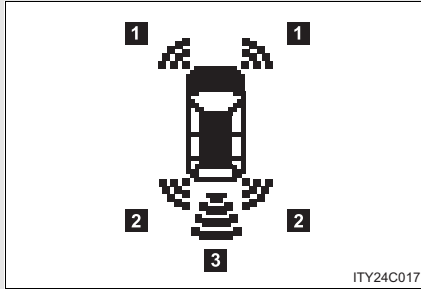

- 1 Front corner sensor detection
- 2 Rear corner sensor detection
- 3 Back sensor detection

■ Touch screen (with navigation system)

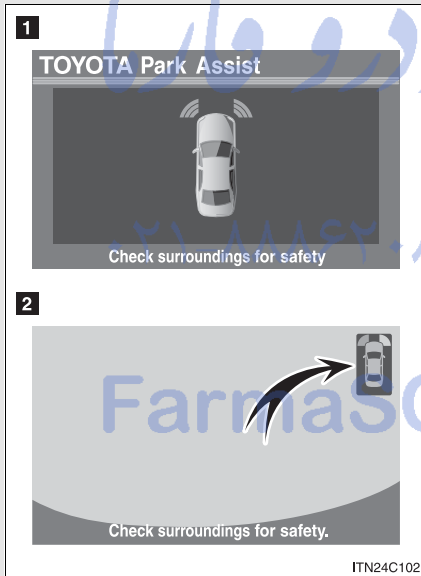

- 1 When the vehicle is moving forward  
The graphic is automatically displayed when an obstacle is detected. The screen can be set so that the graphic is not displayed. (→P. 196)
- 2 When the vehicle is moving backward (insert display)  
A simplified image is displayed on the touch screen when an obstacle is detected.









2

When driving

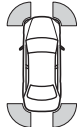
2-4. Using other driving systems









**Sensor detection display, obstacle distance**

■ **Corner sensors**

Approximate distance to obstacle	Multi-information display	Touch screen	
			Insert display
Front: 2.0 ft. (60 cm) to 1.6 ft. (47.5 cm) Rear: 2.0 ft. (60 cm) to 1.2 ft. (37.5 cm)	 (continuous)	 (continuous)	 (blinking)
Front: 1.6 ft. (47.5 cm) to 1.1 ft. (35 cm) Rear: 1.2 ft. (37.5 cm) to 1.0 ft. (30 cm)	 (continuous)	 (continuous)	 (blinking rapidly)
Front: Less than 1.1 ft. (35 cm) Rear: Less than 1.0 ft. (30 cm)	 (blinking)	 (continuous)	 (continuous)



■ Back sensors

Approximate distance to obstacle	Multi-information display	Touch screen (insert display)
4.9 ft. (150 cm) to 2.0 ft. (60 cm)	 (continuous)	 (blinking slowly)
2.0 ft. (60 cm) to 1.5 ft. (45 cm)	 (continuous)	 (blinking)
1.5 ft. (45 cm) to 1.1 ft. (35 cm)	 (continuous)	 (blinking rapidly)
Less than 1.1 ft. (35 cm)	 (blinking)	 (continuous)

2

When driving

### Beeps and obstacle distance

A beep sounds when the corner sensors and back sensors are operating.

- The beep sounds faster as the vehicle approaches an obstacle. When the vehicle comes within the following distance of the obstacle, the beep sounds continuously.
  - Front corner and back sensors: Approximately 1.1 ft. (35 cm)
  - Rear corner sensors: Approximately 1.0 ft. (30 cm)
- When two or more obstacles are detected simultaneously, the beep system responds to the nearest obstacle. If one or both come within the above distances, the beep will repeat a long tone, followed by fast beeps.
- You can change the volume of the warning beeps. (→P. 196)

تلفن شبانه روزی: ۰۲۱-۸۸۸۶۲۰۸۵

FarmaSOS.com

### Obstacle detection range

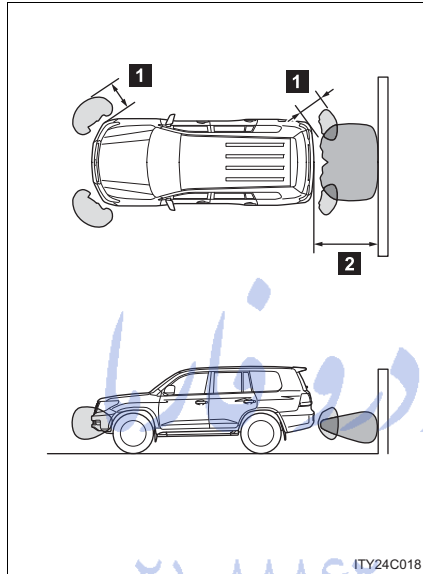

**1** About 2.0 ft. (60 cm)

**2** About 4.9 ft. (150 cm)

The detection area of the sensors is shown to the left. If obstacles move too close to the sensors, they will not be detected.

The range of the sensors may change depending on the shape of the object etc.

2

When driving

### Warning beep volume and touch screen settings (vehicles with navigation system only)

You can change the warning beep volume and touch screen operating conditions.

**STEP 1** Press "SETUP" to display the "Setup" screen.

**STEP 2** Touch "Vehicle".

**STEP 3** Touch "TOYOTA Park Assist".

## 2-4. Using other driving systems

### ■ Changing the warning beep volume

**STEP 1** Touch “1” to “5” of “Alert Volume”.

**STEP 2** Adjust the beep volume, then touch “Save”.

### ■ Display off setting

Touch “On” or “Off” of “Display”.

When an obstacle is detected while the rear view monitor is in use, the warning indicator will appear in the top right of the screen even “Off” has been selected.

### ■ Changing display and alert settings

**STEP 1** Touch “Distance”.

**STEP 2** Touch “Rear” to change the distance for the back sensors display and tone indication, then touch “Save”.

---

### ■ The intuitive parking assist can be operated when

#### ● Front corner sensors:

- The “ENGINE START STOP” switch is in IGNITION ON mode.
- The shift lever is in a position other than “P”.
- The vehicle speed is less than about 6 mph (10 km/h).

#### ● Rear corner and back sensors:

- The “ENGINE START STOP” switch is in IGNITION ON mode.
- The shift lever is in “R”.

### ■ Sensor detection information

- Certain vehicle conditions and the surrounding environment may affect the ability of the sensor to correctly detect obstacles. Particular instances where this may occur are listed below.
  - There is dirt, snow or ice on the sensor. (Wiping the sensor will resolve this problem.)
  - The sensor is frozen. (Thawing the sensor will resolve this problem.)
  - The sensor is covered in any way.
  - In harsh sunlight or intense cold weather.
  - When driving on bumpy, sloped or gravel roads, or over grass.
  - If there is something producing ultrasonic waves nearby, such as another vehicle's horn, motorcycle engine noise, air braking sound from heavy-duty vehicles, or another vehicle using the park assist system.
  - In heavy rain, or if water is splashed on the sensors.
  - The vehicle is leaning considerably to one side.
  - If a commercial fender pole or radio antenna is installed.
  - If moving towards a high curb or a curb corner.
  - If towing eyelet is installed on your vehicle.
  - The bumper or sensor receives a strong impact.
  - A non-genuine Toyota suspension (lowered suspension etc.) is installed.

In addition to the examples above, there are instances in which, because of their shapes, signs and other objects may be judged by the sensor to be closer than they are.

- The shape of the obstacle may prevent the sensor from detecting it. Pay particular attention to the following obstacles.
  - Thin objects such as wire, fencing or rope.
  - Objects that absorb sound waves, such as cotton or snow.
  - Objects with sharp corners.
  - Low objects.
  - Objects where the upper section projects out over the lower section.

## 2-4. Using other driving systems

### ■ If a message is displayed on the multi-information display

→P. 513

### ■ When there is a malfunction

In the following cases, have the vehicle inspected by your Toyota dealer.

- If the bumper is damaged
- If the intuitive parking assist indicator light remains on without a beep sounds.

### CAUTION

#### ■ When using the intuitive parking assist

Observe the following precautions.

Failing to do so may result in the vehicle being unable to be driven safely and possibly cause an accident.

- Do not use the sensor at speeds in excess of 6 mph (10 km/h).
- When moving forward or reversing, always check your surroundings for safety and drive carefully.
- Do not install accessories within the sensors' detection areas.

### NOTICE

#### ■ When washing the vehicle

Do not apply intensive bursts of water or steam to the sensor area. Doing so may result in the sensor malfunctioning.

## 2-4. Using other driving systems Four-wheel drive system

Use the four-wheel drive control switch and center differential lock/unlock switch to select the following transfer and center differential modes.

### ■ Four-wheel drive control switch

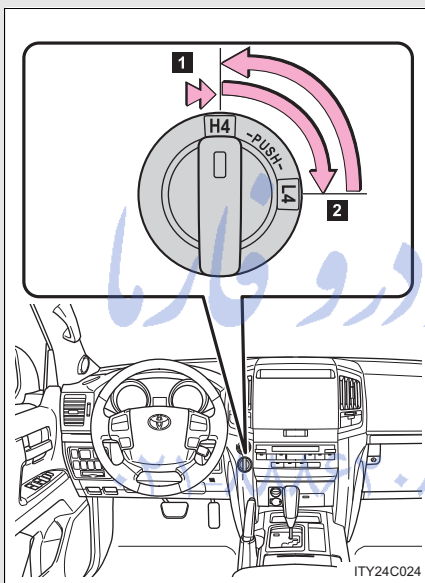

#### 1 "H4" (high speed position)

Normal driving on all types of roads.

#### 2 "L4" (low speed position)

Driving requiring maximum power and traction such as climbing or descending steep hills, off-road driving, and hard pulling in sand or mud, etc.

### ■ Center differential lock/unlock switch

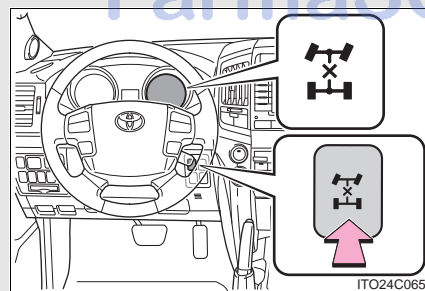

Lock the center differential when your vehicle's wheels get stuck in a ditch or when driving on a slippery or bumpy surface.

Unlock the center differential after the wheels have been freed, or after moving to a flat, non-slippery surface.

### Shifting between “H4” and “L4”

#### ■ Shifting from “H4” to “L4”

**STEP 1** Stop the vehicle completely.

**STEP 2** Shift the shift lever to “N”.

**STEP 3** Push and turn the four-wheel drive control switch fully clockwise.

Maintain this condition until the low speed four-wheel drive indicator light turns on.

#### ■ Shifting from “L4” to “H4”

**STEP 1** Stop the vehicle completely.

**STEP 2** Shift the shift lever to “N”.

**STEP 3** Turn the four-wheel drive control switch fully counterclockwise.

Maintain this condition until the low speed four-wheel drive indicator light turns off.

تلفن شبانه روزی: ۰۲۱-۸۸۶۲۰۸۵

FarmaSOS.com



**■ The four-wheel drive control switch can be operated when**

- The “ENGINE START STOP” switch is in IGNITION ON mode.
- The shift lever is in the “N” position.
- The vehicle is stopped completely.

**■ The low speed four-wheel drive indicator light**

The indicator light blinks while shifting between “H4” and “L4”.

**■ Advice for driving on slippery roads**

- If you shift the four-wheel drive control switch to “L4” and the shift lever to the “2” range of “S” while driving in steep off-road areas, the output of the brake can be controlled effectively by the Active TRAC, which assists the driver to control the driving power of 4 wheels.
- Use the “1” range of “S” of the shift lever for maximum power and traction when your wheels get stuck or when driving down a steep incline.

**■ The center differential lock indicator light**

The indicator light blinks while locking/unlocking the center differential.

**■ The center differential lock/unlock button can be operated when**

- The “ENGINE START STOP” switch is in IGNITION ON mode.
- The vehicle speed is less than 60 mph (100 km/h).

**■ Locking/unlocking the center differential**

- When the center differential is locked, VSC is automatically turned off. (The center differential lock and “VSC OFF” indicator lights come on.)
- If the operation is not completed, the center differential lock indicator blinks. If the indicator light does not turn off when unlocking the center differential, drive straight ahead while accelerating or decelerating, or drive in reverse.
- If the center differential lock/unlock is not completed within 5 seconds while the cruise control system is on, cancel the cruise control system.

■ **If the low speed four-wheel drive indicator light or the center differential lock indicator light blinks**

- If the low speed four-wheel drive indicator light continues to blink when using the four-wheel drive control switch, stop the vehicle completely, move the shift lever to “N” and operate the switch again.
- If the shift lever is moved before the low speed four-wheel drive indicator turns on/off, the transfer mode may not be shifted completely. The transfer mode disengages both the front and rear driveshafts from the powertrain and allows the vehicle to move regardless of the shift position. (At this time, the indicator blinks and the buzzer sounds.)

Therefore, the vehicle is free to roll even if the automatic transmission is in “P”. You or someone else could be seriously injured. You must complete the shifting of the transfer mode.

To complete the shifting, stop the vehicle completely, return the shift lever to “N”, and confirm that the shift was completed (the indicator turns on/off).

- If the engine coolant temperature is too low, the four-wheel drive control system may not be able to shift. When the engine is warmer press the switch again.

If the low speed four-wheel drive indicator light or the center differential lock indicator light continues to blink even after attempting the above, there may be a malfunction in the engine, the brake system or the four-wheel drive system. In this case, you may not be able to shift between “H4” and “L4”, and the center differential lock may not be operable. Have the vehicle inspected by your Toyota dealer immediately.

**⚠ CAUTION****■ While driving**

Never move the four-wheel drive control switch if the wheels have lost traction. Doing so may cause an accident resulting in death or serious injury.

**■ When the vehicle is parked**

If the shift lever is moved before the low speed four-wheel drive indicator turns on/off, the transfer mode may not be shifted completely. The transfer mode disengages both the front and rear driveshafts from the powertrain and allows the vehicle to move regardless of the shift position. (At this time, the indicator blinks and the buzzer sounds.)

Therefore, the vehicle is free to roll even if the automatic transmission is in "P". You or someone else could be seriously injured. You must complete the shifting of the transfer mode. (→P. 199)

2

When driving

**⚠ NOTICE****■ To prevent damage to the center differential**

- For normal driving on dry and hard surface roads, unlock the center differential.
- Unlock the center differential after the wheels are out of the ditch or off the slippery or bumpy surface.
- Do not push the center differential lock/unlock button when the vehicle is turning or when its wheels are spinning freely off the ground.

## 2-4. Using other driving systems Crawl Control

Allows travel on extremely rough off-road surfaces at a fixed low speed without pressing the accelerator or brake pedal. Minimizes loss of traction or vehicle slip when driving on slippery road surfaces, allowing for stable driving.

### ■ Crawl Control switch

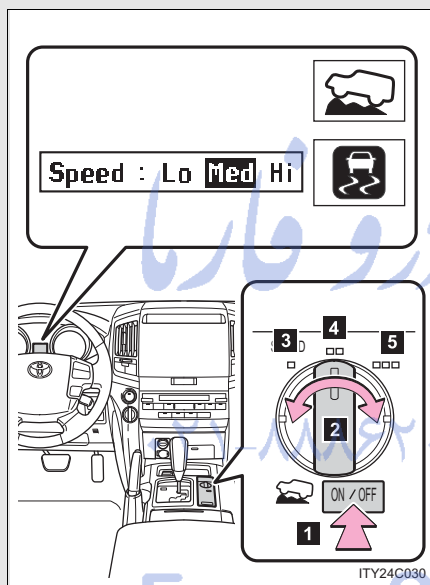

#### 1 On/off

The Crawl Control indicator is lit and the slip indicator flashes when operating.

#### 2 Speed selection switch

#### 3 Low mode

Effective when traveling on rocks and pebbles.\*

#### 4 Medium mode

Effective when traveling on snow mounds or descending a slope of rubble.\*

#### 5 High mode

Effective when ascending a slope of rubble, or traveling on snow, dirt, mud, sand, gravel, grass etc.\*

\*: Depending on the road surface, may not be the most effective.

**When the system is turned off**

If the system is turned off when Crawl Control is operating, the slip indicator turns off, and the Crawl Control indicator flashes until the system has turned off completely. When turning off Crawl Control while traveling, stop the vehicle before the Crawl Control indicator turns off, or drive extremely carefully.

**■ The Crawl Control can be operated when**

- The engine is running.
- The shift lever is in any gear other than "P" or "N".
- The four-wheel drive control switch is in "L4".
- The driver's door is closed.

**■ Automatic system cancelation**

In either of the following situations, a buzzer sounds for approximately 3 seconds. The Crawl Control indicator goes off after the system has automatically turned off:

- When the shift lever is moved to "P".
- When the four-wheel drive control switch is in "H4".

In either of the following situations, a buzzer sounds for approximately 3 seconds, the Crawl Control indicator blinks, and the control will decrease gradually. The Crawl Control indicator goes off after the system has automatically turned off:

- When the shift lever is moved to "N".
- If the driver's door is opened.

## 2-4. Using other driving systems

### ■ Function limitations

- In the following situations, brake control can be used to drive downhill at a constant speed. However, engine control is not available when driving uphill at a constant speed.
  - When switched to second start mode
  - When the vehicle speed exceeds approximately 6 mph (10 km/h).
- In the following situation, engine control and brake control will be temporarily canceled.
  - When the vehicle speed exceeds approximately 15 mph (25 km/h).

### ■ If the brake system overheats

The system will cease operation and a buzzer will sound to alert the driver. Stop the vehicle in a safe place. (There is no problem with continuing normal driving.)

### ■ If the automatic transmission system overheats

The system will cease operation, a buzzer will sound and a warning message will be displayed, or the automatic transmission fluid temperature warning light will come on to alert the driver. Stop the vehicle in a safe place until the warning message or the warning light turns off.

### ■ Sounds and vibrations caused by the Crawl Control system

- A sound may be heard from the engine compartment when the engine is started or just after the vehicle begins to move. This sound does not indicate that a malfunction has occurred in Crawl Control system.
- Either of the following conditions may occur when the Crawl Control system is operating. None of these are indicators that a malfunction has occurred.
  - Vibrations may be felt through the vehicle body and steering.
  - A motor sound may be heard after the vehicle comes to a stop.

 CAUTION

■ **When using Crawl Control**

Do not rely solely on the Crawl Control. This function does not extend the vehicle's performance limitations. Always thoroughly check the road conditions, and drive safely.

■ **These conditions may cause the system not to operate properly**

When driving on the following surfaces, the system may not be able to maintain a fixed low speed, which may result in an accident:

- Extremely steep inclines.
- Extremely uneven surfaces.
- Snow-covered roads, or other slippery surfaces.

2

When driving

تلفن شبانه روزی: ۰۲۱-۸۸۶۲۰۸۵

FarmaSOS.com

## 2-4. Using other driving systems

### Driving assist systems

**To help enhance driving safety and performance, the following systems operate automatically in response to various driving situations. Be aware, however, that these systems are supplementary and should not be relied upon too heavily when operating the vehicle.**

#### ■ Multi Terrain ABS (Anti-lock Brake System)

Helps to prevent wheel lock when the brakes are applied suddenly, or if the brakes are applied while driving on a slippery road surface, or in off-road conditions (such as rough roads, sand and mud).

#### ■ Brake assist

Generates an increased level of braking force after the brake pedal is depressed, when the system detects a panic stop situation.

#### ■ VSC (Vehicle Stability Control)

Helps the driver to control skidding when swerving suddenly or turning on slippery road surfaces.

#### ■ Active TRAC (Traction Control)

Helps to maintain drive power and prevent the 4 wheels from spinning when starting the vehicle or accelerating on slippery roads.

#### ■ Hill-start assist control

Helps prevent the vehicle from rolling backwards when starting on an incline or slippery slope. The hill-start assist control only operate for 5 seconds when engaged.

#### ■ KDSS (Kinetic Dynamic Suspension System)

KDSS enhances ride comfort and handling response by using a hydraulic control system to control the suspension stabilizer bars in response to road surface and driving conditions during cornering or off-road driving.

#### ■ PCS (Pre-Collision System) (if equipped)

→P. 214



**When the VSC/Active TRAC/hill-start assist control systems are operating**

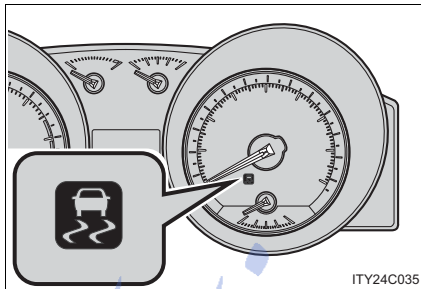

If the vehicle is in danger of slipping, rolling backwards when starting on an incline, or if the rear wheels spin, the slip indicator light flashes to indicate that the VSC/Active TRAC/hill-start assist control systems have been engaged.

A buzzer (intermittent) sounds to indicate that VSC is operating.

The stop lights and high mounted stoplight turn on when the hill-start assist control system is operating.

2

When driving

تلفن شبانه روزی: ۰۲۱-۸۸۸۶۲۰۸۵

FarmaSOS.com

### To disable Active TRAC and/or VSC system

If the vehicle gets stuck in fresh snow or mud, Active TRAC and VSC system may reduce power from the engine to the wheels. You may need to turn the system off to enable you to rock the vehicle in order to free it.

#### ■ Turning off Active TRAC

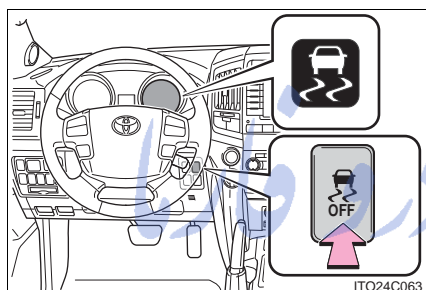

Quickly push and release the button to turn off Active TRAC.

The slip indicator light should come on.

Active TRAC will stop the control of the engine. However, the brake will remain to be controlled.

Push the button again to turn the system back on.

#### ■ Turning off Active TRAC and VSC

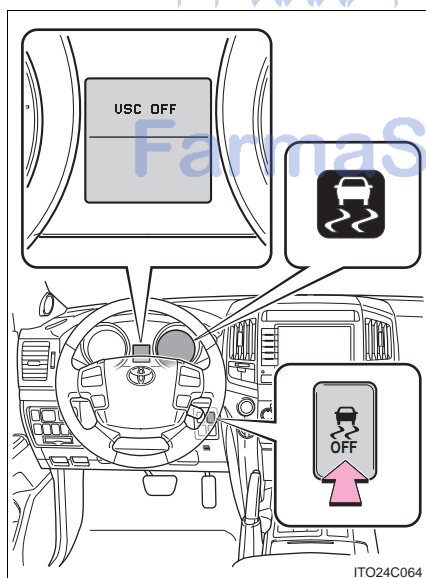

Push and hold the button for more than 3 seconds while the vehicle is stopped to turn off Active TRAC and VSC.

The slip indicator light will come on and "VSC OFF" will be shown on the multi-information display.

Push the button again to turn the system back on.

■ **Active TRAC can be turned off when**

The four-wheel drive control switch is in “H4” and the center differential is unlocked.

■ **Automatic reactivation of Active TRAC and VSC**

Turning the “ENGINE START STOP” switch off after turning off the Active TRAC and VSC systems will automatically re-enable them.

■ **Automatic Active TRAC reactivation**

If only the Active TRAC system is turned off, the Active TRAC system will turn on when vehicle speed increases.

■ **Automatic Active TRAC and VSC reactivation**

If the Active TRAC and VSC systems are turned off, the systems will not turn on even when vehicle speed.

■ **If the brake system overheats**

The Active TRAC and hill-start assist control will cease operation and a buzzer will sound to alert the driver. Stop the vehicle in a safe place. (There is no problem with continuing normal driving.)

■ **Sounds and vibrations caused by the Multi Terrain ABS, brake assist, Active TRAC, VSC and hill-start assist control**

- A sound may be heard from the engine compartment when the engine is started or just after the vehicle begins to move. This sound does not indicate that a malfunction has occurred in any of these systems.
- Any of the following conditions may occur when the above systems are operating. None of these indicates that a malfunction has occurred.
  - Vibrations may be felt through the vehicle body and steering.
  - A motor sound may be heard after the vehicle comes to a stop.
  - The brake pedal may pulsate slightly after the Multi Terrain ABS is activated.
  - The brake pedal may move down slightly after the Multi Terrain ABS is activated.

■ **Hill-start assist control is operational when**

- The shift lever is in “D” or “S”.
- The brake pedal is not depressed.

## 2-4. Using other driving systems

### CAUTION

Any of the following conditions may result in an accident which could cause death or serious injury:

■ **The Multi Terrain ABS does not operate effectively when**

- The limits of tire gripping performance have been exceeded.
- The vehicle hydroplanes while driving at high speed on the wet or slick road.

■ **Stopping distance when the Multi Terrain ABS is operating on the wet or slick roads**

The Multi Terrain ABS is not designed to shorten the vehicle's stopping distance. Always maintain a safe distance from the vehicle in front of you in the following situations.

- When driving on dirt, gravel or snow-covered roads
- When driving with tire chains
- When driving over bumps in the road
- When driving over roads with potholes or roads with uneven roads

■ **Active TRAC may not operate effectively when**

Directional control and power may not be achievable while driving on slippery road surfaces, even if the Active TRAC is operating. Do not drive the vehicle in conditions where stability and power may be lost.

■ **If the hill-start assist control does not operate effectively**

Do not overly rely on the hill-start assist control. The hill-start assist control may not operate effectively on steep inclines and roads covered in ice.

■ **When Active TRAC and VSC are off**

Be especially careful and drive at a speed appropriate to the road conditions. As there are systems to ensure vehicle stability and driving force, do not turn off Active TRAC and VSC unless necessary.

**⚠ CAUTION****■ When the VSC is activated**

The slip indicator light flashes and a warning buzzer sounds. Always drive carefully.

Reckless driving may cause an accident. Exercise particular care when the indicator light flashes and a buzzer sounds.

**■ Replacing tires**

Make sure that all tires are of the same size, brand, tread pattern and total load capacity. In addition, make sure that the tires are inflated to the specified tire pressure level.

The Multi Terrain ABS and VSC will not function correctly if different tires are fitted on the vehicle.

Contact your Toyota dealer for further information when replacing tires or wheels.

**■ Handling of tires and suspension**

Using tires with any kind of problem or modifying the suspension will affect the driving assist systems, and may cause the system to malfunction.

2

When driving

**⚠ NOTICE****■ KDSS**

In the following situations, there is the possibility that a system malfunction has occurred, and drive comfort and the vehicle's ability to travel on poor road surfaces may be reduced. Take the vehicle to your Toyota dealer immediately.

- When turning a corner, the vehicle's body seems to roll further than normal.
- If after the vehicle has been left in a slanted position for a long time, for example with the wheels of one side parked on a curb, the vehicle does not return to level when driving (the vehicle remains slanted to one side after returning the vehicle to level ground).

## 2-4. Using other driving systems Pre-Collision System\*

The system detects emergency braking from the speed and force with which the driver presses the brake pedal, and quickly tightens the seat belt to improve the effectiveness of the seat belt pretensioners (→P. 74). This system also operates in the same manner when the vehicle slips sideways.

### ■ The pre-collision system is operational when

- Vehicle speed exceeds 19 mph (30 km/h).
- The system detects sudden braking or skidding.
- The front occupants are wearing a seat belt.

### ■ When there is a malfunction in the system

Warning message will be displayed on the multi-information display.  
(→P. 513)

### ⚠ CAUTION

#### ■ Limitations of the pre-collision system

Do not rely on the pre-collision system. Always drive safely, taking care to observe your surroundings and checking for any obstacles or other road hazards.

\*: If equipped

## 2-5. Driving information

### Off-road precautions

This vehicle belongs to the utility vehicle class, which has higher ground clearance and narrower tread in relation to the height of its center of gravity to make it capable of performing in a wide variety of off-road applications.

#### Off-road vehicle feature

- Specific design characteristics give it a higher center of gravity than ordinary passenger cars. This vehicle design feature causes this type of vehicle to be more likely to rollover. And, utility vehicles have a significantly higher rollover rate than other types of vehicles.
- An advantage of the higher ground clearance is a better view of the road allowing you to anticipate problems.
- It is not designed for cornering at the same speeds as ordinary passenger cars any more than low-slung sports cars are designed to perform satisfactorily under off-road conditions. Therefore, sharp turns at excessive speeds may cause rollover.

2

When driving

FarmaSOS.com

 CAUTION

■ **Off-road vehicle precautions**

Always observe the following precautions to help minimize the risk of serious personal injury or damage to your vehicle:

- In a rollover crash, an unbelted person is significantly more likely to die than a person wearing a seat belt. Therefore, the driver and all passengers should fasten their seat belts whenever the vehicle is moving.
- Avoid sharp turns or abrupt maneuvers, if at all possible. Failure to operate this vehicle correctly may result in loss of control or vehicle rollover causing death or serious injury.
- Loading cargo on the roof luggage carrier will make the center of the vehicle gravity higher. Avoid high speeds, sudden starts, sharp turns, sudden braking or abrupt maneuvers, otherwise it may result in loss of control or vehicle rollover due to failure to operate this vehicle correctly.
- Always slow down in gusty crosswinds. Because of its profile and higher center of gravity, your vehicle is more sensitive to side winds than an ordinary passenger car. Slowing down will allow you to have better control.
- Do not drive horizontally across steep slopes. Driving straight up or straight down is preferred. Your vehicle (or any similar off-road vehicle) can tip over sideways much more easily than forward or backward.

FarmaSOS.com



**Off-road driving**

When driving your vehicle off-road, please observe the following precautions to ensure your driving enjoyment and to help prevent the closure of areas to off-road vehicles.

- Drive your vehicle only in areas where off-road vehicles are permitted to travel.
- Respect private property. Get owner's permission before entering private property.
- Do not enter areas that are closed. Honor gates, barriers and signs that restrict travel.
- Stay on established roads. When conditions are wet, driving techniques should be changed or travel delayed to prevent damage to roads.

2

When driving

---

**Additional information for off-road driving**

- ▶ For owners in U.S. mainland, Hawaii and Puerto Rico:

To obtain additional information pertaining to driving your vehicle off-road, consult the following organizations.

- State and Local Parks and Recreation Departments
- State Motor Vehicle Bureau
- Recreational Vehicle Clubs
- U.S. Forest Service and Bureau of Land Management

 CAUTION

■ **Off-road driving precautions**

Always observe the following precautions to help minimize the risk of serious personal injury or damage to your vehicle:

- Drive carefully when off the road. Do not take unnecessary risks by driving in dangerous places.
- Do not grip the steering wheel spokes when driving off-road. A bad bump could jerk the wheel and injure your hands. Keep both hands and especially your thumbs on the outside of the rim.
- Always check your brakes for effectiveness immediately after driving in sand, mud, water or snow.
- After driving through tall grass, mud, rock, sand, rivers, etc., check that there is no grass, bush, paper, rags, stone, sand, etc. adhering or trapped on the underbody. Clear off any such matter from the underbody. If the vehicle is used with these materials trapped or adhering to the underbody, a breakdown or fire could occur.
- When driving off-road or in rugged terrain, do not drive at excessive speeds, jump, make sharp turns, strike objects, etc. This may cause loss of control or vehicle rollover causing death or serious injury. You are also risking expensive damage to your vehicle's suspension and chassis.

FarmaSOS.com

 NOTICE

■ **To prevent the water damage**

Take all necessary safety measures to ensure that water damage to the engine or other components does not occur.

- Water entering the engine air intake will cause severe engine damage.
- Water entering the automatic transmission will cause deterioration in shift quality, locking up of your transmission accompanied by vibration, and ultimately damage.
- Water can wash the grease from wheel bearings, causing rusting and premature failure, and may also enter the differentials, transmission and transfer case, reducing the gear oil's lubricating qualities.

■ **When you drive through water**

If driving through water, such as when crossing shallow streams, first check the depth of the water and the bottom of the river bed for firmness. Drive slowly and avoid deep water.

■ **Inspection after off-road driving**

- Sand and mud that has accumulated in brake drums and around brake discs may affect braking efficiency and may damage brake system components.
- Always perform a maintenance inspection after each day of off-road driving that has taken you through rough terrain, sand, mud, or water. For scheduled maintenance information, refer to the "Scheduled Maintenance Guide" or "Owner's Manual Supplement".

## 2-5. Driving information Cargo and luggage

**Take notice of the following information about storage precautions, cargo capacity and load.**

- Stow cargo and luggage in the luggage compartment whenever possible. Be sure all items are secured in place.
- Be careful to keep the vehicle level. Placing the weight as far forward as possible helps maintain vehicle balance.
- For better fuel economy, do not carry unnecessary weight.

### ■ Roof luggage carrier (if equipped)

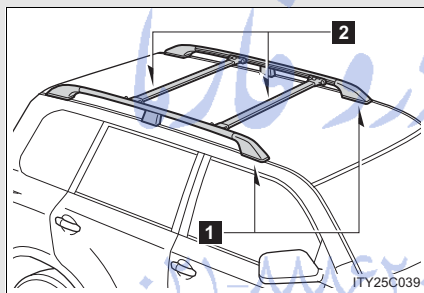

- 1 Roof rails
- 2 Cross rails

FarmaSOS.com

### Adjusting the position of cross rails

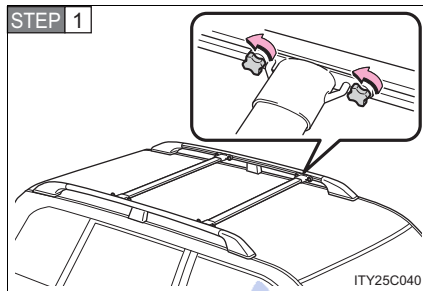

Turn the knobs counterclockwise to release the cross rails.

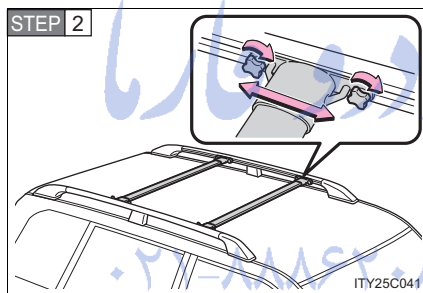

Slide the cross rails to the appropriate position for loading luggage and turn the knobs clockwise to tighten the cross rails securely.

2

When driving

FarmaSOS.com

### Capacity and distribution

Cargo capacity depends on the total weight of the occupants.

(Cargo capacity) = (Total load capacity) — (Total weight of occupants)

#### Steps for Determining Correct Load Limit—

- (1) Locate the statement “The combined weight of occupants and cargo should never exceed XXX kg or XXX lbs.” on your vehicle's placard.
- (2) Determine the combined weight of the driver and passengers that will be riding in your vehicle.
- (3) Subtract the combined weight of the driver and passengers from XXX kg or XXX lbs.
- (4) The resulting figure equals the available amount of cargo and luggage load capacity.

For example, if the “XXX” amount equals 1400 lbs. and there will be five 150 lb passengers in your vehicle, the amount of available cargo and luggage load capacity is 650 lbs. (1400 - 750 (5 × 150) = 650 lbs.)

- (5) Determine the combined weight of luggage and cargo being loaded on the vehicle.  
That weight may not safely exceed the available cargo and luggage load capacity calculated in Step 4.
- (6) If your vehicle will be towing a trailer, load from your trailer will be transferred to your vehicle. Consult this manual to determine how this reduces the available cargo and luggage load capacity of your vehicle. (→P. 227)

### Example on your vehicle

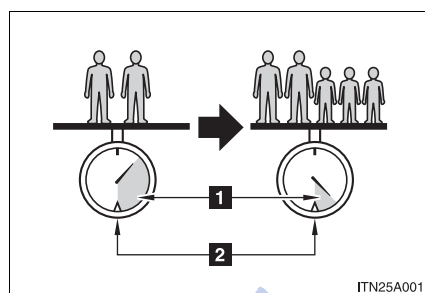

- 1** Cargo capacity
- 2** Total load capacity

When 2 people with the combined weight of 366 lb. (166 kg) are riding in your vehicle, which has a total load capacity of 1235 lb. (560 kg), the available amount of cargo and luggage load capacity will be as follows:

$$1235 \text{ lb.} - 366 \text{ lb.} = 869 \text{ lb.} \quad (560 \text{ kg} - 166 \text{ kg} = 394 \text{ kg})$$

In this condition, if 3 more passengers with the combined weight of 388 lb. (176 kg) get on, the available cargo and luggage load will be reduced as follows:

$$869 \text{ lb.} - 388 \text{ lb.} = 481 \text{ lb.} \quad (394 \text{ kg} - 176 \text{ kg} = 218 \text{ kg})$$

As shown in the above example, if the number of occupants increases, the cargo and luggage load equaling the combined weight of the occupants who got on later, by an amount. In other words, if an increase in the number of occupants causes an excess of the total load capacity (combined weight of occupants plus cargo and luggage load), you must reduce the cargo and luggage on your vehicle.

2

When driving

 CAUTION

■ **Things that must not be carried in the luggage compartment**

The following things may cause a fire if loaded in the luggage compartment.

- Receptacles containing gasoline
- Aerosol cans

■ **Storage precautions**

Observe the following precautions.

Failing to do so may result in death or serious injury.

- Do not place cargo or luggage in or on the following locations as the item may get under the brake or accelerator pedal and prevent the pedals from being depressed properly, block the driver's vision, or hit the driver or passengers, causing an accident.
  - Feet of the driver
  - Front passenger or rear seats (when stacking items)
  - Instrument panel
  - Dashboard
  - Auxiliary box or tray that has no lid
- Secure all items in the occupant compartment, as they may shift and injure someone during sudden braking, sudden swerving or an accident.
- Never allow anyone to ride in the luggage compartment. It is not designed for passengers. They should ride in their seats with their seat belts properly fastened. Otherwise, they are much more likely to suffer death or serious injury, in the event of sudden braking, sudden swerving or an accident.



**⚠ CAUTION****■ Weight of the load**

- Do not exceed the maximum axle weight rating or the total vehicle weight rating.
- Even if the total load of occupant's weight and the cargo load is less than the total load capacity, do not apply the load unevenly. Improper loading may cause deterioration of steering or braking control which may cause death or serious injury.

**■ Roof luggage carrier precautions**

To use the roof rails as a roof luggage carrier, you must fit the roof rails with two or more genuine Toyota cross rails or their equivalent.

When you load cargo on the roof luggage carrier, observe the following:

- Place the cargo so that its weight is distributed evenly between the front and rear axles.
- If loading long or wide cargo, never exceed the vehicle overall length or width. (→P. 430)
- Before driving, make sure the cargo is securely fastened on the roof luggage carrier.
- Loading cargo on the roof luggage carrier will make the center of the vehicle gravity higher. Avoid high speeds, sudden starts, sharp turns, sudden braking or abrupt maneuvers, otherwise it may result in loss of control or vehicle rollover due to failure to operate this vehicle correctly and result in death or serious injury.
- If driving for a long distance, on rough roads, or at high speeds, stop the vehicle now and then during the trip to make sure the cargo remains in its place.
- Do not exceed 154 lb. (70 kg) cargo weight on the roof luggage carrier.

## 2-5. Driving information

### CAUTION

#### ■ Cross rail adjustment

Make sure the cross rails are locked securely by pushing forward and rearward them.

Failure to do so may cause an accident or severe injury in the event of emergency braking or a collision.

### NOTICE

#### ■ Cross rail adjustment

Do not remove the cross rail stoppers, or the moon roof may be damaged when it is tilted.

#### ■ When loading the luggage

Be careful not to scratch the surface of the moon roof.

تلفن شبانه روزی: ۰۲۱-۸۸۶۲۰۸۵

FarmaSOS.com

## 2-5. Driving information

### Vehicle load limits

**Vehicle load limits include total load capacity, seating capacity, towing capacity and cargo capacity.**

■ **Total load capacity: 1235 lb. (560 kg)**

Total load capacity means the combined weight of occupants, cargo and luggage.

■ **Seating capacity: 8 occupants (Front 2, Rear 6)**

Seating capacity means the maximum number of occupants whose estimated average weight is 150 lb. (68 kg) per person.

Even if the number of occupants are within the seating capacity, do not exceed the total load capacity.

■ **Towing capacity: 8500 lb. (3856 kg)**

Towing capacity means the maximum gross trailer weight (trailer weight plus its cargo weight) that your vehicle is able to tow.

■ **Cargo capacity**

Cargo capacity may increase or decrease depending on the weight and the number of occupants.

2

When driving

■ **Total load capacity and seating capacity**

These details are also described on the tire and loading information label. (→P. 454)

**⚠ CAUTION**

■ **Overloading the vehicle**

Do not overload the vehicle.

It may not only cause damage to the tires, but also degrade steering and braking ability, resulting in an accident.

## 2-5. Driving information

### Winter driving tips

**Carry out the necessary preparations and inspections before driving the vehicle in winter. Always drive the vehicle in a manner appropriate to the prevailing weather conditions.**

#### ■ Pre-winter preparations

- Use fluids that are appropriate to the prevailing outside temperatures.
  - Engine oil
  - Engine coolant
  - Washer fluid
- Have a service technician inspect the level and specific gravity of battery electrolyte.
- Have the vehicle fitted with four snow tires or purchase a set of tire chains for the rear tires.

Ensure that all tires are the same size and brand, and that chains match the size of the tires.

تلفن شبانه روزی: ۰۲۱-۸۸۶۲۰۸۵

FarmaSOS.com

■ **Before driving the vehicle**

Perform the following according to the driving conditions.

- Do not try to forcibly open a window or move a wiper that is frozen. Pour warm water over the frozen area to melt the ice. Wipe away the water immediately to prevent it from freezing.
- To ensure proper operation of the climate control system fan, remove any snow that has accumulated on the air inlet vents in front of the windshield.
- Remove any ice that has accumulated on the vehicle chassis.
- Periodically check for and remove any excess ice or snow that may have accumulated in the wheel well or on the brakes.

■ **When driving the vehicle**

Accelerate the vehicle slowly and drive at a reduced speed suitable to road conditions.

■ **When parking the vehicle**

Park the vehicle and move the shift lever to "P" without setting the parking brake. The parking brake may freeze up, preventing it from being released. If necessary, block the wheels to prevent inadvertent sliding or creeping.

### Selection tire chains

Use the correct tire chain size when mounting the tire chains.  
Chain size is regulated for each tire size.

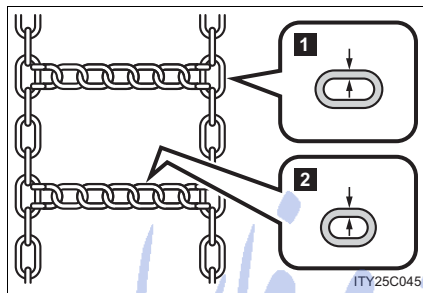

- 1 Side chain  
(0.20 in. [5 mm] in diameter)
- 2 Cross chain  
(0.25 in. [6.3 mm] in diameter)

### Regulations on the use of tire chains

- Regulations regarding the use of tire chains vary according to location and type of road. Always check local regulations before installing chains.
- Retighten the chains after driving 1/4 - 1/2 mile (0.5 - 1.0 km).

### ■ Tire chains

Observe the following precautions when installing and removing chains.

- Install and remove tire chains in a safe location.
- Install tire chains on the rear tires only. Do not install the chains on the front tires.
- Install tire chains following the instructions provided in the accompanying manual.

**⚠ CAUTION****■ Driving with snow tires**

Observe the following precautions to reduce the risk of accidents. Failing to do so may result in a loss of vehicle control and cause death or serious injury.

- Use tires of the size specified for your vehicle.
- Maintain the recommended level of tire inflation pressure.
- Do not drive in excess of 75 mph (120 km/h), regardless of the type of snow tires being used.
- Snow tires should be installed on all wheels.

**■ Driving with tire chains**

Observe the following precautions to reduce the risk of accidents. Failing to do so may result in the vehicle being unable to be driven safely, and may cause death or serious injury.

- Do not drive in excess of the speed limit specified for the tire chains being used, or 30 mph (50 km/h), whichever is lower.
- Avoid driving on bumpy road surfaces or over potholes.
- Avoid sudden turns and braking, as use of chains may adversely affect vehicle handling.
- Slow down sufficiently before entering a curve to ensure that vehicle control is maintained.

 NOTICE

■ **Repairing or replacing snow tires**

Request repairs of and obtain replacement snow tires from Toyota dealers or legitimate tire retailers.

This is because the removal and attachment of snow tires affects the operation of the tire pressure warning valves and transmitters.

■ **Fitting tire chains**

The tire pressure warning valves and transmitters may not function correctly when tire chains are fitted.

امداد خودرو فارما

تلفن شبانه روزی: ۰۲۱-۸۸۸۶۲۰۸۵

FarmaSOS.com



## 2-5. Driving information Trailer towing

**Your vehicle is designed primarily as a passenger-and-load carrying vehicle. Towing a trailer will have an adverse effect on handling, performance, braking, durability, and fuel consumption. For your safety and the safety of others, do not overload the vehicle or trailer.**

**To tow a trailer safely, use extreme care and drive the vehicle in accordance with the trailer's characteristics and operating conditions.**

**The vehicle stability and braking performance are affected by trailer stability, brake setting and performance, and the hitch.**

**Toyota warranties do not apply to damage or malfunction caused by towing a trailer for commercial purposes.**

Contact your Toyota dealer for further information about additional requirements such as a towing kits, etc.

2

When driving

تلفن شبانه روزی: ۰۲۱-۸۸۸۶۲۰۸۵

FarmaSOS.com

### Weight limits

Confirm that the gross trailer weight, gross combined weight, gross vehicle weight, gross axle weight and trailer tongue load are all within the limits.

- The gross trailer weight must never exceed 8500 lb. (3856 kg).
- The gross combined weight must never exceed 14550 lb. (6600 kg).

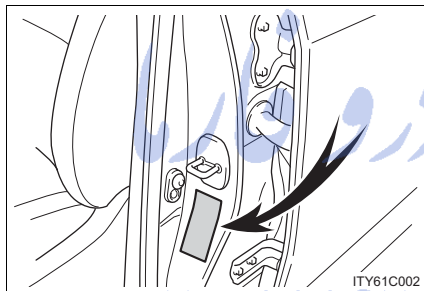

- The gross vehicle weight must never exceed the GVWR indicated the Certification Label.
- The gross axle weight on each axle must never exceed the GAWR indicated the Certification Label.

تلفن شبانه روزی: ۰۲۱-۸۸۸۶۲۰۸۵

FarmaSOS.com

**Towing related term**

Towing related term	Meaning
GVWR (Gross Vehicle Weight Rating)	The maximum allowable gross vehicle weight. The gross vehicle weight is the total weight of the vehicle. When towing a trailer, it is the sum of the vehicle weight (including the occupants, cargo and any optional equipment installed on the vehicle) and the tongue load.
GAWR (Gross Axle Weight Rating)	The maximum allowable gross axle weight. The gross axle weight is the load placed on each axle (front and rear).
GCWR (Gross Combination Weight Rating)	The maximum allowable gross combination weight. The gross combination weight is the sum of the total vehicle weight (including the occupants, cargo and any optional equipment installed on the vehicle) and the weight of the trailer being towed (including the cargo in the trailer).
Gross trailer weight	The sum of the trailer weight and the weight of the cargo in the trailer.
Towing capacity	The maximum allowable gross trailer weight. Towing capacity is calculated considering base vehicle with necessary vehicle equipment and occupants. Additional optional equipment, passengers and cargo in the vehicle will reduce the towing capacity, gross trailer weight includes the trailer, cargo and necessary equipment for towing.
Tongue load	The load placed on the trailer hitch ball.

2

When driving

### Trailer tongue load

- A recommended tongue load varies in accordance with the types of trailers or towing as described below.
- In order to ensure the recommended values shown below, the trailer must be loaded by referring to the following instructions. The trailer cargo load should be distributed so that the tongue load is 9 to 11 %.

$$(\text{Tongue load} / \text{Gross trailer weight} \times 100 = 9 \text{ to } 11 \%)$$

If the gross trailer weight is over 2000 lbs. (900 kg), it is necessary to use a sway control device with sufficient capacity.

If the gross trailer weight is over 5000 lbs. (2268 kg), it is necessary to use a weight distributing hitch with sufficient capacity.

If using a weight distributing hitch when towing, keep your vehicle level with the ground.

The gross trailer weight and tongue load can be measured with platform scales found at a highway weighing station, building supply company, trucking company, junk yard, etc.

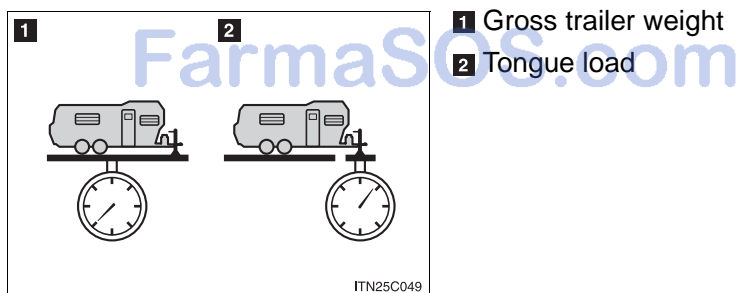

**Removing hitch cover**

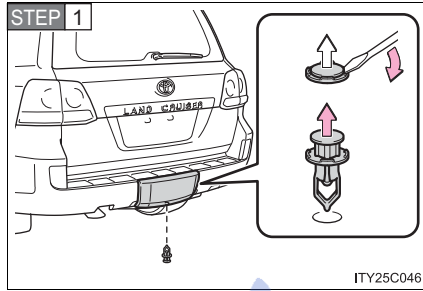

Remove the clip.

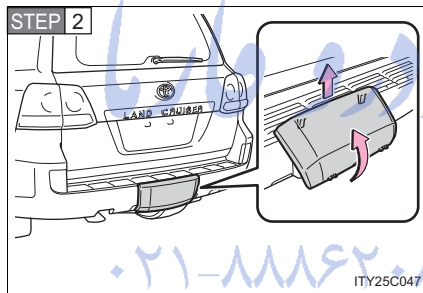

Grasp the lower edge of the hitch cover and raise the cover.

When reattaching the cover, reverse the steps listed.

2

When driving

تلفن شبانه روزی: ۰۲۱-۸۸۶۲۰۱۵

FarmaSOS.com

### Selecting trailer ball

Use the correct trailer ball for your application.

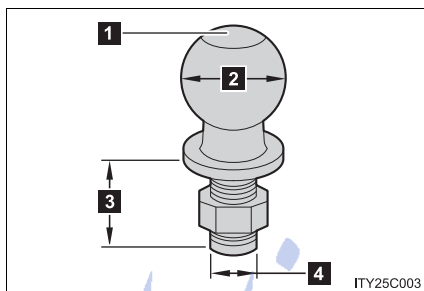

**1** Trailer ball load rating

Matches or exceeds the gross trailer weight rating of the trailer.

**2** Ball diameter

Matches the size of the trailer coupler. Most couplers are stamped with the required trailer ball size.

**3** Shank length

Protrudes beyond the bottom of the lock washer and nut at least 2 threads.

**4** Shank diameter

Matches the ball mount hole diameter size.

### Connecting trailer lights

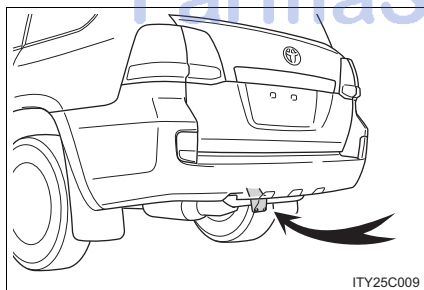

Use the wire harness stored in the rear end under body.

### Trailer towing tips

Your vehicle will handle differently when towing a trailer. In order to avoid accident, death or serious injury, keep the following in mind when towing:

- Before starting out, check the trailer lights and the vehicle-trailer connections. Recheck after driving a short distance.
- Practice turning, stopping and reversing with the trailer attached in an area away from traffic until you become accustomed to the feel of the vehicle.
- Reversing with a trailer attached is difficult and requires practice. Grip the bottom of the steering wheel and move your hand to the left to move the trailer to the left. Move your hand to the right to move the trailer to right. (This is generally opposite to reversing without a trailer attached.) Avoid sharp or prolonged turning. Have someone guide you when reversing to reduce the risk of an accident.
- As stopping distance is increased when towing a trailer, vehicle-to-vehicle distance should be increased. For each 10 mph (16 km/h) of speed, allow at least one vehicle and trailer length.
- Avoid sudden braking as you may skid, resulting in jackknifing and loss of control. This is especially true on wet or slippery surfaces.
- Avoid jerky starts or sudden acceleration.
- Avoid jerky steering and sharp turns, and slow down before making turns.

2

When driving

## 2-5. Driving information

- Note that when making a turn, the trailer wheels will be closer than the vehicle wheels to the inside of the turn. Compensate by making a larger than normal turning radius.
- Crosswinds and rough roads will adversely affect handling of your vehicle and trailer, causing sway. Periodically check the rear to prepare for being passed by large trucks or buses, which may cause your vehicle and trailer to sway. If swaying occurs, firmly grip the steering wheel, reduce speed immediately but gradually, and steer straight ahead. Never increase speed. If you make no extreme correction with the steering or brakes, your vehicle and trailer will stabilize.
- Take care when passing other vehicles. Passing requires considerable distance. After passing a vehicle, do not forget the length of your trailer, and be sure you have plenty of room before changing lanes.
- In order to maintain engine braking efficiency when driving on a long steep downgrade, do not use overdrive. Transmission shift range position must be in "4", in "S" mode.
- Due to the added load of the trailer, your vehicle's engine may overheat on hot days (at temperatures over 85°F [30°C] when driving up a long or steep grade. If the engine coolant temperature gauge indicates overheating, immediately turn off the air conditioning (if in use), pull your vehicle off the road and stop in a safe spot. (→P. 541)



- Always place wheel blocks under both the vehicle and the trailer wheels when parking. Apply the parking brake firmly, and put the transmission in “P”. Avoid parking on a slope, but if unavoidable, do so only after performing the following:

**STEP 1** Apply the brakes and keep them applied.

**STEP 2** Have someone place wheel blocks under both the vehicle and trailer wheels.

**STEP 3** When the wheel blocks are in place, release the brakes slowly until the blocks absorb the load.

**STEP 4** Apply the parking brake firmly.

**STEP 5** Shift into “P” and turn off the engine.

- When restarting after parking on a slope:

**STEP 1** With the transmission in the “P” position, start the engine. Be sure to keep the brake pedal pressed.

**STEP 2** Shift into “3”, “2”, “1”, or “R” position (if reversing).

**STEP 3** Release the parking brake and brake pedal, and slowly pull or back away from the wheel blocks. Stop and apply the brakes.

**STEP 4** Have someone retrieve the blocks.

FarmaSOS.com

---

■ **Before towing**

Check that the following conditions are met:

- The vehicle's tires are properly inflated.
- Trailer tires are inflated according to the trailer manufacturer's recommendation.
- All trailer lights work.
- All lights work each time you connect them.
- The trailer ball is set up at the proper height for the coupler on the trailer.
- The vehicle remains level when a loaded or unloaded trailer is hitched. Do not drive if the vehicle is not level, and check for improper tongue load, overloading, worn suspension, or other possible causes.
- The trailer cargo is securely loaded.
- The rear view mirrors conform to all applicable federal, state/provincial or local regulations. If they do not, install rear view mirrors appropriate for towing purposes.

■ **Break-in schedule**

Toyota recommends that you do not use a new vehicle or a vehicle with any new power train components (engine, transmission, differential, wheel bearings, etc.) to tow a trailer for the first 500 miles (800 km) of driving.

■ **Maintenance**

- If you tow a trailer, your vehicle will require more frequent maintenance due to the additional load. (See "Scheduled Maintenance Guide" or "Owner's Manual Supplement".)
- Retighten the fixing bolts of the towing ball after approximately 600 miles (1000 km) of trailer towing.

**⚠ CAUTION****■ Trailer towing precautions**

- Follow all the instructions described in this section. Failure to do so could cause an accident resulting in death or serious injury.
- Exceeding the towing capacity, GVWR, GCWR and GAWR can cause an accident resulting in death or serious personal injuries.

**■ To avoid accident or injury**

- Do not exceed 45 mph (72 km/h) or the posted towing speed limit, whichever is lower. As instability (swaying) of the towing vehicle-trailer combination increases as speed increases, exceeding 45 mph (72 km/h) may cause loss of control.
- Slow down and downshift before descending steep or long downhill grades. Do not make sudden downshifts.
- Avoid holding the brake pedal down too long or applying the brakes too frequently. This could cause the brakes to overheat and result in reduced braking efficiency.
- Do not exceed the trailer hitch assembly weight, gross vehicle weight, gross axle weight and trailer tongue load capacities.
- Never load more weight in the back than in the front of the trailer. About 60% of the load should be in the front half of the trailer, and the remaining 40% in the rear.
- Do not use cruise control when you are towing.

2

When driving

 CAUTION

■ Hitches

- Lubricate the hitch ball with a light coat of grease.
- If using a weight distributing hitch when towing, keep your vehicle level with the ground.

■ When towing a trailer

- If the gross trailer weight exceeds 1000 lb. (453 kg), trailer brakes are required. Toyota recommends trailers with brakes that conform to all applicable federal and state/provincial regulations.
- Never tap into your vehicle's hydraulic system, as this will lower the vehicle's braking effectiveness.
- Never tow a trailer without using a safety chain securely attached to both the trailer and the vehicle. If damage occurs to the coupling unit or hitch ball, there is danger of the trailer wandering into another lane.

 NOTICE

■ When installing a trailer hitch

- Use only the position recommended by your Toyota dealer. Do not install the trailer hitch on the bumper; this may cause body damage.
- Do not use axle-mounted hitches, as they can cause damage to the axle housing, wheel bearings, wheels or tires.

■ Safety chain

A safety chain must always be used between the towing vehicle and the trailer. Leave sufficient slack in the chain for turns. The chain should cross under the trailer tongue to prevent the tongue from dropping to the ground in the case that it becomes damaged or separated. For the correct safety chain installation procedure, ask your Toyota dealer.

■ Do not directly splice trailer lights

Directly splicing trailer lights may damage your vehicle's electrical system and cause a malfunction.

## 2-5. Driving information Dinghy towing

Your vehicle is not designed to be dinghy towed (with 4 wheels on the ground) behind a motor home.

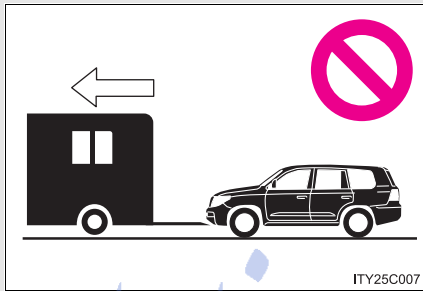

 NOTICE

■ **To avoid serious damage to your vehicle**

Do not tow your vehicle with four wheels on the ground.

تلفن شبانه روزی: ۰۲۱-۸۸۶۲۰۸۵

FarmaSOS.com

2

When driving

**3-1. Using the air conditioning system and defogger**

Front air conditioning system .....	248
Rear air conditioning system .....	258
Rear window and outside rear view mirror defoggers .....	262
Windshield wiper de-icer .....	263

**3-2. Using the audio system**

Audio system type .....	264
Using the radio .....	267
Using the CD player .....	276
Playing back MP3 and WMA discs .....	284
Operating an iPod .....	291
Operating a USB memory .....	298
Optimal use of the audio system .....	306
Using the AUX port .....	308
Using the steering switches .....	309

**3-3. Using the Bluetooth® audio system**

- Bluetooth® audio system..... 313
- Using the Bluetooth® audio system..... 316
- Operating a Bluetooth® enabled portable player ..... 322
- Setting up a Bluetooth® enabled portable player ..... 325
- Bluetooth® audio system setup ..... 332

**3-4. Using the hands-free system (for cellular phone)**

- Hands-free system (for cellular phone)..... 333
- Using the hands-free system ..... 337
- Making a phone call ..... 345
- Setting a cellular phone ... 350
- Security and system setup ..... 356
- Using the phone book ..... 362

**3-5. Using the interior lights**

- Interior lights list ..... 371
- Interior lights ..... 372
- Personal lights ..... 373

**3-6. Using the storage features**

- List of storage features .... 374
- Glove box..... 375
- Console box ..... 376
- Overhead console..... 377
- Cup holders ..... 378
- Bottle holders ..... 379
- Card holders ..... 381
- Auxiliary box ..... 381

**3-7. Other interior features**

- Cool box ..... 382
- Sun visors ..... 384
- Vanity mirror..... 385
- Clock ..... 386
- Outside temperature display ..... 387
- Ashtrays ..... 388
- Cigarette lighter..... 390
- Power outlets ..... 391
- Seat heaters..... 393
- Armrest ..... 395
- Floor mats ..... 396
- Luggage compartment features ..... 397
- Garage door opener..... 399
- Safety Connect ..... 406

### 3-1. Using the air conditioning system and defogger Front air conditioning system\*

**Airflow and outlets are automatically adjusted according to the temperature setting.**

▶ **With navigation system**

Owners of models equipped with a navigation system should refer to the “Navigation System Owner’s Manual”.

▶ **Without navigation system**

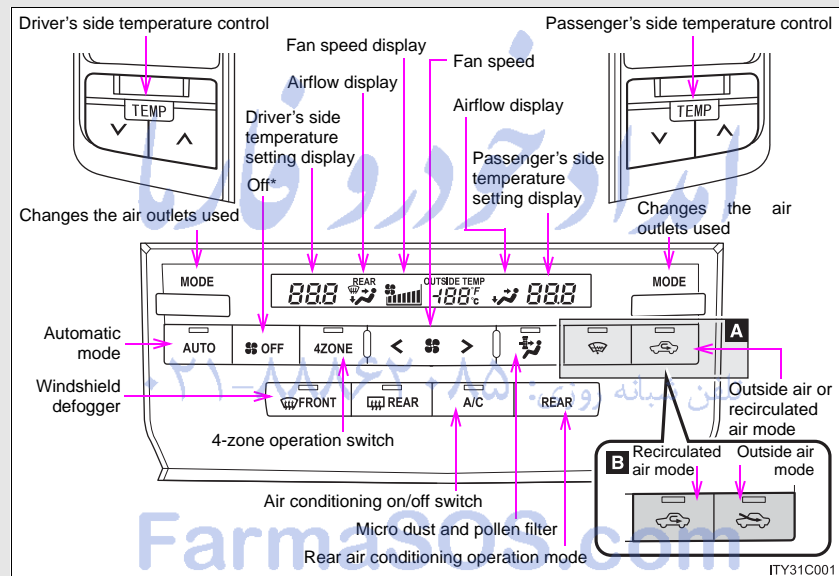

**A** Vehicles with windshield wiper de-icer

**B** Vehicles without windshield wiper de-icer

\*: The front air conditioning system cannot be switched off while the cool box is on. (→P. 382)

\*: If equipped



### 3-1. Using the air conditioning system and defogger

#### Using the automatic mode

**STEP 1** Press .

The air conditioning system will begin to operate. Air outlets and fan speed are automatically adjusted according to the temperature setting.

**STEP 2** Press “^” to increase the temperature and “v” to decrease the

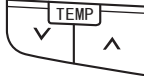
temperature on .

The temperature for the driver's and front passenger's seats can be set separately.

امداد خودرو فارما

تلفن شبانه روزی: ۰۲۱-۸۸۸۶۲۰۸۵

FarmaSOS.com

3

Interior features

### Adjusting the settings

#### ■ Adjusting the temperature setting

Press “^” to increase the temperature and “v” to decrease the temperature on

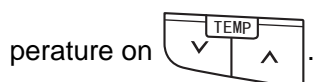

The air conditioning system switches between individual and simultaneous modes each time  is pressed.

Individual mode (the indicator on  is on.): The temperature for the driver's, front passenger's and rear seats (→P. 253) can be set separately. Operating the passenger's side or rear temperature control will enter individual mode.

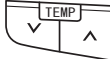
Simultaneous mode (the indicator on  is off.): Only  (driver's side) can be used to adjust the temperature for all seats.

#### ■ Adjusting the fan speed

Press “>” (increase) or “<” (decrease) on .

The fan speed is shown on the display. (7 levels)

Press  to turn the fan off.

### 3-1. Using the air conditioning system and defogger

#### ■ Changing the air outlets

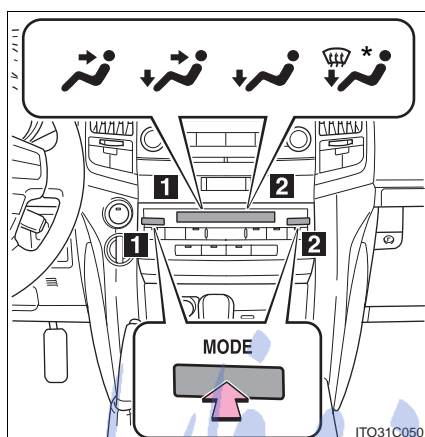

Press .

- 1** For driver's seat
- 2** For front passenger's seat

The air outlets switch each time the button is pressed.

Different air outlets for the driver's and front passenger's seats can be chosen.

\*: Driver side only

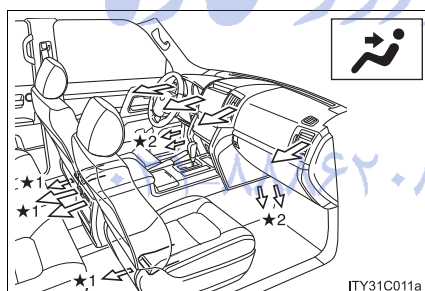

Air flows to the upper body.

\*1: Depending on the rear air conditioning setting.

\*2: Only in the automatic mode

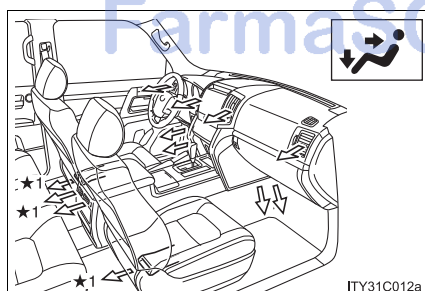

Air flows to the upper body and feet.

\*1: Depending on the rear air conditioning setting.

### 3-1. Using the air conditioning system and defogger

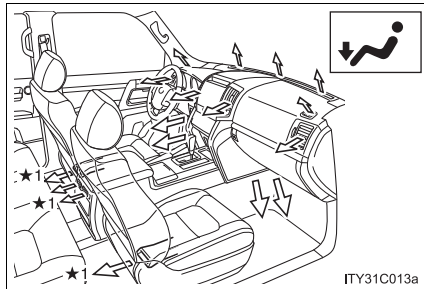

Air flows to the feet.

\*1: Depending on the rear air conditioning setting.

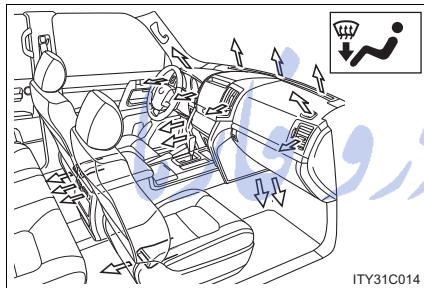

Air flows to the feet and the windshield defogger operates.

#### ■ Switching between outside air and recirculated air modes

- ▶ Vehicles with windshield wiper de-icer تلفن شبانه روزی

Press .

The mode switches between outside air mode (indicator off) and recirculated air mode (indicator on) each time the button is pressed.

- ▶ Vehicles without windshield wiper de-icer

Press  to switch to recirculated air mode and press

 to switch to outside air mode.

### Changing the rear seat settings from the front seat

#### ■ Adjusting the temperature setting

**STEP 1** Press  .

**STEP 2** Press “^” to increase the temperature and “v” to decrease the

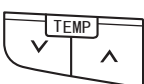
temperature on  (for left-hand rear seat) and

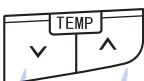
 (for right-hand rear seat).

The temperature for the right-hand and left-hand rear seats can be adjusted separately. Operating the switch will enter individual mode.

The air conditioning system switches between individual and simultaneous modes each time  is pressed.

#### ■ Adjusting the fan speed

**STEP 1** Press  .

**STEP 2** Press “>” (increase) or “<” (decrease) on  .

The fan speed is shown on the display. (7 levels)

Press  to turn the fan off.

### 3-1. Using the air conditioning system and defogger

#### ■ Changing the air outlets

**STEP 1** Press  .

**STEP 2** Press  .

The air outlets switch each time the button is pressed. (→P. 251)

#### Defogging the windshield

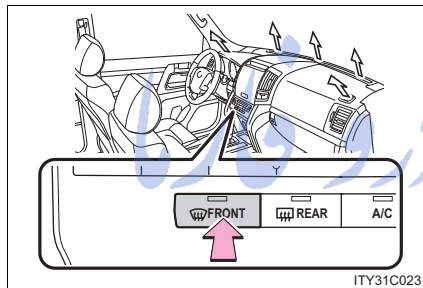

Press  .

The air conditioning system control operates automatically.

Recirculated air mode will automatically switch to outside air mode.

#### Micro dust and pollen filter

Press  .

Outside air mode switches to recirculated air mode. Pollen is removed from the air and the air flows to the upper part of the body.

Usually the system will turn off automatically approximately 3 minutes later.

To stop the operation, press  again.

**Adjusting the position and opening and closing the air outlets**

► Front center outlets

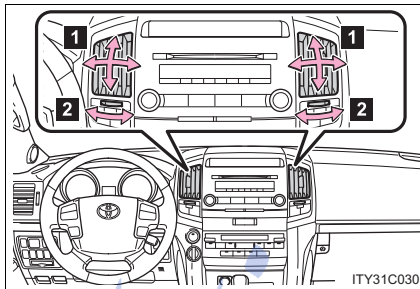

- 1 Direct air flow to the left or right, up or down.
- 2 Turn the knob to open or close the vent.

► Front side outlets

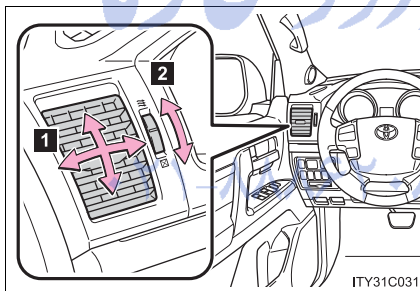

- 1 Direct air flow to the left or right, up or down.
- 2 Turn the knob to open or close the vent.

► Rear center outlets

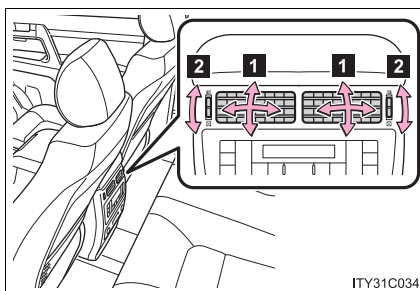

- 1 Direct air flow to the left or right, up or down.
- 2 Turn the knob to open or close the vent.

### 3-1. Using the air conditioning system and defogger

#### ■ Using the automatic mode

Fan speed is adjusted automatically in accordance with the temperature setting and ambient conditions. As a result, the following may occur.

- Immediately after  is pressed, the fan may stop for a while until warm or cool air is ready to flow.
- Cool air may flow to the area around the upper body when the heater is on.

#### ■ Using the system in recirculated air mode

The windows will fog up more easily if the recirculated air mode is used for an extended period.

#### ■ Switching between outside air and recirculated air modes

Recirculated air mode or outside air mode may be automatically switched to in accordance with the temperature setting and the inside temperature.

#### ■ Window defogger feature

Recirculated air mode may automatically switch to outside air mode in situations where the windows need to be defogged.

#### ■ When driving on dusty roads

Close all windows. If dust thrown up by the vehicle is still drawn into the vehicle after closing the windows, it is recommended that the air intake mode be set to outside air mode and the fan speed to any setting except off.

#### ■ When outside temperature approaches 32°F (0°C)

The air conditioning system may not operate even when  is pressed.

#### ■ Micro dust and pollen filter

- In order to prevent the windows from fogging up when the outside air is cold, the following may occur.
  - Outside air mode does not switch to recirculated air mode.
  - The air conditioning system operates automatically.
  - The operation cancels after 1 minute.
- In rainy weather, the windows may fog up. press .



■ **Air conditioning odors**

- During use, various odors from inside and outside the vehicle may enter into and accumulate in the air conditioning system. This may then cause odor to be emitted from the vents.
- To reduce potential odors from occurring:
  - It is recommended that the air conditioning system be set to outside air mode prior to turning the vehicle off.
  - The start timing of the blower may be delayed for a short period of time immediately after the air conditioning system is started in automatic mode.

■ **Customization that can be configured at Toyota dealer**

Settings (e.g. A/C Auto switch operation) can be changed.  
(Customizable features →P. 573)

 **CAUTION**

■ **To prevent the windshield from fogging up**

Do not use  during cool air operation in extremely humid weather. The difference between the temperature of the outside air and that of the windshield can cause the outer surface of the windshield to fog up, blocking your vision.

 **NOTICE**

■ **To prevent battery discharge**

Do not leave the air conditioning system on longer than necessary when the engine is stopped.

### 3-1. Using the air conditioning system and defogger Rear air conditioning system

**Airflow and outlets are automatically adjusted according to the temperature setting.**

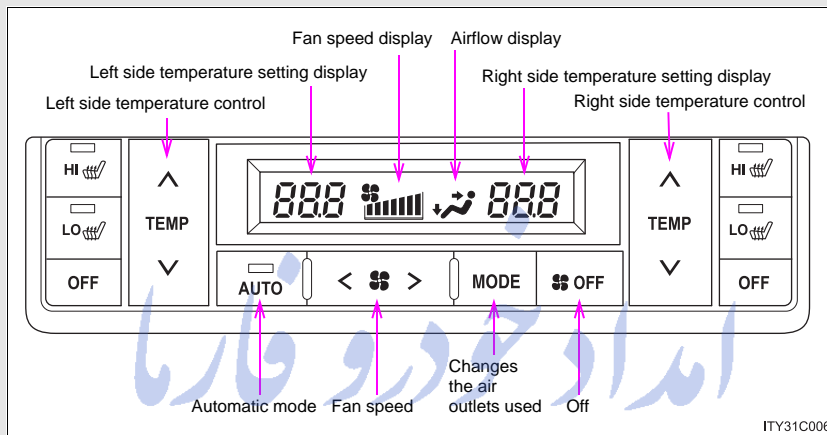

#### Using the automatic mode

**STEP 1** Press .

The air conditioning system will begin to operate. Air outlets and fan speed are automatically adjusted according to the temperature setting.

**STEP 2** Press “^” to increase the temperature and “v” to decrease the

temperature on .

The temperature for the right-hand and left-hand rear seats can be set separately.

### Adjusting the settings

#### ■ Adjusting the temperature setting

Press “^” to increase the temperature and “v” to decrease the tem-

perature on



The temperature for the right-hand and left-hand rear seats can be set separately.

#### ■ Adjusting the fan speed

Press “>” (increase) or “<” (decrease) on .

The fan speed is shown on the display. (7 levels)

Press  to turn the fan off.

#### ■ Changing the air outlets

Press .

The air outlets switch each time the button is pressed.

3-1. Using the air conditioning system and defogger

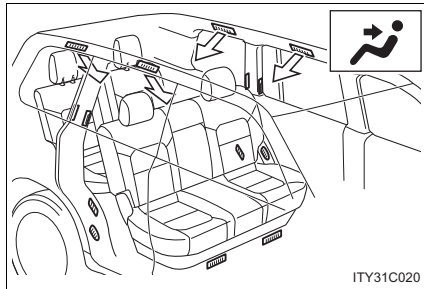

Air flows to the upper body.

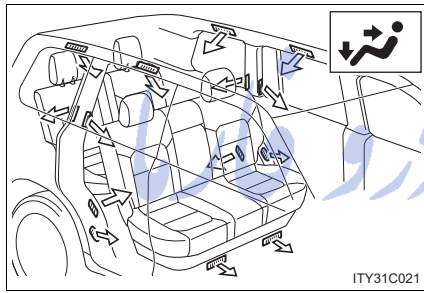

Air flows to the upper body and feet.

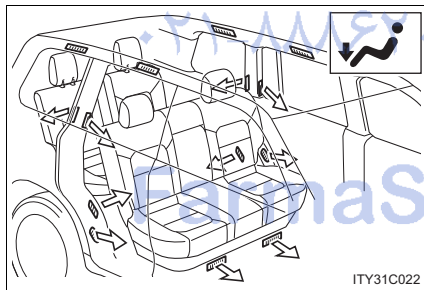

Air flows to the feet.

### Adjusting the position and opening and closing the air outlets

#### ► Rear center outlets

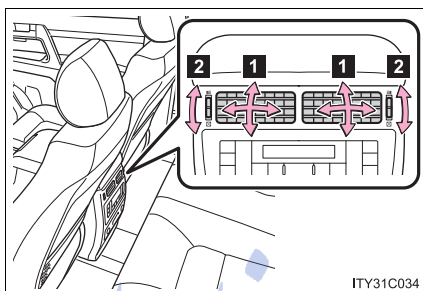

- 1 Direct air flow to the left or right, up or down.
- 2 Turn the knob to open or close the vent.

#### ► Roof side outlets

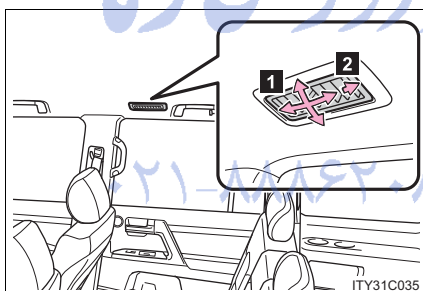

- 1 Direct air flow to the left or right, up or down.
- 2 Turn the knob fully to the back of the vehicle to close the vent.

#### ⚠ NOTICE

##### ■ To prevent battery discharge

Do not leave the air conditioning system on longer than necessary when the engine is stopped.

### 3-1. Using the air conditioning system and defogger Rear window and outside rear view mirror defoggers

These features are used to defog the rear window, and to remove raindrops, dew and frost from the outside rear view mirrors.

#### ► With navigation system

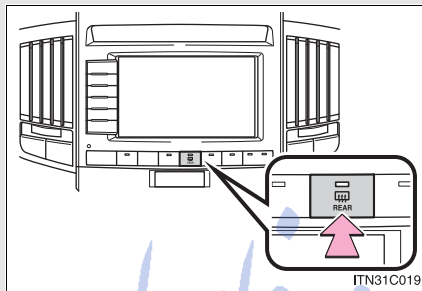

#### On/off

The operation time changes according to the ambient temperature and vehicle speed. Pressing the switch again also turns the defoggers off.

#### ► Without navigation system

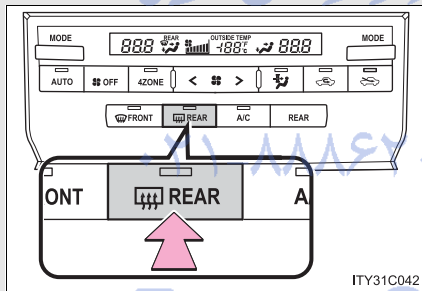

#### ■ The rear window and outside rear view mirror defoggers can be operated when

The "ENGINE START STOP" switch is in IGNITION ON mode.

#### ⚠ CAUTION

#### ■ When the outside rear view mirror defoggers are on

Do not touch the rear view mirror surfaces, as they can become very hot and burn you.

### 3-1. Using the air conditioning system and defogger Windshield wiper de-icer\*

This feature is used to prevent ice from building up on the windshield and wiper blades.

#### ► With navigation system

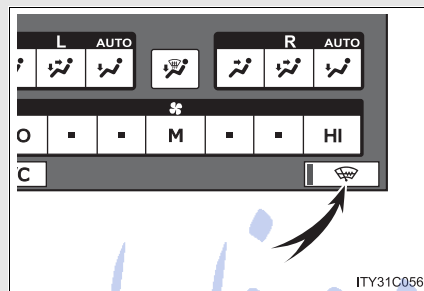

#### On/off

The windshield wiper de-icer will automatically turn off after approximately 15 minutes. Pressing the switch again also turns the de-icer off.

#### ► Without navigation system

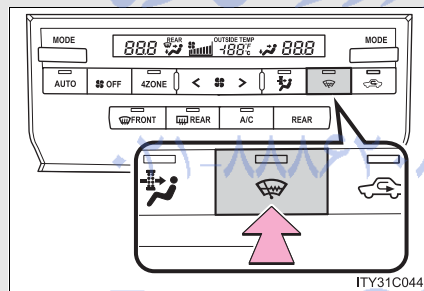

3

Interior features

#### ■ The windshield wiper de-icer can be operated when

The "ENGINE START STOP" switch is in IGNITION ON mode.

#### ⚠ CAUTION

#### ■ When the windshield wiper de-icer is on

Do not touch the glass at the lower part of the windshield or to the side of the front pillars as the surfaces can become very hot and burn you.

\*: If equipped

263

### 3-2. Using the audio system

#### Audio system type

- ▶ With navigation system  
Owners of models equipped with a navigation system should refer to the “Navigation System Owner’s Manual”.
- ▶ Without navigation system  
CD player with changer and AM/FM radio.
- Type A

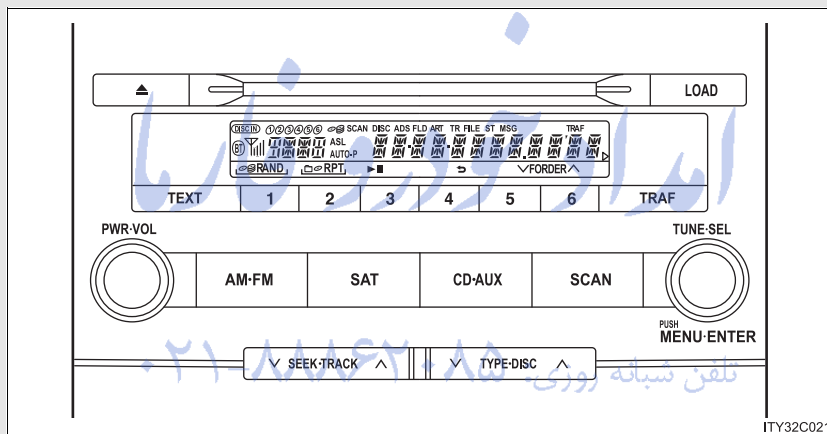

FarmaSOS.com



### 3-2. Using the audio system

#### ● Type B

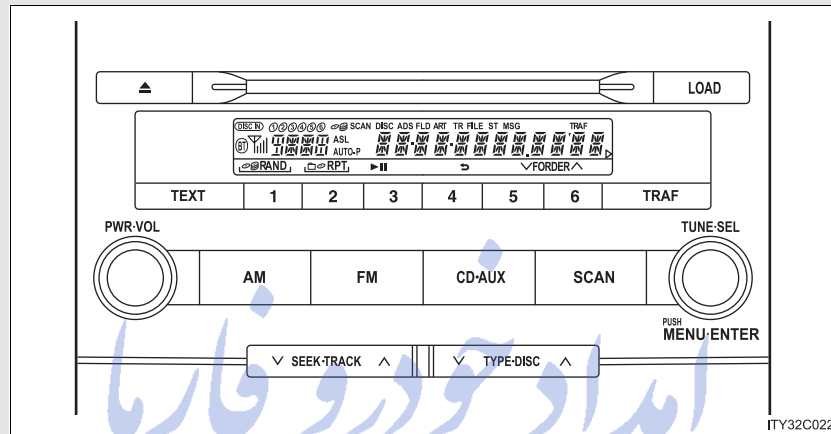

Title	Page
Using the radio	P. 267
Using the CD player	P. 276
Playing back MP3 and WMA discs	P. 284
Operating an iPod	P. 291
Operating a USB memory	P. 298
Optimal use of the audio system	P. 306
Using the AUX port	P. 308
Using the steering switches	P. 309

## 3-2. Using the audio system

### ■ Using cellular phones

Interference may be heard through the audio system's speakers if a cellular phone is being used inside or close to the vehicle while the audio system is operating.

#### CAUTION

##### ■ For vehicles sold in the U.S.A.

###### ● Part 15 of the FCC Rules

FCC Warning:

Any unauthorized changes or modifications to this equipment will void the user's authority to operate this device.

###### ● Laser products

- Do not take this unit apart or attempt to make any changes yourself. This is an intricate unit that uses a laser pickup to retrieve information from the surface of compact discs. The laser is carefully shielded so that its rays remain inside the cabinet. Therefore, never try to disassemble the player or alter any of its parts since you may be exposed to laser rays and dangerous voltages.
- This product utilizes a laser. Use of controls or adjustments or performance of procedures other than those specified herein may result in hazardous radiation exposure.

#### NOTICE

##### ■ To prevent battery discharge

Do not leave the audio system on longer than necessary with the engine off.

##### ■ To avoid damaging the audio system

Take care not to spill drinks or other fluids over the audio system.

3-2. Using the audio system  
Using the radio

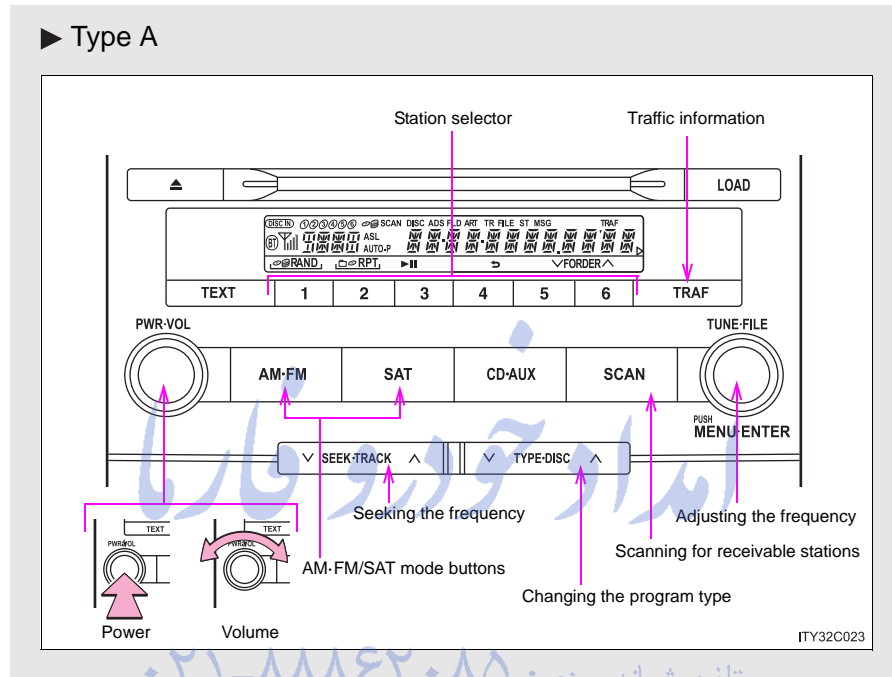

3

Interior features

تلفن شبانه روزی: ۰۲۱-۸۸۶۲۰۸۵

FarmaSOS.com

3-2. Using the audio system



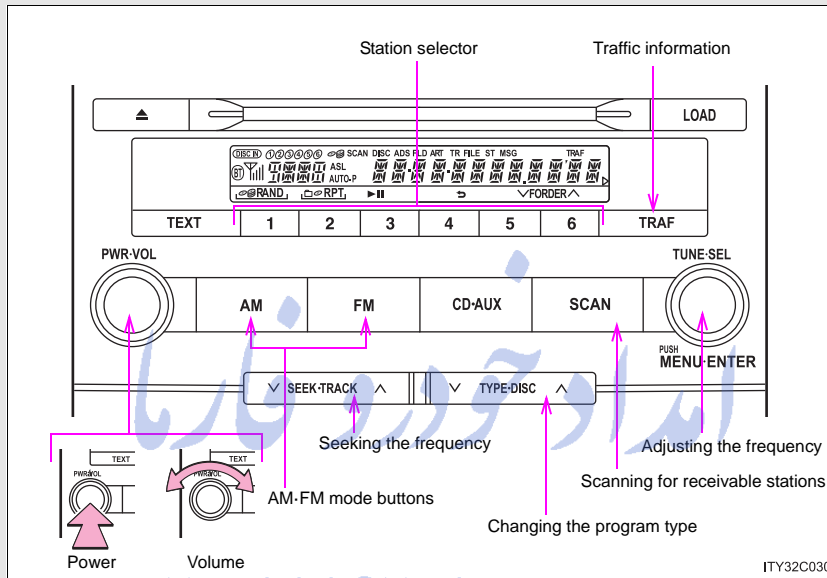

► Type B





تلفن شبانه روزی: ۰۲۱-۸۸۸۶۲۰۸۵

FarmaSOS.com



**Setting station presets (excluding XM® Satellite Radio)**

- STEP 1** Search for desired stations by turning  or pressing “^” or “v” on  .
- STEP 2** Press and hold the button (from  to  ) the station is to be set to, and you hear a beep.

**Scanning radio stations (excluding XM® Satellite Radio)****■ Scanning the preset radio stations**

- STEP 1** Press and hold  until you hear a beep.  
Preset stations will be played for a few seconds each.
- STEP 2** When the desired station is reached, press  once again.

**■ Scanning all radio stations within range**

- STEP 1** Press  .  
“SCAN” appears on the display and all stations with reception will be played for a few seconds each.
- STEP 2** When the desired station is reached, press  once again.

### XM® Satellite Radio (type A)



#### ■ Receiving XM® Satellite Radio

**STEP 1** Press  .



The display changes as follows each time the button is pressed.

“SAT1” → “SAT2” → “SAT3”



**STEP 2** Turn  to select a desired channel from all the categories or press “^” or “v” on  to select a desired channel in the current category.

#### ■ Presetting XM® Satellite Radio channels

Select the desired channel. Press and hold the button (from  to ) until you hear a beep.

#### ■ Changing the channel category

Press “^” or “v” on  .

#### ■ Scanning XM® Satellite Radio channels

- Scanning channels in the current category

**STEP 1** Press  .

**STEP 2** When the desired channel is reached, press the button again.

- Scanning preset channels

**STEP 1** Press and hold  until you hear a beep.

**STEP 2** When the desired channel is reached, press the button again.

### RDS (Radio Data System)

This feature allows your radio to receive station identification information and program information (classical, jazz, etc.) from radio stations which broadcast this information.

#### ■ Receiving RDS broadcasts

**STEP 1** Press “^” or “v” on the  during FM reception. The type of program changes each time the button is pressed.

- ROCK
- EASYLIS (Easy listening)
- CLS/JAZZ (Classical music and Jazz)
- R & B (Rhythm and Blues)
- INFORM (Information)
- RELIGION
- MISC (Miscellaneous)
- ALERT (Emergency messages)

**STEP 2** Press , or “^” or “v” on .

The radio seeks scans the station by the relevant program type.

If no radio station of that type is found, “NOTHING” appears on the display.

#### ■ Displaying radio station names

Press .

### 3-2. Using the audio system

#### ■ Displaying radio text messages

Press .

If MSG is shown on the display, a text message will be displayed.

If the text continues past the end of the display, ► is displayed. Press and hold  until you hear a beep.

#### ■ Traffic announcement

Press .

“TRAF SEEK” appears on the display, and the radio will start seeking any station broadcasting traffic program information.

If no traffic program station is found, “NO TRAF INFO” appears on the display.

---

#### ■ When the battery is disconnected

All preset stations are erased.

#### ■ Reception sensitivity

- Maintaining perfect radio reception at all times is difficult due to the continually changing position of the antenna, differences in signal strength and surrounding objects, such as trains, transmitters, etc.
- The radio antenna is mounted inside the rear quarter window. To maintain clear radio reception, do not attach metallic window tinting or other metallic objects to the antenna wire mounted inside the rear quarter window.



■ **Receiving XM® Satellite Radio**

An XM® Satellite Radio is a tuner designed exclusively to receive broadcasts provided under a separate subscription. Availability is limited to the 48 contiguous states and some Canadian provinces.

● XM® subscriptions

For detailed information about XM® Satellite Radio or to subscribe: Visit on the web at [www.xmradio.com](http://www.xmradio.com) or call 1-800-967-2346.

● Radio ID

You will need the radio ID when activating XM® service or reporting a problem. Select "CH000" using , and the receiver's 8-character ID number will appear.

● Satellite tuner

The tuner supports only Audio Services (Music and Talk) and the accompanying Text Information of XM® Satellite Radio.

تلفن شبانه روزی: ۰۲۱-۸۸۶۲۰۸۵

FarmaSOS.com

### 3-2. Using the audio system

#### ■ If the satellite radio does not operate normally

If a problem occurs with the XM<sup>®</sup> tuner, a message will appear on the display. Refer to the table below to identify the problem, and take the suggested corrective action.

ANTENNA	The XM <sup>®</sup> antenna is not connected. Check whether the XM <sup>®</sup> antenna cable is attached securely.
	There is a short-circuit in the antenna or the surrounding antenna cable. See a Toyota certified dealer.
UNAUTH	You have not subscribed to XM <sup>®</sup> Satellite Radio. The radio is being updated with the latest encryption code. Contact XM <sup>®</sup> Satellite Radio for subscription information. When a contract is canceled, you can choose "CH000" and all free-to-air channels.
	The premium channel you selected is not authorized. Wait for about 2 seconds until the radio returns to the previous channel or "CH001". If it does not change automatically, select another channel. If you want to listen to the premium channel, contact XM <sup>®</sup> Satellite Radio.
NO SIGNAL	The XM <sup>®</sup> signal is too weak at the current location. Wait until your vehicle reaches a location with a stronger signal.
LOADING	The unit is acquiring audio or program information. Wait until the unit has received the information.
OFF AIR	The channel you selected is not broadcasting any programming. Select another channel.

-----	There is no song/program title or artist name/feature associated with the channel at that time. No action needed.
CH UNAVL	The channel you selected is no longer available. Wait for about 2 seconds until the radio returns to the previous channel or "CH001". If it does not change automatically, select another channel.

Contact the XM® Listener Care Center at 1-800-967-2346.

#### ■ Certifications for the radio tuner

This equipment has been tested and found to comply with the limits for a class B digital device, pursuant to Part 15 of the FCC Rules. These limits are designed to provide reasonable protection against harmful interference in a residential installation. This equipment generates, uses and can radiate radio frequency energy and, if not installed and used in accordance with the instructions, may cause harmful interference to radio communications. However, there is no guarantee that interference will not occur in a particular installation.

If this equipment does cause harmful interference to radio or television reception, which can be determined by turning the equipment off and on, the user is encouraged to try to correct the interference by trying one or more of the following:

- Reorienting or relocating the receiving antenna.
- Increasing the separation between the equipment and receiver.
- Connecting the equipment into an outlet on a circuit different from that to which the receiver is connected.
- Consulting the dealer or an experienced radio/TV technician for help.

## 3-2. Using the audio system Using the CD player

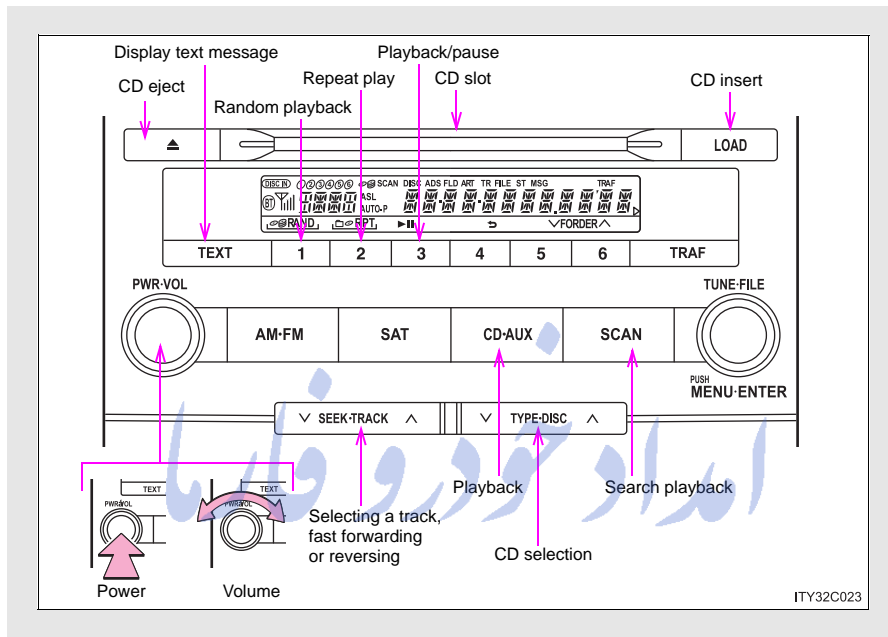

### Loading a CDs

#### ■ Loading a single CD

**STEP 1** Press .

“WAIT” appears on the display.

**STEP 2** Insert a CD when the indicator on the slot turns from amber to green.

The display changes from “WAIT” to “LOAD”.

### ■ Loading multiple CDs

**STEP 1** Press and hold  until you hear a beep.

“WAIT” appears on the display.

**STEP 2** Insert a CD when the indicator on the slot turns from amber to green.

The display changes from “WAIT” to “LOAD”.

The indicator on the slot turns to amber when the CD is inserted.

**STEP 3** Insert the next CD when the indicator on the slot turns from amber to green again.

Repeat the procedure for the remaining CDs.

To cancel the operation, press  or . If you do not insert a CD within 15 seconds, loading will be canceled automatically.

3

Interior features

### Ejecting CDs

#### ■ Ejecting a CD

**STEP 1** To select the CD to be ejected, press “^” or “v” on

.

The number of the CD selected is shown on the display.

**STEP 2** Press  and remove the CD.

#### ■ Ejecting all CDs

Press and hold  until you hear a beep, then remove the CDs.

### 3-2. Using the audio system

#### Selecting a CD

##### ■ To select a CD to play

Press “^” or “v” on  until the desired CD number appears on the display.

##### ■ To scan loaded CDs

**STEP 1** Press and hold  until you hear a beep.

The first 10 seconds of the first track on each CD will be played.

**STEP 2** Press  once again when the desired CD is reached.

#### Selecting a track

Press “^” to move up or “v” to move down using  until the desired track number appears on the display.

#### Playing and pausing tracks

To play or pause a track, press  (▶||). *تلفن شبانه روزی: ۰۲۱-۸۸۶۲۰۸۸*

#### Fast forwarding and rewinding tracks

Press and hold “^” or “v” on . *FarmasOS.com*

#### Scanning a CD

**STEP 1** Press .

“SCAN” appears on the display.

The first 10 seconds of each track will be played.

**STEP 2** Press  once again when the desired track is reached.

### Random playback

#### ■ Current CD

Touch  (RAND).

Tracks are played in random order until the button is pressed once again.

#### ■ All CDs

Press and hold  (RAND) until you hear a beep.

Tracks on all loaded CDs are played in random order until the button is pressed once again.

### Repeating a track or a disc

#### ■ Repeating a track

Press  (RPT).

#### ■ Repeating a disc

Press and hold  (RPT) until you hear a beep.

### Switching the display

Press .

Each time the button is pressed, the display changes in the order of Track no./Elapsed time → CD title → Track name.

### 3-2. Using the audio system

#### ■ Display

Up to 12 characters can be displayed at a time.

If there are 13 characters or more, pressing and holding  for 1 second or more will display the remaining characters.

A maximum of 24 characters can be displayed.

If  is pressed for 1 second or more again or has not been pressed for 6 seconds or more, the display will return to the first 12 characters.

Depending on the contents recorded, the characters may not be displayed properly or may not be displayed at all.

#### ■ Canceling random, repeat and scan playback

Press  (RAND),  (RPT) or  again.

#### ■ Error messages

“ERROR”: This indicates a trouble either in the CD or inside the player.  
The CD may be dirty, damaged or inserted up-side down.

تلفن شبانه روزی: ۰۲۱-۸۸۸۶۲۰۸۵

FarmaSOS.com



■ **Discs that can be used**

Discs with the marks shown below can be used.  
Playback may not be possible depending on recording format or disc features, or due to scratches, dirt or deterioration.



CDs with copy-protect features may not play correctly.

■ **CD player protection feature**

To protect the internal components, playback is automatically stopped when a problem is detected.

■ **If CDs are left inside the CD player or in the ejected position for extended periods**

CDs may be damaged and may not play properly.

■ **Lens cleaners**

Do not use lens cleaners. Doing so may damage the CD player.

تلفن شبانه روزی: ۰۲۱-۸۸۶۲۰۸۵

FarmaSOS.com

### 3-2. Using the audio system

#### NOTICE

##### ■ CDs and adapters that cannot be used

Do not use the following types of CDs, 3 in. (8 cm) CD adapters or Dual Disc.

Doing so may damage the player and/or the CD insert/eject function.

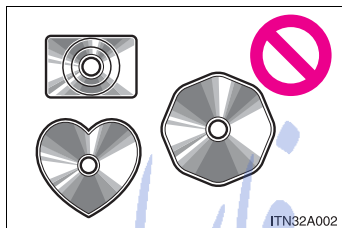

- CDs that have a diameter that is not 4.7 in. (12 cm).

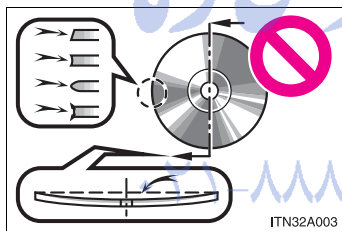

- Low-quality and deformed CDs.

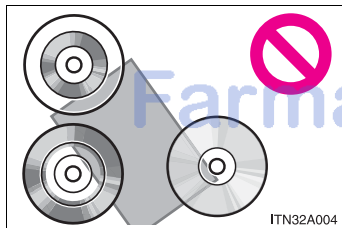

- CDs with a transparent or translucent recording area.

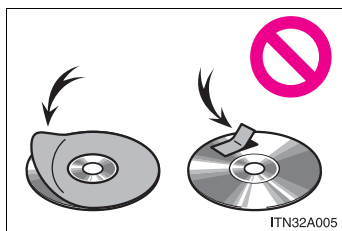

- CDs that have tape, stickers or CD-R labels attached to them, or that have the label peeled off.

 NOTICE

■ **Player precautions**

Failure to follow the precautions below may result in damage to the CDs or the player itself.

- Do not insert anything other than CDs into the CD slot.
- Do not apply oil to the player.
- Store CDs away from direct sunlight.
- Never try to disassemble any part of the player.

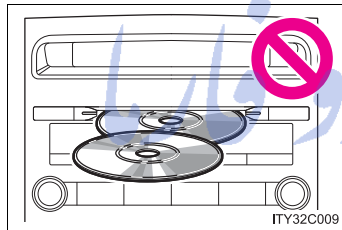

- Do not insert more than one CD at a time.

تلفن شبانه روزی: ۰۲۱-۸۸۶۲۰۸۵

FarmaSOS.com

## 3-2. Using the audio system Playing back MP3 and WMA discs

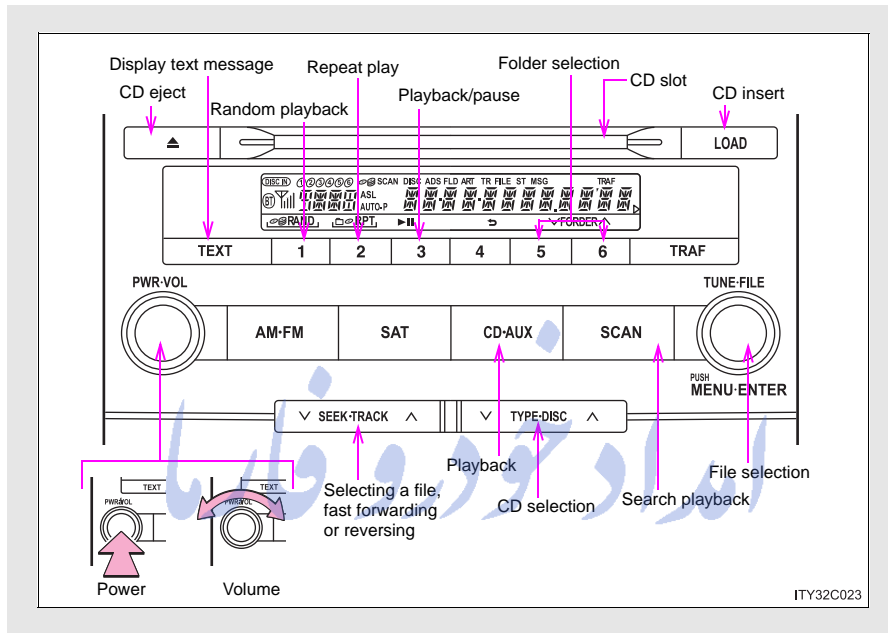

### Loading and ejecting MP3 and WMA discs

→P. 276

### Selecting a CD

→P. 276

### Playing and pausing files

To play or pause a file, press **3** (▶||).

### Selecting and scanning a folder

#### ■ Selecting folders one at a time

Press  (∨) or  (∧) to select the desired folder.

To return to the first folder, press and hold  (∨) until you hear a beep.

#### ■ Selecting the desired folder by cueing the first file of each folder

Press and hold  until you hear a beep.

When the desired folder is reached, press the switch once again.

### Selecting and scanning a file

#### ■ Selecting one file at a time

Turn the  dial or press “∧” or “∨” on  to select the desired file.

#### ■ Selecting the desired file by cueing the files in the folder

Press .

When the desired file is reached, press  once again.

### Fast forwarding and reversing files

Press and hold “∧” or “∨” on .

### 3-2. Using the audio system

#### Random playback

- **To play files from a particular folder in random order**

Press  (RAND).

- **To play all of the files on a disc in random order**

Press and hold  (RAND) until you hear a beep.

#### Repeating a file or a folder

- **Repeating a file**

Press  (RPT).

- **Repeating a folder**

Press and hold  (RPT) until you hear a beep.

#### Switching the display

Press .

Each time the switch is pressed, the display changes in the order of Folder no./File no./Elapsed time→Folder name→File name→Album title (MP3 only)→Track title→Artist name.

FarmaSOS.com

### ■ Display

→P. 280

### ■ Canceling random, repeat and scan playback

Press  (RAND),  (RPT) or  again.

### ■ Error messages

“ERROR”: This indicates a trouble either in the CD or inside the player. The CD may be dirty, damaged or inserted up-side down.

“NO MUSIC”: This indicates that the MP3/WMA file is not included in the CD.

### ■ Discs that can be used

Discs with the marks shown below can be used.

Playback may not be possible depending on recording format or disc features, or due to scratches, dirt or deterioration.



### ■ CD player protection feature

To protect the internal components, playback is automatically stopped when a problem is detected.

### ■ If CDs are left inside the CD player or in the ejected position for extended periods

CDs may be damaged and may not play properly.

### 3-2. Using the audio system

#### ■ Lens cleaners

Do not use lens cleaners. Doing so may damage the CD player.

#### ■ MP3 and WMA files

MP3 (MPEG Audio LAYER3) is a standard audio compression format.

Files can be compressed to approximately 1/10 of their original size by using MP3 compression.

WMA (Windows Media® Audio) is a Microsoft audio compression format.

This format compresses audio data to a size smaller than that of the MP3 format.

There is a limit to the MP3 and WMA file standards and to the media/formats recorded by them that can be used.

- MP3 file compatibility
  - Compatible standards  
MP3 (MPEG1 LAYER3, MPEG2 LSF LAYER3)
  - Compatible sampling frequencies  
MPEG1 LAYER3: 32, 44.1, 48 (kHz)  
MPEG2 LSF LAYER3: 16, 22.05, 24 (kHz)
  - Compatible bit rates  
MPEG1 LAYER3: 64, 80, 96, 112, 128, 160, 192, 224, 256, 320 (kbps)  
MPEG2 LSF LAYER3: 64, 80, 96, 112, 128, 144, 160 (kbps)  
\* Compatible with VBR
  - Compatible channel modes: stereo, joint stereo, dual channel and monaural
- WMA file compatibility
  - Compatible standards  
WMA Ver. 7, 8, 9
  - Compatible sampling frequencies  
32, 44.1, 48 (kHz)
  - Compatible bit rates  
Ver. 7, 8: CBR 48, 64, 80, 96, 128, 160, 192 (kbps)  
Ver. 9: CBR 48, 64, 80, 96, 128, 160, 192, 256, 320 (kbps)  
\* Only compatible with 2-channel playback



- Compatible media

Media that can be used for MP3 and WMA playback are CD-Rs and CD-RWs.

Playback in some instances may not be possible, depending on the status of the CD-R or CD-RW. Playback may not be possible or the audio may jump if the disc is scratched or marked with fingerprints.

- Compatible disc formats

The following disc formats can be used.

- Disc formats: CD-ROM Mode 1 and Mode 2  
CD-ROM XA Mode 2, Form 1 and Form 2
- File formats: ISO9660 Level 1, Level 2, (Romeo, Joliet)  
MP3 and WMA files written in any format other than those listed above may not play correctly, and their file names and folder names may not be displayed correctly.

Items related to standards and limitations are as follows.

- Maximum directory hierarchy: 8 levels
- Maximum length of folder names/file names: 32 characters
- Maximum number of folders: 192 (including the root)
- Maximum number of files per disc: 255
- File names  
The only files that can be recognized as MP3/WMA and played are those with the extension .mp3 or .wma.
- Multi-sessions  
As the audio system is compatible with multi-sessions, it is possible to play discs that contain MP3 and WMA files. However, only the first session can be played.
- ID3 and WMA tags  
ID3 tags can be added to MP3 files, making it possible to record the track title and artist name, etc.  
The system is compatible with ID3 Ver. 1.0, 1.1, and Ver. 2.2, 2.3 ID3 tags. (The number of characters is based on ID3 Ver. 1.0 and 1.1.)  
WMA tags can be added to WMA files, making it possible to record the track title and artist name in the same way as with ID3 tags.

### 3-2. Using the audio system

#### ● MP3 and WMA playback

When a disc containing MP3 or WMA files is inserted, all files on the disc are first checked. Once the file check is finished, the first MP3 or WMA file is played. To make the file check finish more quickly, we recommend you do not write in any files other than MP3 or WMA files or create any unnecessary folders.

If the discs contain a mixture of music data and MP3 or WMA format data, only music data can be played.

#### ● Extensions

If the file extensions .mp3 and .wma are used for files other than MP3 and WMA files, they will be mistakenly recognized and played as MP3 and WMA files. This may result in large amounts of interference and damage to the speakers.

#### ● Playback

- To play MP3 file with steady sound quality, we recommend a fixed bit rate of 128 kbps and a sampling frequency of 44.1 kHz.
- CD-R or CD-RW playback may not be possible in some instances, depending on the characteristics of the disc.
- There is a wide variety of freeware and other encoding software for MP3 and WMA files on the market, and depending on the status of the encoding and the file format, poor sound quality or noise at the start of playback may result. In some cases, playback may not be possible at all.
- When files other than MP3 or WMA files are recorded on a disc, it may take more time to recognize the disc and in some cases, playback may not be possible at all.
- Microsoft, Windows, and Windows Media are the registered trademarks of Microsoft Corporation in the U.S. and other countries.

#### NOTICE

■ **CDs and adapters that cannot be used (→P. 282)**

■ **Player precautions (→P. 283)**

## 3-2. Using the audio system Operating an iPod

Connecting an iPod enables you to enjoy music from the vehicle speakers.

### ■ Connecting an iPod

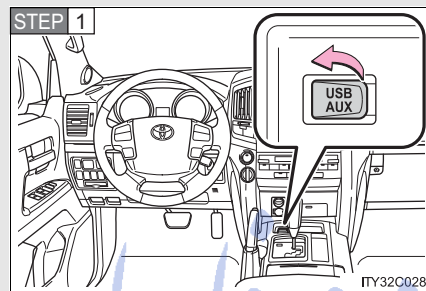

Open the cover and connect an iPod using an iPod cable.

Turn on the power of the iPod if it is not turned on.

**STEP 2** Press **CD-AUX**.

### ■ Control panel

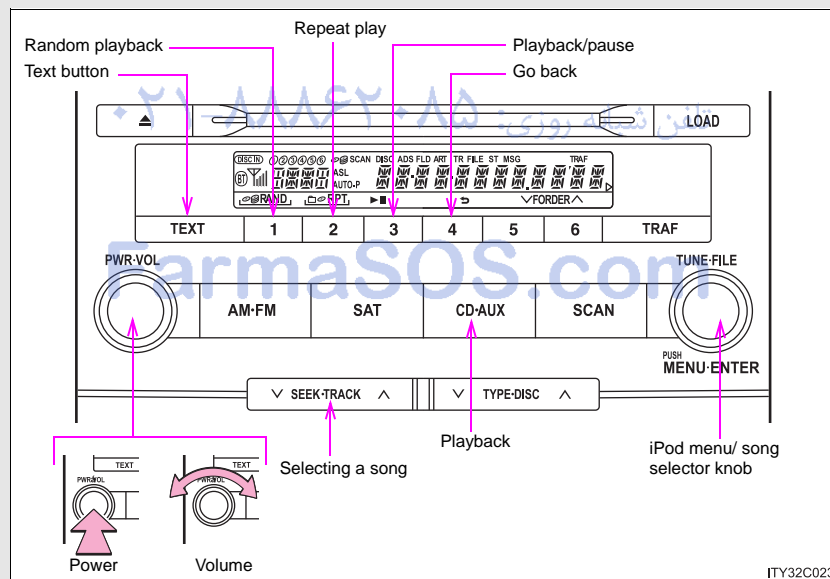

### 3-2. Using the audio system

#### Selecting a play mode

**STEP 1** Press  to select iPod menu mode.

**STEP 2** Turning  changes the play mode in the following order:  
“PLAYLISTS”→“ARTISTS”→“ALBUMS”→“SONGS”→  
“PODCASTS”→“GENRES”→“COMPOSERS”→  
“AUDIOBOOKS”

**STEP 3** Press  to select the desired play mode.

تلفن شبانه روزی: ۰۲۱-۸۸۸۶۲۰۸۵

FarmaSOS.com

### ■ Play mode list

Play mode	First selection	Second selection	Third selection	Fourth selection
"PLAYLISTS"	Playlists select	Songs select	-	-
"ARTISTS"	Artists select	Albums select	Songs select	-
"ALBUMS"	Albums select	Songs select	-	-
"SONGS"	Songs select	-	-	-
"PODCASTS"	Albums select	Songs select	Albums select	Songs select
"GENRES"	Genre select	Artists select	Songs select	-
"COMPOSERS"	Composers select	Albums select	-	-
"AUDIOBOOKS"	Songs select	-	-	-

3

Interior features

### ■ Selecting a list

**STEP 1** Turn  to display the first selection list.

**STEP 2** Press  to select the desired item.

Pressing the knob changes to the second selection list.



**STEP 3** Repeat the same procedure to select the desired song name.

To return to the previous selection list, select "GO BACK" or press

**4** .

### 3-2. Using the audio system

#### Selecting songs

Turn  or press “^” or “v” on  to select the desired song.

#### Playing and pausing songs

To play or pause a song, press  (▶||).

#### Fast-forwarding and rewinding songs

To fast-forward or rewind, press and hold “^” or “v” on  until you hear a beep.

#### Shuffle playback

##### ■ Playing songs from one playlist or album in random order

Press  (RAND).

To cancel, press  (RAND) again.

##### ■ Playing songs from all the playlists or albums in random order

Press and hold  (RAND) until you hear a beep.

To cancel, press  (RAND) again.

#### Repeat play

Press  (RPT).

To cancel, press  (RPT) again.

### Switching the display

Press .

Each time the button is pressed, the display changes in the following order: Elapsed time → Album title → Track title → Artist name

### Adjusting sound quality and volume balance

**STEP 1** Press  to enter iPod menu mode.

**STEP 2** Pressing  changes sound modes. (→P. 306)

#### ■ About iPod

- Apple is not responsible for the operation of this device or its compliance with safety and regulatory standards.
- iPod is a trademark of Apple Inc., registered in the U.S. and other countries.

#### ■ iPod functions

- When an iPod is connected and the audio source is changed to iPod mode, the iPod will resume play from the same point in which it was last used.
- Depending on the iPod that is connected to the system, certain functions may not be available. Disconnecting the device and reconnecting it once again may resolve some malfunctions.

#### ■ iPod problems

To resolve most problems encountered when using your iPod, disconnect your iPod from the vehicle iPod connection and reset it.

For instructions on how to reset your iPod, refer to your iPod Owner's Manual.

### 3-2. Using the audio system

#### ■ Display

→P. 280

#### ■ Error messages

“ERROR”: This indicates a problem in the iPod or its connection.

“NO MUSIC”: This indicates that there is no music data in the iPod.

“EMPTY”: This indicates that an empty playlist is selected.

“UPDATE”: This indicates that the version of the iPod is not compatible. Upgrade your iPod software to the latest version.

#### ■ Compatible models

Model	Generation	Software version
iPod	5th generation	Ver. 1.2.0 or higher
iPod nano	1st generation	Ver. 1.3.0 or higher
	2nd generation	Ver. 1.1.2 or higher
	3rd generation	Ver. 1.0.0 or higher
iPod touch	1st generation	Ver. 1.1.0 or higher
iPod classic	1st generation	Ver. 1.0.0 or higher

Depending on differences between models or software version etc., some models listed above might be incompatible with this system.

iPod 4th generation and earlier models are not compatible with this system. iPhone, iPod mini, iPod shuffle and iPod photo are not compatible with this system.

Items related to standards and limitations are as follows:

- Maximum number of lists in device: 9999
- Maximum number of songs in device: 65535
- Maximum number of songs per list: 65535



 CAUTION

■ **While driving**

Do not connect iPod or operate the controls.

 NOTICE

■ **To prevent damage to iPod**

- Do not leave iPod in the vehicle. The temperature inside the vehicle may become high, resulting in damage to the player.
- Do not push down on or apply unnecessary pressure to the iPod while it is connected as this may damage the iPod or its terminal.
- Do not insert foreign objects into the port as this may damage the iPod or its terminal.

تلفن شبانه روزی: ۰۲۱-۸۸۶۲۰۸۵

FarmaSOS.com

### 3-2. Using the audio system Operating a USB memory

Connecting a USB memory enables you to enjoy music from the vehicle speakers.

#### ■ Connecting a USB memory

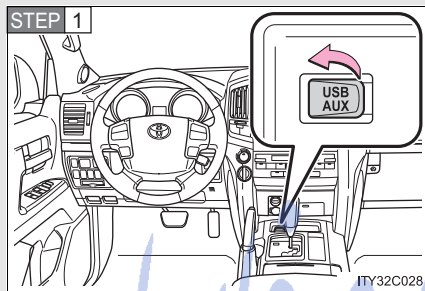

Open the cover and connect a USB memory.

Turn on the power of the USB memory if it is not turned on.

**STEP 2** Press  .

#### ■ Control panel

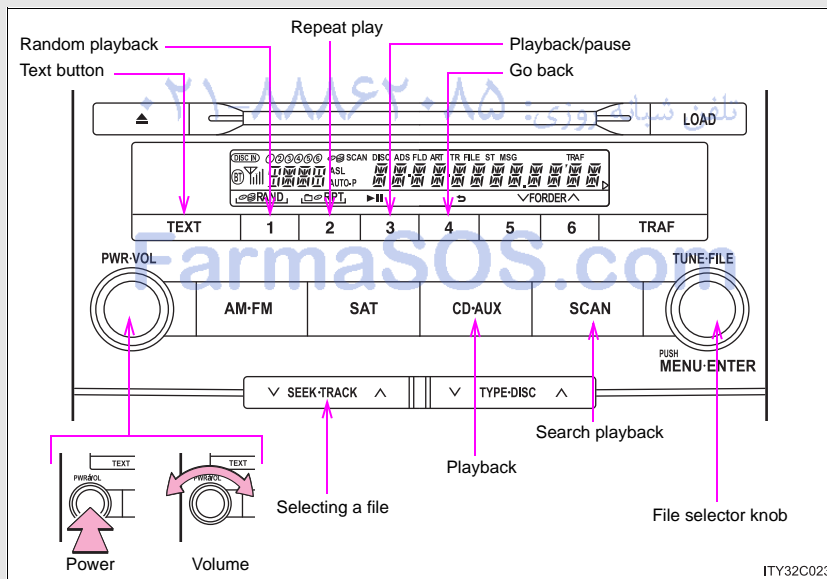

### Selecting and scanning a folder

#### ■ Selecting folders one at a time

Press  (^) or  (v) to select the desired folder.

#### ■ Returning to the first folder

Press and hold  (v) until you hear a beep.

#### ■ Scanning the first file of all the folders

**STEP 1** Press and hold  until you hear a beep.

The first ten seconds of the first file in each folder will be played.

**STEP 2** When the desired folder is reached, press  again.

### Selecting and scanning files

#### ■ Selecting a file

Turn  or press “^” or “v” on  to select the desired file.

#### ■ Scanning the files in a folder

Press .

The first ten seconds of each file will be played.

To cancel, press  again.

When the desired file is reached, press  again.

### Playing and pausing files

To play or pause a file, press  (▶||).

### 3-2. Using the audio system

#### Fast-forwarding and rewinding files

To fast-forward or rewind, press and hold “^” or “v” on  until you hear a beep.

#### Random playback

##### ■ Playing files from a folder in random order

Press  (RAND).

To cancel, press  (RAND) again.

##### ■ Playing all the files from a USB memory in random order

Press and hold  (RAND) until you hear a beep.

To cancel, press  (RAND) again.

#### Repeat play

##### ■ Repeating a file

Press  (RPT).

To cancel, press  (RPT) again.

##### ■ Repeating all the files in a folder

Press and hold  (RPT) until you hear a beep.

To cancel, press  (RPT) again.

### Switching the display

Press  .

Each time the button is pressed, the display changes in the following order: Elapsed time → Folder name → File name → Album title → Track title → Artist name

#### ■ When using the USB port

You may be unable to use the instrument panel power outlet if a device is connected to the USB port at the same time.

#### ■ USB memory functions

Depending on the USB memory that is connected to the system, certain functions may not be available. Disconnecting the device and reconnecting it once again may resolve some malfunctions.

#### ■ Display

→P. 280

#### ■ Error messages

“ERROR”: This indicates a problem in the USB memory or its connection.

“NO MUSIC”: This indicates that no MP3/WMA files are included in the USB memory.

FarmaSOS.com

### ■ USB memory

#### ● Compatible devices

USB memory that can be used for MP3 and WMA playback

#### ● Compatible device formats

The following device formats can be used:

- USB communication formats: USB2.0 FS (12mbps)
- File formats: FAT16/32 (Windows)
- Correspondence class: Mass storage class

MP3 and WMA files written in any format other than those listed above may not play correctly, and their file names and folder names may not be displayed correctly.

Items related to standards and limitations are as follows:

- Maximum directory hierarchy: 8 levels
- Maximum number of folders in a device: 999 (including the root)
- Maximum number of files in a device: 65025
- Maximum number of files per folder: 255

#### ● MP3 and WMA files

MP3 (MPEG Audio LAYER 3) is a standard audio compression format.

Files can be compressed to approximately 1/10 of their original size using MP3 compression.

WMA (Windows Media® Audio) is a Microsoft audio compression format.

This format compresses audio data to a size smaller than that of the MP3 format.

There is a limit to the MP3 and WMA file standards that can be used and to the media/formats on which the files are recorded.

- MP3 file compatibility
  - Compatible standards  
MP3 (MPEG1 AUDIO LAYERII, III, MPEG2 AUDIO LAYERII, III, MPEG2.5)
  - Compatible sampling frequencies  
MPEG1 AUDIO LAYERII, III: 32, 44.1, 48 (kHz)  
MPEG2 AUDIO LAYERII, III: 16, 22.05, 24 (kHz)  
MPEG2.5: 8, 11.025, 12 (kHz)
  - Compatible bit rates (compatible with VBR)  
MPEG1 AUDIO LAYERII, III: 32-320 (kbps)  
MPEG2 AUDIO LAYERII, III: 32-160 (kbps)  
MPEG2.5: 32-160 (kbps)
  - Compatible channel modes: stereo, joint stereo, dual channel and monaural

- WMA file compatibility
  - Compatible standards  
WMA Ver. 9
  - Compatible sampling frequencies  
HIGH PROFILE 32, 44.1, 48 (kHz)
  - Compatible bit rates  
HIGH PROFILE 32-320 (kbps, VBR)

- File names

The only files that can be recognized as MP3/WMA and played are those with the extension .mp3 or .wma.

- ID3 and WMA tags

ID3 tags can be added to MP3 files, making it possible to record the track title, artist name, etc.

The system is compatible with ID3 Ver. 1.0, 1.1, and Ver. 2.2, 2.3, 2.4 ID3 tags. (The number of characters is based on ID3 Ver. 1.0 and 1.1.)

WMA tags can be added to WMA files, making it possible to record the track title and artist name in the same way as with ID3 tags.

## 3-2. Using the audio system

### ● MP3 and WMA playback

- When a device containing MP3 or WMA files is connected, all files in the USB memory device are checked. Once the file check is finished, the first MP3 or WMA file is played. To make the file check finish more quickly, we recommend that you do not include any files other than MP3 or WMA files or create any unnecessary folders.
- When the USB device is connected and the audio source is changed to USB memory mode, the USB device will start playing the first file in the first folder. If the same device is removed and reinserted (and the contents have not been changed), the USB device will resume play from the same point in which it was last used.

### ● Extensions

If the file extensions .mp3 and .wma are used for files other than MP3 and WMA files, they will be mistakenly recognized and played as MP3 and WMA files. This may result in large amounts of interference and damage to the speakers.

### ● Playback

- To play MP3 files with steady sound quality, we recommend a fixed bit rate of at least 128 kbps and a sampling frequency of 44.1 kHz.
- There is a wide variety of freeware and other encoding software for MP3 and WMA files on the market, and depending on the status of the encoding and the file format, poor sound quality or noise at the start of playback may result. In some cases, playback may not be possible at all.
- Microsoft, Windows, and Windows Media are registered trademarks of Microsoft Corporation in the U.S.A. and other countries.

### CAUTION

#### ■ While driving

Do not connect USB memory or operate the controls.



 NOTICE

■ **To prevent damage to USB memory**

- Do not leave USB memory in the vehicle. The temperature inside the vehicle may become high, resulting in damage to the player.
- Do not push down on or apply unnecessary pressure to the USB memory while it is connected as this may damage the USB memory or its terminal.
- Do not insert foreign objects into the port as this may damage the USB memory or its terminal.

امداد خودرو فارما

تلفن شبانه روزی: ۰۲۱-۸۸۸۶۲۰۸۵

FarmaSOS.com

## 3-2. Using the audio system Optimal use of the audio system

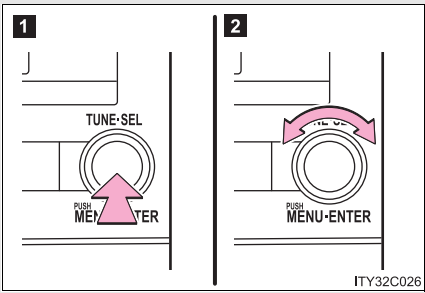

**1** Displays the current mode

**2** Changes the following settings

- Sound quality and volume balance

The sound quality and balance setting can be changed to produce the best sound.

- Automatic Sound Levelizer on/off

### Adjusting sound quality and volume balance

#### ■ Changing sound quality modes

Pressing  selects the mode to be change in the following order.

“BAS” → “MID” → “TRE” → “FAD” → “BAL” → “ASL”

FarmaSOS.com



### ■ Adjusting sound quality

Turning  adjusts the level.

Sound quality mode	Mode displayed	Level	Turn to the left	Turn to the right
Low-pitched tones*	BAS	-5 to 5	Low	High
Mid-pitched tones*	MID	-5 to 5		
High pitched tones*	TRE	-5 to 5		
Front/rear volume balance	FAD	F7 to R7	Shifts to rear	Shifts to front
Left/right volume balance	BAL	L7 to R7	Shifts to left	Shifts to right

\*: The sound quality level is adjusted individually in each audio mode.

### Turning the Automatic Sound Levelizer (ASL) on/off

Turning  clockwise turns on the ASL, and turning  counterclockwise turns off the ASL.

ASL automatically adjusts the volume and tone quality according to the noise level as you drive your vehicle.

## 3-2. Using the audio system Using the AUX port

This port can be used to connect a portable audio device and listen to it using the vehicle's speakers.

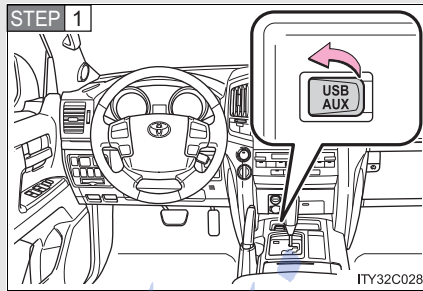

Open the cover and connect the portable audio device.

STEP 2 Press CD-AUX .

### ■ Operating portable audio devices connected to the audio system

The volume can be adjusted using the vehicle's audio controls. All other adjustments must be made on the portable audio device itself. تلف

FarmaSOS.com

## 3-2. Using the audio system Using the steering switches

Some audio features can be controlled using the switches on the steering wheel.

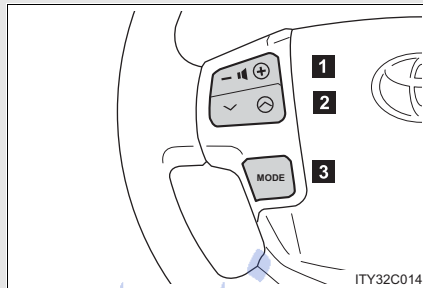

**1** Volume

**2** Radio mode: Selects a radio station

CD mode: Selects a track, file (MP3 and WMA) and disc

Bluetooth® audio mode: Selects a track and album

iPod mode: Selects a song

USB memory mode: Selects a file and folder

**3** Power on, select audio source

3

Interior features

### Turning on the power

Press  when the audio system is turned off.

The audio system can be turned off by holding the switch down until you hear a beep.

### 3-2. Using the audio system

#### Changing the audio source

Press  when the audio system is turned on. The audio source changes as follows each time the button is pressed. If a mode cannot be used, it will be skipped.

Type A:

FM1 → FM2 → SAT1 → SAT2 → SAT3 → CD player → Bluetooth® audio → AUX → iPod or USB memory → AM

Type B:

FM1 → FM2 → CD player → Bluetooth® audio → AUX → iPod or USB memory → AM

#### Adjusting the volume

Press "+" on  to increase the volume and "-" to decrease the volume.

Hold down the button to continue increasing or decreasing the volume.

#### Selecting a radio station

**STEP 1** Press  to select the radio mode.

**STEP 2** Press "∧" or "∨" on  to select a radio station.

To scan for receivable stations, press and hold the switch until you hear a beep.

### Selecting a track/file or song

**STEP 1** Press  to select CD, Bluetooth® audio, iPod or USB memory mode.

**STEP 2** Press “^” or “v” on  to select the desired track/file or song.

### Selecting an album

**STEP 1** Press  to select Bluetooth® audio mode.

**STEP 2** Press and hold “^” or “v” on  until you hear a beep.

### Selecting a folder

**STEP 1** Press  to select USB memory mode.

**STEP 2** Press and hold “^” or “v” on  until you hear a beep.

### Selecting a disc in the CD player

**STEP 1** Press  to select the CD mode.

**STEP 2** Press and hold “^” or “v” on  until you hear a beep.

### 3-2. Using the audio system

#### ■ Canceling automatic selection of a radio station

Press  again.

#### CAUTION

#### ■ To reduce the risk of an accident

Exercise care when operating the audio switches on the steering wheel.

امداد خودرو فارما

تلفن شبانه روزی: ۰۲۱-۸۸۸۶۲۰۸۵

FarmaSOS.com



### 3-3. Using the Bluetooth® audio system Bluetooth® audio system

The Bluetooth® audio system enables you to enjoy music played on a portable digital audio player (portable player) from the vehicle speakers via wireless communication.

This audio system supports Bluetooth®, a wireless data system capable of playing portable audio music without cables. If your portable player does not support Bluetooth®, the Bluetooth® audio system will not function.

- ▶ Vehicles with a navigation system  
Owners of models equipped with a navigation system should refer to the “Navigation System Owner’s Manual”.
- ▶ Vehicles without a navigation system

Title	Page
Using the Bluetooth® audio system	P. 316
Operating a Bluetooth® enabled portable player	P. 322
Setting up a Bluetooth® enabled portable player	P. 325
Bluetooth® audio system setup	P. 332

#### ■ Conditions under which the system will not operate

- If using a portable player that does not support Bluetooth®
- If the portable player is switched off
- If the portable player is not connected
- If the portable player’s battery is low
- If the portable player is behind the seat or in the glove box or console box
- If metal is covering or touching the portable player

### 3-3. Using the Bluetooth® audio system

#### ■ When transferring ownership of the vehicle

Be sure to initialize the system to prevent personal data from being improperly accessed. (→P. 361)

#### ■ About Bluetooth®



Bluetooth is a registered trademark of Bluetooth SIG, Inc.

#### ■ Compatible models

- Bluetooth® specifications:  
Ver. 1.2, or higher (Recommended: Ver. 2.0+EDR or higher)
- Following Profiles:
  - A2DP (Advanced Audio Distribution Profile) Ver. 1.0 or higher
  - AVRCP (Audio/Video Remote Control Profile) Ver. 1.0 or higher (Ver. 1.3 or higher recommended)

Portable players must correspond to the above specifications in order to be connected to the Bluetooth® audio system. However, please note that some functions may be limited depending on the type of portable player.

#### ■ Certification for the Bluetooth® audio system

FCC ID: AJDK018  
MADE IN JAPAN

This device complies with Part 15 of the FCC Rules and RSS-Gen of IC Rules. Operation is subject to the following two conditions: (1) This device may not cause harmful interference, and (2) This device must accept any interference received, including interference that may cause undesired operation.

 CAUTION

■ **FCC WARNING**

Changes or modifications not expressly approved by the party responsible for compliance could void the user's authority to operate the equipment.

Radio Frequency Radiation Exposure. This equipment complies with FCC radiation exposure limits set forth for uncontrolled equipment and meets the FCC radio frequency (RF) Exposure Guidelines in Supplement C to OET65. This equipment has very low levels of RF energy that it deemed to comply without maximum permissive exposure evaluation (MPE). But it is desirable that it should be installed and operated with at least 7.9 in. (20 cm) and more between the radiator and person's body (excluding extremities: hands, wrists, feet and legs).

This transmitter must not be co-located or operated in conjunction with any other antenna or transmitter.

■ **While driving**

Do not connect portable players or operate the controls.

 NOTICE

■ **To prevent damage to portable players**

Do not leave portable players in the vehicle. The temperature inside the vehicle may become high, resulting in damage to the player.

### 3-3. Using the Bluetooth® audio system

## Using the Bluetooth® audio system

#### ■ Audio unit

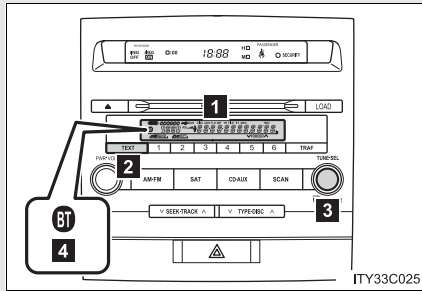

#### 1 Display

A message, name, number, etc. is displayed.

Lower-case characters and special characters cannot be displayed.

#### 2 Displays information that is too long to be displayed at one time on the display (press and hold)

#### 3 Selects items such as menu and number

Turn: Selects an item

Press: Inputs the selected item

#### 4 Bluetooth® connection condition

If "BT" is not displayed, the Bluetooth® audio system cannot be used.

### Operating the system using voice commands

By following voice guidance instructions output from the speaker, voice commands enable to the operation of the Bluetooth® audio system without the need to check the display or operate .

#### ■ Operation procedure when using voice commands

Press the talk switch and follow voice guidance instructions.

#### ■ Auxiliary commands when using voice commands

The following auxiliary commands can be used when operating the system using a voice command:

Cancel: Exits the Bluetooth® audio system

Repeat: Repeats the previous voice guidance instruction

Go back: Returns to the previous procedure



Help: Reads aloud the function summary if a help comment is registered for the selected function

FarmaSOS.com

### 3-3. Using the Bluetooth® audio system

#### Using the Bluetooth® audio system for the first time

Before using the Bluetooth® audio system, it is necessary to register a Bluetooth® enabled portable player in the system. Follow the procedure below to register (pair) a portable player:

**STEP 1** Press  and select “BT•A MENU” using .

**STEP 2** Press the talk switch or select “BT•A Setup” using .

The introductory guidance and portable player name registration instructions are heard.

**STEP 3** Select “Pair Audio Player (Pair Audio)” using a voice command or .

**STEP 4** Register a portable player name by either of the following methods: *تلفن شبانه روزی: ۰۸۵ + ۸۸۸۶۲ - ۸۸۸۸*

- a. Select “Record Name” using , and say the name to be registered.
- b. Press the talk switch and say the name to be registered.

A voice guidance instruction to confirm the input is heard.

### 3-3. Using the Bluetooth® audio system

**STEP 5** Select “Confirm” using a voice command or  .

A passkey is displayed and heard, and a voice guidance instruction for inputting the passkey into the portable player is heard.

**STEP 6** Input the passkey into the portable player.

Refer to the manual that comes with the portable player for the operation of the portable player.

Guidance for registration completion is heard.

If the portable player has a Bluetooth® phone, the phone can be registered at the same time. A voice guidance instruction to register a Bluetooth® phone is heard.

**STEP 7** Select “Yes” or “No” using a voice command or  .  
(Bluetooth® phone →P. 333)

3

Interior features

تلفن شبانه روزی: ۰۲۱-۸۸۶۲۰۸۵

FarmaSOS.com

### 3-3. Using the Bluetooth® audio system

#### Menu list of the Bluetooth® audio system

##### ■ Normal operation

First menu	Second menu	Third menu	Operation detail
"Setup"	"BT•A Setup"	"Pair Audio"	Registering a portable player
		"Connect"	Selecting a portable player to be used
		"Change Name"	Changing the registered name of a portable player
		"List Audios"	Listing the registered portable players
		"Set Passkey"	Changing the passkey
	"System Setup"	"Delete Audio"	Deleting a registered portable player
		"Guidance Vol"	Setting voice guidance volume
		"Device Name"	Displaying the Bluetooth® device address and name
		"Initialize"	Initializing the system



■ **When using a voice command**

For numbers, say a combination of single digits from zero to nine.  
Say the command correctly and clearly.

■ **Situations that the system may not recognize your voice**

- When driving on rough roads
- When driving at high speeds
- When air is blowing out of the vents onto the microphone
- When the air conditioning fan emits a loud noise

■ **Operations that cannot be performed while driving**

- Operating the system with 
- Registering a portable player to the system

■ **Changing the passkey**

→P. 330

تلفن شبانه روزی: ۰۲۱-۸۸۶۲۰۸۵

FarmaSOS.com

### 3-3. Using the Bluetooth® audio system Operating a Bluetooth® enabled portable player

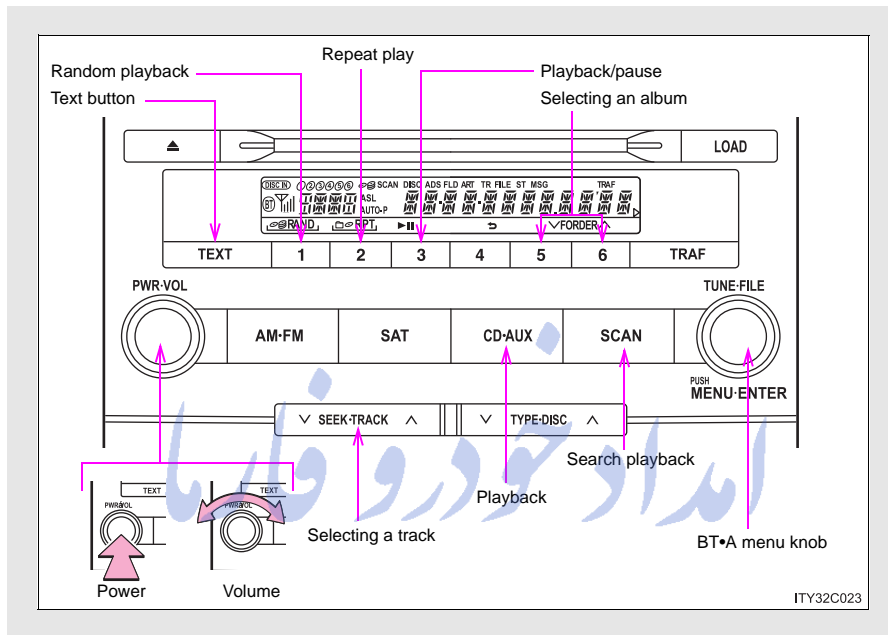

#### Selecting an album

To select the desired album, press  (∨) or  (∧).

#### Selecting tracks

Press "∧" or "∨" on  to select the desired track.

### Playing and pausing tracks

To play or pause a track, press  (▶||).

### Fast-forwarding and rewinding tracks

To fast-forward or rewind, press and hold “^” or “v” on  until you hear a beep.

### Random playback

Press  (RAND).

To cancel, press  (RAND) again.

### Repeat play

Press  (RPT).

To cancel, press  (RPT) again.

### Scanning tracks

Press .

To cancel, press  again.

### 3-3. Using the Bluetooth® audio system

#### Switching the display

Press .

Each time the button is pressed, the display changes in the following order: Elapsed time → Album title → Track title → Artist name

#### Using the steering wheel audio switches

→P. 309

#### ■ Bluetooth® audio system functions

Depending on the portable player that is connected to the system, certain functions may not be available.

#### ■ Display

→P. 280

#### ■ Error messages

“Memory Error”: This indicates a problem in the system.

FarmaSOS.com

### 3-3. Using the Bluetooth® audio system Setting up a Bluetooth® enabled portable player

Registering a portable player in the Bluetooth® audio system allows the system to function. The following functions can be used for registered portable players:

#### ■ Functions and operation procedures

##### ▶ Pattern A

To enter the menu for each function, follow the steps below using a

voice command or  :

- Registering a portable player
  1. "Setup" → 2. "Bluetooth Audio Setup (BT•A Setup)" → 3. "Pair Audio Player (Pair Audio)"
- Selecting a portable player to be used
  1. "Setup" → 2. "Bluetooth Audio Setup (BT•A Setup)" → 3. "Connect Audio Player (Connect)"
- Changing the registered name of a portable player
  1. "Setup" → 2. "Bluetooth Audio Setup (BT•A Setup)" → 3. "Change Name"
- Listing the registered portable players
  1. "Setup" → 2. "Bluetooth Audio Setup (BT•A Setup)" → 3. "List Audio Players (List Audios)"
- Changing the passkey
  1. "Setup" → 2. "Bluetooth Audio Setup (BT•A Setup)" → 3. "Set Passkey"
- Deleting a registered portable player
  1. "Setup" → 2. "Bluetooth Audio Setup (BT•A Setup)" → 3. "Delete Audio Player (Delete Audio)"

### 3-3. Using the Bluetooth® audio system

#### ► Pattern B

**STEP 1** Press  to select “BT•A MENU”.

**STEP 2** Press the talk switch or select “BT•A Setup” using .

**STEP 3** Select one of the following functions using a voice command or .

- Registering a portable player  
“Pair Audio Player (Pair Audio)”
- Selecting a portable player to be used  
“Connect Audio Player (Connect)”
- Changing the registered name  
“Change Name”
- Listing the registered portable players  
“List Audio Players (List Audios)”
- Changing the passkey  
“Set Passkey”
- Deleting a registered portable player  
“Delete Audio Player (Delete Audio)”

### Registering a portable player

Select “Pair Audio Player (Pair Audio)” using a voice command or

 , and perform the procedure for registering a portable player.  
(→P. 318)

### Selecting a portable player to be used

**STEP 1** Select “Connect Audio Player (Connect)” using a voice com-

mand or  .

► Pattern A

**STEP 2** Select the portable player to be used by either of the following methods, and select “Confirm” by using a voice command or

 : تلفن شبانه روزی: ۰۸۵-۸۸۶۲۰۸۵

a. Press the talk switch and say the name of the desired portable player.

b. Press the talk switch and say “List Audio Players”. When the name of the desired portable player is read aloud, press the talk switch.

► Pattern B

**STEP 2** Select the portable player to be used using  .

### 3-3. Using the Bluetooth® audio system

#### ► Pattern A

**STEP 3** Press the talk switch and say “From Car” or “From Audio player”, and select “Confirm” by using a voice command or



#### ► Pattern B

**STEP 3** Select “From Car” or “From Audio”, using .

If “From Car” is selected, the portable player will be automatically connected whenever the “ENGINE START STOP” switch is in either ACCESSORY or IGNITION ON mode.

### Changing the registered name of a portable player

**STEP 1** Select “Change Name” using a voice command or .

#### ► Pattern A

**STEP 2** Select the name of the portable player to be changed by either of the following methods, and select “Confirm” using a

voice command or .

- a. Press the talk switch and say the name of desired portable player.
- b. Press the talk switch and say “List Audio Players”. When the name of the desired portable player is read aloud, press the talk switch.



## ► Pattern B

**STEP 2** Select the desired portable player name to be changed using



**STEP 3** Press the talk switch or select “Record Name” using , and say the new name.

**STEP 4** Select “Confirm” using a voice command or .

### Listing the registered portable players

Select “List Audio Players (List Audios)” using a voice command or



. The list of registered portable players will be read aloud.

When listing is complete, the system returns to “BT•A Setup”.

Pressing the talk switch while the name of a portable player is being read aloud selects the portable player, and the following functions will become available:

- Selecting a portable player: “Connect Audio Player (Connect)”
- Changing a registered name: “Change Name”
- Deleting a portable player: “Delete Audio Player (Delete Audio)”

### 3-3. Using the Bluetooth® audio system

#### Changing the passkey

**STEP 1** Select “Set Passkey” using a voice command or  .

▶ Pattern A

**STEP 2** Press the talk switch, say a 4 to 8-digit number, and select “Confirm” using a voice command or  .

▶ Pattern B

**STEP 2** Select a 4 to 8-digit number using  .  
The number should be input 1 digit at a time.

**STEP 3** When the entire number to be registered as a passkey has been input, press  again.  
If the number to be registered has 8 digits, pressing of the knob is not necessary.

#### Deleting a registered portable player

**STEP 1** Select “Delete Audio Player (Delete Audio)” using a voice command or  .

## ▶ Pattern A

**STEP 2** Select the portable player to be deleted by either of the following methods and select “Confirm” using a voice command or



- a. Press the talk switch and say the name of the desired portable player.
- b. Press the talk switch and say “List Audio Players”. When the name of the desired portable player is read aloud, press the talk switch.

## ▶ Pattern B

**STEP 2** Select the desired portable player to be deleted using  .

If the portable player to be deleted is paired as a Bluetooth® phone, the registration of the mobile phone can be deleted at the same time. A voice guidance instruction to delete a mobile phone is heard.

**STEP 3** Select “Yes” or “No” using a voice command or  .

(Bluetooth® phone →P. 333)

■ **The number of portable players that can be registered**

Up to 2 portable players can be registered in the system.

### 3-3. Using the Bluetooth® audio system Bluetooth® audio system setup

#### ■ System setup items and operation procedures

##### ▶ Pattern A

To enter the menu for each function, follow the steps below using a

voice command or  :

(→P. 356)

##### ▶ Pattern B

**STEP 1** Press  to select “BT•A MENU”.

**STEP 2** Select “System Setup” using .

**STEP 3** Select one of the following items using  :

- Setting voice guidance volume  
“Guidance Vol” (→P. 359)
- Displaying the Bluetooth® device address and name  
“Device Name” (→P. 360)
- Initializing the system  
“Initialize” (→P. 360)

### 3-4. Using the hands-free system (for cellular phone) Hands-free system (for cellular phone)

**The hands-free system is a function that allows you to use your cellular phone without touching it.**

**This system supports Bluetooth<sup>®</sup>, which allows you to make or receive calls without using cables to connect a cellular phone and the system, and without operating the cellular phone.**

► **With navigation system**

Owners of models equipped with a navigation system should refer to the “Navigation System Owner’s Manual”.

► **Without navigation system**

Title	Page
Using the hands-free system	P. 337
Making a phone call	P. 345
Setting a cellular phone	P. 350
Security and system setup	P. 356
Using the phone book	P. 362

### 3-4. Using the hands-free system (for cellular phone)

---

#### ■ Conditions under which the system will not operate

- If using a mobile phone that does not support Bluetooth®
- If the mobile phone is switched off
- If you are outside service range
- If the mobile phone is not connected
- If the mobile phone's battery is low
- If the mobile phone is behind the seat or in the glove box or console box
- If metal is covering or touching the phone

#### ■ When using the hands-free system

- The audio system and voice guidance are muted when making a call.
- If both parties speak at the same time, it may be difficult to hear.
- If the incoming call volume is overly loud, an echo may be heard.
- Try to face toward the microphone as much as possible when speaking.
- In the following circumstances, it may be difficult to hear the other party:
  - When driving on unpaved roads
  - When driving at high speeds
  - When a window is open
  - When the air conditioning is blowing directly on the microphone
  - When the air conditioning is set to high

#### ■ When transferring ownership of the vehicle

Be sure to initialize the system to prevent the personal data from being improperly accessed.

### 3-4. Using the hands-free system (for cellular phone)

#### ■ About Bluetooth®



Bluetooth is a registered trademark of Bluetooth SIG, Inc.

#### ■ Compatible models

Compatible with HFP (Hands Free Profile) Ver. 1.5 and OPP (Object Push Profile) Ver. 1.1.

If your cellular phone does not support HFP, you cannot enter the Bluetooth® phone. If your cellular phone supports OPP alone, you cannot use the Bluetooth® phone.

#### ■ Certification for the hands-free system

FCC ID: AJDK018  
MADE IN JAPAN

This device complies with Part 15 of the FCC Rules. Operation is subject to the following two conditions: (1) this device may not cause harmful interference, and (2) this device must accept any interference received, including interference that may cause undesired operation.

FarmaSOS.com

3-4. Using the hands-free system (for cellular phone)

 CAUTION

■ **FCC WARNING**

Changes or modifications not expressly approved by the party responsible for compliance could void the user's authority to operate the equipment.

Radio Frequency Radiation Exposure. This equipment complies with FCC radiation exposure limits set forth for uncontrolled equipment and meets the FCC radio frequency (RF) Exposure Guidelines in Supplement C to OET65. This equipment has very low levels of RF energy that it deemed to comply without maximum permissive exposure evaluation (MPE). But it is desirable that it should be installed and operated with at least 7.9 in. (20 cm) and more between the radiator and person's body (excluding extremities: hands, wrists, feet and legs).

This transmitter must not be co-located or operated in conjunction with any other antenna or transmitter.

■ **While driving**

Do not use a cellular phone, or connect the Bluetooth® phone.

 NOTICE

■ **To prevent damage to a cellular phone**

Do not leave a cellular phone in the vehicle. The temperature inside may become high resulting in damage to the phone.



### 3-4. Using the hands-free system (for cellular phone) Using the hands-free system

#### ■ Audio unit

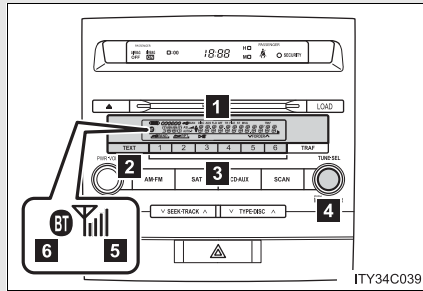

#### 1 Display

A message, name, phone number, etc. is displayed.

Lower-case characters and special characters cannot be displayed.

#### 2 Displays information that is too long to be displayed at one time on the display (press and hold)

#### 3 Selects speed dials

#### 4 Selects items such as menu and number

Turn: Selects an item

Press: Inputs the selected item

#### 5 Reception level

#### 6 Bluetooth® connection condition

If "BT" is not displayed, the hands-free system cannot be used.

### 3-4. Using the hands-free system (for cellular phone)

#### ■ Steering wheel

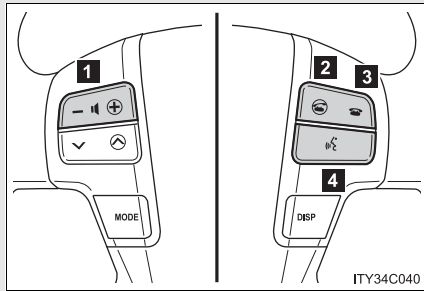

#### 1 Volume

The voice guidance volume cannot be adjusted by using this button.

#### 2 Off-hook switch

Turns the hands-free system on/start a call

#### 3 On-hook switch

Turns the hands-free system off/ends a call/refuse a call

#### 4 Talk switch

Turns the voice command system on (press)/turns the voice command system off (press and hold)

#### ■ Microphone

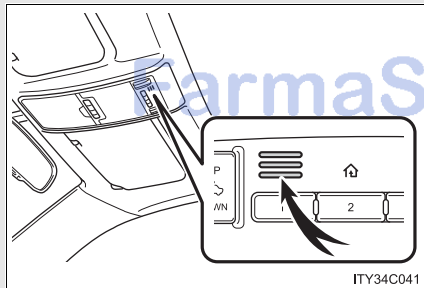

### Operating the system by using a voice command

By following voice guidance instructions output from the speaker, voice commands enable to the operation of the hands-free system

without need to check the display or operate  .

#### ■ Operation procedure when using a voice command

Press the talk switch and follow voice guidance instructions.

#### ■ Auxiliary commands when using a voice command

The following auxiliary commands can be used:

Cancel: Exits the hands-free system

Repeat: Repeats the previous voice guidance instruction

Go back: Returns to the previous procedure

Help: Reads aloud the function summary if a help comment is registered for the selected function

### Using the hands-free system for the first time

Before using the hands-free system, it is necessary to register a cellular phone in the system. The system will enter phone registration mode automatically when starting the system with no cellular phone registered. Follow the procedure below to register (pair) a cellular phone:

### 3-4. Using the hands-free system (for cellular phone)

**STEP 1** Press the off-hook switch or the talk switch.

The introductory guidance and phone name registration instructions are heard.

**STEP 2** Select “Pair Phone” using a voice command or  .

**STEP 3** Register a phone name by either of the following methods.

- a. Select “Record Name” using  , and say the name to be registered.
- b. Press the talk switch and say the name to be registered.

A voice guidance instruction to confirm the input is heard.

**STEP 4** Select “Confirm” using a voice command or  .

A passkey is displayed and heard, and a voice guidance instruction for inputting the passkey into the cellular phone is heard.

**STEP 5** Input the passkey into the cellular phone.

Refer to the manual that comes with the cellular phone for the operation of the phone.

Guidance for registration completion is heard.

If the cellular phone has a Bluetooth® audio player, the audio player can be registered at the same time. A voice guidance instruction to register a Bluetooth® audio player is heard.

**STEP 6** Select “Yes” or “No” using a voice command or  .  
(Bluetooth® audio player →P. 313)

### 3-4. Using the hands-free system (for cellular phone)

#### Menu list of the hands-free system

##### ■ Normal operation

First menu	Second menu	Third menu	Operation detail
Callback	—	—	Dialing a number stored in the incoming call history memory
Redial	—	—	Dialing a number stored in the outgoing call history memory
Phone-book	Add Entry	—	Adding a new number
	Change Name	—	Changing a name in the phone book
	Delete Entry	—	Deleting the phone book data
	Delete Speed Dial (Del Spd Dial)	—	Deleting a registered speed dial
	List Names	—	List the phone book data
	Set Speed Dial (Speed Dial)	—	Registering a speed dial

3

Interior features

3-4. Using the hands-free system (for cellular phone)

First menu	Second menu	Third menu	Operation detail
Setup	Security	Set PIN	Setting a PIN code
		Phbk Lock	Locking the phone book
		Phbk Unlock	Unlocking the phone book
	Phone Setup	Pair Phone	Registering a cellular phone to be used
		Connect	Selecting a cellular phone to be used
		Change Name	Changing a registered name of a cellular phone
		List phones	Listing the registered cellular phones
		Set Passkey	Changing the passkey
		Delete	Deleting a registered cellular phone
	System Setup	Guidance Volume (Guidance Vol)	Setting voice guidance volume
		Device Name	Displaying the Bluetooth® device address and name
		Initialize	Initialization

### 3-4. Using the hands-free system (for cellular phone)

#### ■ Using a short cut key

First menu	Second menu	Operation detail
Dial "XXX (name)"	—	Dialing a number registered in the phone book
Phone book add entry	—	Adding a new number
Phone book change name	—	Changing a name of a phone number in the phone book
Phone book delete entry	—	Deleting phone book data
Phone book list names	—	Listing the registered data
Phone book set speed dial	—	Registering a speed dial
Phone book delete speed dial	—	Deleting a speed dial
Dial XXX (number)	—	Dialing by inputting a number
Phonebook	Phonebook Unlock	Unlocking the phone book
	Phonebook Lock	Locking the phone book

3

Interior features

FarmaSOS.com

### 3-4. Using the hands-free system (for cellular phone)

#### ■ Automatic volume adjustment

When vehicle speed reaches 50 mph (80 km/h) or more, the volume automatically increases. The volume returns to the previous volume setting when vehicle speed drops to 43 mph (70 km/h) or less.

#### ■ When using a voice command

- For numbers, say a combination of single digits from zero to nine, # (pound), \* (star), and + (plus).
- Say a command correctly and clearly.

#### ■ Situations that the system may not recognize your voice

- When driving on a rough road
- When driving at high speeds
- When air is blowing out of the vents onto the microphone
- When the air conditioning fan emits a loud noise

#### ■ Operations that cannot be performed while driving

- Operating the system with  تلفن شبانه روزی: ۰۲۱-۸۸۷۲۰۸۵
- Registering a cellular phone to the system

#### ■ Changing the passkey

→P. 354

FarmaSOS.com



### 3-4. Using the hands-free system (for cellular phone)

## Making a phone call

#### ■ Making a phone call

- Dialing by inputting a number  
“Dial by number”
- Dialing by inputting a name  
“Dial by name”
- Speed dialing
- Dialing a number stored in the outgoing history memory  
“Redial”
- Dialing a number stored in the incoming history memory  
“Call back”

#### ■ Receiving a phone call

- Answering the phone
- Refusing the call

#### ■ Transferring a call

#### ■ Call waiting

#### ■ Using a call history memory

- Dialing
- Storing data in the phone book
- Deleting

### 3-4. Using the hands-free system (for cellular phone)

#### Dialing by inputting a number

**STEP 1** Press the talk switch and say “Dial by number”.

**STEP 2** Press the talk switch and say the phone number.

**STEP 3** Dial by one of the following methods:

- a. Press the off-hook switch.
- b. Press the talk switch and say “Dial”.

c. Select “Dial” using  .

#### Dialing by inputting a name

**STEP 1** Press the talk switch and say “Dial by name”.

**STEP 2** Select a registered name to be input by either of the following methods:

- a. Press the talk switch and say a registered name.
- b. Press the talk switch and say “List names”. Press the talk switch when the desired name is being read aloud.

**STEP 3** Dial by one of the following methods:

- a. Press the off-hook switch.
- b. Press the talk switch and say “Dial”.

c. Select “Dial” using  .

### 3-4. Using the hands-free system (for cellular phone)

#### Speed dialing

- STEP 1** Press the off-hook switch.
- STEP 2** Press the preset button in which the desired number is registered.
- STEP 3** Press the off-hook switch.

#### When receiving a phone call

- **Answering the phone**  
Press the off-hook switch.
- **Refusing the call**  
Press the on-hook switch.

#### Transferring a call

A call can be transferred between the cellular phone and system while dialing, receiving a call, or during a call. Use one of the following methods:

- a. Operate the cellular phone.  
Refer to the manual that comes with the cellular phone for the operation of the phone.
- b. Press the off-hook switch\*<sup>1</sup>.
- c. Press the talk switch and say "Call Transfer"\*<sup>2</sup>.

\*<sup>1</sup>: This operation can be performed only when transferring a call from the cellular phone to the system during a call.

\*<sup>2</sup>: While the vehicle is in motion, a call cannot be transferred from the system to the cellular phone.

### 3-4. Using the hands-free system (for cellular phone)

#### Call waiting

When a call is interrupted by an incoming call from a third party, the following options will become available:

- Answer the incoming call: Press the off-hook switch. (Press the off-hook switch again as necessary to switch back and forth between calls.)
- Refuse the incoming call: Press the on-hook switch.

#### Using the call history memory

Follow the procedure below to use a number stored in the call history memory:

**STEP 1** Press the talk switch and say “Redial” (when using a number stored in the outgoing call history memory) or “Call back” (when using a number stored in the incoming call history memory).

**STEP 2** Select the number by either of the following methods:

a. Say “Previous” or “Go back” until the desired number is displayed.

b. Select the desired number using  .

### 3-4. Using the hands-free system (for cellular phone)

**STEP 3** The following operations can be performed:

Dialing: Press the off-hook switch or select “Dial” using a

voice command or  .

Storing the number in the phone book: Select “Store” and then

“Confirm” using a voice command or  .

Deleting: Select “Delete” and then “Confirm” using a voice

command or  .

#### ■ Call waiting

- If your phone does not support HFP Ver. 1.5, this function cannot be used.
- Call waiting operation may differ depending on your cellular phone and service provider.

#### ■ Call history

Up to 5 numbers can be stored in each of the outgoing and incoming call history memories.

#### ■ When talking on the phone

- Do not talk simultaneously with the other party.
- Keep the volume of the receiving voice down. Otherwise, voice echo will increase.

### 3-4. Using the hands-free system (for cellular phone) Setting a cellular phone

Registering a cellular phone in the hands-free system allows the system to function. The following functions can be used for registered cellular phones:

#### ■ Functions and operation procedures

To enter the menu for each function, follow the steps below.

**STEP 1** Press the off-hook switch and select “Setup” using voice

command or  .

**STEP 2** Select “Phone Setup” using voice command or  .

**STEP 3** Select one of the following items using voice command or



- Registering a cellular phone  
“Pair Phone” – تلفن شبانه روزی: ۰۸۵۰۶۶۶۲-۸۸۸۶۲
- Selecting a cellular phone to be used  
“Select Phone”
- Changing the registered name  
“Change Name”
- Listing the registered cellular phones  
“List Phones”
- Changing the passkey  
“Set Passkey”
- Deleting a registered cellular phone  
“Delete”

### Registering a cellular phone

Select "Pair Phone" using a voice command or , and perform the procedure for registering a cellular phone. (→P. 339)

### Selecting a cellular phone to be used

**STEP 1** Select "Connect Phone (Connect)" using a voice command or



► Pattern A

**STEP 2** Select a cellular phone to be used by either of the following methods, and select "Confirm" using a voice command or



- a. Press the talk switch and say the name of the desired phone.
- b. Press the talk switch and say "List Phones". When the name of the desired cellular phone is read aloud, press the talk switch.

► Pattern B

**STEP 2** Select a cellular phone to be used using .

### 3-4. Using the hands-free system (for cellular phone)

#### Changing the registered name of a cellular phone

**STEP 1** Select "Change Name" using a voice command or  .

► Pattern A

**STEP 2** Select a name of cellular phone to be changed by either of the following methods, and select "Confirm" using a voice com-

mand or  .

- a. Press the talk switch and say the name of the desired phone.
- b. Press the talk switch and say "List phones". When the name of the desired phone is being read aloud, press the talk switch.

► Pattern B

**STEP 2** Select the desired phone name to be changed by using

 .

**STEP 3** Press the talk switch or select "Record Name" using  , and say a new name.

**STEP 4** Select "Confirm" using a voice command or  .



### Listing the registered cellular phones

Selecting “List Phones” using a voice command or  . The list of registered cellular phones to be read aloud.

When listing is complete, the system returns to “Phone Setup”.

Pressing the talk switch while a name of cellular phone is being read selects the cellular phone, and the following functions will become available:

- Selecting a cellular phone: “Connect Phone (Connect)”
- Changing a registered name: “Change Name”
- Deleting a cellular phone: “Delete Phone”

تلفن شبانه روزی: ۰۲۱-۸۸۶۲۰۸۵

FarmaSOS.com

3-4. Using the hands-free system (for cellular phone)

### Changing the passkey

**STEP 1** Select “Set Passkey” using a voice command or  .

► Pattern A

**STEP 2** Press the talk switch, say a 4 to 8-digit number, and select

“Confirm” using a voice command or  .

► Pattern B

**STEP 2** Select a 4 to 8-digit number using  .

The number should be input 1 digit at a time.

**STEP 3** When the entire number to be registered as a passkey has

been input, press  again.

If the number to be registered has 8 digits, pressing of the knob is not necessary.

FarmaSOS.com

### Deleting a registered cellular phone

**STEP 1** Select "Delete Phone" using a voice command or  .

► Pattern A

**STEP 2** Select the cellular phone to be deleted by either of the following methods and select "Confirm" using a voice command or



- a. Press the talk switch and say the name of the desired cellular phone.
- b. Press the talk switch and say "List Phones". While the name of the desired cellular phone is read aloud, press the talk switch.

► Pattern B

**STEP 2** Select a desired cellular phone to be deleted using  .

If the cellular phone to be deleted is paired as a Bluetooth® audio player, the registration of the audio player can be deleted at the same time. A voice guidance instruction to delete a Bluetooth® audio player is heard.

**STEP 3** Select "Yes" or "No" by using a voice command or  .

(Bluetooth® audio player →P. 313)

■ **The number of cellular phone that can be registered**

Up to 6 cellular phones can be registered in the system.

### 3-4. Using the hands-free system (for cellular phone) Security and system setup

#### ■ Security setting items and operation procedure

To enter the menu for each function, follow the steps below.

**STEP 1** Press the off-hook switch and select “Setup” using voice

command or .

**STEP 2** Select “Security” using voice command or .

**STEP 3** Select one of the following items using voice command or



- Setting or changing the PIN (Personal Identification Number)  
“Set PIN”
- Locking the phone book  
“Phonebook Lock (Phbk Lock)”
- Unlocking the phone book  
“Phonebook Unlock (Phbk Unlock)”

FarmaSOS.com

### 3-4. Using the hands-free system (for cellular phone)

#### ■ System setup items and operation procedure

To enter the menu for each function, follow the steps below.

**STEP 1** Press the off-hook switch and select "Setup" using  .

**STEP 2** Select "System Setup" using  .

**STEP 3** Select one of the following items using  .

- Setting voice guidance volume  
"Guidance Vol"
- Displaying the Bluetooth® device address and name  
"Device Name"
- Initializing the system  
"Initialize"

3

Interior features

FarmaSOS.com

### 3-4. Using the hands-free system (for cellular phone)

#### Setting or changing the PIN

##### ■ Setting a PIN

**STEP 1** Select "Set PIN" using a voice command or  .

**STEP 2** Enter a PIN using a voice command or  .

When using  , input the code 1 digit at a time.

##### ■ Changing the PIN

**STEP 1** Select "Set PIN" using a voice command or  .

**STEP 2** Enter the registered PIN using a voice command or  .

**STEP 3** Enter a new PIN using a voice command or  .

When using  , input the code 1 digit at a time.

FarmaSOS.com

### 3-4. Using the hands-free system (for cellular phone)

#### Locking or unlocking the phone book

**STEP 1** Select “Phonebook Lock (Phbk Lock)” or “Phonebook Unlock

(Phbk Unlock)” using a voice command or  .

**STEP 2** Input the PIN by either of the following methods and select

“Confirm” using a voice command or  :

a. Press the talk switch and say the registered PIN.

b. Input a new PIN using  .

#### Setting voice guidance volume

**STEP 1** Select “Guidance Vol” using  .

**STEP 2** Change the voice guidance volume. *تلفن شبانه روزی ۰۲۱ ۸۸۸۶۲۰۸۵*

To decrease the volume: Turn  counterclockwise.

To increase the volume: Turn  clockwise. *FarmaSOS.com*

3-4. Using the hands-free system (for cellular phone)

### Displaying the Bluetooth® device address and name

**STEP 1** Select “Device Name” using  .

**STEP 2** Turn  to display the Bluetooth® device address and name.

**STEP 3** Select “Go Back” using  to return to “System Setup”.

### Initializing the system

**STEP 1** Select “Initialize” and then “Confirm” using  .

**STEP 2** Select “Confirm” again using  .

تلفن شبانه روزی: ۰۲۱-۸۸۸۶۲۰۸۵

FarmaSOS.com



■ **Initialization**

- The following data in the system can be initialized:
  - Phone book
  - Outgoing and incoming call history
  - Speed dials
  - Registered cellular phone data
  - Security code
  - Registered Bluetooth® enabled portable player data
  - Passkey for the cellular phone
  - Passkey for the Bluetooth® audio players
  - Guidance volume
  - Receiver volume
  - Ring tone volume
- Once the initialization has been completed, the data cannot be restored to its original state.

■ **When the phone book is locked**

The following functions cannot be used:

- Dialing by inputting a name
- Speed dialing
- Dialing a number stored in the call history memory
- Using the phone book

### 3-4. Using the hands-free system (for cellular phone) Using the phone book

To enter the menu for each function, follow the steps below.

**STEP 1** Press the off-hook switch and select “Phonebook” using voice command or  .

**STEP 2** Select one of the following items using voice command or



- Adding a new phone number  
“Add Entry”
- Changing the registered name in the phone book  
“Change Name”
- Listing the registered data  
“List Names”
- Setting speed dials  
“Set Speed Dial (Speed Dial)”
- Deleting the registered data  
“Delete Entry”
- Deleting speed dial  
“Delete Speed Dial (Del Spd Dial)”

### 3-4. Using the hands-free system (for cellular phone)

#### Adding a new phone number

The following methods can be used to add a new phone number:

- Inputting a phone number using a voice command
- Transferring data from the cellular phone

- Inputting a phone number using 

- Selecting a phone number from outgoing or incoming call history

#### ■ Adding procedure

**STEP 1** Select "Add Entry" using a voice command or .

**STEP 2** Use one of the following methods to input a telephone number:

- ▶ Inputting a telephone number using a voice command

STEP2-1 Select "By Voice" using a voice command or



STEP2-2 Press the talk switch, say the desired number, and select "Confirm" using a voice command.

### 3-4. Using the hands-free system (for cellular phone)

#### ► Transferring data from the cellular phone

STEP2-1 Select "By Phone" and then "Confirm" using a

voice command or  .

STEP2-2 Transfer the data from the cellular phone.

Refer to the manual that comes with the cellular phone for the details of transferring data.

STEP2-3 Select the data to be registered by either of the following methods:

a. Say "Previous" or "Next" until the desired data is displayed, and select "Confirm" using a voice command.

b. Select the desired data using  .

► Inputting a phone number using  : تلفن شبانه روزی

STEP2-1 Select "Manual Input" using  .

STEP2-2 Input a phone number using  , and press

 again.

Input the phone number 1 digit at a time.

### 3-4. Using the hands-free system (for cellular phone)

► Selecting a phone number from outgoing or incoming call history

STEP2-1 Select “Call History” using a voice command or



STEP2-2 Select “Outgoing” or “Incoming” using a voice com-

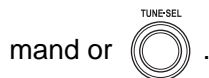

STEP2-3 Select the data to be registered by either of the following methods:

a. Say “Previous” or “Go back” until the desired data is displayed, and select “Confirm” by using a voice command.

b. Select the desired data using .

**STEP 3** Select the name to be registered by either of the following methods, and select “Confirm” using a voice command or



a. Press the talk switch and say the desired name.

b. Select “Record Name” using , and say the desired name.

### 3-4. Using the hands-free system (for cellular phone)

**STEP 4** Select “Confirm” using a voice command or  again.

In **STEP 4**, selecting “Set Speed Dial (Speed Dial)” instead of “Confirm” registers the newly added phone number as speed dial.

#### Changing the registered name in the phone book

**STEP 1** Select “Change Name” using a voice command or .

##### ► Pattern A

**STEP 2** Select the name to be changed by either of the following methods, and select “Confirm” using a voice command or



- a. Press the talk switch, say desired name.
- b. Press the talk switch, and say “List names”. While the desired name is read aloud, press the talk switch.

##### ► Pattern B

**STEP 2** Select the desired name to be changed using .

**STEP 3** Press the talk switch or select “Record Name” using , and say the new name.

**STEP 4** Select “Confirm” using a voice command or .

### Listing the registered data

Select “List names” using a voice command or  . The list of the registered data will be read aloud.

When listing is complete, the system returns to “Phonebook”.

Pressing the talk switch while the desired data is being read aloud selects the data, and the following function will become available.

- Dialing: “Dial”
- Changing a registered name: “Change Name”
- Deleting an entry: “Delete Entry”
- Setting speed dial: “Set Speed Dial (Speed Dial)”

### Setting speed dials

**STEP 1** Select “Set Speed Dial (Speed Dial)” using a voice command

or  .

FarmaSOS.com

### 3-4. Using the hands-free system (for cellular phone)

#### ► Pattern A

**STEP 2** Select the data to be registered as a speed dial by either of the following methods, and select “Confirm” using a voice

command or  .

- a. Press the talk switch, say desired name.
- b. Press the talk switch, and say “List names”. When the desired name is read aloud, press the talk switch.

#### ► Pattern B

**STEP 2** Select the desired data using  .

**STEP 3** Select the desired preset button, and register the data into speed dial by either of the following methods:

- a. Press the desired preset button, and select “Confirm” using a voice command or  .
- b. Press and hold the desired preset button.

FarmaSOS.com



### 3-4. Using the hands-free system (for cellular phone)

#### Deleting the registered data

**STEP 1** Select "Delete Entry" using a voice command or .

► Pattern A

**STEP 2** Select the data to be deleted by either of the following meth-

ods, and select "Confirm" using a voice command or .

- a. Press the talk switch, and say the name of the desired phone number.
- b. Press the talk switch, say "List Names". When the name of the desired phone number is read aloud, press the talk switch.

► Pattern B

**STEP 2** Select the data to be deleted using .

تلفن شبانه روزی: ۰۲۱-۸۸۸۶۲۰۸۵

3

Interior features

FarmaSOS.com

3-4. Using the hands-free system (for cellular phone)

### Deleting speed dials

**STEP 1** Select “Delete Speed Dial (Del Spd Dial)” using a voice com-

mand or  .

**STEP 2** Press the preset button in which the desired speed dial is registered, and select “Confirm” using a voice command or

 .

#### ■ Limitation of number of digits

A phone number that exceeds 24 digits cannot be registered.

تلفن شبانه روزی: ۰۲۱-۸۸۸۶۲۰۸۵

FarmaSOS.com

### 3-5. Using the interior lights

## Interior lights list

Your Toyota is equipped with an illuminated entry system to assist in entering the vehicle. Owing to the function of the system, the lights shown in the following illustration automatically turn on/off according to the presence of the electronic key, whether the doors are locked/unlocked, whether the doors are opened/closed, and the “ENGINE START STOP” switch mode.

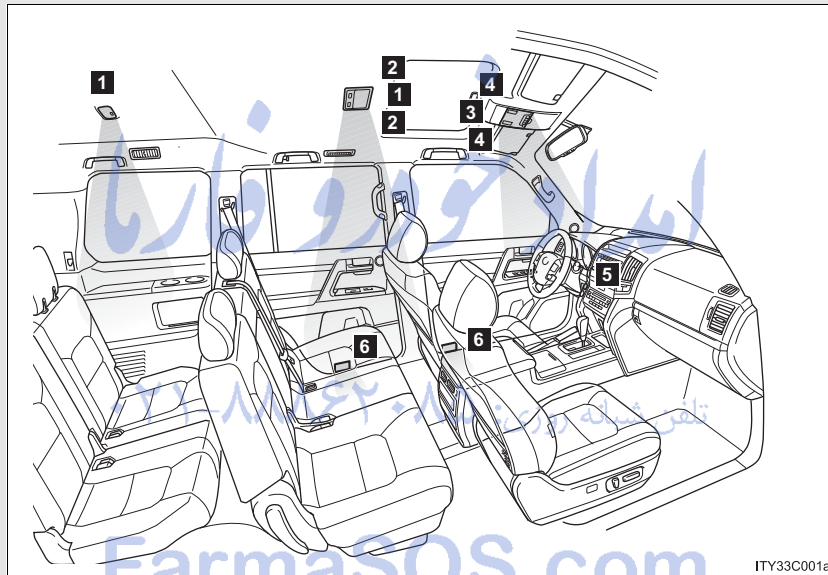

- 1** Rear interior lights (→P. 372)
- 2** Rear personal lights (→P. 373)
- 3** Front interior light (→P. 372)
- 4** Front personal lights (→P. 373)
- 5** “ENGINE START STOP” switch light
- 6** Door courtesy lights

### ■ To prevent the battery from being discharged

If the interior lights and “ENGINE START STOP” switch light remain on when the door is not fully closed and the interior light switch is in the door position, the lights will go off automatically after 20 minutes.

### ■ Customization

Settings (e.g. The time elapsed before lights turn off) can be changed. (Customizable features →P. 573)

## Interior lights

### ► Front

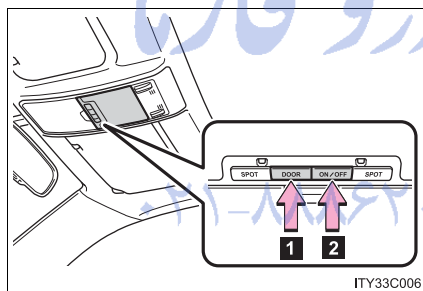

- 1 Door position on/off
- 2 On/off

### ► Rear

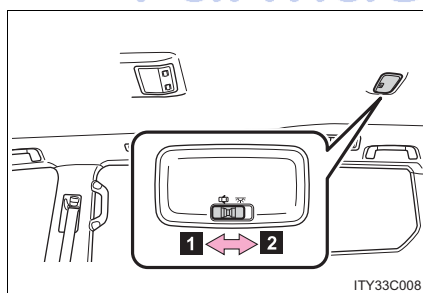

- 1 Door position
- 2 On

**Personal lights**

► Front

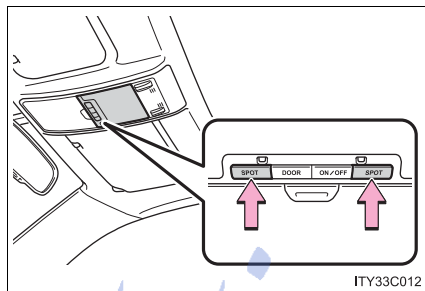

On/off

► Rear (type A)

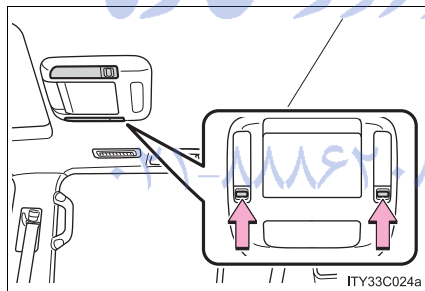

On/off

► Rear (type B)

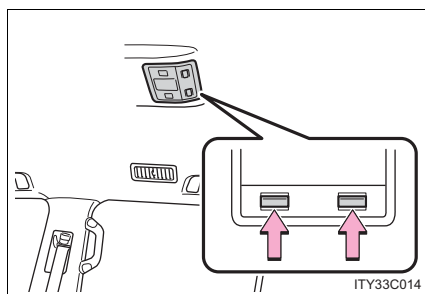

On/off

### 3-6. Using the storage features

#### List of storage features

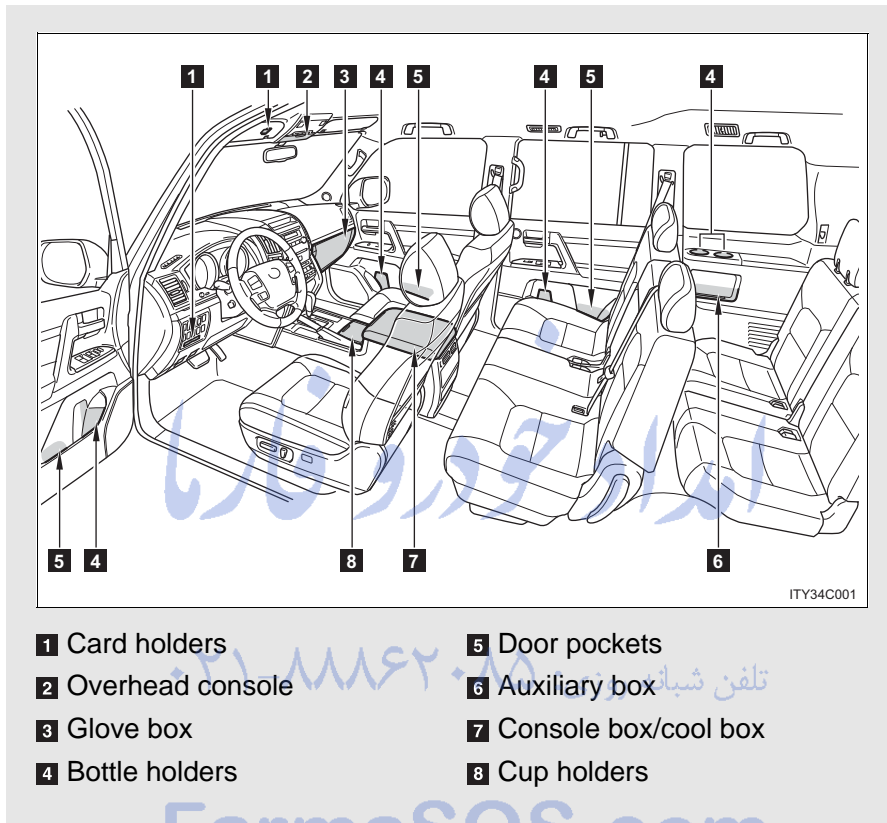

- |                    |                        |
|--------------------|------------------------|
| 1 Card holders     | 5 Door pockets         |
| 2 Overhead console | 6 Auxiliary box        |
| 3 Glove box        | 7 Console box/cool box |
| 4 Bottle holders   | 8 Cup holders          |

#### ⚠ CAUTION

##### ■ Items that should not be left in the storage spaces

Do not leave glasses, lighters or spray cans in the storage spaces, as this may cause the following when cabin temperature becomes high:

- Glasses may be deformed by heat or cracked if they come into contact with other stored items.
- Lighters or spray cans may explode. If they come into contact with other stored items, the lighter may catch fire or the spray can may release gas, causing a fire hazard.

### Glove box

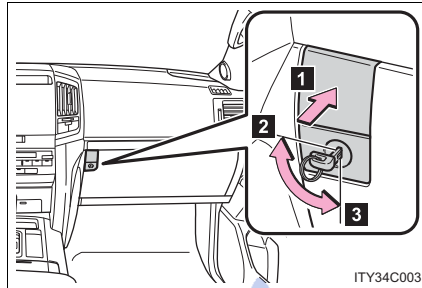

- 1 Open (push button)
- 2 Lock with the mechanical key
- 3 Unlock with the mechanical key

### ■ Glove box light

The glove box light turns on when the tail lights are on.

### ⚠ CAUTION

### ■ While driving

Keep the glove box closed.

Injuries may result in the event of sudden braking, sudden swerving or an accident.

### Console box

Your vehicle is equipped with either a lower console box or cool box. For vehicles with the cool box, refer to page 382.

#### ► Upper console box

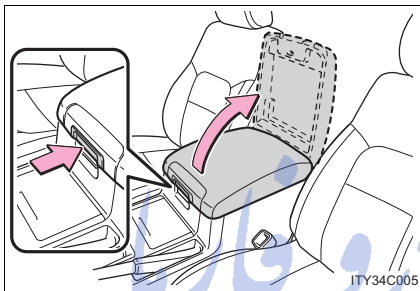

Press the tab to open.

#### ► Lower console box (if equipped)

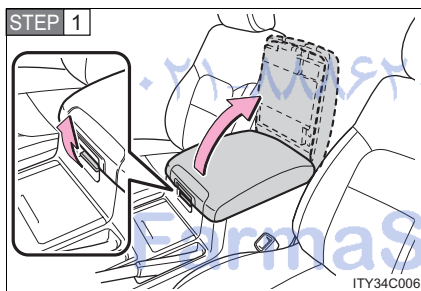

Lift the lever to open.

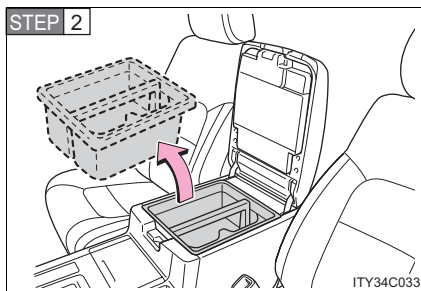

Remove the tray.



3-6. Using the storage features  
Console box and overhead console

**⚠ CAUTION**

■ **While driving**

Keep the console box closed.  
Injuries may result in the event of sudden braking, sudden swerving or an accident.

**Overhead console**

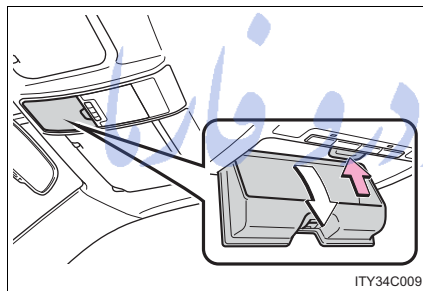

Press the button.

The overhead console is useful for temporarily storing small items.

**⚠ CAUTION**

■ **While driving**

Do not leave the overhead console open.  
Items may fall out and cause injury.

### Cup holders

#### ► Front

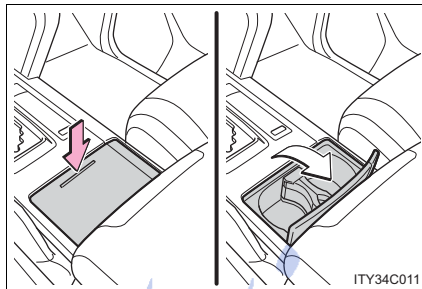

Press down and release the lid.

You can adjust or remove the separator inside.

#### ► Rear

**STEP 1** Pull the armrest down. (→P. 395)

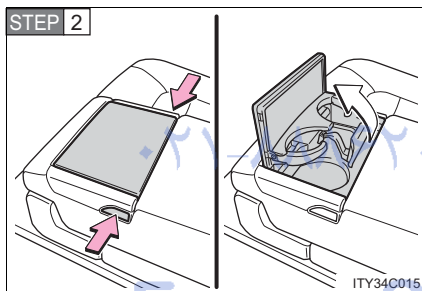

Press the button.

**⚠ CAUTION**

**■ Items unsuitable for the cup holder**

Do not place anything other than cups or aluminum cans in the cup holders. Other items may be thrown out of the holders in the event of an accident or sudden braking and cause injury. If possible, cover hot drinks to prevent burns.

**■ When not in use**

Keep the cup holders closed.

Injuries may result in the event of sudden braking, sudden swerving or an accident.

**Bottle holders**

► For front seats

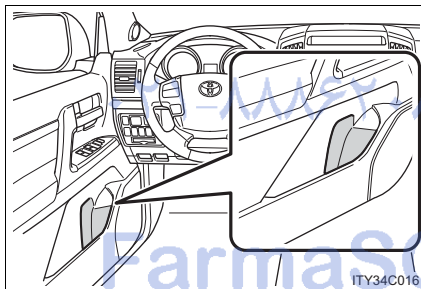

► For second seats

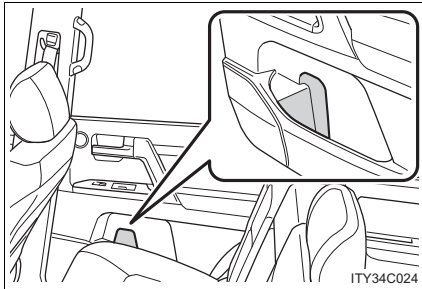

► For third seats

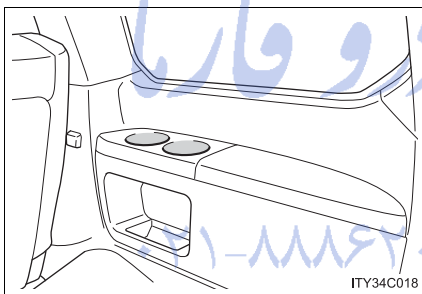

 NOTICE

■ **Items that should not be stowed in the bottle holders**

Put the cap on before stowing a bottle. Do not place open bottles in the bottle holders, or glasses and paper cups containing liquid. The contents may spill and glasses may break.

3-6. Using the storage features

Card holders and auxiliary box

**Card holders**

► Sun visor

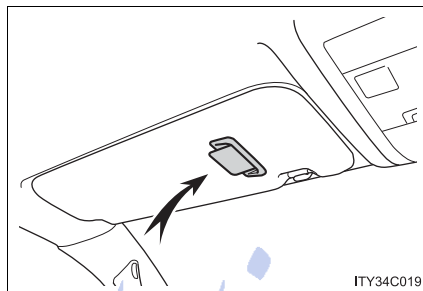

► Instrument panel

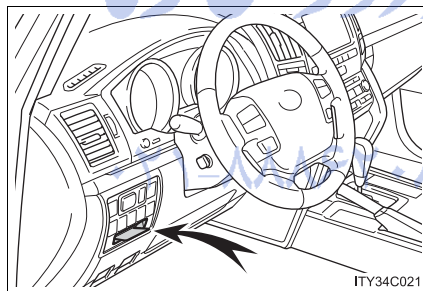

**Auxiliary box**

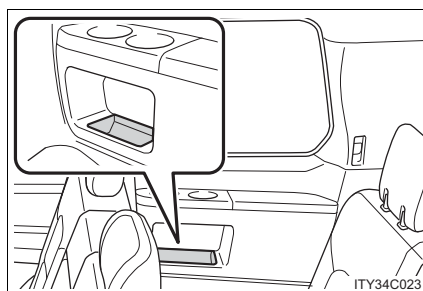

### 3-7. Other interior features

## Cool box\*

**While the engine is running, the cool box, which is cooled by the air conditioning, can be used.**

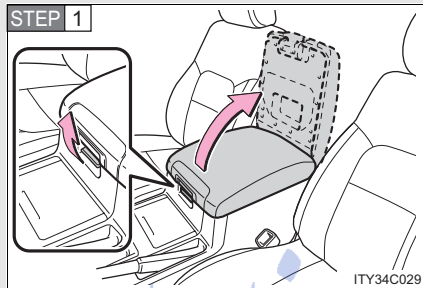

Lift the lever to open.

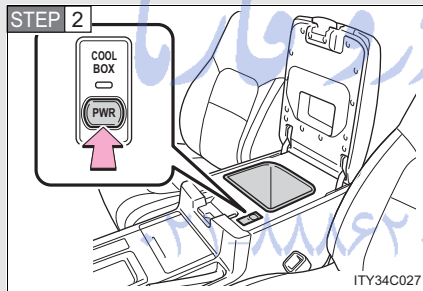

On/off

When on, the indicator light comes on.

If the front air conditioning system is not in use, the front air conditioning system is automatically turned on when the cool box is turned on.

#### ■ While the cool box is on

The front air conditioning system cannot be turned off.

#### ■ When the outside temperature is 32°F (0°C) or below

The cool box may not operate.

\*: If equipped

 CAUTION

■ **While driving**

Keep the cool box closed.  
Injuries may result in the event of sudden braking, sudden swerving or an accident.

 NOTICE

■ **To prevent battery discharge**

Do not leave the cool box on longer than necessary when the engine is stopped.

امداد خودرو فارما  
تلفن شبانه روزی: ۰۲۱-۸۸۶۲۰۸۵

FarmaSOS.com

### 3-7. Other interior features

## Sun visors

#### ► Main sun visor

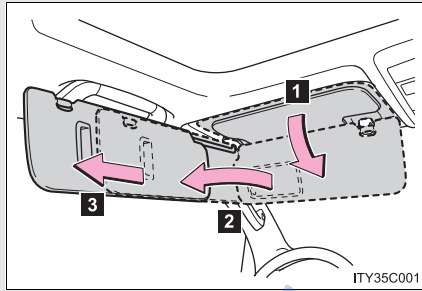

**1** Forward position:  
Flip down.

**2** Side position:  
Flip down, unhook, and  
swing to the side.

**3** Side extender:  
Place in side position, then  
side backwards.

#### ► Sub-sun visor

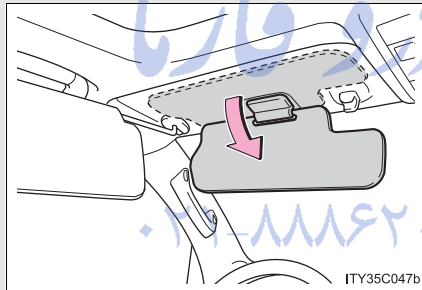

Flip down with the main sun  
visor in position **2** or **3**.

FarmaSOS.com



3-7. Other interior features  
Vanity mirror

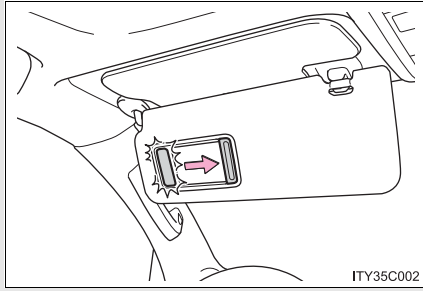

Slide the cover.

The light turns on when the cover is opened.

امداد خودرو فارما

تلفن شبانه روزی: ۰۲۱-۸۸۸۶۲۰۸۵

FarmaSOS.com

3

Interior features

### 3-7. Other interior features

## Clock

▶ With navigation system

Refer to “Navigation System Owner’s Manual”.

▶ Without navigation system

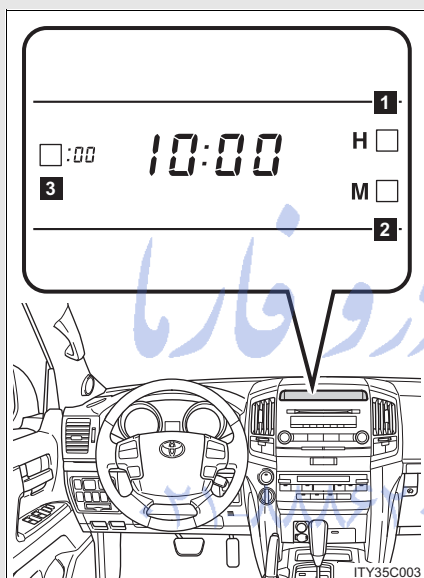

**1** Adjust hours.

**2** Adjust minutes.

**3** Round the nearest hour.\*

\*:e.g. 1:00 to 1:29→1:00

1:30 to 1:59→2:00

FarmaSOS.com

■ **The clock is displayed when**

The “ENGINE START STOP” switch is in ACCESSORY or IGNITION ON mode.

■ **When the battery is disconnected**

The time display will automatically be set to 1:00.

### 3-7. Other interior features

## Outside temperature display

The displayed temperature ranges from -22°F (-30°C) up to 122°F (50°C).

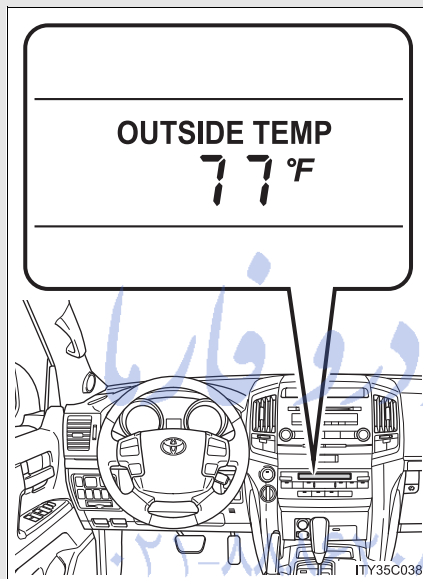

3

Interior features

#### ■ Operating conditions

The "ENGINE START STOP" switch is in IGNITION ON mode.

#### ■ When --- is displayed

The system may be malfunctioning. Take your vehicle to your Toyota dealer.

#### ■ Display

In the following situations, the correct outside temperature may not be displayed, or the display may take longer than normal to change.

- When stopped, or driving at low speeds (less than 12 mph [20 km/h])
- When the outside temperature has changed suddenly (at the entrance/exit of a garage, tunnel, etc.)

### 3-7. Other interior features Ashtrays

#### ► Front

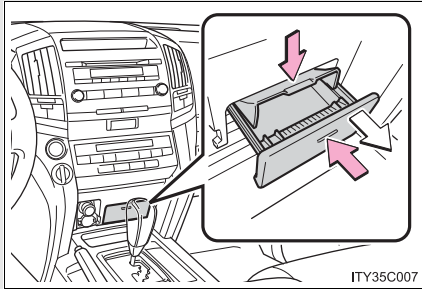

Press in and release the lid to open.

Press down on the lock spring plate to remove.

Push the lid to close.

#### ► Rear

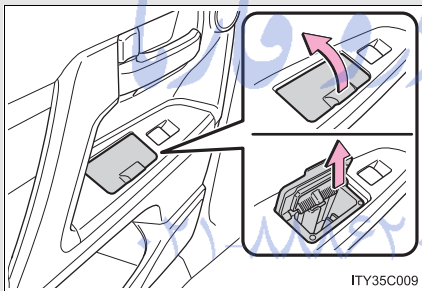

Pull the ashtray lid to open.

Pull the ashtray upwards to remove.

FarmaSOS.com

 CAUTION

■ **When not in use**

Keep the ashtray closed.

Injuries may result in the event of sudden braking, sudden swerving or an accident.

■ **To prevent fire**

- Fully extinguish matches and cigarettes before putting them in the ashtray, then make sure the ashtray is fully closed.
- Do not place paper or any other type of flammable object in the ashtray.

امداد خودرو فارما

تلفن شبانه روزی: ۰۲۱-۸۸۶۲۰۸۵

FarmaSOS.com

### 3-7. Other interior features

## Cigarette lighter

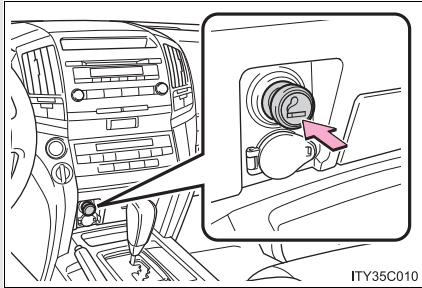

Push the cigarette lighter in.

The cigarette lighter will pop up when ready for use.

#### ■ The cigarette lighter can be used when

The "ENGINE START STOP" switch is in ACCESSORY or IGNITION ON mode.

#### ⚠ CAUTION

#### ■ To avoid burns or fires

- Do not touch the metal parts of the cigarette lighter.
- Do not hold the cigarette lighter down. It could overheat and cause a fire.
- Do not insert anything other than the cigarette lighter into the outlet.

### 3-7. Other interior features

#### Power outlets

**The power outlets can be used for a following component.**

Instrument panel (12V): Accessories that run on less than 10A.

Luggage compartment (115V AC): Accessories that use less than 100W.

► Instrument panel (12V)

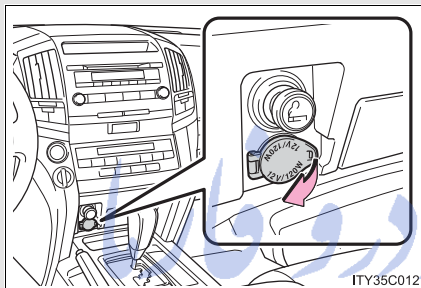

► Luggage compartment (115V AC)

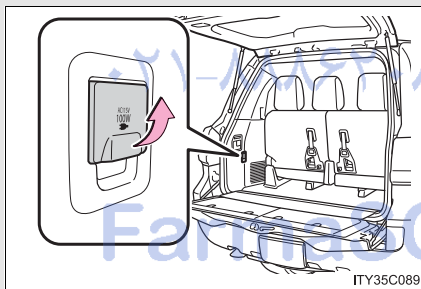

■ **The power outlets can be used when**

12V: The “ENGINE START STOP” switch is in ACCESSORY or IGNITION ON mode.

115V: The “ENGINE START STOP” switch is in IGNITION ON mode.

■ **When using the instrument panel power outlet**

You may be unable to use the USB port if a device is connected to the instrument panel power outlet at the same time.

 **NOTICE**

■ **To avoid damaging the power outlets**

Close the power outlet lid when not in use.

Foreign objects or liquids that enter the power outlet may cause a short circuit.

■ **To prevent the fuse from being blown**

12V: Do not use an accessory that uses more than 12V/10A.

115V: Do not use a 115V AC appliance that requires more than 100W.

If a 115V AC appliance that consumes more than 100W is used, the protection circuit will cut the power supply.

■ **To prevent the battery from being discharged**

Do not use the power outlet longer than necessary when the engine is not running.

■ **Appliances that may not operate properly (115V AC)**

The following 115V AC appliances may not operate even if their power consumption is under 100W.

- Appliances with high initial peak wattage
- Measuring devices that process precise data
- Other appliances that require an extremely stable power supply



## 3-7. Other interior features

### Seat heaters

#### ► For front seats

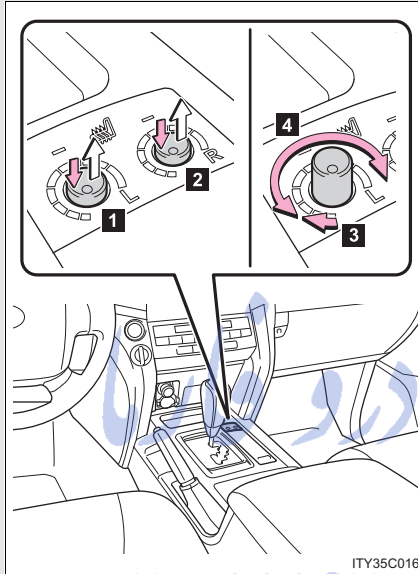

#### 1 For driver's seat

Pops the switch out.

#### 2 For front passenger's seat

Pops the switch out.

#### 3 On

The indicator light comes on.

#### 4 Adjusts the seat temperature

The further you turn the knob clockwise, the warmer the seat becomes.

Raise the knob when you wish to adjust the seat warmth, and push the knob back in when finished.

#### ► For second seats (if equipped)

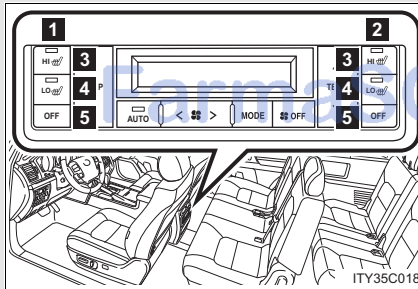

#### 1 For left second seat

#### 2 For right second seat

#### 3 High heating temperature

#### 4 Low heating temperature

#### 5 Off

To turn on the seat heater, press "HI" or "LO".

To turn off, press "OFF".

The indicator light on "HI" or "LO" switch indicates that the seat heater is on.

■ **The seat heaters can be used when**

The "ENGINE START STOP" switch is in IGNITION ON mode.

 **CAUTION**

■ **Burns**

- Use caution when seating the following persons in a seat with the seat heater on to avoid the possibility of burns:
  - Babies, small children, the elderly, the sick and the disabled
  - Persons with sensitive skin
  - Persons who are fatigued
  - Persons who have taken alcohol or drugs that induce sleep (sleeping drugs, cold remedies, etc.)
- Do not cover the seat with anything when using the seat heater. Using the seat heater with a blanket or cushion increases the temperature of the seat and may lead to overheating.

 **NOTICE**

■ **To prevent seat heater damage**

Do not put unevenly weighted objects on the seat and do not stick sharp objects (needles, nails, etc.) into the seat.

■ **To prevent battery discharge**

Turn the switches off when the engine is not running.

### 3-7. Other interior features Armrest

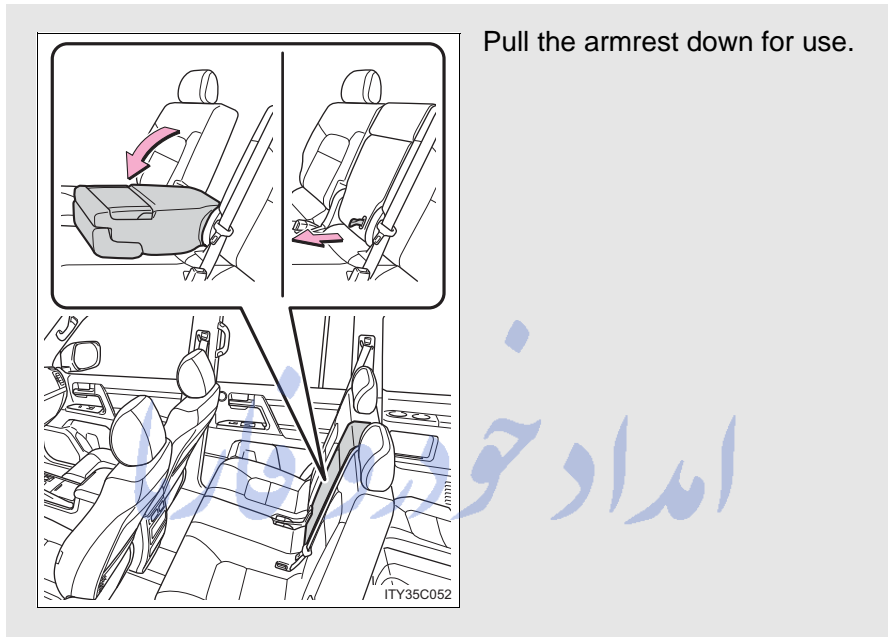

 NOTICE

■ To prevent damage to the armrest

Do not place too much strain on the armrest.

### 3-7. Other interior features

## Floor mats

**Use only floor mats designed specifically for vehicles of the same model and model year as your vehicle. Fix them securely in place onto the carpet.**

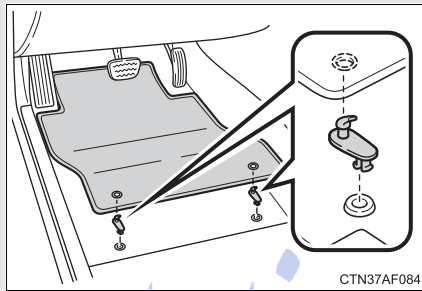

Fix the floor mat in place using the retaining hooks (clips) provided.

For details, refer to the floor mat retention clip installation instructions supplied with the clips.

### ⚠ CAUTION

Observe the following precautions.

Failure to do so may cause the driver's floor mat to slip, possibly interfering with the pedals while driving. An unexpectedly high speed may result or it may become difficult to stop the vehicle, leading to a serious accident.

#### ■ When installing the driver's floor mat

- Do not use floor mats designed for other models or different model year vehicles, even if they are Toyota Genuine floor mats.
- Only use floor mats designed for the driver's seat.
- Always install the floor mat securely using the retaining hooks (clips) provided.
- Do not use two or more floor mats on top of each other.
- Do not place the floor mat bottom-side up or upside-down.

#### ■ Before driving

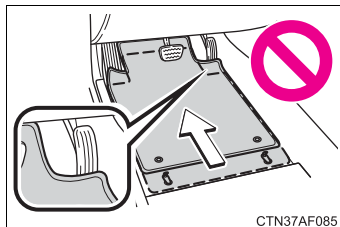

- Check that the floor mat is securely fixed in the right place with all the provided retaining hooks (clips). Be especially careful to perform this check after cleaning the floor.
- With the engine stopped and the shift lever in "P", fully depress each pedal to the floor to make sure it does not interfere with the floor mat.

### 3-7. Other interior features

## Luggage compartment features

#### ■ Cargo hooks

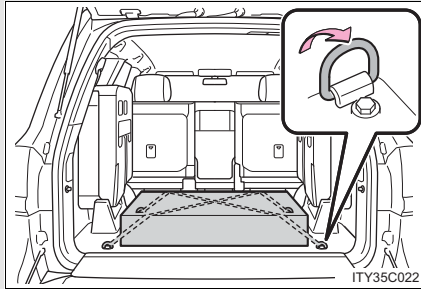

Cargo hooks are provided for securing loose items.

#### ■ Cargo net hooks

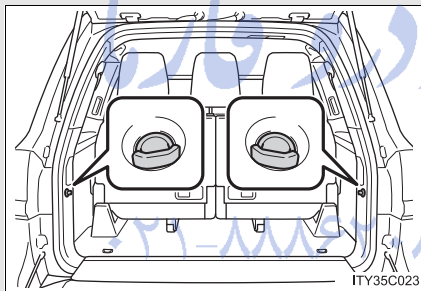

To hang the cargo net, use the cargo net hooks and rear tie-down hooks.

The cargo net itself is not included as an original equipment.

#### ■ Storage compartment

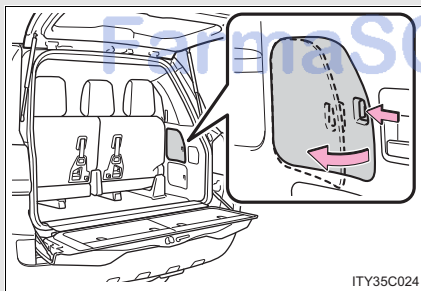

Open the storage compartment as shown.

### 3-7. Other interior features

#### ■ Warning reflector holder

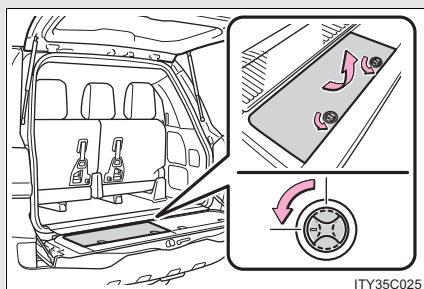

Hold the warning reflector with a band.

The warning reflector itself is not included as an original equipment.

#### ■ First-aid kit holder

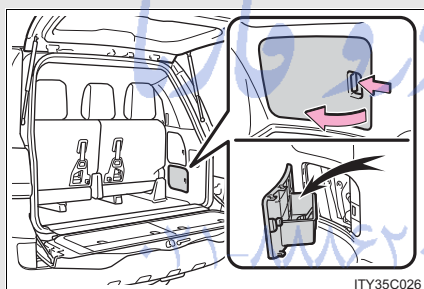

Hold the first-aid kit with a band.

The first-aid kit itself is not included as an original equipment.

#### ⚠ CAUTION

##### ■ When the cargo hooks are not in use

To avoid injury, always return the cargo hooks to their positions when they are not in use.

#### ⚠ NOTICE

##### ■ To prevent damage to the cargo net hooks

Avoid hanging things other than a cargo net on it.

### 3-7. Other interior features

## Garage door opener

The garage door opener can be programmed to operate garage doors, gates, entry doors, door locks, home lighting systems, security systems, and other devices.

The garage door opener (HomeLink® Universal Transceiver) is manufactured under license from HomeLink®.

#### Programming HomeLink® (for U.S.A. owners)

The HomeLink® compatible transceiver in your vehicle has 3 buttons which can be programmed to operate 3 different devices. Refer to the programming method below appropriate for the device.

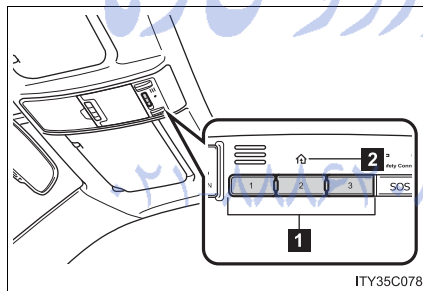

### ■ Programming HomeLink®

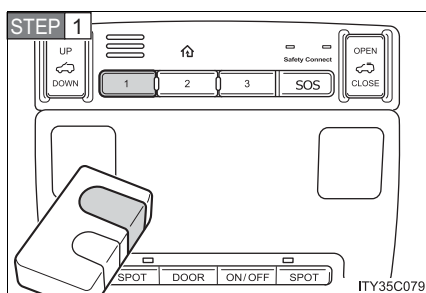

Point the remote control transmitter for the device 1 to 3 in. (25 to 75 mm) from the HomeLink® buttons.

Keep the HomeLink® indicator light in view while programming.

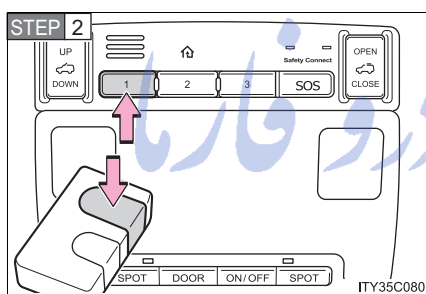

Press and hold one of the HomeLink® buttons and the transmitter button. When the HomeLink® indicator light changes from a slow to a rapid flash, you can release both buttons.

If the HomeLink® indicator light comes on but does not flash, flashes rapidly for 2 seconds and remains lit, the HomeLink® button is already programmed. Use the other buttons or follow the "Reprogramming a HomeLink® button" instructions. (→P. 404)



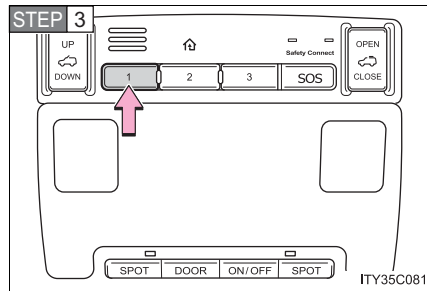

Test the HomeLink<sup>®</sup> operation by pressing the newly programmed button.

If a HomeLink<sup>®</sup> button has been programmed for a garage door, check to see if the garage door opens and closes. If the garage door does not operate, see if your remote control transmitter is of the rolling code type. Press and hold the programmed HomeLink<sup>®</sup> button. The remote control transmitter is of the rolling code type if the HomeLink<sup>®</sup> indicator light flashes rapidly for 2 seconds and then remains lit. If your transmitter is of the rolling code type, proceed to the heading "Programming a rolling code system".

**STEP 4** Repeat the steps above to program another device for each of the remaining HomeLink<sup>®</sup> buttons.

FarmaSOS.com

### ■ Programming a rolling code system

If your device is rolling code equipped, follow the steps under the heading “Programming HomeLink®” before proceeding with the steps listed below.

**STEP 1** Locate the learn button on the ceiling mounted garage door opener motor. The exact location and color of the button may vary by brand of garage door opener motor.

Refer to the operation manual supplied with the garage door opener motor for the location of the learn button.

**STEP 2** Press the learn button.

Following this step, you have 30 seconds in which to initiate step 3 below.

**STEP 3** Press and hold the vehicle’s programmed HomeLink® button for 2 seconds and release it. Repeat this step once again. The garage door may open.

If the garage door opens, the programming process is complete. If the door does not open, press and release the button a third time. This third press and release will complete the programming process by opening the garage door.

The ceiling mounted garage door opener motor should now recognize the HomeLink® signal and operate the garage door.

**STEP 4** Repeat the steps above to program another rolling code system for any of the remaining HomeLink® buttons.

### ■ Programming an entry gate (for U.S.A. owners)/Programming all devices in the Canadian market

- STEP 1** Place your transmitter 1 to 3 in. (25 to 75 mm) away from the surface of the HomeLink®.
- Keep the HomeLink® indicator light in view while programming.
- STEP 2** Press and hold the selected HomeLink® button.
- STEP 3** Repeatedly press and release (cycle) the device's remote control button for two seconds each until step 4 is completed.
- STEP 4** When the indicator light on the HomeLink® compatible transceiver starts to flash rapidly, release the buttons.
- STEP 5** Test the operation of the HomeLink® by pressing the newly programmed button. Check to see if the gate/device operates correctly.
- STEP 6** Repeat the steps above to program another device for each of the remaining HomeLink® buttons.

### ■ Programming other devices

To program other devices such as home security systems, home door locks or lighting, contact your authorized Toyota dealer for assistance.

### ■ Reprogramming a button

The individual HomeLink® buttons cannot be erased but can be reprogrammed. To reprogram a button, follow the "Reprogramming a HomeLink® button" instructions.

### 3-7. Other interior features

#### Operating HomeLink®

Press the appropriate HomeLink® button. The HomeLink® indicator light should come on.

The HomeLink® compatible transceiver in your vehicle continues to send a signal for up to 20 seconds as long as the button is pressed.

#### Reprogramming a HomeLink® button

Press and hold the desired HomeLink® button. After 20 seconds, the HomeLink® indicator light will start flashing slowly. Next, while still pressing and holding the HomeLink® button, press and hold the button on the transmitter until the HomeLink® indicator light changes from a slow to a rapid flash.

#### Erasing the entire HomeLink® memory (all three programs)

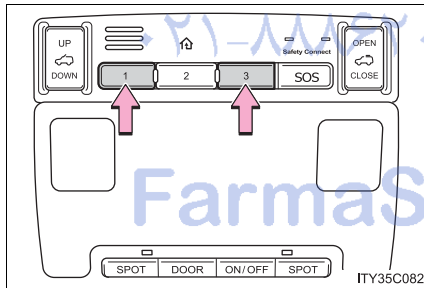

Press and hold the 2 outside buttons for 10 seconds until the indicator light flashes.

If you sell your vehicle, be sure to erase the programs stored in the HomeLink® memory.

### ■ Before programming

- Install a new battery in the remote control transmitter.
- The battery side of the remote control transmitter must be pointed away from the HomeLink® button.

### ■ Certification for the garage door opener

FCC ID: CB2070NHL4

This device complies with FCC rules part 15 and Industry Canada RSS-210. Operation is subject to the following two conditions: (1) This device may not cause harmful interference, and (2) This device must accept any interference that may be received including interference that may cause undesired operation.

WARNING: The transmitter has been tested and complies with FCC and IC rules. Changes or modifications not expressly approved by the party responsible for compliance could void the user's authority to operate the device. The term "IC:" before the certification/registration number only signifies that Industry Canada technical specifications were met.

### ■ When support is necessary

Visit on the web at [www.homelink.com](http://www.homelink.com) or call 1-800-355-3515.

### ⚠ CAUTION

#### ■ When programming a garage door or other remote control devices

The garage door or other devices may operate, so ensure people and objects are out of danger to prevent potential harm.

#### ■ Conforming to federal safety standards

Do not use the HomeLink® compatible transceiver with any garage door opener or device that lacks safety stop and reverse features as required by federal safety standards.

This includes any garage door that cannot detect an interfering object. A door or device without these features increases the risk of death or serious injury.

### 3-7. Other interior features

## Safety Connect\*

Safety Connect is a subscription-based telematics service that uses Global Positioning System (GPS) data and embedded cellular technology to provide safety and security features to subscribers. Safety Connect is supported by Toyota's designated response center, which operates 24 hours per day, 7 days per week.

Safety Connect service is available by subscription on select, telematics hardware-equipped vehicles.

By using the Safety Connect service, you are agreeing to be bound by the Telematics Subscription Service Agreement and its Terms and Conditions, as in effect and amended from time to time, a current copy of which is available at Toyota.com. All use of the Safety Connect service is subject to such then-applicable Terms and Conditions.

#### ■ System components

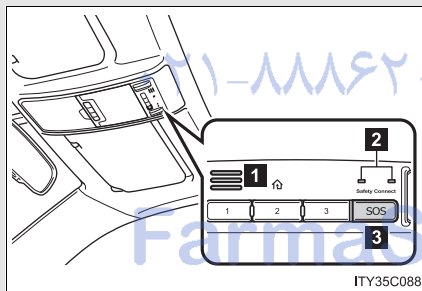

- 1 Microphone
- 2 LED light indicators
- 3 "SOS" button

\*: If equipped

■ **Services**

Subscribers have the following Safety Connect services available:

- **Automatic Collision Notification\***  
Helps drivers receive necessary response from emergency service providers. (→P. 409)  
\*: U.S. Patent No. 7,508,298 B2
- **Stolen Vehicle Location**  
Helps drivers in the event of vehicle theft. (→P. 410)
- **Emergency Assistance Button (SOS)**  
Connects drivers to response-center support. (→P. 410)
- **Roadside Assistance**  
Provides drivers various on-road assistance. (→P. 410)

■ **Subscription**

After you have signed the Telematics Subscription Service Agreement and are enrolled, you can begin receiving services. A variety of subscription terms is available for purchase. Contact your Toyota dealer, call 1-800-331-4331, or push the “SOS” button in your vehicle for further subscription details.

---

■ **Safety Connect Services Information**

- Phone calls using the vehicles Bluetooth® technology will not be possible during Safety Connect.
- Safety Connect is available beginning Fall 2009 on select Toyota models. Contact with the Safety Connect response center is dependent upon the telematics device being in operative condition, cellular connection availability, and GPS satellite signal reception, which can limit the ability to reach the response center or receive emergency service support. Enrollment and Telematics Subscription Service Agreement required. A variety of subscription terms is available; charges vary by subscription term selected.
- Safety Connect services will function in the United States, including Hawaii and Alaska, and in Canada. The services will not function outside of the United States in countries other than Canada. For details about the service, contact your Toyota dealer.
- Safety Connect services are not subject to section 255 of the Telecommunications Act and the device is not TTY compatible.

■ **Languages**

The Safety Connect response center will offer support in multiple languages. The Safety Connect system will offer voice prompts in English and Spanish. Please indicate your language of choice when enrolling.

■ **When contacting the response center**

You may be unable to contact the response center if the network is busy.



### Safety Connect LED light Indicators

When the “ENGINE START STOP” switch is turned to IGNITION ON mode, the red indicator light comes on for 2 seconds then turns off. Afterward, the green indicator light comes on, indicating that the service is active.

The following indicator light patterns indicate specific system usage conditions:

- Green indicator light on = Active service
- Green indicator light flashing = Safety Connect call in process
- Red indicator light (except at vehicle start-up) = System malfunction (contact your Toyota dealer)
- No indicator light (off) = Safety Connect service not active

### Safety Connect services

#### ■ Automatic Collision Notification

In case of either airbag deployment or severe rear-end collision, the system is designed to automatically call the response center. The responding agent receives the vehicle's location and attempts to speak with the vehicle occupants to assess the level of emergency. If the occupants are unable to communicate, the agent automatically treats the call as an emergency, contacts the nearest emergency services provider to describe the situation, and requests that assistance be sent to the location.

■ **Stolen Vehicle Location**

If your vehicle is stolen, Safety Connect can work with local authorities to assist them in locating and recovering the vehicle. After filing a police report, call the Safety Connect response center at 1-800-331-4331 and follow the prompts for Safety Connect to initiate this service.

In addition to assisting law enforcement with recovery of a stolen vehicle, Safety-Connect-equipped vehicle location data may, under certain circumstances, be shared with third parties to locate your vehicle. Further information is available at Toyota.com.

■ **Emergency Assistance Button (“SOS”)**

In the event of an emergency on the road, push the “SOS” button to reach the Safety Connect response center. The answering agent will determine your vehicle’s location, assess the emergency, and dispatch the necessary assistance required.

If you accidentally press the “SOS” button, tell the response-center agent that you are not experiencing an emergency.

■ **Roadside Assistance**

Subscribers can press the “SOS” button to reach a Safety Connect response-center agent, who can help with a wide range of needs, such as: towing, flat tire, fuel delivery, etc. For a description of the Roadside Assistance services and their limitations, please see the Safety Connect Terms and Conditions, which are available at Toyota.com.

### Safety information for Safety Connect

Important! Read this information before using Safety Connect.

#### ■ Exposure to radio frequency signals

The Safety Connect system installed in your vehicle is a low-power radio transmitter and receiver. It receives and also sends out radio frequency (RF) signals.

In August 1996, the Federal Communications Commission (FCC) adopted RF exposure guidelines with safety levels for mobile wireless phones. Those guidelines are consistent with the safety standards previously set by the following U.S. and international standards bodies.

- ANSI (American National Standards Institute) C95.1 [1992]
- NCRP (National Council on Radiation Protection and Measurement) Report 86 [1986]
- ICNIRP (International Commission on Non-Ionizing Radiation Protection) [1996]

Those standards were based on comprehensive and periodic evaluations of the relevant scientific literature. Over 120 scientists, engineers, and physicians from universities, and government health agencies and industries reviewed the available body of research to develop the ANSI Standard (C95.1).

The design of Safety Connect complies with the FCC guidelines in addition to those standards.

---

■ **License**

Licensed by QUALCOMM Incorporated under one or more of the following United States Patents and/or their counterparts in other nations:

4,901,307 5,490,165 5,056,109 5,504,773 5,101,501  
5,506,865 5,109,390 5,511,073 5,228,054 5,535,239  
5,267,261 5,544,196 5,267,262 5,568,483 5,337,338  
5,600,754 5,414,796 5,657,420 5,416,797 5,659,569  
5,710,784 5,778,338

■ **Certification for Safety Connect**

FCC ID: O9EGTM1

FCC ID: O6Y-CDMRF101

**NOTE:**

This device complies with part 15 of the FCC Rules. Operation is subject to the following two conditions: (1) This device may not cause harmful interference, and (2) this device must accept any interference received, including interference that may cause undesired operation.

**FCC WARNING:**

Changes or modifications not expressly approved by the party responsible for compliance could void the user's authority to operate the equipment.

FarmaSOS.com

**4-1. Maintenance and care**

- Cleaning and protecting the vehicle exterior..... 414
- Cleaning and protecting the vehicle interior..... 417

**4-2. Maintenance**

- Maintenance requirements ..... 420
- General maintenance..... 422
- Emission inspection and maintenance (I/M) programs ..... 425

**4-3. Do-it-yourself maintenance**

- Do-it-yourself service precautions ..... 426
- Hood ..... 429
- Engine compartment..... 430
- Tires ..... 445
- Tire inflation pressure ..... 454
- Wheels ..... 458
- Air conditioning filter..... 460
- Electronic key battery..... 463
- Checking and replacing fuses..... 466
- Light bulbs..... 479

#### 4-1. Maintenance and care

### Cleaning and protecting the vehicle exterior

**Perform the following to protect the vehicle and maintain it in prime condition.**

- Working from top to bottom, liberally apply water to the vehicle body, wheel wells and underside of the vehicle to remove any dirt and dust.

Wash the vehicle body using a sponge or soft cloth, such as a cham-  
ois.

- For hard-to-remove marks, use car wash soap and rinse thoroughly with water.
- Wipe away any water.
- Wax the vehicle when the waterproof coating deteriorates.

If water does not bead on a clean surface, apply wax when the vehicle body is cool.

---

تلفن شبانه روزی: ۰۲۱-۸۸۶۲۰۸۵

#### ■ Automatic car washes

- Fold the mirrors back and retract the antenna before washing the vehicle.
- Brushes used in automatic car washes may scratch the vehicle surface and harm your vehicle's paint.

#### ■ High pressure car washes

- Do not allow the nozzles of the car wash to come within close proximity of the windows.
- Before car wash, check that the fuel filler door is closed.

■ **Aluminum wheels**

- Remove any dirt immediately by using a neutral detergent. Do not use hard brushes or abrasive cleaners. Do not use strong or harsh chemical cleaners. Use the same mild detergent and wax as used on the paint.
- Do not use detergent on the wheels when they are hot, for example after driving for long distance in the hot weather.
- Wash detergent from the wheels immediately after use.

■ **Bumpers and side moldings**

Do not scrub with abrasive cleaners.

⚠ **CAUTION**

■ **Caution about the exhaust pipe**

Exhaust gasses cause the exhaust pipe to become quite hot. When washing the vehicle, be careful not to touch the pipe until it has cooled sufficiently, as touching a hot exhaust pipe can cause burns.

4

Maintenance and care

تلفن شبانه روزی: ۰۲۱-۸۸۶۲۰۸۵

FarmaSOS.com

 NOTICE

■ **To prevent paint deterioration and corrosion on the body and components (aluminum wheels etc.)**

- Wash the vehicle immediately in the following cases:
  - After driving near the sea coast
  - After driving on salted roads
  - If you see coal tar or tree sap on the paint surface
  - If you see dead insects or insect droppings on the paint
  - After driving in an area contaminated with soot, oily smoke, mine dust, iron powder or chemical substances
  - If the vehicle becomes heavily soiled in dust or mud
  - If liquids such as benzene and gasoline are spilled on the paint surface
- If the paint is chipped or scratched, have it repaired immediately.
- To prevent the wheels from corroding, remove any dirt and store in a place with low humidity when storing the wheels.

■ **Cleaning the exterior lights**

- Wash carefully. Do not use organic substances or scrub with a hard brush. This may damage the surfaces of the lights.
- Do not apply wax on the surface of the lights. Wax may cause damage to the lenses.

■ **When using an automatic car wash (vehicles with rain-sensing windshield wipers)**

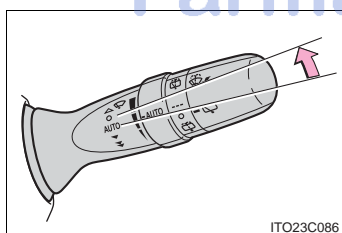

Turn off the wiper switch.

If the wiper switch is in "AUTO", the wipers may operate and the wiper blades may be damaged.



## Cleaning and protecting the vehicle interior

**The following procedures will help protect your vehicle's interior and keep it in top condition:**

### ■ Protecting the vehicle interior

Remove dirt and dust using a vacuum cleaner. Wipe dirty surfaces with a cloth dampened with lukewarm water.

### ■ Cleaning the leather areas

- Remove dirt and dust using a vacuum cleaner.
- Wipe any excess dirt and dust with a soft cloth dampened with diluted detergent.  
Use a diluted water solution of approximately 5% neutral wool detergent.
- Wring out any excess water from the cloth and thoroughly wipe off all remaining traces of detergent.
- Wipe the surface with a dry, soft cloth to remove any remaining moisture. Allow the leather to dry in shaded and ventilated area.

### ■ Synthetic leather areas

- Remove loose dirt using a vacuum cleaner.
- Apply a mild soap solution to the synthetic leather using a sponge or soft cloth.
- Allow the solution to soak in for a few minutes. Remove the dirt and wipe off the solution with a clean, damp cloth.

#### ■ Caring for leather areas

Toyota recommends cleaning the interior of the vehicle at least twice a year to maintain the quality of the vehicle's interior.

#### ■ Shampooing the carpets

There are several commercial foaming-type cleaners available. Use a sponge or brush to apply the foam. Rub in overlapping circles. Do not apply water. Excellent results are obtained by keeping the carpet as dry as possible.

#### ■ Seat belts

Clean with mild soap and lukewarm water using a cloth or sponge. Also check the belts periodically for excessive wear, fraying or cuts.

#### ⚠ CAUTION

##### ■ Water in the vehicle

- Do not splash or spill liquid in the vehicle.  
Doing so may cause electrical components etc. to malfunction or catch fire.
- Do not get any of the SRS components or wiring in the vehicle interior wet.  
(→P. 106)  
Electrical malfunction may cause the airbags to deploy or not function properly, resulting in death or serious injury.

##### ■ Cleaning the interior (especially instrument panel)

Do not use polish wax or polish cleaner. The instrument panel may reflect off the windshield, obstructing the driver's view and leading to an accident, resulting in death or serious injury.

 NOTICE

**■ Cleaning detergents**

- Do not use the following types of detergent, as they may discolor the vehicle interior or cause streaks or damage to painted surfaces.
  - Non-seat portions: Organic substances such as benzene or gasoline, alkaline or acidic solutions, dye, or bleach.
  - Seats: Acidic solutions, such as thinner, benzene, or alcohol.
- Do not use polish wax or polish cleaner. The instrument panel's or other interior part's painted surface may be damaged.

**■ Preventing damage to leather surfaces**

Observe the following precautions to avoid damage to and deterioration of leather surfaces.

- Remove any dust or dirt on leather surfaces immediately.
- Do not expose the vehicle to direct sunlight for extended periods of time. Park the vehicle in the shade, especially during summer.
- Do not place items made of vinyl, plastic, or that contain wax on the upholstery, as they may stick to the leather surface if the vehicle interior heats up significantly.

**■ Water on the floor**

Do not wash the vehicle floor with water.

Vehicle systems such as the audio system may be damaged if water comes into contact with electrical components under the floor of the vehicle, and may also cause the body to rust.

**■ Cleaning the inside of the rear window**

- Do not use glass cleaner to clean the rear window, as this may cause damage to the rear window defogger heater wires or antenna. Use a cloth dampened with lukewarm water to gently wipe the window clean. Wipe the window in strokes running parallel to the heater wires or antenna.
- Be careful not to scratch or damage the heater wires or antenna.

## 4-2. Maintenance

### Maintenance requirements

**To ensure safe and economical driving, day-to-day care and regular maintenance is essential. Toyota recommends the following maintenance.**

#### ■ General maintenance

Should be performed on a daily basis. This can be done by yourself or by a Toyota dealer.

#### ■ Scheduled maintenance

Should be performed at specified intervals according to the maintenance schedule.

For details about maintenance items and schedules, read the "Scheduled Maintenance Guide" or "Owner's Manual Supplement".

#### ■ Do-it-yourself maintenance

You can perform some maintenance procedures yourself. Please be aware that do-it-yourself maintenance may affect warranty coverage.

The use of Toyota service and repair manuals is recommended.

For details about warranty coverage, see the "Owner's Warranty Information Booklet" or "Owner's Manual Supplement".

#### ■ Repair and replacement

It is recommended that genuine Toyota parts be used for repair to ensure performance of each system. If non-Toyota parts are used in replacement or if a repair shop other than a Toyota dealer performs repairs, confirm the warranty coverage.

■ **Allow inspection and repairs to be performed by a Toyota dealer**

- Toyota technicians are well-trained specialists and are kept up to date with the latest service information. They are well informed about the operations of all systems on your vehicle.
- Keep a copy of the repair order. It proves that the maintenance that has been performed is under warranty coverage. If any problem should arise while your vehicle is under warranty, your Toyota dealer will promptly take care of it.

**⚠ CAUTION**

■ **Warning in handling of battery, oils, fuels, and fluids**

- Engine exhaust, some of its constituents, and a wide variety of automobile components contain or emit chemicals known to the State of California to cause cancer and birth defects and other reproductive harm. Work in a well ventilated area.
- Oils, fuels and fluids contained in vehicles as well as waste produced by component wear contain or emit chemicals known to the State of California to cause cancer and birth defects and other reproductive harm. Avoid exposure and wash any affected area immediately.
- Battery posts, terminals and related accessories contain lead and lead compounds which are known to cause brain damage. Wash your hands after handling. (→P. 441)

## 4-2. Maintenance General maintenance

Listed below are the general maintenance items that should be performed at the intervals specified in the “Owner’s Warranty Information Booklet” or “Owner’s Manual Supplement”. It is recommended that any problem you notice should be brought to the attention of your Toyota dealer or qualified service shop for advice.

### Engine compartment

Items	Check points
Battery	• Maintenance-free (→P. 441)
Brake fluid	• At the correct level? (→P. 438)
Engine coolant	• At the correct level? (→P. 436)
Engine oil	• At the correct level? (→P. 432)
Exhaust system	• No fumes or strange sounds?
Power steering fluid	• At the correct level? (→P. 440)
Radiator/condenser/hoses	• Not blocked with foreign matter? (→P. 437)
Washer fluid	• At the correct level? (→P. 444)

**Vehicle interior**

Items	Check points
Accelerator pedal	<ul style="list-style-type: none"> <li>Moves smoothly (without uneven pedal effort or catching)?</li> </ul>
Automatic transmission "Park" mechanism	<ul style="list-style-type: none"> <li>Can the vehicle be hold securely on an incline with the shift lever in "P"?</li> </ul>
Brake pedal	<ul style="list-style-type: none"> <li>Moves smoothly?</li> <li>Does it have appropriate clearance and correct amount of free play?</li> </ul>
Brakes	<ul style="list-style-type: none"> <li>Pulls to one side when applied?</li> <li>Loss of brake effectiveness?</li> <li>Spongy feeling brake pedal?</li> <li>Pedal almost touches floor?</li> </ul>
Head restraints	<ul style="list-style-type: none"> <li>Move smoothly and lock securely?</li> </ul>
Indicators/buzzers	<ul style="list-style-type: none"> <li>Function properly?</li> </ul>
Lights	<ul style="list-style-type: none"> <li>Do all the lights come on?</li> <li>Headlights aimed correctly?</li> </ul>
Parking brake	<ul style="list-style-type: none"> <li>Moves smoothly?</li> <li>Can hold the vehicle securely on an incline?</li> </ul>
Seat belts	<ul style="list-style-type: none"> <li>Does the seat belt system operate smoothly?</li> <li>Are the belts undamaged?</li> </ul>
Seats	<ul style="list-style-type: none"> <li>Do the seat controls operate properly?</li> </ul>
Steering wheel	<ul style="list-style-type: none"> <li>Moves smoothly?</li> <li>Has correct free play?</li> <li>No strange noises?</li> </ul>

**Vehicle exterior**

Items	Check points
Doors	<ul style="list-style-type: none"> <li>• Operate smoothly?</li> </ul>
Engine hood	<ul style="list-style-type: none"> <li>• The lock system works properly?</li> </ul>
Fluid leaks	<ul style="list-style-type: none"> <li>• Is there any leakage after parking?</li> </ul>
Tire	<ul style="list-style-type: none"> <li>• Inflation pressure is correct?</li> <li>• Tire surfaces not worn or damaged?</li> <li>• Tires rotated according to the maintenance schedule?</li> <li>• Wheel nuts are not loose?</li> </ul>

**⚠ CAUTION**

**■ If the engine is running**

Turn off the engine and ensure that there is adequate ventilation before performing maintenance checks.

FarmaSOS.com



**Some states have vehicle emission inspection programs which include OBD (On Board Diagnostics) checks. The OBD system monitors the operation of the emission control system.**

■ **If the malfunction indicator lamp comes on**

The OBD system determines that a problem exists somewhere in the emission control system. Your vehicle may not pass the I/M test and may need to be repaired. Contact your Toyota dealer to service the vehicle.

■ **Your vehicle may not pass the I/M test:**

- When the battery is disconnected or discharged

Readiness codes that are set during ordinary driving are erased.

Also, depending on your driving habits, the readiness codes may not be completely set.

- When the fuel tank cap is loose

The malfunction indicator lamp comes on as a temporary malfunction and your vehicle may not pass the I/M test.

■ **When the malfunction indicator lamp goes off after several driving trips**

The error code in the OBD system will not be cleared unless the vehicle is driven 40 or more times.

■ **If your vehicle does not pass the I/M test**

Contact your Toyota dealer to prepare the vehicle for re-testing.

#### 4-3. Do-it-yourself maintenance

### Do-it-yourself service precautions

**If you perform maintenance yourself, be sure to follow the correct procedure given in these sections.**

Items	Parts and tools
Battery condition (→P. 441)	<ul style="list-style-type: none"> <li>• Warm water</li> <li>• Baking soda</li> <li>• Grease</li> <li>• Conventional wrench (for terminal clamp bolts)</li> </ul>
Brake fluid level (→P. 438)	<ul style="list-style-type: none"> <li>• FMVSS No.116 DOT 3 or SAE J1703 brake fluid</li> <li>• Rag or paper towel</li> <li>• Funnel (used only for adding brake fluid)</li> </ul>
Engine coolant level (→P. 436)	<ul style="list-style-type: none"> <li>• "Toyota Super Long Life Coolant" or similar high quality ethylene glycol based non-silicate, non-amine, non-nitrite and non-borate coolant with long-life hybrid organic acid technology.</li> <li>• "Toyota Super Long Life Coolant" is pre-mixed with 50% coolant and 50% deionized water.</li> <li>• Funnel (used only for adding coolant)</li> </ul>
Engine oil level (→P. 432)	<ul style="list-style-type: none"> <li>• "Toyota Genuine Motor Oil" or equivalent</li> <li>• Rag or paper towel</li> <li>• Funnel (used only for adding engine oil)</li> </ul>
Fuses (→P. 466)	<ul style="list-style-type: none"> <li>• Fuse with same amperage rating as original</li> </ul>

#### 4-3. Do-it-yourself maintenance

Items	Parts and tools
Power steering fluid (→P. 440)	<ul style="list-style-type: none"><li>• Automatic transmission fluid DEXRON®II or III</li><li>• Rag or paper towel</li><li>• Funnel (used only for adding power steering fluid)</li></ul>
Radiator and condenser (→P. 437)	—
Tire inflation pressure (→P. 454)	<ul style="list-style-type: none"><li>• Tire pressure gauge</li><li>• Compressed air source</li></ul>
Washer fluid (→P. 444)	<ul style="list-style-type: none"><li>• Water</li><li>• Washer fluid containing antifreeze (for winter use)</li><li>• Funnel (used only for adding washer fluid)</li></ul>

4

Maintenance and care

تلفن شبانه روزی: ۰۲۱-۸۸۶۲۰۸۵

FarmaSOS.com

 CAUTION

The engine compartment contains many mechanisms and fluids that may move suddenly, become hot, or become electrically energized. To avoid death or serious injury.

■ **When working on the engine compartment**

- Keep hands, clothing, and tools away from the moving fan and engine drive belt.
- Be careful not to touch the engine, inverter, radiator, exhaust manifold, etc. right after driving as they may be hot. Oil and other fluids may also be hot.
- Do not leave anything that may burn easily, such as paper or rags, in the engine compartment.
- Do not smoke, cause sparks or expose an open flame to fuel or the battery. Fuel and battery fumes are flammable.
- Be extremely cautious when working on the battery. It contains poisonous and corrosive sulfuric acid.

■ **When working near the electric cooling fan or radiator grille**

Be sure the "ENGINE START STOP" switch is OFF.  
With the "ENGINE START STOP" switch in IGNITION ON mode, the electric cooling fan may automatically start to run if the air conditioning is on and/or if the coolant temperature is high. (→P. 437)

■ **When working on or under the vehicle**

- Do not get under the vehicle with just the jack supporting it. Always use automotive jack stands or other solid supports.
- Use eye protection to prevent flying or falling material, fluid spray, etc. from getting in your eyes.

 NOTICE

■ **If you remove the air cleaner filter**

Driving with the air cleaner filter removed may cause excessive engine wear due to dirt in the air. Also a backfire could cause a fire in the engine compartment.

## 4-3. Do-it-yourself maintenance Hood

Release the lock from the inside of the vehicle to open the hood.

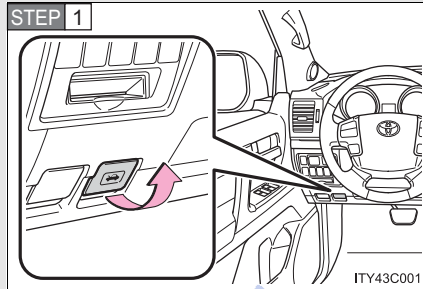

Pull the hood release lever.  
The hood will pop up slightly.

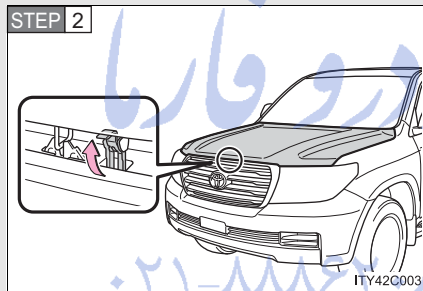

Lift the hood catch and lift the hood.

### ⚠ CAUTION

#### ■ Pre-driving check

Check that the hood is fully closed and locked.  
If the hood is not locked properly it may open while the vehicle is in motion and cause an accident, which may result in death or serious injury.

## 4-3. Do-it-yourself maintenance Engine compartment

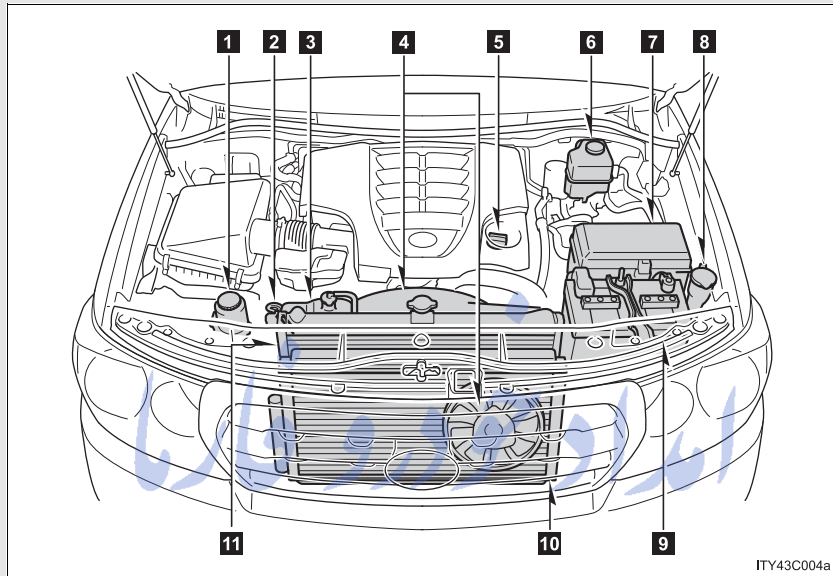

- |  |   |
|--|---|
| <b>1</b> Power steering fluid reservoir<br>(→P. 440) | <b>6</b> Brake fluid reservoir<br>(→P. 438) |
| <b>2</b> Engine oil level dipstick<br>(→P. 432)      | <b>7</b> Fuse box<br>(→P. 466)              |
| <b>3</b> Engine coolant reservoir<br>(→P. 436)       | <b>8</b> Washer fluid tank                  |
| <b>4</b> Cooling fans                                | <b>9</b> Battery<br>(→P. 441)               |
| <b>5</b> Engine oil filler cap<br>(→P. 433)          | <b>10</b> Condenser<br>(→P. 437)            |
|  | <b>11</b> Radiator<br>(→P. 437)             |

### Engine compartment cover

#### ■ Removing the engine compartment cover

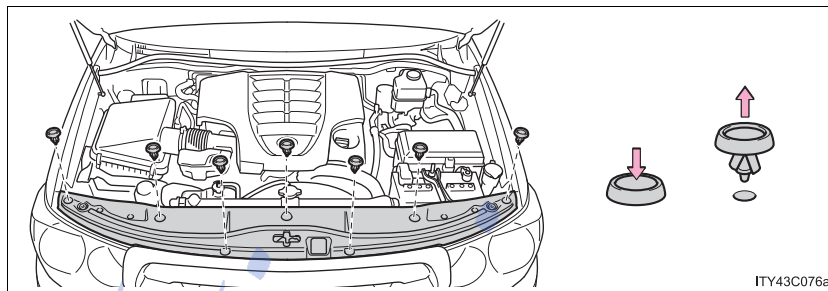

#### ■ Installing the clips

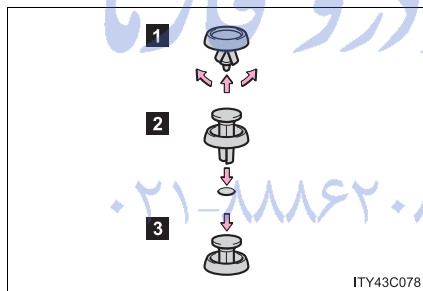

- 1 Push up center portion
- 2 Insert
- 3 Press

## Engine oil

With the engine at operating temperature and turned off, check the oil level on the dipstick.

### ■ Checking the engine oil

**STEP 1** Park the vehicle on level ground. After turning off the engine, wait more than 5 minutes for the oil to drain back into the bottom of the engine.

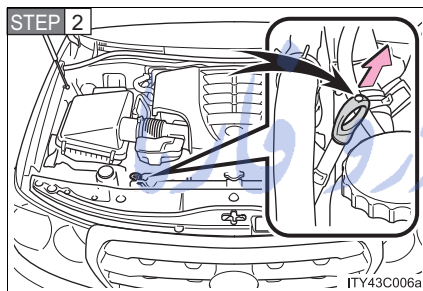

**STEP 2** Hold a rag under the end and pull the dipstick out.

The amount of oil to use when refilling or exchanging will differ depending on the color of the marker on the dipstick handle.

**STEP 3** Wipe the dipstick clean.

**STEP 4** Reinsert the dipstick fully.

**STEP 5** Holding a rag under the end, pull the dipstick out and check the oil level.

**STEP 6** Wipe the dipstick and reinsert it fully.

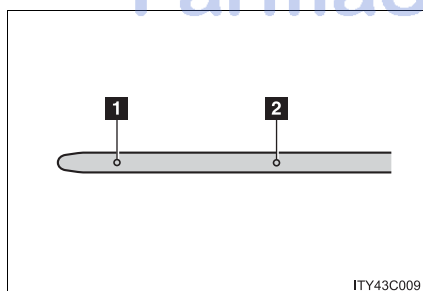

**1** Low

**2** Full



### ■ Adding engine oil

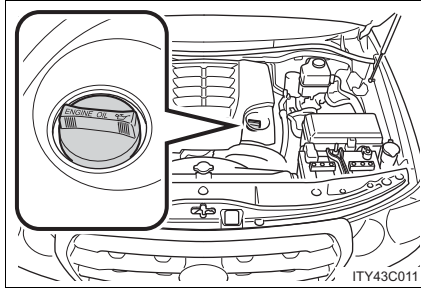

If the oil level is below or near the low level mark, add engine oil of the same type as already in the engine.

Make sure to check the oil type and prepare the items needed before adding oil.

Engine oil selection	→P. 551
Oil quantity (Low → Full)	1.2 qt. (1.1 L, 1.0 Imp. qt.)* <sup>1</sup> 1.6 qt. (1.5 L, 1.3 Imp.qt)* <sup>2</sup>
Items	Clean funnel

\*1: Vehicles with a blue-markered dipstick handle

\*2: Vehicles with a green-markered dipstick handle

(Location of the marker: →P. 432)

**STEP 1** Remove the oil filler cap.

**STEP 2** Add engine oil slowly, checking the dipstick.

**STEP 3** Install the filler cap, turning it clockwise.

#### ■ Engine oil consumption

- The amount of engine oil consumed depends on the oil viscosity, the quality of the oil and the way the vehicle is driven.
- More oil is consumed under driving conditions such as high speeds and frequent acceleration and deceleration.
- A new engine consumes more oil.
- When judging the amount of oil consumption, keep in mind that the oil may have become diluted, making it difficult to judge the true level accurately.
- Oil consumption: Max. 1.1 qt./600 miles (0.9 Imp.qt./600 miles, 1.0 L per 1000 km)
- If you consume more than 1.1 qt. (1.0 L, 0.9 Imp.qt.) every 600 miles (1000 km), contact your Toyota dealer.

#### ■ Resetting the engine oil maintenance data

The oil change system should be reset. Perform the following procedures:

- STEP 1** Switch the display to the trip meter A when the engine is running. (→P. 167)
- STEP 2** Turn the "ENGINE START STOP" switch OFF.
- STEP 3** While pressing the trip meter reset button, set the "ENGINE START STOP" switch to IGNITION ON mode (but do not start the engine because otherwise the reset mode will be cancelled). Continue to press and hold the button until the multi-information display indicates that the reset is complete.

**⚠ CAUTION****■ Used engine oil**

- Used engine oil contains potentially harmful contaminants which may cause skin disorders such as inflammation or skin cancer, so care should be taken to avoid prolonged and repeated contact. To remove used engine oil from your skin, wash thoroughly with soap and water.
- Dispose of used oil and filters only in a safe and acceptable manner. Do not dispose of used oil and filters in household trash, in sewers or onto the ground.  
Call your Toyota dealer, service station or auto parts store for information concerning recycling or disposal.
- Do not leave used engine oil within the reach of children.

**⚠ NOTICE****■ To prevent serious engine damage**

Check the oil level on regular basis.

**■ When replacing the engine oil**

- Be careful not to spill engine oil on the vehicle components.
- Avoid overfilling, or the engine could be damaged.
- Check the oil level on the dipstick every time you refill the vehicle.
- Be sure the engine oil filler cap is properly retightened.

### Engine coolant

The coolant level is satisfactory if it is between the “F” and “L” lines on the reservoir when the engine is cold.

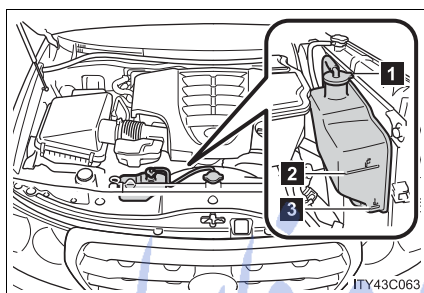

1 Reservoir cap

2 “F”

3 “L”

If the level is on or below the “L” line, add coolant up to the “F” line.

#### ■ If the coolant level drops within a short time after replenishing

Visually check the radiator, hoses, reservoir cap, radiator cap, drain cock and water pump.

If you cannot find a leak, have your Toyota dealer pressure test the cap and check for leaks in the cooling system.

#### ■ Coolant selection

Only use “Toyota Super Long Life Coolant” or similar high quality ethylene glycol based non-silicate, non-amine, non-nitrite, and non-borate coolant with long-life hybrid organic acid technology.

“Toyota Super Long Life Coolant” is a mixture of 50% coolant and 50% deionized water. (Enabled: -31°F [-35°C])

For more details about engine coolant, contact your Toyota dealer.

**⚠ CAUTION****■ When the engine is hot**

Do not remove the radiator cap.  
The cooling system may be under pressure and may spray hot coolant if the cap is removed, causing burns or other injuries.

**⚠ NOTICE****■ When adding the engine coolant**

Coolant is neither plain water nor straight antifreeze. The correct mixture of water and antifreeze must be used to provide proper lubrication, corrosion protection and cooling. Be sure to read the antifreeze or coolant label.

**■ If you spill coolant**

Be sure to wash it off with water to prevent it damage to parts or paint.

**Radiator and condenser**

Check the radiator and condenser and clear any foreign objects.  
If either of the above parts are extremely dirty or you are not sure of their condition, have your vehicle checked by your Toyota dealer.

**⚠ CAUTION****■ When the engine is hot**

Do not touch the radiator or condenser as they may be hot and you may be burned.

## Brake fluid

### ■ Checking fluid level

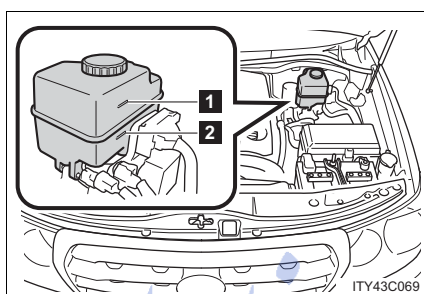

The brake fluid level should be between the “MAX” and “MIN” lines on the tank.

- 1 MAX
- 2 MIN

Make sure to check the fluid type and prepare the necessary items.

### ■ Adding fluid

Fluid type	FMVSS No.116 DOT 3 or SAE J1703 brake fluid
Items	Clean funnel

### ■ Refilling brake fluid

**STEP 1** Turn the “ENGINE START STOP” switch OFF.

**STEP 2** Depress the brake pedal more than 40 times.

**STEP 3** Remove the reservoir cap by hand. Add brake fluid up to the “MAX” line.

If you do not follow the procedure above, the reservoir may overflow.

■ **Brake fluid can absorb moisture from the air**

Excess moisture in the fluid can cause a dangerous loss of braking efficiency. Use only newly opened brake fluid.

 **CAUTION**

■ **When filling the reservoir**

Take care because brake fluid can harm your hands or eyes and damage painted surfaces.

If fluid gets in your eyes, flush your eyes with clean water immediately.

If you still experience discomfort, see a doctor.

 **NOTICE**

■ **If the fluid level is low or high**

It is normal for the brake fluid level to go down slightly as the brake pads wear or when the fluid level in the accumulator is high.

If the reservoir needs frequent refilling, it may indicate a serious problem.

### Power steering fluid

#### ■ Fluid level

The fluid level should be within the appropriate range.

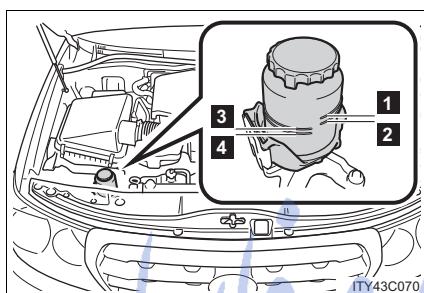

- 1 Full (when hot)
- 2 Add fluid (when hot)
- 3 Full (when cold)
- 4 Add fluid (when cold)

**Hot:** Vehicle has been driven around 50 mph (80 km/h) for 20 minutes, or slightly longer in frigid temperatures. (Fluid temperature, 140°F - 175°F [60°C - 80°C]).

**Cold:** Engine has not been run for about five hours. (Room temperature, 50°F - 85°F [10°C - 30°C]).

#### ■ Checking the fluid level

Make sure to check the fluid type and prepare the necessary items.

Fluid type	Automatic transmission fluid DEXRON® II or III
Items	Rag or paper, Clean funnel (only for adding fluid)

- STEP 1 Clean all dirt off the reservoir.
- STEP 2 Remove the cap by turning it counterclockwise.
- STEP 3 Wipe the dipstick clean.
- STEP 4 Reinstall and remove the reservoir cap again.
- STEP 5 Check the fluid level.



**⚠ CAUTION**

■ **When checking the reservoir**

Take care, as the reservoir may be hot.

**⚠ NOTICE**

■ **When adding fluid**

Avoid overfilling, or the power steering may be damaged.

■ **After replacing the reservoir cap**

Check the steering box case, vane pump and hose connections for leaks or damage.

**Battery**

■ **Exterior**

Make sure that the battery terminals are not corroded and that there are no loose connections, cracks, or loose clamps.

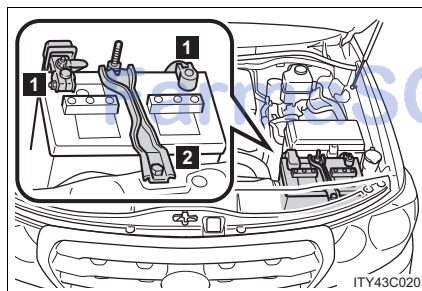

**1** Terminals

**2** Hold-down clamp

### ■ Checking battery condition (vehicles with the battery indicator)

Check the battery condition using the indicator color.

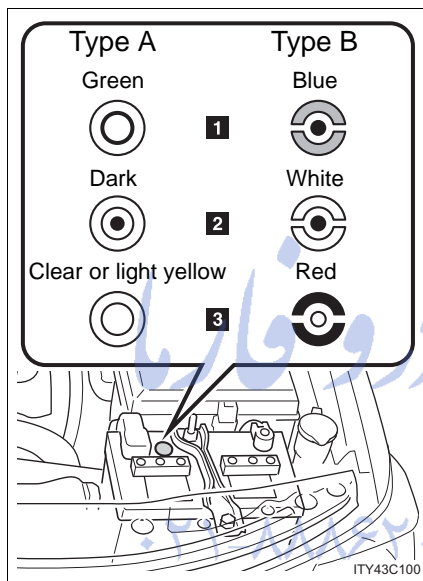

1 Good condition

2 Charging is necessary.

Have the vehicle inspected by your Toyota dealer.

3 Not working properly, have the battery checked by your Toyota dealer.

### ■ Before recharging

When recharging, the battery produces hydrogen gas which is flammable and explosive. Therefore, before recharging:

- If recharging with the battery installed on the vehicle, be sure to disconnect the ground cable.
- Make sure the power switch on the charger is off when connecting and disconnecting the charger cables to the battery.

### ■ After recharging the battery

The engine may not start. Follow the procedure below to initialize the system.

**STEP 1** Depress the brake pedal with the shift lever in "N".

**STEP 2** Open and close any of the doors.

**STEP 3** Restart the engine.

**⚠ CAUTION****■ Chemicals in the battery**

A battery contains poisonous and corrosive sulfuric acid and may produce hydrogen gas which is flammable and explosive. To reduce the risk of death or serious injury, take the following precautions while working on or near battery:

- Do not cause sparks by touching the battery terminals with tools.
- Do not smoke or light a match near the battery.
- Avoid contact with eyes, skin and clothes.
- Never inhale or swallow electrolyte.
- Wear protective safety glasses when working near the battery.
- Keep children away from the battery.

**■ Where to safely charge the battery**

Always charge the battery in an open area. Do not charge the battery in a garage or closed room where there is not sufficient ventilation.

**■ How to recharge the battery**

Only perform a slow charge (5A or less). The battery may explode if charged at a quicker rate.

**■ Emergency measures regarding electrolyte**

- If electrolyte gets in your eyes  
Flush your eyes with clean water for at least 15 minutes and get immediate medical attention. If possible, continue to apply water with a sponge or cloth while traveling to the nearest medical facility.
- If electrolyte gets on your skin  
Wash the affected area thoroughly. If you feel pain or a burning sensation, seek medical attention immediately.
- If electrolyte gets on your clothes  
It can soak through clothing on to your skin. Immediately take off the clothing and follow the procedure above if necessary.
- If you accidentally swallow electrolyte  
Drink a large quantity of water or milk. Follow with milk of magnesia, beaten raw egg or vegetable oil. Get emergency medical attention immediately.

#### 4-3. Do-it-yourself maintenance

##### NOTICE

###### ■ When recharging the battery

Never recharge the battery while the engine is running. Also, be sure all accessories are turned off.

##### Washer fluid

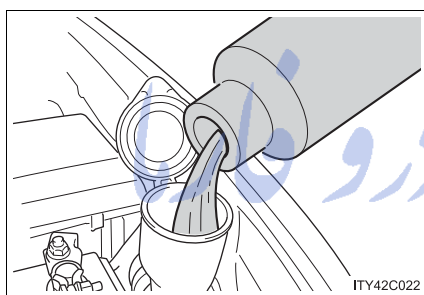

If any washer does not work or the warning message appears on the multi-information display, the washer tank may be empty. Add washer fluid.

##### CAUTION

###### ■ When refilling the washer fluid

Do not refill the washer fluid when the engine is hot or running, as the washer fluid contains alcohol and may catch fire if spilled on the engine etc.

##### NOTICE

###### ■ Do not use any fluid other than washer fluid

Do not use soapy water or engine antifreeze instead of washer fluid. Doing so may cause streaking on the vehicle's painted surfaces.

###### ■ Diluting washer fluid

Dilute washer fluid with water as necessary. Refer to the freezing temperatures listed on the washer fluid tank.

## 4-3. Do-it-yourself maintenance Tires

Replace or rotate tires in accordance with maintenance schedules and treadwear.

### ■ Checking tires

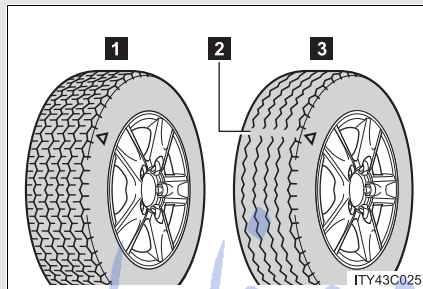

- 1 New tread
- 2 Treadwear indicator
- 3 Worn tread

The location of treadwear indicators is shown by the "TWI" or "Δ" marks, etc., molded on the sidewall of each tire.

Check spare tire condition and inflation pressure if not rotated.

### ■ Tire rotation

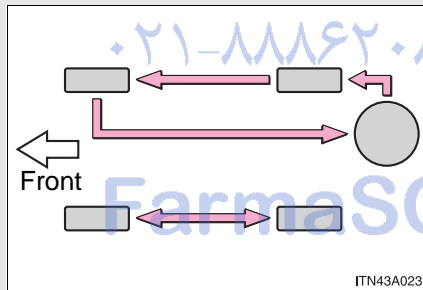

Rotate the tires in the order shown.

To equalize tire wear and extend tire life, Toyota recommends that tire rotation is carried out at the same interval as tire inspection.

Do not fail to initialize the tire pressure warning system after tire rotation.

### ■ The tire pressure warning system

Your Toyota is equipped with a tire pressure warning system that uses tire pressure warning valves and transmitters to detect low tire inflation pressure before serious problems arise. (→P. 505)

### **Installing tire pressure warning valves and transmitters**

When replacing tires or wheels, tire pressure warning valves and transmitters must also be installed.

When new tire pressure warning valves and transmitters are installed, new tire pressure warning valve and transmitter ID codes must be registered in the tire pressure warning computer and tire pressure warning system must be initialized. Have tire pressure warning valve and transmitter ID codes registered by your Toyota dealer. (→P. 446, 448)

### **Initializing the tire pressure warning system**

■ **The tire pressure warning system must be initialized in the following circumstances:**

- When rotating the tires on vehicles differing with front and rear tire inflation pressures.
- When changing the tire inflation pressure by changing traveling speed or load weight, etc.
- When changing the tire size.

When the tire pressure warning system is initialized, the current tire inflation pressure is set as the pressure benchmark.

### ■ How to initialize the tire pressure warning system

**STEP 1** Park the vehicle in safe place and turn the “ENGINE START STOP” switch to OFF.

While the vehicle is moving, initialization is not performed.

**STEP 2** Adjust the tire inflation pressure to the specified cold tire inflation pressure level. (→P. 556)

Make sure to adjust the tire pressure to the specified cold tire inflation pressure level. The tire pressure warning system will operate based on this pressure level.

**STEP 3** Turn the “ENGINE START STOP” switch to IGNITION ON mode.

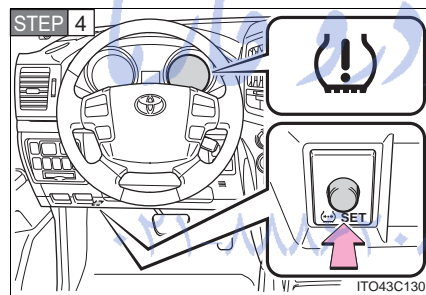

Press and hold the tire pressure warning reset switch until the tire pressure warning light blinks slowly 3 times and the message “TIRE PRESSURE RESET PROCEEDING” appears on the multi-information display.

**STEP 5** Wait for a few minutes with the IGNITION ON mode, and then turn the “ENGINE START STOP” switch to OFF.

### Registering ID codes

The tire pressure warning valve and transmitter is equipped with a unique ID code. When replacing a tire pressure warning valve and transmitter, it is necessary to register the ID code of tire pressure warning valve and transmitter. Have the ID code registered by your Toyota dealer.

#### ■ When to replace your vehicle's tires

Tires should be replaced if:

- You have tire damage such as cuts, splits, cracks deep enough to expose the fabric or bulges indicating internal damage
- A tire goes flat repeatedly or cannot be properly repaired due to the size or location of a cut or other damage

If you are not sure, consult with your Toyota dealer.

#### ■ Replacing tires and wheels

If the ID code of the tire pressure warning valve and transmitter is not registered, the tire pressure warning system will not work properly. After driving for about 20 minutes, the tire pressure warning light comes on after blinking for 1 minute to indicate a system malfunction.

#### ■ Tire life

Any tire over 6 years old must be checked by a qualified technician even if they have seldom or never been used or damage is not obvious.

#### ■ If the tread wears down below 0.16 in. (4 mm) on snow tires

The effectiveness of snow tires is lost.



### ■ Maximum load of tire

Check that the number given by dividing the maximum load by 1.10 of the replacement tire is greater than 1/2 of the Gross Axle Weight Ratings (GAWR) of either the front axle or the rear axle, whichever is greater.



For the GAWR, see the Certification Label. For the maximum load of the tire, see the load limit at maximum cold tire inflation pressure mentioned on the side-wall of the tire. (→P. 561)

### ■ Tire types

#### 1 Summer tires

Summer tires are high-speed performance tires best suited to highway driving under dry conditions. Since summer tires do not have the same traction performance as snow tires, summer tires are inadequate for driving on snow-covered or icy roads. For driving on snow-covered roads or icy roads, the use of snow tires is recommended. When installing snow tires, be sure to replace all four tires.

#### 2 All season tires

All season tires are designed to provide better traction in snow and to be adequate for driving in most winter conditions, as well as for use year round. All season tires, however, do not have adequate traction performance compared with snow tires in heavy or loose snow. Also, all season tires fall short in acceleration and handling performance compared with summer tires in highway driving.

#### 3 Snow tires

For driving on snow-covered roads or icy roads, we recommend using snow tires. If you need snow tires, select tires of the same size, construction and load capacity as the originally installed tires. Since your vehicle has radial tires as original equipment, make sure your snow tires also have radial construction. Do not install studded tires without first checking local regulations for possible restriction. Snow tires should be installed on all wheels. (→P. 228)

#### 4-3. Do-it-yourself maintenance

##### ■ Initializing the tire pressure warning system

Initialize the tire pressure warning system with the tire inflation pressure adjusted to the specified level.

##### ■ If you press the tire pressure reset switch accidentally

If initialization is performed, adjust the tire inflation pressure to the specified level and initialize the tire pressure warning system again.

##### ■ When the initialization of the tire pressure warning system has failed

Initialization can be completed in a few minutes. However, in the following cases, the settings have not been recorded and the system will not operate properly. If repeated attempts to record tire inflation pressure settings are unsuccessful, have the vehicle inspected by your Toyota dealer.

- When operating the tire pressure warning reset switch, the tire pressure warning light does not flash 3 times and the setting message does not appear on the multi-information display.
- After carrying out the initialization procedure, the tire pressure warning light blinks for 1 minute then stays on after driving for about 20 minutes.

##### ■ Routine tire inflation pressure checks

The tire pressure warning system does not replace routine tire inflation pressure checks. Make sure to check tire inflation pressure as part of your routine of daily vehicle checks.

■ **Tire pressure warning system certification**

FCC ID: PAXPMV107J

FCC ID: HYQ13BCX

This device complies with Part 15 of the FCC Rules. Operation is subject to the following two conditions: (1) this device may not cause harmful interference, and (2) this device must accept any interference received, including interference that may cause undesired operation.

FCC WARNING:

Changes or modifications not expressly approved by the party responsible for compliance could void the user's authority to operate the equipment.

امداد خودرو فارما

تلفن شبانه روزی: ۰۲۱-۸۸۸۶۲۰۸۵

FarmaSOS.com

 CAUTION

■ **Tire pressure warning system operation**

The tire pressure warning system may not provide warning immediately if a tire bursts or if sudden air leakage occurs.

■ **When inspecting or replacing tires**

Observe the following precautions to prevent accidents. Failure to do so may cause damage to parts of the drive train, as well as dangerous handling characteristics, which may lead to an accident resulting in death or serious injury.

- Do not mix tires of different makes, models or tread patterns.  
Also, do not mix tires of remarkably different treadwear.
- Do not use tire sizes other than those recommended by Toyota.
- Do not mix differently constructed tires (radial, bias-belted or bias-ply tires).
- Do not mix summer, all season and snow tires.
- Do not use tire that have been used on another vehicle.  
Do not use tires if you do not know they were used previously.

■ **When initializing the tire pressure warning system**

Do not push the tire pressure warning reset switch without first adjusting the tire inflation pressure to the specified level. Otherwise, the tire pressure warning light may not come on even if the tire inflation pressure is low, or it may come on when the tire inflation pressure is actually normal.

 NOTICE

■ **Repairing or replacing tires, wheels, tire pressure warning valves and transmitters and tire valve caps**

- When removing or fitting the wheels, tires or the tire pressure warning valve and transmitter, contact your Toyota dealer as the tire pressure warning valve and transmitter may be damaged if not handled correctly.
- When replacing tire valve caps, do not use tire valve caps other than those specified. The cap may become stuck.

■ **To avoid damaging the tire pressure warning valves and transmitters**

Do not use liquid sealants on flat tires.

■ **Driving on rough roads**

Take particular care when driving on roads with loose surfaces or pot-holes.

These conditions may cause losses in tire inflation pressure, reducing the cushioning ability of the tires. In addition driving on rough roads may cause damage to the tires themselves, as well as the vehicle's wheels and body.

■ **If tire inflation pressures become low while driving**

Do not continue driving, or your tires and/or wheels may be ruined.

## 4-3. Do-it-yourself maintenance Tire inflation pressure

### ■ Tire inflation pressure

The recommended cold tire inflation pressure and tire size is displayed on the tire and loading information label. (→P. 556)

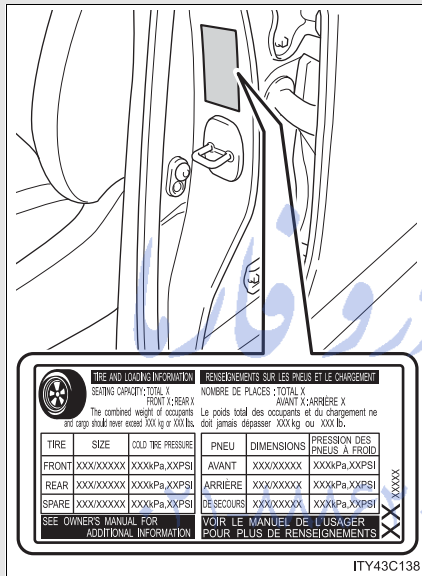

FarmaSOS.com

### ■ Inspection and adjustment procedure

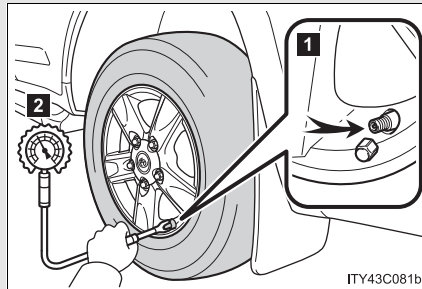

- 1 Tire valve
- 2 Tire pressure gauge

- STEP 1** Remove the tire valve cap.
- STEP 2** Press the tip of the tire pressure gauge onto the tire valve.
- STEP 3** Read the pressure using the graduations of the gauge.
- STEP 4** If the tire inflation pressure is not within the recommended levels, adjust tire pressure.  
If you add too much air, press the center of the valve to lower.
- STEP 5** After completing the tire inflation pressure measurement and adjustment, apply soapy water to the valve and check for leakage.
- STEP 6** Reinstall the tire valve cap.

### ■ Tire inflation pressure check interval

You should check tire inflation pressure every 2 weeks, or at least once a month.

Do not forget to check the spare.

■ **Effects of incorrect tire inflation pressure**

Driving with incorrect tire inflation pressure may result in the following:

- Reduced fuel efficiency
- Reduced driving comfort and tire life
- Reduced safety
- Damage to the drive train

If a tire needs frequent refilling, have it checked by your Toyota dealer.

■ **Instructions for checking tire inflation pressure**

When checking tire inflation pressure, observe the following:

- Check only when the tires are cold.  
If your vehicle has been parked for at least 3 hours and has not been driven for more than 1 mile or 1.5 km, you will get an accurate cold tire inflation pressure reading.
- Always use a tire pressure gauge.  
The appearance of the tire can be misleading. In addition, tire inflation pressures that are even just a few pounds off can degrade ride and handling.
- Do not bleed or reduce tire inflation pressure after driving. It is normal for the tire inflation pressure to be higher after driving.
- Never exceed the vehicle capacity weight.  
Passengers and luggage weight should be placed so that the vehicle is balanced.



**⚠ CAUTION****■ Proper inflation is critical to save tire performance**

Keep your tires properly inflated. Otherwise, the following conditions may occur and result in an accident causing death or serious injury.

- Excessive wear
- Uneven wear
- Poor handling
- Possibility of blowouts resulting from overheated tires
- Poor sealing of the tire bead
- Wheel deformation and/or tire separation
- A greater possibility of tire damage from road hazards

**⚠ NOTICE****■ When inspecting and adjusting tire inflation pressure**

Be sure to reinstall the tire valve caps. Without the valve caps, dirt or moisture could get into the valve and cause air leakage, which could result in an accident. If the caps have been lost, replace them as soon as possible.

## 4-3. Do-it-yourself maintenance

### Wheels

**If a wheel is bent, cracked or heavily corroded, it should be replaced.**

**Otherwise, the tire may separate from the wheel or cause loss of handling control.**

#### ■ Wheel selection

When replacing wheels, care should be taken to ensure that they are equivalent to those removed in load capacity, diameter, rim width, and inset\*.

Replacement wheels are available at your Toyota dealer.

\*: Conventionally referred to as "offset".

Toyota does not recommend using:

- Wheels of different sizes or types
- Used wheels
- Bent wheels that have been straightened

#### ■ Aluminum wheel precautions

- Use only Toyota wheel nuts and wrenches designed for use with your aluminum wheels.
- When rotating, repairing or changing your tires, check that the wheel nuts are still tight after driving 1000 miles (1600 km).
- Be careful not to damage the aluminum wheels when using tire chains.
- Use only Toyota genuine balance weights or equivalent and a plastic or rubber hammer when balancing your wheels.

### ■ When replacing wheels

The wheels of your Toyota are equipped with tire pressure warning valves and transmitters that allow the tire pressure warning system to provide advanced warning in the event of a loss in tire inflation pressure. Whenever wheels are replaced, the tire pressure warning valves and transmitters must be installed. (→P. 446)

### ⚠ CAUTION

#### ■ When replacing wheels

- Do not use wheels that are a different size from those recommended in the Owner's Manual, as this may result in loss of handling control.
- Never use an inner tube in a leaking wheel which is designed for a tubeless tire. Doing so may result in an accident, causing death or serious injury.

### ⚠ NOTICE

#### ■ Replacing tire pressure warning valves and transmitters

- Because tire repair or replacement may affect the tire pressure warning valves and transmitters, make sure to have tires serviced by your Toyota dealer or other qualified service shop. In addition, make sure to purchase your tire pressure warning valves and transmitters at your Toyota dealer.
- Ensure that only genuine Toyota wheels are used on your vehicle. Tire pressure warning valves and transmitters may not work properly with non-genuine wheels.

## 4-3. Do-it-yourself maintenance Air conditioning filter

The air conditioning filter must be cleaned or changed regularly to maintain air conditioning efficiency.

### ■ Removal method

**STEP 1** Turn the “ENGINE START STOP” switch IGNITION ON mode and switch to recirculated air mode, then turn the “ENGINE START STOP” switch OFF.

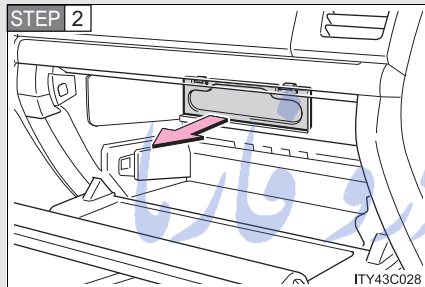

Open the glove box and remove the filter cover.

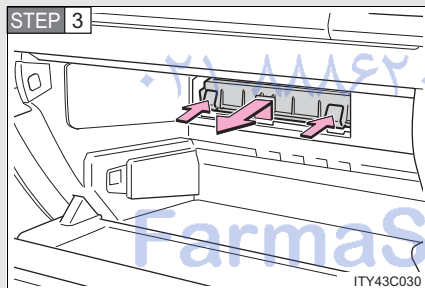

Remove the filter case.

■ **Cleaning method**

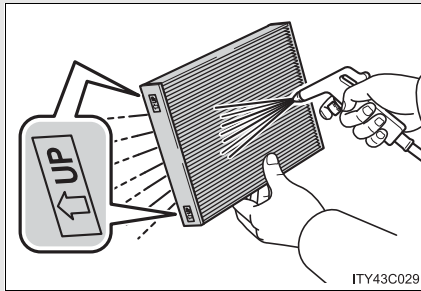

If the filter is dirty, clean by blowing compressed air through the filter from the downward side.

Hold the air gun 2 in. (5 cm) from the filter and blow for approximately 2 minutes at 72 psi (500 kPa, 5.0 kgf/cm<sup>2</sup> or bar).

If it is not available, have the filter cleaned by your Toyota dealer.

■ **Replacement method**

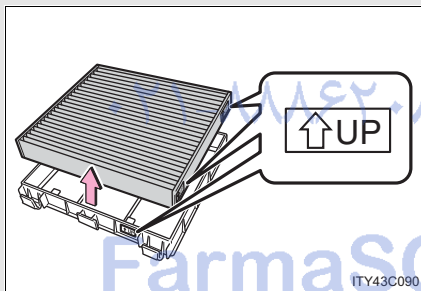

Remove the air conditioning filter and replace it with a new one.

The "UP" marks shown on the filter should be pointing up.

#### 4-3. Do-it-yourself maintenance

##### ■ Checking interval

Inspect, clean and replace the air conditioning filter according to the maintenance schedule. In dusty areas or areas with heavy traffic flow, more frequent cleaning or early replacement may be required. (For scheduled maintenance information, read the "Scheduled Maintenance Guide", "Owner's Manual Supplement".)

##### ■ If air flow from the vents decreases dramatically

The filter may be clogged. Check the filter and replace if necessary.

##### NOTICE

##### ■ To prevent damage to the system

- When using the air conditioning system, make sure that a filter is always installed.
- When cleaning the filter, do not clean the filter with water.

تلفن شبانه روزی: ۰۲۱-۸۸۶۲۰۸۵

FarmaSOS.com

### 4-3. Do-it-yourself maintenance Electronic key battery

Replace the battery with a new one if it is discharged.

■ You will need the following items:

- Flathead screwdriver (To prevent damage to the key, cover the tip of the screwdriver with rag.)
- Small Phillips-head screwdriver
- Lithium battery CR1632

■ Replacing the battery

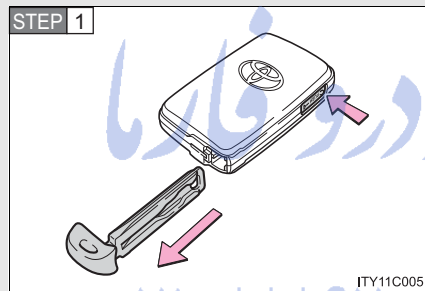

Take out the mechanical key.

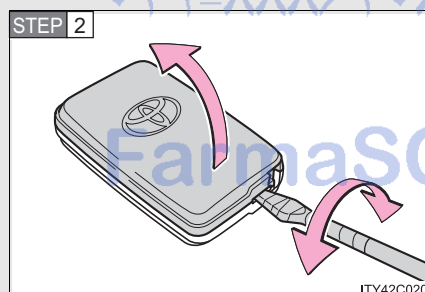

Remove the cover.

#### 4-3. Do-it-yourself maintenance

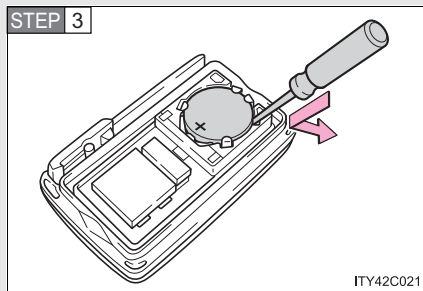

Remove the depleted battery.

Insert a new battery with the "+" terminal facing up.

#### ■ If the electronic key battery is discharged

The following symptoms may occur.

- The smart key system and wireless remote control will not function properly.
- The operational range is reduced.

#### ■ Use a CR1632 lithium battery

- Batteries can be purchased at your Toyota dealer, jewelers, or camera stores.
- Replace only with the same or equivalent type recommended by a Toyota dealer.
- Dispose of used batteries according to the local laws.



 CAUTION

■ **Removed battery and other parts**

Keep away from children. These parts are small and if swallowed by a child, they can cause choking. Failure to do so could result in death or serious injury.

 NOTICE

■ **For normal operation after replacing the battery**

Observe the following precautions to prevent accidents.

- Always work with dry hands.  
Moisture may cause the battery to rust.
- Do not touch or move any other components inside the electronic key.
- Do not bend the battery terminals.

تلفن شبانه روزی: ۰۲۱-۸۸۸۶۲۰۸۵

FarmaSOS.com

## 4-3. Do-it-yourself maintenance Checking and replacing fuses

**If any of the electrical components do not operate, a fuse may have blown. If this happens, check and replace the fuses as necessary.**

**STEP 1** Turn the “ENGINE START STOP” switch OFF.

**STEP 2** Open the fuse box cover.

► Engine compartment

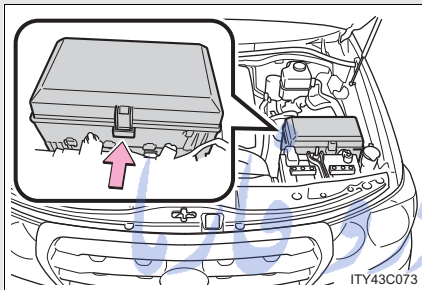

Push the tab in and lift the lid off.

► Driver's side instrument panel

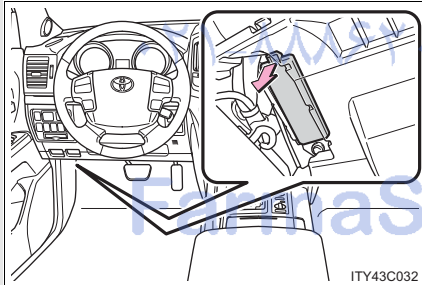

Remove the lid.

▶ Passenger's side instrument panel

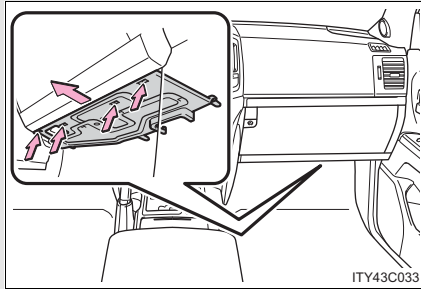

Remove the cover.

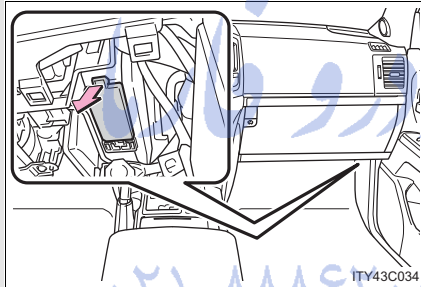

Remove the lid.

**STEP 3** After a system failure, see "Fuse layout and amperage ratings" (→P. 470) for details about which fuse to check.

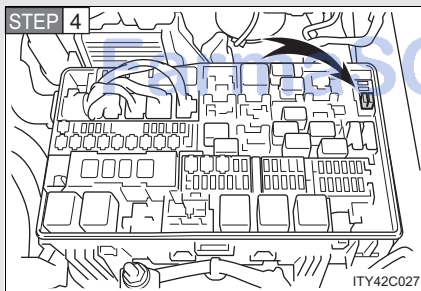

**STEP 4** Remove the fuse with the pull-out tool.

#### 4-3. Do-it-yourself maintenance

##### STEP 5 Check if the fuse has blown.

###### ► Type A and B

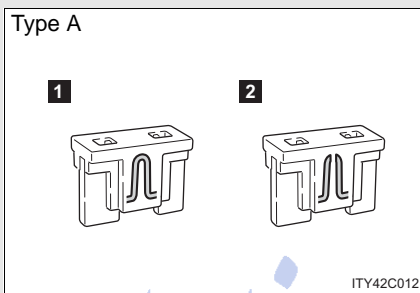

**1** Normal fuse

**2** Blown fuse

Replace it with one of an appropriate amperage rating. The amperage rating can be found on the fuse box lid.

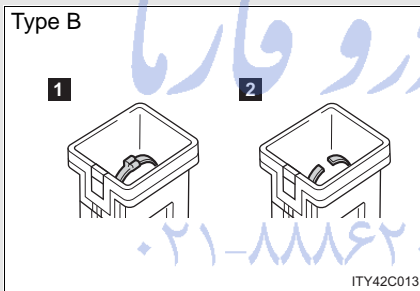

امداد خودرو فارما  
تلفن شبانه روزی: ۰۲۱-۸۸۶۲۰۸۵

FarmaSOS.com

► Type C and D

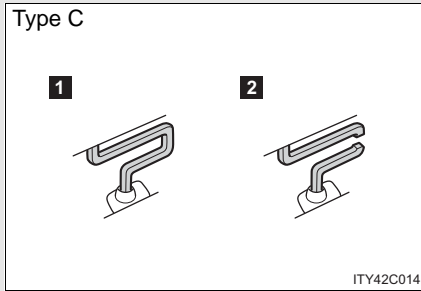

**1** Normal fuse

**2** Blown fuse

Contact your Toyota dealer.

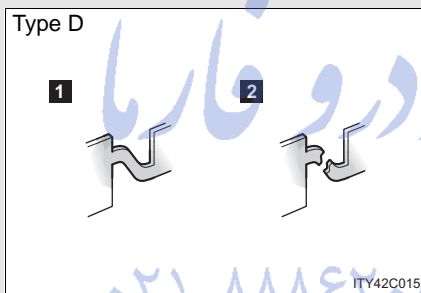

امداد خودرو فارما  
تلفن شبانه روزی: ۰۲۱ ۸۸۶۲۰۸۵

#### 4-3. Do-it-yourself maintenance

### Fuse layout and amperage ratings

#### ■ Engine compartment

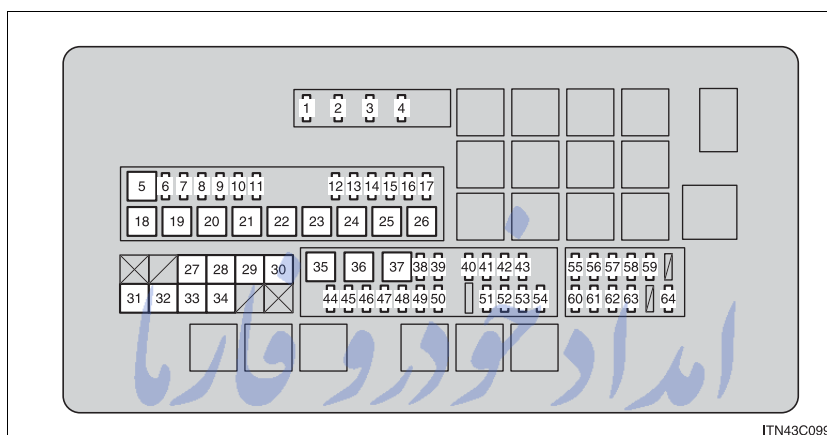

ITN43C099

Fuse	Ampere	Circuit
1	15 A	A/F heater
2	10 A	Horn
3	25 A	EFI, A/F heater
4	30 A	INJ, IGN, MET
5	50 A	No circuit
6	25 A	No circuit
7	20 A	Rear seat heater
8	20 A	Windshield wiper de-icer
9	25 A	Condenser fan
10	30 A	Towing tail
11	30 A	No circuit
12	10 A	No circuit
13	15 A	Front fog lights
14	5 A	Security horn
15	25 A	No circuit

### 4-3. Do-it-yourself maintenance

Fuse		Ampere	Circuit
16	STOP	15 A	Stoplights, high mounted stoplight, brake controller, towing converter, ABS, VSC, main body ECU, EFI, trailer
17	TOW BRK	30 A	Brake controller
18	RR AUTO A/C	50 A	Rear air conditioning system
19	PTC-1	50 A	PTC heater
20	PTC-2	50 A	PTC heater
21	PTC-3	50 A	PTC heater
22	RH-J/B	40 A	No circuit
23	SUB BATT	40 A	Towing
24	VGRS	40 A	No circuit
25	H-LP CLN	30 A	Headlight cleaner
26	DEFOG	30 A	Rear window defogger
27	AHC	60 A	No circuit
28	HTR	50 A	Front air conditioning system
29	PBD	30 A	No circuit
30	LH-J/B	150 A	Main body ECU
31	ALT	180 A	No circuit
32	A/PUMP NO.1	50 A	AI DRIVER
33	A/PUMP NO.2	50 A	AI DRIVER 2
34	MAIN	40 A	Headlight, daytime running light system, HEAD LL, HEAD RL, HEAD LH, HEAD RH
35	ABS1	50 A	ABS
36	ABS2	30 A	ABS
37	ST	30 A	Starter system
38	IMB	7.5 A	ID code box, smart key system, GBS
39	AM2	5 A	Main body ECU
40	DOM2	7.5 A	Vanity lights, overhead module, rear interior light

#### 4-3. Do-it-yourself maintenance

Fuse		Ampere	Circuit
41	ECU-B2	5 A	Driving position memory system
42	AMP 2	30 A	Audio system
43	RSE	7.5 A	Rear seat entertainment
44	TOWING	30 A	Towing
45	DOOR NO.2	25 A	Main body ECU
46	STR LOCK	20 A	Steering lock system
47	TURN-HAZ	15 A	Meter, front turn signal lights, rear turn signal lights, towing converter
48	EFI MAIN2	20 A	Fuel pump
49	ETCS	10 A	EFI
50	ALT-S	5 A	IC-ALT
51	AMP 1	30 A	Audio system
52	RAD NO.1	10 A	Navigation system, audio system
53	ECU-B1	5 A	Smart key system, overhead module, tilt and telescopic steering, meter, cool box, gateway ECU, steering sensor
54	DOME1	5 A	Illuminated entry system, clock
55	HEAD LH	15 A	Headlight high beam (left)
56	HEAD LL	15 A	Headlight low beam (left)
57	INJ	10 A	Injector, ignition system
58	MET	5 A	Meter
59	IGN	10 A	Circuit open, SRS airbag system, gateway ECU, occupant detection system, smart key system, ABS, VSC, steering lock system, GBS
60	HEAD RH	15 A	Headlight high beam (right)



#### 4-3. Do-it-yourself maintenance

	Fuse	Ampere	Circuit
61	HEAD RL	15 A	Headlight low beam (right)
62	EFI NO.2	7.5 A	Air injection system, air flow meter
63	RR A/C NO.2	7.5 A	No circuit
64	DEF NO.2	5 A	Outside rear view mirror defoggers

امداد خودرو فارما

تلفن شبانه روزی: ۰۲۱-۸۸۸۶۲۰۸۵

FarmaSOS.com

#### 4-3. Do-it-yourself maintenance

##### ■ Driver's side instrument panel

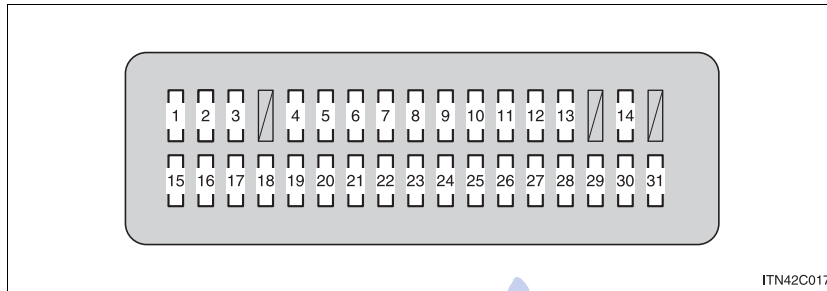

Fuse		Ampere	Circuit
1	CIG	15 A	Cigarette lighter
2	BK/UP LP	10 A	Back-up lights, trailer
3	ACC	7.5 A	Audio system, multi-display assembly, gateway ECU, main body ECU, mirror ECU, rear seat entertainment, smart key system, clock
4	PANEL	10 A	Four-wheel drive system, ash-tray, cigarette lighter, brake controller, cool box, cruise control, center differential lock, multi-display assembly, seat heater, air conditioning system, glove box light, emergency flashers, audio system, headlight cleaner switch, inverter, driving position memory system, outside rear view mirror switches, overhead module, roll sensing of curtain shield airbags off switch, shift lever switch, steering switches, VSC OFF switch, console switch

### 4-3. Do-it-yourself maintenance

Fuse		Ampere	Circuit
5	ECU-IG NO.2	10 A	Air conditioning system, heater, overhead module, ABS, VSC, steering sensor, yaw rate & G sensor, main body ECU, stoplights, moon roof, clock, EC mirror
6	WINCH	5 A	No circuit
7	A/C IG	10 A	Cool box, condenser fan, cooler compressor, rear window and outside rear view mirror defoggers, air conditioning system
8	TAIL	15 A	Tail lights, license plate lights, front fog lights, front side marker lights, rear side marker lights, parking lights
9	WIPER	30 A	Windshield wiper
10	WSH	20 A	Windshield washer
11	RR WIPER	15 A	Rear window wiper and washer
12	4WD	20 A	4WD
13	LH-IG	5 A	Alternator, sub battery, seat heater, windshield wiper de-icer, front seat belt, emergency flasher, inverter, shift lever switch
14	ECU-IG NO.1	5 A	ABS, VSC, tilt and telescopic steering, gateway ECU, shift lock system, cruise control system, pre-collision seat belt, headlight cleaner, multi-display assembly, driving position memory system, power door lock system
15	S/ROOF	25 A	Moon roof

#### 4-3. Do-it-yourself maintenance

	Fuse	Ampere	Circuit
16	RR DOOR RH	20 A	Power windows
17	MIR	15 A	Mirror ECU, outside rear view mirror defoggers
18	RR DOOR LH	20 A	Power windows
19	FR DOOR LH	20 A	Power windows
20	FR DOOR RH	20 A	Power windows
21	RR FOG	7.5 A	No circuit
22	A/C	7.5 A	Air conditioning system
23	AM1	5 A	No circuit
24	TI & TE	15 A	Tilt and telescopic steering
25	FR P/SEAT RH	30 A	Power seat
26	PWR OUTLET	15 A	Power outlet
27	OBD	7.5 A	On-Board diagnosis
28	PSB	30 A	Pre-collision seat belt
29	DOOR NO.1	25 A	Main body ECU
30	FR P/SEAT LH	30 A	Power seat
31	INVERTER	15 A	Inverter

تلفن شبانه روزی: ۰۲۱-۸۸۶۲۰۸۵

FarmaSOS.com

### ■ Passenger's side instrument panel

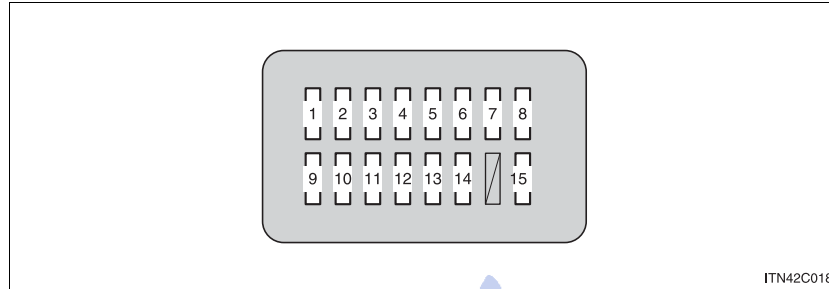

	Fuse	Ampere	Circuit
1	RSF LH	30 A	No circuit
2	B/DR CLSR RH	30 A	No circuit
3	B/DR CLSR LH	30 A	No circuit
4	RSF RH	30 A	No circuit
5	DOOR DL	15 A	No circuit
6	AHC-B	20 A	No circuit
7	TEL	5 A	Multimedia
8	TOW BK/UP	7.5 A	Towing
9	AHC-B NO.2	10 A	No circuit
10	ECU-IG NO.4	5 A	Tire pressure warning system
11	SEAT-A/C FAN	10 A	No circuit
12	SEAT-HTR	20 A	Seat heater
13	AFS	5 A	No circuit
14	ECU-IG NO.3	5 A	No circuit
15	TV	10 A	Multi-display assembly

#### 4-3. Do-it-yourself maintenance

##### ■ After a fuse is replaced

- If the lights do not turn on even after the fuse has been replaced, a bulb may need replacement. (→P. 479)
- If the replaced fuse blows again, have the vehicle inspected by your Toyota dealer.

##### ■ If there is an overload in the circuits

The fuses are designed to blow the entire wiring harness is damaged.

#### ⚠ CAUTION

##### ■ To prevent system breakdowns and vehicle fire

Observe the following precautions.  
Failing to do so may cause damage, and possibly a fire or injury.

- Never use a fuse of a higher amperage rating than indicated, or use any other object in place of a fuse.
- Always use a genuine Toyota fuse or equivalent.  
Never replace a fuse with a wire, even as a temporary fix.  
This can cause extensive damage or even fire.
- Do not modify fuses or the fuse box.

#### ⚠ NOTICE

##### ■ Before replacing fuses

Have the cause of electrical overload determined and repaired by your Toyota dealer.

## 4-3. Do-it-yourself maintenance

### Light bulbs

You may replace the following bulbs yourself. The difficulty level of replacement varies depending on the bulb. If necessary bulb replacement seems difficult to perform, contact your Toyota dealer.

For more information about replacing other light bulbs, contact your Toyota dealer.

#### ■ Prepare a replacement light bulb.

Check the wattage of the light bulb being replaced. (→P. 557)

#### ■ Remove the engine compartment cover.

→P. 431

#### ■ Front bulb locations

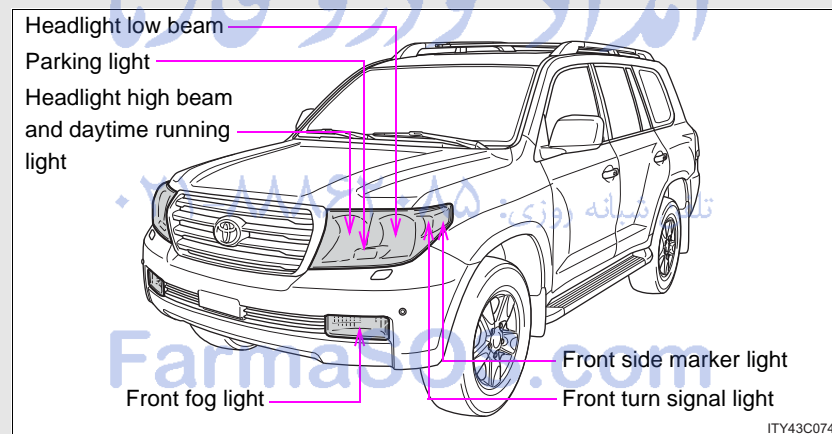

#### 4-3. Do-it-yourself maintenance

##### ■ Rear bulb locations

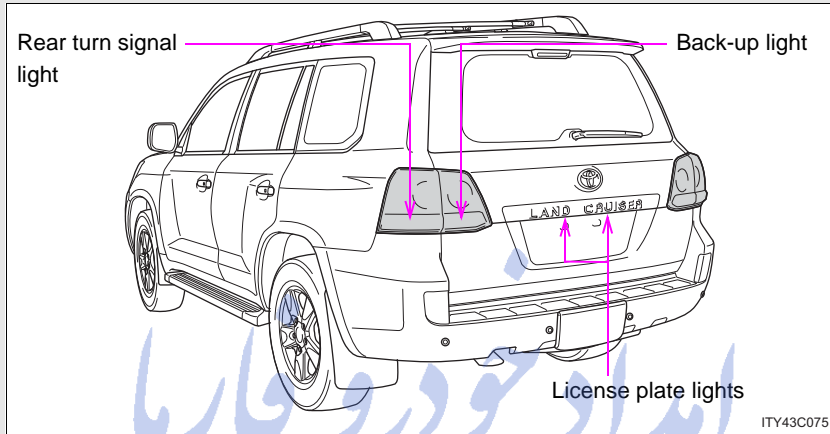

##### Replacing light bulbs

##### ■ Headlight low beam

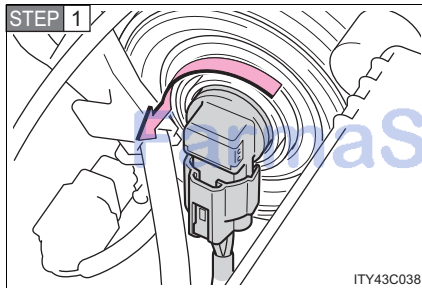

تلفن شایانه روزی: ۰۱۵-۸۸۶۲۰۱۵  
Turn the bulb base counterclockwise.



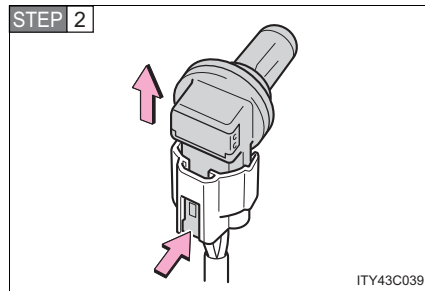

Unplug the connector while depressing the lock release.

■ Headlight high beam and daytime running light

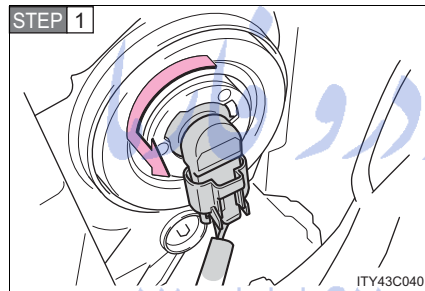

Turn the bulb base counterclockwise.

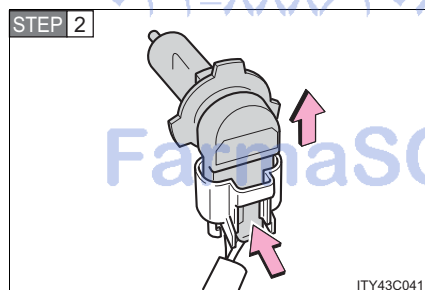

Unplug the connector while depressing the lock release.

■ Front fog light

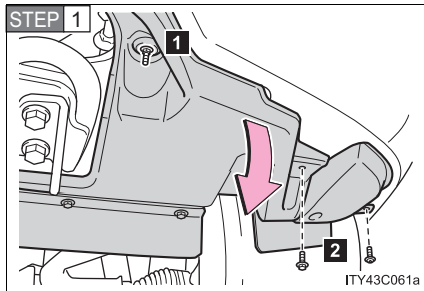

Remove the fender liner bolts, loose the fender liner nut and remove the fender liner.

- 1 Fender liner nut
- 2 Fender liner bolts

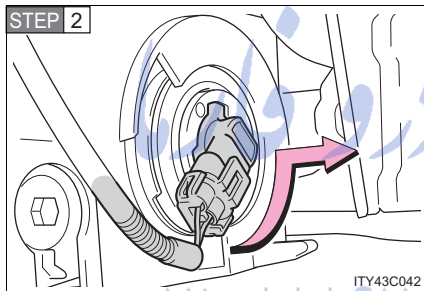

Turn the bulb base counterclockwise.

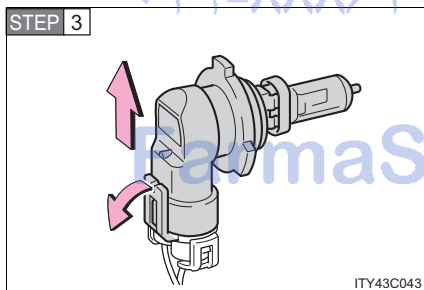

Unplug the connector while pulling the lock release.

■ Parking light

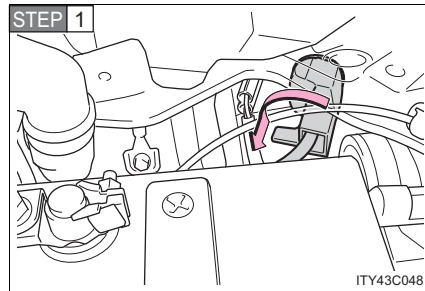

Turn the bulb base counterclockwise.

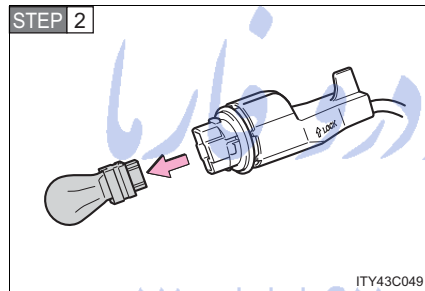

Remove the light bulb.

امداد خود بخاریا  
تلفن شبانه روزی: ۰۲۱-۸۸۶۲۰۸۵

FarmaSOS.com

#### 4-3. Do-it-yourself maintenance

##### ■ Front turn signal light

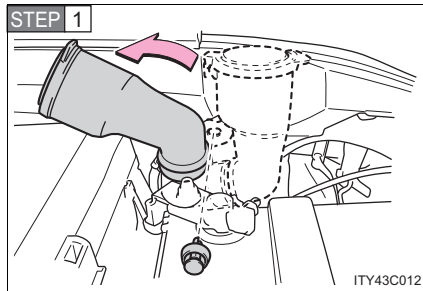

For the left side only: Remove the securing bolt and move the washer fluid filler opening.

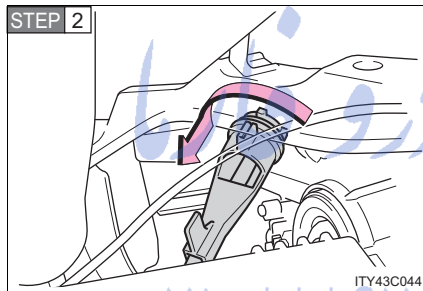

Turn the bulb base counterclockwise.

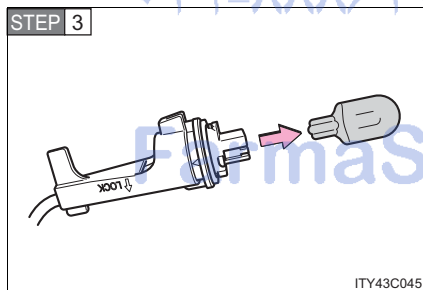

Remove the light bulb.

■ Front side marker light

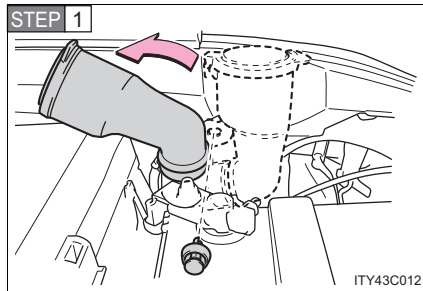

For the left side only: Remove the securing bolt and move the washer fluid filler opening.

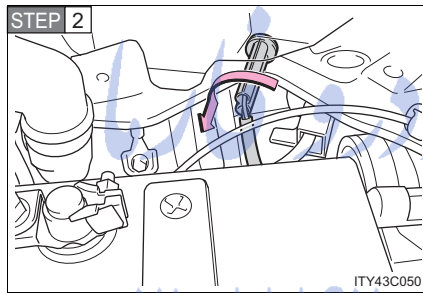

Turn the bulb base counterclockwise.

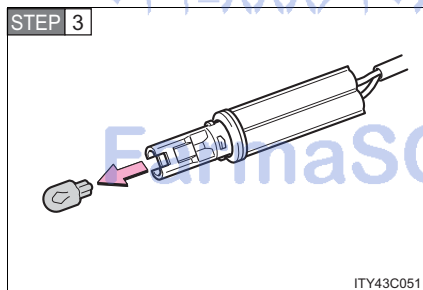

Remove the light bulb.

4-3. Do-it-yourself maintenance

■ Back-up light

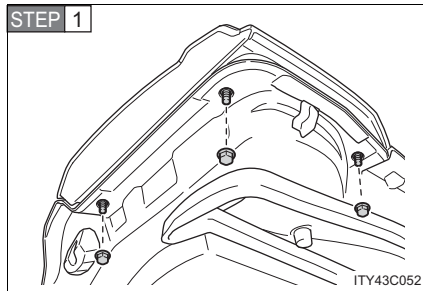

Open the back door and remove the nuts and lamp assembly.

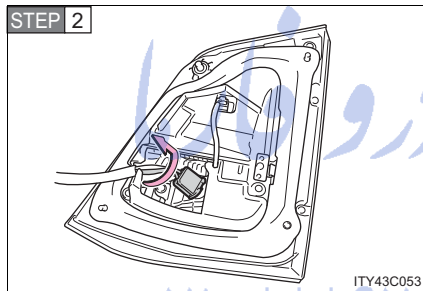

Turn the bulb bases counter-clockwise.

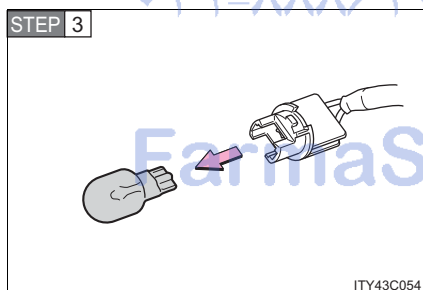

Remove the light bulb.

■ Rear turn signal light

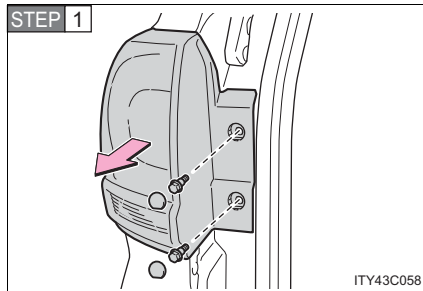

Open the back door and remove the bolts and lamp assembly.

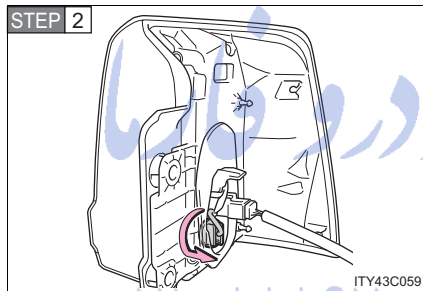

Turn the bulb bases counter-clockwise.

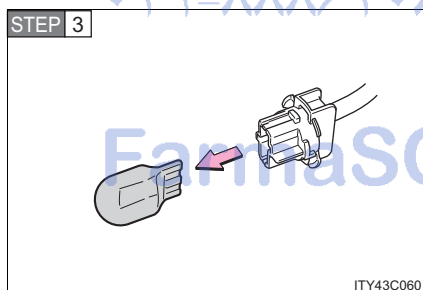

Remove the light bulb.

4-3. Do-it-yourself maintenance

■ License plate light

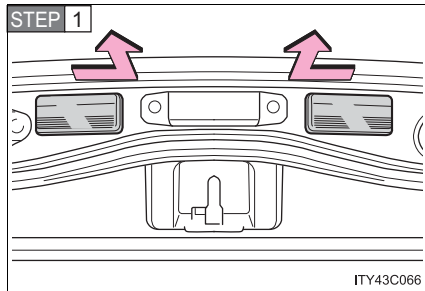

Open the back door and remove the license plate light unit.

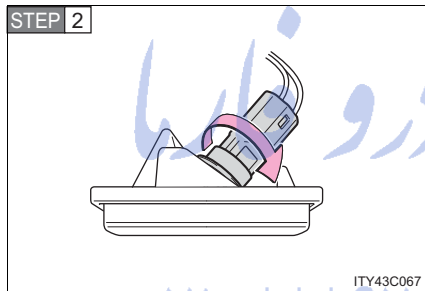

Turn the bulb base counterclockwise.

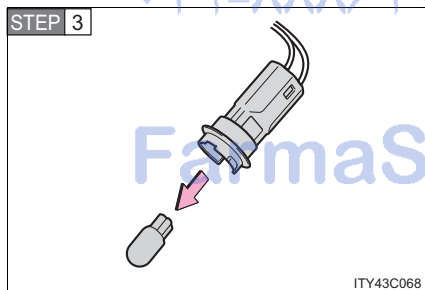

Remove the light bulb.



■ **Bulbs other than the above**

If any of the bulbs listed below has burnt out, have your Toyota dealer replace it.

- Stop/tail lights
- Tail lights
- High mounted stoplight
- Rear side marker lights

---

■ **Condensation build-up on the inside of the lens**

Contact your Toyota dealer for more information in the following situations. Temporary condensation build-up on the inside of the headlight lens does not indicate a malfunction.

- Large drops of water are built up on the inside of the lens.
- Water has built up inside the headlight.

■ **LED lights**

The stop/tail, tail, rear side marker lights and high mounted stoplight consist of a number of LEDs. If any LEDs burn out, take your vehicle to your Toyota dealer to have the light replaced.

FarmaSOS.com

 CAUTION

■ **Replacing light bulbs**

- Turn off the headlights. Do not attempt to replace the bulb immediately after turning off the headlights.  
The bulbs become very hot and may cause burns.
- Do not touch the glass portion of the light bulb with bare hands. Hold the bulb by the plastic or metal portion.  
If the bulb is scratched or dropped it may blow out or crack.
- Fully install light bulbs and any parts used to secure them. Failing to do so may result in heat damage, fire, or water entering the headlight unit. This may damage the headlights or cause condensation to build up on the lens.
- Do not attempt to repair or disassemble light bulbs, connectors, electric circuits or component parts.  
Doing so may result in death or serious injury due to electric shock.

■ **To prevent damage or fire**

Make sure bulbs are fully seated and locked.

تلفن شبانه روزی: ۰۲۱-۸۸۶۲۰۸۵

FarmaSOS.com

## When trouble arises

# 5

### 5-1. Essential information

Emergency flashers .....	492
If your vehicle needs to be towed .....	493
If you think something is wrong .....	498
Fuel pump shut off system .....	499
Event data recorder .....	500

### 5-2. Steps to take in an emergency

If a warning light turns on or a warning sounds... ..	502
If a warning message is displayed .....	513
If you have a flat tire.....	516
If the engine will not start.....	530
If the shift lever cannot be shifted from P.....	532
If you lose your keys .....	533
If you cannot operate back door opener.....	534
If the electronic key does not operate properly .....	535
If the battery is discharged.....	538
If your vehicle overheats .....	541
If the vehicle becomes stuck.....	544
If your vehicle has to be stopped in an emergency .....	545

## 5-1. Essential information Emergency flashers

**Use the emergency flashers if vehicle malfunctions or is involved in an accident.**

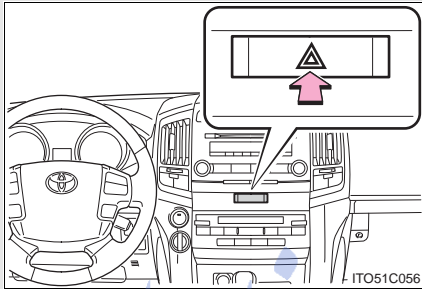

Press the switch to flash all the turn signal lights. To turn them off, press the switch once again.

### NOTICE

#### ■ To prevent battery discharge

Do not leave the emergency flashers on longer than necessary when the engine is not running.

تلفن شبانه روزی: ۰۲۱-۸۸۸۶۲۰۸۵

FarmaSOS.com

## 5-1. Essential information

### If your vehicle needs to be towed

**If towing is necessary, we recommend having your vehicle towed by your Toyota dealer or a commercial towing service, using a lift-type truck or a flat bed truck.**

**Use a safety chain system for all towing, and abide by all state/provincial and local laws.**

**Use a towing dolly or flat bed truck.**

#### Before towing

The following may indicate a problem with your transmission. Contact your Toyota dealer before towing.

- The engine is running, but the vehicle will not move.
- The vehicle makes an abnormal sound.

#### Emergency towing

If a tow truck is not available in an emergency, your vehicle may be temporarily towed using a cable or chain secured to the following part. This should only be attempted on hard, surfaced roads for short distances at low speeds.

A driver must be in the vehicle to steer and operate the brakes. The vehicle's wheels, drive train, axles, steering and brakes must be in good condition.

##### ► Towing hook

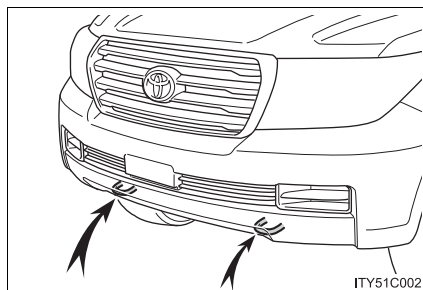

■ **Emergency towing procedure**

- STEP 1 The engine must be in ACCESSORY mode (engine off) or IGNITION ON mode (engine running).
- STEP 2 Put the four-wheel drive control switch in "H4". (The center differential is unlocked.)
- STEP 3 Put the shift lever in "N".
- STEP 4 Release the parking brake.

⚠ **CAUTION**

■ **While towing**

- Use extreme caution when towing the vehicle. Avoid sudden starts or erratic driving maneuvers which place excessive stress on the emergency towing hook and the cable or chain. Always use caution for the surroundings and other vehicles while towing.
- If the engine is not running, the power assist for the brakes and steering will not function, making steering and braking more difficult.

⚠ **NOTICE**

■ **To prevent causing serious damage to the transmission**

- Never tow this vehicle wheels on the ground.
- Use only the front emergency towing hooks or towing eyelets (depending on vehicles) when towing your vehicle.

**Towing with a sling-type truck**

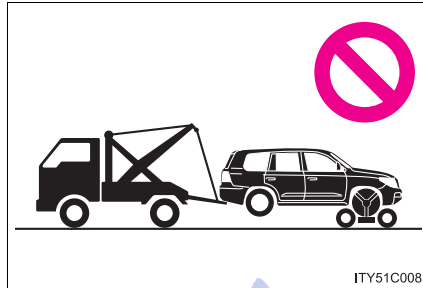

**⚠ NOTICE**

**■ To prevent body damage**

Do not tow with a sling type truck, either from the front or rear.

تلفن شبانه روزی: ۰۲۱-۸۸۶۲۰۸۵

FarmaSOS.com

## 5-1. Essential information

### Towing with a wheel lift-type truck

#### ► From front

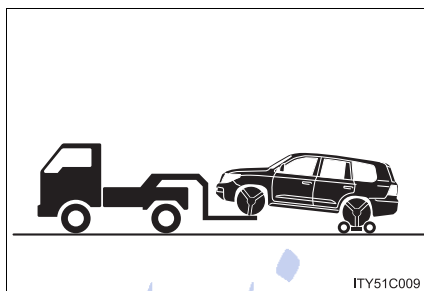

Use a towing dolly under the rear wheels.

#### ► From rear

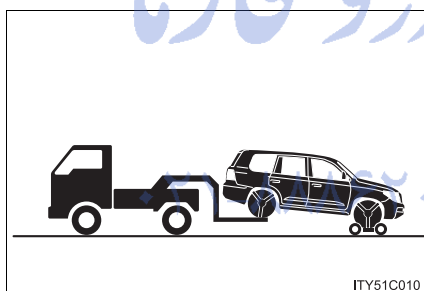

Use a towing dolly under the front wheels.

#### ⚠ NOTICE

##### ■ To prevent causing serious damage to the transmission

Never tow this vehicle wheels on the ground.

##### ■ To prevent damaging the vehicle

- Do not tow the vehicle with the “ENGINE START STOP” switch OFF. The steering lock mechanism is not strong enough to hold the front wheel straight.
- When raising the vehicle, ensure adequate ground clearance for towing at the opposite end of the raised vehicle. Without adequate clearance, the vehicle could be damaged while being towed.



**Using a flat bed truck**

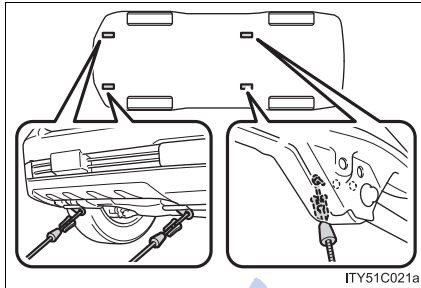

ITY51C021a

If your Toyota is transported by a flat bed truck, it should be tied down at the locations shown in the illustration. When attaching the hooks to the rear of the vehicle, make sure to attach them to the inside of the vehicle.

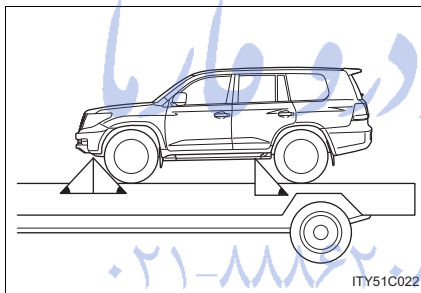

ITY51C022

If you use chains or cables to tie down your vehicle, the angles shaded in black must be 45°.

Do not overly tighten the tie downs or the vehicle may be damaged.

**⚠ NOTICE**

**■ To avoid serious damage to your vehicle**

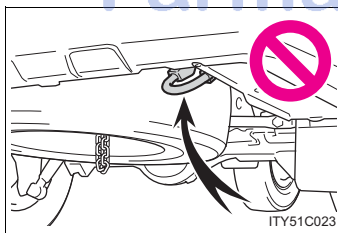

ITY51C023

Do not use the rear emergency towing hook.

## 5-1. Essential information

### If you think something is wrong

**If you notice any of the following symptoms, your vehicle probably needs adjustment or repair. Contact your Toyota dealer as soon as possible.**

#### ■ Visible symptoms

- Fluid leaks under the vehicle  
(Water dripping from the air conditioning after use is normal.)
- Flat-looking tires or uneven tire wear
- Engine coolant temperature gauge needle continually points higher than normal
- Engine oil pressure gauge continually points lower than normal
- Voltmeter continually points higher or lower than normal

#### ■ Audible symptoms

- Changes in exhaust sound
- Excessive tire squeal when cornering
- Strange noises related to the suspension system
- Pinging or other noises related to the engine

#### ■ Operational symptoms

- Engine missing, stumbling or running rough
- Appreciable loss of power
- Vehicle pulls heavily to one side when braking
- Vehicle pulls heavily to one side when driving on a level road
- Loss of brake effectiveness, spongy feeling, pedal almost touches the floor

## 5-1. Essential information Fuel pump shut off system

**To minimize the risk of fuel leakage when the engine stalls or an air-bag inflates upon collision, the fuel pump shut off system stops supplying fuel to the engine.**

Follow the procedure below to restart the engine after the system is activated.

**STEP 1** Turn the “ENGINE START STOP” switch to ACCESSORY mode or OFF.

**STEP 2** Restart the engine.

### NOTICE

#### ■ Before starting the engine

Inspect the ground under the vehicle.

If you find that fuel has leaked on to the ground, the fuel system has been damaged and is in need of repair. Do not restart the engine.

تلفن شبانه روزی: ۰۲۱-۸۸۸۶۲۰۸۵

FarmaSOS.com

5

When trouble arises

## 5-1. Essential information Event data recorder

**Your vehicle has computers that monitor and control certain aspects of your vehicle. These computers assist in driving and maintaining optimal vehicle performance.**

**Besides storing data useful for troubleshooting, there is a system to record data in a crash or a near car crash event. This is called an Event Data Recorder (EDR).**

### **In a crash or a near car crash event**

The SRS airbag sensor assembly contains the EDR. In a crash or a near car crash event, this device may record some or all of the following information:

- Engine speed
- Whether the brake pedal was applied or not
- Vehicle speed
- To what extent the accelerator pedal was depressed
- Position of the transmission shift lever
- Whether the driver and front passenger wore seat belts or not
- Driver's seat position
- Front passenger's occupant classification
- SRS airbag deployment data
- SRS airbag system diagnostic data

The information above is intended to be used for the purpose of improving vehicle safety performance. Unlike general data recorders, the EDR does not record sound data such as conversation between passengers.

**Disclosure of the data**

Toyota will not disclose the data recorded in an EDR to a third party except when:

- An agreement from the vehicle's owner (or the leasing company for a leased vehicle) is obtained
- Officially requested by the police or other authorities
- Used as a defense for Toyota in a law suit
- Ordered by a court

However, if necessary Toyota will:

- Use the data for research on Toyota vehicle safety performance
- Disclose the data to a third party for research purposes without disclosing details of the vehicle owner, and only when it is deemed necessary
- Disclose summarized data cleared of vehicle identification information to a non-Toyota organization for research purposes

FarmaSOS.com

## 5-2. Steps to take in an emergency

### If a warning light turns on or a warning sounds...

**Calmly perform the following actions if any of the warning lights turn on or flash. If a light turns on or flashes, but then turns off, this does not necessarily indicate a malfunction in the system.**

**Stop the vehicle immediately. Continuing to drive the vehicle may be dangerous.**

The following warning indicates a possible problem in the brake system. Immediately stop the vehicle in a safe place and contact your Toyota dealer.

Warning light	Warning light/Details
	<b>Brake system warning light (warning buzzer)*</b> <ul style="list-style-type: none"><li>• Low brake fluid</li><li>• Malfunction in the brake system</li></ul> This light also comes on when the parking brake is not released. If the light turns off after the parking brake is fully released, the system is operating normally.

\*:Parking brake engaged warning buzzer:

A buzzer will sound if the vehicle is driven at a speed of approximately 3 mph (5 km/h) or more.



**Stop the vehicle immediately.**

The following warning indicates the possibility of damage to the vehicle that may lead to an accident. Immediately stop the vehicle in a safe place and contact your Toyota dealer.



Warning light	Warning light/Details
	<b>Charging system warning light</b> Indicates a malfunction in the vehicle's charging system.

**Have the vehicle inspected by your Toyota dealer immediately.**

Failing to investigate the cause of the following warnings may lead to the system operating abnormally and possibly cause an accident. Have the vehicle inspected by your Toyota dealer immediately.

Warning light	Warning light/Details
	<b>Malfunction indicator lamp</b> Malfunction in: <ul style="list-style-type: none"> <li>• The emission control system;</li> <li>• The electronic engine control system;</li> <li>• The electronic throttle control system; or</li> <li>• The electronic automatic transmission control system.</li> </ul>
	<b>SRS warning light</b> Malfunction in: <ul style="list-style-type: none"> <li>• The SRS airbag system;</li> <li>• The front passenger occupant classification system; or</li> <li>• The seat belt pretensioner system.</li> </ul>

## 5-2. Steps to take in an emergency

Warning light	Warning light/Details
	<b>ABS warning light</b> Malfunction in: <ul style="list-style-type: none"> <li>• The ABS; or</li> <li>• The brake assist system.</li> </ul>
	<b>Pre-collision system warning light (if equipped)</b> Malfunction in the pre-collision system.

### Have the malfunction repaired immediately.

After taking the specified steps to correct the suspected problem, check that the warning light turns off.





Warning light	Warning light/Details	Correction procedure
	<b>Open door warning light (warning buzzer)*1</b> A door is not fully closed.	Check that all doors are closed.

تلفن شبانه روزی: ۰۲۱-۸۸۶۲۰۸۵

FarmaSOS.com





5-2. Steps to take in an emergency

Warning light	Warning light/Details	Correction procedure
	<b>Driver's seat belt reminder light (warning buzzer)*2</b> Warns the driver to fasten his/her seat belt.	Fasten the seat belt.
  (*3 PASSENGER *4 PASSENGER (On the center cluster)	<b>Front passenger's seat belt reminder light (warning buzzer)*2</b> Warns the front passenger to fasten his/her seat belt.	Fasten the seat belt.
	<b>Tire pressure warning light</b>	
	When the light comes on: Low tire inflation pressure.	Adjust the tire inflation pressure.
	When the light comes on after blinking for 1 minute: Malfunction in the tire pressure warning system.	Have the system checked by your Toyota dealer.
	<b>Unengaged "Park" warning light</b> The transmission "Park" mechanism is not engaged.	Shift four-wheel drive control to "H4" or "L4". (→P. 199)

5

When trouble arises

## 5-2. Steps to take in an emergency

Warning light	Warning light/Details	Correction procedure
	<p><b>Low fuel level warning light</b></p> <p>Indicates that remaining fuel is about 4.0 gal. (15.0 L, 3.3 Imp. gal.) or less.</p>	Refuel the vehicle.
	<p><b>Master warning light</b></p> <p>A buzzer sounds and the warning light comes on and flashes to indicate that the master warning system has detected a malfunction.</p>	Take appropriate action in accordance with the message displayed on the multi-information display.

\*1: Open door warning buzzer:

The open door warning buzzer sounds to alert one or more of the doors is not fully closed (with the vehicle having reached a speed of 3 mph [5 km/h]).

\*2: Driver's and front passenger's seat belt reminder buzzer:

The driver's and front passenger's seat belts reminder sounds to alert the driver and front passenger that his/her seat belt is not fastened. The buzzer sounds intermittently for 10 seconds after the vehicle had reached a speed of at least 12 mph (20 km/h). Then, if the seat belt is still unfastened, the buzzer will sound in a different tone for 20 more seconds.

\*3: Vehicles with navigation system

\*4: Vehicles without navigation system

**■ If the malfunction indicator lamp comes on while driving**

First check the following:

- Is the fuel empty?  
If it is, fill the fuel tank immediately.
- Is the fuel tank cap loose?  
If it is, tighten it securely.

The malfunction indicator lamp will go off after taking several driving trips. If the malfunction indicator lamp does not go off even after several trips, contact your Toyota dealer as soon as possible.

**■ If the low speed four-wheel drive indicator light or the center differential lock indicator light blinks**

Take the specified steps. (→P. 202)

If the brake system warning light or the malfunction indicator light also comes on, or the low speed four-wheel drive indicator light or the center differential lock indicator light continues to blink after taking the specified steps, there may be a malfunction in the engine, the brake system or the four-wheel drive system. In this case, you may not be able to transfer between "H4" and "L4" modes, and the center differential lock may not be able to be locked or unlocked. Have the vehicle inspected by your Toyota dealer immediately.

**■ Front passenger detection sensor and passenger seat belt reminder**

- If luggage is placed on the front passenger seat, the front passenger detection sensor may cause the warning light to flash, even if a passenger is not sitting in the seat.
- If a cushion is placed on the seat, the sensor may not detect a passenger, and the warning light may not operate properly.

## 5-2. Steps to take in an emergency

### ■ SRS warning light

This warning light system monitors the following:

- The airbag sensor assembly
- Front airbag sensors
- The curtain shield airbag sensors
- The side and curtain shield airbag sensors
- The seat belt buckle switches
- The driver's seat position sensor
- The belt tension sensor
- The inflators
- The interconnecting wiring and power sources
- The front passenger occupant classification ECU
- "AIR BAG ON" and "AIR BAG OFF" indicator lights
- The seat belt pretensioners
- The roll sensing of curtain shield airbags off indicator light

### ■ Changing the engine oil

Make sure to reset oil change system

### ■ When the tire pressure warning light comes on

Check the tire inflation pressure and adjust to the appropriate level. Pushing the tire pressure warning reset switch does not turn off the tire pressure warning light.

### ■ The tire pressure warning light may turn on due to natural causes

The tire pressure warning light may turn on due to natural causes such as natural air leaks or tire inflation pressure changes caused by temperature. In this case, adjusting the tire inflation pressure will turn off the warning light (after a few minutes).

### ■ When a tire is replaced with a spare tire

The spare tire is also equipped with the tire pressure warning valve and transmitter. The tire pressure warning light will turn on if the tire inflation pressure of the spare tire is low. If a tire goes flat, even though the flat tire is replaced with the spare tire, the tire pressure warning light does not turn off. Replace the spare tire with the repaired tire and adjust the proper tire inflation pressure. The tire pressure warning light will turn off after a few minutes.

### ■ If the tire pressure warning system is inoperative

The tire pressure warning system will be disabled in the following conditions:

(When the condition becomes normal, the system will work properly.)

- If tires not equipped with tire pressure warning valves and transmitters are used.
- If the ID code on the tire pressure warning valves and transmitters is not registered in the tire pressure warning computer.
- If the tire inflation pressure is 73 psi (500 kPa, 5.1 kgf/cm<sup>2</sup> or bar) or higher.

The tire pressure warning system may be disabled in the following conditions:

(When the condition becomes normal, the system will work properly.)

- If electronic devices or facilities using similar radio wave frequencies are nearby.
- If a radio set at similar frequencies is in use in the vehicle.
- If a window tint that affects the radio wave signals is installed.
- If there is a lot of snow or ice on the vehicle, in particular around the wheels or wheel housings.
- If non-genuine Toyota wheels are used. (Even if you use Toyota wheels, the tire pressure warning system may not work properly with some types of tires.)
- If tire chains are used.
- If the spare tire is in a location subject to poor radio wave signal reception.
- If a large metallic object which can interfere with signal reception is put in the luggage compartment.

## 5-2. Steps to take in an emergency

### ■ If the tire pressure warning light comes on after blinking for 1 minute frequently

If the tire pressure warning light comes on after blinking for 1 minute frequently when the “ENGINE START STOP” switch is turned to IGNITION ON mode, have it checked by Toyota dealer.

### ⚠ CAUTION

#### ■ If the tire pressure warning light comes on

Be sure to observe the following precautions. Failure to do so could cause loss of vehicle control and result in death or serious injury.

- Stop your vehicle in a safe place as soon as possible. Adjust the tire inflation pressure immediately.
- If the tire pressure warning light comes on even after tire inflation pressure adjustment, it is probable that you have a flat tire. Check the tires. If the tire is flat, change to the spare tire and have the flat tire repaired by the nearest Toyota dealer.
- Avoid abrupt maneuvering and braking. If the vehicle tires deteriorate, you could lose control of the steering wheel or the brakes.

#### ■ If a blowout or sudden air leakage should occur

The tire pressure warning system may not activate immediately.

FarmaSOS.com

 CAUTION**■ Maintenance of the tires**

Each tire, including the spare (if provided), should be checked monthly when cold and inflated to the inflation pressure recommended by the vehicle manufacturer on the vehicle placard or tire inflation pressure label (tire and load information label). (If your vehicle has tires of a different size than the size indicated on the vehicle placard or tire inflation pressure label [tire and load information label], you should determine the proper tire inflation pressure for those tires.)

As an added safety feature, your vehicle has been equipped with a tire pressure monitoring system (TPMS-tire pressure warning system) that illuminates a low tire pressure telltale (tire pressure warning light) when one or more of your tires is significantly under-inflated. Accordingly, when the low tire pressure telltale (tire pressure warning light) illuminates, you should stop and check your tires as soon as possible, and inflate them to the proper pressure. Driving on a significantly under-inflated tire causes the tire to overheat and can lead to tire failure. Under-inflation also reduces fuel efficiency and tire tread life, and may affect the vehicle's handling and stopping ability.

Please note that the TPMS (tire pressure warning system) is not a substitute for proper tire maintenance, and it is the driver's responsibility to maintain correct tire pressure, even if under-inflation has not reached the level to trigger illumination of the TPMS low tire pressure telltale (tire pressure warning light).

## 5-2. Steps to take in an emergency

### CAUTION

Your vehicle has also been equipped with a TPMS (tire pressure warning system) malfunction indicator to indicate when the system is not operating properly. The TPMS (tire pressure warning system) malfunction indicator is combined with the low tire pressure telltale (tire pressure warning light). When the system detects a malfunction, the telltale will flash for approximately one minute and then remain continuously illuminated. This sequence will continue upon subsequent vehicle start-ups as long as the malfunction exists. When the malfunction indicator is illuminated, the system may not be able to detect or signal low tire pressure as intended.

TPMS (tire pressure warning system) malfunctions may occur for a variety of reasons, including the installation of replacement or alternate tires or wheels on the vehicle that prevent the TPMS (tire pressure warning system) from functioning properly. Always check the TPMS (tire pressure warning system) malfunction telltale after replacing one or more tires or wheels on your vehicle to ensure that the replacement or alternate tires and wheels allow the TPMS (tire pressure warning system) to continue to function properly.

### NOTICE

#### ■ **Precaution when installing a different tire**

When a tire of a different specification or maker is installed, the tire pressure warning system may not operate properly.



## 5-2. Steps to take in an emergency If a warning message is displayed

The multi-information display shows warnings of system malfunctions, incorrectly performed operations, or shows messages that indicate a need for maintenance. When a message is shown, perform the correction procedure appropriate to the message.

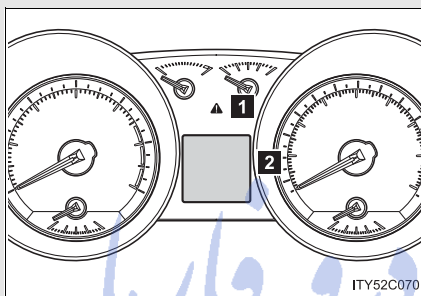

### 1 Master warning light

The master warning light comes on or flashes when a message is being shown on the multi-information display.

### 2 Multi-information display

If any of the warning messages is shown again after its correction procedure has been performed, contact your Toyota dealer.

## Messages and warnings

The warning lights and warning buzzers operate as follows depending on the content of the message. If a message indicates the need for inspection by a dealer, have the vehicle inspected immediately by your Toyota dealer.

## 5-2. Steps to take in an emergency

	System warning light	Warning buzzer*	Warning
Comes on	—	Sounds	Indicates an important situation, such as when a system related to driving is malfunctioning or that danger may result if the correction procedure is not performed.
—	Comes on or flashes	Sounds	Indicates an important situation, such as when the system shown on the multi-information display may be malfunctioning.
Comes on	—	Does not sound	Indicates a condition, such as malfunction of electrical components, their condition, or indicates the need for maintenance.
Flashes	—	Does not sound	Indicates a situation, such as when an operation has been performed incorrectly, or indicates how to perform an operation correctly.

\*: A buzzer sounds first time a message is shown on the multi-information display.

### ■ System warning lights

The master warning light does not come on or flash in the following cases. Instead, a separate system warning light will come on or flash along with the message shown on the multi-information display.

- Malfunction of the brake system  
The brake system warning light (red indicator) comes on. (→P. 502)
- Malfunction of the ABS  
The ABS warning light comes on. (→P. 504)
- Malfunction of the charging system  
The charging system warning light comes on. (→P. 503)

### ■ Resetting the tire pressure warning data

After adjusting the tire inflation pressure, be sure to initialize the data. (→P. 446)

If the message remains on, the system may have malfunctioned. Have the vehicle inspected by your Toyota dealer as soon as possible.

#### NOTICE

#### ■ Engine oil maintenance message

The warning message is based on the projected driving range after engine oil maintenance message is reset.

The system does not monitor the purity of the engine oil.

## 5-2. Steps to take in an emergency If you have a flat tire

**Remove the flat tire and replace it with the spare provided.**

■ **Before jacking up the vehicle**

- Stop the vehicle on a hard, flat surface.
- Set the parking brake.
- Shift the shift lever to "P".
- Stop the engine.
- Turn on the emergency flashers.

■ **Location of the spare tire, jack and tools**

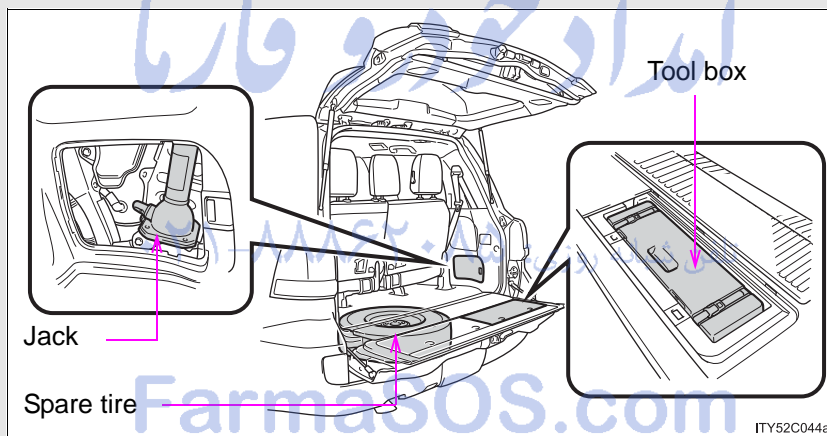

### Taking out the jack

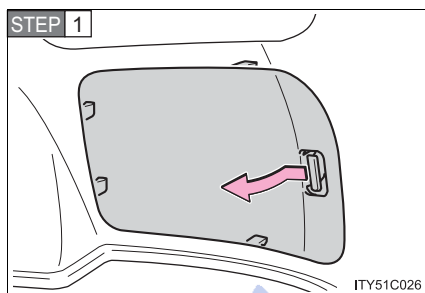

Remove the cover.

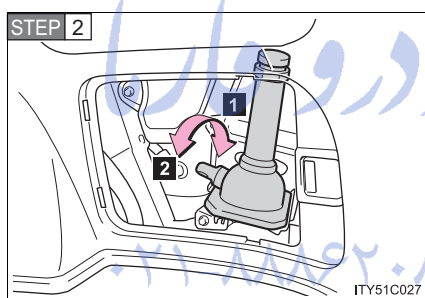

**1** Loosen  
**2** Tighten  
Loosen and remove the jack.

FarmaSOS.com

5-2. Steps to take in an emergency

**Taking out the tool box**

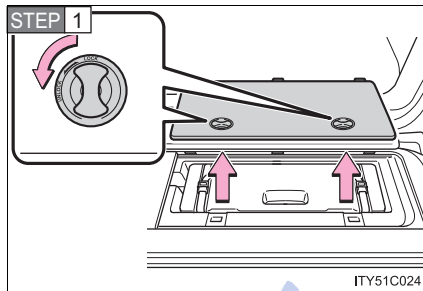

Remove the cover.

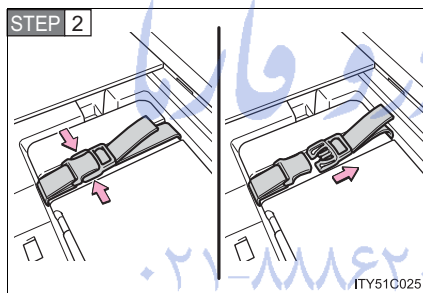

Take out the tool box.

امداد خود فایده  
تلفن شبانه روزی: ۰۲۱-۸۸۸۶۲۰۸۵  
FarmaSOS.com

### Taking out the spare tire

#### STEP 1 Assembling the jack handle.

Remove the jack handle and the jack extension bar from the tool box and assemble by following these steps.

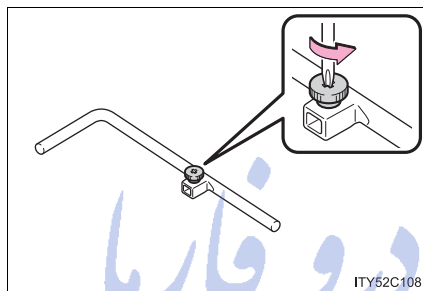

**1** Loosen the screw using a screwdriver.

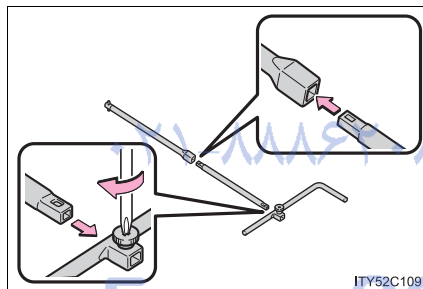

**2** Assemble the jack handle and the jack handle extension bar and tighten the screw.

Check that the screw is firmly tightened.

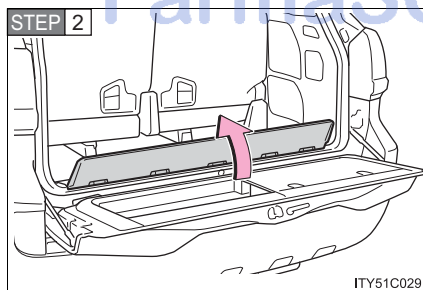

#### STEP 2

Open the cover.

## 5-2. Steps to take in an emergency

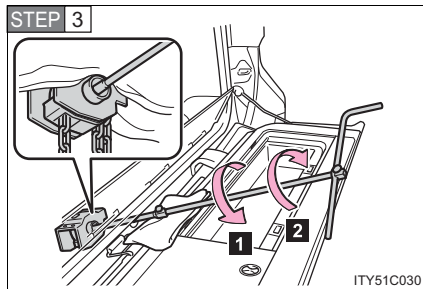

Insert the jack handle extension into the lowering screw.

**1** Lower

**2** Raise

Place a rag under the jack handle extension to protect the back door.

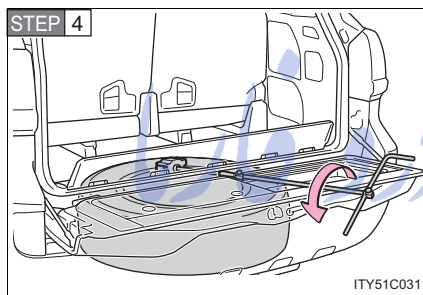

Lower the spare tire completely to the ground.

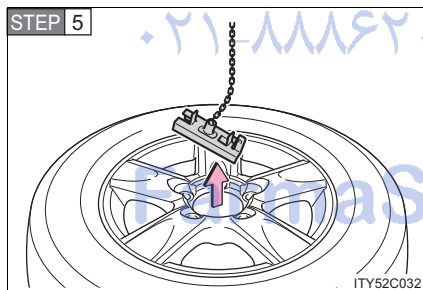

Pull out the spare tire and remove the holding bracket.



**Replacing a flat tire**

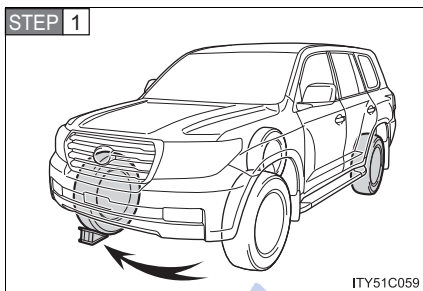

Chock the tires.

	Flat tire	Wheel chock position
Front	Left-hand side	Behind the rear right-hand side tire
	Right-hand side	Behind the rear left-hand side tire
Rear	Left-hand side	In front of the front right-hand side tire
	Right-hand side	In front of the front left-hand side tire

FarmaSOS.com

## 5-2. Steps to take in an emergency

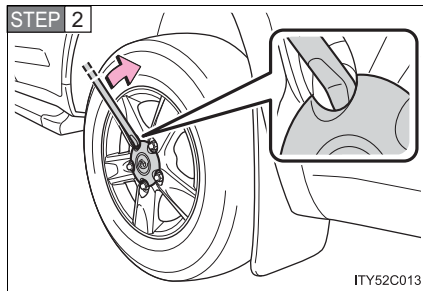

Pry off the wheel ornament, using the beveled end of the wheel ornament remover as shown.

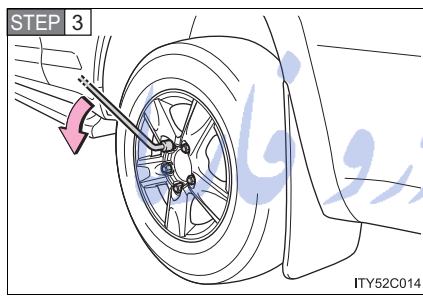

Slightly loosen the wheel nuts (one turn).

تلفن شبانه روزی: ۰۲۱-۸۸۸۶۲۰۸۵

FarmaSOS.com

**STEP 4** Assembling the jack handle.

Remove the jack handle, jack extension bar and jack handle bar from the tool box and assemble by following these steps.

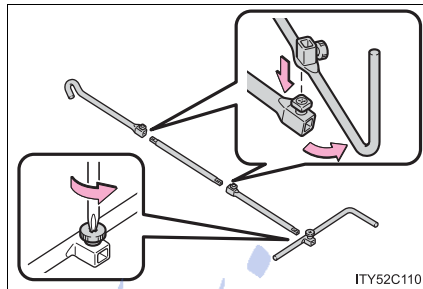

- 1** Loosen the bolts and the screw using either the jack handle or a screwdriver.

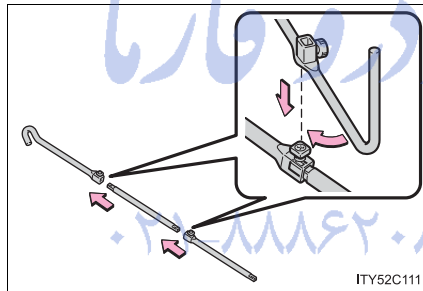

- 2** Assemble the jack handle extension bar and the jack handle bar and tighten the bolts.

Check that the bolts are firmly tightened.

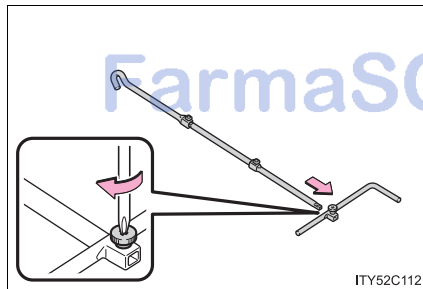

- 3** Assemble the jack handle extension bar and the jack handle and tighten the screw.

Check that the screw is firmly tightened.

5

When trouble arises

## 5-2. Steps to take in an emergency

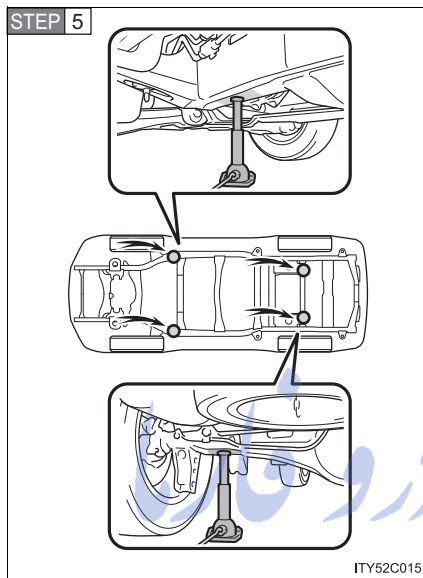

Position the jack at the jack points as shown.

Front - Under the chassis frame side rail

Rear - Under the rear axle housing

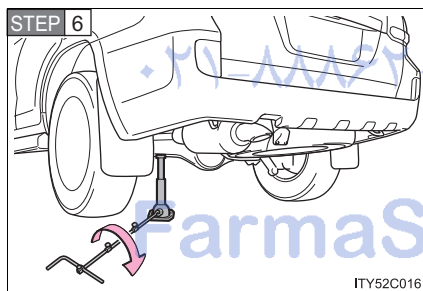

Raise the vehicle until the tire is slightly raised off the ground.

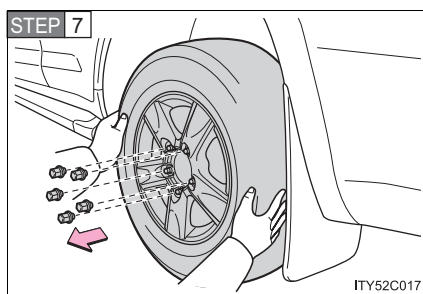

Remove all the wheel nuts and the tire.

When resting the tire on the ground, place the tire so that the wheel design faces up to avoid scratching the wheel surface.

### Installing the spare tire

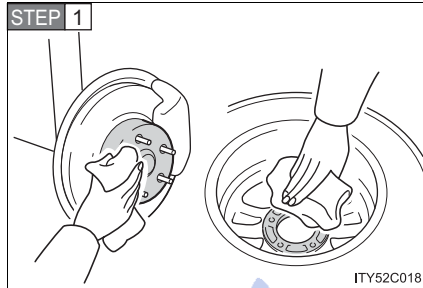

Remove any dirt or foreign matter from the wheel contact surface.

If foreign matter is on the wheel contact surface, the wheel nuts may loosen while the vehicle is in motion, and the tire may come off the vehicle.

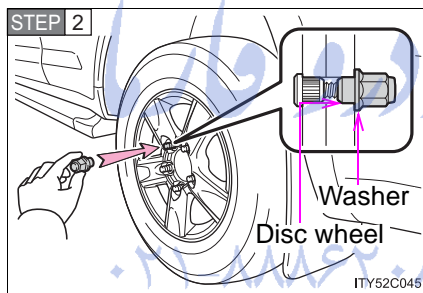

Install the spare tire and loosely tighten each nut by hand to approximately the same amount.

Turn the nut washers until they come into contact with the disc wheel.

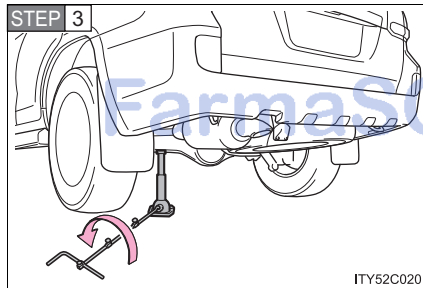

Lower the vehicle.

## 5-2. Steps to take in an emergency

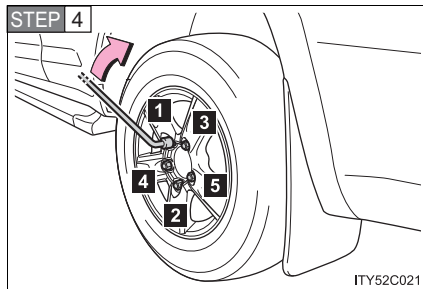

Firmly tighten each nut two or three times in the order shown in the illustration.

**Tightening torque:**  
97 ft•lbf (131 N•m, 13.4 kgf•m)

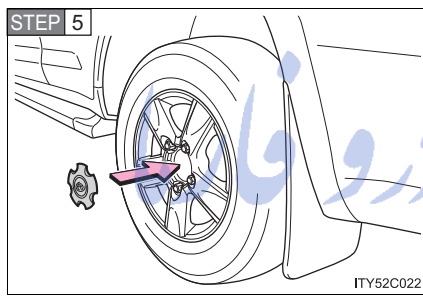

Reinstall the wheel ornament.

### Stowing the flat/spare tire, jack and tools

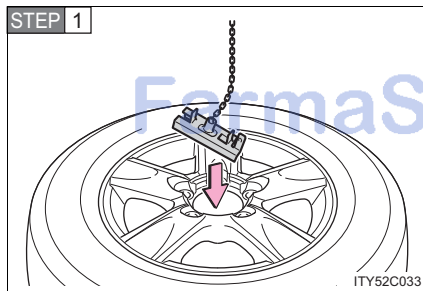

Lay down the tire with the outer side facing up, and install the holding bracket.

**STEP 2** Raise the tire.

Pull the tire towards the rear of the vehicle when raising. After raising, visually check that tire is not interfering with components.

**STEP 3** Stow the tools and jack securely, and replace all covers.

### ■ After completing the tire change

The tire pressure warning system must be reset. (→P. 446)

#### ⚠ CAUTION

#### ■ Using the tire jack

Improper use of the tire jack may lead to death or serious injuries due to the vehicle suddenly falling off the jack.

- Do not use the tire jack for any purpose other than replacing tires or installing and removing tire chains.
- Only use the tire jack that comes with this vehicle for replacing a flat tire.  
Do not use it on other vehicles, and do not use other tire jacks for replacing tires on this vehicle.
- Always check that the tire jack is securely set to the jack point.
- Do not raise the vehicle while someone is in it.
- When raising the vehicle, do not put an object on or under the jack.
- Do not raise the vehicle to a height greater than that required to replace the tire.
- Use a jack stand if it is necessary to get under the vehicle.
- Do not put any part of your body under the vehicle supported by a jack.
- Do not start or run the engine while your vehicle is supported by the jack.

Take particular care when lowering the vehicle to ensure that no one working on or near the vehicle may be injured.

#### ■ Using the jack handle

Tighten all the jack handle bolts securely using a Phillips-head screwdriver, to prevent the extension parts from coming apart unexpectedly.

 CAUTION

■ **Replacing a flat tire**

Observe the following precautions to reduce the risk of death or serious injury.

- Lower the spare tire completely to the ground before removing it from under the vehicle.
- Do not try to remove the wheel ornament by hand. Take due care in handling the ornament to avoid unexpected personal injury.
- Never use oil or grease on the wheel bolts or wheel nuts.  
Oil and grease may cause the wheel nuts to be excessively tightened, leading to bolt or disc wheel damage. In addition, the oil or grease can cause the wheel nuts to loosen and the wheel may fall off, causing a serious accident. Remove any oil or grease from the wheel bolts or wheel nuts.
- Have the wheel nuts tightened with a torque wrench to 97 ft•lbf (131 N•m, 13.4 kgf•m) as soon as possible after changing wheels.  
Failure to follow these precautions could cause the nuts to loosen and the wheels may fall off, which could lead to an accident causing death or serious injury.
- Do not attach a heavily damaged wheel ornament, as it may fly off the wheel while the vehicle is moving.

FarmaSOS.com



 NOTICE

■ **Do not drive the vehicle with a flat tire**

Do not continue driving with a flat tire.  
Driving even a short distance with a flat tire can damage the tire and the wheel beyond repair.

■ **When stowing the flat tire**

Ensure that there is no object caught between the tire and the vehicle underbody.

■ **When replacing the tires**

When removing or fitting the wheels, tires or the tire pressure warning valve and transmitter, contact your Toyota dealer as the tire pressure warning valve and transmitter may be damaged if not handled correctly.

■ **To avoid damaging the tire pressure warning valves and transmitters**

Do not use liquid sealants on flat tires.

تلفن شبانه روزی: ۰۲۱-۸۸۸۶۲۰۸۵

FarmaSOS.com

## 5-2. Steps to take in an emergency If the engine will not start

**If the engine still does not start after following the correct starting procedure (→P. 154) or releasing the steering lock (→P. 156), confirm the following points.**

■ **The engine will not start when the starter motor operates normally.**

One of the following may be the cause of the problem.

- There may not be sufficient fuel in the vehicle's tank.  
Refuel the vehicle.
- The engine may be flooded.  
Try to restart the engine once more following correct starting procedures. (→P. 154)
- There may be a malfunction in the engine immobilizer system.  
(→P. 96)

■ **The starter motor turn over slowly, the interior lights and headlights are dim, or the horn does not sound or sounds at a low volume.**

One of the following may be the cause of the problem.

- The battery may be discharged. (→P. 538)
- The battery terminal connections may be loose or corroded.

■ **The starter motor does not turn over.**

The engine starting system may be malfunctioning due to an electrical problem such as an open circuit or a blown fuse. However, an interim measure is available to start the engine.  
(→P. 531)

■ **The starter motor does not turn over, the interior lights and headlights do not turn on, or the horn does not sound.**

One of the following may be the cause of the problem.

- One or both of the battery terminals may be disconnected.
- The battery may be discharged. (→P. 538)
- There may be a malfunction in the steering lock system.

Contact your Toyota dealer if the problem cannot be repaired, or if repair procedures are unknown.

**Emergency start function**

When the engine does not start, the following steps can be used as an interim measure to start the engine if the “ENGINE START STOP” switch is functioning normally.

**STEP 1** Set the parking brake.

**STEP 2** Put the shift lever in “P”.

**STEP 3** Set the “ENGINE START STOP” switch to ACCESSORY mode.

**STEP 4** Press and hold the “ENGINE START STOP” switch about 15 seconds while depressing the brake pedal firmly.

Even if the engine can be started using the above steps, the system may be malfunctioning. Have the vehicle checked by your Toyota dealer.

## 5-2. Steps to take in an emergency

### If the shift lever cannot be shifted from P

If the shift lever cannot be shifted with your foot on the brake, there may be a problem with the shift lock system (a system to prevent accidental operation of the shift lever). Have the vehicle inspected by your Toyota dealer immediately.

The following steps may be used as an emergency measure to ensure that the shift lever can be shifted.

**STEP 1** Set the parking brake.

**STEP 2** Set the "ENGINE START STOP" switch to the ACCESSORY mode.

**STEP 3** Depress the brake pedal.

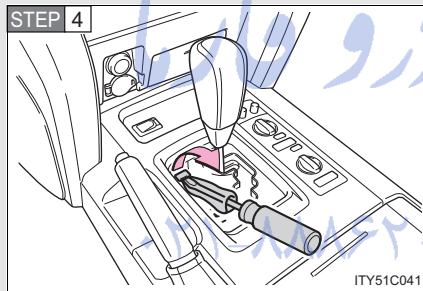

Pry the cover up with a flat-head screwdriver or equivalent.

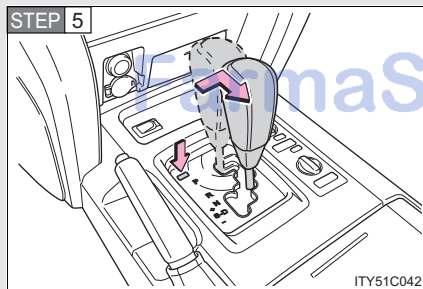

Press the shift lock override button.

The shift lever can be shifted while the button is pressed.

5-2. Steps to take in an emergency  
If you lose your keys

**New genuine Toyota keys can be made by your Toyota dealer using one of the other keys and the key number stamped on your key number plate.**

امداد خودرو فارما

تلفن شبانه روزی: ۰۲۱-۸۸۸۶۲۰۸۵

FarmaSOS.com

5

When trouble arises

## 5-2. Steps to take in an emergency If you cannot operate back door opener

If the back door opener does not operate, there may be a problem with the back door opener system. Have the vehicle inspected by your Toyota dealer immediately.

The following steps may be used as an emergency measure to ensure that the back door can be opened from the inside.

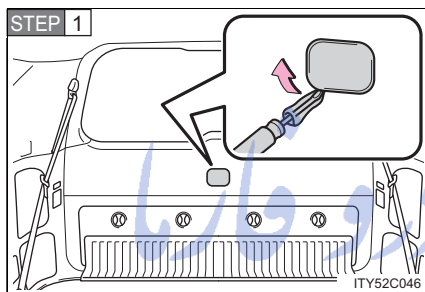

Remove the cover on the back door trim.

Use a cloth to prevent scratches.

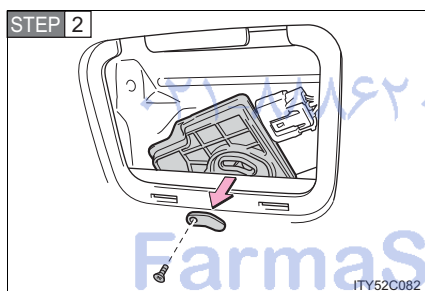

Remove the screw and cover.

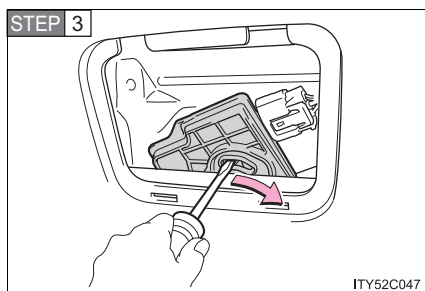

Push the lever with the back door motor, open the back door.

## 5-2. Steps to take in an emergency

### If the electronic key does not operate properly

If communication between the electronic key and vehicle is interrupted (→P. 26) or the electronic key cannot be used because the battery is depleted, the smart key system and wireless remote control cannot be used. In such cases, the doors can be opened or the engine can be started by following the procedure below.

#### Locking and unlocking the doors and key linked functions

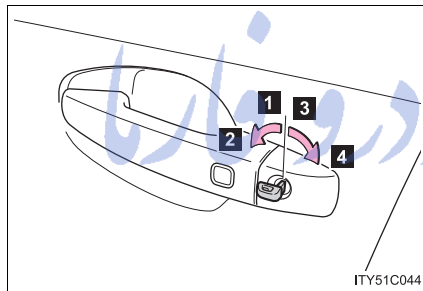

Using the mechanical key (→P. 24) in order to perform the following operations.

- 1** Locks all doors
- 2** Closes the windows/moon roof (turn and hold)\*
- 3** Unlocks all doors
- 4** Opens the windows/moon roof (turn and hold)\*

Turning the key rearward unlocks the driver's door. Turning the key once again unlocks the other doors.

\*: This setting must be customized at your Toyota dealer.

5

When trouble arises

### Changing “ENGINE START STOP” switch modes and starting the engine

**STEP 1** Shift the shift lever to “P” and apply the brakes.

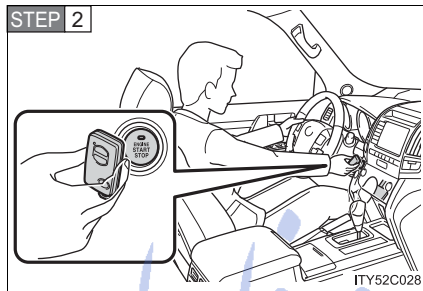

Touch the Toyota emblem side of the electronic key to the “ENGINE START STOP” switch.

An alarm will sound to indicate that the start function cannot detect the electronic key that is touched to the “ENGINE START STOP” switch if any of the doors is opened and closed while the key is touched to the switch.

**STEP 3** To change “ENGINE START STOP” switch modes: Within 10 seconds of the buzzer sounding, release the brake pedal and press the “ENGINE START STOP” switch. Modes can be changed each time the switch is pressed. (→P. 154)  
To start the engine: Press the “ENGINE START STOP” switch within 10 seconds after the buzzer sounds, keeping the brake pedal depressed.

In the event that the “ENGINE START STOP” switch cannot be operated, contact your Toyota dealer.



■ **Stopping the engine**

Shift the shift lever to “P” and press the “ENGINE START STOP” switch as you normally do when stopping the engine.

■ **Replacing the key battery**

As this above procedure is a temporary measure, it is recommended that the electronic key battery be replaced immediately when the battery depletes. (→P. 463)

■ **Alarm**

Using the mechanical key to lock the doors will not set the alarm system. If a door is unlocked using the mechanical key when the alarm system is set, the alarm may be triggered. (→P. 98)

امداد خودرو فارما

تلفن شبانه روزی: ۰۲۱-۸۸۸۶۲۰۸۵

FarmaSOS.com

## 5-2. Steps to take in an emergency If the battery is discharged

The following procedures may be used to start the engine if the battery is discharged.

You can call your Toyota dealer or qualified repair shop.

If you have a set of jumper (or booster) cables and a second vehicle with a 12 volt battery, you can jump start your Toyota following the steps below.

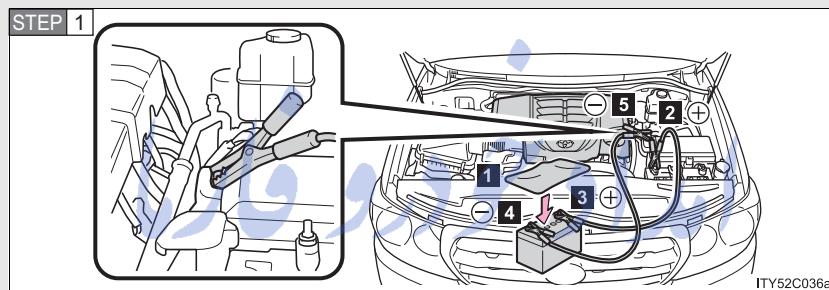

Connecting the jumper cables.

- 1** If required, remove all vent plugs from the booster battery. Lay a cloth over the open vents on the booster battery. (This helps reduce the explosion hazard, personal injuries and burns.)
- 2** Positive (+) battery terminal on your vehicle.
- 3** Positive (+) battery terminal on the second vehicle.
- 4** Negative (-) battery terminal on the second vehicle.
- 5** Connect the jumper cable to ground on your vehicles as shown in the illustration.

**STEP 2** Start the engine of the second vehicle. Increase the engine speed slightly and maintain at that level for approximately 5 minutes to recharge the battery of your vehicle.

**STEP 3** Open and close any of the doors with the “ENGINE START STOP” switch off.

**STEP 4** Maintain the engine speed of the second vehicle and start your vehicle's engine.

**STEP 5** Once the vehicle's engine has started, remove the jumper cables in the exact reverse order in which they were connected.

Once the engine starts, have the vehicle checked at your Toyota dealer as soon as possible.

---

■ **Starting the engine when the battery is discharged**

The engine cannot be started by push-starting.

■ **Avoiding a discharged battery**

- Turn off the headlights and the audio system while the engine is turned off.
- Turn off any unnecessary electrical components when the vehicle is running at a low speed for an extended period, such as in heavy traffic, etc.

FarmaSOS.com

## 5-2. Steps to take in an emergency

### CAUTION

#### ■ **Avoiding battery fires or explosions**

Observe the following precautions to prevent accidentally igniting the flammable gas that may be emitted from the battery.

- Make sure the jumper cable is connected to the correct terminal and that it is not unintentionally in contact with any part other than the intended terminal.
- Do not allow the jumper cables to come into contact with the “+” and “-” terminals.
- Do not allow open flame or use matches, cigarette lighters or smoke near the battery.

#### ■ **Battery precautions**

The battery contains poisonous and corrosive acidic electrolyte, while related parts contain lead and lead compounds. Observe the following precautions when handling the battery:

- When working with the battery, always wear safety glasses and take care not to allow any battery fluids (acid) to come into contact with skin, clothing or the vehicle body.
- Do not lean over the battery.
- If the battery fluid comes into contact with the skin or eyes, immediately wash the affected area with water and seek medical attention. Place a wet sponge or cloth over the affected area until medical attention can be received.
- Always wash your hands after handling the battery support, terminals, and other battery-related parts.
- Do not allow children near the battery.

### NOTICE

#### ■ **When handling jumper cables**

Be careful that the jumper cables do not become tangled in the cooling fan or any of the belts when connecting or disconnecting them.

## 5-2. Steps to take in an emergency If your vehicle overheats

### If your engine overheats

**STEP 1** Stop the vehicle in a safe place and turn off the air conditioning system.

**STEP 2** Check to see if steam is coming out from under the hood.

If you see steam:

Stop the engine. Carefully lift the hood after the steam subsides and then restart the engine.

If you do not see steam:

Leave the engine running and carefully lift the hood.

**STEP 3** Remove the engine compartment cover. (→P. 431)

**STEP 4** Check to see if the cooling fan is operating.

If the fan is operating:

Wait until the engine coolant temperature gauge begins to fall and then stop the engine.

If the fan is not operating:

Stop the engine immediately and call your local Toyota dealer.

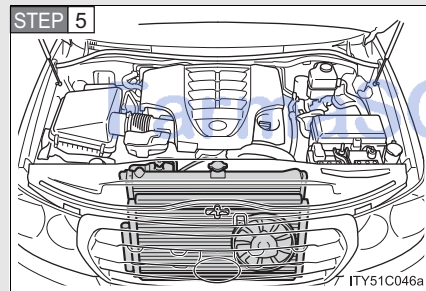

After the engine has cooled down sufficiently, check the coolant level and inspect the radiator core (radiator) for any leaks.

5

When trouble arises

## 5-2. Steps to take in an emergency

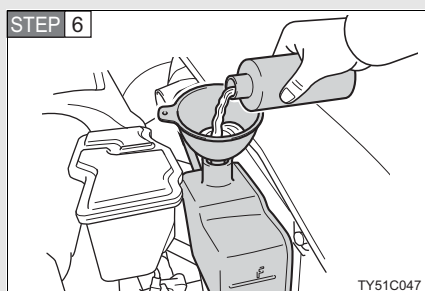

Add coolant if required.

Water can be used in an emergency measure if coolant is unavailable. (→P. 552)

Have the vehicle checked at nearest Toyota dealer as soon as possible.

### ■ Overheating

In the following situations, your vehicle may be overheating.

- The engine coolant temperature gauge enters the red zone or a loss of power is experienced.
- Steam is coming from under the hood.

### ⚠ CAUTION

#### ■ To prevent an accident or injury when inspecting under the hood of your vehicle

- If steam is seen coming from under the hood, do not open the hood until the steam has subsided. The engine compartment may be very hot, causing serious injury such as burns.
- Keep hands and clothing away from the fan and engine drive belt while the engine is running.
- Do not loosen the radiator cap while the engine and radiator are hot. Serious injury, such as burns, may result from hot coolant and steam released under pressure.

 NOTICE

■ **When adding engine coolant**

Wait until the engine has cooled down before adding engine coolant.  
When adding coolant, do so slowly. Adding cool coolant to a hot engine too quickly can cause damage to the engine.

امداد خودرو فارما

تلفن شبانه روزی: ۰۲۱-۸۸۸۶۲۰۸۵

FarmaSOS.com

## 5-2. Steps to take in an emergency If the vehicle becomes stuck

**Carry out the following procedures if the tires spin or the vehicle becomes stuck in mud, dirt, or snow.**

- STEP 1** Stop the engine. Set the parking brake and shift the shift lever in "P".
- STEP 2** Remove the mud, snow or sand from around the stuck tire.
- STEP 3** Place wood, stones or some other material to help provide traction under the tires.
- STEP 4** Restart the engine.
- STEP 5** Turn off VSC. (→ P. 210)
- STEP 6** Shift the shift lever to "D" or "R" position and carefully apply the accelerator to free the vehicle.

### CAUTION

#### ■ When attempting to free a stuck vehicle

If you choose to rock the vehicle back and forth to free it, make sure the surrounding area is clear, to avoid striking other vehicles, objects or persons. The vehicle may also lunge forward or lunge back suddenly as it becomes free. Use extreme caution.

#### ■ When shifting the shift lever

Be careful not to shift the shift lever with the accelerator pedal depressed. This may lead to unexpected rapid acceleration of the vehicle that may cause an accident and result in death or serious injury.

### NOTICE

#### ■ To avoid damaging the transmission and other components

- Avoid spinning the wheels and do not rev the engine.
- If the vehicle remains stuck after trying these procedures, the vehicle may require towing to be freed.



## 5-2. Steps to take in an emergency

### If your vehicle has to be stopped in an emergency

**Only in an emergency, such as if it becomes impossible to stop the vehicle in the normal way, stop the vehicle using the following procedure:**

**STEP 1** Steadily step on the brake pedal with both feet and firmly depress it.

Do not pump the brake pedal repeatedly as this will increase the effort required to slow the vehicle.

**STEP 2** Shift the shift lever to "N".

▶ If the shift lever is shifted to "N"

**STEP 3** After slowing down, stop the vehicle in a safe place by the road.

**STEP 4** Stop the engine.

▶ If the shift lever cannot be shifted to "N"

**STEP 3** Keep depressing the brake pedal with both feet to reduce vehicle speed as much as possible.

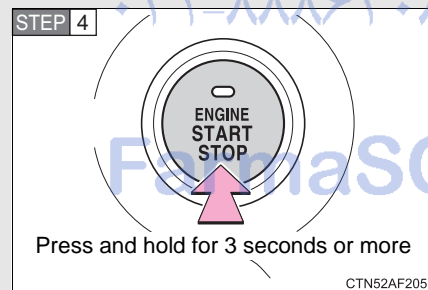

Stop the engine by pressing and holding the "ENGINE START STOP" switch for 3 consecutive seconds or more.

**STEP 5** Stop the vehicle in a safe place by the road.

## 5-2. Steps to take in an emergency

### CAUTION

#### ■ If the engine has to be turned off while driving

Power assist for the brakes and steering wheel will be lost, making the brake pedal harder to depress and the steering wheel heavier to turn. Decelerate as much as possible before turning off the engine.

امداد خودرو فارما

تلفن شبانه روزی: ۰۲۱-۸۸۸۶۲۰۸۵

FarmaSOS.com

## Vehicle specifications

# 6

### 6-1. Specifications

Maintenance data (fuel, oil level, etc.) .....	548
Fuel information .....	558
Tire information .....	561

### 6-2. Customization

Customizable features .....	573
-----------------------------	-----

### 6-3. Initialization

Items to initialize .....	582
---------------------------	-----

تلفن شبکه روزی: ۰۲۱-۸۸۸۶۲۰۸۵

FarmaSOS.com

## 6-1. Specifications

### Maintenance data (fuel, oil level, etc.)

#### Dimensions and weights

Overall length	194.9 in. (4950 mm)	
Overall width	77.6 in. (1970 mm)	
Overall height*	74.0 in. (1880 mm)	
Wheelbase	112.2 in. (2850 mm)	
Tread	Front	64.6 in. (1640 mm)
	Rear	64.4 in. (1635 mm)
Vehicle capacity weight (Occupants + luggage)	1235 lb. (560 kg)	
Towing capacity (trailer weight + cargo weight)	8500 lb. (3856 kg)	

\*:Unladen vehicle

تلفن شبانه روزی: ۰۲۱-۸۸۸۶۲۰۸۵

FarmaSOS.com

### Vehicle identification

#### ■ Vehicle identification number

The vehicle identification number (VIN) is the legal identifier for your vehicle. This is the primary identification number for your Toyota. It is used in registering the ownership of your vehicle.

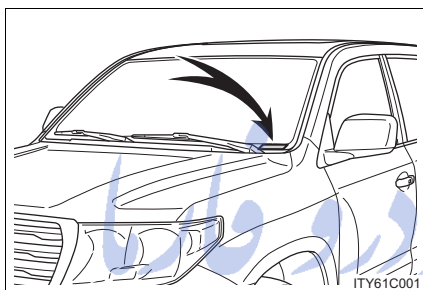

This number is stamped on the top left of the instrument panel.

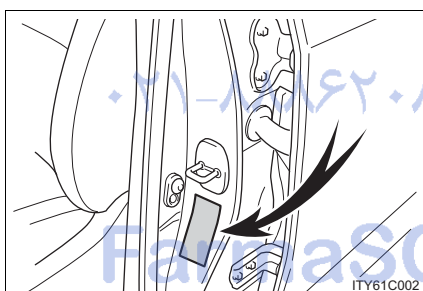

This number is also on the Certification Label.

#### ■ Engine number

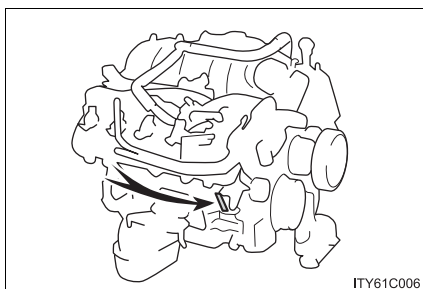

The engine number is stamped on the engine block as shown.

## 6-1. Specifications

### Engine

Model	3UR-FE
Type	8-cylinder V type, 4-cycle, gasoline
Bore and stroke	3.70 × 4.02 in. (94.0 × 102.0 mm)
Displacement	345.6 cu.in. (5663 cm <sup>3</sup> )
Valve clearance (engine cold)	Automatic adjustment
Drive belt tension	Automatic adjustment

### Fuel

Fuel type	Unleaded gasoline only
Octane rating	87 (Research octane number 91) or higher
Fuel tank capacity (Reference)	24.6 gal. (93 L, 20.5 Imp.gal)

FarmaSOS.com

### Lubrication system

Oil capacity (Drain and refill — reference)	
With filter	7.4 qt. (7.0 L, 6.2 Imp.qt.) <sup>*1</sup> 7.9 qt. (7.5 L, 6.6 Imp.qt.) <sup>*2</sup>
Without filter	7.0 qt. (6.6 L, 5.8 Imp.qt.) <sup>*1</sup> 7.5 qt. (7.1 L, 6.2 Imp.qt.) <sup>*2</sup>

\*1: Vehicles with a blue-markered dipstick handle

\*2: Vehicles with a green-markered dipstick handle

(Location of the marker: →P. 432)

#### ■ Engine oil selection

“Toyota Genuine Motor Oil” is used in your Toyota vehicle. Use Toyota approved “Toyota Genuine Motor Oil” or equivalent to satisfy the following grade and viscosity.

Oil grade: ILSAC multigrade engine oil

Recommended viscosity: SAE 5W-20 or 0W-20

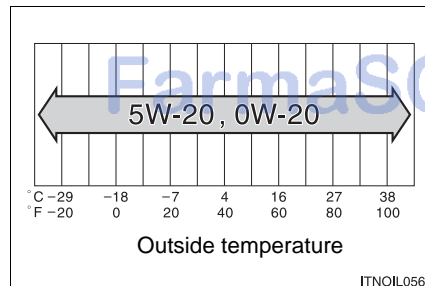

SAE 5W-20 or 0W-20 engine oil may be used. However, SAE 0W-20 is the best choice for good fuel economy and good starting in cold weather.

The 0W portion of the oil viscosity rating indicates the characteristic of the oil which allows cold startability. Oils with a lower value before the W allow for easier starting of the engine in cold weather.

The 20 in 0W-20 indicates the oil viscosity when the oil is at its operating temperature. An oil with a higher viscosity may be better suited if the vehicle is operated at high speeds, or under extreme load conditions.

## 6-1. Specifications

How to read oil container label:

The ILSAC (International Lubricant Standardization and Approval Committee) Certification Mark is added to some oil containers to help you select the oil you should use.

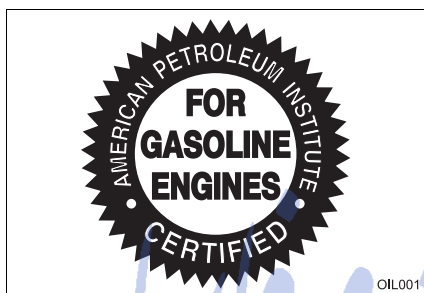

### Cooling system

Capacity	17.6 qt. (16.7 L, 14.7 Imp.qt.)
Coolant type	Use either of the following: <ul style="list-style-type: none"><li>• "Toyota Super Long Life Coolant"</li><li>• Similar high-quality ethylene glycol-based non-silicate, non-amine, non-nitrite, and non-borate coolant with long-life hybrid organic acid technology</li></ul> Do not use plain water alone.



**Ignition system**

Spark plug		
Make	DENSO	SK20HR11
Gap		0.043 in. (1.1 mm)

**⚠ NOTICE****■ Iridium-tipped spark plugs**

Use only iridium-tipped spark plugs. Do not adjust gap when tuning engine.

**Electrical system**

Battery	
Open voltage at 68°F (20°C):	12.6 — 12.8 V Fully charged 12.2 — 12.4 V Half charged 11.8 — 12.0 V Discharged (Voltage is checked 20 minutes after the key is removed with all lights turned off.)
Charging rates	5 A max.

## 6-1. Specifications

### Differential

Oil capacity	
Front	2.01 qt. (1.90 L, 1.67 Imp.qt.)
Rear	4.44 qt. (4.20 L, 3.70 Imp.qt.)
Oil type and viscosity	Toyota Genuine Differential gear oil LT 75W-85 GL-5 or equivalent

“Toyota Genuine Differential Oil” is filled in your Toyota vehicle at factory fill.

Use Toyota approved “Toyota Genuine Differential Gear Oil” or an equivalent of matching quality to satisfy the above specification. Please contact your Toyota dealer for further details.

### Automatic transmission

Fluid capacity	Without oil cooler	12.3 qt. (11.6 L, 10.2 Imp.qt.)
	With oil cooler	12.6 qt. (11.9 L, 10.5 Imp.qt.)
Fluid type	Toyota Genuine ATF WS	

### NOTICE

#### ■ Automatic transmission fluid type

Using transmission fluid other than “Toyota Genuine ATF WS” may cause deterioration in shift quality, locking up of your transmission accompanied by vibration, and ultimately damage the transmission of your vehicle.

**Transfer**

Oil capacity	1.53 qt. (1.45 L, 1.28 Imp.qt.)
Oil type	Gear oil API GL-5
Recommended oil viscosity	SAE 75W-90

**Brakes**

Pedal clearance* <sup>1</sup>	3.62 in. (92 mm) Min.
Pedal free play	0.04 — 0.24 in. (1.0 — 6.0 mm)
Brake pad wear limit	0.04 in. (1.0 mm)
Parking brake lining wear limit	0.04 in. (1.0 mm)
Parking brake adjustment* <sup>2</sup>	5 — 7 clicks
Fluid type	SAE J1703 or FMVSS No. 116 DOT 3

\*1: Minimum pedal clearance when depressed with a force of 110 lbf (490 N, 50 kgf) while the engine is running.

\*2: Parking brake pedal travel when pulled with a force of 45 lbf (200 N, 20 kgf).

**Chassis lubrication**

Propeller shafts	Lithium base chassis grease, NLGI No.2 Molybdenum-disulfide lithium base chassis grease, NLGI No.2 or lithium base chassis grease, NLGI No.2
Spider	
Slide yoke	

## 6-1. Specifications

### Steering

Free play	Less than 1.18 in. (30 mm)
Power steering fluid type	Automatic transmission fluid DEXRON® II or III

### Tires and wheels

Tire size	P285/60R18 114V
Tire inflation pressure (Recommended cold tire inflation pressure)	<p>Normal driving</p> <p>Front tires: 33 psi (230 kPa, 2.3 kgf/cm<sup>2</sup> or bar)</p> <p>Rear tires: 33 psi (230 kPa, 2.3 kgf/cm<sup>2</sup> or bar)</p> <p>Spare tire: 33 psi (230 kPa, 2.3 kgf/cm<sup>2</sup> or bar)</p> <p>Trailer towing</p> <p>Front tires: 33 psi (230 kPa, 2.3 kgf/cm<sup>2</sup> or bar)</p> <p>Rear tires: 33 psi (230 kPa, 2.3 kgf/cm<sup>2</sup> or bar)</p> <p>Spare tire: 33 psi (230 kPa, 2.3 kgf/cm<sup>2</sup> or bar)</p>
Wheel size	18 × 8 J
Wheel nut torque	97 ft•lbf (131 N•m, 13.4 kgf•m)

**Light bulbs**

	Light Bulbs	Bulb No.	W	Type
Exterior	Headlights Low beam	—	55	A
	High beam	9005	60	B
	Front turn signal lights	3457	28	E
	Parking lights	—	5	E
	Front side marker lights	—	5	E
	Front fog lights	9006	55	C
	Rear turn signal lights	—	21	E
	Back-up lights	921	18	E
License plate lights	—	5	E	
Interior	Front interior light	—	8	E
	Rear interior lights With rear personal lights	—	8	E
	Without rear personal lights	—	8	F
	Front personal lights	—	8	E
	Rear personal lights	—	8	E
	Vanity lights	—	1.5	D
	Door courtesy lights	—	5	E
Glove box light	—	1.2	E	

- A: H11 halogen bulbs  
 B: HB3 halogen bulbs  
 C: HB4 halogen bulbs  
 D: Single end bulbs  
 E: Wedge base bulbs  
 F: Double end bulbs

## 6-1. Specifications

### Fuel information

**Your vehicle must use only unleaded gasoline.**

**Select octane rating 87 (Research Octane Number 91) or higher. Use of unleaded gasoline with an octane rating lower than 87 may result in engine knocking. Persistent knocking can lead to engine damage.**

At minimum, the gasoline you use should meet the specifications of ASTM D4814 in the U.S.A.

---

#### ■ Fuel tank opening for unleaded gasoline

To help prevent incorrect fueling, your Toyota has a fuel tank opening that only accommodates the special nozzle on unleaded fuel pumps.

#### ■ If your engine knocks

- Consult your Toyota dealer.
- You may occasionally notice light knocking for a short time while accelerating or driving uphill. This is normal and there is no need for concern.

#### ■ Gasoline quality

In very few cases, driveability problems may be caused by the brand of gasoline you are using. If driveability problems persist, try changing the brand of gasoline. If this does not correct the problem, consult your Toyota dealer.

FarmaSOS.com

**■ Gasoline quality standards**

- Automotive manufacturers in the US, Europe and Japan have developed a specification for fuel quality called World-Wide Fuel Charter (WWFC) that is expected to be applied worldwide.
- The WWFC consists of four categories that are based on required emission levels. In the US, category 4 has been adopted.
- The WWFC improves air quality by lowering emissions in vehicle fleets, and customer satisfaction through better performance.

**■ Toyota recommends the use of gasoline containing detergent additives**

- Toyota recommends the use of gasoline that contains detergent additives to avoid build-up of engine deposits.
- All gasoline sold in the US contains detergent additives to clean and/or keep clean intake systems.

**■ Toyota recommends the use of cleaner burning gasoline**

Cleaner burning gasoline, including reformulated gasoline that contains oxygenates such as ethanol or MTBE (Methyl Tertiary Butyl Ether) is available in many areas.

Toyota recommends the use of cleaner burning gasoline and appropriately blended reformulated gasoline. These types of gasoline provide excellent vehicle performance, reduce vehicle emissions and improve air quality.

**■ Toyota does not recommend blended gasoline**

- Toyota allows the use of oxygenate blended gasoline where the oxygenate content is up to 10% ethanol or 15% MTBE.
- If you use gasohol in your Toyota, be sure that it has an octane rating no lower than 87.
- Toyota DOES NOT recommend the use of gasoline containing methanol.

## 6-1. Specifications

### ■ Toyota does not recommend gasoline containing MMT

Some gasoline contains octane enhancing additive called MMT (Methylcyclopentadienyl Manganese Tricarbonyl).

Toyota DOES NOT recommend the use of gasoline that contains MMT. If fuel containing MMT is used, your emission control system may be adversely affected.

The malfunction indicator lamp on the instrument cluster may come on. If this happens, contact your Toyota dealer for service.

 <b>NOTICE</b>
<p>■ <b>Notice on fuel quality</b></p> <ul style="list-style-type: none"><li>● Do not use improper fuels. If improper fuels are used the engine will be damaged.</li><li>● Do not use leaded gasoline. Leaded gasoline can cause damage to your vehicle's three-way catalytic converters causing the emission control system to malfunction.</li><li>● Do not use gasohol other than that stated here. Other gasohol may cause fuel system damage or vehicle performance problems.</li><li>● Using unleaded gasoline with an octane number or rating lower than that stated here will cause persistent heavy knocking. At worst, this will lead to engine damage.</li></ul>
<p>■ <b>Fuel-related poor driveability</b></p> <p>If after using a different type of fuel, poor driveability is encountered (poor hot starting, vaporization, engine knocking, etc.), discontinue the use of that type of fuel.</p>
<p>■ <b>When refueling with gasohole</b></p> <p>Take care not to spill gasohol. It can damage your vehicle's paint.</p>



## 6-1. Specifications Tire information

### Typical tire symbols

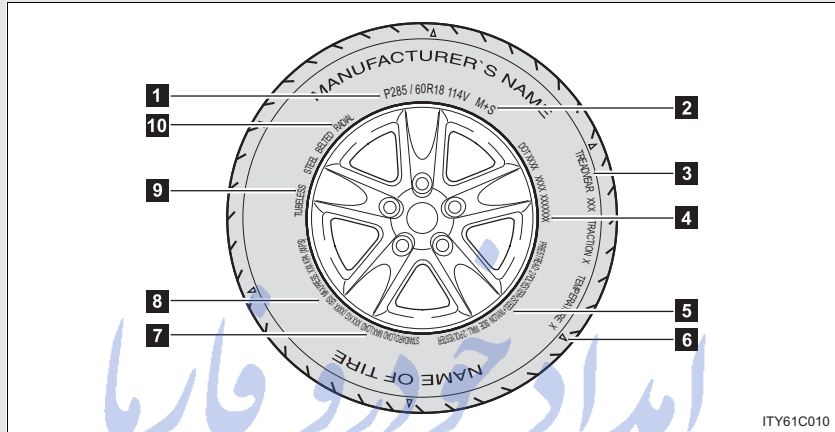

- 1** Tire size (→P. 563)
- 2** Summer tire or all season tire (→P. 449)  
An all season tire has “M+S” on the sidewall. A tire not marked “M+S” is a summer tire.
- 3** Uniform tire quality grading  
For details, see “Uniform Tire Quality Grading” that follows.
- 4** DOT and Tire Identification Number (TIN) (→P. 562)
- 5** Tire ply composition and materials  
Plies are layers of rubber-coated parallel cords. Cords are the strands which form the plies in a tire.
- 6** Location of treadwear indicators (→P. 564)
- 7** Load limit at maximum cold tire inflation pressure (→P. 566)

## 6-1. Specifications

**8** Maximum cold tire inflation pressure (→P. 566)

This means the pressure to which a tire may be inflated.

**9** TUBELESS or TUBE TYPE

A tubeless tire does not have a tube and air is directly filled in the tire. A tube type tire has a tube inside the tire and the tube maintains the air pressure.

**10** Radial tires or bias-ply tires

A radial tire has RADIAL on the sidewall. A tire not marked RADIAL is a bias-ply tire.

### Typical DOT and tire identification number (TIN)

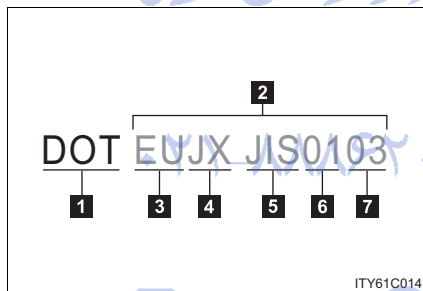

**1** DOT symbol\*

**2** Tire Identification Number (TIN)

**3** Tire manufacturer's identification mark

**4** Tire size code

**5** Manufacturer's optional tire type code (3 or 4 letters)

**6** Manufacturing week

**7** Manufacturing year

\*:The DOT symbol certifies that the tire conforms to applicable Federal Motor Vehicle Safety Standards.

## Tire size

### ■ Typical tire size information

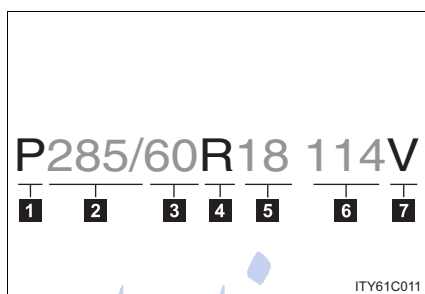

The illustration indicates typical tire size.

- 1** Tire use  
(P = Passenger car,  
T = Temporary use)
- 2** Section width (millimeters)
- 3** Aspect ratio  
(tire height to section width)
- 4** Tire construction code  
(R = Radial, D = Diagonal)
- 5** Wheel diameter (inches)
- 6** Load index (2 or 3 digits)
- 7** Speed symbol  
(alphabet with one letter)

### ■ Tire dimensions

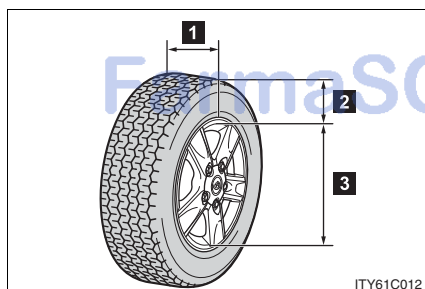

- 1** Section width
- 2** Tire height
- 3** Wheel diameter

### Tire section names

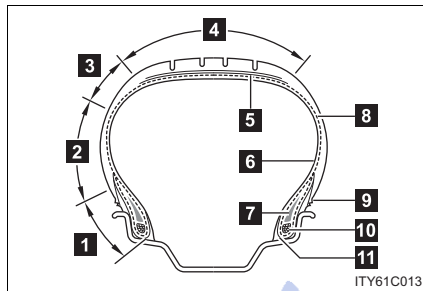

- 1 Bead
- 2 Sidewall
- 3 Shoulder
- 4 Tread
- 5 Belt
- 6 Inner liner
- 7 Reinforcing rubber
- 8 Carcass
- 9 Rim lines
- 10 Bead wires
- 11 Chafer

### Uniform Tire Quality Grading

This information has been prepared in accordance with regulations issued by the National Highway Traffic Safety Administration of the U.S.A. Department of Transportation.

It provides the purchasers and/or prospective purchasers of Toyota vehicles with information on uniform tire quality grading.

Your Toyota dealer will help answer any questions you may have as you read this information.

#### ■ DOT quality grades

All passenger vehicle tires must conform to Federal Safety Requirements in addition to these grades. Quality grades can be found where applicable on the tire sidewall between tread shoulder and maximum section width.

For example: Treadwear 200 Traction AA Temperature A

### ■ Treadwear

The treadwear grade is a comparative rating based on the wear rate of the tire when tested under controlled conditions on a specified government test course.

For example, a tire graded 150 would wear one and a half (1 - 1/2) times as well on the government course as a tire graded 100.

The relative performance of tires depends upon the actual conditions of their use, however, and may depart significantly from the norm due to variations in driving habits, service practices and differences in road characteristics and climate.

### ■ Traction AA, A, B, C

The traction grades, from highest to lowest, are AA, A, B and C, and they represent the tire's ability to stop on wet pavement as measured under controlled conditions on specified government test surfaces of asphalt and concrete.

A tire marked C may have poor traction performance.

Warning: The traction grade assigned to this tire is based on braking (straight ahead) traction tests and does not include cornering (turning) traction.

### ■ Temperature A, B, C

The temperature grades are A (the highest), B, and C, representing the tire's resistance to the generation of heat and its ability to dissipate heat when tested under controlled conditions on a specified indoor laboratory test wheel.

Sustained high temperature can cause the material of the tire to degenerate and reduce tire life, and excessive temperature can lead to sudden tire failure.

The grade C corresponds to a level of performance which all passenger car tires must meet under the Federal Motor Vehicle Safety Standard No. 109.

Grades B and A represent higher levels of performance on the laboratory test wheel than the minimum required by law.

## 6-1. Specifications

Warning: The temperature grades for this tire are established for a tire that is properly inflated and not overloaded.

Excessive speed, underinflation, or excessive loading, either separately or in combination, can cause heat buildup and possible tire failure.

### Glossary of tire terminology

Tire related term	Meaning
Cold tire inflation pressure	Tire pressure when the vehicle has been parked for three hours or more, or has not been driven more than 1 mile or 1.5 km under that condition
Maximum inflation pressure	The maximum cold inflated pressure to which a tire may be inflated, shown on the sidewall of the tire
Recommended inflation pressure	Cold tire inflation pressure recommended by a manufacturer.
Accessory weight	The combined weight (in excess of those standard items which may be replaced) of transmission, power steering, power brakes, power windows, power seats, radio and heater, to the extent that these items are available as factory-installed equipment (whether installed or not)
Curb weight	The weight of a motor vehicle with standard equipment, including the maximum capacity of fuel, oil and coolant, and if so equipped, air conditioning and additional weight optional engine
Maximum loaded vehicle weight	The sum of: (a) Curb weight (b) Accessory weight (c) Vehicle capacity weight (d) Production options weight

Tire related term	Meaning
Normal occupant weight	150 lb. (68 kg) times the number of occupants specified in the second column of Table 1* that follows
Occupant distribution	Distribution of occupants in a vehicle as specified in the third column of Table 1* below
Production options weight	The combined weight of installed regular production options weighing over 5 lb. (2.3 kg) in excess of the standard items which they replace, not previously considered in curb weight or accessory weight, including heavy duty brakes, ride levelers, roof rack, heavy duty battery, and special trim
Rim	A metal support for a tire or a tire and tube assembly upon which the tire beads are seated
Rim diameter (Wheel diameter)	Nominal diameter of the bead seat
Rim size designation	Rim diameter and width
Rim type designation	The industry manufacturer's designation for a rim by style or code
Rim width	Nominal distance between rim flanges
Vehicle capacity weight (Total load capacity)	The rated cargo and luggage load plus 150 lb. (68 kg) times the vehicle's designated seating capacity
Vehicle maximum load on the tire	The load on an individual tire that is determined by distributing to each axle its share of the maximum loaded vehicle weight, and dividing by two

6-1. Specifications

Tire related term	Meaning
Vehicle normal load on the tire	The load on an individual tire that is determined by distributing to each axle its share of curb weight, accessory weight, and normal occupant weight (distributed in accordance with Table 1* below), and dividing by two
Weather side	The surface area of the rim not covered by the inflated tire
Bead	The part of the tire that is made of steel wires, wrapped or reinforced by ply cords and that is shaped to fit the rim
Bead separation	A breakdown of the bond between components in the bead
Bias ply tire	A pneumatic tire in which the ply cords that extend to the beads are laid at alternate angles substantially less than 90 degrees to the centerline of the tread
Carcass	The tire structure, except tread and sidewall rubber which, when inflated, bears the load
Chunking	The breaking away of pieces of the tread or sidewall
Cord	The strands forming the plies in the tire
Cord separation	The parting of cords from adjacent rubber compounds
Cracking	Any parting within the tread, sidewall, or inner-liner of the tire extending to cord material
CT	A pneumatic tire with an inverted flange tire and rim system in which the rim is designed with rim flanges pointed radially inward and the tire is designed to fit on the underside of the rim in a manner that encloses the rim flanges inside the air cavity of the tire



Tire related term	Meaning
Extra load tire	A tire designed to operate at higher loads and at higher inflation pressures than the corresponding standard tire
Groove	The space between two adjacent tread ribs
Innerliner	The layer(s) forming the inside surface of a tubeless tire that contains the inflating medium within the tire
Innerliner separation	The parting of the innerliner from cord material in the carcass
Intended outboard sidewall	(a)The sidewall that contains a whitewall, bears white lettering, or bears manufacturer, brand, and/or model name molding that is higher or deeper than the same molding on the other sidewall of the tire, or (b)The outward facing sidewall of asymmetrical tire that has a particular side that must always face outward when mounted on a vehicle
Light truck (LT) tire	A tire designated by its manufacturer as primarily intended for use on lightweight trucks or multipurpose passenger vehicles
Load rating	The maximum load that a tire is rated to carry for a given inflation pressure
Maximum load rating	The load rating for a tire at the maximum permissible inflation pressure for that tire
Maximum permissible inflation pressure	The maximum cold inflation pressure to which a tire may be inflated
Measuring rim	The rim on which a tire is fitted for physical dimension requirements
Open splice	Any parting at any junction of tread, sidewall, or innerliner that extends to cord material
Outer diameter	The overall diameter of an inflated new tire

6-1. Specifications

Tire related term	Meaning
Overall width	The linear distance between the exteriors of the sidewalls of an inflated tire, including elevations due to labeling, decorations, or protective bands or ribs
Passenger car tire	A tire intended for use on passenger cars, multipurpose passenger vehicles, and trucks, that have a gross vehicle weight rating (GVWR) of 10,000 lb. or less
Ply	A layer of rubber-coated parallel cords
Ply separation	A parting of rubber compound between adjacent plies
Pneumatic tire	A mechanical device made of rubber, chemicals, fabric and steel or other materials, that, when mounted on an automotive wheel, provides the traction and contains the gas or fluid that sustains the load
Radial ply tire	A pneumatic tire in which the ply cords that extend to the beads are laid at substantially 90 degrees to the centerline of the tread
Reinforced tire	A tire designed to operate at higher loads and at higher inflation pressures than the corresponding standard tire.
Section width	The linear distance between the exteriors of the sidewalls of an inflated tire, excluding elevations due to labeling, decoration, or protective bands
Sidewall	That portion of a tire between the tread and bead
Sidewall separation	The parting of the rubber compound from the cord material in the sidewall

Tire related term	Meaning
Snow tire	A tire that attains a traction index equal to or greater than 110, compared to the ASTM E-1136 Standard Reference Test Tire, when using the snow traction test as described in ASTM F-1805-00, Standard Test Method for Single Wheel Driving Traction in a Straight Line on Snow-and Ice-Covered Surfaces, and which is marked with an Alpine Symbol (  ) on at least one sidewall
Test rim	The rim on which a tire is fitted for testing, and may be any rim listed as appropriate for use with that tire
Tread	That portion of a tire that comes into contact with the road
Tread rib	A tread section running circumferentially around a tire
Tread separation	Pulling away of the tread from the tire carcass
Treadwear indicators (TWI)	The projections within the principal grooves designed to give a visual indication of the degrees of wear of the tread
Wheel-holding fixture	The fixture used to hold the wheel and tire assembly securely during testing

## 6-1. Specifications

\*: Table 1 — Occupant loading and distribution for vehicle normal load for various designated seating capacities

Designated seating capacity, Number of occupants	Vehicle normal load, Number of occupants	Occupant distribution in a normally loaded vehicle
2 through 4	2	2 in front
5 through 10	3	2 in front, 1 in second seat
11 through 15	5	2 in front, 1 in second seat, 1 in third seat, 1 in fourth seat
16 through 20	7	2 in front, 2 in second seat, 2 in third seat, 1 in fourth seat

تلفن شبانه روزی: ۰۲۱-۸۸۸۶۲۰۸۵

FarmaSOS.com

## 6-2. Customization Customizable features

Your vehicle includes a variety of electronic features that can be personalized to your preferences.

Programming of these preferences can be performed by your Toyota dealer.

For vehicles with the navigation system, it is also possible to customize certain vehicle features yourself using the touch screen.

Some function settings are changed simultaneously with other functions being customized. Contact your Toyota dealer for further details.

### Customizing vehicle features using the touch screen (vehicles with navigation system)

**STEP 1** Press "SETUP".

**STEP 2** Touch "Vehicle" on the "Setup" screen.

**STEP 3** Touch "Vehicle Customization".

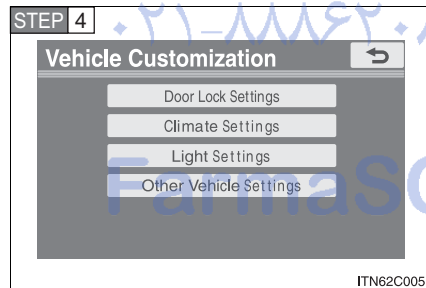

Touch the setting to be changed. Change each setting and touch "Save".

If "Save" is not touched before switching to another screen, any changes will be lost.

**STEP 5** A message indicating that the settings are being saved will appear.

Do not perform any other operations while this message is displayed.

### Customizable features

Vehicle customization settings can be changed at your Toyota dealer. For vehicles with the navigation system, some settings can be changed using the touch screen.

- 1** Settings that can be changed using the touch screen
- 2** Settings that can be changed using the vehicle switches
- 3** Settings that can be changed by your Toyota dealer

Definition of symbols: O= Available, — = Not available

Item	Function	Default setting	Customized setting	1	2	3
Smart key system (→P. 26)	Smart key system	ON	OFF	O	—	O
	Smart door unlocking	Driver's door	All the doors	O	O	O
	Operation signal (Buzzer)	ON	OFF	—	—	O

FarmaSOS.com

Item	Function	Default setting	Customized setting	1	2	3
Wireless remote control (→P. 39)	Wireless remote control	ON	OFF	—	—	○
	Open door warning function (when locking the vehicle)	ON	OFF	—	—	○
	Unlocking operation	Driver's door unlocked in one step, all doors unlocked in two steps	All doors unlocked in one step	○	—	○
Smart key system (→P. 26) and wireless remote control (→P. 39)	Operation signal (Emergency flashers)	ON	OFF	○	—	○
	Time elapsed before automatic door lock function is activated if door is not opened after being unlocked	60 seconds	OFF	○	—	○
			30 seconds			
		120 seconds				

6-2. Customization

Item	Function	Default setting	Customized setting	1	2	3
Door lock (→P. 42)	Unlocking using a key	Driver's door unlocked in one step, all doors unlocked in two steps	All doors unlocked in one step	○	—	○
	Speed-detecting automatic door lock function	OFF	ON	○	○	○
	Shifting the shift lever to position other than "P" locks all doors	ON	OFF	○	○	○
	Shifting the shift lever to "P" unlocks all doors	ON	OFF	○	○	○
	Opening driver's door unlocks all doors	OFF	ON	○	○	○
Power windows (→P. 86)	Mechanical key linked operation (close)	OFF	ON	—	—	○
	Mechanical key linked operation (open)	OFF	ON	—	—	○
	Wireless remote control linked operation (open)	OFF	ON	—	—	○
	Linked entry function	OFF	ON	—	—	○



Item	Function	Default setting	Customized setting	1	2	3
Moon roof (→P. 89)	Mechanical key linked operation (open) <sup>*1</sup>	OFF	ON	—	—	○
	Mechanical key linked operation (close) <sup>*1</sup>	OFF	ON	—	—	○
	Linked operation of components when door key is use	Slide only	Tilt only	—	—	○
	Wireless remote control linked operation (open) <sup>*2</sup>	OFF	ON	—	—	○
	Linked operation of components when wireless remote control used	Slide only	Tilt only	—	—	○
	Linked entry function <sup>*3</sup>	OFF	ON	—	—	○

\*1: The settings can be changed when the mechanical key linked operation of the power window is set to ON.

\*2: The settings can be changed when the wireless remote control linked operation of the power window is set to ON.

\*3: The settings can be changed when the entry function linked operation of the power window is set to ON.

6-2. Customization

Item	Function	Default setting	Customized setting	1	2	3
Illumination (→P. 371)	Time period before the interior lights turn off	15 seconds	OFF	O	—	O
			7.5 seconds			
			30 seconds			
	Time period before the exterior lights turn off	15 seconds	OFF	O	—	O
			7.5 seconds			
			30 seconds			
	Operation after the “ENGINE START STOP” switch is turned off	ON	OFF	—	—	O
	Operation when the doors are unlocked	ON	OFF	—	—	O
	Operation when you approach the vehicle with the electronic key on your person (When the interior light switch is door position)	ON	OFF	—	—	O
Foot lights	ON	OFF	—	—	O	
Sensitivity of the ambient light sensor used for dimming the meter lights etc.	Standard	-2 to 2	O	—	O	
Sensitivity of the ambient light sensor used for brightening the meter lights etc.	Standard	-2 to 2	O	—	O	

578

Item	Function	Default setting	Customized setting	1	2	3
Automatic light control system (→P. 177)	Light sensor sensitivity	Standard	-2 to 2	○	—	○
	Daytime running light system	ON	OFF	○	—	○
	Time elapsed before headlights automatically turn off after doors are closed	30 seconds	OFF	○	—	○
			60 seconds			
		90 seconds				
Automatic air conditioning system (→P. 248)	Switching between outside air and recirculated air mode linked to "AUTO" switch operation	Auto	Manual	○	—	○
	A/C Auto switch operation	Auto	Manual	○	—	○

FarmaSOS.com

---

■ **Vehicle customization**

- If the smart key system is turned "OFF", unlock door cannot be selected.
- If the doors are not opened after locking and are then automatically re-locked, a signal will be given if "Operation signal (Emergency flashers)" or "Operation signal (Buzzer)" are set to ON.

■ **When setting using the vehicle switches (vehicles with navigation system)**

When using the vehicle switches to set an item that can also be set using the touch screen, the item displayed on the touch screen will not change immediately.

If the "ENGINE START STOP" switch is first turned to OFF, the screen display will change once the "ENGINE START STOP" switch is turned to IGNITION ON mode again.

■ **When customizing using the touch screen (vehicles with navigation system)**

Stop the vehicle in a safe place, apply the parking brake, and shift the shift lever to "P". Also, to prevent battery discharge, leave the engine running while customizing the features.

تلفن شبانه روزی: ۰۸۵ ۰۸۸۶۲ ۰۸۱  
FarmaSOS.com

**⚠ CAUTION****■ During customization**

As the engine needs to be running during customization, ensure that the vehicle is parked in a place with adequate ventilation. In a closed area such as a garage, exhaust gases including harmful carbon monoxide (CO) may collect and enter the vehicle. This may lead to death or a serious health hazard.

**⚠ NOTICE****■ During customization**

To prevent battery discharge, ensure that the engine is running while customizing features.

**Multi-information display (→P. 172)**

Available languages

English (U.S.A.), English (UK), French, German, Spanish, Italian, Japanese, Simplified Chinese and Traditional Chinese

FarmaSOS.com

### 6-3. Initialization Items to initialize

The following items must be initialized for normal system operation in cases such as after the battery is reconnected, or maintenance is performed on the vehicle.

Item	When to initialize	Reference
Engine oil maintenance data	After changing engine oil	P. 434
Tire pressure warning system	<ul style="list-style-type: none"><li>• When rotating the tires on vehicles differing with front and rear tire inflation pressures.</li><li>• When changing the tire inflation pressure by changing traveling speed or load weight, etc.</li><li>• When changing the tire size.</li></ul>	P. 446

تلفن شبانه روزی: ۰۲۱-۸۸۸۶۲۰۸۵

FarmaSOS.com

For U.S. owners

7

Reporting safety defects  
for U.S. owners ..... 584

امداد خودرو فارما

تلفن شبانه روزی: ۰۲۱-۸۸۸۶۲۰۸۵

FarmaSOS.com

## Reporting safety defects for U.S. owners

If you believe that your vehicle has a defect which could cause a crash or could cause injury or death, you should immediately inform the National Highway Traffic Safety Administration (NHTSA) in addition to notifying Toyota Motor Sales, U.S.A., Inc. (Toll-free: 1-800-331-4331).

If NHTSA receives similar complaints, it may open an investigation, and if it finds that a safety defect exists in a group of vehicles, it may order a recall and remedy campaign. However, NHTSA cannot become involved in individual problems between you, your dealer, or Toyota Motor Sales, U.S.A., Inc.

To contact NHTSA, you may call the Vehicle Safety Hotline toll-free at 1-888-327-4236 (TTY: 1-800-424-9153); go to <http://www.safercar.gov>; or write to: Administrator, NHTSA, 1200 New Jersey Ave, S.E., Washington, DC 20590. You can also obtain other information about motor vehicle safety from <http://www.safercar.gov>.

تلفن شبانه روزی: ۰۲۱-۸۸۸۶۲۰۸۵

FarmaSOS.com



## Index

Abbreviation list .....	586
Alphabetical index .....	588
What to do if.....	596

امداد خودرو فارما  
تلفن شبکه روزی: ۰۲۱-۸۸۶۲۰۸۵

For details of equipment related to the navigation system and touch screen, such as the air conditioning and audio systems, refer to the "Navigation System Owner's Manual".

FarmaSOS.com

Abbreviation list

Abbreviation/Acronym list

ABBREVIATIONS	MEANING
A/C	Air conditioning
ABS	Anti-lock Brake System
ALR	Automatic Locking Retractor
AUX	Auxiliary
CRS	Child Restraint System
DISP	Display
ECT	Electronic Controlled Transmission
ECU	Electronic Control Unit
EDR	Event Data Recorder
ELR	Emergency Locking Retractor
GAWR	Gross Axle Weight Rating
GVWR	Gross Vehicle Weight Rating
I/M	Emission inspection and maintenance
INT	Intermittent
KDSS	Kinetic Dynamic Suspension System
LATCH	Lower Anchors and Tethers for Children
LED	Light Emitting Diode
MMT	Methylcy clopentadienyl Manganese Tricarbonyl

ABBREVIATIONS	MEANING
M+S	Mud and Snow
MTBE	Methyl Tertiary Butyl Ether
OBD	On Board Diagnostics
PCS	Pre-Collision System
PWR	Power
RSCA	Roll Sensing of Curtain Shield airbag
SRS	Supplemental Restraint System
TIN	Tire Identification Number
TPMS	Tire Pressure Warning System
TRAC	Traction Control
VIN	Vehicle Identification Number
VSC	Vehicle Stability Control

تلفن شبانه روزی: ۰۲۱-۸۸۶۲۰۸۵

FarmaSOS.com

## Alphabetical index

## Alphabetical index

<b>A</b>	<b>A/C</b>		
	Air conditioning filter.....	460	
	Automatic air conditioning system .....	248	
	<b>ABS</b> .....	<b>208</b>	
	<b>Active traction control</b> .....	<b>208</b>	
	<b>Air conditioning filter</b> .....	<b>460</b>	
	<b>Air conditioning system</b>		
	Air conditioning filter.....	460	
	Automatic air conditioning system .....	248	
	<b>Airbags</b>		
	Airbag operating conditions... 108		
	Airbag precautions for your child .....	112	
	Airbag warning light.....	503	
	Curtain shield airbag operating conditions.....	108	
	Curtain shield airbag precautions .....	112	
	Front passenger occupant classification system.....	120	
	General airbag precautions... 112		
	Locations of airbags .....	104	
	Modification and disposal of airbags .....	115	
	Proper driving posture... 102, 112		
	Roll sensing of curtain shield airbags off switch .....	118	
	Side airbag operating conditions.....	108	
	Side airbag precautions .....	112	
	SRS airbags .....	104	
	<b>Alarm</b> .....	<b>98</b>	
	<b>Antenna</b> .....	<b>272</b>	
	<b>Anti-lock brake system</b> .....	<b>208</b>	
	<b>Armrest</b> .....	<b>395</b>	
	<b>Ashtrays</b> .....	<b>388</b>	
	<b>Audio input</b> .....	<b>308</b>	
	<b>Audio system</b>		
	Antenna.....	272	
	Audio input .....	308	
	AUX port .....	308	
	CD player/changer .....	276	
	iPod.....	291	
	MP3/WMA disc .....	284	
	Optimal use.....	306	
	Portable audio device .....	308	
	Radio.....	267	
	Steering wheel audio switch.....	309	
	USB memory.....	298	
	<b>Automatic air conditioning system</b> .....	<b>248</b>	
	<b>Automatic light control system</b> .....	<b>175</b>	
	<b>Automatic transmission</b>		
	Automatic transmission.....	158	
	If the shift lever cannot be shifted from P .....	532	
	S mode.....	160	
	<b>AUX port</b> .....	<b>308</b>	
	<b>B</b>		
	<b>Back door</b>		
	Back door.....	47	
	Wireless remote control key....	39	
	<b>Back-up lights</b>		
	Replacing light bulbs.....	479	
	Wattage.....	557	
	<b>Battery</b>		
	Checking .....	441	
	If the vehicle has discharged battery .....	538	
	Preparing and checking before winter .....	228	
	<b>Bluetooth® audio</b> .....	<b>313</b>	
	<b>Bluetooth® phone</b> .....	<b>333</b>	
	<b>Bottle holder</b> .....	<b>379</b>	
	<b>Brake</b>		
	Fluid .....	438	
	Parking brake.....	164	

**Brake assist**..... 208  
**Break-in tips** ..... 145  
**Brightness control**  
 Instrument light control ..... 167

**C**

**Care**  
 Exterior ..... 414  
 Interior ..... 417  
 Seat belts ..... 418  
**Card holder** ..... 381  
**Cargo capacity** ..... 220  
**Cargo net hooks**..... 397  
**CD player/changer** ..... 276  
**Center differential**  
 lock/unlock switch ..... 199  
**Chains** ..... 230  
**Child-protectors** ..... 43  
**Child restraint system**  
 Booster seats, definition ..... 125  
 Booster seats, installation .... 129  
 Convertible seats,  
 definition ..... 125  
 Convertible seats,  
 installation ..... 129  
 Front passenger occupant  
 classification system ..... 119  
 Infant seats, definition ..... 125  
 Infant seats, installation ..... 129  
 Installing CRS with  
 LATCH system ..... 130  
 Installing CRS with  
 seat belts ..... 132  
 Installing CRS with top  
 tether strap ..... 137  
**Child safety**  
 Airbag precautions ..... 112  
 Battery precautions ..... 443, 465  
 Child-protectors ..... 43  
 Child restraint system ..... 125  
 How your child should wear  
 the seat belt ..... 76

Installing child restraints ..... 129  
 Moon roof precautions ..... 91  
 Power window lock switch ..... 86  
 Power window precautions ..... 88  
 Removed key battery  
 precautions ..... 463  
 Seat belt extender  
 precautions ..... 79  
 Seat belt precautions ..... 77  
 Seat heater precautions ..... 394  
**Cigarette lighter** ..... 390  
**Cleaning**  
 Exterior ..... 414  
 Interior ..... 417  
 Seat belts ..... 418  
**Clock** ..... 386  
**Condenser** ..... 437  
**Console box** ..... 376  
**Cool box**..... 382  
**Cooling system**  
 Engine overheating ..... 541  
**Cruise control**..... 186  
**Cup holder** ..... 378  
**Crawl Control** ..... 204  
**Curtain shield airbags** ..... 104  
**Customizable features**..... 573

**D**

**Daytime running light**  
 system ..... 176  
**Defogger**  
 Rear window ..... 262  
**Dimension**..... 548  
**Dinghy towing** ..... 245  
**Display**  
 Crawl Control display ..... 204  
 Intuitive parking assist  
 display ..... 190  
 Trip information ..... 173  
 Shift position and shift  
 range ..... 160  
 Warning messages ..... 513

**Do-it-yourself maintenance.....426**

**Door courtesy lights**

- Door courtesy lights .....333
- Wattage.....557

**Door lock**

- Back door .....47
- Side door.....42
- Wireless remote control key....39

**Doors**

- Back door.....47
- Side door.....42
- Side mirrors.....83

**Driver's seat belt reminder**

- light.....505**

**Driving**

- Break-in tips .....145
- Correct posture .....102
- Off-road precautions .....215
- Procedures.....144
- Winter driving tips.....228

**Driving position memory.....63**

**E**

**Electronic key**

- If your electronic key battery is discharged...463, 535

**Emergency flashers**

- Switch.....492

**Emergency, in case of**

- If a warning message is displayed.....513
- If the electronic key does not operate properly.....535
- If the engine will not start .....530
- If the shift lever cannot be shifted from P.....532
- If the vehicle has discharged battery .....538
- If the warning buzzer sounds .....502
- If the warning light turns on...502
- If you cannot operate back door opener .....534

- If you have a flat tire .....516

- If you lose your keys .....533

- If you think something is wrong.....498

- If your vehicle becomes stuck .....544

- If your vehicle has to be stopped in an emergency ...545

- If your vehicle needs to be towed.....493

- If your vehicle overheats .....541

**Engine**

- Compartment .....430
- Engine switch.....154
- Hood .....429
- How to start the engine .....154
- Identification number.....549
- If the engine will not start .....530
- Ignition switch .....154
- Overheating .....541

**Engine coolant**

- Capacity .....552
- Checking.....436
- Preparing and checking before winter.....228

**Engine coolant temperature**

- gauge.....166**

**Engine immobilizer system .....96**

**Engine oil**

- Capacity .....551
- Checking .....432
- Preparing and checking before winter.....228

**Engine oil maintenance**

- data .....434**

**Engine switch.....154**

**Event data recorder .....500**

**F**

**First-aid kit holder .....397**

**Floor mats .....396**

<b>Fluid</b>	
Brake .....	438
Power steering .....	440
Washer .....	444
<b>Fog lights</b>	
Replacing light bulbs .....	479
Switch .....	178
Wattage .....	557
<b>Four-wheel drive system .....</b>	<b>199</b>
<b>Front fog lights</b>	
Replacing light bulbs .....	479
Switch .....	178
Wattage .....	557
<b>Front passenger's seat belt reminder light .....</b>	<b>505</b>
<b>Front seats</b>	
Adjustment .....	52
Driving position memory .....	63
<b>Front side marker light</b>	
Replacing light bulbs .....	479
Wattage .....	557
<b>Front turn signal lights</b>	
Replacing light bulbs .....	479
Wattage .....	557
<b>Fuel</b>	
Capacity .....	550
Fuel gauge .....	166
Fuel pump shut off system .....	499
Gas station information .....	600
Information .....	558
Refueling .....	92
Type .....	558
<b>Fuel door .....</b>	<b>92</b>
<b>Fuel filler door .....</b>	<b>92</b>
<b>Fuel pump shut off system .....</b>	<b>499</b>
<b>Fuses .....</b>	<b>466</b>
<b>G</b>	
<b>Garage door opener .....</b>	<b>399</b>
<b>Gas station information .....</b>	<b>600</b>
<b>Gauges .....</b>	<b>166</b>

<b>Glove box .....</b>	<b>375</b>
<b>Glove box light .....</b>	<b>375</b>
<b>H</b>	
<b>Hazard lights</b>	
Switch .....	492
<b>Head restraints</b>	
Adjusting .....	67
<b>Headlight cleaner .....</b>	<b>185</b>
<b>Headlights</b>	
Replacing light bulbs .....	479
Switch .....	175
Wattage .....	557
<b>Heaters</b>	
Seat heaters .....	393
<b>Hill-start assist control .....</b>	<b>208</b>
<b>Hood .....</b>	<b>429</b>
<b>Hooks</b>	
Cargo hook .....	397
Tie-down hooks .....	397
<b>Horn .....</b>	<b>165</b>
<b>I</b>	
<b>I/M test .....</b>	<b>425</b>
<b>Identification</b>	
Engine .....	549
Vehicle .....	549
<b>Ignition</b>	
Engine switch .....	154
Keys .....	24
Ignition switch .....	154
<b>Ignition switch .....</b>	<b>154</b>
<b>Illuminated entry system .....</b>	<b>333</b>
<b>Indicator lights .....</b>	<b>169</b>
<b>Initialization</b>	
Items to initialize .....	582
<b>Inside rear view mirror .....</b>	<b>81</b>
<b>Instrument panel light control .....</b>	<b>167</b>
<b>Interior lights</b>	
Interior lights .....	333
Switch .....	372
Wattage .....	557
<b>Intuitive parking assist .....</b>	<b>190</b>

## Alphabetical index

- J** **Jack**  
 Vehicle-equipped jack .....516  
**Jack handle** .....516
- K** **KDSS** .....208  
**Keyless entry**.....26  
**Keys**  
 Electronic key .....24  
 If you lose your keys .....533  
 If your electronic key  
 battery is discharged...463, 535  
 Ignition switch.....154  
 Keyless entry.....26  
 Key number .....24  
 Keys .....24  
 Mechanical key .....24  
 Wireless remote control key ....39
- L** **Language**  
 Multi-information  
 display.....172, 581  
**Licence plate lights**  
 Replacing light bulbs .....479  
 Wattage.....557  
**Light bulbs**  
 Replacing .....479  
 Wattage.....557  
**Lights**  
 Door courtesy lights .....333  
 Emergency flasher switch .....492  
 Fog light switch .....178  
 Hazard light switch .....492  
 Headlights switch .....175  
 Interior light switch .....372  
 Personal light switch .....373  
 Replacing light bulbs .....479  
 Turn signal lever.....163  
 Vanity lights.....385  
 Wattage.....557  
**Load capacity** .....227
- M** **Maintenance**  
 Do-it-yourself maintenance ... 426  
 General maintenance.....422  
 Maintenance data .....548  
 Maintenance requirements ...420  
**Meter**  
 Instrument panel light  
 control.....167  
 Meters.....166  
**Micro dust and pollen filter**.....254  
**Mirrors**  
 Inside rear view mirror .....81  
 Side mirror heater .....262  
 Side mirrors.....83  
 Vanity mirrors.....385  
**Moon roof** .....89  
**MP3 disc** .....284  
**Multi-information display** .....172
- N** **Noise from under vehicle**.....18
- O** **Odometer** .....166  
**Off-road precautions** .....215  
**Oil**  
 Engine oil .....432  
**Opener**  
 Fuel filler door .....92  
 Hood .....429  
**Outside rear view mirrors**  
 Adjusting and folding.....83  
 Mirror position memory .....63  
**Outside temperature**  
 display .....387  
**Overhead console**.....377  
**Overheating, Engine**.....541



<b>P</b>	<b>Parking brake</b> ..... 164	<b>S</b>	<b>Safety Connect</b> .....406
	<b>Parking lights</b>		<b>Seat belts</b>
	Replacing light bulbs ..... 479		Adjusting the seat belt.....72
	Switch..... 175		Automatic Locking
	Wattage..... 557		Retractor .....74
	<b>PCS</b> ..... 214		Child restraint system
	<b>Personal lights</b>		installation..... 129
	Personal lights..... 373		Cleaning and maintaining
	Switch..... 373		the seat belts .....418
	Wattage..... 557		Emergency Locking
	<b>Power outlet</b> ..... 391		Retractor .....74
	<b>Power steering</b>		How to wear your seat belt.....71
	Fluid..... 440		How your child should wear
	<b>Power windows</b> ..... 86		the seat belt .....76
	<b>Pre-Collision System</b> ..... 214		Pregnant women,
			proper seat belt use .....75
			Reminder light .....505
			Seat belt extenders .....76
			Seat belt pretensioners .....74
			<b>Seat heaters</b> .....393
			<b>Seats</b>
			Adjustment precautions.....53
			Child seats/child restraint
			system installation ..... 129
			Cleaning .....417
			Driver's seat position
			memory .....63
			Front seat adjustment .....52
			Head restraint.....67
			Properly sitting in the seat.....102
			Rear seat adjustment .....54
			Seat heaters.....393
			<b>Service reminder</b>
			<b>indicators</b> ..... 169
			<b>Shift lever</b>
			Automatic transmission ..... 158
			If the shift lever cannot be
			shifted from P .....532
<b>R</b>	<b>Radiator</b> ..... 437		
	<b>Radio</b> ..... 267		
	<b>RDS</b> ..... 271		
	<b>Rear seats</b>		
	Adjustment ..... 54		
	Tumbling second seats ..... 55		
	Tumbling third seats ..... 58		
	<b>Rear turn signal lights</b>		
	Replacing light bulbs ..... 479		
	Wattage..... 557		
	<b>Rear window defogger</b> ..... 262		
	<b>Rear window wiper</b> ..... 184		
	<b>Replacing</b>		
	Fuses..... 466		
	Key battery ..... 463		
	Light bulbs ..... 479		
	Tires ..... 516		
	<b>Reporting safety defects for</b>		
	<b>U.S.A. owners</b> ..... 584		
	<b>Roll sensing of curtain shield</b>		
	<b>airbags off switch</b> ..... 118		
	<b>Roof luggage carrier</b> ..... 220		

Alphabetical index

<b>Side airbags</b> .....	<b>104</b>
<b>Side marker lights</b>	
Replacing light bulbs.....	479
Switch.....	175
Wattage.....	557
<b>Side mirror</b>	
Adjusting and folding.....	83
Mirror position memory .....	63
<b>Smart key system</b>	
Entry function .....	26
Starting the engine .....	154
<b>“SOS” button</b> .....	<b>406</b>
<b>Spare tire</b>	
Inflation pressure.....	454
Storage location .....	516
<b>Spark plug</b> .....	<b>553</b>
<b>Specifications</b> .....	<b>548</b>
<b>Speedometer</b> .....	<b>166</b>
<b>Steering</b>	
Column lock release.....	156
Fluid .....	440
<b>Steering wheel</b>	
Adjustment .....	80
Audio switches .....	309
Steering wheel position memory.....	63
<b>Stop lights</b>	
Replacing light bulbs.....	479
<b>Storage feature</b> .....	<b>374</b>
<b>Storage precautions</b> .....	<b>220</b>
<b>Stuck</b>	
If your vehicle becomes stuck .....	544
<b>Sun visors</b> .....	<b>384</b>
<b>Sunshade</b>	
Roof.....	90
<b>Switch</b>	
ECT switch.....	159
Driving mode select switch....	159
Emergency flasher switch .....	492
Engine switch.....	154

Fog light switch .....	178
Hazard light switch.....	492
Ignition switch .....	154
Light switches .....	175
Power door lock switch .....	42
Power window switch.....	86
Rear window wiper and washer switch.....	184
Window lock switch.....	86
Wipers and washer switch.....	179, 184

**T**

<b>Tachometer</b>	
Tachometer.....	166
<b>Tail lights</b>	
Switch .....	175
<b>Talk switch *</b> .....	<b>338</b>
<b>Telephone switch *</b> .....	<b>338</b>
<b>Theft deterrent system</b>	
Alarm.....	98
Engine immobilizer system .....	96
<b>Tire inflation pressure</b> .....	<b>454</b>
<b>Tie-down hooks</b> .....	<b>397</b>
<b>Tire information</b>	
Glossary.....	566
Size.....	563
Tire identification number.....	562
Uniform tire quality grading ...	564
<b>Tires</b>	
Chains.....	228
Checking .....	445
If you have a flat tire.....	516
Inflation pressure .....	454
Information .....	561
Pressure warning system.....	445
Replacing.....	516
Rotating tires.....	445
Size .....	556
Snow tires .....	228
Spare tire .....	516
<b>Tools</b> .....	<b>516</b>

<b>Total load capacity</b> .....	<b>227</b>	Seat belt reminder.....	505
<b>Towing</b>		SRS airbags.....	503
Dinghy towing.....	245	Tire pressure.....	505
Emergency towing.....	493	Unengaged "Park".....	505
Trailer towing.....	233	<b>Warning messages</b> .....	<b>513</b>
<b>TRAC</b> .....	<b>208</b>	<b>Warning reflector holder</b> .....	<b>397</b>
<b>Traction control</b> .....	<b>208</b>	<b>Washer</b>	
<b>Trailer towing</b> .....	<b>233</b>	Checking.....	444
<b>Trip information display</b> .....	<b>172</b>	Preparing and checking	
<b>Trip meter</b> .....	<b>166</b>	before winter.....	228
<b>Turn signal lights</b>		Switch.....	179, 184
Replacing light bulbs.....	479	<b>Washing and waxing</b> .....	<b>414</b>
Switch.....	163	<b>Weight</b>	
Wattage.....	557	Cargo capacity.....	220
<b>V</b>		Load limits.....	227
<b>Vanity lights</b>		Weight.....	548
Vanity lights.....	385	<b>Wheels</b> .....	<b>458</b>
Wattage.....	557	<b>Window glasses</b> .....	<b>86</b>
<b>Vanity mirrors</b> .....	<b>385</b>	<b>Window lock switch</b> .....	<b>86</b>
<b>Vehicle identification</b>		<b>Windows</b>	
<b>number</b> .....	<b>549</b>	Power windows.....	86
<b>Vehicle stability control</b> .....	<b>208</b>	Rear window defogger.....	262
<b>Voice command switch</b> *.....	<b>338</b>	Washer.....	179, 184
<b>VSC</b> .....	<b>208</b>	<b>Windshield wiper de-icer</b> .....	<b>263</b>
<b>W</b>		<b>Windshield wipers</b> .....	<b>179</b>
<b>Warning buzzers</b>		<b>Wireless remote control key</b>	
Brake system.....	502	Replacing the battery.....	463
Open door.....	504	Wireless remote control key....	39
Seat belt reminder.....	505	<b>WMA disc</b> .....	<b>284</b>
<b>Warning lights</b>			
Anti-lock brake system.....	504		
Brake system.....	502		
Charging system.....	503		
Low fuel level.....	506		
Malfunction indicator lamp....	503		
Master warning.....	506		
Open door.....	504		
Pre-collision.....	504		

\*: Refer to the "Navigation System Owner's Manual".  
595

What to do if...  
What to do if...

A tire punctures	P. 516	If you have a flat tire
The engine does not start	P. 96	Engine immobilizer system
	P. 530	If the engine will not start
	P. 538	If the battery is discharged
The shift lever cannot be moved out	P. 532	If the shift lever cannot be shifted from "P"
The engine coolant temperature gauge enters the red zone	P. 541	If your vehicle overheats
Steam can be seen coming from under the hood		
The key is lost	P. 533	If you lose your keys
The battery runs out	P. 538	If the battery is discharged
The doors cannot be locked	P. 42	Side doors
	P. 47	Back door
The horn begins to sound	P. 98	Alarm
The vehicle is stuck in mud or sand	P. 544	If the vehicle becomes stuck
The warning light or indicator light comes on	P. 502	If the warning light turns on

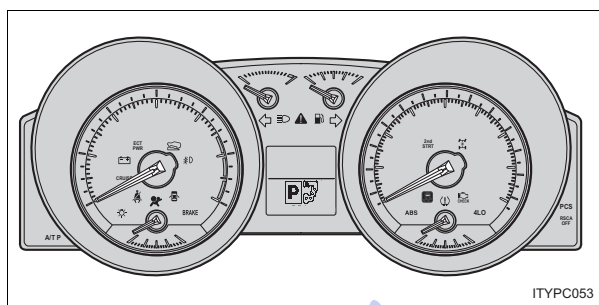

■ Warning lights

<b>BRAKE</b>	Brake system warning light	P. 502		Driver's seat belt reminder light	P. 505
<b>ABS</b>	ABS warning light	P. 504	<b>PASSENGER</b>	Front passenger's seat belt reminder light	
			OR		
	SRS warning light	P. 503	<b>PASSENGER</b>		P. 505
	Open door warning light	P. 504		Tire pressure warning light	P. 504
	Charging system warning light	P. 503	<b>PCS</b>	Pre-collision system warning light	P. 503
<b>A/T P</b>	Unengaged "Park" warning light	P. 505		Low fuel level warning light	P. 504
	Malfunction indicator lamp	P. 503		Master warning light	P. 506

The warning message is displayed

P. 513 If a warning message is displayed

What to do if...

امداد خودرو فارما

تلفن شبانه روزی: ۰۲۱-۸۸۸۶۲۰۸۵

**FarmaSOS.com**

What to do if...

امداد خودرو فارما

تلفن شبانه روزی: ۰۲۱-۸۸۸۶۲۰۸۵

**FarmaSOS.com**

## GAS STATION INFORMATION

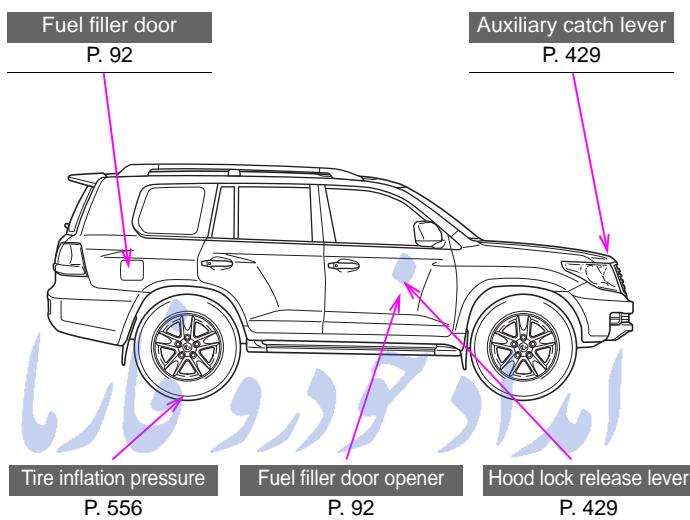

Fuel tank capacity (Reference)	24.6 gal. (93 L, 20.5 Imp.gal.)	
Fuel type	Unleaded gasoline only	P. 93, 550
Cold tire inflation pressure		P. 556
Engine oil capacity (Drain and refill — reference)	With filter	7.4 (7.0, 6.2) <sup>*1</sup>
		7.9 (7.5, 6.6) <sup>*2</sup>
	Without filter	7.0 (6.6, 5.8) <sup>*1</sup>
		7.5 (7.1, 6.2) <sup>*2</sup>
Engine oil type	"Toyota Genuine Motor Oil" or equivalent Oil grade: ILSAC multigrade engine oil P. 551	

\*1: Vehicles with a blue-markered dipstick handle

\*2: Vehicles with a green-markered dipstick handle

(Location of the marker: →P. 432)